Detailed table of contents	1
Alphabetical index	A 1
1. General laboratory consumables	11
2. Occupational safety, Security	195
3. Analytical measurement and testing	295
4. Stirring, Shaking, Mixing	447
5. Sample preparation	541
6. Distillation, separation, filtration	617
7. Heating and cooling technology	753
8. Liquid Handling	909
9. Vacuum technology, Drying, Dry storage	1059
10. Optical instruments and Microscopes	1093
11. Cleaning and sterilisation	1161
12. Environmental-, soil-, water-, food analysis	1211
13. Life Sciences	1291
14. Chromatography	1419
15. Cleanroom	1501
Supplier index	S 1
Numerical index	N 1

Imprint

Published by:

Lab Logistics Group GmbH
Meckenheim, Germany

Editor:

Michael Simon
Lab Logistics Group GmbH

Printing:

Konradin Druck GmbH, Leinfelden-Echterdingen, Germany

Software:

WiesoSoft GmbH, Schifferstadt, Germany

Design:

Lab Logistics Group GmbH, Meckenheim, Germany
Die Gestalter GmbH, Schwerte, Germany
Stock Photos by Shutterstock.com, Fotolia.de, istockphoto.com

© Copyright 2020, Lab Logistics Group GmbH

Copying of information or data, especially all or part of the text and illustrations is only allowed if LLG has given written agreement to this in advance. Existing rights of trademarks, patents, registrations etc. are indicated and acknowledged. A missing mark does not mean that there are no protective rights existing.

Illustrations are only representative of the products supplied and may show accessories and associated items which are not included within the scope of supply. Technical specifications are subject to change.

Copies: 85,010

Published: 2020

Liability, information on products and rights belonging to third parties

Lab Logistics Group GmbH and the dealer who uses this catalogue accept no liability for the suitability of an item listed in the catalogue for a specific application. The responsibility for the suitability of an item for a specific application lies with the user. Please ask your dealer for advice.

Information contained within the catalogue concerning items of personal protective equipment are of general nature only and do not recommend any specific application. To determine whether a product meets the safety requirements of a specific application, the user must assess the technical data sheets/safety data sheets of the manufacturer/supplier indicated.

All product listings have been researched and presented in co-operation with the respective supplier. Every effort has been made to ensure that data and descriptions given within this catalogue were correct at the time of going to press but we accept no liability for any error. We kindly ask you for your understanding.

Your LLG-Partner's Terms and Conditions of Business will apply.

Some products and brands shown in this catalogue may not be available in all countries.

Abbreviation key:

PK = packaging unit

E & OE = Errors and omissions excepted



PEFC/04-31-0845

PEFC Certified

This catalogue is from sustainably managed forests, controlled sources

www.pefc.org



1. General laboratory consumables	11
Vessels	13
Beakers	13
Measuring jugs	16
Flasks	19
Test tubes.....	24
Stoppers.....	29
Tube racks	33
Containers	42
Baskets	49
Transport boxes.....	51
Buckets	54
Aspirators and Carboys.....	56
Wide-mouth bottles.....	62
Wide-mouth kegs.....	77
Narrow-mouth bottles	78
Square bottles.....	85
Reagent bottles	90
Spray, dropping bottles.....	91
Funnels	98
Cylinders	103
Dishes	103
Crucibles.....	111
Tools	115
Spoons, Spatulas	115
Knives, Scissors.....	126
Workshop tools.....	130
Forceps.....	132
Scoops	138
Heating	139
Burners	139
Beaker tongs.....	143
Tripod.....	144
Tubing	146
Tubing/Gas.....	146
Rubber	146
Plastic	147
Adapters, Clips, Clamps	153
General laboratory aids	165
Labels	165
Documenting.....	172
Laboratory jacks	175
Stands, Fittings.....	177
Batteries.....	187
Accessories for electrical device	188
Bags, Foils	188
Greases	194

2. Occupational safety, Security	195
Eye protection	196
Eyeshields.....	196
Panoramic eyeshields.....	202
Overgoggles.....	203
Accessories.....	204
Safety shields.....	205
Breathing protection	206
Hygiene masks.....	206
Half masks.....	207
Full face masks.....	212
Ear protection	214
Noise protection.....	214
Gloves	217
Vinyl gloves.....	217
Latex gloves.....	217
Nitrile gloves.....	220
Glove box holder.....	230
Chemical protective gloves.....	232
Cotton safety gloves.....	237
Cut resistant gloves.....	237
Temperature protective gloves.....	238
Protective clothing	245
Laboratory coats.....	245
Aprons.....	248
Coveralls.....	249
Caps.....	250
Oversleeves.....	251
Shoes.....	252
Identification of hazards	253
Safety signs.....	253
First-aid	253
Eye wash bottles.....	253
Eye wash stations.....	255
Body showers.....	256
Dressings/plasters.....	257
Waste disposal	258
Waste, Disposal bags.....	258
Waste bins.....	261
Chemical Sorbents.....	263
Safety containers	264
Transport, storage containers.....	264
Transport	270
Trolleys.....	270
Furniture	272
Chairs.....	272
Step-ladders.....	278
Furniture.....	279
Fume hoods.....	280
Safety cabinets.....	287

3. Analytical measurement and testing	295
pH-measurement	296
Paper, chopstick.....	296
Portable devices.....	299
Table devices.....	309
pH-Electrodes.....	315
Redox-Electrodes.....	322
Ion selective Electrodes.....	323
Electrode accessories.....	324
Buffer solutions.....	325
Conductivity measurement	329
Portable devices.....	329
Table devices.....	333
Electrodes.....	337
Solutions.....	339
Oxygen measurement	340
Devices.....	340
Electrodes and accessories.....	342
Multiparameter measurement	345
Devices.....	345
Balances	354
Pocket balances.....	354
Precision balances.....	358
Analytical balances.....	367
Other balances.....	375
Moisture balances.....	376
Weights.....	379
Accessories.....	381
Thermometers	385
Laboratory thermometers.....	385
Surface, Insertion thermometers.....	392
Temperature meters.....	399
Temperature data logger.....	402
Temperature-Humidity logger.....	408
Timing	414
Timers.....	414
Clocks.....	417
Climate and environment measurement	418
Hygrometer.....	418
Special climate meters.....	420
Density determination	425
Density meter.....	425
Pycnometer.....	427
Density meters.....	428
Viscosity determination	432
Viscosimeter.....	432
Material testing	437
Force measurement.....	437
Hardness measurement.....	438
Surface analysis.....	440

Analytical instruments and systems	443
Melting point determination	443
4. Stirring, Shaking, Mixing	447
Magnetic stirrers / Hotplates	448
Without heating, with motor	448
Without heating, cable free	460
With heating and motor	461
Accessories, Magnetic stirring bars	475
Overhead stirrers	478
Instruments	478
Stirrer Heads	489
Stirrers	491
Shakers and mixers	497
Vortexer	497
Orbital shakers	505
Reciprocating shakers	515
Rocking shakers	518
Tumbling shakers	522
Thermoshakers	527
Overhead shakers	533
Roller mixers	537
Microtitre plate shakers	539
5. Sample preparation	541
Sampling	542
Samplers, gas	542
Samplers, Solids	543
Samplers, Liquids	553
Sample containers	559
Sample transport, storage	562
Grinding	565
Mortars	565
Blenders	566
Mills	568
Jaw breaker	590
Sieving	591
Sieve shakers	591
Test sieves	594
Sample dividers	598
Laboratory presses	599
Presses	599
Mixing, Homogenisation	599
Dispersers	599
Ultrasonic homogenisers	610
Homogenisers	614
6. Distillation, separation, filtration	617
Distillation, synthesis	618
Flasks with NS joint neck	618
Components for reaction and distillation	625
Flat ground flange reaction vessels	630

KPG stirrer and bearings	632
Dropping Funnels	634
Reflux condenser	635
Distillation-Accessories	637
Components for Extraction	639
Gas wash bottles.....	643
Tubing adapters	645
Standard ground stoppers	649
NS joints accessories	650
Ground joints, attachable	654
Stopcocks and Valves	655
Rotary evaporators	656
Instruments	656
Accessories	662
Separating, centrifuging	664
Minicentrifuges	664
Benchtop centrifuges	669
Centrifuge tubes	688
Filtration	699
Filter paper, qualitative	699
Filter paper, quantitative	710
Glass-fibre filters	716
Membrane filters.....	721
Syringe filters.....	729
In-Line filter	741
Filtration apparatus	742
7. Heating and cooling technology	753
Cooling	754
Cryogenic tubes.....	754
Cryogenic boxes	757
Cryogenic racks	763
Cryogenic accessories.....	763
Biobanking	766
Cryogenic storage tanks.....	768
Liquid nitrogen-Accessories	768
Dewar flasks	769
Low and Ultra low temperature freezers	772
Refrigerators and Freezers.....	785
Refrigerators and Freezers ex protected	787
Ice machines.....	789
Transport boxes	790
Temperature regulators	796
Heating-Thermostats	796
Cooling-Thermostats.....	812
Circulator baths	821
Dynamic Temperature Control Systems	826
Temperature Control Accessories	827
Heating	829
Water baths	829
Shaking water baths.....	836
Heating baths.....	839
Hotplates	841
Heating mantles.....	846

Temperature controllers, thermostats.....	851
Microwaves	852
Universal, Heating and Drying incubators	853
Vacuum drying incubators	862
Incubators	864
Cooling incubators.....	870
CO ₂ -Incubators	875
Shaking incubators.....	878
Thermoblocks	889
Test incubators	898
Ovens, Furnaces	903

8. Liquid Handling 909

Volumetric apparatus 910	910
Measuring cylinders.....	910
Mixing cylinders	916
Graduated flasks.....	917

Pipettes 927

Volumetric pipettes	927
Graduated pipettes.....	931
Pasteur pipettes.....	936
Serological pipettes	938
Pipette controllers	939
Pipette balls	942
Pipettes Accessories	943
Capillary tubes.....	946
Microlitre pipettes	949
Positive displacement pipettes	979
Pipette tips.....	981
Reagent Reservoirs.....	1000

Dispensing 1002

Hand dispensers.....	1002
Bottletop dispensers	1009

Titration 1021

Burettes.....	1021
Titration.....	1027
Digital burettes	1031

Pumps 1037

Drum pumps	1037
Peristaltic pumps.....	1042
Dosing pumps.....	1053
Rotary piston pumps.....	1054

Microfluidics 1055

Syringe pumps.....	1055
Hoses and connections.....	1057

9. Vacuum technology, Drying, Dry storage 1059

Water jet pumps 1060	1060
Water jet pumps	1060

Piston pumps/Compressors 1061	1061
Pumps and compressors.....	1061

Diaphragm pumps 1062	1062
Pumps	1062

Pump units-speed controlled	1069
Pump units-valve controlled	1071
Rotary vane pumps	1074
Pumps	1074
Accessories	1075
for vacuum pumps	1075
Cold traps, Woulff bottles	1076
Vacuum controller	1078
Sensors and Controllers	1078
Desiccators	1081
Desiccators - glass	1081
Desiccators - plastic.....	1084
Desiccator cabinets	1085
Laboratory Freeze drying	1091
Freeze dryers.....	1091
10. Optical instruments and Microscopes	1093
Optical instruments	1094
Magnifiers	1094
Microscopy	1097
Light microscopes.....	1097
Stereomicroscopes	1103
Digital microscopes and cameras	1104
Microscopy accessories	1107
Cold light sources.....	1109
Counting chambers.....	1114
Slides	1116
Slide covers.....	1118
Slide storage	1119
Staining racks.....	1121
Refractometers	1125
Hand held refractometers	1125
Benchtop refractometers	1130
Photometers	1135
Polarimeters	1135
Spectrophotometers	1137
OD-Measurement	1143
Microplate reader and washer	1144
Colour measurement	1147
Special Photometers	1148
Glass cuvettes	1150
Plastic cuvettes	1157
Accessories cuvettes.....	1160
11. Cleaning and sterilisation	1161
Disinfection	1162
Wipes	1162
liquid	1163
for Instruments.....	1166
Cleaning implements	1174
dry wipes	1174
Towels and dispensers	1178

Absorbent pads / Cotton wool	1179
Cleaning equipment.....	1180
Brushes	1182
Hair brushes.....	1183
Draining racks.....	1184
Ultrasonic cleaners	1185
Instruments	1185
Ultrasonic cleaners	1193
Washers, disinfectors	1194
Instruments	1194
Accessories	1196
Steam sterilisers - Autoclaves	1197
Instruments	1197
Accessories	1206
Sterile packaging	1209

12. Environmental-, soil-, water-, food analysis **1211**

Sample preparation	1212
Air sampling and analysis	1212
for standard analysis	1217
Trace analysis	1221
Tubes	1221
Accessories	1231
Sample analysis	1235
Elemental analysis.....	1235
Oil Testing	1237
Photometers	1238
COD	1249
BOD	1254
Turbidity	1261
Extraction	1266
Kjeldahl	1271
Special distillation	1274
Milk analysis	1275
Water purification	1278
Distillation	1278
Pure and ultra-pure water.....	1278

13. Life Sciences **1291**

Genomics	1292
PCR.....	1292
DNA and RNA isolation	1300
Thermocyclers	1302
PCR cabinets	1305
DNA-Electrophoresis	1306
Gel-Documentatio	1310
Concentration	1314
Electroporation	1314
Proteomics	1316
ELISA	1316
Protein-Electrophoresis	1321
Blotting.....	1322

Blot Imaging.....	1326
Purification	1327
Cell Culture	1331
Cultivation.....	1331
Aspirators	1351
Filtration	1354
Safety Cabinets.....	1357
Microbiology	1361
Media and reagents	1361
Cultivation.....	1364
Sterilizers and burners	1380
Cell disruption.....	1387
Disruptors	1389
Filtration	1390
Analysis	1392
ATP detection.....	1396
Hygiene monitoring	1396
Histology	1398
Embedding cassettes	1398
Microtoms	1399
Scalpels	1400
Dissecting sets.....	1402
Accessories and reagents	1403
General Consumables	1406
Micro Tubes	1406
Centrifugation Tubes.....	1413
Deep-well plates	1415
14. Chromatography	1419
Vials	1420
General information vials and caps	1420
Autosampler Compatibility List	1421
Authentic 1:1 size drawings of all vials	1428
Septa and cap recommendation	1433
Vials, Septa	1435
Accessories	1451
NMR/EPR	1452
Tubes	1452
Accessories	1453
Syringes	1454
Microlitre Syringes.....	1454
Disposable syringes	1460
Sample preparation	1463
SPE	1463
Syringe filters	1468
Liquid chromatography	1472
HPLC columns.....	1472
HPLC-Accessories	1473
Glass columns.....	1475
Solvent storage/handling.....	1477
Gas chromatography	1484
Gas generators	1484

GC columns	1488
GC consumables	1491
Thin-layer chromatography	1495
Plates	1495
Chambers	1498
Detection	1499
Accessories	1500
15. Cleanroom	1501
Reusable garments	1502
Overalls, coats	1502
Surgical masks, hoods, sleeves	1503
Accessories	1504
Disposable garments	1504
Overalls, coats	1504
Surgical masks, hoods, sleeves	1507
Overshoes, overboots, socks.....	1508
Eye protection	1510
Cleanroom goggles.....	1510
Gloves and fingercots	1512
Nitrile gloves	1512
Latex gloves	1517
Polychloroprene gloves.....	1521
PE, PVC, PU gloves	1523
Coated gloves	1523
Undergloves	1524
Finger cots	1524
Skin protection and care.....	1525
Wipes and swabs	1526
Dry wipes.....	1526
Swabs	1530
Cleaning rollers.....	1532
Paper and documentation	1533
Paper, notebooks, pencils	1533
Tapes.....	1535
Cleaning equipment and tools	1537
Cleaning systems, stainless steel.....	1537
Cleaning systems, plastic	1538
Mop holders and covers.....	1539
Facility	1542
Mats and floor coverings.....	1542
Trolleys, dispenser.....	1545
Wardrobes.....	1548
Gowing benches.....	1549
ESD products	1550
ESD-gloves and fingercots	1550
ESD-mats and pads	1550

Technical information

1551

- A -

Abbe refractometers1132-1134
 Absorbents262-263
 Absorption cells1150,1152-1154,1156
 Acid bottles90
 Adapters
 -bends626-627
 -destilling625,629
 -distillation adapters626
 -expansion and reduction645
 -flexible tubing adapters646
 -plugs188
 -reduction159-160
 -splash head629,662
 -tubing645-646
 Adhesive
 -parcel tapes165
 -tapes166-167,1532,1535-1536
 -tapes, antistatic1532
 -tapes, dispenser165,167
 -tapes, for cleanroom1532
 Agarose1308
 Agars1361
 Air flow testers1212
 Air velocity measuring instrument424
 Air
 -regulators638
 -samplers1216,1397
 -valve1480
 Alarm clocks417
 Alcohol meters425
 Alkylation reagents1490
 Allergenic test1396
 Allergy testing1396
 Allihn condensers635-636,642
 Aluminium
 -bottles85
 -containers189
 -discs189
 -foil188
 Anaerobic
 -digestion equipment1218
 -jars1378
 Analytical
 -balances367-373,375
 -filter units1390-1391
 -sieve shakers591
 Anemometers420
 Antistatic cable set1042
 Antitamper seals547
 Antivibration platforms384
 Aprons248
 Aquaria1122
 Arm protectors251
 Aspirators1351-1353
 Aspirator
 -bottles56-57
 -carboys58
 Atomisers
 -test tube, for TLC1500
 -with blowball, for TLC1499
 ATP-Detection1396-1397
 Autoclavable bags258-259
 Autoclaves
 -automatic1200-1202
 -biological controllers1206
 -deodorants1207
 -horizontal1200,1205
 -indicator tapes165

Autoclaves
 -mesh baskets1201-1202
 -steam sterilizers1203-1204
 -tabletop1197-1200,1205
 -temperature control1206-1207
 -thermometers1206
 -thermoprinters1202
 Automatic burettes
 -class AS1024-1027
 -class B1025,1027-1028
 -Pellet pattern1024,1026-1028
 -Schilling pattern1024-1025

- B -

Bags
 -autoclavable258-259
 -biohazard258-259
 -blender616
 -cleanroom1504
 -disposal192-193,258
 -freezer192
 -homogenizing560-561
 -sample193,542,559-562
 -sponge561
 -stand-up559
 -waste258-259
 Balance benches384
 Balances
 -analytical367-373
 -calibration weights380
 -compact354-355,359
 -Ex-protected358
 -moisture auri379
 -moisture halogen371,376,378-379
 -platform375
 -playing cards382
 -pocket354
 -portable354-357
 -precision358-366,372-374
 -printer360,371
 -teaching355
 -weighting brushes381,1183
 Barcode readers767
 Barrel pumps1038-1039,1041
 Basins
 -evaporating105-106
 -stainless steel107
 Baskets
 -cleaning50
 -nylon-coated50
 -stainless steel50
 -transport50
 -wire50
 Batch mills575
 Baths
 -circulating, refrigerated814
 -circulator806-807
 -covers809
 -digital dry baths889-890
 -digital water baths829-831
 -flotation, histology1403
 -heating839-840
 -heating circulator804,808-809,811
 -heating water baths834-835
 -immersion circulator796
 -lids833
 -preservative liquid819
 -protection agent819
 -refrigerated circulator812-820

Baths	
-sand	.839
-shaking water baths	.836-838
-tanks	.807
-thermostatic	.804,808-809,814-815,832-833
-thermostatic liquid	.840
-ultrasonic	.596,1185,1187-1189,1191
-ultrasonic, microbiology	.1190
-ultrasonic, shaking	.1192
-unstirred water baths	.831,833
Batteries	
-alkaline	.187
-NiMH	.187
Beads, glass	.628
Beakerliners	.477
Beakers	
-angled, for sampling	.554
-angular, for sampling	.555
-boro 3.3	.13
-conical form	.17
-Duran®	.13-14
-ETFE	.1224
-filter	.14
-griffin	.15,1223-1225
-holder	.556
-low form	.13-14
-multi-purpose	.47
-pendulum, for sampling	.554-555
-PFA	.1224-1225
-PMP	.15
-PP	.14-15
-PTFE	.1223-1224
-stainless steel	.16
-tall form	.13-14
-tongs	.144
-trace analysis	.1223-1225
Beard masks	.251
Bench protectors	
-cork	.190
-paper	.190
Benches	.280
Benchtop refractometers	.1130
Bends	.626-627
Biobanking	.766-767
Biohazard bags	.258-259
Biological test dishes	.1365
Bioreactors	.1340,1379
Blades, razor	.129
Blenders	
-bags	.616
-homogenisers	.567
-paddle	.615
Block heaters	.527,532,893-896
Block thermostats	.527,530,889-893,896
Blocking	
-buffer	.1324-1325
-solution	.1324
Blood lancets	.1402
Blotters	
-semi dry	.1323
-wet	.1324
Blotting paper	.1322
Blowballs	.942,1028
BOD	
-dissolved oxygen bottles	.1258-1259
-incubators	.871,1259
-Karlsruher bottles	.1259
-measurement systems	.1254-1258
-thermostat cabinets	.871,1259
-Winkler bottles	.1258
Boiling chips	.638
Boiling stones	
-for COD	.638
-for Kjeldahl nitrogen	.638
-PTFE	.1232
-Type A	.638
-Type B	.638
Bossheads	
-90°	.180-181
-cast iron	.180
-cross	.182
-die-cast zinc	.181-182
-malleable cast iron	.180
-scaffold	.180
-stainless steel	.181-182
-swivelling	.181-182
Bottle-top dispensers	
-accessories	.78
-fix volume	.1009,1014,1018
-trace analysis	.1019
-variable volume	.1009-1014,1018
Bottles	
-allrounder, plastic	.67
-aluminium	.85
-aspirator	.56-58
-baffled	.71
-burette	.1028
-Canada balsam	.1108
-cell culture	.1347
-culture media	.1347-1348,1370
-diagnostic	.84
-dissolved oxygen	.1258-1259
-dropping, trace analysis	.1226
-gas wash bottle, Drechsel type	.644
-gas washing	.643
-gas washing, Drechsel type	.643-644
-in vitro	.1347
-laboratory, amber	.64,70
-laboratory, boro 3.3	.62
-laboratory, DURAN®	.62-67,70-72
-medium-mouth	.77
-narrow-mouth, glass	.78-79
-narrow-mouth, plastic	.80,82,84,1226-1227
-powder	.70
-reagent	.73,79,82
-reagent, square	.90
-round	.81,83
-sample	.564
-shouldered	.80
-sloping shouldered	.90
-spray	.95-97
-square	.85-87
-trace analysis	.1226-1228
-vacuum	.77
-wash	.91
-wash, safety	.93
-wash, trace analysis	.1229
-wide-mouth, amber	.70
-wide-mouth, brown	.75-76
-wide-mouth, glass	.69-73
-wide-mouth, graduated	.74
-wide-mouth, plastic	.73-76,87-88,90,1228
-with retrace code	.66
-Woulff	.1077
Bottle	
-baskets	.49-50
-carriers	.49-50
Bouffant caps	.251
Bowl trolleys	.271
Bowls	.107-108

Boxes	
-display	.51
-euronorm	.53
-for culture tubes	.29
-insulating	.792
-plastic	.45
-sound proof	.1192
-storage	.52
Breath protection	.206-213
Breathing air testers	.1216
Bridge circulators	.806
Brooms	.1181
Brushes	
-cleaning	.1182-1183
-for test tubes	.29
-natural bristle	.1175
-transport bag	.1183
-weighing	.381,1183
Bubble counters	.643
Buckets	
-ice	.793
-lids	.55
-pans	.793
-plastic	.54-55
-stainless steel	.55
Buffer solutions	
-PBS	.1325
-pH	.325-326
-potassium phosphate	.1325
-redox	.327
-standard	.326
-technical	.327
-with colour coding	.325
Bulbs	.943
Bunsen burners	.140-143,1383
Burettes	
-automatic, class AS	.1024,1026-1027
-automatic, class B	.1025,1027-1028
-automatic, Schilling pattern	.1025
-class AS	.1021-1023
-class B	.1022
-compact	.1023
-digital	.1029-1030,1033-1036
-micro	.1023
-reservoir bottles	.1028
-Schellbach line	.1021-1023
-straight stopcock	.1022
-with lateral stopcock	.1022-1023
-with motor-driven piston	.1031-1032
-with straight stopcock	.1021-1023
Burette	
-bellows	.1028
-bottles	.1028
-clamps	.186-187
-holders	.186-187
Burners	
-bunsen	.140-143
-electric	.143
-gas	.141
-gas cartridge	.141
-safety	.142,1382-1386
-spirit	.139
-Teclu	.142
-tubing	.146
Butyrometers	
-accessories	.1276
-cheese and quark	.1275
-cream, Koehler	.1275
-cream, Roeder	.1275
-dry milk	.1275
Butyrometers	
-milk	.1275
-pipettes	.1275
- C -	
Cabinets	
-for acids and alkalis	.293
-microbiological safety	.1357-1358,1360
-underbench	.280,287
-viewing, TLC	.1500
Cameras	
-C-mount adapter	.1100
-USB Hand-held	.440,1105-1106
-Wifi microscope	.1104
Canisters	.267
Capillary	
-pipettes	.946-947
-tubes	.947-948
Caps for vials	
-crimp seals ND11	.1441
-crimp seals ND13	.1443
-crimp seals ND20	.1447-1449
-crimp seals ND24	.1450
-crimp seals ND8	.1435
-crimping tools	.1451
-headspace seals ND20	.1447
-plugs, ND12	.1445
-plugs, ND8	.1445
-screw bonded ND10	.1439
-screw bonded ND9	.1438
-screw seals magnetic	.1446
-screw seals ND13	.1444
-screw seals ND15	.1444
-screw seals ND18	.1444,1446
-screw seals ND8	.1436
-septa ND11	.1441
-septa ND13	.1444
-septa ND20	.1449
-septa ND8	.1436
-septa ND9	.1439
-snap caps ND18	.1445
-snap caps ND22	.1445
-snap ring ND11	.1442
-stoppers ND20	.1449
-thread seals ND9	.1438
Caps	
-aluminium	.1377
-drop-over	.1377
-dropping bottles	.95
-Erlenmeyer	.1376
-for narrow-mouth bottles	.81-82
-for reagent bottles	.82
-for round bottles	.81,83
-for square bottles	.87
-for test tubes	.30
-jars, wide neck	.48
-Kapsenberg	.1370
-membrane	.68
-metal	.1376
-plastic bottles	.75
-quick release	.72
-screw	.48,67,69,75,78
-screw, GL thread	.67
-screw, high temperature	.68-69
-screw, trace analysis	.1231
-sealing	.698
-storage jars	.48
-tamper-evident	.86,88-89

Carbon dioxide snow	.790	Centrifuge tubes	
Carboys	.56-60	-PC	.696-697
Carrier boxes	.49	-pear shape	.690
Cartridges for deionisers	.1281	-PP	.691,693-695
Casseroles	.106-107	-PPCO	.697
Cavity tiles	.1121	-PS	.694-696
Cell based assays	.1146	-PSU	.696
Cell culture		-racks	.35,37-38
-chamber slides	.1336	-round bottom	.688-689,695-696
-counters	.1341	-with rim	.691,694-695
-dishes	.877,1331-1332	Centrifuges	
-flasks	.876,1333-1335,1370-1371	-benchtop	.672-679,681-687
-lifters	.1342	-cyto	.1349-1350
-multidishes	.1336-1337	-dairy testing	.1277
-plates	.1339	-floor-standing	.680
-scrapers	.1342	-high-speed	.665,668,670,673-675,677,679,682
-strainers	.1343	-large volume	.680
Cell lifters		-micro	.669-671,673,675,681-682,685
-blades	.1342	-microplate	.668
-flat blades	.1342	-milk analysis	.1277
-hooks	.1342	-mini	.666-668
Cells/Optical cells		-refrigerated	.677
-calibration reference	.1151-1152	-rotors	.680
-cleaning liquid	.1160	-underbench	.680
-disposable	.1157-1159	-universal	.676-680
-flow-through	.1156	-vortexer, combined	.667
-for absorption measurement	.1150,1152-1154,1156	Chairs	.273,275,277
-for colorimeters	.1147	Chamber slides	.1335-1336
-for fluorescence measurement	.1150,1155	Chambered coverglass	.1336
-for light scattering measurement	.1155	Chambers	
-for micro volume analysis	.1152	-climate with illumination	.902
-for stray light	.1155	-constant climate	.898,900-901
-glass	.1150-1156	-growth	.902
-plastic	.1159	-material test	.901
-racks	.1160	Charcoal tubes	.1213
-stands	.1157,1160	Chemical protection gloves	.232-237,1522
-storage boxes	.1160	Chemical	
-UV-range	.1150,1153-1156,1158-1159	-binder	.262-263
-VIS-range	.1152,1155,1157-1158	-sorbents	.262-263
Cellulose		Chest freezers	.773,775,778,780,783
-absorbent pads	.1179	Chillers	.821-824
-stoppers	.1372	Chromatography	
-tissues	.1179	-columns	.1463,1465-1466
-TLC-plates	.1497	-GC	.1488-1490
-wad	.1179	-ion exchange paper	.1497
Cell		-paper	.1497-1498
-counters	.1115,1341	-sprayers	.1499
-disruptors	.1389	Circulator baths	.809,821-824
-factories	.1340	Circulators	
-lifters	.1342	-compact	.815
-scrapers	.1342	-heating bath	.804,808-809,811
-strainers	.1343	-high temperature	.826
Centrifugal concentrators	.1327-1328	-refrigerated	.812-820
Centrifugal mills	.570-571,588	-tanks	.807
Centrifuge bottles		Clamps	
-PC	.698	-2-prong	.184
-PPCO	.698	-3-prong	.183-184
Centrifuge tubes		-4-prong	.183
-5 ml	.692-693	-B form	.183
-ASTM	.0,689-690	-chain	.186
-black	.1414	-condenser	.185-186
-conical	.0,688-690,693	-flexible	.185
-FEP	.696	-for burettes	.186-187
-filters	.1328	-for joints	.650-651
-glass	.0,688-690	-micro	.185
-graduated	.0,688,695-696	-pipettes, shelf-holder	.959
-LoBind	.1414	-retort	.183-184
-micro	.690	-stand	.184
-Oak Ridge	.696-697	-table	.179
-oil test	.689-690	-test tubes	.42

Clamps	
-thermometer	.186
-universal	.185
-with cork	.183
Clean-up stations	.1220
Cleaners	
-dust remover spray	.1173
-special	.1169
-universal	.1173
Cleaning	
-brushes	.544,1175,1182-1183
-cloths	.1175-1176
-concentrate	.1193
-hand towels	.1178
-solution, for electrodes	.326,344
-solutions	.1167-1170
-tissues	.1176-1177
-tissues for lenses	.204
-wipes	.230,1174-1175,1177
-wipes, dispensing system	.1178
-wipes, floor stand	.1178
Cleanroom	
-bags	.1504
-chairs	.277
-cleaning papers	.1533-1534
-cleansing lotions	.1525
-coats	.247,1503,1506
-disposable gloves, latex	.1517-1520
-disposable gloves, nitrile	.1512-1517
-disposable gloves, polychloroprene	.1521
-disposable gloves, PU	.1523
-disposable hoods	.1508
-disposable masks	.1507
-disposable overalls	.1502,1504-1506
-disposable overshoes	.1508-1509
-disposable sleeve guards	.1508
-disposable socks	.1510
-fine dust mats	.1542-1545
-finger cots	.1550
-gloves, chemical-resistant	.1521-1522
-hanger racks	.1548
-hoods	.1503
-liquid dispensers	.1108
-markers	.1534
-masks	.1503
-mats	.278
-mops	.1539-1541
-notebooks	.1534
-protection film	.1536
-safety eyeshields	.1510-1511
-sealing tape	.1535
-soap dispenser	.1525
-sticky mats	.1542-1545
-stools	.276
-surface protection	.1550
-swabs	.1530-1532
-tape	.1535-1536
-transport trolleys	.1537-1538,1545-1546
-undergloves	.1524
-wardrobe	.1548
-wipes	.1526-1530
Cleansing lotions	.1525
Climate chambers	.899-901
Cling film	.192
Clips	
-for conical joint	.651
-for sleeve connections	.651
Clocks	.417
Closures	
-filling and venting	.1348
-quick-acting	.630
-quick-lock	.260,631
-reagent bottles	.82
-ties	.260
-winchester bottles	.82
Clutches	.489
CO ₂	
-incubators	.875-876
-meters	.422
-monitoring	.1130
Coats	.245,247
COD	
-cooling trough	.1252
-digestion units	.1250-1252
-HCl absorbers	.1253
-heating blocks	.1251
-magnetic stirrers	.1252
-measuring station	.1250
-metering funnel	.1252
-standards	.1253
-thermoreactors	.1249
-titration stations	.1252
-work stations	.1251
Coil condensers	.636
Cold resistant gloves	.241-242
Cold	
-boxes	.783
-light sources	.1111-1113
-traps	.1076
Colony counters	
-automatic	.1395
-hand tally	.1392
-manual	.1393-1394
Colorimeters	
-cells	.1147
-instrument	.1147
-reference standards	.1235
Colour standards	
-Gardner	.1235
-Platinum-Cobalt Hazen	.1235
Columns	
-Hempel	.627
-HPLC	.1476
-Vigreux	.628
Combustion dishes	.114
Comminution mills	.569,586
Compressed air stirrers	.491-492
Compressive force measurement	.437
Compressors, vacuum pump	.1061
Concentrators	.1474
Condenser clamps	.185-186
Condensers	
-Allihn	.635-636
-Allihn, for extractors	.642
-Allihn, for soxhlet	.642
-Coil	.636
-Dimroth	.635,641
-Dimroth, for extractors	.642
-Dimroth, for Soxhlet	.641
-intensive	.636
-Liebig	.637
-spiral	.636
Conductive	
-finger cots	.1550
-gloves	.1550
Conductivity	
-cell probes	.337
-meters	.329-337,345,348,353

Conductivity	
-sensors	.338
-solutions	.339
-standards	.338-339
Connection	
-stopcocks	.157
-system	.73
Connectors	
-GL thread	.647
-threaded tube	.386,646-647
-with NS joint	.654
-with stopcock	.645
Contact thermometers	.395,397,473
Containers	
-cooling	.793
-freezing	.795
-insulated	.792-793
-PE	.75,90
-PETG	.87
-PP	.47
-PVC	.88
-safety	.268
-sampling	.42-44,47
-storage	.52
-transport	.52,55
-wide-mouth	.87-88,90
Controllers	
-macropipette	.941
-micropipette	.948
-pipette	.939-941,948
Coolers	
-flow coolers	.825
-for PCR	.1294,1299
-for samples	.794
-recirculating	.824
Cooling	
-boxes	.790,792,794
-circulators	.814,818-819
-containers	.793
-incubators	.867,871
-packs	.790-791
-sprays	.194
-thermostats	.812-817,820
Core samplers	.543
Core thermometers	.393-395,398
Cork	
-borers	.32
-lids, dewar flasks	.771
-rings	.23
Cotton	
-applicators	.1368,1397
-wool	.1180
Counters	
-colony, automatic	.1395
-colony, hand tally	.1115,1392
-colony, manual	.1393-1394
Counting chambers	
-Fuchs-Rosenthal	.1114
-improved Neubauer	.1114
-Malassez	.1114
-Neubauer	.1114
-Thoma	.1114
-with clips	.1114
-without clips	.1114
Couplings	.153-156,490,647
Cover glasses	
-forceps	.135
-haemacytometer	.1118
Cover slips	.1118
Coveralls	.249
Crimping tools	.1451
Cross beater mills	.572
Crossflow filters	.1328
Crucibles	
-adapters	.746
-alsint	.112-113
-collars	.746
-filter, glass	.745
-filter, porcelain	.745
-nickel	.115
-porcelain	.111-112
-quartz glass	.113
Cryo boxes	
-adaptable height	.760
-autoclavable	.759-761,765
-cardboard	.758
-EPS	.762
-partition inserts	.757-758
-plastic coated	.36,757-762
-racks	.763
Cryo tubes	.754-756
Cryo tubes accessories	
-cap coders	.755-756
-capping system	.767
-corrugated boxes	.759
-decappers	.766
-floating racks	.765
-insert cap discs	.755
-racks	.765
-storage boxes	.36,757-762,765
-storage, biobanking	.766-767
Cryogenic	
-ampoule holders	.768
-blocks	.764
-flasks, Dewar	.768-771
-racks	.765
-storage tanks	.768
Cryo	
-apron	.248
-gloves	.241-242
-labels	.168-170
-markers	.762
-mills	.584
-scopes	.1277
-stats	.817
Crystallising dishes	
-glass	.104-105
-stainless steel	.105,111
Culture	
-media	.1361-1363
-tubes	.28,1374-1375
-tubes, Durham type	.1375
Cut protection	.237-238
Cutters	
-glass tubing	.130
-tubing	.152
-universal	.128-129
Cutting board	.129
Cutting mills	.573-574,579-581,589
Cuvettes	
-calibration reference	.1151-1152
-cleaning liquid	.1160
-disposable	.1157-1159
-flow-through	.1156
-for absorption measurement	.1152-1154,1156
-for electroporation	.1315
-for fluorescence measurement	.1155
-for light scattering measurement	.1155
-for micro volume analysis	.1152
-for photometers	.1158,1244

- Cuvettes
 -for stray light1155
 -plastic1159
 -racks1160
 -stands1157,1160
 -storage boxes1160
 -UV-range1153-1156,1159
 -VIS-range1152,1157
 Cytocentrifuges1349-1350
- D -**
- Dairy testing
 -butyrometers1275-1276
 -centrifuges1277
 -cryoscopes1277
- Data loggers
 -CO₂413
 -disposable402
 -humidity403,408,410-411
 -mini404,410
 -PDF406
 -temperature399,402-404,408-411
- Decappers766
- Deep-well plates
 -384-well1417
 -96-well1415-1417
 -sealing mats1297,1415
 -system1416
- Deflagrating spoons116
- Dehydrated media1361
- Deionised water1278
- Deionisers1278-1281
- Densitometers428-431,1143
- Density
 -bottles427
 -meters428-431,1143
 -standards429
- Desalting1331
- Desiccators
 -antistatic1089
 -auto dry box1086
 -cabinets1086-1090
 -discs1083
 -drying agents1085
 -for gas filling1087
 -glass1081-1082
 -lids1082
 -mini1086-1087
 -o-rings1083
 -PC1084-1087
 -plates1083
 -PMMA1087-1090
 -portable264
 -PP1084
 -stopcocks1083
 -vacuum1081-1082,1084
 -vacuum cabinet1085
- Distilling adapters625,629
- Detergents1168,1171-1172
- Determination of volatile oils1220
- Dewar flasks768,770
- Diagnostic slides1117
- Dialysis clips1331
- Diaphragm vacuum pumps1053,1062-1070
- Digestion
 -infrared, system1252,1271-1272
 -scrubbers1273
- Dimroth condensers635,641-642
- Dippers
 -PE553
 -PFA1233
 -PP553
- Dipping flow cups432
- Disc mills581
- Dishwashers1195-1196
- Dishwashing tools1175
- Disinfectant
 -DNA/Rnase elimination1165
 -instruments1166-1172
 -sprays1163-1164
 -surface1162-1165
 -tissues1162-1163
- Disinfectors1195
- Disk mills581,587-588
- Disks, Secchi1262
- Dispenser tips1003,1005
- Dispensers
 -adhesive tape167
 -bottle top1009-1014,1016-1017,1019
 -gloves215,230-231
 -hand towels1178
 -Kipp, heads79
 -manual1002,1004-1006
 -microscope slides1117
 -overshoes252
 -plasters257
 -pump1052
 -serial1002,1004-1006
 -soap1525
 -spectacles51
 -tips1003,1005,1007
- Dispensing scoops138
- Dispersers599-605,607-609
- Dispersing
 -heads602,604-605,607,609
 -instruments599-605,607-609
 -systems603
- Display boxes51
- Disposable
 -bouffant caps250
 -capillary pipettes946-947
 -capillary tubes947
 -cartons262
 -culture tubes1374-1375
 -cuvettes1157-1159
 -dippers553
 -filter units1354-1356
 -filters1391
 -gloves, for cleanroom1512-1517
 -gloves, latex217-220
 -gloves, neopren229-230
 -gloves, nitrile220-227,229
 -gloves, vinyl217
 -laboratory coats247,1506
 -masks1507
 -needles261
 -optical cells1157-1159
 -overshoes252
 -petri dishes1365
 -samplers546-547,557
 -scalpels1401
 -scoops549,551
 -shoe covers252
 -staining slide trays1123
 -syringe filters729-734
 -syringeless filters739
 -syringes, 2-parts1356,1460-1461
 -syringes, 3-parts1460-1461

Disposable	
-vacuum filter units	.1390
Dissecting	
-needles	.1402
-sets	.1402-1403
Distillation	
-adapters	.626-627
-apparatus	.1269
-assemblies	.625-626
-cooling monitors	.1270
-special systems, sulphur	.1274
-special systems, water content	.1274
-steam units	.1273-1274
-units	.1218,1269
Distilled water	.1278
Distilling	
-columns, Hempel type	.627
-columns, Vigreux type	.628
-links, Claisen type	.625-626
-links, with Liebig condenser	.625-626
-receivers, Bernauer type	.627
-receivers, Bredt type	.627
Distributors, flexible	.158
DNA/RNA isolation	
-collection cards	.1300
-magnetic micro-plates	.1302
DNA	
-loading dyes	.1309
-plasmid extraction	.1301
-protein tubes	.1409
-purification kits	.1301
-spin columns	.1301
-surface decontaminant	.1165
Dosing pumps	.1053
Draining racks	.1184
Drench hoses	.255
Dropping bottles	
-ETFE	.1226
-glass	.95
-PE	.95
Dropping funnels	.634
Drum pumps	.1037-1041
Dry block heaters	.889-890,895-896
Dry ice machines	.790
Dry mills	.568
Dryers	.139
Drying	
-ovens	.853,855-857,859-861
-ovens, vacuum	.863
-pads	.442
-pistols	.907
-tubes	.628-629

- E -

Ear protectors	.214-215
Earplugs	.214-215
EC analytical columns	.1472
Electrodes	
-accessories	.324
-ion selective	.323
-pH	.319-321
-redox	.322
-stands	.324
Electrolyte solutions	.328,343-344
Electrophoresis	.1312-1313
ELISA	
-micro-volume plates	.1145
-microplate lids	.1317,1320
-microplate readers	.1144-1145

ELISA	
-microplate washers	.1146
-microplates	.1297,1316-1320
Elution mixers	.1217
Embedding	
-cassettes	.1398
-mounting medium	.1404-1405
-rings	.1398
-wax	.1404
Environmental	
-analysis equipment	.1217
Enzyme kinetics	.1144-1145
Erlenmeyer flasks	
-glass	.19-20
-PFA	.1225
-plastic	.21
ESD	
-disposable overshoes	.1508
-liquid dispensers	.1108
-mats	.1545
-surface protection	.1550
-swabs	.1532
-tape	.1535
Evaporating dishes	
-for trace analysis	.1222
-glass	.104
-PFA	.1222
-porcelain	.105-106,113
-PTFE	.1222
-quartz glass	.104
-stainless steel	.106
Exchangeable blocks, for thermo shakers	.527,532
Exhaust devices	.1271
Extraction	
-apparatus, soxhlet	.1267-1268
-apparatus, Twisselmann	.1269
-crude fibre	.1270
-exhaust devices	.1271
-systems	.1269
-thimbles, borosilicate glass	.1267
-thimbles, cellulose	.1266
-thimbles, stands	.1267
-tubes, Mojonner	.1276
-units	.1219
-units, Randall method	.1270

Extractors	
-extraction apparatus	.641
-heads for heavy solvents	.641
-Knöfler-Böhm	.1268
-soxhlet	.640
Eye protection	.196-200,202
Eye showers	.256
Eye wash	
-bottles	.253,255
-emergency station	.254-255
-stations	.255
Eyeshields	.196-198,200,202

- F -

Face	
-masks	.206,209
-shields	.205
-visors	.205
Ferrules	
-angled	.648
-for Agilent GC	.1492
-for Perkin Elmer GC	.1492
-GL thread	.648
Fiber optic lighting	.1109

- Film
 -cling192
 -dispenser193
 -plastic, transparent192
 -sealing192-193
Filter bags560
Filter beakers14
Filter flasks
 -bottle shape752
 -Erlenmeyer shape752
 -glass751-752
 -protective collars750
 -seal648
 -Witt-pattern752
Filter paper
 -circles699-705,708,710-713
 -folded700,705-706
 -for beer analysis708
 -for light-coloured particles708
 -phase separator713
 -pyramidal folded704
 -qualitative699-706,708-709
 -quantitative710-713,715
 -round709,711,715
 -soil analysis709
Filter storage bottles1356
Filter tips981,983,985-987,989-990,993-995,997
Filter units1328,1354-1355,1391
Filters
 -blotting membrane1323
 -bottle-top1354,1356
 -crucible cones751
 -discs747
 -for fume hoods284
 -funnels749
 -glass microfibre719
 -gridded membrane1391
 -holders744,746-747
 -inline741
 -manifolds742
 -membrane filters, hydrophob722
 -membrane filters, MCE725
 -membrane filters, NC728,1391
 -membrane filters, PC723
 -sieve100
 -syringe filters CA729-730,732-733,735-736
 -syringe filters GF731,739
 -syringe filters H-PTFE738
 -syringe filters inorganic733
 -syringe filters MCE736
 -syringe filters NY729-730,732-733
 -syringe filters PA738
 -syringe filters PC732-733
 -syringe filters PE730
 -syringe filters PES729,734,738
 -syringe filters PET737
 -syringe filters PP732
 -syringe filters PSU732
 -syringe filters PTFE729,731,733-734,736-737
 -syringe filters PVDF731,738
 -syringe filters RC731,734-735,737
 -syringeless739
Filtration
 -capsules740-741
 -funnels98-101
 -pressure units744
 -units1356
 -vacuum apparatus743-744
 -vacuum filter units1390
Fine dust masks207-208
Finger cots1524,1550
First aid boxes257-258
Flake ice makers789
Flame photometers1148-1149
Flame sterilizers140
Flanged tubing1483
Flashlights132
Flask shakers515
Flasks
 -baffled1371
 -cell culture1333,1370-1371
 -culture, Fernbach1371
 -culture, Roux1370
 -Duran®, Erlenmeyer19
 -Erlenmeyer culture, baffled1372
 -Erlenmeyer culture, glass1371
 -Erlenmeyer culture, sterile1346
 -Erlenmeyer, Duran®19-20
 -Erlenmeyer, glass19-20
 -Erlenmeyer, NS joint624
 -evaporator662-663
 -filter751-752
 -flat bottom, NS joint623
 -flat flange630
 -glass, Erlenmeyer19
 -glass, flat bottom21-22
 -glass, Kjeldahl22
 -glass, round bottom21
 -iodine determination624
 -nitrogen623
 -pear shape flasks, NS joint620
 -plastic, Erlenmeyer21
 -powder662
 -receiving662
 -rings23
 -round bottom, NS joint618-619
 -round bottom, with four necks622
 -round bottom, with three necks621-622
 -round bottom, with two necks620,620-621
 -round-bottom, PFA1225
 -support rings23
 -volumetric917,920-925,1229
 -weighting rings23
Flat flange flasks630-631
Floating pellets831
Flocculation testers1263
Floor marking tapes1535
Floor stands for cleaning cloth1178
Floor wipers1539-1541
Flotation baths1403
Flow cups
 -detachable nozzle432
 -dipping432
 -fixed nozzle432
 -immersion432
 -stands432
Flow indicators152
Flow meters1486-1487
Fluid pumps1051
Fluorescent labels1335
Folding
 -boxes271
 -steps278
Food
 -scoops552
 -spatulas547
Foot pumps1037,1040
Force gauges437
Force measurement437

Forceps
 -assortment135,137
 -cover glass134-135
 -curved133
 -dissecting132-134
 -extra fine134
 -high precision134
 -PMP137
 -PTFE1233
 -rounded tips137
 -silicone-coated381
 -stainless steel132-133
 -standard133
 Fork clamps651
 Freeze dryers1091-1092
 Freezers
 - -10°C781
 - -25°C785
 - -30°C779,786
 - -50°C775,777-778
 - -80°C777
 - -85°C775,778
 -boxes, benchtop775
 -cryobox racks763
 -plasma784
 -ultra-low temperature772,774,781
 Freezing containers795
 Full face masks212
 Fume hoods
 -charcoal filters283
 -ductless280,282,284-285
 Funnels
 -analytical98
 -Büchner, Duran®749
 -Büchner, porcelain749,751
 -Büchner, PP750
 -Büchner, PTFE750-751
 -conical joint101
 -dropping funnels634
 -drum99
 -fast filtration99
 -filter749,1390-1391
 -for barrels99
 -glass98,100
 -holder101-102
 -PE99
 -powder100-101
 -PP98-99,101
 -safety265-268
 -separating640
 -separating, conical639
 -separating, Squibb639
 -solid addition100
 -stainless steel100
 -stand101-102
 Furnaces
 -ashing/burn-off905
 -muffle903-905
 Furniture272,278

- G -

Gas cylinders
 -cabinets294
 -carts294
 -regulators294
 Gas filters for GC1487
 Gas wash bottles
 -complete, Drechsel type644
 -Drechsel type643

Gas wash bottles
 -glass643
 -heads643
 -PP643
 -reservoirs643
 Gaskets68,750
 Gas
 -analyzers1217
 -burners141
 -cartridges140-141
 -Chromatography1488-1490
 -detection tubes1213-1215
 -jars103
 -leak detection fluid194
 -lighters142-143
 -safety tubing146
 -sampling tubes542,1213,1215
 -warning device1217
 Gauges
 -force437
 -Vernier caliper130
 GC
 -alkylation reagents, TMSH1490
 -columns1488-1489
 -ferrules, for Agilent GC1492
 -ferrules, for Perkin Elmer GC1492
 -flow meters1486-1487
 -generators, hydrogen1484
 -generators, nitrogen1485
 -generators, zero air1485
 -Inlet liners, for Agilent GC1491
 -Inlet liners, for Perkin-Elmer GC1492
 -Inlet liners, for Shimadzu GC1491
 -Inlet liners, for Thermo GC1491
 -septas1492
 -silylation reagents1490
 Gear pumps1051
 Gel documentation systems1312-1313,1326
 Gel electrophoresis tanks
 -genomics1306-1307
 -power supplies1307
 -proteomics1321
 Gel-Extraction kits1301
 Generators
 -hydrogen1484
 -nitrogen1485
 -zero air1485
 Germ resistance tests708
 Germ testing papers708
 Glass fibre filters716-717,719-720
 Glass wool1475
 Glove boxes281
 Gloves
 -boxes281
 -chemical protection232,234-237,1522
 -cold protection241-242
 -conductive1550
 -cotton237
 -cryo241,243
 -cut protection237-238,240
 -dispenser230-231
 -disposable, latex217-220,1517-1520
 -disposable, long221
 -disposable, neopren229-230
 -disposable, nitrile220-228,1512-1517
 -disposable, powder free217-227
 -disposable, powdered218
 -disposable, vinyl217
 -for cleanroom1512-1524

Gloves	
-heat protection	.239-240
-latex	.233
-neopren	.232
-safety, butyl	.237
-safety, latex	.233
-safety, NBR	.236
-safety, nitrile	.234-235
-sterile	.228,1514-1520
Graduated pipettes	
-class A	.934-935
-class AS	.931-934
-class B	.934-935
-for tissue culture	.1345
-PP	.935
-typ 2	.933
-typ 3	.931-934
Gravimetric dilutors	.614
Grease	
-vacuum	.653
-vacuum, silicone-free	.653
-vacuum, water soluble	.653
Griffin beakers	
-ETFE	.1224
-PFA	.1224-1225
-plastic	.15
-PTFE	.1223-1224
-trace analysis	.1223-1225
Grinders	
-mortar	.573,586
-ultra-centrifugal	.571
Grinding	
-balls	.587
-bowls	.587
-jars	.583-585
-mills	.569-585
Grindometers	.593
Ground thermometers	.386
Growth chambers	.902
- H -	
Haemocytometer cover glasses	.1118
Haematocrit capillaries	.947-948
Half-masks	.210-211
Hammers	.130
Hand	
-bellows	.1028
-brushes	.1180-1181
-dispenser	.1003
-protection cream	.244
-protectors	.240
-pumps	.1038,1042
-tally counters	.1115,1392
Hanger racks	.1548
Hanging scales	.354
Hardness testers	
-Leeb	.439
-shore	.438
Hazard labels	.253
Hazardous material workplace	.284
HCl absorbers	.1253
Hearing protection	.214-215
Heat protective gloves	.239-240
Heaters, gas	.141
Heating	
-baths	.839-840
-baths, liquid	.840
-cables	.850
-circulators	.802,804,808-809,811
Heating	
-mantles	.846-849
-mantles, electronic	.847,849
-mantles, electronic, multi-size	.848
-mantles, stirring	.849
-tapes	.850
Histology	
-cassettes	.1398
-mounting medium	.1404
-Paraffin flotation baths	.1403
-Paraffin wax dispensers	.1403
-staining solutions	.1405
-tissue-embedding wax	.1404
-trays	.1398
Holders	
-biohazard bags	.259
-cryogenic ampoule	.768
-filter	.1356
-funnel stands	.101-102
-glove boxes	.1546
-thermometer	.387
Homogenisers	
-blenders	.566
-digital	.605,607-609
-Duall	.1388
-fittings	.490
-handheld	.600
-heads	.602,604-605,607,609
-Potter-Elvehjem	.1389
-stands	.602
-tubes	.604
-ultrasonic	.610-614
-units	.600-601,603-604
-versatile	.599
-water samples	.1218
Homogenizing bags	.560
Hoods	.251,1503,1508
Hook connectors	.182
Horizontal shakers	.515
Hose cutters	.152
Hot benches	.446
Hotplates	
-analogue	.841-843
-Ceran®	.841,844
-digital	.842-843
-multiple	.845
-precision	.844-845
-temperature sensors	.461
-with stirrer	.461-472,474
HPLC	
-bottles	.1477,1483
-column thermostats	.1473
-columns, with frit	.1475
-columns, with indentations	.1475
-columns, without frit	.1475
-glass wool	.1475
-quartz wool	.1476
-safety caps	.1479-1480
-safety caps, accessories	.1481
-safety waste caps	.1480
-safety waste caps, collectors	.1482
-safety waste caps, with funnel	.1481
-safety waste caps, with level control	.1482
-seasand for columns	.1475
-silica adsorbents	.1476
-solvent handling	.1480-1483
-solvent supply	.1478-1479
-withdrawal caps	.1478-1479
Hub tubing	.1058
Humidity chambers	.899

Humidity data loggers403,408-413
 Hydrometers
 -alcohol425
 -ASTM426
 -Baumé type425
 -density425-426
 -jars427
 Hygiene analysis1396
 Hygrometers418-420

- I -

Ice
 -buckets793
 -machines789-790
 -makers789-790
 -pans793
 Immersion
 -circulators796,801
 -oil1107
 -thermostats802
 Impellers
 -2-blade493
 -3-blade478,493,496
 -4-blade478,493
 -6-hole494
 -anchor494
 -centrifugal493
 -disk-type494
 -dissolver493
 -spiral494
 -system495
 -U-shaped496
 In-line filters741
 Incinerating dishes114
 Incinerators902-906
 Incubating shakers530
 Incubators
 -CO₂875-877
 -compact865,869
 -cooling870-874
 -drying867
 -hoods878
 -microbiological861,869
 -mini864-865
 -Peltier872-873
 -refrigerated870,872,874
 -shaking878,884-888
 -shaking, platform887
 -with forced convection867-868
 -with gravity convection867-869
 -with natural convection866-868
 Indicator paper
 -rolls296
 -special296-298
 -steam1208
 -strips296-298
 -universal296,298
 Indicator tapes
 -gas sterilisation1207
 -hot air1207
 -steam165,1207
 Infrared thermometers399-401
 Inlet
 -filters for solvents1483
 -liners, for Agilent GC autosamplers1491
 -liners, for Perkin-Elmer GC autosamplers1492
 -liners, for Shimadzu GC autosamplers1491
 -liners, for Thermo GC autosamplers1491

Inoculation loops
 -holders1369
 -platinum-iridium1370
 -PS1368-1369
 -stand1369
 -sterile1368
 -sterilizers1380-1382,1384-1386
 -wironit1369
 Inoculation
 -loop sterilizers1383,1385
 -needles1369
 -turntables1366-1367
 Insert grids
 -chrome-plated857
 -stainless steel857
 Insertion thermometers394-398
 Instrument
 -boxes107-108
 -set125
 -trays107-109
 Insulated cooling boxes792
 Interval timers414,416
 Iodine determination flasks624
 Ion exchangers1280-1281
 Ion meters353
 ISE reference electrolyte328

- J -

Jars
 -cylinder103
 -gas103
 -glass48
 -PC46
 -PE44-45,47-48
 -PET48
 -PFA1222,1230
 -PP44-47
 -PS42-43,46
 -rolled rim28
 -trace analysis1222
 Jaw crushers587-588,590
 Jerrycans
 -conductive60
 -industrial61
 -safety267
 -wide-mouth59
 -with spout60-61
 Joint clips651
 Joints
 -spherical ground glass654
 -threaded156
 Jugs
 -measuring17-18
 -measuring, SAN18
 -plastic16
 -stainless steel18

- K -

Karlsruher bottles1259
 Kegs
 -UN approved77
 -wide-mouth77
 Kipp dispensers79
 Kjeldahl
 -block digestion systems1252,1272
 -digestion systems1271-1272
 -flasks619
 -scrubbers1273

Kjeldahl
 -weighing boats382
 Knives
 -glass cutting130
 -glass tubing130
 -multi-purpose152
 -tubing cutter152

- L -

Lab chairs273,275
 Lab jacks
 -aluminium175
 -stainless steel175-177
 -with hydraulic drive177
 Lab mixers566
 Lab stools272,274,276
 Labels
 -biohazard253
 -cryogenic169-170
 -deep freeze168-169
 -hazard GHS253
 -printer171-172
 -removing sprays170
 -self-adhesive167-170
 Laboratory
 -coats245,247
 -coats, for cleanroom247,1503,1506
 -mats191
 -notebooks174,1534
 -presses599
 -trays107-109
 Ladle scoops116
 Laminar flow workbenches1357-1358,1360
 Lamps
 -handle for UV lamps1310
 -holder for UV lamps1310
 -pocket132
 -UV1310
 Leak testing978
 Leakproof bottles84
 LED
 -illumination1110,1112
 -lighting1110,1112
 -modul1110
 -transilluminators1310-1311
 Leeb-Hardness testers439
 Lens cleaning tissues204,1107
 Lids
 -buckets55
 -containers52
 -flat ground flange630-631
 -ultrasonic baths1189
 Liebig condensers637
 Light
 -guides1109
 -measuring instruments422
 -microscopes1101-1102,1104
 Linear shakers505,507-508,511,887-888
 Linen testers1094-1095
 Liquid dispensers, for cleanroom1108
 Liquid samplers553-558,564
 Litmus paper297
 Loop sterilizers1380-1382
 Luer-Lock Syringes1356,1460
 Luer-Slip Syringes1356,1460
 Luminometer1396

- M -

Macropipette controllers941
 Magnesia
 -rods114
 -trays114
 Magnetic stirrers
 -accessories469,472-473
 -ATEX455
 -bearing490
 -contact thermometer473
 -control units451
 -digital465,471
 -for cell culture451
 -for microtiter plates459
 -illuminated453
 -mini448-449
 -multi-position453,456-457,459,473-474
 -reaction block475
 -temperature sensors461
 -ultra-flat451,454-455
 -with battery operation460
 -with heating464,466-467,469-471,473-474
 -without heating448-454,457,460
 Magnetic stirring bars
 -beakerliner477
 -cylindrical462,476
 -dumbbell477
 -oval477
 -retrievers463
 -set476
 -triangular476-477
 Magnifiers
 -folding1095
 -hand-held1094
 -illuminated1094,1096
 -micro1096
 -precision1095
 -reading1094
 -scale1095
 -table-top1096
 Magnifying lens1094
 Manifolds742
 Markers
 -cleanroom1534
 -cryogenic762
 -diamond-tipped130
 -for glass130
 -permanent172-173
 Mats
 -adhesive, for fine dust1542-1545
 -adhesive, for shakers888
 -for cleanroom1542-1545
 Max/Min-Thermometers391
 Measuring cylinders
 -class A, boro 3.3910
 -class A, Duran®910-911
 -class A, PMP915
 -class B, boro 3.3911
 -class B, Duran®911-912
 -class B, PP913-914
 -class B, SAN915
 -hexagonal foot912
 -low form915
 -PP914
 -trace analysis1229
 -with handle914
 -with spout912-913

Measuring jugs			
-conical17	
-plastic17-18	
-plastic, SAN18	
-stainless steel18	
Measuring scoops138,552	
Media bottles1347-1348	
Media for bacteria/yeasts1361	
Melting point meters			
-capillary tubes443	
-instruments443-446	
-standards443	
Membrane filters			
-blotting723	
-CA724	
-holders741	
-MCE725	
-NC726-728,1391	
-NY722	
-PC723	
-PTFE721	
-RC723-724	
Mercury collectors263	
Mesh			
-PE597	
-Polyamide597	
Meters			
-conductivity329-337,345-346,348,351	
-density430-431	
-melting point443-446	
-multiparameter345	
-oxygen347,351	
-oxygen enrichment1217	
-pH299-314,345	
Micro-ball mills582	
Micro-tubes			
-DNA-free1409	
-multi-racks37	
-racks, plastic33-35,1412	
-safe-lock1410	
-stands33-37	
-with attached lid1406-1407,1409	
-with attached screw cap1407	
-with detached screw cap1408	
Microbiological			
-dry swabs1396	
-incubators861,865,869	
-media1361-1362	
-monitors1390	
-rapid tests864,1362-1363	
Microcentrifuges669-671,673	
Microfluidics1055-1058	
Microlitre pipettes			
-dilution956	
-fixed volume949,955,966-967,972-973	
-multichannel954,958-959,961-964,970-971,975,977-978	
-single channel949-953,955-958,960-967	
-variable volume949-950,953-967	
Microlitre syringes1455-1458,1491	
Micropipettes			
-controllers946,948	
-disposable947	
Microplates			
-384-well1320	
-96-well1297,1316-1320	
-magnetic1302	
Microplate			
-readers1144-1146	
-sealing tapes1320	
-shakers502,504,527-528,530,539-540	
Microplate			
-spinners668	
-washers1146	
Microscope slides			
-adhesive1116	
-boxes1119-1121	
-cleaning442,1107	
-cover slips1118	
-diagnostic1117,1335	
-dispensers1117	
-drying bench1404	
-drying pads442	
-folders1120	
-folders, Munich1120	
-forceps135	
-holders1117	
-immersion oil1107	
-mailers1119-1120	
-prepared1119	
-standard1116	
-stands1117	
-Superfrost1116	
-trays1120	
-with cavities1116,1335-1336	
Microscopes			
-binocular441-442,1099,1101-1102,1104	
-cleaning set442	
-clinical441-442	
-digital cameras1105	
-digital CMOS cameras1105	
-drying pads442	
-educational1097,1101,1104	
-fluorescence1106	
-Greenough stereo1103-1104	
-immersion oil1107	
-inverted1100	
-lens cleaning tissue1107	
-life science1100	
-light441,1102	
-monocular1101	
-polarisation442	
-stereo441	
-trinocular441-442,1097-1098,1100-1102	
-Wifi cameras1104	
-zoom stereo1103	
Microtiter plate shakers540	
Microtiter plates1297,1316-1320	
Microwaves852	
Microwell plates1339	
Micro			
-clamps185	
-spatulas118	
-spoons117-118	
Milk analysis			
-butyrometers1275-1276	
-centrifuges1277	
-cryoscopes1277	
-extraction tubes1276	
-freezing point1277	
Mills			
-batch575	
-centrifugal570	
-cross beater572	
-cutting573-574,579,589	
-disk581,587-588	
-dry568	
-grinding576-577	
-grinding jars583-585	
-knife580-581	
-micro ball582	

Mills
 -mixer583-584
 -mortar573,586
 -planetary ball569,585-586
 -rotor beater570
 -tube575
 -ultra-centrifugal571
 -universal578-579
 -variable speed rotor588
 Mini-cartridge filters740
 Mini-incubators864-865
 Mixer mills583-584
 Mixers
 -homogenisers567
 -magnetic449,452
 -paddle488,495,566
 -roller535-539
 -tumble534-535
 Mixing cylinders
 -class A, glass916
 Moisture
 -analysers371,376-378
 -halogen balances371,377
 Molecular model systems174-175
 Monitors, microbiological1390
 Mops
 -covers1539-1540
 -for cleanroom1539
 -frames1540-1541
 -handles1542
 Mortar grinders573,586
 Mortars
 -agate566
 -porcelain565
 -stainless steel566
 -with spout565
 Muffle furnaces902
 Multi-purpose
 -knives128-129
 -tools129-130
 Multidishes1337
 Multimeters347
 Multiparameter meters334,345-347,349,351

- N -

Narrow-mouth bottles1226-1227
 Needle containers261
 Nessler tubes1235
 Netting rolls66
 Neutralising agents1172
 Nitrogen
 -flasks623
 -stations1220
 -tubes623
 NMR
 -brushes1453
 -tubes1453
 Notebooks174
 NS jointed
 -Erlenmeyer flasks624
 -flat bottom flasks623
 -Kjeldahl flasks619
 -pear shape flasks620
 -round bottom flasks618-619
 -round bottom flasks, 2 necks620-621
 -round bottom flasks, 3 necks621-622
 Nucleic acid purification1301
 Nutrient pads1363

- O -

Oil binder262
 Oil test paper1237
 Orbital shakers501,505-508,510-514,517,540
 Orsat blowballs1028
 Osmolality standards1344
 Osmometers1344
 Ovens
 -accessories867
 -drying853,856,859-861
 -heating855,857
 -incubating865-867,869
 -protocol860-861
 -universal853-855
 -with forced convection853-855,857
 -with gravity convection855-856
 -with mechanical convection859-861
 -with natural convection857
 Overalls250-251,1504-1505
 Overhead shakers533-534
 Overhead stirrers
 -accessories489
 -bossheads490
 -digital478-483,485-488
 -for chemistry534
 -for haematology534
 -for waste water analysis535
 -rotors496
 -stands490-491
 -strap clamps490
 Overshoes252
 Oversleeves251
 Oxygen
 -depletion controllers1217
 -meters340-341,343
 -meters, portable341
 -sensors342-343
 Oxymeters340-342

- P -

Paddle blenders615
 Paddle stirrers488,495
 Paddles
 -2-blade493
 -3-blade493,496
 -4-blade493
 -6-hole494
 -centrifugal496
 -U-shaped496
 Palette knives120
 Paper
 -indicator296-297
 -indicator, special296-298
 -surface protection190
 Paraffin
 -section flotation baths1403
 -wax dispensers1403
 PARAFILM® M193
 Partition inserts for cryo boxes757-758
 Pasteur pipettes936
 PCR
 -adhesive film1296-1297
 -boxes1299
 -cabinets, UV1305
 -cap tools1294
 -centrifuge667-668
 -cyclers1302-1304
 -foil1296

- PCR**
 -laminar flow workbenches1305
 -laminar flows1305
 -mini-coolers1294,1299
 -plate sealers1297
 -plates, 24-well1295
 -plates, 48-well1295
 -plates, 96-well1295
 -plates, for qPCR1295
 -racks1298-1299
 -real-time PCR machine1303
 -tubes1292-1294
 -tubes, strips1292-1294
 -UV sterilisation cabinets1305
Peleus balls943
Peltier thermostats1132
Penetration thermometers399
Pepsin cleaning solution326
Peristaltic
 -pumps1043-1046,1048-1052
 -pumps, drives1050
 -pumps, heads1045,1049
Permanent markers172-173
Pestles
 -agate566
 -disposable, Pellet1387
 -MF565
 -micro1387-1388
 -porcelain565
 -quick-change chuck1387
Petri dishes
 -glass1364-1365
 -holders1365
 -PFA1223
 -PS874,1365
 -trace analysis1223
 -turntables1366-1367
Petrefilm1362
Pharmacist's spatulas120
Pharmacy workstations284
Phase separators713
Photometers
 -bench-top1240
 -cuvettes1157,1244
 -filter1246
 -hand-held1238-1239,1245
 -instruments1242
 -reagent solutions1244
 -reagent tablets1243
 -spectral1137-1142
 -system1241
 -test programs1248
 -turbidity testing1245
pH
 -combination electrodes319
 -combination electrodes, gel315
 -electrodes315-322
 -electrodes, cleaning326
 -electrodes, stands324
 -meters, benchtop309-314
 -meters, multi-parameters309
 -meters, pH/redox306
 -meters, portable299-308
 -meters, printers313-314
 -papers296-298
 -testers299-302
Pipette controllers939-941,948
Pipette fillers939
Pipette tips
 -box987
 -dual filter997-998
 -empty racks982
 -extra-long993
 -filter981,983,985-987,989-990,993-995,997
 -for PCR997
 -low retention964-965,981-982,998
 -macro989
 -racked985-987,990-995
 -refill system987,989,992
 -reload996-997
 -robotic999
 -standard981,988-989,991-992,994-996
 -storage system999-1000
 -ultra-micro988
 -wide994
Pipettes
 -boxes, cylindrical945
 -boxes, square945
 -boxes, variable945
 -bulbs942
 -capillary946-947
 -cargo rack944
 -digital microlitre952,955-957,960-961,963,965-967,
970,972-975,977-978
 -dilution microlitre956
 -electrical pump939-941
 -electronic953,956,958-959,962,964,969,971,974-975,977
 -fixed volume949,952,955,966-967,972-973,979
 -frame943
 -holders943,950-951,953,959-960,968
 -horizontal stands943
 -leak testing unit978
 -micro946
 -multichannel microlitre954,958-959,961-964,
970-971,975,977-978
 -pasteur, disposable936
 -pasteur, glass936
 -positive displacement979-980
 -racks943,950,976
 -rinsers944
 -safety bulb943
 -seals979
 -serological938
 -shelf holders959
 -single channel microlitre949-953,955-958,960-967
 -stands943,950-951,953,959-960,968,976,980
 -steppers1002,1004-1006
 -storage containers944
 -straw tips956
 -teats942
 -tips1003,1005,1007
 -trays943-944
 -ultrasonic cleaners1191
 -variable volume951-967
 -vertical stands943
Pipetting aids, micropipettes946,948
Pipettors, positive displacement1005-1006
Piston pumps1061
Pitchers16
Plasmid purification Kits1301
Plaster dispensers257
Plasters257
Plastic
 -beakers14
 -bottles84
 -buckets54-55
 -jugs16
 -pitchers15-18
 -stoppers1259

- Plates
 -cell culture1336-1337,1339
 -deep-well1416-1417
 -immunoassays1318-1319
 -microtitration1297,1316-1320
 -sealers1297
 -sealing tapes1320
 -storage1416-1417
 Platforms, anti-vibration384
 Platform
 -rockers522-523
 -shakers510,513,521,525,540
 Platinum wire1370
 Playing cards382
 Pliers131
 Pocket
 -lamps132
 -magnifiers1094
 -refractometers1125-1128
 -thermometers392-393
 Polarimeters1135-1136
 Pool testers1235
 Porcelain
 -casseroles106-107
 -crucibles111-112
 -evaporating basins105-106
 -evaporating dishes105
 -incinerating boats114
 -incinerating dishes114
 Positive displacement pipettes979-980
 Potassium iodide starch paper1237
 Pouches1209-1210
 Pouring rings68
 Powder
 -flasks662
 -spatulas123
 -spoons117
 Power
 -controllers850-852
 -failure detector188
 -supplies, electrophoresis1308
 Precision
 -balances358-364,372-374
 -thermometers394,398
 Preparative HPLC columns1473
 Pressure data loggers412-413
 Pressurized sprays96-97
 Propeller stirrers
 -3-blade493,496
 -4-blade493
 -6-hole paddle494
 -anchor494
 -centrifugal478,493
 -crescent-shaped496
 -disk-type494
 -dissolver493
 -paddle, 3 holes478
 -spiral494
 -U-shaped496
 Protection
 -aprons248
 -beard masks251
 -coats245,247
 -cream, skin244
 -film1536
 -gloves237-238
 -overalls249-250
 -overshoes252
 -plates145
 -sleeves251
 Protective
 -clothing248-251
 -face visors205
 -netting66
 Protein
 -assays1144-1145
 -gel electrophoresis1321
 -purification1331
 Pumps
 -automatic tube1216
 -barrel1038-1039
 -centrifugal1042
 -chemical-resistant1053,1062-1063,1065-1067
 -chemistry stands1070-1071,1073,1075
 -diaphragm1072
 -diaphragm vacuum1053,1062-1070
 -drum1037-1039,1042
 -foot1037,1040
 -hand1038
 -heads1052
 -liquid1053
 -mini solvent1040
 -peristaltic1043-1046,1051-1052
 -peristaltic, drives1049-1050
 -peristaltic, pumpheads1045-1046,1048-1049
 -rotary piston1054
 -rotary piston, pumpheads1054
 -rotary vane1074
 -solvent1040
 -syringe1055-1057
 -water jet1060
 Pure water systems1282-1283,1285-1290
 Pycnometers
 -glass427
 -stainless steel428
 - Q -
 Qualitative Test papers1237
 Quick closures630
 Quick
 -closures631
 -lock binders260
 - R -
 Racks
 -biobanking766
 -cryo boxes, chest freezers763
 -drying39
 -floating racks765
 -for centrifuge tubes35-37
 -for chromatography vials1451
 -for cryo boxes, upright freezers763
 -for cuvettes1160
 -for micro-tubes33-38
 -for microlitre pipettes950
 -for optical cells1160
 -for test tubes40-41
 -matrix, biobanking766
 -PCR1298
 -POM, for test tubes39
 -PP, for test tubes33,38
 -wired38
 Rapid tests
 -microbiological864,1362-1363
 -pool1235
 -test strips1236
 Raschig rings628,1231

Reaction tubes	
-racks	1412
-safe-lock	1410
-with attached lid	1406-1407,1409
-with attached screw cap	1407
-with detached screw cap	1408
-without screw cap	1408
Reactivation salt	1172
Readers, for microplates	1144
Reagent	
-bottles	85,89
-metering units	1253
-reservoirs	1000-1001
-solutions, for photometers	1244
-tablets	1243
Reciprocating shakers	512,515,521
Recirculating chillers	821
Redox buffer solutions	327
Reference electrolyte	328
Refractometers	
-Abbe	1132-1134
-benchtop	1130-1131
-digital	1127-1131,1135
-hand-held	1125-1129
-Peltier thermostats	1132
Refrigerated circulators	812-820
Refrigerators	
-biomedical	782
-power failure detector	188
-spark-free	787
Repeater pipettes	1002
Repetitive pipettes	1004
Reservoirs, for reagents	1000-1001
Respirators	208-209
Respiratory protection	208-213
Retort	
-clamps	183-184
-stand bases	177-178
Reverse osmosis systems	1289
Rings	
-for round bottom flasks	23
-pouring	68
-Raschig	628,1231
-sealing rings	652
Rocking shakers	510,513,518-521
Rods	
-air leak rods	637
-magnesia	114
-stirring	126
-support	179-180
Roll containers	685
Roller	
-mixers	537-539
-shakers	537-539
-steps	278
Rotary evaporators	
-apparatus	656-661
-flasks	662-663
Rotary	
-microtoms	1399-1400
-piston pumps	1054
-vane pumps	1074-1075
Rotator mixers	535-536
Rotators	
-mini	533
-tube holders	536
-vertical	533-534
Rubber	
-blowballs	942
-pipette balls	943

Rubber	
-sleeves	746
-spacers	750-751
-stoppers	30-31

- S -

Safety	
-barrels	269
-body showers	256
-boxes	264
-burners	142,1382-1386
-cabinets, microbiology	1357-1358,1360
-canisters	269
-cans	268
-chemical protection coveralls	1506
-CO ₂ monitors	1217
-containers	268
-disposal boxes	261
-drying ovens	858
-earplugs	214
-equipment storage boxes	215-216
-eye showers	253,256
-eyeshields	196,199-200,202,1511
-eyeshields, for cleanroom	1510-1511
-eyeshields, panoramic	202-204
-face masks	206,209
-face shields	205
-face visors	205
-fine-dust masks	207-209
-full face mask, filters	213
-full face masks	212
-funnels	268
-gloves	233,235,237-240
-half-mask, filters	210
-half-masks	210-211
-overgoggles	202-203
-overshoes	252
-overshoes, for cleanroom	1508-1509
-pipette balls	943
-pipette bulbs	943
-protective hoods	1508
-protective masks	1507
-protective visors	205
-sharp containers	261-262
-sleeve guard	1508
-spectacles	199-200
-spectacles, dispenser	51
-suction systems	1351-1353
-visitors eyeshields	196
-waste caps, HPLC	1479-1482
Sample preparation	
-clean-up stations	1220
-elution units	1219
-extraction units	1219
-nitrogen stations	1220
-soil analysis	1218
-water waste mixers	1218
Samplers	
-air	1216
-bottles	73
-disposable	546-547,557
-for bulk goods	73,543
-for trace analysis	557-558
-free flowing	544,546,557
-granules, powder	546,557
-liquid	554-558
-solids	543-547
-stainless	543
-ultra-pure sampling	557-558

Samplers		
-viscous liquid	557-558
Sample		
-bags	559-562
-collection cards	1300
-concentrators	1474
-conditioning solutions	328
-containers	42-45
-dishes	383-384
-dividers	598
-splitters	598
-tubes	1453
-tubes, trace analysis	1221
Sampling		
-beaker, stainless	556
-bottles	564
-catch net	556
-dippers	553
-paddle blenders	615
-pendulum beaker	554-555
-scoops	549,551
-spoons	120-121
-telescope	554-555
-transport	562
-tubes	542,562
-vessels	558
-waterlanding net	554
Sand baths	839
Scalpels		
-blades	1401
-disposable	1401
-handles	1401
Scintillation vials	43
Scissors		
-stainless steel	126-127
-surgical	127-128
Scoops		
-chemistry	553
-dispensing	138
-disposable	549,551
-food	139,552
-measuring	138
-sampling	549,551
Scrapers	124
Screw caps	48,67,69,75,78
Screwdrivers	131
Scrubbers	1273
Sealing		
-caps	698
-film	192-193
-film, dispenser	193
-mats, deep-well plates	1297,1415
-rings, for jointed glassware	652
-sterilisation	1210
-tapes	653,1535
-tapes, for microplates	1320
Seals		
-anti-tamper	547
-for sampling sacks	548
Seasand	1475
Secchi Disks	1262
Section lifters	120
Sedimentation cones		
-glass	1261
-holders	1261-1262
-Imhoff	1261
-SAN	1261
Self-filling syringes	1008
Semi dry blotters	1323
Separation filters	1328
Serological pipettes	938
Shakers		
-3D	523
-disruptor	1389
-flask	515
-horizontal	514-516
-incubator	505,529-530,878-883,885,887-888
-linear	505-508,511
-micro-tubes	502,528-529
-microplate	502
-microtiter	502,527-528,530,539-540
-orbital	505-514
-overhead	534
-reciprocating	515
-rocking	518-520,522-526
-roller	535,537
-rotator	535
-tumbling	522,524-526,534-535
-tumbling, 3D	523
-vertical	533-534
-vortex	497-504
Shaking		
-incubators	878
-water baths	836-838
-water baths, accessories	837-838
Sharps containers	261
Shoe covers	252
Sieve shakers	591-592
-analytical	593
-vibratory	593
Sieve		
-aids	594
-filters	100
-sand	595
-test sieves	594-595
Silica		
-adsorbents	1476
-layers for TLC	1496
Silicone		
-cap wads	647
-lid	22
-sealing rings	648
-stoppers	1373-1374
-surface mats	191
Silylation reagents	1490
Siphons	1038
Sit-over benches	1549
Skin protection	244,1525
Sleeves		
-cone joint	652
-disposable	652
-rubber	746
-with ribs	652
Slicers	128
Soakers	190
Soap dispensers	1525
Soil analysis		
-anaerobic digestion	1218
-elution units	1219
Solutions		
-cleaning, electrodes	326
-electrolyte	343-344
-pepsin cleaning	326
-sample conditioning	328
-staining, histology	1405
-storage and cleaning	328
Solvent pumps	1040
Sorbents	262-263

Sound	
-level meters	.421
-proof boxes	.614,1192
Spatulas	
-disposable	.123,546-547
-double-ended	.118-119
-double-scoop	.123
-Drigalski	.1367
-food	.547
-macro	.122
-micro	.118
-micro-spoons	.117
-Pharmacist's	.120
-PMMA	.124
-powder	.118,123
-PTFE	.1232
-round grooved	.119
-sampling	.123
-section filter	.120
-set	.125
-spoons	.116-117,123
-stainless steel	.117
-vibration	.119
-with knob	.119
-wood	.120,124
Spectrophotometers	
-accessories	.1138
-cells	.1157-1159
-double beam	.1141
-for microplates	.1144-1145
-nano	.1142
-reference beam	.1243
-single beam	.1137-1140
-split beam	.1243,1247
SPE	
-cartridges	.1465
-phases	.1463-1464,1467
-vacuum manifolds	.1466
Spin columns	.1301
Spinner	
-flasks	.1340
-mini plate	.668
Spiral condensers	.636
Spirit burners	.139
Sponge-Sticks	.561
Spoons	
-deflagrating	.116
-disposable	.120-123
-double ended	.115
-measuring	.122
-micro	.117-118
-multi-purpose	.116-117
-powder	.117
-sampling	.120-123
-short form	.115
-spatula	.116-117,123
-spatula, macro	.122
-spatula, micro	.118
-spatulas	.116
-sterile	.121
Spray bottles	.95-97
Sprays	
-disinfectant	.1163-1164
-oil	.194
Spreaders	.1367
Square bottles	.80,85-87,90
Staining jars	
-Coplin	.1124
-glass	.1122
-Hellendahl	.1123-1124
Staining jars	
-PMP	.1123
-Schiefferdecker	.1123
Staining	
-blocks	.1121
-cylinders	.1124
-plates	.1121
-racks	.1122-1123
-Solution Ponceau S	.1324
-solutions	.1405
-trays	.1123
-troughs	.1122-1124
-Western Blot	.1324
Stainless steel	
-baskets	.50
-beakers	.16
-bossheads	.182
-boxes	.108
-buckets	.55
-clamps	.555
-crystallising dishes	.105,111
-forceps	.134-135,137
-glove dispenser	.231
-jugs	.18
-manifolds	.742
-micropestles	.1387
-microtom blades	.1400
-mortars	.566
-rods	.179
-samplers	.544-545,553,556
-scissors	.126-128
-scoops	.138-139,381
-spatulas	.116,118,125
-spoons	.115-116,130
-test tubes racks	.41
-trolleys	.270,1537-1538,1545
Standards	
-COD	.1253
-density	.429
-dynamic viscosity	.429
-Gardner, colorimeters	.1235
-melting point	.443
-osmolality	.1344
-Pt-Co, colorimeters	.1235
-refractive index	.1134
-secondary, for spectrophotometers	.1151-1152
-sucrose	.1134
-turbidity	.1265
-viscometer	.429
Stands	
-for cuvettes	.1157,1160
-for electrodes	.324
-for extraction thimbles	.1267
-for forceps	.135
-for funnels	.102
-for microscope slides	.1117
-for optical cells	.1157,1160
-for pipettes	.950-951,953,959-960,968,976
-for sedimentation cones	.1261-1262
-for waste bags	.258-260
-micro-tube	.34
-tripod	.144-145
Steam sterilizers	.1203-1204
Stepper pipettes	.1002,1004-1006
Steps	.278
Stereo Microscopes	.441
Sterilisation	
-autoclaves	.1197-1202,1205
-containers	.1208
-controllers	.1206-1207

Sterilisation		Stoppers	
-indicator strips	.1208	-conical	.649
-indicator tapes	.165,1207	-cork	.32
-loops	.1380-1386	-glass	.649-650
-pouches	.1209-1210	-hollow	.649-650
-reels	.1208-1210	-NS	.649-650
-sealer	.1210	-PE	.694
-steam sterilizers	.1203	-PP	.649
Stillheads		-rubber	.30-31,1275
-Claisen type	.625	-silicone	.31,1373-1374
-with Liebig condenser	.625	-test tubes	.29
Stirrer bearings		-turn-over flange	.30
-glass	.633	Stopwatches	.417
-KPG	.632	Storage	
-PTFE	.633	-boxes	.52
Stirrer shafts		-boxes, culture tubes	.29
-3-blade	.493,496	-boxes, microscope slides	.1119-1121
-4-blade	.493	-boxes, microtubes	.36
-6-hole paddle	.494	-boxes, vials	.1451
-anchor	.494	-plates, deep-well	.1415,1417
-centrifugal	.493	-system, pipette tips	.999-1000
-crescent-shaped	.496	-tubes, biobanking	.766
-KPG	.632	Substrate-kits	.1325
-spiral	.494	Sucrose	.1134
-U-shaped	.496	Suction systems	.1351-1353
Stirrers		Sulphur dioxide determination	.1274
-couplings	.489	Support	
-disk-type	.494	-clamps	.849
-dissolver	.493	-rings	.23,180
-hotplates	.469	Surface disinfectants	.1163-1165
-induction-drive	.451	Surface protector	
-magnetic	.448-457,459-460,464-467,470	-cleanroom	.1550
-overhead	.478-483,485-489	-cork	.190
-temperature sensors	.461	-ESD	.1550
Stirring rods		-paper	.190
-glass	.126	-silicone	.191
-PTFE	.1232	Surgical	
-PVC	.126	-face masks	.206
Stirring rotors		-scissors	.128
-6-hole paddle	.494	Swabs	.1368,1397,1530-1532
-anchor	.494	Syringe filters	
-centrifugal	.493	-CA membrane	.729,732-733,735-736
-crescent-shaped	.496	-GF membrane	.731,739
-diagonal blade	.493	-H-PTFE membrane	.738
-disk-type	.494	-inorganic membrane	.733
-dissolver	.493	-MCE membrane	.736
-propeller, 3-blade	.493	-NY membrane	.732
-spiral	.494	-PA membrane	.738
-turbine	.493	-PC membrane	.732
-U-shaped	.496	-PES membrane	.734,738
Stirring shafts		-PET membrane	.737
-3-blade	.478,493,496	-PP membrane	.732
-4-blade	.478,493	-PSU membrane	.732
-6-hole paddle	.494	-PTFE membrane	.731,733-734,736-737
-anchor	.494	-PVDF membrane	.731,733,738
-centrifugal	.493	-RC membrane	.731,734-735,737
-crescent-shaped	.496	Syringeless filters	.739
-disk-type	.494	Syringes	
-spiral	.494	-all-glass	.1459
Stomacher bags	.616	-disposable	.1356,1460-1462
Stools	.272,274,276	-for CTC autosamplers	.1493-1494
Stopcocks		-for GC autosamplers	.1455,1458,1493
-drain syphon	.57	-for HPLC autosamplers	.1458
-one-way	.655	-for Perkin-Elmer GC autosamplers	.1494
-quick-action	.58	-for Shimadzu autosamplers	.1494
-straight bore	.655	-microlitre	.1455-1457,1491
-vacuum	.655	-needles	.1462
Stoppers		-self-filling	.1008
-cellulose	.1372		
-centrifuge tubes	.694		

Syringe	
-pumps	.1055-1057
-tips	.1005
- T -	
Table clamps	.179
Tamper-evident caps	.86,88-89
Tank blot systems	.1324
Tapes	
-adhesive	.165,167,1535
-dispenser	.167
-double-sided	.1536
-floor marking	.1535
-heating	.850
-label	.166
-sealing	.653,1320,1535
-sterilisation indicator	.165,1207
Teats	.942
Teclu burners	.142
Temperature	
-blocks	.764
-control systems	.826
-controllers	.851
-data loggers	.399,402-406,410
-indicators	.389
-probes	.395,397
-regulators	.850
-sensors	.851
-strips	.390
Tensile force measurement	.437
Test kits	.1325
Test papers	
-oil	.1237
-pH	.296-298
-qualitative	.1237
Test strips	
-nitrate	.1236
-qualitative	.1237
-rapid tests	.1236
-water hardness	.1236
Test tube racks	
-PP	.40
-self-aligning	.41
-stainless steel	.41
Test tubes racks	
-acetal plastic	.40
-foldable	.35
-PP	.36-39,41
-stainless steel	.38
-wire	.41
-wooden	.42
Test tubes	
-brushes	.29
-clamp	.42
-cleaner	.29
-conical bottom	.695
-drying racks	.39
-glass	.24-28
-glass, with rim	.26
-graduated	.28
-holders	.42
-rimless	.25
-round bottom	.24-26,695
-stoppers	.29-31
-trays	.838
-with stopper	.27
Test tube	
-caps	.29
-shakers	.499,503

Testers	
-air flow	.1212
-breathing air	.1216
-conductivity	.329-337
-cooking oil	.1237
-flocculation	.1263
-hardness, Leeb	.439
-linen	.1094-1095
-pH	.299-302
-shore hardness	.438
Test	
-sieves	.594-595
-stands	.437
Thermal beads	.829
Thermocyclers	.1302-1304
Thermohygrometers	.418-420
Thermometers	
-ASTM	.387
-contact	.395,397
-core	.393,395,398
-digital	.392-398
-for steam sterilizers	.1206
-general purpose	.385-386
-ground	.386
-hand held	.393-397,399,423
-holder	.387
-immersion	.398
-indoor/outdoor	.390
-infrared	.400-401
-insertion	.394-398
-low temperature	.386
-Min/Max	.388,390-391
-penetration	.394-399
-pocket	.392-393
-precision	.386-388,398,423
-probes	.395-397
-waterproof	.392
Thermomixers	
-accessories	.532
-exchangeable blocks	.532
-instruments	.527,530-531
Thermoprinters	.1202
Thermoreactors	.1249
Thermoregulators	.804-808,811-820,826
Thermoshakers	.527-530,540
Thermostatic	
-bath liquid	.840
-controllers	.799,802,804-807
-water baths	.796,800,802
Thermostats	
-bath	.814
-circulation	.804,807-809,811-820
-cooling	.814-820
-covers	.809
-immersion	.796,801
-Peltier, for refractometers	.1132
-software	.827
-temperature controllers	.826
Thread adapters	.1039
Threaded joints	.156-157
Ties for bags	.260
Timers	
-2-channel	.414
-3-channel	.415-416
-4-channel	.415
-clock	.414-416
-countdown	.416
-electronic	.414-416
-interval	.414,416
-short period	.414,416

- Timers
 -stopclock417
 -stopwatch417
- Tips
 -filter983,985-987,989-990,993-995,997
 -for dilution pipettes956
 -for stepper1003,1005,1007
 -low retention964-965,981-982,998
 -macro989
 -racked985-986,991-994
 -refill system987,992
 -robotic999
 -standard981,983-984,988,992,996
 -storage system999-1000
 -ultra-micro988
- Tissue culture dishes877,1331-1332,1336
- Tissues
 -cleaning230,1174,1176-1177
 -dispenser bin1162
 -for surface disinfectant1162
 -hand towels1178-1179
 -lens cleaning1107
- Tissue
 -embedding wax1404
 -grinders1388
 -vials1400
- Titration stations1252
- Titration stations
 -accessories1033
 -automatic1033-1036
 -COD1253
 -digital1029-1030
 -motor-driven piston1031-1032
- TLC
 -aluminium oxide layers1498
 -atomisers1499-1500
 -chromatography paper1497
 -developing chambers1499
 -dryers139
 -H separating chambers1499
 -irradiation systems1500
 -nano separating chambers1499
 -plates, Silica gel1496
 -separating chambers1498
 -silica layers1495-1496
 -sprayers1499
- Tongs
 -for basins144
 -for beakers144
 -for crucibles143-144,1233
 -for flasks144
- Tongue depressors124
- Tools129-131
- Toothpicks1367
- Torches132
- Towels1179
- Trace analysis
 -beakers1223-1225
 -bottles1226-1228
 -Erlenmeyer flasks1225
 -evaporating dishes1222
 -measuring cylinders1229
 -Petri Dishes1223
 -sample jars1230
 -stirrers1232
 -tubes1221
 -vials1230
 -wash bottles1228-1229
 -watch glasses1222
- Transfer membranes1323
- Transfer paper1533
- Transilluminators1310-1311
- Transport
 -baskets50
 -boxes52-53
 -containers55,269
 -cool boxes794
 -microscope slides1119-1121
 -trolleys270-271,1537-1538,1545-1546
 -tubes562
- Traps
 -cold1076
 -condensation1076
- Trays
 -for test tubes833
 -with compartments110
- Tripod stands144-145
- Trolleys270-271,1537-1538,1545-1546
- Tube mixers497-502,504,535-536
- Tubes
 -capillary, air leak637
 -capillary, melting point443
 -capping system767
 -centrifuge, 5 ml691-693
 -centrifuge, ASTM689-690
 -centrifuge, black1414
 -centrifuge, conical0,688-689
 -centrifuge, FEP696
 -centrifuge, glass688-690
 -centrifuge, graduated688
 -centrifuge, LoBind1414
 -centrifuge, Oak Ridge697
 -centrifuge, oil test689-690
 -centrifuge, PC696-697
 -centrifuge, PP691,694-695
 -centrifuge, PPCO697
 -centrifuge, PS694-696
 -centrifuge, PSU696
 -centrifuge, round bottom688-689,691
 -centrifuge, with rim694-695
 -cryogenic754-756
 -culture1374-1375
 -DNA1409
 -drying tubes628-629
 -Durham type1375
 -Eppendorf Tubes®692
 -extraction Mojonier1276
 -for trace analysis696,1221
 -for UV lamps1311
 -gas detection1213-1215
 -gas sampling542
 -Haematocrit capillary947-948
 -insertion637
 -micro capillary947
 -micro centrifuge, PP690,1409
 -micro-tubes1406-1409
 -micro-tubes, safe-lock1410
 -microcentrifuge690
 -Nessler1235
 -nitrogen623
 -reaction1409
 -sampling1213-1215,1453
 -storage, biobanking766
 -test, PP694
 -test, PS694
 -test, round bottom695
 -threaded654

Tubing	
-clamps	162-164
-clamps, curved	162
-clamps, Herbie	164
-clamps, Pean	163
-clips, Hofmann	163
-connectors	159
-connectors, 3-way	161
-connectors, 4-way	160
-connectors, Y	160
-cutters	130,152
-dialysis, clips	1331
-flanged	1483
-gas burners	146
-gas safety	146
-gauge	153
-iso-versinic	150
-PFA	149
-pumps	1051-1052
-silicone	147-148,150
-Tygon	151-152
-vacuum	147
-Viton	149

Tumbling shakers	522-526
------------------	---------

Turbidity	
-meters	1263-1265
-standards	1265

Tweezers	
-pointed	136
-stainless steel	134-135
-sterile	137

- U -

Ultrasonic baths	
-accessories	596,1188-1191
-apparatus	1185,1187
-baskets	1188-1189
-lids	1189
-microbiology	1190
-shaker baths	1192
-sieve baths	596

Ultrasonic	
-cleaners	205
-cleaning concentrates	1193
-homogenisers	610-614
-pipette cleaner	1191

Unergloves	
-cotton	237
-nylon	1524
-polyester	1524

Urine cups	47
------------	----

USB Hand-held microscopes	440,1105-1106
---------------------------	---------------

UV	
-lamps	1310-1311
-PCR cabinets	1305
-transilluminators	1311

- V -

Vacuum pumps	
-chemistry	1070-1071,1073,1075,1353
-diaphragm	1062-1070
-valve-regulated	1071-1072

Vacuum	
-aspiration systems	1351-1352
-bottles	77
-controllers	1079-1080
-desiccators	1081-1082,1084
-drying ovens	863

Vacuum	
-filtration systems	743-744,1390
-grease	653
-grease, silicone-free	653
-grease, water soluble	653
-measuring instruments	1078,1080
-modular systems	1071
-ovens	863
-pump trolley	1075
-tubings	146

Valves	
-2-way	158
-angled	57
-non-return	161

Vertical shakers	533-534
------------------	---------

Vials	
-2in1 Kits crimp neck ND11	1442
-2in1 Kits screw neck ND8	1436
-2in1 Kits short thread ND9	1439
-2in1 Kits snap ring ND11	1443
-crimp neck ND11	1440-1441
-crimp neck ND13	1443
-crimp neck ND20	1449
-crimp neck ND8	1435
-crimping tools	1451
-headspace ND18	1446
-headspace ND20	1446-1447
-micro-inserts ND11	1435,1441
-micro-inserts ND8	1435
-screw neck ND10	1437
-screw neck ND13	1443
-screw neck ND24	1450
-screw neck ND8	1435
-shell ND12	1445
-shell ND15	1445
-shell ND8	1445
-short thread ND9	1437
-snap cap N22	1445
-snap cap ND18	1445
-snap ring ND11	1441
-wash kits	1446

Vibration spatulas	119
--------------------	-----

Viscometers	
-digital	433
-holders	433
-measuring instrument	436
-rotation	434-435
-standards	429
-Ubbelohde	433

Visitor gowns	247
---------------	-----

Volumetric flasks	
-amber	924
-class A, boro 3.3	918-921,923
-class A, Duran®	917,919,922,924
-class A, PFA	1229
-class B, PP	926
-oil testing	925
-sugar testing, Kohlrausch	925
-trapezoidal shape	917

Volumetric pipettes	
-1 mark	927-930
-2 marks	929-930
-class AS, glass	927-930
-class B, glass	930
-PP	930

Vortex mixers	497-504
---------------	---------

Vortexers	497-504
-----------	---------

- W -

Wash bottles	
-narrow-mouth	.91-92
-safety	.92-94
-safety, vented	.92,94
-trace analysis	.1229
-wide-mouth	.91-92
Washers	.1195-1196
Washing brushes	.1181
Waste	
-bags	.258-259
-disposal unit	.266-267
-water mixers	.1218
Watch glasses	
-glass	.103
-PP	.104
-PTFE	.1222
-trace analysis	.1222
Water analysis	
-content determination	.1274
-test strips	.1236-1237
Water baths	
-accessories	.799,834-835
-circulating	.798,804,808,810
-digital	.829-831,833-835
-heating	.829-831,834-835
-lids	.800,833
-preservative liquid	.819
-protection agent	.819
-shaking	.836-838
-shaking, accessories	.837
-stirred	.802
-tanks	.807
-thermostatic	.832-833
-unstirred	.831,833
Water estimator apparatus	.1267
Water jet pumps	.1060
Water nuclease-free	.1300
Water purification	
-pure water systems	.1285,1288
-reverse osmosis systems	.1289
-ultra-pure water systems	.1282-1284,1286-1290
Water	
-analysis apparatus	.534-535,1217
-analysis, biodegradability	.1217

Water	
-estimators	.637
-sampling	.553-558,564
-treatment systems	.1278-1281
Weighing boats	
-aluminium	.383
-antistatic	.383-384
-hexagonal	.384
-Kjeldahl	.382
-paper	.382
-square	.384
Weighing dishes	
-aluminium	.383
-PS	.383-384
Weighing platforms	.357
Weighing scoops	
-aluminium	.381
-glass	.381
-porcelain	.381
-stainless steel	.381
-without counterweight	.381
Weighing	
-bottles	.383
-brushes	.381,1183
-paper	.382
Weights	.380
Western blot	
-blocking solution	.1324
-substrate kits	.1325
Wet-Blotter	.1324
Wide-mouth bottles	.67,69-76,1227
Winkler bottles	.1258
Wipes for cleanroom	.1526-1530,1533
Wire gauzes	.145
Withdrawal caps for HPLC	.1478-1479
Workplace mats	.278
Workstations	.283-284
Woulff bottles	.1077

- X -

X-ray cassettes	.1326
-----------------	-------

- Z -

Zipper bags	.562
-------------	------

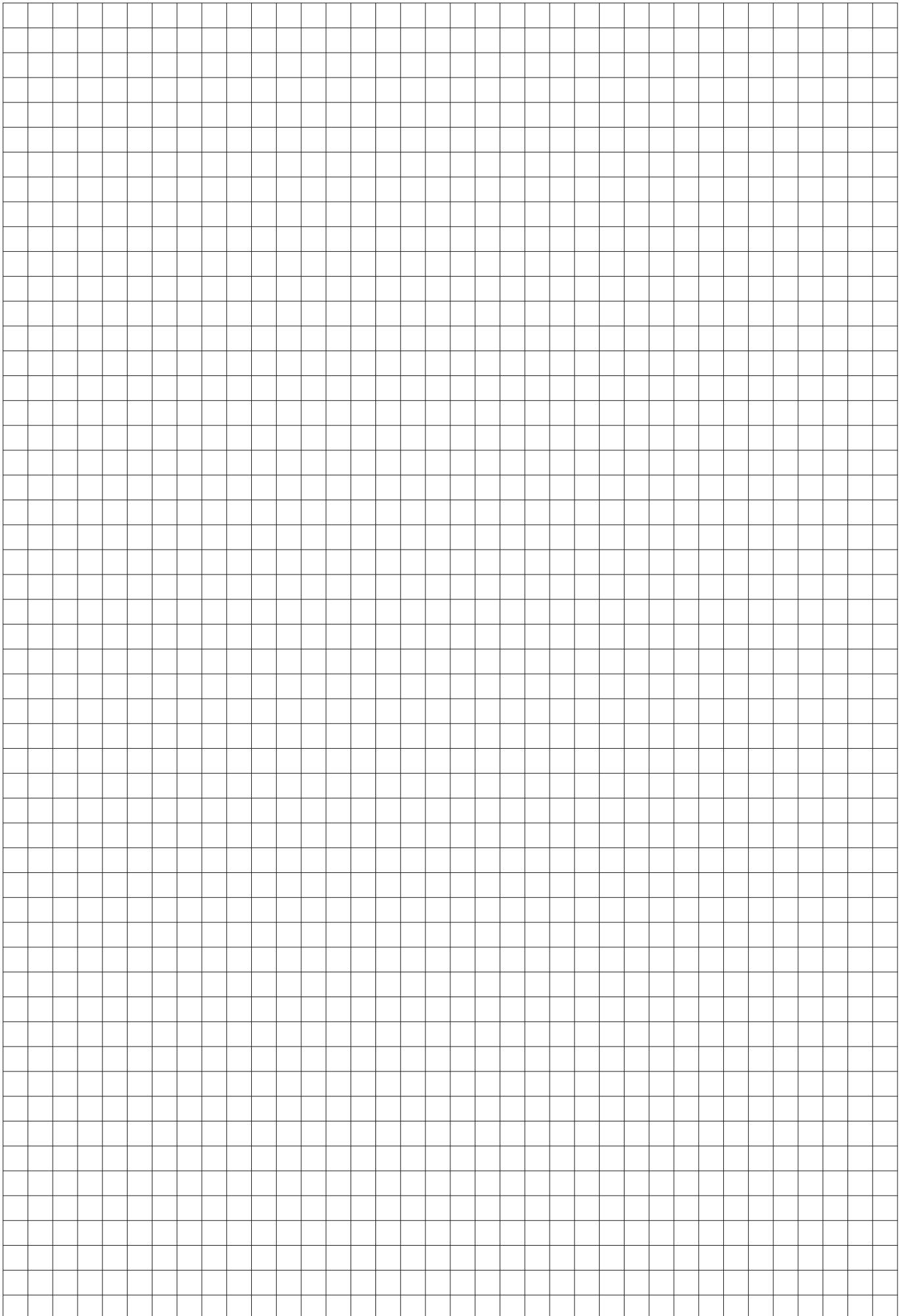

Vessels	13
Beakers.....	13
Measuring jugs.....	16
Flasks	19
Test tubes	24
Stoppers	29
Tube racks	33
Containers.....	42
Baskets.....	49
Transport boxes.....	51
Buckets.....	54
Aspirators and Carboys.....	56
Wide-mouth bottles	62
Wide mouth kegs.....	77
Narrow-mouth bottles	78
Square bottles	85
Reagent bottles.....	90
Spray, dropping bottles	91
Funnels.....	98
Cylinders.....	103
Dishes.....	103
Crucibles	111
Tools	115
Spoons, Spatulas.....	115
Knives, Scissors	126
Workshop tools	130
Forceps	132
Scoops.....	138
Heating	139
Burners.....	139
Beaker tongs	143
Tripod	144
Tubing	146
Tubing/Gas	146
Rubber.....	146
Plastic.....	147
Adapters, Clips, Clamps.....	153
General laboratory aids	165
Labels	165
Documenting	172
Laboratory jacks.....	175
Stands, Fittings.....	177
Batteries	187
Accessories for electrical device.....	188
Bags, Foils.....	188
Greases.....	194

PERFECT MATCH

Vials, closures and more
for chromatography applications



Your perfect match for all general chromatography applications

- One source for vials, closures and more
- DWK premium quality
- Borosilicate glass USP Type I and ASTM E438, Type I
- Made in USA



www.DWK.com



**DURAN
WHEATON
KIMBLE**

Excellence in your hands

1. General laboratory consumables

Vessels/Beakers

1 Beakers, Borosilicate glass 3.3, low form

DIN 12 331. ISO 3819. With approximate graduations and spout.

Nominal capacity ml	Diam. mm	Height mm	PK	Cat. No.
5 *	22	30	10	9.013 905
10 *	26	35	10	9.013 906
25 *	34	50	10	9.013 900
50	42	60	10	9.013 901
100	50	70	10	9.013 902
150	60	80	10	9.013 903
250	70	95	10	9.013 904
400	80	110	10	9.013 910
600	90	125	10	9.013 911
800	100	135	10	9.013 912
1000	105	145	10	9.013 913
2000	132	185	10	6.270 091
3000	150	210	1	6.270 090
5000	170	270	1	6.280 298

*without graduation



2 Beakers glass, DURAN®, low form

DIN 12331. ISO 3819. With approximate graduations and spout. With easy-to-read scale and large labelling field for easy marking. In fired-on, highly durable white ceramic. Due to the uniform wall thickness, it is suitable for use as a heating vessel. Glass Type I/neutral as per USP, EP and JP. With retrace code (Batch Identification, for all) except 5 ml, 10 ml and 25 ml. Certificate available via the Internet. Autoclavable. DWK Life Sciences

Nominal capacity ml	Diam. mm	Height mm	PK	Cat. No.
5	22	30	10	4.665 752
10	26	35	10	4.665 754
25	34	50	10	4.665 746
50	42	60	10	4.665 753
100	50	70	10	4.665 751
150	60	80	10	4.665 750
250	70	95	10	4.665 749
400	80	110	10	4.665 748
600	90	125	10	4.665 745
800	100	135	10	4.665 744
1000	105	145	10	4.665 747
2000	132	185	1	9.013 063
3000	152	210	1	9.013 068
5000	170	270	1	9.013 073
10000 **	217	350	1	9.013 086

** Not to DIN and ISO.



3 Beakers Super Duty, DURAN®, low form

With approximate graduations and spout. Reinforced, sturdy rim and increased mechanical strength for heavy duty. Glass Type I/neutral glass as per USP, EP and JP. With retrace code (Batch Identification). Certificate available via the Internet. Autoclavable. DWK Life Sciences

Nominal capacity ml	Diam. mm	Height mm	PK	Cat. No.
150	60	80	1	9.051 150
250	70	95	1	9.051 151
400	80	110	1	9.051 152
600	90	125	1	9.051 153
1000	105	145	1	9.051 154
2000	132	185	1	9.051 155
5000	170	270	1	9.051 156



4 Beakers, Borosilicate glass 3.3, tall form

DIN 12 331. ISO 3819. With approximate graduations and spout.

Nominal capacity ml	Diam. mm	Height mm	PK	Cat. No.
25 *	30	55	10	9.013 924
50	38	70	10	9.013 925
100	48	80	10	9.013 920
150	54	95	10	9.013 921
250	60	120	10	9.013 922
400	70	130	10	9.013 923
600	80	150	10	9.013 930
800	90	175	10	9.013 931
1000	95	180	10	9.013 932
2000	120	240	10	6.270 117
3000	135	280	1	6.313 628

*without graduation



Vessels/Beakers



1 Beakers glass, DURAN®, tall form

DIN 12331. ISO 3819. With approximate graduations and spout. With easy-to-read scale and large labelling field for easy marking, in fired-on, highly durable white ceramic. *DWK Life Sciences*
 Due to the uniformly wall thickness, it is suitable for use as a heating vessel. Glass Type I/neutral glass as per USP, EP and JP. With retrace code (Batch Identification). Certificate available via the Internet. Autoclavable.

Nominal capacity ml	Diam. mm	Height mm	PK	Cat. No.
50	38	70	10	4.665 762
100	48	80	10	4.665 755
150	54	95	10	4.665 759
250	60	120	10	4.665 758
400	70	130	10	4.665 761
600	80	150	10	4.665 760
800	90	175	10	4.665 757
1000	95	180	10	4.665 756
2000	120	240	1	9.013 163
3000	135	280	1	9.013 168



2 Filter beaker glass, DURAN®, heavy wall

With approximate graduations and spout. Glass type I/neutral glass as per USP, EP and JP. Autoclavable. *DWK Life Sciences*

Nominal capacity ml	Diam. mm	Height mm	PK	Cat. No.
250	70	94	1	9.051 036
500	89	124	1	9.051 044
1000	105	160	1	9.051 054
2000	135	195	1	9.051 063
3000	157	205	1	9.051 068
5000	182	256	1	9.051 073
10000*	225	340	1	9.051 086
15000*	260	390	1	9.051 088
20000*	285	430	1	9.051 091

*without graduation

3 Beakers, PP, low form

Kartell



Conform to ISO 7056 - 1981 (E). New PP giving very high translucency. Autoclavable to 121°C for 20 min. and can be used continuously at 100 °C. Permanent blue printed graduations. Excellent chemical resistance. Tolerance ±10 %.

Nominal capacity ml	Grad. ml	Diam. mm	Height mm	PK	Cat. No.
25	1	34	49	1	9.013 573
50	2	42	60	1	9.013 574
100	5	52	72	1	9.013 575
250	10	71	95	1	9.013 576
500	10	88	119	1	9.013 577
1000	20	110	146	1	9.013 578
2000	50	133	184	1	9.013 579
3000	500	159	201	1	9.013 580
5000	500	190	228	1	9.013 581



1. General laboratory consumables

Vessels/Beakers

1 LLG-Griffin beakers, PP



According to ISO 7056. With spout and printed blue graduations.

Nominal capacity ml	Grad. ml	Diam. mm	Height mm	PK	Cat. No.
25	5	32	47	2	9.013 670
50	10	39	60	2	9.013 671
100	10	50	70	2	9.013 672
250	25	67	93	2	9.013 673
500	50	88	119	2	9.013 674
1000	50	109	147	2	9.013 675
2000	100	133	184	1	9.013 676

1



2 Griffin beakers, PP



VITLAB

Highly transparent. With spout and easily readable, blue printed scale. To preserve markings, cleaning at no higher than 60 °C is recommended. Food-safe product according to regulation (EU) No. 10/2011.

Nominal capacity ml	Grad. ml	Ext. diam. mm	Height mm	PK	Cat. No.
10 */**	2	30	36	1	9.013 208
25 **	5	38	50	1	9.013 220
50 **	10	47	60	1	9.013 228
100	10	55	70	1	9.013 238
150*	20	66	80	1	9.013 244
250	25	77	95	1	9.013 248
400*	50	87	112	1	9.013 209
500	50	94	118	1	9.013 254
600	50	100	127	1	9.013 256
1000	100	120	147	1	9.013 262
2000	200	149	187	1	9.013 264
3000	250	170	212	1	9.013 266
5000	500	203	247	1	9.013 270

* Supplementary to ISO 7056
**blue printed scale, not raised



3 Griffin beakers PMP



VITLAB

Crystal clear. With spout and easily readable, printed red scale. To preserve markings, cleaning at no higher than 60 °C is recommended.

Nominal capacity ml	Grad. ml	Ext. diam. mm	Height mm	PK	Cat. No.
10 *	2	30	36	1	9.013 315
25	5	38	50	1	9.013 320
50	10	47	60	1	9.013 328
100	10	55	70	1	9.013 338
150*	20	66	80	1	9.013 344
250	25	77	95	1	9.013 348
400*	50	87	112	1	9.013 350
500	50	94	118	1	9.013 354
600*	50	100	127	1	9.013 356
1000	100	120	147	1	9.013 362
2000	200	149	187	1	9.013 364
3000	250	170	212	1	9.013 366
5000	500	203	247	1	9.013 370

* Supplementary to ISO 7056

Vessels/Beakers-Measuring jugs

1

1 Beakers, stainless steel

Manufactured from high quality, chemical and corrosion resistant AISI 304 grade stainless steel. Robust seamless construction guarantees a long life cycle. Highly polished smooth interior enables much easier cleaning.

ISOLAB

Nominal capacity ml	Ext. diam. mm	Height mm	PK	Cat. No.
100	50	60	1	6.286 609
250	65	85	1	6.286 610
500	82	110	1	6.286 611
1000	100	130	1	6.286 612

2

2 Beakers, stainless steel

Especially: Contact bottom for heating plates and magnetic stirrers.

Bochem

Nominal capacity ml	Diam. mm	Height mm	Description	PK	Cat. No.
100	50	60	with rim	1	9.013 600
250	65	85	with rim	1	9.013 601
500	80	110	with rim	1	9.013 602
1000	100	130	with rim	1	9.013 603
2000	120	180	with rim	1	9.013 604
3000	150	180	with rim	1	9.013 605
5000	180	210	with rim	1	9.013 606
100	50	60	with rim and spout	1	9.013 610
250	65	85	with rim and spout	1	9.013 611
500	80	110	with rim and spout	1	9.013 612
1000	100	130	with rim and spout	1	9.013 613
2000	120	180	with rim and spout	1	9.013 614
3000	150	180	with rim and spout	1	9.013 615
5000	180	210	with rim and spout	1	9.013 616
100	50	60	with rim and handle	1	6.237 690
250	65	85	with rim and handle	1	6.255 781
500	80	110	with rim and handle	1	6.237 691
1000	100	130	with rim and handle	1	6.237 692
2000	120	180	with rim and handle	1	6.203 870
3000	150	180	with rim and handle	1	6.268 733
5000	180	210	with rim and handle	1	6.226 943
100	50	60	with rim, spout and handle	1	6.056 364
250	65	85	with rim, spout and handle	1	6.056 365
500	80	110	with rim, spout and handle	1	6.056 366
1000	100	130	with rim, spout and handle	1	6.077 412
2000	120	180	with rim, spout and handle	1	7.604 208
3000	150	180	with rim, spout and handle	1	6.302 733
5000	180	210	with rim, spout and handle	1	6.085 775



9.275 266



Measuring jugs, PP, blue scale or embossed

BRAND

Transparent. Graduated beakers with handle with blue printed scale or embossed. Ergonomic handle for secure grip. Functional spout to minimize spills. Cleaning at temperatures below 60 °C is recommended to preserve marks and inscriptions. For autoclaving (121 °C), beakers with an embossed scale should be selected.



9.275 273

4

Nominal capacity ml	Grad. ml	Ext. diam. mm	Height mm	Description	PK	Cat. No.
50	2	43	67	blue	1	9.275 769
100	2	54	85	blue	1	9.275 263
250	5	74	120	blue	1	9.275 264
500	10	92	140	blue	1	9.275 265
1000	20	117	181	blue	1	9.275 266
2000	50	152	213	blue	1	9.275 770
3000	50	172	242	blue	1	9.275 267
5000	100	204	270	blue	1	9.275 268
50	2	43	67	embossed	1	9.275 269
100	2	54	85	embossed	1	9.275 270
250	5	74	120	embossed	1	9.275 271
500	10	92	140	embossed	1	9.275 272
1000	20	117	181	embossed	1	9.275 273
2000	50	152	213	embossed	1	9.275 274
3000	50	172	242	embossed	1	9.275 275
5000	100	204	270	embossed	1	9.275 771

1. General laboratory consumables

Vessels/Measuring jugs

1 LLG-Measuring jugs, PP



According to ISO 7056. With spout and printed blue graduations. Stackable.

Nominal capacity ml	Grad. ml	Ext. diam. mm	Height mm	PK	Cat. No.
250	5	75	115	2	9.013 680
500	10	100	137	2	9.013 681
1000	10	125	167	2	9.013 682
2000	20	148	217	1	9.013 683
3000	25	170	244	1	9.013 684



2 Measuring jugs with handle, PP



Kartell

Short form. Highly translucent especially when filled with liquids. Permanently moulded graduations. Heavy duty, with non-drip spout. Thumb grip on handle. Autoclavable

Nominal capacity ml	Grad. ml	Ext. diam. mm	Height mm	PK	Cat. No.
500	25	90	116	1	9.013 591
1000	50	116	131	1	9.013 592
2000	50	145	165	1	9.013 593
3000	100	165	180	1	9.013 594
5000	250	190	225	1	9.013 595



3 Measuring jugs, PP



VITLAB

Transparent. With stable handle and easily readable, printed black graduations on both sides. Therefore, the volume is equally visible for left- and right handers. To preserve markings, do not clean at temperatures exceeding 60 °C.

- Stackable
- Food-safe product according to regulation (EU) No. 10/2011.

Nominal capacity ml	Grad. ml	Ext. diam. mm	Height mm	PK	Cat. No.
250	5	75	115	1	9.275 738
500	10	97	140	1	9.275 740
1000	10	125	167	1	9.275 742
2000	20	148	212	1	9.275 744
3000	50	170	242	1	9.275 746



4 Conical measures, PP, graduated



Kartell

Graduated. Can withstand temperatures up to 120 °C. With wide base for stability. Autoclavable. Suitable for foodstuff.

Nominal capacity ml	Grad. ml	Height mm	PK	Cat. No.
100	2	118	1	9.013 773
250	5	164	1	9.013 774
500	10	183	1	9.013 775
1000	20	263	1	9.013 776



Vessels/Measuring jugs

1 2 Graduated jugs, PP, moulded graduations



VITLAB

Highly transparent. With a raised scale, spout and stable, easy-grip handle. Autoclavable at 121 °C (2 bar) according to DIN EN 285. Food-safe product according to regulation (EU) No. 10/2011. To preserve markings, do not clean at temperatures exceeding 60 °C. Conditionally autoclavable at 121 °C (2 bar) according to DIN EN 285. For autoclaving, we recommend the design with raised graduations.

Nominal capacity ml	Grad. ml	Ext. diam. mm	Height mm	Description	PK	Cat. No.
50	2	40	70	embossed	1	7.008 977
100	2	50	80	embossed	1	7.008 978
250	5	74	120	embossed	1	7.008 967
500	10	92	140	embossed	1	7.008 969
1000	20	117	181	embossed	1	7.008 971
2000	50	152	213	embossed	1	7.008 973
3000	50	172	242	embossed	1	7.008 975
5000	100	204	270	embossed	1	7.008 976
50	2	40	70	blue embossed	1	9.275 772
100	2	50	80	blue embossed	1	9.275 773
250	5	74	120	blue embossed	1	9.275 748
500	10	92	140	blue embossed	1	9.275 775
1000	20	117	181	blue embossed	1	9.275 776
2000	50	152	213	blue embossed	1	9.275 777
3000	50	172	242	blue embossed	1	9.275 778
5000	100	204	270	blue embossed	1	9.275 779



3 Graduated jugs, SAN, moulded graduations



VITLAB

Crystal clear. With a raised scale and stable, easy-grip handle. Food-safe product according to regulation (EU) No. 10/2011.

Nominal capacity ml	Grad. ml	Ext. diam. mm	Height mm	Description	PK	Cat. No.
250	5	70	120		1	7.008 966
500	10	91	133		1	7.008 968
1000	10	116	170		1	7.008 970
2000	20	150	215		1	7.008 972
3000	50	170	242		1	7.008 974



4 Measuring jugs with handle, stainless steel, heavy duty

18/10 steel. Graduated 200 ml. With spout and handle.

Bochem

Nominal capacity ml	Ext. diam. mm	Height mm	Description	PK	Cat. No.
1000	100	140	without foot	1	9.275 850
2000	130	170	without foot	1	9.275 852
500	90	125	without foot	1	6.072 687
1000	125	140	without foot	1	7.400 857
2000	140	170	without foot	1	6.204 504
500	115	115	with foot	1	9.275 860
1000	140	160	with foot	1	9.275 861
1500	150	160	with foot	1	9.275 862
2000	160	185	with foot	1	9.275 863

1 Erlenmeyer flasks, Borosilicate glass 3.3, narrow neck

DIN ISO 1773. With graduations and beaded rim.

Capacity ml	Neck diam. mm	Bottom diam. mm	Height mm	PK	Cat. No.
25	22	42	70	10	9.141 079
50	22	51	90	10	9.141 080
100	22	64	105	10	9.141 081
200	34	79	135	10	9.141 085
250	34	85	145	10	9.141 082
300	34	87	160	10	9.141 086
500	34	105	180	10	9.141 083
1000	42	131	220	10	9.141 084
2000	50	166	280	10	6.270 089
3000	50	187	310	1	6.270 118
5000	50	220	365	1	6.270 119

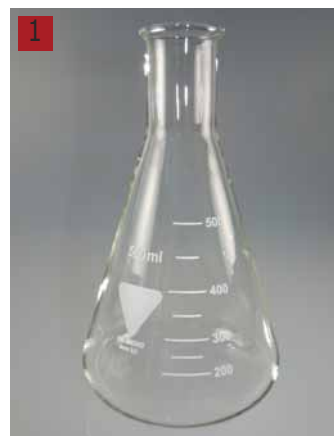

2 Erlenmeyer flasks, narrow neck, DURAN®

DIN ISO 1773. With approximate graduations and beaded rim. Uniform wall thickness distribution makes these beakers ideal for heating applications. Erlenmeyer flasks are well suited for mixing, because of their conical shape.

DWK Life Sciences

Glass Type I/neutral glass as per USP, EP and JP. Autoclavable.

With Retrace Code (Batch Identification), certificate available via the Internet.

Capacity ml	Neck diam. mm	Bottom diam. mm	Height mm	PK	Cat. No.
25**	22	42	75	1	9.141 014
50	22	51	90	1	9.141 017
100	22	64	105	1	9.141 024
125	28	67	112	1	9.141 028
150*	28	74	118	1	6.234 510
200*	34	79	131	1	9.141 032
250	34	85	145	1	9.141 036
300*	34	87	156	1	9.141 039
500	34	105	180	1	9.141 044
800	42	120	200	1	9.141 053
1000	42	131	220	1	9.141 054
2000	50	166	280	1	9.141 063
3000	52	187	310	1	9.141 068
5000	52	220	365	1	9.141 073

* Not to DIN.

**without retrace code



3 Erlenmeyer flasks, DURAN® Super Duty, narrow neck

With approximate graduations. Reinforced sturdy rim, and increased mechanical strength for heavy duty. Glass type I/neutral glass as per USP, EP and JP. With Retrace Code (Batch Identification) certificate available via the Internet. Autoclavable.

DWK Life Sciences

Capacity ml	Neck diam. mm	Bottom diam. mm	Height mm	PK	Cat. No.
25	22	42	75	1	9.141 270
50	22	51	90	1	9.141 271
100	22	64	105	1	9.141 272
250	34	85	145	1	9.141 273
500	34	105	180	1	9.141 274
1000	42	131	220	1	9.141 275
2000	50	166	280	1	9.141 276
5000	52	220	365	1	9.141 277

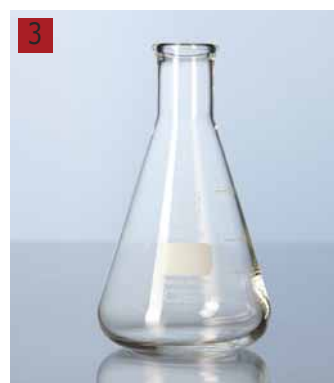

4 Erlenmeyer flasks, Borosilicate glass 3.3, wide neck

DIN ISO 24450. With graduations and beaded rim.

Capacity ml	Neck diam. mm	Bottom diam. mm	Height mm	PK	Cat. No.
25	31	43	70	10	9.141 186
50	34	51	85	10	9.141 180
100	34	64	105	10	9.141 181
200	50	79	131	10	9.141 187
250	50	85	140	10	9.141 182
300	50	87	156	10	9.141 183
500	50	105	175	10	9.141 184
1000	50	131	220	10	9.141 185
2000	69	166	280	10	6.270 181

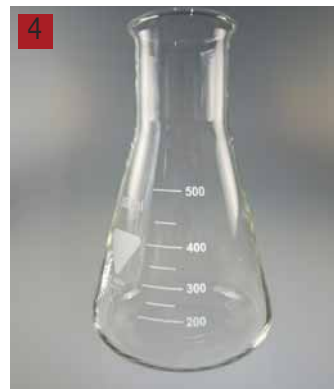

Vessels/Flasks



1 Erlenmeyer flasks, DURAN®, wide neck

DIN EN ISO 24450. With approximate graduations and beaded rim. With Retrace Code (Batch Identification), certificate available via the Internet. Uniformly wall thickness. Glass type I/neutral glass as per USP, EP and JP. Autoclavable.

DWK Life Sciences

Capacity ml	Neck diam. mm	Bottom diam. mm	Height mm	PK	Cat. No.
25**	31	43	70	1	9.141 114
50	34	51	85	1	9.141 117
100	34	64	105	1	9.141 124
200	50	79	131	1	9.141 132
250	50	85	140	1	9.141 136
300	50	87	156	1	9.141 139
500	50	105	175	1	9.141 144
1000	50	131	220	1	9.141 154
2000*	72	153	276	1	9.141 163

* Not to DIN.

**without retrace code



2 Erlenmeyer flasks DURAN® Super Duty, wide neck

With approximate graduations. Reinforced, sturdy rim and increased mechanical strength for heavy duty. Glass Type I/neutral glass as per USP, EP and JP. With retrace code (Batch Identification). Certificate available via the Internet. Autoclavable.

DWK Life Sciences

Capacity ml	Neck diam. mm	Bottom diam. mm	Height mm	PK	Cat. No.
100	34	64	105	1	9.141 280
250	50	85	140	1	9.141 281
500	50	105	175	1	9.141 282
1000	50	131	220	1	9.141 283



3 Erlenmeyer flasks, borosilicate glass 3.3, with screw neck

Borosilicate glass 3.3. Resistant to heat and almost all chemicals. Ideal for contamination free storage of culture specimen and media. Inscriptions are in white enamel which is specially designed for glass use. Autoclavable flasks and PP screw caps are resistant up to 121 °C.

ISOLAB

Capacity ml	Height mm	Neck thread GL	PK	Cat. No.
100	105	32	1	9.141 100
250	145	32	1	9.141 101
500	180	32	1	6.242 393
1000	225	32	1	9.141 102



4 Erlenmeyer flasks, DURAN®, with screw neck

With DIN screw neck, PBT-screwthread cap (autoclavable up to 180 °C), and approximate graduations. The flask is suitable for storage and cultivation. Glass Type I/neutral glass as per USP, EP and JP. Autoclavable; undo cap before autoclaving. With retrace code (Batch Identification). Certificate via internet.

DWK Life Sciences

Capacity ml	Bottom diam. mm	Height mm	Neck thread GL	PK	Cat. No.
100	64	109	25	1	9.141 224
250	85	149	32	1	9.141 236
500	105	180	32	1	9.141 244
1000	131	225	32	1	9.141 254

➔ Buffle flasks please see page 1371.

1. General laboratory consumables

Vessels/Flasks

1 Wide-mouth-Erlenmeyer flasks, PP, with screw neck



VITLAB

Highly transparent, can also be used with NS stoppers (not included). Suitable for storage and cultivation of cell cultures. Safer than glass flasks for use in incubator shakers due to the break resistance of plastic. Suitable for microwaves. To preserve markings, do not clean at temperatures exceeding 60 °C. Food-safe product according to EC Directive No. 10/2011.



Capacity ml	Grad. ml	stopper size	Neck thread GL	PK	Cat. No.
50	10	34/35	40	1	9.141 381
100	20	34/35	40	1	9.141 382
250	50	45/40	52	1	9.141 383
500	100	45/40	52	1	9.141 384
1000	200	45/40	52	1	9.141 385

2 Round bottom flasks, borosilicate glass 3.3

NEW
ISOLAB

- ISO 1773
- With beaded rim
- Thick walled
- Heat resistant

Nominal capacity ml	PK	Cat. No.
50	10	4.678 058
100	10	4.678 059
250	10	4.678 060
500	10	4.678 061
1000	10	4.678 062
2000	6	4.678 063
4000	1	6.254 100
6000	1	6.254 101
10000	1	6.254 102



3 Round bottom flasks, DURAN®, narrow neck

To DIN ISO 1773. With beaded rim. Glass Type I/neutral glass as per USP, EP and JP. Autoclavable.

DWK Life Sciences

Volume ml	Neck diam. mm	External flask diam. mm	Height mm	PK	Cat. No.
50	26	51	95	1	9.141 417
100	26	64	110	1	9.141 424
250	34	85	144	1	9.141 436
500	34	105	168	1	9.141 444
1000	42	131	200	1	9.141 454
2000*	42	166	260	1	9.141 464
3000*	50	185	260	1	9.141 468
4000	52	207	290	1	9.141 471
5000*	50	223	305	1	9.141 473
6000*	51	236	355	1	9.141 477
10000	65	279	380	1	9.141 486
12000**	65	295	380	1	6.801 504
20000**	76	345	515	1	9.141 491

* Not according to DIN ISO.
**according to ASTM E 1403.



4 Flat bottom flasks, borosilicate glass 3.3

NEW
ISOLAB

- With flat bottom
- ISO 1773
- With beaded rim
- Thick walled
- Heat resistant

Nominal capacity ml	PK	Cat. No.
50	10	4.678 064
100	10	4.678 065
250	10	4.678 066
500	10	4.678 067
1000	10	4.678 068
2000	6	4.678 069
4000	1	7.970 273
6000	1	6.254 092
10000	1	6.254 093

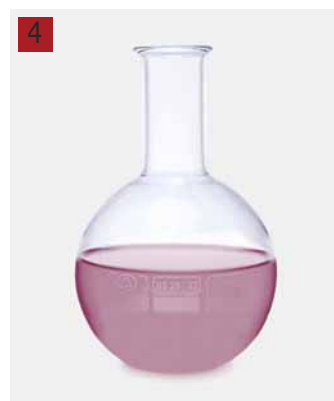

Vessels/Flasks



1 Flat bottom flasks, DURAN®, wide and narrow neck

DIN ISO 24450 (wide mouth), DIN ISO 1773 (narrow mouth). With beaded rim.

DWK Life Sciences

Glass Type I/neutral glass as per USP, EP and JP. Uniform wall thickness distribution makes these beakers ideal for heating applications. Flat base means flasks can be set down without a supporting ring. Autoclavable.

Description	Capacity	Neck diam.	External flask diam.	Height	PK	Cat. No.
	ml	mm	mm	mm		
wide mouth	50	34	51	90	1	9.141 717
wide mouth	100	34	64	105	1	9.141 724
wide mouth	250	50	85	138	1	9.141 736
wide mouth	500	50	105	163	1	9.141 744
wide mouth	1000	50	131	190	1	9.141 754
wide mouth	2000*	76	166	230	1	9.141 763
wide mouth	2000	50	166	230	1	9.141 764
narrow mouth	50	26	51	90	1	9.141 617
narrow mouth	100	26	64	105	1	9.141 624
narrow mouth	250	34	85	138	1	9.141 636
narrow mouth	500	34	105	163	1	9.141 644
narrow mouth	1000	42	131	190	1	9.141 654
narrow mouth	2000**	42	166	250	1	9.141 664
narrow mouth	3000**	50	185	250	1	9.141 668
narrow mouth	4000	50	207	275	1	9.141 671
narrow mouth	5000	50	223	290	1	9.141 673
narrow mouth	6000	65	237	315	1	9.141 676
narrow mouth	10000	65	280	360	1	9.141 686

* Not to DIN, with reinforced rim.

**Not to ISO.



2 Kjeldahl flasks, DURAN®

To DIN 12360. With beaded rim.

DWK Life Sciences

Capacity	Neck diam.	External flask diam.	Height	PK	Cat. No.
ml	mm	mm	mm		
50	22	51	200	1	9.141 817
100	22	60	200	1	9.141 824
250	34	81	270	1	9.141 836
500	34	101	300	1	9.141 844
750	34	115	340	1	9.141 851
1000	34	126	350	1	9.141 854

Note: special sizes available on request.



3 Silicone lid DURAN®

NEW

DWK Life Sciences



Stretchable silicone lid for safe covering of vessels, e.g. to protect against dust or splashing of solutions.

The wide overlapping sides of the silicone lid closes well with the vessel wall. Suitable for temperatures from -40 °C to 180 °C. The prolonged exposure to solvents may cause swelling of the material.

- Three different sizes and colours
- Labeling field on the flap
- Chemically resistant
- Heat resistant
- Suitable for dishwashers
- Autoclavable

Type	Ø mm	Colour	PK	Cat. No.
Size S	43 ... 61	pink	5	4.669 341
Size S	43 ... 61	cyan	5	4.669 342
Size S	43 ... 61	green	5	4.669 343
Size M	64 ... 76	pink	5	4.669 344
Size M	64 ... 76	cyan	5	4.669 345
Size M	64 ... 76	green	5	4.669 346
Size L	84 ... 116	pink	5	4.669 347
Size L	84 ... 116	cyan	5	4.669 348
Size L	84 ... 116	green	5	4.669 349
Set S / M / L		pink	1	4.669 338
Set S / M / L		cyan	1	4.669 339
Set S / M / L		green	1	4.669 340

1. General laboratory consumables

Vessels/Flasks

1 Flask rings, pressed cork

Height 30 mm.

For flasks ml	Ext. diam. mm	Int. diam. mm	PK	Cat. No.
4000	210	150	1	9.143 015
10 ... 100	80	30	10	4.667 531
250 ... 500	110	60	10	4.667 532
1000 ... 2000	140	90	10	4.667 533
3000	170	120	10	4.667 534



2 Flask ring, PP.



Kartell

Provides a secure base for round bottom flasks from 10 ml to 10000 ml capacity. Autoclavable.

For flasks ml	Diam. mm	Height mm	PK	Cat. No.
10 ... 10000	160	50	1	9.143 040



3 Flask support rings, "BiBase", silicone elastomer

Blue. Double sided. Sits firmly on the bench to support round-bottomed flasks.

- Resistant to oxidation and temperatures from -60 to +200 °C
- Very soft and easy to clean
- Resistant to chemicals
- Good thermal and electric insulation
- Excellent adhesion with glass
- Non-slip

For flasks ml	Ext. diam. mm	Int. diam. mm	Height mm	Max. kg	PK	Cat. No.
50 ... 500	80	46	30	13	1	9.143 035
500 ... 2000	120	80	40	18	1	9.143 036
2000 ... 6000	162	120	45	30	1	9.143 037



4 Stabilizing/Weighting rings, lead

LAB-Rings to stabilise glassware and plasticware on shakers or to immerse in water baths. Vinyl-coated lead rings will not mark or scratch benchtops and labware.

Type	For flasks ml	Int. diam. mm	PK	Cat. No.
O-Shape	5 ... 10	18	1	7.072 085
O-Shape	125 ... 500	48	1	6.243 010
O-Shape	250 ... 1000	51	1	6.242 742
O-Shape	500 ... 2000	57	1	6.243 011
O-Shape	1000 ... 4000	70	1	7.054 161
C-Shape	125 ... 500	42	1	9.149 902
C-Shape	250 ... 1000	51	1	9.149 905
C-Shape	500 ... 2000	54	1	9.149 906
C-Shape	1000 ... 4000	66	1	9.149 907

4



➔ Water baths please see page 829.

Vessels/Test tubes



1 LLG-Test tubes, soda-lime glass

Test tubes with round bottom. Hydrolytic resistance: Class HGB 3 acc. to ISO 719, Type III acc. to C - USP.

Diam. mm	Length mm	PK	Cat. No.
8	70	100	6.201 034
10	100	100	6.801 073
12	100	100	7.607 198
14	130	100	6.800 620
16	130	100	6.800 382
16	160	100	7.600 405
20	180	100	7.607 778
25	150	50	6.800 621
30	200	50	7.600 324
30	100	100	6.267 806
15	100	100	7.651 872
16	120	100	7.651 871
18	130	100	7.652 552



2 LLG-Test tubes, Fiolax® glass

Round bottom test tubes made of high quality Fiolax® glass with beaded rim.

Diam. mm	Length mm	PK	Cat. No.
8	70	100	7.190 001
10	100	100	6.234 026
12	75	100	7.613 795
12	100	100	7.190 011
14	130	100	7.606 374
16	130	100	7.606 375
16	160	100	7.190 021
18	180	100	7.190 023
20	120	100	7.617 551
20	180	100	7.190 028
30	200	50	6.801 914

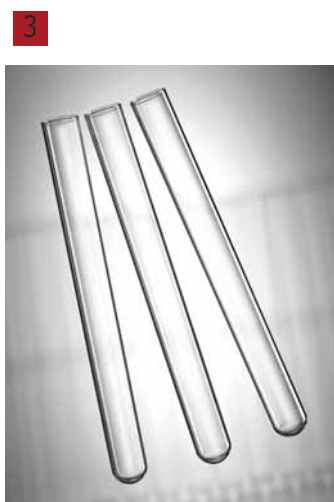

3 Test tubes, Soda Lime Glass

Scherf

Diam. mm	Length mm	Beaded rim	PK	Cat. No.
7.0	25	No	1000	4.658 073
6.5	35	No	1000	4.658 074
8.0	35	No	1000	4.658 075
8.0	40	No	200	4.658 076
9.5	40	No	500	4.658 077
10.5	40	No	500	6.802 657
6.5	50	No	1000	4.658 078
9.5	50	No	200	4.658 079
11.0	55	No	500	4.658 080
11.0	70	No	200	4.658 081
10.0	75	No	250	7.021 545
11.5	75	No	250	6.232 384
12.0	75	No	250	4.658 082
12.0	100	No	250	4.658 083
13.0	100	No	250	4.658 084
16.0	100	No	250	6.267 191
12.0	120	No	500	4.658 085
16.0	125	No	250	4.658 086
18.0	150	No	250	4.658 088
16.0	160	No	250	4.658 089
18.0	180	Yes	100	4.658 090
16.0	120	Yes	100	4.658 091
16.0	160	Yes	100	4.658 092
18.0	180	Yes	100	4.658 093
20.0	180	Yes	100	4.658 094

1 Test tubes, round bottom, Soda-lime glass

Heavy wall. Rimless, with round bottom.

Diam. mm	Length mm	PK	Cat. No.
8	40	200	9.400 004
10	70	100	9.400 007
12	75	100	9.400 009
15	85	100	9.400 011
10	100	100	9.400 015
12	100	100	9.400 017
14	100	100	9.400 020
16	100	100	9.400 022
14	130	100	9.400 030
16	160	100	9.400 040
16	160	100	6.282 424
18	180	100	9.400 050



2 Test tubes, Soda-lime glass, heavy wall

Rimless, with round bottom (0.7 to 1.0 mm wall thickness).

Scherf

Diam. mm	Length mm	PK	Cat. No.
8	40	100	9.190 200
10	70	100	9.190 202
10	100	100	9.190 205
12	75	250	6.258 821
12	100	250	6.258 822
14	100	250	6.258 823
14	130	250	6.258 824
16*	100	250	6.258 825
16*	160	250	6.258 826
18*	180	250	6.258 827

* Suitable for Kapsenberg caps.



3 Test tubes, Borosilicate glass 5.1

Scherf

Diam. mm	Length mm	Beaded rim	PK	Cat. No.
10	75	No	250	4.658 095
12	75	No	250	7.623 956
13	100	No	250	6.223 211
16	100	No	250	6.265 921
16	125	No	250	4.658 096
16	150	No	250	4.658 097
18	150	No	125	4.658 098
20	150	No	100	6.237 590
8	70	Yes	100	4.658 099
10	75	Yes	100	4.658 100
12	75	Yes	100	4.658 101
10	100	Yes	100	4.658 102
12	100	Yes	100	4.658 103
16	100	Yes	100	4.658 104
14	130	Yes	100	4.658 105
16	130	Yes	100	4.658 106
20	150	Yes	100	4.658 107
25	150	Yes	50	4.658 108
18	180	Yes	100	4.658 109
20	180	Yes	100	4.658 110
25	200	Yes	50	4.658 111
30	200	Yes	50	4.658 112



Vessels/Test tubes

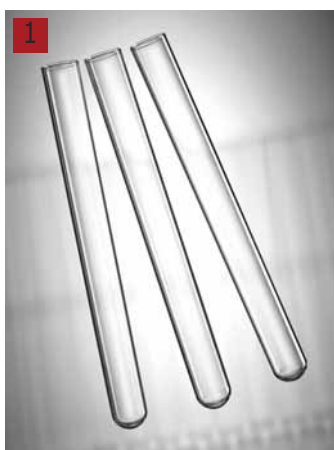

1 Test tubes, Borosilicate glass 3.3

Scherf

Diam. mm	Length mm	Beaded rim	PK	Cat. No.
10	75	No	100	4.658 113
12	75	No	100	4.658 114
10	100	No	100	4.658 115
12	100	No	100	6.281 701
16	100	No	100	4.658 116
14	130	No	100	4.658 117
16	130	No	100	4.658 118
20	150	No	100	4.658 119
25	150	No	50	4.658 120
16	160	No	100	6.266 691
18	180	No	100	4.658 121
20	180	No	100	4.658 122
25	200	No	50	6.281 479
30	200	No	50	4.656 051
10	75	Yes	100	4.658 123
12	75	Yes	100	4.658 124
10	100	Yes	100	4.658 125
12	100	Yes	100	4.658 126
14	130	Yes	100	4.658 127
16	130	Yes	100	4.658 128
20	150	Yes	100	4.658 129
25	150	Yes	50	4.658 130
16	160	Yes	100	4.658 131
18	180	Yes	100	4.658 132
20	180	Yes	100	4.658 133
25	200	Yes	50	4.658 134
30	200	Yes	50	4.658 135



2 Test tubes, Fiolax® glass

Fiolax®. Round bottom with rim. Light-walled and resistant to rapid temperature changes and localised heating.

DWK Life Sciences

Diam. mm	Length mm	PK	Cat. No.
8	70	100	9.190 001
10	75	100	9.190 003
10	100	100	9.190 006
12	75	100	9.190 008
12	100	100	9.190 011
14	130	100	9.190 013
16	130	100	9.190 016
16	160	100	9.190 021
18	180	100	9.190 023
20	150	100	9.190 026
20	180	100	9.190 028
25	150	50	9.190 033
25	200	50	9.190 036
30	200	50	9.190 038



1. General laboratory consumables

Vessels/Test tubes

1 Test tubes, DURAN®, heavy wall

Available rimmed or rimless. DURAN® test tubes have a heavier wall and considerable mechanical strength and excellent resistance to temperature changes.
Glass Type I/neutral glass as per USP, EP and JP. Autoclavable.

DWK Life Sciences

Diam. mm	Length mm	Beaded rim	PK	Cat. No.
8	70	With	100	9.190 101
10	75	With	100	9.190 103
10	100	With	100	9.190 106
12	75	With	100	9.190 108
12	100	With	100	9.190 111
13	100	With	100	9.190 112
14	130	With	100	9.190 113
16	130	With	100	9.190 116
16	160	With	100	9.190 121
18	180	With	100	9.190 123
20	150	With	100	9.190 126
20	180	With	100	9.190 128
25	150	With	50	9.190 133
25	200	With	50	9.190 136
30	200	With	50	9.190 138
8	70	Without	100	9.190 151
10	75	Without	100	9.190 153
10	100	Without	100	9.190 156
12	75	Without	100	9.190 158
12	100	Without	100	9.190 161
13	100	Without	100	9.190 162
14	130	Without	100	9.190 163
16	130	Without	100	9.190 166
16	160	Without	100	9.190 171
18	180	Without	100	9.190 173
20	150	Without	100	9.190 176
20	180	Without	100	9.190 178
25	150	Without	50	9.190 183
25	200	Without	50	9.190 186
30	200	Without	50	9.190 188



2 Test tubes, AR-Glas®

Round bottom, heavy wall.

NEW

Hecht

Diam. mm	Length mm	PK	Cat. No.
12	100	100	9.190 215
16	100	100	9.190 230
16	160	100	9.190 235
18	180	100	9.190 240

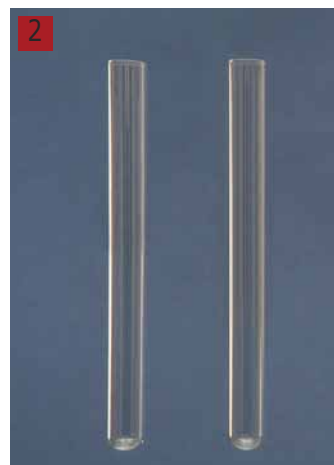

3 Test tubes, DURAN® tubing, without graduation, with NS joint, with PE stopper

Made of DURAN® tubing. Round bottom test tubes with NS socket and PE stopper.

Lenz

Diam. mm	Length mm	Ground size NS	PK	Cat. No.
16	100	14/23	1	9.190 410
16	125	14/23	1	6.233 870
16	160	14/23	1	9.190 416
18	150	14/23	1	6.243 070
18	180	14/23	1	9.190 418
22	150	19/26	1	6.235 895
28	150	24/29	1	6.231 352
28	200	24/29	1	6.226 470



Vessels/Test tubes



1 Test tubes, borosilicate glass 3.3, graduated, with stopper

Wall thickness approx. 1.2mm. With NS 14/23 ground socket and PP stopper. Graduations of approx. volume and markings are in high contrast white enamel. Supplied singly.

BRAND

Diam.	Length	Grad.	PK	Cat. No.
mm	mm	ml		
15	165	0.1	1	9.190 508
17	200	0.2	1	9.190 516
17	220	0.2	1	9.190 521
19	220	0.5	1	9.190 524



2 Culture tubes, Borosilicate glass 3.3, screw cap

For culture growth, transport and storage. Heavy walled, thickness 1.1 mm. Wide neck for easy inoculation and cleaning. Complete with aluminium or plastic screw cap and rubber sealing gasket. Autoclavable.

schuett-biotec

Diam.	Nominal capacity	Length	PK	Cat. No.
mm	ml	mm		
16	15	98	100	9.010 612
16	20	150	100	9.190 600
16	15	98	100	9.010 613
16	20	150	100	9.190 605
25	50	150	100	9.010 620

Spare screw caps on request.



3 Tubes, culture, Soda-lime glass, screw cap

Autoclavable. For culture growth, transport and storage. Complete with aluminium or plastic screw cap and rubber sealing gasket. The 5 ml size has a frosted marking area.

schuett-biotec

Further sizes available on request.

Diam.	Nominal capacity	Length	PK	Cat. No.
mm	ml	mm		
12	3	35	100	9.010 608
14	5	50	100	9.010 602
27	15	45	100	6.266 815
27	20	50	100	6.264 629
27	30	75	100	6.266 816
14	5	50	100	9.010 603
27	15	45	100	9.010 610
27	20	50	100	9.010 611
27	30	75	100	9.010 601

Spare screw caps on request.



4 Rolled rim bottles, Soda-lime glass with PE snap-on lid

With PE snap-on lid. Tight closing.

Nominal capacity	Ø with Cover	Height	PK	Cat. No.
ml	mm	mm		
3	19	31	200	9.400 211
5	19	41	200	9.400 215
10	21	51	200	9.400 220
10	22	46	200	9.400 225
15	24	53	200	9.400 235
20	27	56	200	9.400 240
20	25	71	200	9.400 250
25	30	51	250	9.400 230
30	28	76	200	9.400 260
40	30	81	200	9.400 270
50	30	101	200	9.400 280
100	34	146	100	9.400 290
25	30	65	200	6.270 036
10	24	32	200	7.609 731

Storage cases for culture tubes

For the protective storage and transportation of culture tubes.

schuett-biotech

For	Material	PK	Cat. No.
50 jars, 35x12 mm	Polystyrene	1	9.010 609 1
50 jars, 35x12 mm	Polypropylene, autoclavable	1	9.010 614 1
49 jars, 50x14 mm	Polypropylene, box black, autoclavable	2	9.010 606 2
100 jars, 50x14 mm	Wood	1	9.010 605 2



9.010 609



9.010 605

Test tube cleaners, rubber

For removing heavy soiling from test tubes by scraping. With 5 mm boring for rod.

Form	Width mm	PK	Cat. No.
Rubber Spatulas (grey)	35	1	9.190 902 3
Rubber Spatulas (red)	35	1	6.051 806 3
Rubber Spatulas (transparent)	35	1	6.076 243 3
Rod-shaped	8	1	9.190 901 4
4 blades	30	1	9.190 903 5

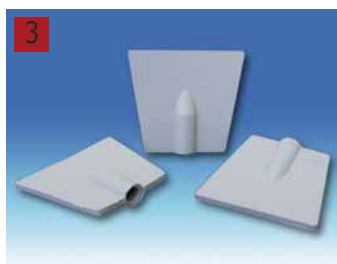

9.190 902

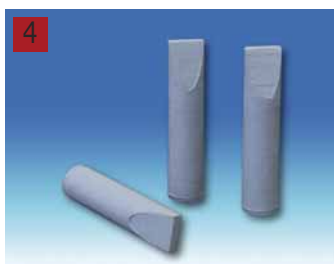

9.190 901



9.190 903

6 LLG-Stoppers, PE, for test tubes

Available in different sizes and colours.

For tubes diam. mm	Colour	PK	Cat. No.
12 - 13	neutral	100	9.231 270
12 - 13	blue	100	9.231 271
12 - 13	yellow	100	9.231 272
12 - 13	red	100	9.231 273
12 - 13	green	100	9.231 274
15 - 16	neutral	100	9.231 275
15 - 16	blue	100	9.231 276
15 - 16	yellow	100	9.231 277
15 - 16	red	100	9.231 278
15 - 16	green	100	9.231 279



7 Stoppers for test tubes, PE

Polyethylene.

Kartell

For tubes diam. mm	Colour	PK	Cat. No.
15 to 17	neutral	100	9.231 641
11 to 13	neutral	100	9.231 642
15 to 17	blue	100	9.231 643
11 to 13	blue	100	9.231 644
15 to 17	yellow	100	9.231 645
11 to 13	yellow	100	9.231 646
15 to 17	red	100	9.231 647
11 to 13	red	100	9.231 648
15 to 17	green	100	9.231 649
11 to 13	green	100	9.231 650



Vessels/Test tubes-Stoppers



1 Sealing caps for test tubes, versatile silicone

Transparent. Sealing caps have a slight taper and offer a very secure hold and are comfortable to use.

Saint Gobain

Ext. diam. mm	PK	Cat. No.
10	1	9.231 510
12	1	9.231 512
14	1	9.231 514
16	1	9.231 516
18	1	9.231 518
20	1	9.231 520
22	1	9.231 522
25	1	9.231 541
30	1	9.231 530
35	1	9.231 532
50	1	9.231 536



2 3 Stoppers, natural rubber, with single hole

Grey. DIN 12871.

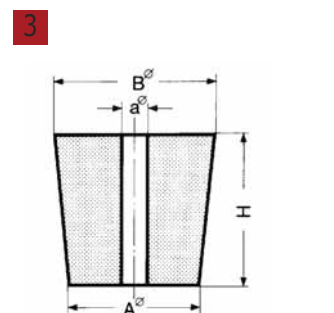

Bottom diam. mm	Top diam. mm	Height mm	Bore diam. mm	PK	Cat. No.
10.5	14.5	20	3	1	9.230 310
12.5	16.5	20	3	1	9.230 312
14.0	18.0	20	3	1	9.230 314
17.0	22.0	25	4	1	9.230 317
18.0	24.0	30	4	1	9.230 318
21.0	27.0	30	5	1	9.230 321
23.0	29.0	30	5	1	9.230 323
26.0	32.0	30	6	1	9.230 326
29.0	35.0	30	6	1	9.230 329
31.0	38.0	35	7	1	9.230 331
41.0	49.0	40	20	1	9.230 351
41.0	49.0	40	23	1	6.242 677



4 Stoppers, rubber, with turn-over flange

These stoppers guarantee perfect sealing even with poorly finished rims on glass or plastic bottles. The top of the stopper has a septum which can be punctured by a hypodermic needle. Very secure fit prevents accidental opening.

Diam. mm	PK	Cat. No.
7.1	100	9.230 640
10.2	50	9.230 641
12.7	50	9.230 642
14.9	20	9.230 643
15.9	20	9.230 644
19.4	20	9.230 645
23.7	10	9.230 646
30.7	5	9.230 647



5 Stoppers, silicone, with turn-over flange

These stoppers guarantee perfect sealing even with poorly finished rims on glass or plastic bottles. The top of the stopper has a septum which can be punctured by a hypodermic needle. Very secure fit prevents accidental opening.

Diam. mm	PK	Cat. No.
7.1	100	9.230 476
10.2	50	9.230 477
12.7	50	9.230 478
14.9	20	9.230 479
15.9	20	9.230 480
19.4	20	9.230 489
23.7	10	9.230 499

1 Rubber stoppers

Grey. DIN 12871. Solid.

Deutsch & Neumann



Bottom diam. mm	Top diam. mm	Height mm	PK	Cat. No.
3.5	6.5	15	1	9.230 203
5.0	9.0	20	1	9.230 205
8.0	12.0	20	1	9.230 208
10.5	14.5	20	1	9.230 210
12.5	16.5	20	1	9.230 212
14.0	18.0	20	1	9.230 214
17.0	22.0	25	1	9.230 217
18.0	24.0	30	1	9.230 218
21.0	27.0	30	1	9.230 221
23.0	29.0	30	1	9.230 223
26.0	32.0	30	1	9.230 226
29.0	35.0	30	1	9.230 229
31.0	38.0	35	1	9.230 231
36.0	44.0	40	1	9.230 236
41.0	49.0	40	1	9.230 241
47.0	55.0	40	1	9.230 247
50.5	59.5	45	1	9.230 250
56.0	65.0	45	1	9.230 256
60.0	70.0	50	1	9.230 260
64.5	75.5	55	1	9.230 264
71.0	83.0	60	1	9.230 271
79.0	92.0	65	1	9.230 279
87.0	100.0	65	1	9.230 287
94.0	107.0	65	1	9.230 294

2 Silicone rubber stoppers

Transparent. To DIN 12871. Solid. Operating temperature up to 220 °C. Supplied singly.

Deutsch & Neumann



Bottom diam. mm	Top diam. mm	Height mm	PK	Cat. No.
3.5	6.5	15	1	9.230 503
5.0	9.0	20	1	9.230 505
8.0	12.0	20	1	9.230 508
10.5	14.5	20	1	9.230 510
12.5	16.5	20	1	9.230 512
14.0	18.0	20	1	9.230 514
17.0	22.0	25	1	9.230 517
18.0	24.0	30	1	9.230 518
21.0	27.0	30	1	9.230 521
23.0	29.0	30	1	9.230 523
26.0	32.0	30	1	9.230 526
29.0	35.0	30	1	9.230 529
31.0	38.0	35	1	9.230 531
36.0	44.0	40	1	9.230 536
41.0	49.0	40	1	9.230 541
47.0	55.0	40	1	9.230 547
50.5	59.5	45	1	9.230 550
56.0	65.0	45	1	9.230 556
60.0	70.0	50	1	9.230 560
64.5	75.5	55	1	9.230 564
71.0	83.0	60	1	9.230 571
79.0	92.0	65	1	9.230 579
87.0	100.0	65	1	9.230 587
94.0	107.0	65	1	9.230 594



Vessels/Stoppers



1 Stoppers, cork

A1 quality. Non-porous.

Bottom diam. mm	Top diam. mm	Height mm	PK	Cat. No.
3	6	16	1	9.230 703
6	9	17	1	9.230 706
7	10	18	1	9.230 707
8	11	20	1	9.230 708
9	12	20	1	9.230 709
10	13	22	1	9.230 710
12	15	22	1	9.230 712
14	17	22	1	9.230 714
15	18	22	1	9.230 715
16	19	23	1	9.230 716
18	22	26	1	9.230 718
20	24	27	1	9.230 720
22	26	27	1	9.230 722
24	28	27	1	9.230 724
26	30	27	1	9.230 726
28	32	27	1	9.230 728
30	34	27	1	9.230 730
32	36	27	1	9.230 732
34	38	27	1	9.230 734
36	40	27	1	9.230 736
38	42	27	1	9.230 738
41	45	27	1	9.230 741
45	50	30	1	9.230 745
50	55	30	1	9.230 750
55	60	30	1	9.230 755
60	65	30	1	9.230 760
65	70	30	1	9.230 765

➔ For cellulose stoppers, please see page 1372.



2 Cork borers

Nickel-plated brass. With handles. Tube wall 0.4 mm.

Usbeck

Type	PK	Cat. No.
3-piece set, 5 ... 7.5 mm tube dia.	1	6.269 657
6-piece set, 5 ... 11.25 mm tube dia.	1	9.143 106
9-piece set, 5 ... 15 mm tube dia.	1	9.143 109
12-piece set, 5 ... 18.75 mm tube dia.	1	9.143 112
18-piece set, 5 ... 26.5 mm tube dia.	1	9.143 118

We can **supply** this
manufacturer's
whole
product range !



1. General laboratory consumables

Vessels/Tube racks

1 2 LLG-Microtube racks, PP, 80-well NEW



Made of Heavy-duty Polypropylene. Designed to hold 1.5 ml/2.0 ml microtubes (5 x 16 arrays) in a temperature range from -80 °C to 121 °C. Molded numbers on the surface for easy samples identification. Suitable for autoclaving at 121 °C.

1



2



Colour	PK	Cat. No.
yellow, red, blue, orange, green	5	4.672 062
yellow	5	4.672 063
red	5	4.672 064
blue	5	4.672 065
orange	5	4.672 067
green	5	4.672 068

3 Microtube Rack, PP BRAND



Grey. Numbered positions for 20 x 1.5 ml microcentrifuge tubes. Autoclavable (121°C). Dimensions (l x w x h): 210 mm x 70 mm x 37 mm. Accessories: Microcentrifuge tube racks can be equipped with inserts to accommodate 0.5 ml microcentrifuge tubes. Easy permanent assembly.

3



Array	PK	Cat. No.
2 x 10	1	9.409 380
Adapter (20 Units)	20	7.020 330

4 Tube Rack, PP BRAND



Stackable racks with alphanumerical positions. Operating temperature -20 °C to +90 °C. Autoclavable at 121 °C (2 bar), acc. DIN EN 285. Density 1.2 g/cm³. Will not float in water bath. Racks are supplied in two-pieces (Ø 11 mm, for micro tubes) or three-pieces (Ø 13 mm for cryogenic tubes) for convenient and permanent assembly. Dimensions (l x w x h): 265 mm x 126 mm x 38 mm.

For tubes diam.	Colour	Array	PK	Cat. No.
mm				
11	White	8 x 16	1	9.409 308
11	Blue	8 x 16	1	9.409 309
11	Red	8 x 16	1	9.409 312
13	White	6 x 14	1	9.409 314
13	Blue	6 x 14	1	9.409 316
13	Red	6 x 14	1	9.409 321

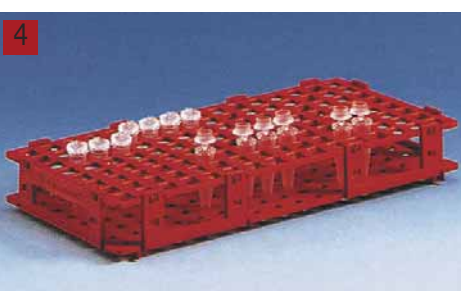

Vessels/Tube racks

Eppendorf Tube Racks, PP



Eppendorf AG

- Numbered positions for easy handling and identification
- Made of high quality polypropylene (PP) for chemical and physical resistance
- Temperature stability from -86 °C to 121 °C
- Autoclavable (121 °C, 20 min)
- Laboratory washer-safe for easy cleaning
- Stackable to save lab space

Array	For	PK	Cat. No.
48	Tubes, 0.5 ml	2	6.289 108 1
36	Tubes, 1.5 ml / 2.0 ml	2	6.289 109 2
12	Tubes, 5.0 ml / 15 ml	2	6.289 110 3
12	Tubes, 5.0 ml / 15 ml / 50 ml	2	6.289 111 4
36	Cryogenic tubes	2	6.289 112 5



6.289 108



6.289 109



6.289 110



6.289 111



6.289 112

6

6 Microtube racks, PP, 4-Way

Heathrow Scientific

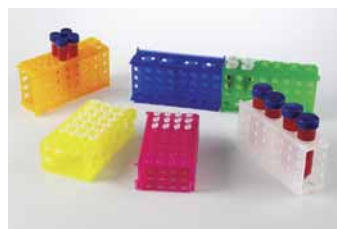

Racks feature a unique system of tabs and slots, which facilitate easy assembly and sturdy fit to build as large as rack as you need. Heavy-duty polypropylene racks can hold 4 x 50 ml or 12 x 15 ml conical tubes, 32 x 1.5 ml or 32 x 0.5 ml microtubes. Autoclavable.

Dimensions (L x W x H): 175 x 95 x 51 mm.

Colour	PK	Cat. No.
Natural	1	9.409 131
Blue	1	9.409 132
Green	1	9.409 133
Pink	1	9.409 134
Yellow	1	9.409 135
Orange	1	9.409 136
Blue, green, pink, yellow, orange	5	9.409 137

7

7 Test Tube Racks, PP, clinical, 4-Way

Heathrow Scientific



Especially suited for round, flat and conical blood collection and culture tubes. 6 racks can be assembled to build a large rack. Sturdy polypropylene racks can hold tubes of 13 x 75 mm, 13 x 100 mm, 16 x 100 mm, 16 x 125 mm, 17 x 120 mm or volumes of 3.5 ml, 7 ml, 10 ml, 15 ml. Different sizes to hold 12 or 18 tubes dependent on tube size. Dimensions (L x W x H): 232 x 70 x 95 mm.

- Racks can be used in water baths and placed in freezers
- Alphanumeric identification
- Chemically resistant
- Autoclavable

Colour	PK	Cat. No.
Blue, purple, green, red, transparent	5	6.292 162
Blue	5	6.292 163
Purple	5	6.292 164
Green	5	6.292 165
Transparent	5	6.292 166

1. General laboratory consumables

Vessels/Tube racks

1 2 Tube Rack Adapt-a-Rack™, POM



Heathrow Scientific

Capable of holding different size tubes in each available slot as the well literally adapts to your tube size to hold firmly in an upright position. The design enables you to hold 12 to 30 mm (5 to 50 ml) tubes simultaneously and still allow full viewing of the tube label. Racks can be linked together for additional holding capacity. Autoclavable. Dimensions (W x D x H): 181 x 56 x 76 mm



Colour	Array	PK	Cat. No.
Blue/Green	4	2	4.657 434
Blue/Yellow	4	2	4.674 952
Pink/White	4	2	4.674 953
Pink/Pink	4	2	6.287 302
Yellow/Yellow	4	2	6.287 303
Blue/Blue	4	2	9.194 027
Green/Green	4	2	9.194 028
White/White	4	2	9.194 029



3 Microtube Rack, 20-Well, PP



Heathrow Scientific

Interlocking racks with 2 x 10 array hold 0.5/1.0/1.5/2.0ml tubes. Polypropylene racks lock together on each side, permitting the user to attach several together to increase capacity. Features an innovative "hold-it" finger slot on the front, and internal ribbing for stability. Autoclavable. Dimensions: 210 mm x 90 mm x 46 mm.



Colour	PK	Cat. No.
blue	1	9.409 088

4 Microtube racks, PP, 96-Well



Heathrow Scientific

Autoclavable. Polypropylene rack has 96 wells for 0.5 ml microcentrifuge tubes on one side and 96 wells for 1.5 ml to 2.0 ml microcentrifuge tubes on the other side. Wells are arranged in standard 8 x 12 array. Handy lid snaps into place via tabs on each end of rack. Dimensions (L x W x H): 246 x 121 x 50 mm



Colour	PK	Cat. No.
Blue, green, pink, yellow and orange	5	9.193 982
Natural	1	6.237 620
Blue	1	6.237 267
Green	1	6.237 268
Pink	1	6.237 621
Yellow	1	6.237 622

5 6 Tube Rack pop-up™, foldable, PP



Heathrow Scientific

Robust polypropylene construction. Simple, easy to open and close. Flatten for compact storage. Pops up for instant use. Expand and collapse when racks are needed. Printed grid aids rapid retrieval. Stack racks in open or closed position. Saves space when racks are not in use. Not recommended for steam sterilisation. Dimensions (L x W x H): 255 mm x 137 mm x 72 mm when expanded, 21 mm high when collapsed.



For	Colour	PK	Cat. No.
21 x 15 ml and 12 x 50 ml tubes	Pink	2	9.193 997
21 x 15 ml and 12 x 50 ml tubes	Blue	2	9.193 998
45 x 15 ml tubes	Purple	2	6.254 577
18 x 50 ml tubes	Green	2	6.254 578



Vessels/Tube racks

1

1 Tube Rack Rota-Rack®, PP



Heathrow Scientific

Interlocked racks. Rotate each of the four modules independently. Use several sizes of test tubes, culture tubes, centrifuge tubes or microcentrifuge tubes at the same time. Autoclavable.

Each module of the Rota-Rack® for large tubes holds 2 x 50 ml tubes, 6 x 20 mm tubes or 10 x 10/13 mm tubes. Each module of the Rota-Rack® for microtubes holds 6 x 15 ml tubes, 9 x 1.5/2.0 ml tubes, 12 x 0.5 ml tubes or 32 x 0.2 ml PCR tubes or 4 x 8-tube strips.

Description	Width mm	Length mm	Height mm	PK	Cat. No.
Rota-Rack® for large tubes	110	224	110	1	9.193 988
Rota-Rack® for micro tubes	100	210	100	1	9.193 989

2

2 Microtube Storage Boxes, PP, 50-/100-Well



Heathrow Scientific

Autoclavable. Compact storage box has angled front slot for easy access to tubes. Rugged, polypropylene box has durable three-point hinges, snapping clasp for secure closure, moulded grid lines on lid, imprinted coordinates on bottom of base and imprinted and raised coordinates on tube wells. Ideal for sample or case study storage. Holds 1.5 ml to 2.0 ml microtubes. Resist storage temperatures from -80 to +121 °C.

Colour	Dimensions (l x w x h) mm	Array	PK	Cat. No.
blue, green, purple, yellow, orange	141 x 92 x 56	50	5	9.193 985
natural	141 x 92 x 56	50	1	6.243 162
blue, green, purple, yellow, orange	141 x 151 x 57	100	5	9.193 981
natural	141 x 151 x 57	100	1	6.206 710
black	141 x 151 x 57	100	1	6.253 894

3

3 Test tube rack, PP, "monoblock"



ISOLAB

Blue. Manufactured from high density polypropylene. Moulded-in alpha numeric grid reference on the top tier of the rack allows easy sample identification. Due to their weights, they do not float in the water baths. Autoclavable.

For tubes diam. mm	Array	Dimensions (W x D x H) mm	PK	Cat. No.
12 ... 13	50	275 x 160 x 70	1	9.193 141
15 ... 16	50	275 x 160 x 70	1	9.193 142
17 ... 18	50	275 x 160 x 70	1	9.193 143
18 ... 20	45	275 x 160 x 70	1	9.193 144
28 ... 30	26	275 x 160 x 70	1	9.193 145

4

4 Tube rack, PP



ISOLAB

Manufactured from high density polypropylene. Due to their weights, they do not float in the water baths, not even in agitated water. These racks are supplied dismantled and can be easily assembled. Autoclavable. A moulded-in alpha-numeric grid reference on the top tier of the rack allows easy sample identification.

For tubes diam. mm	Array	Dimensions (W x D x H) mm	Colour	PK	Cat. No.
13	84	125 x 265 x 70	blue	1	4.663 315
16	55	125 x 265 x 70	blue	1	4.663 316
18	55	125 x 265 x 70	blue	1	4.678 588
20	40	125 x 265 x 70	blue	1	4.663 317
25	32	125 x 265 x 90	blue	1	4.663 318
30	21	125 x 265 x 90	blue	1	4.663 319

1. General laboratory consumables

Vessels/Tube racks

1 PCR Multirack, PP



ISOLAB

Fully autoclavable. This storage/working rack, with lid, is designed to work with different PCR volumes at the same time. It can accommodate up to 32 individual 0.2 ml PCR tubes, 24 pieces of 1.5/2.0 ml and 16 pieces of 0.5 ml microtubes. Tube wells are alpha-numerically matrixed with raised bold type for accurate sample identification. The rack also has a transparent lid for easy viewing of samples. Frosted writing panels on four sides allow labelling or writing.

Rack dimensions (l x w x h): 210 x 115 x 50 mm.

For tubes	Array	PK	Cat. No.
ml			
0,2 / 0,5 / 1,5 - 2,0	32 / 16 / 24	1	6.255 805



2 Rack for centrifuge tubes, PP



ISOLAB

Suitable to hold 15 ml and 50 ml centrifuge tubes with conical bottom. Just push the tubes into the cavities and leave them. Unique design has an angular end to provide easy stacking for space saving purpose. Moulded in alpha numeric grid reference on the rack allows easy sample identification.

For tubes	Array	Dimensions (W x D x H)	PK	Cat. No.
ml		mm		
15	5 x 5	150 x 120 x 32	1	6.267 412
50	5 x 5	230 x 190 x 35	1	6.267 413



3 Mircotube Rack (1.5ml), PP



Kartell

Two-tier, available in four different colours. These versatile racks are autoclavable and can be used dry, in water baths or in freezers. Each rack has an alpha-numeric reference for easy sample identification. Can accommodate 100 x 1.5 ml tubes with closed caps or without caps, and 50 x 1.5 ml tubes with open caps. Racks are stackable even when loaded and have (purpose) designed label spaces on each side (for bar coding, etc.). Dimensions (l x w x h): 263 x 109.5 x 45 mm

Colour	Array	PK	Cat. No.
blue	100	1	6.225 714
yellow	100	1	6.238 141
white	100	1	6.226 179
red	100	1	6.401 579



Vessels/Tube racks

Tube Rack, epoxy-coated steel

Chemically resistant racks for transport or sample handling.

Heathrow Scientific

Typ A: Rack suitable for low profile tubes up to a diameter of 25 mm or a diameter of 33 mm. Mesh bottom support.

Typ B: Support capped tubes 15 ml up to 20 mm diameter 3x5 format or 50 ml tubes up to 30 mm diameter 2x4 format. Slotted bottom.

Typ C: Holds bottles 250 ml up to 60 mm diameter. Slotted bottom

Type	For tubes diam.	Width	Length	Height	Array	PK	Cat. No.
	mm	mm	mm	mm			
A	25	64	164	32	2 x 6	1	9.194 021
A	25	145	271	32	5 x 10	1	9.194 022
A	33	80	212	60	2 x 6	1	9.194 023
A	33	189	355	60	5 x 10	1	9.194 024 ¹
B	20	76	127	76	3 x 5	1	6.243 203
B	30	80	147	89	2 x 4	1	6.239 754
C	60	135	205	104	2 x 3	1	9.194 025 ²

1



9.194 024

2



9.194 025

LLG-Test tube rack, PP



Made of PP. Stackable. Supplied in three parts and are easy to assemble. Alphanumeric grid referenced on top tier for easy identification of probes. Can be used in water baths. With large lateral marking area. Autoclavable.

For tubes diam.	Colour	Dimensions (W x D x H)	Array	PK	Cat. No.
mm		mm			
16	white	251 x 106 x 71	60	1	6.286 169
16	blue	251 x 106 x 71	60	1	6.286 170 ³
16	red	251 x 106 x 71	60	1	6.286 171
20	white	252 x 108 x 72	40	1	6.286 172 ⁴
20	blue	252 x 108 x 72	40	1	6.286 173
20	red	252 x 108 x 72	40	1	6.286 174
30	white	252 x 107 x 71	21	1	6.286 175
30	blue	252 x 107 x 71	21	1	6.286 176
30	red	252 x 107 x 71	21	1	6.286 177 ⁵

3



6.286 170

4



6.286 172

5



6.286 177

1. General laboratory consumables

Vessels/Tube racks

1 Test tube racks Switch-Grid™, POM



Bel-Art Products

This split-frame rack holds up to two different grid inserts. For 10 to 30 mm diameter test tubes. Dimension frame (W x D x H): 318 x 111 x 67 mm.

- 5 colored coded grid inserts
- Three tier rack
- With rubber feet
- Stackable
- Chemical resistant
- Autoclavable at 121 °C



Type	For diam. mm	Colour	Array	PK	Cat. No.
Rack frame		white		1	4.674 982
Grid insert	10 ... 13	orange	7 x 6	4	4.674 983
Grid insert	13 ... 16	blue	6 x 5	4	4.674 984
Grid insert	16 ... 20	green	5 x 4	4	4.674 985
Grid insert	20 ... 25	fuchsia	4 x 3	4	4.674 986
Grid insert	25 ... 30	yellow	3 x 2	4	4.674 987

2 Test tube rack, PP



BRAND

PP. For all common test tube diameters. Very sturdy design. All openings are widely spaced apart to accommodate screw cap tubes. All racks have the same footprint and can be stacked easily when empty. Modified PP with greater density than water makes them ideal for use in water baths. Large marking area (60 x 12mm) for barcode labels and alphanumeric references for clear sample identification. Racks are supplied in three parts for quick and permanent assembly. Continuous use temperature -20 to +90 °C. Autoclavable at 121 °C (2 bar), according to DIN EN 285. Choice of colours as outlined below.



For tubes diam. mm	Colour	Dimensions (l x w x h) mm	Array	PK	Cat. No.
13	White	265 x 126 x 75	6 x 14	1	9.193 240
13	Blue	265 x 126 x 75	6 x 14	1	9.193 241
13	Red	265 x 126 x 75	6 x 14	1	9.193 242
16	White	265 x 126 x 75	5 x 11	1	9.193 230
16	Blue	265 x 126 x 75	5 x 11	1	9.193 231
16	Red	265 x 126 x 75	5 x 11	1	9.193 232
18	White	265 x 126 x 75	5 x 11	1	9.193 245
18	Blue	265 x 126 x 75	5 x 11	1	9.193 246
18	Red	265 x 126 x 75	5 x 11	1	9.193 247
20	White	265 x 126 x 75	4 x 10	1	9.193 250
20	Blue	265 x 126 x 75	4 x 10	1	9.193 251
20	Red	265 x 126 x 75	4 x 10	1	9.193 252
25	White	265 x 126 x 88	4 x 8	1	9.193 255
25	Blue	265 x 126 x 88	4 x 8	1	9.193 256
25	Red	265 x 126 x 88	4 x 8	1	9.193 257
30	White	265 x 126 x 88	3 x 7	1	9.193 260
30	Blue	265 x 126 x 88	3 x 7	1	9.193 261
30	Red	265 x 126 x 88	3 x 7	1	9.193 262

3 Tube standing and drying racks, PP



Heathrow Scientific

Autoclavable, fiberglass-reinforced polypropylene racks are ideal for bench work or storage of test tubes. Allows easy viewing of tube contents. Does not float in water baths. User can also turn tubes as well as electrophoresis and chromatography plates upside-down and use as a drying rack. The flexible peg design is suitable for tubes with a diameter of 10 mm to 13 mm and 14 mm to 17 mm. Includes embossed indexing and drainage holes.



For tubes	Colour	Width mm	Length mm	Height mm	No. of pegs	PK	Cat. No.
14 ... 17 mm	White	104	188	69	50	1	6.243 212
14 ... 17 mm	Blue	104	188	69	50	1	6.243 213
10 ... 13 mm	White	126	182	69	96	1	6.243 210
10 ... 13 mm	Blue	126	182	69	96	1	6.243 211

Vessels/Tube racks

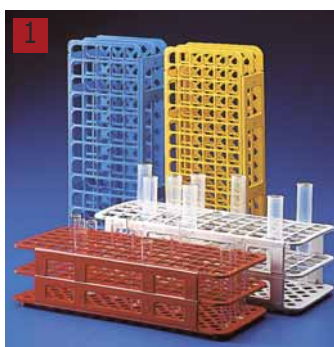

1 Tube racks, PP



Kartell

Will not float. Alphanumeric grid referenced on top tier for easy identification of samples. Stackable when empty. Can be used in freezers or water baths. Autoclavable at 121 °C for 20 min.

For tubes diam.	Colour	Dimensions (l x w x h)	Array	PK	Cat. No.
mm		mm			
13	white	246 x 105 x 64	90	1	6.205 483
13	blue	246 x 105 x 64	90	1	6.224 460
13	yellow	246 x 105 x 64	90	1	6.206 439
13	red	246 x 105 x 64	90	1	9.193 200
16	white	246 x 105 x 72	60	1	6.205 109
16	blue	246 x 105 x 72	60	1	6.206 347
16	yellow	246 x 105 x 72	60	1	6.206 305
16	red	246 x 105 x 72	60	1	6.204 936
20	white	246 x 105 x 72	40	1	6.205 110
20	blue	246 x 105 x 72	40	1	6.206 206
20	yellow	246 x 105 x 72	40	1	6.224 461
20	red	246 x 105 x 72	40	1	9.193 201
25	white	295 x 125 x 85	40	1	6.236 328
25	blue	295 x 125 x 85	40	1	6.236 329
25	yellow	295 x 125 x 85	40	1	6.236 330
25	red	295 x 125 x 85	40	1	9.193 202
30	white	300 x 112 x 85	24	1	6.207 191
30	blue	300 x 112 x 85	24	1	7.632 543
30	red	300 x 112 x 85	24	1	6.401 582
30	yellow	300 x 112 x 85	24	1	6.204 134



2 Test tube racks Nalgene™, acetal plastic



Thermo Scientific

Thermo Scientific™ Nalgene™ Unwire™ test tube racks manufactured with Resmer™ Manufacturing Technology. 3-tier grid design. Will not float. Single moulding, with no sharp edges or corners. Alphanumeric grid referenced on top tier for easy identification of samples. End plates can be labelled or written on. Autoclavable.

For tubes diam.	Colour	Width	Length	Height	Array	PK	Cat. No.
mm		mm	mm	mm			
13	White	102	200	57	6 x 12	1	9.194 513
13	Orange	102	200	57	6 x 12	1	9.194 523
13	Yellow	102	200	57	6 x 12	1	9.194 533
13	Blue	102	200	57	6 x 12	1	9.194 543
13	Green	102	200	57	6 x 12	1	9.194 553
13	Red	102	200	57	6 x 12	1	9.194 563
16	White	127	248	70	6 x 12	1	9.194 514
16	Orange	127	248	70	6 x 12	1	9.194 524
16	Yellow	127	248	70	6 x 12	1	9.194 534
16	Blue	127	248	70	6 x 12	1	9.194 544
16	Green	127	248	70	6 x 12	1	9.194 554
16	Red	127	248	70	6 x 12	1	9.194 564
20	White	102	250	83	4 x 10	1	9.194 515
20	Orange	102	250	83	4 x 10	1	9.194 525
20	Yellow	102	250	83	4 x 10	1	9.194 535
20	Blue	102	250	83	4 x 10	1	9.194 545
20	Green	102	250	83	4 x 10	1	9.194 555
20	Red	102	250	83	4 x 10	1	9.194 565
25	White	121	300	92	4 x 10	1	9.194 516
25	Orange	121	300	92	4 x 10	1	9.194 526
25	Yellow	121	300	92	4 x 10	1	9.194 536
25	Blue	121	300	92	4 x 10	1	9.194 546
25	Green	121	300	92	4 x 10	1	9.194 556
25	Red	121	300	92	4 x 10	1	9.194 566
30	White	108	283	83	3 x 8	1	9.194 517
30	Orange	108	283	83	3 x 8	1	9.194 527
30	Yellow	108	283	83	3 x 8	1	9.194 537
30	Blue	108	283	83	3 x 8	1	9.194 547
30	Green	108	283	83	3 x 8	1	9.194 557
30	Red	108	283	83	3 x 8	1	9.194 567

1. General laboratory consumables

Vessels/Tube racks

1 LLG-Test tube racks, wire/nylon

White nylon-coated wire. Opening size 18 x 18 mm (6.286 416 = 30 x 30 mm)

Length	Width	Height	Array	PK	Cat. No.
mm	mm	mm			
130	54	70	2 x 6	1	6.286 410
248	55	70	2 x 12	1	6.286 411
248	73	70	3 x 12	1	6.286 412
130	95	70	4 x 6	1	6.286 413
248	94	70	4 x 12	1	6.286 414
215	208	70	10 x 10	1	6.286 415
235	85	80	6 x 2	1	6.286 416



2 Test tube racks, wire/nylon

Wire with white nylon coating. 3-tier design , second tier approximately 30 mm high. Opening size 18 x 18 mm. Temperature resistant up to 80 °C max.

Height	Array	PK	Cat. No.
mm			
70	3 x 4	1	6.800 654
70	2 x 6	1	9.193 762
70	2 x 10	1	9.193 764
70	2 x 12	1	9.193 766
70	3 x 12	1	9.193 768
70	4 x 6	1	9.193 772
70	4 x 12	1	9.193 774
70	10 x 10	1	9.193 776
100	2 x 12	1	9.193 784
100	4 x 12	1	9.193 788



3 Test tube racks, stainless steel

Corrosion resistant, stainless steel wire. Electrochemically polished. Opening size 18 x 18 mm. Mesh grid levels are positioned at the top and 30 mm above the base.

Height	Array	PK	Cat. No.
mm			
70	2 x 12	1	9.193 824
70	3 x 12	1	9.193 836
70	4 x 12	1	9.193 848
100	4 x 12	1	9.193 948



4 LLG-Test tube racks, self-aligning, stainless steel

Robust stainless steel (brushed) test tube racks. Due to the special construction the racks align the test tubes automatically so that the tubes are more comfortable to use. Contamination from vessel to vessel is also reduced as the tops of the tubes do not touch. Dishwasher safe, steam autoclavable, suitable for dry heat (200 °C) and water bath. Each rack holds up to 50 test tubes.

For neck diam.	Bore diam.	Dimensions (l x w x h)	PK	Cat. No.
mm	mm	mm		
16	17.5	224 x 120 x 75	1	9.409 014

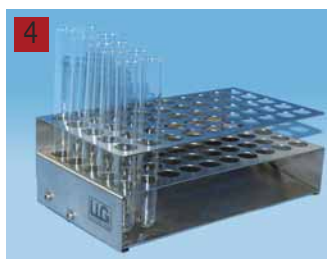

5 Test tube racks, PP



Blue. For tubes up to 18 mm in diameter. Autoclavable and unbreakable. Can be dismantled. Can be recycled.

For tubes diam.	Array	PK	Cat. No.
mm			
18	12	1	9.193 112
18	24	1	9.193 124



Vessels/Tube racks-Containers

1

1 Test tube holders, wood

Wood with metal spring.

For neck diam. mm	PK	Cat. No.
Up to 20	10	9.193 749
Up to 30	10	9.193 750

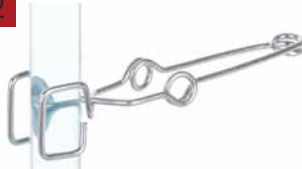
2

2 Tube clamp, plated

Ideal for handling hot tubes or to heat test tubes up to 30 mm diameter. Manufactured from stainless steel with a finger grip. With a long arm for better handling and to avoid close contact between fingers and the flame. High resistance to heat up to 100 °C.

Length mm	PK	Cat. No.
130	1	6.202 530

3

3 LLG-Sample containers, PP, Heavy Duty, with screw cap, HDPE

Ideal for liquid specimen collection, transportation and storage.

- Ideally suited for liquid histological samples
- Container made of non-cytotoxic polypropylene
- Very solid quality
- Top and bottom gripping assures easy opening and closing when wearing gloves
- Half-transparency containers
- With graduation
- With label
- Leak proof

Nominal capacity ml	Grad. up to ml	Ø with Cover mm	Height mm	PK	Cat. No.
20	15	37	42	1000	6.265 649
40	30	50	40	500	6.265 650
60	50	50	58	500	6.265 651
80	70	50	77	300	6.265 652
120	120	58	77	300	6.265 653
160	160	57	100	200	6.282 108
250	150	97	52	154	6.265 654
450	350	97	110	132	6.265 655
900	700	120	138	64	6.265 656
250		63	121	70	6.267 972
900		700	138*	64	6.270 049

* without label.

4

4 LLG-Sample containers, PS, with screw cap, sterile

With PE or /PP screw cap. Ideal for many applications as sample collection, transportation or storage.

- Non-cytotoxic
- EO sterilized
- 30 ml container with conical skirted bottom
- Ideal for small volume samples
- Leakproof-tested
- Unique leak tight cap ensures exceptional leak proof seal
- With plain label

Nominal capacity ml	Ø with Cover mm	Height mm	Material Lid	PK	Cat. No.
7	22	48	PP	700	6.265 646
30	30	90	PP	50	6.265 647
60	43	58	PE	60	6.265 648

5

5 LLG-Sample containers, PS, with metal cap, sterile

Ideal for sample collection and storage. Made of virgin polystyrene. All materials are non-cytotoxic. The metal cap with inert PVC-Liner ensures leak proof seal.

Nominal capacity ml	Ø with Cover mm	Height mm	PK	Cat. No.
60	43	60	300	9.070 321
60	43	60	60	6.261 958
100	49	75	200	9.070 322
100	49	75	40	6.261 959
250	63	121	50	9.070 323
250	63	121	25	6.261 960

1. General laboratory consumables

Vessels/Containers

1 Sample container, 30 ml, Sterilin™, PS, with screw cap, PP

Sample container available with printed, unprinted or without labeling field. With or without sample spoon.

Thermo Scientific

- Screw cap PP with 1/2 turn for one-hand operation
- Aseptically manufactured
- Leak-proof
- Suitable for centrifugation at 3.800 x g

Description	Nominal capacity ml	Ext. diam. mm	Height mm	Labeling	PK	Cat. No.
Universal Container	30	31	94	none	400	6.800 901
Universal Container	30	31	94	printed	400	6.228 981
Universal Container	30	31	94	plain	400	6.265 733
Universal Container with spoon	30	31	94	none	400	6.280 000
Universal Container with spoon	30	31	94	printed	400	6.228 982



2 Scintillation Vials, borosilicate glass

- With white screw caps made of PP
- Liner Material metal foil
- Made of WHEATON 180 low potassium borosilicate glass
- High ultraviolet transmission

DWK Life Sciences

2



Capacity ml	Description	Cap size	Dimensions (dia. x H) mm	PK	Cat. No.
20	caps attached	22-400	28 x 61	500	6.253 024
20	caps attached	22-400	28 x 61	500	6.284 229
20	caps packed separately	22-400	28 x 61	500	6.801 771

3 Scintillation vials, PE

Unbreakable vials compatible with all liquid scintillation counters. Heavy walled to minimize solvent losses. Special PP screw cap to achieve leakproof closure (Cat. Art. 6.204 304). Insert vials, capacity of 4 ml, supplied with screw caps, (Cat. Art. 6.901 743).

Kartell

3



Nominal capacity ml	Ext. diam. mm	Height mm	PK	Cat. No.
20	26.50	60.1	1000	6.204 304
4	13.71	53.6	2000	6.901 743

Vessels/Containers

1

1 LLG-Sample containers, PP, with screw cap, PP

White, with screwed-on lid.

Nominal capacity ml	Ø with Cover mm	Height mm	PK	Cat. No.
30	58	19	10	9.402 310
75	58	47	10	9.402 313
310	81	81	10	9.402 318
600	119	67	10	9.402 321
1250	119	130	5	9.402 324

2

2 LLG-Sample containers, PS/PP, with tamper-evident cap, LDPE/PP

White with tamper-evident cap. Multi-purpose containers e.g. for storage or transport of samples.

Nominal capacity ml	Ø with Cover mm	Height mm	Material	Material Lid	PK	Cat. No.
40	36	52	PS	LDPE	10	9.402 350
100	58	58	PP	PP	10	9.402 353
250	64	95	PS	LDPE	10	9.402 356
1000	116	116	PP	PP	5	9.402 359

3

3 Universal -jars, HDPE with cap, LDPE

HDPE with LDPE cap. Resistant to acids and chemicals. Suitable for cold storage rooms, refrigerators and freezers. Stackable. Food safe. Color: natural.

Nominal capacity ml	Ø with Cover mm	Height mm	PK	Cat. No.
200	98	42	1	9.033 201
400	114	55	1	9.033 202
700	114	88	1	9.033 211
1000	136	110	1	9.033 212
2000	169	143	1	9.033 213

4

4 Jars, PP with PP screw cap

White, complete with red PP screw cap, in safe pack with certificate of analysis.

Nominal capacity ml	Ø with Cover mm	Height mm	PK	Cat. No.
25	34	40	25	7.077 661
60	41	56	25	6.254 446
90	56	52	25	7.077 852
125	56	68	25	7.085 372
250	73	79	20	7.053 933
500	96	90	9	7.052 896
625	96	113	6	7.051 092
1000	112	129	3	7.052 895
1250	112	159	3	7.053 930

1 Containers, PP, with lids



BRAND

Transparent.

Nominal capacity ml	Ø with Cover mm	Height mm	PK	Cat. No.
50	56	25	10	9.402 416
115	75	30	10	9.402 421



2 Jars with screw cap, LaboPlast®, PP



Bürkle

Without residues, free of undercuts, sterilisable, colour: white.

Nominal capacity ml	Ø with Cover mm	Height mm	PK	Cat. No.
12	25	31	1	7.624 042
25	31	40	1	7.631 862
60	41	56	1	6.901 503
90	52	52	1	6.222 886
125	52	67	1	6.802 809
250	68	79	1	6.050 562
625	90	113	1	6.078 446
1000	102	129	1	6.055 461



3 Jars with snap cap, PE



Kartell

Slightly tapered with snap cap attached which snaps tightly closed when pressed. Lightweight and unbreakable. Suitable for foodstuff.

Nominal capacity ml	Ø with Cover mm	Height mm	PK	Cat. No.
1.0	8	32	100	9.401 805
2.5	14	32	1	9.401 820
5.0	15	49	1	9.401 822
7.0	23	33	1	9.401 830
8.0	17	58	1	9.401 825
20.0	25	75	1	9.401 835
25.0	31	53	1	9.401 838
35.0	31	75	1	9.401 840



4 Jars with screw cap, HDPE



Kartell

Heavy walled jar and screw cap with cone liner. Leakproof. Excellent chemical resistance. Suitable for foodstuff.

Nominal capacity ml	Ø with Cover mm	Height mm	PK	Cat. No.
5	21	36	1	9.401 850
10	21	58	1	9.401 851
30	35	53	1	9.401 852
60	35	94	1	9.401 853
90	55	63	1	9.401 854
180	55	110	1	9.401 855



Vessels/Containers

1

1 Multi-purpose jars, PS

Multi-purpose, Polystyrene jar without cap.
Please order cap separately.

Thermo Scientific

Nominal capacity ml	Ext. diam. mm	Height mm	PK	Cat. No.
12.5	27	29	1000	4.008 637
20.0	27	41	2400	4.008 944
30.0	27	60	1200	4.009 104
50.0	41	49	800	4.008 750

2

2 Lids, PE for multi-purpose jars, PS

Thermo Scientific

For jars ml	Sterile	Colour	PK	Cat. No.
12,5 / 20 / 30	-	natural	4000	4.008 824
50	-	grey	2400	4.008 825

3

3 Jars with screw cap Nalgene™, PP

Thermo Scientific

Transparent. Excellent chemical resistance. Autoclavable - undo cap before autoclaving.

Nominal capacity ml	Ø with Cover mm	Height mm	PK	Cat. No.
15	38	46	12	9.033 230
30	43	48	12	9.033 231
60	53	45	12	9.033 232
125	70	74	12	9.033 233
250	70	119	6	9.033 234
500	120	88	6	9.033 235
1000	120	151	6	9.033 236

4

4 Jars with screw cap Nalgene™, PC

Thermo Scientific

Cylindrical. Very durable. Stackable. Non-toxic. Suitable for cold storage rooms and refrigerators.
 Autoclavable - remove cap before autoclaving.

- Excellent for cold room and refrigerated use, easy to see contents
- Wide-mouth and straight sides provide full-access and complete sample retrieval ease
- 15, 30 and 60 mL jars have natural polypropylene closures
- 125 mL to 1 L jars have white polypropylene closures with recessed tops for stacking
- 125 and 250 mL sizes fit Osterizer™ and other blenders that have Mason Jar threads, recommended for use with Fluid Transfer Closure 7.048 079
- Not liquid leakproof, not recommended for liquid transport
- Autoclavable/Transparent

Nominal capacity ml	Ø with Cover mm	Height mm	PK	Cat. No.
15	38	46	4	9.033 237
30	43	48	4	9.033 238
60	53	45	4	9.033 239
125	70	74	4	9.033 240
250	70	119	4	9.033 241
500	120	88	4	9.033 242
1000	120	151	1	9.033 187

1. General laboratory consumables

Vessels/Containers

1 Sample containers, PP with snap on caps, LDPE



VITLAB

Transparent. With LDPE snap-on lid. Conical shape. Food-safe product according to regulation (EU) No. 10/2011.

Nominal capacity ml	Ø with Cover mm	Height mm	PK	Cat. No.
5	20	25	25	9.402 771
18	22	57	25	9.402 777
50	30	97	10	9.402 781
160	50	110	10	9.402 783



Multi-purpose beakers with screw cap, PP

Transparent, with red screw cap. Non-sterile or sterile. Sterile beakers are single packed. Ideal beaker for sampling and storing of solid, muddy and liquid samples.

Ratiolab

Nominal capacity ml	Sterile	Ø with Cover mm	Height mm	Material	PK	Cat. No.
30	-	43	47	PP	1000	9.401 860
30	+	43	47	PP	500	6.287 527
60 *	-	43	66	PP	600	6.260 493
60 *	+	43	66	PP	500	6.258 714
120*	-	63	73	PP	500	6.803 183 2
120*	+	63	73	PP	250	6.093 728
200	+	64	80	PP	150	6.262 099 3
200	-	64	80	PP	200	6.261 429
200	+	64	82	PS	150	9.401 861

*with graduation and labelling area



6.803 183



6.262 099

4 Multi-purpose beakers, PP

Transparent, pressure-resistant and unbreakable sample cup, ideal for collecting and storing samples of all types. Can be ordered with and without screw cap.

Böttger

- Graduated
- Solid and stable
- Writing field on the cup and labeling area on the lid
- Wide opening for easy and safe filling
- Fluid tight sealing screw cap with thread

Description	Nominal capacity ml	PK	Cat. No.
Beaker 125 ml, PP, with screw cap, green, HDPE	125	500	6.238 122
Beaker 125 ml, PP, without screw cap	125	1000	6.237 981



5 Cylindrical jars with ribbed cap, HDPE



NEW
Kartell

The cylindrical jars are supplied with insert and cap. Thanks to the large neck they are suitable for powders, solid specimen, creamy or semisolid substances, crystals and hygroscopic substances. Suitable for foodstuff according to EC Regulation 1935/2004 and EC Regulation 10/2011.

Nominal capacity ml	Ext. diam. mm	Neck i. d. mm	Height mm	PK	Cat. No.
70	50	36	60	10	4.672 397
120	56	36	71	10	4.672 394
250	69	50	94	10	4.672 395
500	86	70	107	10	4.672 396
1000	111	85	128	10	4.672 393
1500	111	87	182	10	9.073 444
2000	111	87	235	10	9.073 446



Vessels/Containers

1

1 Storage jars, series 376, HDPE

Natural round jars without lid. The wide mouth allows for easy filling and cleaning.
Black caps available with PE foam leakproof wad - please order separately.

Kautex

Nominal capacity ml	Ext. diam. mm	Neck i. d. mm	Thread external diam. mm	Height mm	PK	Cat. No.
100	48	31	40	77	1	9.073 388
250	65	41	50	98	1	9.073 389
500	80	53	65	122	1	9.073 390
750	94	53	65	130	1	9.073 391
1000	100	67	80	153	1	9.073 392
1500	114	67	80	173	1	9.073 393
2000	126	67	80	192	1	9.073 394

Height in mm without lid.

2

2 Screw caps, PP, for storage jars, series 376

Black, screw cap with PE-foam insert.

Kautex

For jars ml	Thread external diam. mm	PK	Cat. No.
100	40	1	9.073 071
250	50	1	9.073 072
500 and 750	65	1	9.073 073
1000, 1500 and 2000	80	1	9.073 074

3

3 Wide mouth jars, PET, with screw cap, PP

Transparent with white polypropylene cap. Food-safe.
Round, except 1000 ml and 2000 ml which are square.

behr

Nominal capacity ml	Ext. Ø diam. mm	Cover mm	Height mm	PK	Cat. No.
100	74	69	37	10	9.103 136
250	81	69	72	10	9.103 137
500	88	81	108	10	9.103 138
1000	85	81	174	10	6.242 746
2000	118	100	186	10	9.103 140
2500	140	100	212	10	9.103 148
3000	150	100	212	10	9.103 149

4

4 LLG-Wide-Neck jars, glass

Twist-off jar, wide-neck. Perfect for sample storage. Glass, clear.
Without cap, please order cap separately.

Nominal capacity ml	Ext. diam. mm	Height mm	PK	Cat. No.
106	48	78.0	12	9.070 301
212	63	80.5	12	9.070 302
375	63	120.5	12	9.070 303
720	82	148.0	12	9.070 304
1062	82	176.0	12	9.070 305

5

5 Caps, metal, for LLG-Wide-Neck jars

White. Twist-off screw cap for LLG-Wide-neck jars

For jars ml	PK	Cat. No.
106	12	9.070 306
212 / 375	12	9.070 307
720 / 1062	12	9.070 308

1. General laboratory consumables

Vessels/Baskets

1 LLG-Bottle carriers, wire/nylon

For carrying laboratory bottles.

For bottles	Array	PK	Cat. No.
ml			
1000	6	1	6.286 409
2000	6	1	6.286 408



2 Bottle carriers, wire/PE

Made of PE coated wire.
For carrying laboratory bottles of various sizes.
With base and fixed carrying handle.

For bottles	Array	PK	Cat. No.
ml			
2000	4	1	9.102 204
2000	6	1	9.102 206
2000	8	1	9.102 208
2000	10	1	9.102 210
1000	4	1	9.102 214
1000	6	1	9.102 216
1000	8	1	9.102 218
1000	10	1	9.102 220
250	4	1	9.102 224
250	6	1	9.102 226
250	8	1	9.102 228
250	10	1	9.102 230
250	12	1	9.102 232



3 Bottle carriers, wire/plastic coated

Plastic-coated. Strong wire frame.

For bottles	Array	PK	Cat. No.
ml			
1000	4	1	9.102 321
2500	2	1	9.102 322



4 Bottle carrier, PP



For 6 bottles up to max. diam. 95 mm. Food-safe.

Array	External dimensions (W x D x H) mm	PK	Cat. No.
6	210 x 305 x 310	1	6.076 356

Bürkle



Vessels/Baskets



1 Bottle carrier for 6 bottles, ABS

For safe and convenient transportation of maximum 6 bottles of 250 or 500 ml volume. Specially designed for holding 500 ml wash bottles. Strong light weight construction with ergonomic handle offers both comfort and control. Unique design of the bottle basket offers stackable solution for space saving.

ISOLAB

For bottles	Array	PK	Cat. No.
ml			
250 ... 500	6	1	6.267 361



2 Transport baskets, stainless steel wire

Non-rusting stainless steel, electrochemically polished. With fold down handle that locks into position. Handle with plastic moulding. Made of 8 x 8 x 1.2 mm diameter spot welded wire mesh. Base reinforced with two rods.

External dimensions (W x D x H) mm	PK	Cat. No.
300 x 400 x 200	1	9.143 090



3 Cleaning baskets, stainless steel wire

With cover, made of non-rusting, electrochemically polished, stainless steel wire. For washing hardware. Frame, base and cover made of 8 x 8 x 1.2 mm spot welded wire mesh.

External dimensions (W x D x H) mm	PK	Cat. No.
150 x 250 x 150	1	9.908 130



4 Wire baskets, wire/nylon

White. Nylon coated, strong wire.

External dimensions (W x D x H) mm	PK	Cat. No.
100 x 100 x 100	1	9.033 341
120 x 120 x 120	1	9.033 342
140 x 140 x 140	1	9.033 344
160 x 160 x 160	1	9.033 346
200 x 200 x 200	1	9.033 350



5 Wire baskets, stainless steel

Polished stainless steel wire.

External dimensions (W x D x H) mm	PK	Cat. No.
100 x 100 x 100	1	9.033 410
120 x 120 x 120	1	9.033 412
140 x 140 x 140	1	9.033 414
160 x 160 x 160	1	9.033 416
180 x 180 x 180	1	9.033 418
200 x 200 x 200	1	9.033 420
200 x 300 x 200	1	9.033 430
200 x 400 x 200	1	9.033 440

1 LLG-Dispenserbox, Acrylic Glass

With hinged lid. For storage of laboratory tools, e.g. laboratory goggles, gloves or other small items. Wall mounting possible (mounting material included)

- for about 12 goggles



Description	Dimensions (W x D x H) mm	PK	Cat. No.
LLG-Dispenserbox	216 x 216 x 200	1	6.286 593

2 LLG-Assortment box, PS



Designed for storing and transporting small labwares such as magnetic stirring bars. Manufactured from clear material for easy observation of the contents. Ten compartments of 32 x 50 x 27 mm (W x D x H).

- Suitable for food
 - Temperature resistant from -20 °C up to 70 °C



Width mm	Depth mm	Height mm	PK	Cat. No.
170	105	32	1	6.311 019

3 Display boxes, PS

Polystyrol. Heavy duty, industrial quality. Stackable (lengthways and crosswise). With RAL certificate. Shock-resistant, high impact PS. Food safe colors. Smooth underbody, therefore suitable for transport.



Colour	Width mm	Depth mm	Height mm	Size	PK	Cat. No.
red	100	165	75	2	1	9.033 121
blue	100	165	75	2	1	9.033 123
green	100	165	75	2	1	9.033 124
red	145	232	125	3	1	9.033 131
blue	145	232	125	3	1	9.033 133
green	145	232	125	3	1	9.033 134
red	200	336	150	4	1	9.033 141
blue	200	336	150	4	1	9.033 143
green	200	336	150	4	1	9.033 144

Vessels/Transport boxes

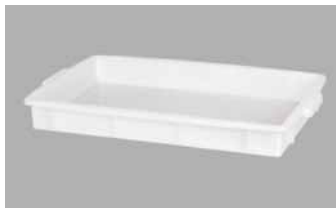
1

1 Storage and transport containers, PP/HDPE

White. Made of thermoplastic resin. Stackable.
The raw material used is physiologically compatible and corresponds with the directives of the Federal Board of Health.

Capacity Litres	External dimensions (W x D x H) mm	Internal dimensions (W x D x H) mm	Material	PK	Cat. No.
9	560 x 360 x 64	510 x 310 x 60	PP	1	9.301 643
10	445 x 345 x 90	410 x 310 x 85	PP	1	9.301 641
23	460 x 330 x 210	395 x 295 x 200	HDPE	1	9.301 663
28	660 x 450 x 130	600 x 400 x 120	HDPE	1	9.301 647
31	550 x 450 x 170	480 x 410 x 160	HDPE	1	9.301 645
35	600 x 350 x 220	530 x 315 x 210	HDPE	1	9.301 661
50	660 x 450 x 220	600 x 400 x 210	HDPE	1	9.301 649
96	660 x 450 x 410	600 x 400 x 400	PP	1	9.301 651

2

2 Lids for stacking and transport containers.

For	Width mm	Length mm	PK	Cat. No.
9.301 647 / 649 / 651	450	660	1	9.301 655
9.301 663	330	460	1	9.301 664

3

3 Storage boxes, HDPE with tightly closing LDPE lid

Suitable for cold storage rooms and refrigerators. Temperature range/withstands temperatures (without mechanical stress) from -20 to +95 °C.
Stackable. Acid and chemical resistant. Food safe. Colour: natural.

Capacity L	Width mm	Depth mm	Height mm	PK	Cat. No.
0.5	103	103	64	1	9.033 270
1.0	103	103	127	1	9.033 275
1.0	103	208	64	1	9.033 280
1.5	103	208	94	1	9.033 285
2.0	103	255	94	1	9.033 286
2.0	208	208	64	1	9.033 287
3.2	208	208	94	1	9.033 288

4

4 Collapsible Box mini, PP, stackable

A straightforward and tough folding mechanism permits a safe and easy handling. Volume 4 liter, weight 180 g, load 2.5 kg. Dishwasher safe, food safe. Autoclavable at 120 °C, enduring temperature stability from -40 °C to 90 °C.

Colour	Width mm	Depth mm	Height mm	PK	Cat. No.
light-grey	238	161	100	1	4.675 426
white	238	161	100	1	9.301 481

5

5 Collapsible Box midi, PP, stackable

A straightforward and tough folding mechanism permits a safe and easy handling. Volume 14.5 liter, weight 300 g, load 8 kg. Dishwasher safe, food safe. Autoclavable at 120 °C, enduring temperature stability from -40 °C to 90 °C.
The Folding Box mini perfectly fits two-times into the Midi.

Colour	Width mm	Depth mm	Height mm	PK	Cat. No.
black	400	300	145	1	9.301 485
white	400	300	145	1	9.301 486

➔ Trolleys please see page 271

1. General laboratory consumables

Vessels/Transport boxes

1 Euronormboxes, PP, stackable

Solid transparent plastic containers, odorless, cold- and heat-resistant, stable against the most acids and alkalis. Dishwasher safe, food safe. Two sizes (40 x 30 cm and 60 x 40 cm) available.

- Corresponding lids please order separately
- Suitable Trolley (Cat. No.: 9.301 502)

Type	Capacity	External dimensions (W x D x H) l mm	Colour	PK	Cat. No.
Euronormbox	20	400 x 300 x 220	transparent	1	9.301 503
Lid	-	400 x 300 x 10	transparent	1	9.301 506
Euronormbox	46	600 x 400 x 220	transparent	1	9.301 504
Euronormbox	66	600 x 400 x 320	transparent	1	9.301 505
Lid	-	600 x 400 x 10	transparent	1	9.301 507
Euronormbox	20	400 x 300 x 220	grey	1	6.283 913
Lid	-	400 x 300 x 10	grey	1	6.283 914

Suitable accessories can be found in our online shop.



2 Euro-boxes, aluminium alloy

- High strength, corrosion resistant aluminium alloy
- Stainless steel hinges
- Cover for protection against dust and water
- Strengthened rim
- Cover clamp straps
- Can be secured with lead seal, padlock or fitted lock
- Stackable
- Impact resistant, blue plastic stacking brackets

Capacity l	External dimensions (W x D x H) mm	Internal dimensions (W x D x H) mm	Weight g	PK	Cat. No.
27	400 x 300 x 340	350 x 250 x 310	3000	1	9.301 356
42	600 x 400 x 250	550 x 350 x 220	4700	1	9.301 357
60	600 x 400 x 340	550 x 350 x 310	4900	1	9.301 358
63	1200 x 300 x 350	1150 x 250 x 220	6300	1	6.258 794
73	600 x 400 x 410	550 x 350 x 380	5200	1	9.301 359
81	800 x 400 x 340	750 x 350 x 310	6100	1	9.301 360
157	800 x 600 x 410	750 x 550 x 380	7500	1	9.301 361
239	800 x 600 x 610	750 x 550 x 580	8900	1	9.301 362

Usable dimensions approx. 30mm less than internal dimensions.

Suitable accessories can be found in our online shop.



Vessels/Buckets



1 LLG-Buckets, PP

White. With lid and temper-evident closure.
For transport, packaging and storage of foodstuffs, building materials and non-corrosive chemicals.
Stability guaranteed when filling up with material up to 80 °C.

Capacity Litres	Diam. mm	Height mm	PK	Cat. No.
1	131	127	1	9.040 030
2	179	133	1	9.040 031
3	198	141	1	9.040 032
5	224	193	1	9.040 033
10	266	265	1	9.040 034
1	131	127	10	6.291 418
2	179	133	10	6.291 419
3	198	141	10	6.291 420
5	224	193	10	6.291 421
10	266	265	10	6.291 422



2 LLG-Buckets, PP

White. Round. With metal handle. Graduated.

Capacity Litres	PK	Cat. No.
10	1	9.040 216



3 Buckets, series 610/615, HDPE

Graduated.
- thick-walled
- very stable
- durable
- litre scale
- laboratory and industrial bucket (white) with plastic coated steel carrying handle
- builder's bucket (grey) with rust-free handle

Kautex

Type 1: with spout
Type 2: without spout



Type	Colour	Capacity Litres	Bottom diam. mm	Top diam. mm	Height mm	PK	Cat. No.
1	white	10	193	280	300	1	9.040 110
1	white	15	235	316	335	1	9.040 115
2	white	10	212	253	279	1	9.040 010
2	grey	10	212	253	279	1	9.040 011



4 Buckets, HDPE, Lids, LDPE



VITLAB

White. Without spout. With division into 1L segments. Stable handle with reinforcement in the middle for comfortable carrying. Food-safe product according to regulation (EU) No. 10/2011.
Tightly closing, transparent LDPE lid - please order separately.

Description	Capacity Litres	Diam. mm	Height mm	PK	Cat. No.
Buckets	5	250	240	1	9.040 006
Buckets	10	290	300	1	9.040 012
Lid	5	-	-	1	9.040 206
Lid	10	-	-	1	9.040 212

1. General laboratory consumables

Vessels/Buckets

1 Buckets with spout, PP



VITLAB

Transparent. With division into 1L segments. With stable handle and spout for easy emptying. Highly resistant to chemicals. Without lid. Food-safe product according to regulation (EU) No. 10/2011.

Capacity Litres	Diam. mm	Height mm	PK	Cat. No.
12	310	330	1	9.040 022
15	310	370	1	9.040 025



2 Transport containers with lid and handle, 18/10 steel

Bochem

Capacity Litres	Diam. mm	Height mm	PK	Cat. No.
1	100	155	1	9.039 921
2	135	170	1	9.039 922
3	160	185	1	9.039 923
5	180	240	1	9.039 925
6	180	280	1	9.039 926
10	225	280	1	9.039 928



3 4 Buckets, 18/10 steel

Graduated. With handle. Lids - Order separately.

RSG

Capacity Litres	Grad. up to ml	Int. diam. top mm	Bottom diam. mm	Height mm	PK	Cat. No.
6	6	250	170	190	1	9.040 325
10	10	280	170	265	1	9.040 330
12	12	310	200	270	1	9.040 332
15	17	330	200	320	1	9.040 335



5 Lids for buckets 18/10 stainless steel

RSG

For buckets	Diam. mm	PK	Cat. No.
6 L	260	1	7.623 893
10 L	280	1	6.901 567
12 L	300	1	7.636 628
15 L	310	1	7.612 465



Vessels/Aspirators and Carboys



1 LLG-Bottles, wide mouth, HDPE

Suitable for food. With carrying handle. Ideal for containing liquids, powders and granules. Very strong and durable quality for extended use over time. With screw cap and additional inner cap for a very tight seal. Screw cap can be attached to the bottle using the integrated loops. The bottles can be used by temperature from -40 °C to +80 °C. Please use only in upright position.

Capacity	Neck Int. diam.	Neck Ext. diam.	Body diam.	Height	Handle	PK	Cat. No.
Litres	mm	mm	mm	mm			
5	84	94	170	350	1	1	9.139 938
10	99	109	210	420	1	1	9.139 939



2 LLG-Aspirator Bottles, narrow neck, HDPE

With carrying handle. Suitable for food. Very strong and durable quality for extended use over time. With gasket in the screw cap for a very tight seal. Screw cap can be attached to the bottle using the integrated loops. With thread of 12 mm depth for use with a 3/4" stopcock. Please order the stopcock separately (Cat. No. 9.139 937). The bottles can be used by temperatures from -40 °C to +80 °C. Please use only in upright position.

Capacity	Neck Int. diam.	Neck Ext. diam.	Body diam.	Height	Handle	PK	Cat. No.
Litres	mm	mm	mm	mm			
5	52	62	160	350	1	1	9.139 929
10	52	62	210	430	1	1	9.139 930
25	84	97	270	570	2	1	9.139 931
50	84	97	350	690	2	1	9.139 932



3 LLG-Aspirator Bottles, narrow neck, HDPE, with stopcock

With carrying handle and 3/4" stopcock. Thread and opening for stopcock provided. Suitable for food. Very strong and durable quality for extended use over time. With gasket in the screw cap for a very tight seal. Screw cap can be attached to the bottle using the integrated loops. The bottles can be used by temperature from -40 °C to +80 °C. Please use only in upright position.

Capacity	Neck Int. diam.	Neck Ext. diam.	Body diam.	Height	Handle	PK	Cat. No.
l	mm	mm	mm	mm			
5	52	62	160	350	1	1	9.139 933
10	52	62	210	430	1	1	9.139 934
25	84	97	270	570	2	1	9.139 935
50	84	97	350	690	2	1	9.139 936



4 Stopcock, 3/4", for LLG-Aspirator bottles

For 9.139 929 - 9.139 932 and 9.139 933 - 9.139 936.

Type	PK	Cat. No.
Tap for aspirator bottles	1	9.139 937

1. General laboratory consumables

Vessels/Aspirators and Carboys

1 Aspirator bottles, HDPE

Natural, narrow-neck storage bottles with or without scale. Storage vessel with drain made of food-safe polyethylene. With UV protection for long life. Resistant to acids and chemicals. Special colour and printing possible. With metal carrying belt. With threaded plug and wide thread 22 mm. With white screw cap Ø 65 mm. With 2 O-rings/seals. Other sizes available on request.

Please order stopcocks and adapter for stopcocks with R 1/2" separately.

Description	Capacity	Ext. diam. mm	Height mm	PK	Cat. No.
	Litres				
Aspirator bottles, without scale	5	167	348	1	9.002 601
Aspirator bottles, without scale	10	210	427	1	9.002 602
Aspirator bottles, without scale	25	275	580	1	9.002 603
Aspirator bottles, with scale	5	167	348	1	9.002 606
Aspirator bottles, with scale	10	210	427	1	9.002 607
Aspirator bottles, with scale	25	275	580	1	9.002 608
Angle valve with sleeve connection 19 mm (3/4")				1	6.253 481
Adapter for stopcocks with R 1/2"				1	6.227 536
Angle valve, straight, with sleeve connection 12 mm (1/2")				1	9.002 670
Angle valve curved, with sleeve connection 12 mm (1/2")				1	9.002 671



4 Aspirator bottles, series 350, HDPE

Food-grade product according to Regulation (EC) No 10/2011. Natural with printed blue graduations (in L) and screwed closure. With or without threaded connection at base. Inside neck diameter 50 mm.

Please order stopcock separately.

Kautex

Capacity Litres	Ext. diam. mm	Height mm	Stopcock connection	Handle	PK	Cat. No.
5	167	330	without	1	1	9.011 009
10	206	427	without	1	1	9.011 010
25	278	580	without	2	1	9.011 025
60	346	823	without	2	1	9.011 060
5	167	330	with	1	1	9.011 069
10	206	427	with	1	1	9.011 071
25	278	580	with	2	1	9.011 072
60	346	823	with	2	1	9.011 076

Height in mm without cap.



5 Accessories for series 350 aspirator bottles



Type	Figure	PK	Cat. No.
Stopcock, blue PE-HD	A	1	9.011 181
Blanking plug with sealing, natural PE-HD	B	1	9.011 170
Stopcock, blue PP	C	1	9.139 997
Reducer, blue for 9.139 997	D	1	9.011 078

Vessels/Aspirators and Carboys



1 2 Aspirator Carboys Nalgene™, Type 2319, 2250, with handle, PP

With 83 mm diameter neck, screw cap and shoulder handles. Graduated. For nutritive media, distilled water or other solutions. Leakproof. Not for use with aggressive substances. Neck also accepts stoppers, 36 mm in height and a top/bottom diameter of 75/62 mm. Autoclavable - for best results, autoclave using a properly vented closure.

Thermo Scientific

Type	Description	Capacity Litres	PK	Cat. No.
2319	with stopcock	10	1	9.002 721
2319	with stopcock	20	1	9.002 722
2319	with stopcock	50	1	9.002 723
2250	without stopcock	10	1	9.011 102
2250	without stopcock	20	1	9.011 103
2250	without stopcock	50	1	9.011 104



3 Aspirator Carboys Nalgene™ with handle

Thermo Scientific

Capacity Litres	Description	PK	Cat. No.
10	Carboy, PP, suitable for vacuum	1	6.510 059
10	Carboy, HDPE, amber	1	7.048 149
10	Carboy, PP	1	9.011 121
20	Carboy, PP, suitable for vacuum	1	6.072 292
20	Carboy, PP, with tube connection	1	6.268 720
20	Carboy, PP, wide-mouth	1	9.011 122



4 Aspirator carboys Nalgene™, Type 2322, PC

Transparent. With PP stopcock. Graduated. Leakproof. Robust. Suitable for use in cold rooms. Autoclavable, before autoclaving, unscrew cap and set on bottle neck.

Thermo Scientific

Type	Capacity Litres	Width mm	Depth mm	Height mm	PK	Cat. No.
2322	9	216	146	362	1	9.139 916
2322	20	318	219	381	1	9.139 917



5 Aspirator carboys Nalgene™, Type 2320, HDPE

With PP stopcock. Graduated. Leakproof. Stable. Rigid. Suitable for use in cold rooms.

Thermo Scientific

Type	Capacity Litres	Width mm	Depth mm	Height mm	PK	Cat. No.
2320	9	216	146	356	1	9.139 918
2320	20	318	219	381	1	9.139 919



6 Stopcocks, quick action Type 6422, 6432, PP or ETFE for Aspirator carboys

Type 6422 PP. Autoclavable. Standard stopcock with quick acting closure. Accepts tubing with an inside diameter of up to 16mm. For tubing with an inside diameter of 6.4 mm to 7.9 mm. HDPE adapter is provided.

Thermo Scientific

Type 6432. Autoclavable. Housing and plugs made of Tefzel® ETFE. For tubing with an inside diameter of 6.4 mm to 7.9 mm. Without adapter.

Type	Material	PK	Cat. No.
6422	PP	1	9.139 925
6432	ETFE	1	9.139 926

Tefzel® is registered trademark of DuPont.

1. General laboratory consumables

Vessels/Aspirators and Carboys

1 Wide-mouth jerrycans, HDPE

HDPE. 88mm filling opening. Offers UV protection. With thread and stopper on the narrow side. Wide thread 22 mm. Food safe. Angle valves for 9.002 670 and 9.002 671, 10 L variant with 18 mm additional spout.

1



Capacity Litres	Width mm	Depth mm	Height mm	PK	Cat. No.
10	154	302	397	1	9.139 975
22	180	370	475	1	9.139 970

2 Angled stopcocks/Angle valve, HDPE

HDPE. With spout attachment 12 mm (1/2") diameter and 22 mm threaded connector. For bottles and wide-mouth carboys. Acid and chemical resistant, pressure resistant up to 1.5 bar. For 9.139 975 and 9.139 970. Food safe.

2



Description	PK	Cat. No.
Angled stopcock, straight	1	9.002 670
Angled stopcock, curved	1	9.002 671

3 4 Space saving jerrycan Flachmann LaboPlast®, PP

Space-saving jerrycan Flachmann LaboPlast®

With its low width the compact jerrycan Flachman is ideal as a space-saving canister. Different liquids can be stored and decanted in a small space. Flachmann can also be stored lying on its side e.g. in a refrigerator. It is very stable due to ribbed structure and thick sides. The compact jerrycan can also be used as a settling canister.

Bürkle

- With or without threaded connector 3/4"
- With tamper-evident cap, PP, blue
- PP, transparent
- Canister without valve autoclavable
- Volume: 5 L and 10 L
- Graduations: 250 ml
- With moulded, indestructible litre graduation

Space-saving Compact set: 1 Flachmann LaboPlast® canister 5 L or 10 L and 1 stopcock Compact (9.140 003)

The Flachmann canister is ideal to store and decant liquids in a small space. The Compact stopcock for canisters and barrels features an impressive compact design, which does not overlap the footprint of the canister and therefore can be stored on its side e.g. within a refrigerator or rack without screwing off the stop-cock.

Space-saving StopCock set: 1 Flachmann LaboPlast® canister 5 L or 10 L with screw neck and 1 stopcock (9.139 997)

Capacity Litres	Description	Dimensions (W x D x H) mm	PK	Cat. No.
5	with screw neck,	65 x 335 x 335	1	9.140 002
5	without screw neck	65 x 335 x 335	1	9.140 001
5	Space-saving Set Compact	65 x 335 x 335	1	9.140 004
5	Space-saving Set StopCock	65 x 335 x 335	1	9.140 011
	Support stand for 2 jerrycans (only for 5 L canister)		1	9.139 999
	Support stand for 3 jerrycans (only for 5 L canister)		1	9.139 996

3



4



1

1 Space-saving jerrycans, HDPE, electrically conductive

For use in explosion-protected areas.

Bürkle

- Black
- Antistatic
- Surface resistance <math>< 10^5 \text{ Ohm}</math>
- With or without threaded connector 3/4"
- Space-saving due to its narrow width
- Grounding by means of antistatic set (available as accessory)
- Electrically conductive stopcock StopCock PA (available as accessory)

Nominal capacity ml	Description	Width mm	PK	Cat. No.
5000	Space-saving jerrycans without threaded connector	65	1	4.665 330
10000	Space-saving jerrycans without threaded connector	125	1	4.665 331
5000	Space-saving jerrycans with threaded connector	65	1	4.665 332
10000	Space-saving jerrycans with threaded connector	125	1	4.665 333
5000	Compact jerrycan set, with StopCock PA	65	1	4.665 322
10000	Compact jerrycan set, with StopCock PA	125	1	4.665 329

2

9.140 003

Stopcocks LaboPlast®

StopCock Siphon

Bürkle

- With rotatable spout, preventing drips
- With tapered spout for bottles with narrow openings from diameter 6 mm to 8 mm
- Fits screw threads with G 3/4"
- Pressure proof to 2 bar at 20 °C (without discharge bracket and grommet)
- Parts in contact with media made of PP, PE and PTFE
- Food safe

StopCock Compact

- Compact design, the short discharge does not protrude over the lower edge of the container
- The specially optimised design of the discharge forms an even stream of liquid with no splashing or spattering
- The Compact stop cock fits all containers with G 3/4" connecting threads
- PP, PE and PTFE are materials that offer outstanding chemical resistance to acids and bases
- Food safe

StopCock PA

- Made of polyamide, electroconductive, can be grounded separately
- Ideally suited for solvents
- Inexpensive alternative to stainless steel stopcocks
- PTFE seal
- Including adapter for 3/4" inner thread made of PA electroconductive
- Fits all containers with 3/4" outer thread and with included adapter, to all 3/4" inner threads

3

9.140 000

Type	PK	Cat. No.
StopCock Siphon	1	9.139 997
StopCock Compact	1	9.140 003
StopCock PA	1	9.140 000

4

4 Aspirator Carboys behroplast®, PE

Polyethylene, with welded stopcock. Food-safe. Leakproof, even after prolonged use.

behr

Capacity Litres	Width mm	Depth mm	Height mm	PK	Cat. No.
5	160	190	240	1	9.140 100
10	190	190	360	1	9.140 101
20	250	280	370	1	9.140 098
25	240	300	450	1	9.140 099
30	260	300	450	1	9.140 102
60	330	390	670	1	9.140 103

1 Jerrycan with integrated spout, HDPE

Jerrycan in stable design made of food safe polyethylene (HDPE)

Hünersdorff

- UV protection for long life
- Especially suitable for drinking water and food
- Space-saving and stackable
- Integrated spout with wide thread
- Fill opening 65mm diameter
- With threaded plug and wide thread 22 mm

Capacity Litres	Width mm	Depth mm	Height mm	PK	Cat. No.
10	350	165	310	1	9.002 611
20	350	165	495	1	9.002 612



2 Industrial jerrycans, HDPE

Jerrycans with capacity of 2 to 30 L.
Please order closures separately.

Kautex

Capacity	Colour	Width	Depth	Height	Weight	Thread external diam.	PK	Cat. No.
L		mm	mm	mm	g	mm		
2.0	natural	145	109	196	110	45	1	9.140 021
2.5	natural	153	115	208	125	45*	1	9.140 022
3.0	natural	153	115	240	140	45*	1	9.140 023
5.0	natural	190	145	251	250	50*	1	9.140 025
6.0	natural	192	145	294	265	45	1	9.140 026
8.0	natural	230	190	270	320	45	1	9.140 027
10.0	natural	230	190	310	450	50*	1	9.140 030
20.0	natural	290	246	385	950	60*	1	9.140 037
30.0	natural	320	284	435	1250	60*	1	9.140 038
20.0	blue	290	246	385	950	60*	1	9.140 032
25.0	blue	290	246	450	1100	60*	1	9.140 031
30.0	blue	320	284	435	1250	60*	1	9.140 033

* With UN approval.



1. General laboratory consumables

Vessels/Wide-mouth bottles

1



1

Laboratory bottles Borosilicate glass 3.3, GL 45, with retrace code

Borosilicate glass 3.3. DIN 168 - 1. EN ISO 4796-1.
With graduations and retrace code, pouring ring, PP screw cap with ISO thread.
Certificates are available on request.

DWK Life Sciences

Capacity	Ext. diam.	Height	PK	Cat. No.
ml	mm	mm		
100	56	100	10	9.072 331
250	70	138	10	9.072 332
500	86	176	10	9.072 334
1000	101	225	10	9.072 335
2000	136	260	10	9.072 336
5000	186	330	1	9.072 337
10000	234	410	1	9.072 338

2



2

3

DURAN® YOUTILITY Laboratory Bottle system GL 45

- Specially shaped gripping zones on both sides of the bottle for easier and safer handling.
- With the new YOUTILITY bottle thread opening or closing the bottle is significantly faster. The thread is fully compatible with DIN GL 45 closures and other accessories.
- The slimmer YOUTILITY bottle shape allows more optimal use of limited space in autoclaves and laboratory refrigerators.
- A pre-defined labelling area is compatible with the dedicated DURAN® self-adhesive YOUTILITY bottle labels.
- Nominal volume is shown at the top of the easy-to-read graduation scale for fast determination of the volumes.
- Glass bottle body is moulded from the tried and tested DURAN® borosilicate 3.3 Type 1 neutral glass. DURAN® glass offers very good chemical resistance and high temperature resistance.
- The YOUTILITY bottle has an integrated Retrace Code to allow full product traceability. The lot specific certificate of conformance is available at: www.duran-group.com.
- Bottles are available in either clear or amber coloured glass. The amber colour meets the requirements of the USP <660> and Eur. Ph. requirements for UV light protection.
- Each DURAN® YOUTILITY bottle is supplied as a complete system, with a pouring ring (cyan polypropylene) and a GL 45 cap (cyan polypropylene).

DWK Life Sciences

3



Capacity	Colour	Ext. diam.	Height	Neck thread	PK	Cat. No.
ml		mm	mm	GL		
125	clear	55	124	45	4	9.071 679
250	clear	66	158	45	4	9.071 678
500	clear	78	193	45	4	9.071 677
1000	clear	93	253	45	4	9.071 676
125	amber	55	124	45	4	9.071 672
250	amber	66	158	45	4	9.071 673
500	amber	78	193	45	4	9.071 674
1000	amber	93	253	45	4	9.071 675

4



9.209 139

Accessories for DURAN® YOUTILITY Laboratory Bottle system

DWK Life Sciences

Description	PK	Cat. No.
Printable labels	1	6.310 674
Spare screw caps, GL 45, cyan, PP, food safe	10	9.209 137
Spare pouring ring, GL 45, cyan, PP	16	9.209 138
Bottle tags, GL 45, 8 colours (2 tags each), silicone	16	9.209 139

We can supply this
**manufacturer's whole
 product range !**



**DURAN
 WHEATON
 KIMBLE**
 Excellence in your hands

1. General laboratory consumables

Vessels/Wide-mouth bottles

Laboratory bottles DURAN®

ISO 4796-1 compliant. Thread acc. to DIN 168-1 and approximate graduations. The ring mark on the shoulder of the 100 ml to the 2000 ml bottles makes the filling height of the nominal capacity visible. The 25 ml bottle has a specially shaped glass rim for pouring (eliminating the need for an additional pouring ring). Neutral glass/Type I glass in compliance with USP/EP and JP. With easy to read scale and large labelling field for easy marking. Highly durable white ceramic. With Retrace code (Batch identification). Certificate available via the Internet. Autoclavable.

1 DURAN® laboratory glass bottle GL 25

Areas of application

- Storing expensive/sensitive media, reference samples etc.
- Packaging bottle for reference samples, stability tests, proficiency tests and deuteration solutions
- Shipping bottle for small sample volumes
- Storing proteins, vitamins, DNA

DWK Life Sciences

Description	Capacity ml	PK	Cat. No.
clear, without cap	10	1	9.072 181
clear, with cap	10	1	9.072 182
amber, without cap	10	1	9.072 183
amber, with cap	10	1	9.072 184
protect laboratory glass bottle, without cap	10	1	9.072 185



2 Laboratory bottles, DURAN®, with retrace code, without screw cap

Please order cap and pouring ring separately.

DWK Life Sciences

Capacity ml	Diam. mm	Height mm	Neck thread GL	PK	Cat. No.
25*	36	70	25	1	9.072 013
50	46	87	32	1	9.072 020
100	56	100	45	1	9.072 011
150**	62	105	45	1	9.071 683
250	70	138	45	1	9.072 012
500	86	176	45	1	9.072 015
750**	95	203	45	1	9.071 684
1000	101	225	45	1	9.072 016
2000	136	260	45	1	9.072 017
3500**	160	295	45	1	9.071 685
5000	182	330	45	1	9.072 018
10000	227	410	45	1	9.072 019
15000	268	445	45	1	7.079 854
20000	288	505	45	1	9.072 014

*With specially shaped glass edge for improved pouring out (so that an additional plastic pouring ring is not required)
 **Acceptance within iso 4796 standard has been requested



3 Laboratory bottles, DURAN®, with retrace code, with screw cap

With blue PP screw cap and pouring ring.

DWK Life Sciences

Capacity ml	Diam. mm	Height with cap mm	Neck thread GL	PK	Cat. No.
25*	36	74	25	1	9.072 003
50	46	91	32	1	9.072 000
100	56	105	45	1	9.072 001
150	62	105	45	1	9.071 680
250	70	143	45	1	9.072 002
500	86	181	45	1	9.072 005
750	95	203	45	1	9.071 681
1000	101	230	45	1	9.072 010
2000	136	265	45	1	9.072 007
3500	160	295	45	1	9.071 682
5000	182	335	45	1	9.072 008
10000	227	415	45	1	9.072 004
15000	268	450	45	1	7.076 312
20000	288	510	45	1	9.072 009

*With specially shaped glass edge for improved pouring out (so that an additional plastic pouring ring is not required).



Vessels/Wide-mouth bottles



1 Laboratory bottles, DURAN® amber, with retrace code

DURAN®. ISO 4796-1, Amber with DIN thread. Neutral glass/Type I glass acc. to USP/EP and JP. Autoclavable. With approximate graduations. A ring-shaped moulding on the shoulder of the 100 to 2000 ml bottles makes the filling height of the nominal capacity visible. The 25 ml bottle has a specially formed rim for pouring (eliminating the need for an additional pouring ring). UV protection up to 500 nm. Unaffected DURAN® properties within the bottle, as colour is applied only to the outer surface. Very uniform, durable and chemically resistant, amber colour due to innovative technology. With Retrace code (Batch identification). Certificate available via the Internet.

DWK Life Sciences

Please order screw cap and pouring ring separately.

Capacity ml	Diam. mm	Height mm	Neck thread GL	PK	Cat. No.
25	36	70	25	1	9.071 979
50	46	87	32	1	9.071 980
100	56	100	45	1	9.071 981
150	62	105	45	1	9.071 686
250	70	138	45	1	9.071 982
500	86	176	45	1	9.071 983
750	95	203	45	1	9.071 687
1000	101	225	45	1	9.071 984
2000	136	260	45	1	9.071 985
3500	160	295	45	1	9.071 688
5000	182	330	45	1	9.071 987
10000	227	410	45	1	9.071 988
15000	268	445	45	1	7.021 486
20000	288	505	45	1	9.071 989



2 Laboratory bottle, DURAN® amber glass, with screw cap and pouring ring made of PP

For the storage and transport of photosensitive substances. With easy-to-read graduation and large labelling field for easy identification. UV protection up to approx. 500 nm wavelength.

DWK Life Sciences

- ISO 4796-1
- USP standard
- Retrace code
- Autoclavable

Capacity ml	Diam. mm	Height mm	Neck thread GL	PK	Cat. No.
25*	36	74	25	1	6.262 931
50	46	91	32	1	7.671 498
100	56	105	45	1	6.262 932
150	62	115	45	1	6.259 100
250	70	143	45	1	9.071 961
500	86	181	45	1	6.259 101
1000	101	230	45	1	6.259 102
2000	136	265	45	1	6.259 797

* With specially shaped glass rim for better pouring, thus an additional pouring ring made of plastic is not necessary.



3 Safety-coated bottles, DURAN®, brown, with retrace code

The coating provides scratch, leak and splinter protection and is ideally suited to both the transport and storage of hazardous media or valuable samples. Service temperature limit of the PU plastic coating: -30 °C to +135 °C.

DWK Life Sciences

- Graduated
- UV protection
- DIN thread
- DIN ISO 4796-1
- Suitable for microwaving
- USP compliant
- Autoclavable

Nominal capacity ml	Ext. diam. mm	Height mm	Neck thread GL	PK	Cat. No.
50	46	87	32	1	4.652 776
100	56	110	45	1	9.071 962
250	70	138	45	1	9.071 964
500	86	176	45	1	4.652 777
1000	101	225	45	1	4.652 779
2000	136	260	45	1	9.071 970
5000	182	330	45	1	6.228 624

1. General laboratory consumables

Vessels/Wide-mouth bottles

1 Safety-coated bottles, DURAN®, with retrace code

Glass laboratory bottles with DIN thread to ISO 4796-1. Safety-coated in plastic (DURAN® Protect). Neutral glass/Type I acc. to USP/EP. With Retrace code (Batch identification). Certificate available via the Internet. Autoclavable.

DWK Life Sciences



DURAN® Protect is a resistant and transparent plastic coating based on a cross-linked co-polymer (polyurethane) applied onto DURAN® 3.3 borosilicate glass. The coating made from PU adheres to the glass surface and fulfils the following functions:

- protects the glass surfaces against mechanical damage (**scratch protection**)
- keeps fragments together in the event of glass breakage (**shatter protection**)
- minimises loss of fluid in the event of glass breakage (**leak and spray protection**)
- absorbs UV rays up to a light wavelength of 380 nm (**light protection**)
- (Cat. No.: 9.071 999) only scratch protection.

Temperature resistance

Do not subject to an open flame or direct heat (e.g. on a laboratory hotplate). The maximum operating temperature sustained is 135°C - continuous use at this temperature (>30 mins.) should be avoided.

DURAN® Protect is suitable for freezing (down to -30 °C) and for use in microwaves.

Please order cap and pouring ring separately.

Capacity	Ext. diam.	Height	Neck thread	PK	Cat. No.
ml	mm	mm	GL		
100	56	100	45	1	9.071 991
150	62	105	45	1	9.071 689
250	70	138	45	1	9.071 992
500	86	176	45	1	9.071 995
750	95	203	45	1	9.071 690
1000	101	225	45	1	9.071 996
2000	136	260	45	1	9.071 997
3500	160	295	45	1	9.071 691
5000	182	330	45	1	9.071 998
10000	227	410	45	1	9.071 999

2 Laboratory bottles Protect DURAN®, with retrace code

Highly transparent. The coating provides scratch, leak and splinter protection and is ideally suited to both the transport and storage of hazardous media or valuable samples. Service temperature limit of the PU plastic coating: -30 °C to +135 °C. With screw cap and pouring ring.

DWK Life Sciences



- Graduated
- UV protection
- DIN thread
- DIN ISO 4796-1
- Suitable for microwaving
- USP compliant
- Autoclavable

Nominal capacity	Ext. diam.	Height	Neck thread	PK	Cat. No.
ml	mm	mm	GL		
100	56	100	45	1	4.652 768
150	62	110	45	1	4.652 769
250	70	138	45	1	4.652 770
500	86	176	45	1	9.071 990
750	95	203	45	1	4.652 771
1000	101	225	45	1	9.071 994
2000	136	260	45	1	9.072 006
3500	160	300	45	1	4.652 772
5000	182	330	45	1	4.652 773
20000 *	289	505	45	1	9.071 993

* without screw cap and pouring ring

➔ Bottle carriers - please see page 49.



Vessels/Wide-mouth bottles



1 Reagent bottles DURAN®, clear/amber, pressure resistant

DURAN® reagent bottles, DIN thread, ISO 4796. Pressure resistance, as a result of amended shape, in the range of -1 up to +1.5 bar (tested by the TÜV in accordance with DIN EN 1595, with GS mark). Neutral/Type 1 glass in accordance with USP/EP.

DWK Life Sciences

With Retrace code (Batch identification). Certificate available via the Internet. Autoclavable.

Please order cap and pouring ring separately.

Colour	Capacity ml	Ext. diam. mm	Height mm	Neck thread GL	PK	Cat. No.
clear	100	56	100	45	1	6.270 531
clear	250	70	138	45	1	9.071 706
clear	500	86	176	45	1	9.071 707
clear	1000	101	225	45	1	9.971 704
amber	250	70	138	45	1	9.071 701
amber	500	86	176	45	1	9.071 702
amber	1000	101	225	45	1	9.971 703



2 Laboratory bottles Premium, DURAN®, with retrace code

DURAN®, ISO 4796-1, DIN ISO 718. Premium laboratory bottle with DIN thread. Highly leak-tight using Premium screw cap. Working temperature from -196 °C up to 260 °C.

DWK Life Sciences

With PTFE coated silicone seal and pouring ring. With additional reverse scale, accuracy ±5 %.

Thermal shock resistance of 160K (tested by the German TÜV and with GS mark). Bottle and screw cap in accordance to USP/EP guidelines (Glass Type I/Neutral glass, screw cap raw material USP Class VI, seal FDA). Screw cap material is similar to PFA and highly resistant against chemicals. The material is free from colourants and therefore no leaching takes place. DMF available upon request. Premium bottle and screw cap fulfil highest requirements of the pharmaceutical, chemical and food industry. With Retrace code (Batch identification). Certificate available via the Internet (available for cap and bottle). Autoclavable.

Capacity ml	Ext. diam. mm	Height* mm	Neck thread GL	PK	Cat. No.
100	56	105	45	1	9.072 155
250	70	143	45	1	9.072 156
500	86	181	45	1	9.072 157
1000	101	230	45	1	9.072 158

*Height mm incl. cap



3 Laboratory bottles Premium, DURAN®, without cap

Laboratory bottles without pouring ring and without cap.

DWK Life Sciences

Capacity ml	Ext. diam. mm	Height mm	Neck thread GL	PK	Cat. No.
100	56	100	45	1	6.256 954



4 LLG-Protective netting, roll

From polyethylene for covering glass containers. Cut to size with scissors. Package contains 5 m roll.

For bottles diam. mm	Description	Colour	PK	Cat. No.
30 - 60	LLG Safety Nets, roll	green	1	6.050 132
50 - 100	LLG Safety Nets, roll	red	1	6.050 133
90 - 200	LLG Safety Nets, roll	yellow	1	6.079 513

1. General laboratory consumables

Vessels/Wide-mouth bottles

1 VITgrip™ lab bottles, PP, GL 45



VITLAB

- Allround lab bottle made of polypropylene, with GL 45 thread and supplied with tamper-evident closure (PP).
- Excellent handling due to innovative design. In contrast to common lab bottles, the slim, waisted shape facilitates the handling of the VITgrip™ to a considerable degree. The molded volume graduations support slip-safety while working with gloves.
 - Leakproof**due to optimized sealing system of the bottle thread and the screw cap with ergonomic design.
 - Easy readability of the volume at all times due to molded, double-sided graduations with high accuracy (±5 %).
 - Smooth pouring of liquids and easy to clean due to hydrophobic material and rounded shape without dirt catching edges.
 - With tamper-evident closure that reliably signals, if the bottle is still sealed.
 - Autoclavable at 121 °C (2 bar) according to DIN EN 285



Very good chemical resistance against most acids, bases and alcoholic solutions. Furthermore, the VITgrip™ lab bottles and the supplied VITLAB® tamper-evident closures are suitable for contact with foodstuffs (according to regulation EU No. 10/2011).

Capacity	Height*	Bottom diam.	PK	Cat. No.
ml	mm	mm		
125	103	54	6	6.270 627
250	149	64	6	6.270 628
500	192	77	6	6.270 629
1000	234	97	6	6.270 630
2000	278	126	1	6.270 631

* Height without screw cap

**The VITgrip™ lab bottles are leakproof (tested with distilled water at room temperature and atmospheric pressure and in combination with the supplied VITLAB® screw closures. Please contact us for the detailed test conditions, if required).

2 Screw caps, PP, GL 45



ISOLAB

For perfect and tight closure of GL 45 screw necked laboratory bottles. Large ridges on the cap outer surface guarantees for increased grip and fast closure. Color coded caps enable fast, easy and practical identification of bottle content.



Colour	PK	Cat. No.
Red	10	6.286 663
Yellow	10	6.286 664
Blue	10	6.286 665
Green	10	6.286 666

3 Screw caps, PP



DWK Life Sciences

PP. DIN thread. With lip seal. Temperature resistant to 140 °C. Only suitable for DURAN® laboratory bottles.



Colour	Neck thread GL	PK	Cat. No.
blue	25	1	9.209 065
blue	32	1	9.209 067
blue	45	1	9.209 069
yellow	45	1	9.072 400
green	45	1	9.072 401
grey	45	1	9.072 402
blue	80	1	9.140 110

Vessels/Wide-mouth bottles

1

1 Pouring rings, PP

DWK Life Sciences



PP. Autoclavable to 140 °C (steam).

Colour	Neck thread GL	PK	Cat. No.
blue	32	10	9.209 082
blue	45	10	9.209 084
green	45	10	9.209 078
yellow	45	10	9.209 079
grey	45	10	9.209 080

2

2 Screw caps, high temperature, PBT

DWK Life Sciences



Red. DIN thread. With PTFE-coated silicone seal. Withstands temperatures up to 180 °C. Autoclavable.

Neck thread GL	PK	Cat. No.
14	10	9.209 015
18	10	9.209 019
25	10	9.209 026
32	10	9.209 033
45	10	9.209 044

3

3 | 4 Gaskets, silicone/PTFE and pouring rings, ETFE

DWK Life Sciences



Pouring rings, ETFE. For screw caps made from PBT. Autoclavable. Thermal resistance: max. 180 °C

Silicone gasket (VMQ), PTFE coated.

For screw caps made from PBT. Autoclavable. Thermal resistance: max. 130 °C (steam), 200 °C (heat)

4

Type	Neck thread GL	Material	PK	Cat. No.
Gasket	14	silicone, PTFE coated	10	9.209 445
Gasket	18	silicone, PTFE coated	10	9.209 446
Gasket	25	silicone, PTFE coated	10	9.209 447
Gasket	32	silicone, PTFE coated	10	9.209 448
Gasket	45	silicone, PTFE coated	10	9.209 449
Pouring ring	32	ETFE	10	9.209 087
Pouring ring	45	ETFE	10	9.209 089

5

6.273 341

Membrane Cap, PP/ PTFE

DWK Life Sciences



Cap from PP, membrane made of PTFE with 0.2 µm pore size. Ideal for autoclaving processes because the membrane permits pressure equalisation and tight sealing, reducing the risk of contamination. Temperature resistant up to 140 °C. Typical applications: storage or transport of gas generating media, autoclaving of media.

6

6.273 369

Neck thread GL	PK	Cat. No.
25	5	4.664 035
32	5	6.273 341 5
45	5	6.273 369 6
80	2	6.291 131

1. General laboratory consumables

Vessels/Wide-mouth bottles

1 Screw caps, High Temperature (HT), PPS



BOLA

With PTFE/silicone seal made of PPS (polyphenylene sulphide). With PTFE/silicone seals having a particularly high level of mechanical resistance, even in temperatures up to +250 °C. The non-slip, knurled outer surface ensures the screw cap can be closed securely and opened easily. The closure incorporates a PTFE-faced silicone seal wad and the substance in the container only comes in contact with PTFE. The silicone wad levels out any unevenness in the container neck.



For thread size GL	PK	Cat. No.
14	1	9.209 070
18	1	9.209 071
25	1	9.209 072
32	1	9.209 073
45	1	9.209 074

2 Screw cap, GL45, with 2 hose connections, PP



DWK Life Sciences

The core moves freely and allows the vessel to be changed without twisting the securely attached tubing.

- For use with elastic, soft tubing of 6 - 9 mm i.d. (Viton®, Tygon®, silicone)
- 2 x polypropylene, curved, hose connections on top and straight connections below
- Autoclavable
- Temperature resistant up to +140 °C
- Dishwasher-proof
- Optional filter top part for sterile pressure equalisation available



Description	PK	Cat. No.
Screw cap, with 2 hose connections	2	9.140 109
Filter top part	1	9.071 692

3 Wide-mouth bottles, soda-lime glass

Clear or amber glass. Round thread neck in accordance with DIN 168.

Please order screw caps separately.

Colour	Capacity ml	Diam. mm	Height mm	Neck thread GL	PK	Cat. No.
clear	30	36.0	68.0	32	126	6.314 706
clear	50	44.0	75.0	32	85	7.960 501
clear	100	50.0	93.0	40	63	7.960 502
clear	125	54.0	98.0	40	80	7.960 503
clear	150	57.0	104.0	45	42	9.072 210
clear	250	70.0	113.0	55	48	7.960 504
clear	500	84.0	154.0	55	20	7.960 505
clear	1000	103.5	180.5	68	18	7.960 506
amber	30	36.0	68.0	32	126	7.960 507
amber	50	44.0	75.0	32	85	7.960 508
amber	100	50.0	92.5	40	56	6.270 392
amber	125	54.0	98.0	40	84	7.960 510
amber	150	57.0	104.0	45	48	9.072 211
amber	250	70.0	113.0	55	30	6.287 780
amber	500	84.0	154.0	55	20	7.960 512
amber	1000	103.5	180.5	68	12	7.960 513



4 Screw caps for wide-mouth bottles, PP/LDPE

Cap PP, seal LDPE

Neck thread GL	Material	PK	Cat. No.
32	PP	1	9.072 164
40	PP	1	9.072 165
55	PP	1	9.072 166
68	PP	1	9.072 167
45	PPN	1	6.272 535



➔ Further Safety caps - please see page 1481.

Vessels/Wide-mouth bottles



1 2 Wide-mouth bottles, clear and amber glass, PTFE-lined screw caps

Clear and amber glass. For storage and transport.
The PTFE-lined screw caps make them ideal for taking samples.

behr



Type	Colour	Capacity ml	Thread diam. mm	PK	Cat. No.
RK 30 GT	clear	30	32	1	4.658 144
RK 50 GT	clear	50	32	1	4.658 145
RK 100 GT	clear	100	40	1	4.658 146
RK 250 GT	clear	250	55	1	9.103 200
RK 500 GT	clear	500	55	1	9.103 201
RK 1000 GT	clear	1000	68	1	9.103 202
RB 30 GT	amber	30	32	1	4.658 141
RB 50 GT	amber	50	32	1	4.658 142
RB 100 GT	amber	100	40	1	4.658 143
RB 250 GT	amber	250	55	1	9.072 325
RB 500 GT	amber	500	55	1	9.072 326
RB 1000 GT	amber	1000	68	1	9.072 327



3 Wide-mouth bottles with GLS 80® neck, DURAN®, clear, with screw cap

Laboratory bottle with GLS 80® wide neck (80 mm diameter), autoclavable and up to 500 °C temperature resistant. Neutral/Type 1 glass acc. to USP/EP.

DWK Life Sciences

With Retrace code (Batch identification). Certificate available via the Internet. The wide neck is ideal for any application with powders or granulates, giving easier filling and emptying. With PP screw cap and pouring ring (autoclavable and temperature resistant up to 140 °C). With improved quick release cap which allows the bottle to be easily opened and closed with a minimum of turns.

Capacity ml	Diam. mm	Height without closure mm	PK	Cat. No.
250	95	105	1	9.071 896
500	101	152	1	9.284 510
1000	101	222	1	9.284 511
2000	136	252	1	9.284 512
3500	160	271	1	9.071 966
5000	182	314	1	9.284 513
10000	227	389	1	9.284 514
20000	288	484	1	9.284 515



4 Wide-mouth bottles GLS 80®, DURAN® amber glass

Temperature-resistant, bottle can be used up to 500 °C (for short periods), screw cap and pouring ring up to +140 °C. Protects light-sensitive media from light wavelengths between 200 nm to 470 nm. Unaffected DURAN® properties within the bottle, as colour is only applied on the outer surface. Very uniform, durable and chemically resistant amber colour due to innovative technology. With 80 mm wide mouth screw thread. Ideal for applications with powders and granules, easy filling and emptying. Neutral glass/Type I glass acc. to USP/EP and JP. With Retrace Code (Batch Identification). Certificate available via the Internet. Autoclavable.

Capacity ml	Diam. mm	Height without closure mm	PK	Cat. No.
250	95	105.5	1	9.071 899
500	101	148.0	1	9.284 516
1000	101	218.0	1	9.284 517
2000	136	248.0	1	9.284 518
3500	160	271.0	1	9.071 968
5000	182	310.0	1	9.284 519
10000	227	385.0	1	9.284 520
20000	288	480.0	1	9.284 521

1. General laboratory consumables

Vessels/Wide-mouth bottles

1 Wide-mouth bottles GLS 80® protect, DURAN®

Laboratory bottle with batch identification (Retrace Code), certificate available via the internet, with GLS80® wide-mouth (o.d. 80 mm). Glass Type I/neutral glass as per USP, EP and JP. Autoclavable. Ideal for any application with powder or granulate, easier filling and emptying. The coating of DURAN® protect is a resistant and transparent plastic coating based on a cross-linked copolymer. Complete with blue quick release closure (PP, integral lip seal) and pouring ring (PP) for drip-free pouring and clean, safe working.

The coating adheres to the surface of the glass and fulfils the following functions:

- protection of the glass surface against mechanical damage (e.g. scratches)
- keeps broken glass in place after breakage and avoids or reduces leakage
- minimises loss of media in case of breakage
- absorption of light up to a wavelength of 380 nm

Temperature resistance:

- autoclavable (< 135 °C)
- can be used in microwaves
- high temperature applications for extended periods (>30 min) and direct heating with a flame not recommended
- freezing down to -30 °C possible

Temperature (max.): 135 °C

Capacity ml	Diam. mm	Height without closure mm	PK	Cat. No.
250	95	105.5	1	9.071 897
500	101	148.0	1	9.284 522
1000	101	218.0	1	9.284 523
2000	136	248.0	1	9.284 524
3500	160	271.0	1	9.071 969
5000	182	310.0	1	9.284 525



2 Baffled Wide-mouth bottles, GLS 80®, DURAN®, with screw cap

Baffled Wide-mouth bottle with three vertical baffles in the inner surface of the GLS 80® bottles which disrupt a swirling motion. The baffles improve the top-to-bottom circulation and produce a greater radial mixing. The baffles also offer other advantages such as suppressing the formation of a central vortex, and reducing dead-zones where mixing does not occur.

DWK Life Sciences

- Compatible with both the DURAN® GLS 80® magnetic stirrers, and other magnetic stir bars
- Manufactured from DURAN® borosilicate 3.3 glass
- Fully autoclavable
- The wide 65 mm inner diameter of the GLS 80® wide mouth provides easy access to the contents, or for cleaning
- The baffles are moulded into the glass side wall of the bottles and form a continuous, smooth inner surface making clean up easy
- Compatible with full range of wide mouth GLS 80® connection cap systems for liquid addition or removal when mixing with stir bars.
- The bottles feature an easy-to-read graduated volume scale
- With pouring ring

Applications

- Aerating
- Dissolving
- Emulsifying
- Homogenizing
- Mixing
- Suspending

Capacity ml	Diam. mm	Height mm	PK	Cat. No.
250	95	105	1	6.270 534
500	101	152	1	6.270 535
1000	101	222	1	6.270 536



Vessels/Wide-mouth bottles



1 Double-walled wide-mouth bottles GLS 80®, DURAN®

The DURAN® double-walled wide-mouth bottles GLS 80® incorporate an integral jacket that isolates the contents from the external environment. Heated or cooled liquids can be circulated through the jacket to control the temperature within the screw topped DURAN® bottle.

Applications

- Simple, low cost, jacketed chemostat or bioreactor for cell culture.
- Vessel for temperature-controlled reactions such as enzyme digestions.
- Simple continuous flow stirred reactor system with the optional GLS 80® cap components.
- Thermostatic vessel to maintain fluids, or high viscosity liquids at a constant temperature, useful when working with endo- or exothermic reactions.
- Large cold trap or condenser when used with dry ice in the inner container.

Features

- Usable temperature range of - 40 to + 120 °C.
- Manufactured from DURAN® borosilicate 3.3 glass.
- All components are fully autoclavable.
- Available in two sizes: 500 and 1000 ml.
- Compatible with full range of wide mouth GLS 80® connection cap systems for liquid addition or removal during processing.

Capacity	Diam.	Height without closure	PK	Cat. No.
ml	mm	mm		
500	110	170	1	6.266 805
1000	110	270	1	6.266 806



2 Accessories for Wide-mouth bottles GLS 80®, PP

DWK Life Sciences



Temperature resistant up to 140 °C. Autoclavable.

Description	Diam. mm	Height mm	PK	Cat. No.
Screw cap	87	40.0	1	9.140 110
Pouring ring, blue	77	6.8	1	9.284 530



3 Quick release closure, PSU compound, for GLS 80® laboratory bottles

DWK Life Sciences



The GLS 80® quick release thread allows opening and closing of bottles with three-quarters of a turn. This closure contains dyestuffs. There is a lower risk of contamination due to the double-sided PTFE-coated silicone seal. The medium only comes in contact with PTFE. The matching pouring ring made of PTFE allows clean, drip-free working. Please order separately.

- Good mechanical stability
- High chemical resistance
- Autoclavable/suitable for hot-air sterilisation
- Tmax: 180 °C

Description	Diam. mm	Height mm	PK	Cat. No.
Screw cap	88.5	40.00	1	7.651 746
Pouring ring		6.85	1	6.237 901
Replacement cap liner, on both sides PTFE coated			1	6.253 984

Further accessories can be found in our online shop.

1. General laboratory consumables

Vessels/Wide-mouth bottles

1 Connection system for wide-mouth bottles GLS 80®



DWK Life Sciences

Materials used PP, PBT and PTFE. Flexible modular system. Five different hose diameters (3.2 mm, 6.0 mm, 8.0 mm, 10.0 mm and 12.0 mm) can be connected. Sterile pressure equalisation is possible through use of membrane filter. Unused ports can be provided with a blind cap. Typical applications: safe transfer of liquid media within a closed and sterile system (evaporation is reduced). Autoclavable - maximum temperature 140 °C.



Description	Neck thread GL	PK	Cat. No.
Insert for screw cap, inner diam. 3.2 mm	18	1	9.284 533
Insert for screw cap, inner diam. 6.0 mm	18	1	9.284 534
Insert for screw cap, inner diam. 8.0 mm	18	1	9.284 535
Insert for screw cap, inner diam. 10.0 mm	18	1	9.284 536
Insert for screw cap, inner diam. 12.0 mm	18	1	9.284 537
Screw cap for tube connection, blue	18	1	9.284 538
Pressure equalization for 4-port	18	1	9.284 539
Screw cap, red	18	1	9.284 540

➔ Safety Caps - please see page 1479.

2 Wide-mouth reagent bottles with stopper, soda-lime glass

Soda-lime glass. To ISO 4796-2. Standard ground joint neck. With glass stopper. Hydrolytic class 3.

DWK Life Sciences

Colour	Capacity	Diam. mm	Height mm	Neck	PK	Cat. No.
	ml			NS		
clear	50	44	79	24/20	1	9.071 405
clear	100	52	97	29/22	1	9.071 408
clear	250	71	129	34/24	1	9.071 414
clear	500	86	164	45/40	1	9.071 419
clear	1000	107	200	60/46	1	9.071 424
amber	100	52	97	29/22	1	9.071 508
amber	250	71	129	34/24	1	9.071 514
amber	500	86	164	45/27	1	9.071 519
amber	1000	107	200	60/46	1	9.071 524



3 Wide-mouth reagent bottles with stopper, DURAN®

DURAN®. ISO 4796-2. With standard ground joint as outlined below. With glass stoppers. Glass Type I/neutral glass as per USP, EP and JP. With Retrace Code (Batch Identification). Certificate available via the Internet. Autoclavable.

DWK Life Sciences

Colour	Capacity	Diam. mm	Height mm	Neck	PK	Cat. No.
	ml			NS		
clear	50	44	79	24/20	1	9.071 817
clear	100	52	97	29/22	1	9.071 824
clear	250	70	133	34/35	1	9.071 836
clear	500	86	163	45/40	1	9.071 844
clear	1000	107	201	60/46	1	9.071 854
clear	2000	133	247	60/46	1	9.071 863
amber	50	44	79	24/20	1	9.071 917
amber	100	52	97	29/22	1	9.071 924
amber	250	70	133	34/35	1	9.071 936
amber	500	86	163	45/40	1	9.071 944
amber	1000	107	201	60/46	1	9.071 954
amber	2000	133	247	60/46	1	9.071 963



4 LLG-Wide-mouth bottles, with screw cap, LDPE

Natural, translucent. Thick-walled. Ideal for taking, storing and transporting samples of liquids, pastes and granulated products.

Capacity ml	Diam. mm	Thread external diam. mm	Height mm	PK	Cat. No.
50	39	32	76.0	50	9.073 510
100	48	32	93.5	20	9.073 511
250	64	40	120.0	10	9.073 512
500	77	50	154.0	10	9.073 513
1000	95	65	205.0	4	9.073 514
1500	108	65	226.0	4	9.073 515
2000	120	65	247.0	1	9.073 516



Vessels/Wide-mouth bottles

1

1 Wide-mouth bottles, PE, graduated

NEW

Kartell



Will withstand considerable pressure before rupturing. Secured by tagging points on bottle and PP cap. Confidential notes can be placed in the space between insert sealing plug and cap. Suitable for foodstuff according to EC Regulation 1935/2004 and EC Regulation 10/2011.

Capacity	Grad.	Ext. diam.	Int. diam.	Height	PK	Cat. No.
ml	ml	mm	mm	mm		
50	10	40	24.0	77	10	4.672 391
100	20	48	24.0	89	10	4.672 387
250	25	61	34.5	126	10	4.672 390
500	50	75	34.5	158	10	4.672 392
1000	100	93	45.0	200	10	4.672 388
2000	100	115	45.0	247	10	4.672 389

2

2 Bottles, wide-mouth, PE, graduated

Kartell



PE. General purpose bottle meeting Food and Drug regulations with pictograms. Wide neck for easy filling and emptying of liquid or powder samples. Conform to DIN 13316 and 168. With PE closure. Deep seal ensures leakproof closure. Food-safe.

Capacity	Grad.	Ext. diam.	Tubing i.d.	Height	DIN	PK	Cat. No.
ml	ml	mm	mm	mm			
50	10	38	24	88	32	1	9.072 974
100	20	48	24	105	32	1	9.072 975
250	25	60	38	140	45	1	9.072 976
500	100	75	38	170	45	1	9.072 977
1000	100	95	55	206	63	1	9.072 978
2000	100	120	55	252	63	1	9.072 979

3

3 Graduated wide-mouth bottles

Kartell



PP, meeting Food and Drug regulations with pictograms. Very sturdy, rupture-proof bottles. Wide mouth for easy filling and emptying of liquid or powder samples. Conforms to DIN 13316 and 168. With PP closure. Deep seals ensure leakproof closure. Autoclavable. Remove lid before autoclaving.

Capacity	Grad.	Ext. diam.	Tubing i.d.	Height	DIN	PK	Cat. No.
ml	ml	mm	mm	mm			
50	10	38	24	88	32	1	9.073 030
100	20	48	24	105	32	1	9.073 031
250	25	60	38	140	45	1	9.073 032
500	100	75	38	170	45	1	9.073 033
1000	100	95	55	206	63	1	9.073 034
2000	100	120	55	252	63	1	9.073 035

4

4 Wide-mouth bottles, series 303, LDPE

Kautex

Natural, translucent. Thick-walled. Ideal for taking, storing and transporting samples of liquids, pastes and granulated products.

Please order closure separately.

Capacity	Diam.	Thread external diam.	Height	PK	Cat. No.
ml	mm	mm	mm		
50	39.0	32	76.0	1	9.072 981
100	48.0	32	93.5	1	9.072 982
200	59.0	40	114.0	1	9.072 983
250	64.0	40	120.0	1	9.072 984
300	67.5	40	128.0	1	9.072 985
500	77.0	50	154.0	1	9.072 986
750	88.0	50	173.0	1	9.072 987
1000	95.0	65	205.0	1	9.072 988
1500	108.0	65	226.0	1	9.072 989
2000	120.0	65	247.0	1	9.072 990

Height in mm without cap.

1. General laboratory consumables

Vessels/Wide-mouth bottles

1 Caps for wide-mouth bottles, LDPE

Kautex

For bottles	For Thread o.d. mm	PK	Cat. No.
50/100	32	1	6.291 537
200/250/300	40	1	6.291 538
500/750	50	1	6.291 539
1000/1500/2000	65	1	6.291 540



2 Wide-mouth bottles, series 303, PP

Kautex



Round, Natural without closure. With approximate graduations. Ideal for liquids, pastes and granulates. For taking samples, sending specimens and as transport containers. Can be filled with hot substances. Autoclavable to max. 121 °C. **With screw closure.**

Note: Before autoclaving, unscrew closure and set lightly upside down on the container. Do not screw the closure down.

Capacity	Diam.	Thread external diam.	Height without closure	PK	Cat. No.
ml	mm	mm	mm		
100	48.5	32	94	1	6.287 813
250	64.5	40	121	1	6.287 814
500	77.5	50	155	1	6.287 815
1000	96.0	65	205	1	6.287 816



3 Wide-mouth bottles, series 303, HDPE

Kautex

Brown, offers protection against UV rays for light sensitive liquids. These wide-mouth bottles are easy to fill and clean. Leakproof.

Please order closure separately.

Capacity	Thread external diam.	Height	PK	Cat. No.
ml	mm	mm		
50	32	76.0	1	9.073 681
100	32	93.5	1	9.073 682
250	40	120.0	1	9.073 684
500	50	154.0	1	9.073 686
1000	65	205.0	1	9.073 688

Height in mm without closure.



4 Caps, series 303, HDPE

Kautex

Brown, screw caps.

For bottles	For Thread o.d. mm	PK	Cat. No.
50, 100	32	1	9.073 778
250	40	1	9.073 779
500	50	1	9.073 781
1000	65	1	9.073 782



5 Wide-mouth bottles, with closure, 357 series, HDPE

Kautex

Multi-sided (octagonal), natural HDPE, with screw closure. With an extra-large neck opening, this container is ideal for disposal, storage, collection, transport, waste and sampling of dry substances.

Capacity	Diam.	Neck diam.	Thread external diam.	Height	PK	Cat. No.
Litres	mm	mm	mm	mm		
5	190 x 180	108	120	230	1	9.073 036
10	230 x 222	108	120	303	1	9.073 042



Vessels/Wide-mouth bottles



1 Wide-Mouth Bottles Nalgene™, HDPE with screw cap, PP

Durable, general-purpose bottles with countless applications in the lab or field. Translucent. Wide mouth is easy to fill with dry materials or liquids. Excellent chemical resistance to most acids, bases and alcohols. Can be used in freezer - use to -100 °C. Suitable for shipping liquids. Leakproof with PP screw cap.

Thermo Scientific

Capacity ml	Cover type mm	PK	Cat. No.
30	28	12	9.103 221
60	28	12	9.103 222
125	38	12	9.103 223
250	43	12	9.103 224
500	53	12	9.103 225
1000	63	6	9.103 226
1500	63	6	9.103 227



2 Wide-mouth bottle Nalgene™ Economy, HDPE, with screw cap, PP

Economical, ruggedly constructed bottle. Guaranteed leakproof for safe sampling, shipping and storage. Translucent bottle allows viewing of liquid level. EPA-specified sample bottle material for a wide variety of inorganic compound and elemental analyses.

Thermo Scientific

Capacity ml	Cover type mm	PK	Cat. No.
30	28	72	9.103 228
60	28	72	9.103 229
125	38	72	9.103 230
250	43	72	9.103 231
500	53	48	9.103 232
1000	63	24	9.103 233



3 Wide-mouth bottle Nalgene™ Economy, HDPE, with screw cap, PP, brown

Protects light sensitive samples from UV/VIS light transmission during sampling, shipping or storage. Wide mouth allows easy retrieval of grab samples and reduces turbulence when filling. Single-use sample bottle. Leakproof.

Thermo Scientific

Capacity ml	Cover type mm	PK	Cat. No.
30	28	72	9.103 234
60	28	72	9.103 235
125	38	72	9.103 236
250	43	72	9.103 237
500	53	48	9.103 238
1000	63	24	9.103 239



4 Wide-mouth bottles Nalgene™, PPCO, with screw cap, PP



Rigid wall. For general laboratory use.

- Transparent
- Autoclavable (cap should be unscrewed before autoclaving)
- Leakproof
- Withstands temperatures up to +121 °C

Thermo Scientific

Capacity ml	Cover type mm	PK	Cat. No.
30	28	12	9.103 248
60	28	12	9.103 249
125	38	12	9.103 250
250	43	12	9.103 251
500	53	12	9.103 252
1000	63	6	9.103 253

1. General laboratory consumables

Vessels/Wide-mouth bottles-Wide-mouth kegs

1 Heavy-duty vacuum bottles, PP, with screw cap, PP



Thermo Scientific

With white PP screw cap and TPE gaskets. Most durable Nalgene-bottle. Large, thick-walled bottle with wide mouth for extra-rugged service. Withstand application of full vacuum for 24 hours at 20 °C. Leakproof. Autoclavable.

Capacity ml	Cover type mm	PK	Cat. No.
250	53B	1	6.510 510
1000	53B	1	7.048 062
2000	53B	1	7.048 063
4000	83B	1	7.048 064
5000	83B	1	7.048 065



➔ Suction pumps - please see page 1352.

2 Wide-mouth bottle Nalgene™ Economy, PPCO, with screw cap, PP



Thermo Scientific

General-purpose, single-use sample bottle. Leakproof. Autoclavable.

Capacity ml	Cover type mm	PK	Cat. No.
30	28	72	9.103 254
60	28	72	9.103 255
125	38	72	9.103 256
250	43	72	9.103 257
500	53	48	9.103 258
1000	63	24	9.103 259



3 Medium neck bottles, series 307, HDPE with screw cap, PP

With graduations. Leakproof screw cap. Multi-purpose bottles for universal use in the laboratory and in industry. Offers a good level of chemical resistance. Generous neck diameters offer easy filling and cleaning. Ideal for pastes, granulates and withstands heat filling.

Kautex

Capacity ml	Thread external diam. mm	Height mm	PK	Cat. No.
100	25	99.5	1	9.073 344
250	28	129.5	1	9.073 345
500	40	161.0	1	9.073 346
1000	50	203.0	1	9.073 347

Height in mm without closure.



4 5 Kegs, wide mouth, HDPE, with UN-approval

White, with red lid. UN-approved for Packaging groups I, II and III. Product must have cooled down to 30 °C before the barrel is closed and stacked. All barrels can be sealed airtight, watertight and water-vapour tight.

- Suitable for use with foodstuffs
- Sealable
- Max. filling temperature of 80 °C

Capacity L	Diam. Neck mm	Height mm	Handle	PK	Cat. No.
3.6	198 Ø 136 mm	175	without	1	9.050 020
6.4	198 Ø 136 mm	266	without	1	9.050 021
10.4	274 Ø 204 mm	239	without	1	9.050 019
15.4	274 Ø 204 mm	328	without	1	9.050 022
20.0	274 Ø 204 mm	418	without	1	9.050 018
26.4	316 Ø 204 mm	424	without	1	9.050 023
54.0	410 Ø 282 mm	518	with	1	6.900 353
68.5	410 Ø 282 mm	632	with	1	6.401 093



Vessels/Narrow-mouth bottles



1 Narrow-mouth Winchester bottles, soda-lime glass

Amber, with PP (Pilferproof) 28 neck finish.

Please order caps separately.

Capacity ml	Colour	Diam. mm	Height mm	PK	Cat. No.
30	amber	33.9	69	100	9.070 199
50	amber	40.5	81	99	9.070 201
100	amber	50.5	96	56	9.070 202
250	amber	65.0	133	39	9.070 203
500	amber	82.0	160	20	9.070 205
1000	amber	100.5	207	14	9.070 204



2 Screw caps for narrow-mouth bottles, PP 28

PP Cap (Pilferproof) 28 neck finish, with approx. 19.4 mm inner mouth.

Description	PK	Cat. No.
Screw caps, black, with foam insert	500	6.272 536
Screw caps, white with cone sealing	500	6.272 537
Closure, white, with pouring ring	500	9.070 211
Originality closure, white, with foam insert	500	9.070 213



3 Narrow-mouth bottles, soda-lime glass

Amber or Clear, to DIN 5090. Standard packaging bottles. Round thread neck in accordance with DIN 168.

Please order caps separately.

Colour	Capacity ml	Diam. mm	Height mm	Neck thread GL	PK	Cat. No.
clear	30	34.0	74.0	18	168	6.287 781
clear	50	36.5	97.0	18	105	6.287 782
clear	100	45.0	117.0	22	72	6.287 783
clear	250	61.5	148.5	22	42	6.287 784
clear	500	76.0	176.5	25	35	6.287 785
clear	1000	96.5	225.0	28	20	6.287 786
amber glass	30	34.0	74.0	18	112	6.287 787
amber glass	50	36.5	97.0	18	84	6.287 788
amber glass	100	45.0	117.0	22	56	6.287 789
amber glass	250	61.5	148.5	22	42	6.287 790
amber glass	500	76.0	176.5	25	35	6.287 792
amber glass	1000	96.5	225.0	28	20	6.287 791



4 Screw caps for narrow-mouth bottles, PP/LDPE

PP cap with LDPE seal.

Neck thread GL	PK	Cat. No.
18	1	9.072 160
22	1	9.072 161
25	1	9.072 162
28	1	9.072 163



5 Dispenser/bottle-top flasks, amber soda-lime glass

Available ethylene-acrylate-coated or uncoated. The coating envelops the glass bottle like a protection skin. Should the bottle break, the splintering hazards are reduced considerably. To preserve the coating, do not clean at temperatures exceeding 60 °C.

BRAND

- PP screw cap
- LDPE pouring ring
- Space-saving square design
- The maximum operating temperature for coated bottles is 80 °C

Type	Nominal capacity ml	Width mm	Height mm	Neck thread GL	PK	Cat. No.
Ethylene-acrylate coated	100	50	125	32	1	6.073 469
Ethylene-acrylate coated	250	65	160	32	1	6.701 658
Ethylene-acrylate coated	500	80	195	32	1	6.701 659
Ethylene-acrylate coated	1000	95	230	45	1	7.604 011
Ethylene-acrylate coated	2500*	140	300	45	1	7.510 519
Uncoated	100	50	125	32	1	9.284 541
Uncoated	250	65	160	32	1	9.284 542
Uncoated	500	80	195	32	1	9.284 543
Uncoated	1000	95	230	45	1	9.284 544
Uncoated	2500*	140	300	45	1	9.284 545

* Cylindrical design

1. General laboratory consumables

Vessels/Narrow-mouth bottles

1 Narrow-mouth reagent bottles with stopper, soda-lime glass

Amber or Clear. Soda-lime glass. ISO 4796-2. With glass stopper. Hydrolytic class 3. Standard ground joint neck.

DWK Life Sciences

Colour	Capacity	Diam.	Height	Neck	PK	Cat. No.
	ml	mm	mm	NS		
clear	100	52	96	14/15	1	9.070 408
clear	250	72	130	19/26	1	9.070 414
clear	500	89	165	24/29	1	9.070 419
clear	1000	110	200	29/32	1	9.070 424
amber	50	42	80	14/15	1	9.070 505
amber	100	52	96	14/15	1	9.070 508
amber	250	72	130	19/26	1	9.070 514
amber	500	89	165	24/29	1	9.070 519
amber	1000	110	200	29/32	1	9.070 524



2 Narrow-mouth reagent bottles with stopper, DURAN®

Amber or Clear. DURAN®. ISO 4796-2. With conical ground joint and glass stopper. Glass Type I/neutral glass as per USP, EP and JP. With Retrace code (Batch identification). Certificate available via the Internet. Autoclavable.

DWK Life Sciences

Colour	Capacity	Diam.	Height	Neck	PK	Cat. No.
	ml	mm	mm	NS		
clear	25	36	64	12/21	1	9.070 814
clear	50	42	80	14/15	1	9.070 817
clear	100	52	96	14/15	1	9.070 824
clear	250	70	130	19/26	1	9.070 836
clear	500	86	164	24/29	1	9.070 844
clear	1000	107	200	29/32	1	9.070 854
clear	2000	134	248	29/32	1	9.070 863
clear	5000	182	323	45/40	1	9.070 873
clear	10000	227	398	60/46	1	9.070 886
amber	50	42	80	14/15	1	9.070 917
amber	100	52	96	14/15	1	9.070 924
amber	250	70	130	19/26	1	9.070 936
amber	500	86	164	24/29	1	9.070 944
amber	1000	107	200	29/32	1	9.070 954
amber	2000	134	248	29/32	1	9.070 963



3 Kipp dispenser heads, DURAN® tubing

Made of DURAN® tubing. Dispenser heads for kipp dispensers, with cone NS 29/32

Lenz

Description	PK	Cat. No.
Dispenser head for Kipp dispenser 5 ml	1	9.277 105
Dispenser head for Kipp dispenser 10 ml	1	9.277 110
Dispenser head for Kipp dispenser 20 ml	1	9.277 120
Dispenser head for Kipp dispenser 25 ml	1	9.277 125
Dispenser head for Kipp dispenser 50 ml	1	9.277 150
Reservoir bottle for dispenser heads	1	6.224 318



➔ More bottles please see page 62



Vessels/Narrow-mouth bottles

1 LLG-Narrow-mouth bottles with cap, LDPE, economy pack

Transparent with cap.



Capacity	Diam.	Thread external diam.	Height	PK	Cat. No.
ml	mm	mm	mm		
50	37	18	78	50	9.073 500
100	47	18	105	20	9.073 501
250	63	25	119	10	9.073 502
500	78	25	152	10	9.073 503
1000	96	28	206	4	9.073 504
2000	120	28	264	1	9.073 505

2 Narrow-mouth bottles, series 301, LDPE

Natural. Round bottle without closure. Tall, narrow form, leakproof. Easy to handle. Also available with dropper cap or spray cap.

Kautex

Please order cap separately.

Capacity	Diam.	Thread external diam.	Height	PK	Cat. No.
ml	mm	mm	mm		
10	26.0	14	46.5	1	9.072 741
20	31.5	14	56.5	1	9.072 742
30	33.5	14	68.5	1	9.072 743
50	37.5	18	86.0	1	9.072 745
100	47.5	18	105.0	1	9.072 748
200	57.5	18	133.0	1	9.072 751
250	61.3	25	140.0	1	9.072 750
500	75.0	25	177.0	1	9.072 752
1000	97.5	28	223.5	1	9.072 755

3 Narrow-mouth bottles, series 301, LDPE, with srew cap

Natural, round. Tall, narrow form, leakproof. Easy to handle.

Kautex

Also available with dropper cap or spray cap.

Capacity	Diam.	Height	Thread external diam.	PK	Cat. No.
ml	mm	mm	mm		
2000	120	264	28	1	9.072 757
3000	138	300	32	1	9.072 759
5000	162	355	40	1	9.072 762



4 Round square-shouldered bottles, series 302, HDPE

Natural. Round. Tall, narrow form, leakproof. Easy to handle.

Kautex

Also available with dropper cap or spray cap.

Please order cap separately.



Capacity	Diam.	Thread external diam.	Height	PK	Cat. No.
ml	mm	mm	mm		
50	36.5	18	80.0	1	9.073 365
100	44.5	18	98.5	1	9.073 366
500	75.5	25	160.0	1	9.073 369
1000	95.0	28	196.0	1	9.073 370

Height in mm without cap.

1. General laboratory consumables

Vessels/Narrow-mouth bottles

1 Caps for narrow-mouth bottles, series 301/302/310, LDPE

Natural.

Kautex

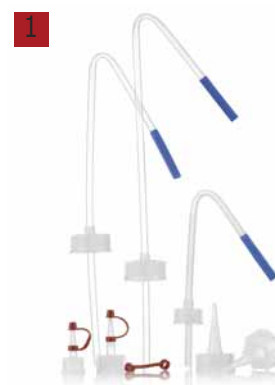

For bottles ml	For Thread o.d. mm	Description	PK	Cat. No.
10, 20, 30	14	Dropping cap *	1	9.073 314
50, 100, 200	18	Dropping cap *	1	9.073 315
250, 500	25	Dropping cap *	1	9.073 318
1000, 2000	28	Dropping cap *	1	9.073 319
10, 20, 30	14	Screw-type cap	1	9.072 771
50, 100, 200	18	Screw-type cap	1	9.072 773
250/500	25	Screw-type cap	1	6.291 535
1000, 2000	28	Screw-type cap	1	6.291 536
100	18	Spray cap	1	9.223 110
200	18	Spray cap	1	9.223 111
250	25	Spray cap	1	9.223 112
500	25	Spray cap	1	9.223 113
1000	28	Spray cap	1	9.223 114
2000	28	Spray cap	1	9.223 120
alle		Small nozzle cap with red retaining band, PVC	1	9.073 320

* with PVC-Nozzle, red

2 Round Bottles, series 308, HDPE

Neck design allows single handed use.

Kautex

Used for:

- Packaging
- Storage
- Transport

Please order closure separately.

Capacity ml	Diam. mm	Neck diam. mm	Thread external diam. mm	Height mm	PK	Cat. No.
50	32	17.0	22	86.0	1	9.072 783
100	41	17.0	22	108.5	1	9.072 784
250	56	17.0	22	135.5	1	9.072 785
500	70	19.4	25	173.0	1	9.072 786
1000	89	19.4	25	211.5	1	9.072 787

Height without cap.



3 Caps for Round Bottles, series 308, PP

White caps.

Kautex

For bottles ml	Description	Thread Internal Ø mm	PK	Cat. No.
50 / 100 / 250	Neck opening caps	22	1	9.072 788
500 / 1000	Neck opening caps	25	1	9.072 789

Vessels/Narrow-mouth bottles

1

1

Narrow-mouth reagent bottles, series 308/310, HDPE, UN-approved

UN-approved (only with the fitting UN-approved closures: 9.073 379 - 381).
 Square except 500 ml size which is round and has an outside diameter of 77 mm.
 Available in natural or black. Suitable for transporting hazardous liquids. Leakproof.
Please order closure separately.

Kautex

Colour	Capacity ml	Height mm	Weight g	Neck thread GL	Serie	PK	Cat. No.
natural	500	176.5	50	45	500	1	9.073 373
natural	1000	211.8	88	45	1000	1	9.073 374
natural	2500	282.0	163	45	2500	1	9.073 375
black	500	176.5	52	45	500	1	9.073 376
black	1000	211.8	92	45	1000	1	9.073 377
black	2500	282.0	167	45	2500	1	9.073 378

Height in mm without closure.

2

2

Narrow-mouth bottles, series 310 "Clear Grip", PP

Transparent with bright surface, ideal for product presentations.
 Low weight, outstanding chemical resistance and thermal stability,
 balanced stiffness and impact resistance.

Kautex
Please order closures separately.

Capacity ml	Height mm	Weight g	Neck thread GL	PK	Cat. No.
100	108	15	32	1	9.073 456
250	136	21	32	1	9.073 457
500	169	40	45	1	9.073 458
1000	204	61	45	1	9.073 459

3

3

Closures for narrow-mouth reagent bottles, series 310, UN-approved

UN-approved.

Kautex

Type 1: Light cap, white, PP, tamper-evident ring, white, PTFE cup-shaped liner
 (without figure)

Type 2: Light cap, black, HDPE, tamper-evident ring, black, PTFE cup-shaped liner

Type 3: Bell cap, black, PP, tamper-evident ring, red, cup-shaped PTFE liner

Type 4: Bell cap, red, PP, with degassing membrane, tamper-evident ring, red, cup-shaped, perforated PTFE liner

Type	Description	For bottles ml	For Thread o.d. mm	PK	Cat. No.
1	Light cap	100 ... 250	32	1	9.073 480
2	Light cap	500, 1000, 2500	45	1	9.073 379
3	Bell cap	500, 1000, 2500	45	1	9.073 380
4	Bell cap	500, 1000, 2500	45	1	9.073 381

4

4

Caps for narrow-mouth reagent bottles, PP

A) Tamper-evident cap, blue, with conical seal and tamper-evident ring.
 Immediately indicates unauthorised opening. Perfect for determining whether
 the cap has been removed.

Kautex

B) Tamper-evident cap, red, with PE foam lining and tamper-evident ring. Immediately indicates unauthorised
 opening. Perfect for determining whether the cap has been removed.

C) Tamper-evident cap, white/blue, with push and turn function, conical seal and tamper-evident ring.
 Immediately indicates unauthorised opening. Perfect for determining whether the cap has been removed.

D) Tamper-evident cap, white/red, with push and turn function, tamper-evident ring, conical seal and
 degassing membrane.

without Fig.) Tamper-evident cap, red, degassing cap, with conical gasket and degassing membrane.

For bottles ml	For Thread o.d. mm	Figure	PK	Cat. No.
2500	45	A	1	9.072 862
100 to 1000	32	B	1	9.072 863
100 to 1000	32	C	1	9.072 866
100 to 1000	32	D	1	9.072 867
100 to 1000	32	-	1	9.072 905

YOUR RELIABLE PARTNER SINCE 85 YEARS





Highest quality, best delivery reliability and excellent service. Your products are produced only with specified raw materials. Kautex is certified with ISO 9001, ISO 14001, OHSAS 18001 and ISO 50001.

Benefit from our wide product portfolio, developed and produced for laboratories, chemical and pharmaceutical industries.

www.kautex.de.
Sales.IP@kautex.textron.com

Plastic bottles & jerrycans 5 ml to 60 l

- Wide neck bottles
- Narrow neck bottles
- Polygonal bottles
- Wash bottles
- UN Bottles
- Wide neck containers
- Wide neck jars
- UN Jerrycans
- Carboys
- Buckets



1 Round Bottles, series 321 "VarioPack Dual" with PA barrier layer, white

High-quality packaging with barrier layer of polyamide for highly volatile or intense smelling media with high permeation rate.

Kautex

- Used for:
- Packaging
 - Storage
 - Transport

Please order closure separately.



Capacity	Diam.	Neck diam.	Thread external diam.	Height	PK	Cat. No.
ml	mm	mm	mm	mm		
250	62	42	50	131.3	1	9.073 517
500	69	42	50	186.5	1	9.073 518
1000	88	42	50	234.0	1	9.073 519

Height without cap.

2 Caps for Round Bottles, VarioPack, HDPE

Closure HDPE, white, with PA/PE/PA-insert and tamper evident ring

Kautex



For bottles	Description	Thread Internal Ø	PK	Cat. No.
ml		mm		
250 - 1000	Closure HDPE	50	1	9.073 520

Vessels/Narrow-mouth bottles



1 Narrow-mouth bottles Nalgene™, with screw cap, PP

Thermo Scientific



- High level of chemical resistance
- Leakproof
- Autoclavable (cap must be unscrewed before autoclaving)

Capacity ml	Screw cap diam. mm	PK	Cat. No.
4	13	12	9.103 260
8	20	12	9.103 261
15	20	12	9.103 262
30	20	12	9.103 263
60	20	12	9.103 264
125	24	12	9.103 265
250	24	12	9.103 266
500	28	12	9.103 267
1000	38-430*	6	9.103 268

* with high form thread.



2 Narrow-mouth bottles Nalgene™, HDPE, with screw cap, PP

Thermo Scientific

- High level of chemical resistance
- Leakproof

Capacity ml	Screw cap diam. mm	PK	Cat. No.
4	13	12	9.103 269
8	20	12	9.103 270
15	20	12	9.103 271
30	20	12	9.103 272
60	20	12	9.103 273
125	24	12	9.103 274
250	24	12	9.103 275
500	28	12	9.103 276
500	38-430*	12	9.103 277
1000	38-430*	6	9.103 278

* with high form thread.



3 Narrow-mouth bottles Nalgene™ Economy , PPCO, with screw cap, PP

Thermo Scientific



General-purpose, single-use sample bottle.

- Leakproof
- Autoclavable

Capacity ml	Cover type mm	PK	Cat. No.
30	20	1	9.103 035
60	20	1	9.103 036
125	24	1	9.103 037
250	24	1	9.103 038
500	28	1	9.103 039
1000	38-43	1	9.103 040



4 Diagnostic bottles Nalgene™, PETG, with white screw cap, HDPE

Thermo Scientific

For sterile sampling, storage and shipment of reagents and buffer solutions.

- Pyrogen-free
- Non-cytotoxic
- USP class VI

Capacity ml	Diam. mm	Height mm	Neck diam. int. mm	Sterile	PK	Cat. No.
5	22	46	11	+	100	6.803 092
10	24	56	11	+	100	6.205 128
20	30	65	11	+	100	7.632 641

1. General laboratory consumables

Vessels/Narrow-mouth bottles-Square bottles

1 Reagent bottles, PP, GL 45



VITLAB

Transparent. With PP screw cap. Good chemical resistance, ideal for storage of liquids. Autoclavable at 121 °C (2 bar) according to DIN EN 285. Food-safe product according to regulation (EU) No. 10/2011. Size 5000 ml with a carrying handle made of HDPE.



Capacity ml	Ext. diam. mm	Neck thread GL	Height mm	PK	Cat. No.
250	132	45	73	1	7.055 116
500	172	45	87	1	7.072 173
1000	197	45	105	1	9.073 171
2000	241	45	131	1	9.073 172
5000	315	45	178	1	9.073 170

2 Aluminium bottles, with UN approval



Bürkle

The aluminium bottle is particularly suited for storing, transport or sending substances and reference samples which have to be stored completely unaltered.

- With UN approval (60 - 5600 ml)
- Pure aluminium (AL99.5 material)
- PP screw cap with internal aluminium seal included



Description	Capacity ml	Diam. mm	Height mm	PK	Cat. No.
Bottle	5600	161	340	1	6.290 529
Bottle	60	40	88	10	6.291 403
Bottle	120	57	97	10	6.291 404
Bottle	300	57	160	10	6.291 405
Bottle	600	74	192	10	6.291 406
Bottle	1200	88	248	10	6.291 407
Bottle	3000	161	215	10	6.291 408
Bottle	5600	161	340	10	6.291 409
Screw cap for 38 ml				1	6.269 841
Screw cap for 60-1200 ml				1	6.201 285

3 Square shape laboratory bottles, DURAN®, with retrace code

Easy to use due to square shape, highly stable, good stackability - proven DURAN® properties give a space saving of 44 % in comparison with standard laboratory bottles (example applies to 100 ml bottles) With pouring ring and PP screw cap. Temperature (max.): +140 °C

DWK Life Sciences

Advantages:

- proven DURAN® properties
- excellent chemical resistance
- low coefficient of expansion
- can be sterilised to 140 °C. Before autoclaving, unscrew closure and set lightly on the container. Do not tighten the closure.
- freezer limit: -40 °C. Only freeze the bottle by laying at an angle and if maximum ¾ full.
- ergonomic shape
- very stable
- with Retrace code (Batch identification). Certificate available via the Internet.
- neutral glass/Type I glass acc. to USP/EP and JP.



Capacity ml	Width mm	Height* mm	Neck thread GL	PK	Cat. No.
100	50	109	32	1	9.072 076
250	64	143	45	1	9.072 077
500	78	181	45	1	9.072 078
1000	94	222	45	1	9.072 079

*Height mm incl. cap

Vessels/Square bottles



1 Square, screw cap bottles, wide-mouth, soda-lime glass

Soda-lime glass. With short thread. Hydrolytical class 3.

DWK Life Sciences

Please order pouring ring separately.

Colour	Capacity ml	Diam. mm	Height mm	Neck thread	PK	Cat. No.
clear	50	48	70	32	1	9.072 073
clear	100	49	109	32	1	9.072 071
clear	250	64	146	45	1	9.072 072
clear	500	77	173	54	1	9.072 075
clear	1000	97	213	60	1	9.072 080
amber	100	49	109	32	1	9.072 081
amber	250	64	146	45	1	9.072 082
amber	500	77	173	54	1	9.072 085
amber	1000	97	213	54	1	9.072 090



2 Narrow-mouth square bottles, soda-lime glass, with screw cap

Soda-lime glass, with high threaded neck. Without closure. Hydrolytical class 3.

DWK Life Sciences

clear: without pouring ring and dust cap

amber: with pouring ring and dust cap

Colour	Capacity ml	Diam. mm	Height mm	Neck thread GL	PK	Cat. No.
clear	100	49	119	32	1	9.072 051
clear	250	64	155	32	1	9.072 052
clear	500	77	186	32	1	9.072 055
clear	1000	97	223	45	1	9.072 060
amber	100	49	119	32	1	9.072 061
amber	250	64	155	32	1	9.072 062
amber	500	77	186	32	1	9.072 065
amber	1000	97	223	45	1	9.072 070



3 Tamper-evident caps for soda-lime square screw cap bottles, PP

Blue PP. For square screw cap bottles (soda-lime glass).

Type H: Narrow-neck, with high form thread.

Type K: Wide-necked, with short form thread.

Temperature (max.): 140 °C

Type	Diam. mm	Height mm	Neck thread GL	PK	Cat. No.
32 H	45	32	32	1	9.072 041
45 H	60	35	45	1	9.072 042
32 K	44	23	32	1	9.072 092
45 K	58	27	45	1	9.072 093
54 K	69	29	54	1	9.072 094
60 K	78	29	60	1	9.072 095



4 Wide-mouth bottles, PE, square, graduated, with screw cap

Kartell



Space saving bottles, ideal for long term storage of samples. With PP screw cap. Approximate graduations allow reproducible filling without the use of cylinders/beakers. Easy grip caps can be wired down for security. Suitable for foodstuff according to EC Regulation EC Regulation 10/2011.

Capacity ml	Grad. ml	Tubing i.d. mm	Width mm	Depth mm	Height mm	PK	Cat. No.
25	5	18.0	32	34	52	1	9.072 943
50	10	24.0	38	38	70	1	9.072 944
100	20	34.5	42	48	90	1	9.072 945
250	50	34.5	57	60	110	1	9.072 946
500	100	45.0	70	80	138	1	9.072 947
1000	100	58.0	80	103	176	1	9.072 948
2000	100	58.0	100	134	210	1	9.072 949

1. General laboratory consumables

Vessels/Square bottles

1 2 Square bottles, HDPE and PVC, series 310

Square, HDPE, Natural, translucent bottle. Square, PVC, transparent, rigid bottle.
Please order screw caps separately.

Kautex

Capacity ml	Thread external diam. mm	Width mm	Depth mm	Height mm	Material	PK	Cat. No.
100	18	40.5	32.0	110.5	HDPE	1	9.072 808
250	25	53.5	42.0	146.5	HDPE	1	9.072 814
500	25	63.5	54.5	180.0	HDPE	1	9.072 819
1000	25	84.0	66.0	222.5	HDPE	1	9.072 824
250	25	59.0	38.0	151.5	PVC	1	9.072 914
500	25	70.0	50.0	189.0	PVC	1	9.072 919
1000	25	87.5	61.0	233.0	PVC	1	9.072 924

Height in mm without cap.



3 Caps for HDPE and PVC square bottles series 310

Kautex



For bottles	Description	PK	Cat. No.
100 ml, HDPE	Moulded plastic cap, black melamine	1	9.073 321
250, 500 and 1000 ml, HDPE	Moulded plastic cap, black melamine	1	9.073 322
250, 500 and 1000 ml, PVC	Moulded plastic cap, melamine, white	1	9.072 929
250, 500 and 1000 ml, PVC	Screw cap, white PP, with washbottle jet	1	9.072 915

4 Square wide-mouth containers, series 310, PETG

Without closure. Crystal clear, ideal for presenting products in their true colours.
 The wide-mouth enables easy filling and cleaning.
Please order closures separately.

Kautex

Capacity ml	Thread external diam. mm	Height mm	PK	Cat. No.
50	32	60.5	1	9.073 395
100	40	71.0	1	9.073 396
200	50	88.0	1	9.073 397
500	65	108.0	1	9.073 398
1000	80	143.0	1	9.073 399
2000	80	187.0	1	9.073 400

Height in mm without closure.



➔ Further Caps - please see page 81.

Vessels/Square bottles

1

1 Square wide-mouth containers, series 310, PVC

Transparent. Clear, for good product presentation. Amber, for light sensitive contents. The wide mouth allows for easy filling and cleaning. Black PP, tamper-evident leakproof closure.

Kautex

Please order closures separately.

Colour	Capacity ml	Thread external diam. mm	Height mm	PK	Cat. No.
Transparent	100	40	83.5	1	9.074 051
Transparent	200	50	98.5	1	9.074 052
Transparent	300	50	105.5	1	9.074 053
Transparent	500	65	118.5	1	9.074 054
Amber	100	40	83.5	1	9.074 061
Amber	200	50	98.5	1	9.074 062
Amber	300	50	105.5	1	9.074 063
Amber	500	65	118.5	1	9.074 064

Height in mm without closure.

2

2 Square, wide-mouth containers, series 310, PVC

Rigid, Amber or Clear PVC containers. Universal container for storage, sample dispatch and transport. The clear version is ideal for colour-fast product presentation.

Kautex

The amber version is suitable for light sensitive products.

Please order screw caps separately.

Colour	Capacity ml	Thread external diam. mm	Width mm	Depth mm	Height without closure mm	PK	Cat. No.
clear	50	32	38.0	38.0	57	1	9.073 050
clear	100	40	46.0	46.0	71	1	9.073 051
clear	200	50	59.5	59.5	87	1	9.073 052
clear	300	50	67.5	67.5	94	1	9.073 053
clear	500	65	80.5	80.5	108	1	9.073 054
clear	750	80	91.5	91.5	120	1	9.073 055
clear	1000	80	97.5	97.5	143	1	9.073 056
clear	2000	80	122.0	122.0	187	1	9.073 057
amber	50	32	38.0	38.0	54	1	9.073 060
amber	100	40	46.0	46.0	71	1	9.073 061
amber	200	50	59.5	59.5	87	1	9.073 062
amber	300	50	67.5	67.5	94	1	9.073 063
amber	500	65	80.5	80.5	108	1	9.073 064
amber	750	80	91.5	91.5	120	1	9.073 065
amber	1000	80	97.5	97.5	143	1	9.073 066
amber	2000	80	122.0	122.0	187	1	9.073 067

3

3 Caps for series 310 PETG and PVC

Black screw caps, suitable for wide mouth containers made of PVC (clear or amber) and PETG.

Kautex

For volume ml	For Thread o.d. mm	PK	Cat. No.
50	32	1	9.073 070
100	40	1	9.073 071
200 and 300	50	1	9.073 072
500	65	1	9.073 073
750 and 1000	80	1	9.073 074
2000	80	1	9.073 075

4

4 Tamper-evident caps for series 310, PP/PE

Suitable for series 310 PVC wide mouth containers (transparent and amber).

Kautex

Tamper-evident black PP cap with PE foam liner and tamper-evident ring which immediately indicates unauthorised opening. Perfect for determining whether the cap has been removed.

For jars ml	For Thread o.d. mm	PK	Cat. No.
100	40	1	9.074 071
200 and 300	50	1	9.074 072
500	65	1	9.074 073

1. General laboratory consumables

Vessels/Square bottles

1 2 Square reagent bottles, HDPE

Natural or white. Wide neck. UN approved for solid materials.

Kautex

Please order closure separately.

Colour	Capacity ml	Thread external diam. mm	Width mm	Depth mm	Height without closure mm	PK	Cat. No.
natural	50	28*	36	36	88.5	1	9.072 869
natural	100	32	45	45	101.0	1	9.072 870
natural	250	45	59	59	128.0	1	9.072 871
natural	350	45*	60	60	164.0	1	9.072 877
natural	500	54	75	75	161.0	1	9.072 872
natural	750	54	83	83	185.0	1	9.072 878
natural	1000	54	85	85	212.0	1	9.072 873
natural	1500	80	108	108	209.0	1	9.072 874
natural	2500	80	122	122	258.0	1	9.072 875
natural	4000	80	142	142	294.0	1	9.072 876
white	50	28*	36	36	88.5	1	9.072 879
white	100	32	45	45	101.0	1	9.072 880
white	250	45	59	59	128.0	1	9.072 881
white	500	54	75	75	161.0	1	9.072 882
white	750	54	83	83	185.0	1	9.072 883
white	1000	54	85	85	212.0	1	9.072 884
white	1500	80	108	108	209.0	1	9.072 885
white	2500	80	122	122	258.0	1	9.072 886
white	4000	80	142	142	294.0	1	9.072 887

*not UN approved



3 Caps for wide-mouth reagent bottles, PP (melamine*)

Guarantees the functionality and the tightness of the bottle to protect the contents.

Kautex

Type a) Screw cap, black with 1.5 mm PE foam lining. Ensures that the bottle is tightly and safely sealed.

Type b) Tamper-evident cap, blue, with conical seal and tamper-evident ring. Immediately indicates unauthorised opening. Perfect for determining whether the cap has been removed.

Type c) Tamper-evident cap, red, with PE foam lining and tamper-evident ring. Immediately indicates unauthorised opening. Perfect for determining whether the cap has been removed.

Type	For bottles ml	Colour	Thread external diam. mm	PK	Cat. No.
Type a*	50	black	28	1	9.072 894
Type a	100	black	32	1	9.072 895
Type a	250, 350	black	45	1	9.072 896
Type a	500, 750, 1000	black	54	1	9.072 897
Type a	1500 - 4000	black	80	1	9.072 898
Type b	50	blue	28	1	9.072 904
Type b	1500 - 4000	blue	80	1	9.072 893
Type c	50	red	28	1	9.072 899
Type c	100	red	32	1	9.072 900
Type c	250, 350	red	45	1	9.072 901
Type c	500, 750, 1000	red	54	1	9.072 902
Type c	1500 - 4000	red	80	1	9.072 903

* melamine.



Vessels/Square bottles-Reagent bottles

1

1 Wide-mouth square bottles, 311 series, HDPE

Natural. Square with recessed handle. Large, wide-mouth containers designed to be space-saving. Safe and easy to use. Ideal for storing, collecting and transporting dry substances.

Kautex

Type 1: Tamper-evident cap 9.072 893 please order separately.

Type 2: Supplied with closure.

Description	Capacity	Thread external diam.		Height	PK	Cat. No.
	ml	mm	mm	mm		
Type 1 (without cap)	2300	80		188	1	9.072 932
Type 2 (with cap)	4400	120		263	1	9.072 934

2

2 Tamper-evident cap for 311 series, PP

Blue, with conical seal and tamper-evident ring for 2.3 L wide mouth containers. Immediately indicates unauthorised opening. Perfect for determining whether the cap has been removed.

Kautex

For	PK	Cat. No.
Type 2300, art. nr. 9.072 932	1	9.072 893

3

3 Square reagent bottles, HDPE

Natural or white. Narrow neck.

Kautex

Please order closures separately.

Colour	Capacity	Thread external diam.		Width	Depth	Height without closure	PK	Cat. No.
	ml	mm	mm	mm	mm	mm		
natural	100	32		45	45	108	1	9.072 850
natural	250	32		60	60	136	1	9.072 851
natural	500	32		74	74	170	1	9.072 852
natural	1000	32		85	85	221	1	9.072 853
natural	2500	45		122	122	272	1	9.072 854
white	100	32		45	45	108	1	9.072 855
white	250	32		60	60	136	1	9.072 856
white	500	32		74	74	170	1	9.072 857
white	1000	32		85	85	221	1	9.072 858
white	2500	45		122	122	272	1	9.072 859

4

4 Square bottles Nalgene™ Type 2007, HDPE, with PP screw cap

Leakproof.

Thermo Scientific

Capacity	Screw cap diam.	Width	Depth	Height	PK	Cat. No.
ml	mm	mm	mm	mm		
125	28	64	58	102	12	9.103 279
250	38	76	48	114	12	9.103 280
500	48	94	58	140	12	9.103 281
1000	53	125	71	180	6	9.103 282
2000	63	152	81	239	4	9.103 283

5

5 Acid cap bottles

DURAN®. Conical shoulders. With NS pennyhead stopper and interchangeable glass cap. Glass type I/neutral glass as per USP, EP and JP. Autoclavable.

DWK Life Sciences

Colour	Capacity	Diam. mm	Height NS		PK	Cat. No.
	ml		mm	mm		
clear	100	55	145	19/17	1	9.072 408
clear	250	75	180	19/17	1	9.072 414
clear	500	82	220	24/20	1	9.072 419
clear	1000	109	260	29/32	1	9.072 424
amber	100	55	145	19/17	1	9.072 508
amber	250	75	180	19/17	1	9.072 514
amber	500	82	220	24/20	1	9.072 519
amber	1000	109	260	29/32	1	9.072 524

1. General laboratory consumables

Vessels/Spray, dropping bottles

1 LLG-Wash bottles, narrow neck, PE

Easy to squeeze, semi-rigid, translucent, with excellent clarity. The stream of the liquid can be easily controlled by hand pressure. Dispensing tip provides extra fine stream - tip can be cut back in order to increase the flow rate, if required.

Capacity ml	PK	Cat. No.
100	10	9.223 509
250	10	9.223 510
500	10	9.223 511
1000	10	9.223 512



2 Wash bottles Nalgene™ Type 2401, LDPE

LDPE bottle and suction tube. PP screw cap and suction tube support moulded as one piece.

Thermo Scientific

Capacity ml	Screw cap diam. mm	Height mm	PK	Cat. No.
125	24	147	1	9.223 223
250	24	175	1	9.223 224
500	28	213	1	9.223 225
1000	38-430*	259	1	9.223 226

*with high form thread



3 Wide-neck wash bottles, Nalgene™ Unitary™, Type 2402, LDPE, with screw cap, PP

LDPE Bottle with leakproof PP screw cap. Wide mouth neck. Bottle and dispensing jet are moulded in one piece.

Thermo Scientific

Type	Capacity ml	Screw cap diam. mm	PK	Cat. No.
2402	125	24	1	9.223 236
2402	250	38	1	9.223 237
2402	500	38	1	9.223 238
2402	750	38	1	9.223 239
2402	1000	43	1	9.223 240



4 Coloured wash-bottles, narrow-neck, LDPE/PP

Transparent. Available in four different colours to facilitate ready identification. Screw cap and PP spray tube. Precise spray jet and optimised medium backflow through the continuous and finely drawn tip of the spray tube.

VITLAB



Capacity ml	Neck thread GL	Colour	Height mm	Diam. mm	PK	Cat. No.
250	25	red	135	65	1	4.678 162
250	25	green	135	65	1	4.678 160
250	25	yellow	135	65	1	4.678 161
250	25	blue	135	65	1	4.678 159
500	25	red	180	74	5	4.664 278
500	25	green	180	74	5	4.664 281
500	25	yellow	180	74	5	4.664 282
500	25	blue	180	74	5	4.664 283
500	25	Set: red, green, yellow, blue (1 pc each)	180	74	1	7.910 783
1000	32	red	221	92	1	4.678 166
1000	32	green	221	92	1	4.678 165
1000	32	yellow	221	92	1	4.678 164
1000	32	blue	221	92	1	4.678 163
1000	32	Set: red, green, yellow, blue (1 pc each)	221	92	1	4.671 822

Vessels/Spray, dropping bottles



1 Wash bottle caps VENT-CAP, PP

NEW

VITLAB

No leakage or dripping with the VENT-CAP screw cap, the design of which prevents almost all static overpressure.

For bottles ml	Neck thread GL	Colour	PK	Cat. No.
250	25	Red	1	4.671 442
250	25	Blue	1	4.671 443
250	25	Green	1	4.671 444
250	25	Orange	1	4.671 445
250	25	Yellow	1	4.671 446
250	45	Red	1	4.671 599
250	45	Blue	1	4.671 600
250	45	Green	1	4.671 601
250	45	Orange	1	4.671 602
250	45	Yellow	1	4.671 603
500	25	Transparent	1	4.671 604
500	25	Red	1	4.671 605
500	25	Blue	1	4.671 606
500	25	Green	1	4.671 607
500	25	Orange	1	4.671 608
500	25	Yellow	1	4.671 609
500	45	Transparent	1	4.671 610
500	45	Red	1	4.671 611
500	45	Blue	1	4.671 612
500	45	Green	1	4.671 613
500	45	Orange	1	4.671 614
500	45	Yellow	1	4.671 615
1000	32	Red	1	4.671 616
1000	63	Red	1	4.671 617

2

2 LLG-Safety wash bottles, LDPE

Manufactured from LDPE and with the safety label printed on the wash bottle in accordance with regulation (EC) No. 1272/2008 (GHS).

- Colour coded cap and bottle for easy and quick recognition of the bottle content
- Dispensing tube designed to optimize backflow and turbulence-free operation.
- Permanent printing on the body of safety symbols in acc. with GHS, as well as of chemical formula, CAS number, hazard pictogram, signal word, hazard statements and NFPA code.
- Chemical name and Warning texts in German, English, French and Spanish

Colour	Capacity ml	Print	PK	Cat. No.
red	500	acetone	10	6.291 413
blue	500	distilled water	10	6.291 414
green	500	ethanol	10	6.291 415
yellow	500	isopropanol	10	6.291 416
orange	500	methanol	10	6.291 417

3

3 LLG-Safety vented wash bottles, LDPE

- Available in the languages: SP/FR/D/UK, NL/GR/IT/UK
- Wide mouth wide neck wash bottles featuring the patented DripLok® vapour venting valve that prevents solvent drips
- Indelibly printed
- Choose from 4 solvent labels all including the new Globally Harmonised Symbols, NFPA diamond, risk phrases and safety information
- Fitted with colour coded, one-piece polypropylene closures that maintain their shape in use
- Closures feature precision jet-tip aperture for fine control

Print	Capacity ml	Colour	Language	PK	Cat. No.
Acetone	500	red	SP/FR/D/UK	1	9.223 491
Acetone	500	red	NL/GR/IT/UK	1	4.663 289
Methanol	500	orange	SP/FR/D/UK	1	9.223 492
Methanol	500	orange	NL/GR/IT/UK	1	4.663 292
Isopropanol	500	yellow	SP/FR/D/UK	1	9.223 493
Isopropanol	500	yellow	NL/GR/IT/UK	1	4.663 291
Ethanol	500	green	SP/FR/D/UK	1	9.223 494
Ethanol	500	green	NL/GR/IT/UK	1	4.663 290

Further models can be found in our online shop.

1. General laboratory consumables

Vessels/Spray, dropping bottles

1 Washbottles with imprint, LDPE

Transparent. Screw cap and spray tube made of PP. Imprinted with "Distilled Water" in German, English, French and Spanish. Upon request, also with other imprints for non-hazardous media according to the RECh Directive.

VITLAB



Capacity ml	Neck thread GL	Print	PK	Cat. No.
250	25	Distilled water	1	9.223 301
250	45	Distilled water	1	6.256 388
500	25	Distilled water	1	9.223 321
1000	32	Distilled water	1	9.223 331

Further washbottles available on request.

2 Safety wash bottles, wide mouth, series 303, HDPE

Laboratory safety wash bottle printed with symbols for hazardous substances. Leakproof. Description of contents is given in German, English and French.

Kautex

Scratch-resistant ink. Bottles can be fully emptied thanks to a movable outlet jet, also can be used upside down.

Safety note: If the base of the jet is positioned above the liquid level, no liquid will be ejected in the event of a change in temperature. The jet tip is sealed for safety during transport and must be cut before use.

With fitted HDPE washbottle cap.



Type	Colour	Capacity ml	Thread external diam. mm	Height mm	PK	Cat. No.
Acetone	Red	250	40	120	1	9.073 355
Acetone	Red	500	50	154	1	9.073 356
Ethanol	Green	250	40	120	1	9.073 357
Ethanol	Green	500	50	154	1	9.073 358
Isopropanol	Yellow	250	40	120	1	9.073 359
Isopropanol	Yellow	500	50	154	1	9.073 360
Methanol	Orange	250	40	120	1	9.073 361
Methanol	Orange	500	50	154	1	9.073 362
Distilled water	Blue	250	40	120	1	9.073 363
Distilled water	Blue	500	50	154	1	9.073 364

Height in mm without closure.

3 Safety washbottles Nalgene™, PE

Solvent resistant print, indicating capacity, formula and hazard symbol. Text in english. Markings in accordance with hazardous material regulations. Non-metallic vent keeps contents in bottle. No risk of solvent leakage.

Thermo Scientific

Capacity ml	Print	Screw cap diam. mm	PK	Cat. No.
500	Acetone	28	1	9.223 261
500	Ethanol	28	1	9.223 263
500	Methanol	28	1	9.223 265
500	Distilled water	28	1	9.223 269



4 GHS Safety Wash Bottles Nalgene™

Prevent chemical accidents in the lab with Nalgene Right-to-Understand LDPE Wash Bottles. Bottles are pre-labeled with chemical identification and safe handling information following the GHS specifications as applicable to secondary laboratory containers. Wash bottles are ready to use when you transfer common laboratory chemicals from manufacturers' containers. Self-venting wash bottles eliminate risk of bottles self-dispensing.

Thermo Scientific

- Bottles are made from high quality Nalgene materials for low extractables and long life in the lab
- Printed with 100 % Globally Harmonized System (GHS) chemical safety information. No other system markings are used on the bottles, which eliminates confusion
- Color coded for easy chemical identification at a glance
- Dispensing nozzles are carefully molded to deliver a straight stream for precision dispensing and safety
- Self-venting, so idle bottles won't drip on the bench top
- Designed to dispense through the top with a closure and stem molded in one piece for uniform leakproof service



Capacity ml	Print	Material	Cover type	PK	Cat. No.
500	Ethanol	LDPE, natural	PP, white	6	6.269 400
500	Methanol	LDPE, natural	PP, green	6	6.269 401
500	Isopropanol	LDPE, natural	PP, yellow	6	6.269 402
500	Distilled Water	LDPE, natural	PP, natural	6	6.269 403
500	Sodium Hypochlorite	LDPE, white	HDPE, white	6	6.269 404
500	Deionized Water	LDPE, natural	PP, natural	6	6.269 405

Vessels/Spray, dropping bottles



1 VITsafe™ safety wash bottles, wide-mouth, PP/LDPE

LDPE or PP Bottles, PP spray tube. Safer due to the durable safety imprint in accordance to Directive (EC) No. 1272/2008 (GHS), as well as with all important information: Material name in German, English, French and Spanish, Chemical formula, CAS No., hazard pictogram, signal word, Risk phrases (H phrases), safety phrases (P phrases), as well as NFPA Code. Precise spray jet and optimised medium backflow through the continuous and finely drawn tip of the spray tube. Practically no leakage or dripping with the VENT-CAP screw cap, the design of which prevents almost all static overpressure.

VITLAB

Capacity ml	Print	Colour Cover	Neck thread GL	Material	PK	Cat. No.
250	Acetone	red	45	PP	1	9.223 375
500	Acetone	red	45	PP	1	9.223 381
1000	Acetone	red	63	PP	1	9.223 390
500	Acetonitrile	red	45	LDPE	1	6.235 042
250	Distilled water	blue	45	LDPE	1	9.223 370
500	Distilled Water	blue	45	LDPE	1	9.223 376
1000	Distilled water	red	63	LDPE	1	9.223 385
250	Ethanol	orange	45	LDPE	1	9.223 374
500	Ethanol	orange	45	LDPE	1	9.223 380
1000	Ethanol	red	63	LDPE	1	9.223 389
250	Ethyl acetate	red	45	LDPE	1	9.223 373
500	Ethyl acetate	red	45	LDPE	1	9.223 379
1000	Ethyl acetate	red	63	LDPE	1	9.223 388
250	Isopropanol	yellow	45	LDPE	1	9.223 372
500	Isopropanol	yellow	45	LDPE	1	9.223 378
500	i-Hexane	red	45	LDPE	1	9.223 391
500	Heptane	red	45	LDPE	1	9.223 392
1000	Isopropanol	red	63	LDPE	1	9.223 387
250	Methanol	green	45	LDPE	1	9.223 371
500	Methanol	green	45	LDPE	1	9.223 377
1000	Methanol	red	63	LDPE	1	9.223 386
500	Methylethylchloride	transparent	45	LDPE	1	6.225 506
500	Methylethylketone (MEK)	red	45	PP	1	9.223 384
500	N,N-Dimethylformamide	red	45	LDPE	1	6.225 507
500	Pentane	red	45	LDPE	1	9.223 397
500	Tetrahydrofuran (THF)	red	45	LDPE	1	9.223 393
500	Toluene	red	45	LDPE	1	9.223 394
500	Xylol	red	45	LDPE	1	9.223 395



2 VITsafe™ Safety wash bottles, narrow neck, PP/LDPE

Bottles made from LDPE, spray tube from PP. Safer due to the durable safety imprint in accordance to Directive (EC) No. 1272/2008 (GHS), as well as with all important information: Material name in German, English, French and Spanish, Chemical formula, CAS No., hazard pictogram, signal word, Risk phrases (H phrases), safety phrases (P phrases), as well as NFPA Code. Precise spray jet and optimised medium backflow through the continuous and finely drawn tip of the spray tube. Practically no leakage or dripping with the VENT-CAP screw cap, the design of which prevents almost all static overpressure.

VITLAB

Capacity ml	Print	Colour Cover	Material	Neck thread GL	PK	Cat. No.
250	Acetone	red	PP	25	1	9.223 345
500	Acetone	red	PP	25	1	9.223 351
1000	Acetone	red	PP	32	1	9.223 360
500	Acetonitrile	red	LDPE	25	1	7.058 640
250	Distilled water	blue	LDPE	25	1	9.223 340
500	Distilled water	blue	LDPE	25	1	9.223 346
1000	Distilled water	red	LDPE	32	1	9.223 355
250	Ethanol	orange	LDPE	25	1	9.223 344
500	Ethanol	orange	LDPE	25	1	9.223 350
1000	Ethanol	red	LDPE	32	1	9.223 359
250	Ethyl acetate	red	LDPE	25	1	9.223 343
500	Ethyl acetate	red	LDPE	25	1	9.223 349
1000	Ethyl acetate	red	LDPE	32	1	9.223 358
500	Acetic acid	red	LDPE	25	1	7.079 737
250	Isopropanol	yellow	LDPE	25	1	9.223 342
500	Isopropanol	yellow	LDPE	25	1	9.223 348
1000	Isopropanol	red	LDPE	32	1	9.223 357
250	Methanol	green	LDPE	25	1	9.223 341
500	Methanol	green	LDPE	25	1	9.223 347
1000	Methanol	red	LDPE	32	1	9.223 356
500	Methylene chloride	transparent	LDPE	25	1	7.078 722
500	Methylethylketone (MEK)	red	PP	25	1	9.223 354
500	N, N-Dimethylformamide	red	LDPE	25	1	6.401 458
500	Xylene	red	LDPE	25	1	7.087 939
500	i-Hexane	red	LDPE	25	1	7.009 310
500	Heptane	red	LDPE	25	1	6.073 505
500	Tetrahydrofuran (THF)	red	LDPE	25	1	7.087 940
500	Toluene	red	LDPE	25	1	7.087 938
500	Pentane	red	LDPE	25	1	6.242 784

1. General laboratory consumables

Vessels/Spray, dropping bottles

1 Dropping bottles, pipette bottles, soda-lime glass

Amber or Clear. Soda-lime glass, NS 14/15. With interchangeable ground joint transparent pipette. Hydrolytical class 3. Complete with rubber teat.

DWK Life Sciences

Colour	Description	Capacity ml	Height mm	PK	Cat. No.
clear	Dropping bottles	50	79	1	9.072 646
clear	Dropping bottles	100	105	1	9.072 648
amber	Dropping bottles	50	79	1	9.072 656
amber	Dropping bottles	100	105	1	9.072 658
clear	Replacement pipette	50		1	7.021 595
clear	Replacement pipette	100		1	7.021 596



2 Dropper bottles, HDPE

Natural. Highly suitable for adhesives and other liquids that can be finely dispensed.

Kautex

HDPE combination closure with screw-on dropping tip (Cat. No. 9.073 313). Please order separately.

Capacity ml	Diam. mm	PK	Cat. No.
10	24.0	1	9.073 310
25	31.3	1	9.073 311
50	40.0	1	9.073 312



3 Cap for dropping bottles, HDPE

For bottles 9.073 310 to 9.037 312 series.

Kautex

Type	PK	Cat. No.
Cap for dropping bottles	1	9.073 313



4 Spray bottles with pump vapouriser

Spray bottles (HDPE) with pump vapouriser (PP, stainless steel) and safety cap for the pump. Liquids can be finely vapourised at the push of a button in an environmentally compatible way. The transparent bottles make identification of contents easy. The protective cover prevents unintentional pressing of the pump and acts as a dust cover.

Bürkle

Capacity ml	Height with closure mm	Diam. mm	PK	Cat. No.
20	85	28	1	6.254 292
50	110	35	1	6.801 696
100	161	37	1	6.300 066
250	222	50	1	6.300 067



5 Spray bottles LaboPlast®, PE/PP

Chemical resistant to a large extend. Trigger-action spray pump with continuously adjustable spray nozzle.

Bürkle

- Parts in contact with media made of PP, PE and stainless steel
- Nozzle diameter 0.6mm; nozzle is continuously adjustable
- Amount sprayed per stroke: 1.2 ml ±0.1 ml

Capacity ml	Ext. diam. mm	Neck diam. int. mm	Height mm	Weight g	PK	Cat. No.
250	60	18.0	220	54	1	9.223 152
500	75	18.0	240	79	1	9.223 155
1000	98	17.5	295	111	1	9.223 160



Vessels/Spray, dropping bottles

1



1 Spare spray head for spray bottles LaboPlast®

Bürkle

For	Colour	PK	Cat. No.
250 ml (9.223 152)	white	1	6.224 916
500 ml (9.223 155)	white	1	6.802 505
1000 ml (9.223 160)	white	1	6.079 701

2



2 3 Spray bottle Turn'n'Spray with overhead valve, PE/PP

Bürkle

Spraying upwards overhead is not possible with standard spray bottles. As soon as the suction tube is no longer immersed in liquid, you can't spray any more. Not so with our overhead spray bottle, Turn'n'Spray. It features a special technology that allows you to spray from any position. That means you can spray practically and conveniently from any angle and reach hard-to-access places easily and without straining. The high-quality, refillable spray bottle can be used again and again.

- Uninterrupted spraying, even upside down
- Parts in contact with media made of PP, PE, silicon and stainless steel
- Nozzle diameter 0.6mm; nozzle is continuously adjustable
- Amount sprayed per stroke: 1.2 ml ± 0.1 ml

3



Capacity	Neck diam.	Height int. with closure	Weight	PK	Cat. No.
ml	mm	mm	g		
250	18.0	220	18	1	6.252 153
500	18.0	240	18	1	6.252 154
1000	17.5	295	17	1	6.252 166

4



4 Pressure atomizer LaboPlast®, HDPE

Bürkle

The pressure sprayer is ideal to spray a wide range of liquids uniformly. The pressurised spray has a working pressure of 4 bar. Extension for spray lance 30 cm available as accessory.

- Wetted parts PE, PP, glass-fibre reinforced PA, V2A, FKM
- Bottle made of HDPE
- With short spray nozzle
- Left-handed and right-handed pistol control
- Adjustable spray jet
- Graduation up to 1500 ml
- Temperature max. 30 °C

Capacity	Ext. diam.	Neck diam.	Height	Weight	PK	Cat. No.
ml	mm	mm	mm	g		
1500	142	45	315	475	1	9.223 162

5



5 Pressure sprayer Turn'n'Spray

NEW

Bürkle

The pressure sprayer is ideal to spray a wide range of liquids uniformly. The practical 360° spray function allows you to spray overhead. The adjustable spray jet, with a nozzle diameter of 0.8 mm, can be adjusted from a fine spray mist to a powerful jet. Extension for spray lance 30 cm available as accessory.

- Wetted parts HDPE, PP, FKM, V4A
- Plastic container made of HDPE
- Safety valve to compensate overpressure, max. 4 bar

Type	Nominal capacity ml	PK	Cat. No.
Turn'n'Spray	1500	1	4.670 813

1. General laboratory consumables

Vessels/Spray, dropping bottles

1 Spray bottles

White or transparent bottles. Sprayer insert with stable, smooth pump trigger and adjustable spray nozzle, which can be regulated from the finest mist (nebulising) to a precise liquid jet. Range: approx. 3-4 meters. Ideal for spraying detergents or disinfectants, especially into difficultly accessible areas, as well as applications in thin layer chromatography.

VITLAB

Capacity ml	Colour	Material	PK	Cat. No.
400	white	PP	1	7.008 989
850	white	PP	1	7.008 990
1000	transparent	PP	1	7.659 025
1000	transparent with imprint "Ethanol"	LDPE	1	6.281 023



2 Pressure sprayer Food

NEW

Bürkle



For spraying various media, such as oils, fats or flavourings. The adjustable spray jet, with a nozzle diameter of 0.8 mm, can be adjusted from a fine spray mist to a powerful jet.

- Wetted parts HDPE, PP, VMQ, V2A
- Plastic container made of HDPE
- Safety valve to compensate overpressure, max. 3 bar
- Transparent viewing window for easy reading of the filling level
- Rubberised stand ring
- Food-safe

Type	Nominal capacity ml	PK	Cat. No.
Food	1200	1	4.670 814



3 Spray bottles, PET

Manufactured from transparent PET with a spray head. All media contacting parts perfectly resists to most solvents and chemicals. Liquids can be finely vaporised with the pull of the hand pump trigger. Safety lock at the trigger prevents accidental use.

ISOLAB

Capacity ml	PK	Cat. No.
250	1	6.286 661
500	1	6.286 662



Vessels/Funnels



1 LLG-Funnel, borosilicate glass 3.3

With short stem. Cone angle of 60°. Standard borosilicate funnels with excellent heat resistance. All funnels have a cone angle of 60° and therefore offer an optimum fit for all filter sizes. Autoclavable.

Funnel diam. mm	Shaft diam. mm	For filter paper diam. mm	Overall length mm	PK	Cat. No.
40	6	55 - 70	70	1	9.251 200
60	8	70 - 90	100	1	9.251 201
80	8	125 - 150	140	1	9.251 202
100*	10	150 - 185	180	1	9.251 203
125*	16	185 - 240	210	1	9.251 204
150*	16	240 - 270	250	1	9.251 205

* according to DIN ISO 4798



2 Funnels, DURAN®

DIN ISO 4798. With short stem. Glass Type I/neutral glass as per USP, EP and JP. Autoclavable.

DWK Life Sciences

Diam. mm	For filter paper diam. mm	Height mm	DIN	PK	Cat. No.
35	45 - 55	60	4798	1	9.251 123
45	55 - 70	80		1	9.251 128
55	70 - 90	95	4798	1	9.251 133
70	110 - 125	125		1	9.251 138
80	125 - 150	140		1	9.251 141
100	150 - 185	180	4798	1	9.251 146
120	185 - 240	210		1	9.251 023
150	240 - 270	265	4798	1	9.251 157
180	270 - 320	290		1	9.251 036
200	320 - 385	325		1	9.251 161
300	500	409		1	9.251 169



3 Analytical funnels, DURAN®

For rapid filtration. Glass Type I/neutral glass as per USP, EP and JP. Autoclavable.

DWK Life Sciences

Funnel diam. mm	For filter paper diam. mm	Height mm	PK	Cat. No.
65	70 to 90	200	1	9.251 237
80	110 to 125	210	1	9.251 241
110	150 to 185	265	1	9.251 248



4 LLG-Funnels, PP



Made of clear, virgin polypropylene, autoclavable at 121 °C and 1.1 bar for 30 minutes.

Funnel diam. mm	Shaft diam. mm	For filter paper diam. mm	Stem length mm	PK	Cat. No.
40	6	55 - 70	40	10	9.251 185
60	8	70 - 90	60	10	9.251 186
80	8	125 - 150	80	10	9.251 187
100	10	150 - 185	100	10	9.251 188
120	16	185 - 240	120	10	9.251 189
150	16	240 - 270	150	10	9.251 190

➔ For Filter paper, please have a look at page 699.

1. General laboratory consumables

Vessels/Funnels

1 LLG-Fast filtration funnels with internal ribs, PP



Clear, virgin polypropylene, autoclavable at 121 °C and 1.1 bar for 30 minutes. The external ribs prevent airlock and back pressure. The internal helicoidal rib prevents filter papers from sticking and increases filtration speed.

Funnel diam. mm	Shaft diam. mm	For filter paper diam. mm	Stem length mm	PK	Cat. No.
40	6	55 - 70	40	10	9.251 191
60	8	70 - 90	60	10	9.251 192
80	8	125 - 150	80	10	9.251 193
80	9	125 - 150	150	10	9.251 197
100	10	150 - 185	100	10	9.251 194
120	16	185 - 240	120	10	9.251 195
150	16	240 - 270	150	10	9.251 196



2 Funnel HDPE

Nature colours.

Hünersdorff

Funnel diam. mm	Diam. of the filler mm	PK	Cat. No.
50	3	1	9.073 464
60	8	1	9.073 465
80	11	1	9.073 466
100	12	1	9.073 467
120	12	1	9.073 468
164	17	1	9.073 469
208	20	1	9.073 470

9.073 470 with stainless steel mesh, 50 mm dia.



3 Funnels, PP



VITLAB

Transparent. Rapid flow due to a steep 60° angle. Practical handle with loop for hanging. Food-safe product according to regulation (EU) No. 10/2011.

Funnel diam. mm	Shaft int. diam. mm	Length* mm	Height mm	PK	Cat. No.
30	2	25	45	1	9.251 602
30	4	25	47	1	9.251 605
40	4	35	65	1	9.251 610
50	7	43	85	1	9.251 615
75	7	55	108	1	9.251 620
100	8	77	155	1	9.251 625
120	11	90	180	1	9.251 630
150	15	95	220	1	9.251 635

* Stem length (mm)



Barrel funnels, PP/HDPE



VITLAB

Transparent. Rapid flow due to a steep 60° angle. Practical handle for hanging. Suitable for filling large amounts of liquids. Cat. No. 9.251 640, 9.251 645 and 9.251 650 are food-safe products according to regulation (EU) No. 10/2011.

Sieve for 9251 640 and 9251 645 available (not approved as a food-safe article). Please order separately.

Funnel diam. mm	Stem diam. mm	Length* mm	Height mm	Material	PK	Cat. No.
200	22	90	200	PP	1	9.251 640
250	30	100	260	PP	1	9.251 645
350	35	170	440	PP	1	9.251 650
400	42	150	365	HDPE	1	9.251 655
430	37	420	420	HDPE	1	9.251 660

* Stem length (mm)



9.251 640



9.251 655

Vessels/Funnels

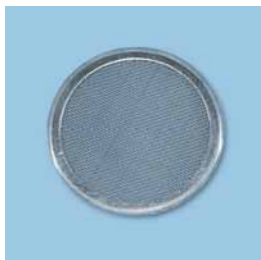
1

1 Sieve filter for barrel funnels

For 9.251 640 and 9.251 645.

Type	Diam. mm	PK	Cat. No.
Sieve filter	50	1	9.251 665

2

2 Funnels, stainless steel Remanit® 4301

With filling vent and handle.

RSG

Funnel diam. mm	Height mm	PK	Cat. No.
50*	65	1	4.664 420
80	105	1	6.274 315
100	125	1	4.661 801
120	140	1	9.251 213
150	180	1	4.661 836
200	210	1	4.661 835
240	270	1	4.661 834

* without handle and vent

3

3 Powder funnels, DURAN®

With short, wide stem.

Funnel diam. mm	Stem diam. mm	Height mm	PK	Cat. No.
55	20	60	1	6.901 149
70	22	72	1	7.021 151
80	24	79	1	7.021 152
100	26	94	1	7.021 153
120	34	105	1	9.251 323
160	35	140	1	9.251 332
200	40	170	1	9.251 338

4

4 Powder funnels with NS cone, DURAN® tubing

Solid addition funnels (angle: 60°), with NS cone, made of DURAN® tubing.

Lenz

Funnel diam. mm	NS	PK	Cat. No.
45	14 / 23	1	9.251 340
55	19 / 26	1	9.251 341
70	24 / 29	1	9.251 342
80	29 / 32	1	9.251 343

5

5 Powder funnels with NS-cone, borosilicate glass 3.3

With short stem and NS cone.

ISOLAB

Funnel diam. mm	Stem diam. mm	NS	PK	Cat. No.
60	13	14/23	1	4.008 433
80	17	19/26	1	4.008 434
100	22	24/29	1	4.008 435
120	26	29/32	1	4.008 436

1. General laboratory consumables

Vessels/Funnels

1 2 Powder funnels, PP



Transparent. With short, wide stem. For transfer of powdered and granular substances. Rapid flow due to a steep 60° angle. Food-safe product according to regulation (EU) No. 10/2011.

Funnel diam. mm	Stem diam. mm	Height mm	PK	Cat. No.
60	15	57	1	7.019 920
65 *	15	70	1	9.251 720
80	15	80	1	7.059 654
80 *	21	75	1	9.251 725
100	25	89	1	6.303 859
100*	24	92	1	9.251 730
120*	27	105	1	9.251 735
150	36	142	1	6.262 104
150	28	138	1	9.251 740
180	43	166	1	9.251 741

* with practical tab for hanging



3 Powder funnels, PP



Transparent. For transfer of powdered substances.

Funnel diam. mm	PK	Cat. No.
65	10	6.313 446
80	10	4.678 046
100	10	4.678 047
120	10	4.678 048
150	10	4.678 049



4 Powder funnels with NS-cone, PP

VITLAB



Transparent. For multi-neck flasks, laterally flattened, suitable for standard joint necks of various sizes. Suitable for the filling of liquid or powdered reagents into a reaction flask, particularly multi-neck flasks, during a reaction. Food-safe product according to regulation (EU) No. 10/2011.

Funnel diam. mm	Height mm	Joint size (NS)	PK	Cat. No.
40	75	14 / 23	1	9.251 814
50	95	19 / 26	1	9.251 819
75	135	29 / 32	1	9.251 829



5 LLG-Funnel holder, PP

Manufactured from best quality polypropylene. Suitable to hold all types of laboratory funnels with diameters up to 150 mm. Two tapered wedges are provided to ensure firm grip on rods having diameters of 10-13 mm.

To hold funnels piece	PK	Cat. No.
1	1	9.251 558



Vessels/Funnels



1 LLG-Funnel holder, stainless steel, with or without boss head

These funnel holders are suitable to hold all types of funnels with a diameter up to 150 mm. They can also accommodate separating funnels (up to 1000 ml). With or without boss head.

Description	Diam. mm	PK	Cat. No.
without bosshead	40	1	9.251 550
without bosshead	60	1	9.251 551
without bosshead	80	1	9.251 552
without bosshead	100	1	9.251 553
with bosshead	40	1	9.251 554
with bosshead	60	1	9.251 555
with bosshead	80	1	9.251 556
with bosshead	100	1	9.251 557



2 Funnel holders, PP

Polypropylene. Single or double holder for funnels from 25 mm (with adapter supplied) up to 170mm diameter. Without adapter they can be used for powder funnels with stem diameters not exceeding 35 mm. Two clamp adapters are provided for use with rods from 8 mm to 14 mm.

Kartell

To hold funnels piece	PK	Cat. No.
1	1	9.251 561
2	1	9.251 560

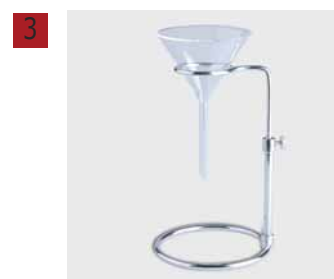

3 Funnel holder, chromated steel

Adjustable height 140 to 230 mm. Inner diameter upper ring: 45 mm. Outer diameter bottom ring: 126 mm.

ISOLAB

Description	PK	Cat. No.
Funnel holder	1	4.008 510



4 Filter funnel stands

PP holder mounted on a stand with 12.7 x 595 mm aluminium rod and heavy cast base plate. Choice of stands to hold 2 or 4 funnels with a top diameter of 50 to 120 mm. The holder height is adjustable.

BRAND

To hold funnels piece	Width mm	Length mm	PK	Cat. No.
2	140	250	1	9.069 982
4	140	450	1	9.069 984



9.069 924

5 Funnel stands LaboPlast®, PP

White, unbreakable, chemically resistant. For 2 or 4 funnels. Robust, heavy base provides good stability. Variable height adjustment up to 450 mm. Thanks to a magnet system, no clamping screws are necessary. The height of the funnel holder can be adjusted easily and flexibly with one hand.

Bürkle

With 2 or 4 aperture reduction inserts for small funnels. Suitable for funnels with diam. 40 to 180 mm.

To hold funnels piece	Width mm	Depth mm	Height mm	PK	Cat. No.
2	140	300	480	1	9.069 922
4	150	550	500	1	9.069 924

Gas jars, DURAN®



DWK Life Sciences

DURAN®. With base. Rim flanged and surface-ground or rim roughly ground. Autoclavable.

Description	Capacity ml	Diam. mm	Height mm	PK	Cat. No.
Rim flanged, surface-ground	80	40	100	1	9.318 107
Rim flanged, surface-ground	190	40	200	1	9.318 134
Rim flanged, surface-ground	390	40	400	1	9.318 168
Rim flanged, surface-ground	440	60	200	1	9.318 136
Rim flanged, surface-ground	550	60	250	1	9.318 146
Rim roughly ground	180	40	200	1	9.318 034
Rim roughly ground	220	50	150	1	9.318 021
Rim roughly ground	280	40	300	1	9.318 052
Rim roughly ground	380	40	400	1	9.318 068
Rim roughly ground	420	60	200	1	9.318 036
Rim roughly ground	450	50	300	1	9.318 053
Rim roughly ground	530	60	250	1	9.318 046
Rim roughly ground	770	50	500	1	9.318 080
Rim roughly ground	1250	65	450	1	9.318 077
Rim roughly ground	1650	80	400	1	9.318 074



9.318 107



9.318 034

3 Glass cylinders with knob lid, DURAN®

DURAN®. With knob lid and polished rim.

DWK Life Sciences

Diam. mm	Height mm	PK	Cat. No.
80	80	1	9.318 201
100	100	1	9.318 203
120	120	1	9.318 205
150	150	1	9.318 210
210	210	1	9.318 221
260	260	1	9.318 232



4 Watch glasses, Soda-lime glass

To DIN 12341. Ground edges. Hydrolytical class 3.

Diam. mm	PK	Cat. No.
200	1	9.263 020
250	1	9.263 025
40	10	9.263 030
50	10	9.263 031
60	10	9.263 032
70	10	9.263 033
80	10	9.263 034
90	10	9.263 035
100	10	9.263 036
110	10	9.263 037
120	10	9.263 039
125	10	9.263 038
150	10	9.263 040



5 Watch glasses, DURAN®



DWK Life Sciences

DURAN®, DIN 12341. Flame-polished edges. Autoclavable.

Diam. mm	PK	Cat. No.
40	1	9.263 424
50	1	9.263 432
60	1	9.263 434
80	1	9.263 441
100	1	9.263 446
125	1	9.263 452
150	1	9.263 457
200	1	9.263 461
250	1	9.263 466



Vessels/Dishes



1 Watch glasses, PP



Kartell

With base. Resistant to steam sterilisation (121 °C). Autoclavable.

Diam. mm	PK	Cat. No.
60.0	1	9.263 526
80.0	1	9.263 528
100.0	1	9.263 530
118.5	1	9.263 532



2 Evaporating dishes, DURAN®

DURAN®. DIN 12336. Flat-bottom with spout. Autoclavable.

DWK Life Sciences

Capacity ml	Rim diam. mm	Height mm	PK	Cat. No.
15	50	25	1	9.000 032
45	60	30	1	9.000 034
60	70	35	1	9.000 038
90	80	45	1	9.000 041
170	95	55	1	9.000 044
320	115	65	1	9.000 049
600	140	80	1	9.000 054
1500	190	100	1	9.000 059
2500	230	130	1	9.000 063

Suitable accessories can be found in our online shop.



3 Evaporating basins, Quartz glass

Transparent silica (Quartz glass). In accordance with DIN 12336. Flat-bottom with spout.

proQuarz

Capacity ml	Rim diam. mm	Height mm	PK	Cat. No.
10	40	18	1	9.000 110
15	50	25	1	9.000 111
45	60	30	1	9.000 112
60	70	35	1	9.000 113
90	80	45	1	9.000 114
170	95	55	1	9.000 115
320	115	65	1	9.000 116
600	140	80	1	7.400 417
45*	60	30	1	6.283 464

* without spout.



4 5 LLG-Crystallising dishes, borosilicate glass

Crystallising dishes with or without spout. DIN 12337/12338. Autoclavable.

Description	Capacity ml	Diam. mm	Height mm	DIN	PK	Cat. No.
without spout	20	40	25	12337	1	7.616 800
without spout	40	50	30	12337	1	6.228 031
without spout	60	60	35	12337	1	6.236 596
without spout	100	70	40	12337	1	6.233 757
without spout	150	80	45	12337	1	6.227 688
without spout	300	95	55	12337	1	6.205 104
without spout	500	115	65	12337	1	6.205 105
without spout	900	140	75	12337	1	6.236 597
without spout	2000	190	90	12337	1	6.236 598
without spout	3500	230	100	12337	1	6.236 599
with spout	20	40	25	12338	1	6.226 043
with spout	40	50	30	12338	1	7.616 171
with spout	60	60	35	12338	1	6.227 922
with spout	100	70	40	12338	1	6.228 387
with spout	150	80	45	12338	1	6.225 256
with spout	300	95	55	12338	1	6.803 567
with spout	500	115	65	12338	1	6.223 298
with spout	900	140	75	12338	1	6.206 856
with spout	2000	190	90	12338	1	6.803 371
with spout	3500	230	100	12338	1	6.231 072



1 Crystallising dishes, DURAN®

DURAN®. To DIN 12338. With spout. Dishes with capacity of 100 ml and above have labelling patch. Glass Type I/neutral glass as per USP, EP and JP. Autoclavable.

DWK Life Sciences

Description	Capacity ml	Diam. mm	Height mm	DIN	PK	Cat. No.
with spout	20	40	25	12338	1	9.144 024
with spout	40	50	30	12338	1	9.144 032
with spout	60	60	35	12338	1	9.144 034
with spout	100	70	40	12338	1	9.144 038
with spout	150	80	45	12338	1	9.144 041
with spout	300	95	55	12338	1	9.144 044
with spout	500	115	65	12338	1	9.144 049
with spout	900	140	75	12338	1	9.144 054
with spout	2000	190	90	12338	1	9.144 059
with spout	3500	230	100	12338	1	9.144 063



2 LLG-Crystallising dishes, stainless steel

Alternative to borosilicate glass dishes for similar applications. Manufactured from seamless and robust stainless steel.

Capacity ml	Depth mm	Width mm	PK	Cat. No.
100	70	35	1	6.267 379
150	85	45	1	6.267 380
400	110	55	1	6.267 381



3 LLG-Porcelain evaporating dishes with spout, flat bottom, shallow form

Glazed.

Capacity ml	Ext. diam. mm	Height mm	DIN	PK	Cat. No.
10	50	10	12903	1	9.115 301
20	60	14	12903	1	9.115 302
28	75	15		1	9.115 305
55	80	20	12903	1	9.115 303
110	100	25	12903	1	6.231 540
250	130	30	12903	1	9.115 304
450	160	40		1	9.115 306
1100	200	55		1	9.115 307
1750	250	55		1	9.115 308



4 Evaporating basins, porcelain, shallow form

Glazed inside and outside except for rim.

Haldenwanger

Capacity ml	Rim diam. mm	Height mm	PK	Cat. No.
5*	40	9	1	9.000 204
10*	50	11	1	9.000 205
20*	63	13	1	9.000 206
40*	80	20	1	9.000 208
80*	100	22	1	9.000 210
270*	125	27	1	9.000 212
450	160	35	1	9.000 216
1100	190	55	1	9.000 220
1750	240	65	1	9.000 225
2500	300	60	1	9.000 230

*According to DIN standard



5 LLG-Porcelain evaporating dishes with spout, round bottom, medium form

Glazed.

Capacity ml	Ext. diam. mm	Height mm	DIN	PK	Cat. No.
10	40	16	12903	1	9.115 310
20	50	20	12903	1	9.115 311
30	63	25	12903	1	6.239 177
41	72	26		1	9.000 150
60	80	32	12903	1	9.115 312
62	83	27		1	9.000 151
110	96	30		1	9.000 152
150	100	40	12903	1	9.115 313
240	127	42		1	9.000 153
285	125	50	12903	1	9.115 314
420	154	50		1	6.232 525
558	170	55		1	9.000 154
700	170	74	12903	1	9.115 315
1000	200	80	12903	1	9.115 316



Vessels/Dishes



1 LLG-Porcelain evaporating dishes with spout, flat bottom, medium form

Glazed.

Capacity ml	Ext. diam. mm	Height mm	PK	Cat. No.
22	54	22	1	7.970 673
62	70	30	1	6.268 802
93	86	33	1	6.251 474
154	98	40	1	6.253 566
265	112	50	1	6.262 379
330	126	53	1	6.257 949
450	145	55	1	6.269 244
620	151	63	1	6.257 950
800	169	68	1	6.269 245
1200	195	74	1	6.241 820
3000	254	105	1	7.971 013



2 Evaporating basins, porcelain, with spout, round bottom, medium form

Round bottom with spout. DIN 12903. 10 to 310 ml sizes are completely glazed inside and out. 640 to 3400 ml sizes are glazed with the exception of the outer base.

Haldenwanger

Capacity ml	Rim diam. mm	Height mm	PK	Cat. No.
10	40	16	1	9.000 304
20	50	20	1	9.000 305
40	63	25	1	9.000 306
75	80	34	1	9.000 308
95*	85	35	1	6.006 036
115	100	40	1	9.000 310
310	115	47	1	9.000 312
640	160	64	1	9.000 316
1000	200	80	1	9.000 320
2200	260	86	1	9.000 325
3400	310	110	1	9.000 330

* without DIN.



3 LLG-Evaporating basins, stainless steel

Manufactured from stainless steel as round bottom. A perfect product for heating and evaporating liquids. Can be used with direct flame in order to prevent breakage.

Capacity ml	Diam. mm	Height mm	PK	Cat. No.
50	60	30	1	6.267 376
130	80	40	1	6.267 377
250	100	50	1	6.267 378



4 Evaporating basins, 18/10 steel

18/10 steel. Cylindrical.

Bochem

Description	Capacity ml	Diam. mm	Height mm	PK	Cat. No.
Tall	125	75	35	1	9.000 460
Tall	250	85	50	1	9.000 461
Tall	500	110	55	1	9.000 462
Tall	1000	140	75	1	9.000 463
Tall	2000	160	105	1	9.000 464
Tall	5000	200	160	1	9.000 465
Shallow	50	60	20	1	9.000 470
Shallow	75	70	20	1	9.000 471
Shallow	100	80	20	1	9.000 472



5 LLG-Porcelain casserole with handle

Glazed.

Capacity ml	Diam. mm	Height mm	DIN	PK	Cat. No.
22	45	26	12907	1	7.656 131
84	67	39	12907	1	9.252 512
176	85	49	12907	1	9.252 513
270	101	51	12907	1	9.252 514
450	120	64	12907	1	9.252 515
960	150	86		1	9.252 516

1 Porcelain Crucible

To DIN 12907. Glazed inside and outside except for rim.

Haldenwanger

Capacity ml	Diam. mm	Height mm	PK	Cat. No.
80	63	36	1	9.140 113
140	80	46	1	9.140 114
290	102	58	1	9.140 115
500	127	70	1	9.140 116
1300	160	97	1	9.140 118
2600	215	110	1	9.140 119

Capacity brimful. Dimensions may vary by up to 4%.



2 Bowls, PP



VITLAB

Round, white with broad, stable edge and circumferential standing ring on the bottom.
Food-safe product according to regulation (EU) No. 10/2011.

Nominal capacity l	Ext. diam. mm	Height mm	PK	Cat. No.
0.9	160	70	1	9.301 216
1.7	200	80	1	9.301 220
2.9	240	100	1	9.301 224
4.3	280	120	1	9.301 228
6.6	320	130	1	9.301 232
9.2	360	150	1	9.301 236
13.4	400	180	1	9.301 240



3 Laboratory-bowls, 18/10 steel

With flanged rim. Polished finish.

Bochem

Capacity ml	Int. diam. mm	Height mm	PK	Cat. No.
1000	165	75	1	9.200 518
2000	220	75	1	9.200 524
3000	240	95	1	9.200 526
4500	260	120	1	9.200 529
8000	320	145	1	9.200 536
11000	380	135	1	9.200 541
14000	400	160	1	7.605 523



4 Instrument trays, melamine resin

White, melamine resin. Autoclavable (121 °C)

Width mm	Depth mm	Height mm	PK	Cat. No.
190	150	20	1	7.608 352
240	180	20	1	9.200 324
270	210	20	1	9.200 327
300	150	20	1	9.200 328
300	190	20	1	7.055 383
360	240	20	1	9.200 335
430	290	20	1	9.200 345



5 Instrument boxes, melamine resin

Melamine resin. Base section is autoclavable (121 °C).

Please order lid separately.

Width mm	Depth mm	Height mm	PK	Cat. No.
110	210	30	1	9.200 177
150	190	40	1	9.200 170
160	290	30	1	9.200 165
160	290	60	1	9.200 160
240	350	40	1	9.200 155
250	350	100	1	9.200 150



6 Lids, PS, for instrument boxes

For	PK	Cat. No.
9.200 177	1	9.200 181
9.200 170	1	9.200 182
9.200 165 and 9.200 160	1	9.200 183
9.200 155 and 9.200 150	1	9.200 184

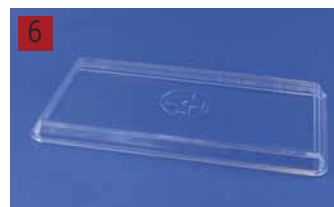

Vessels/Dishes



1 Trays and bowls, PS

Suitable for foodstuffs and general laboratory use. High impact polystyrene.

Kartell

Width mm	Depth mm	Height mm	Internal dimensions (W x D x H) mm	PK	Cat. No.
201	151	21	170 x 110 x 10	1	6.233 344
303	151	21	270 x 120 x 10	1	6.225 141
353	252	21	320 x 220 x 10	1	6.224 952
254	254	21	220 x 220 x 10	1	6.206 152
201	151	41	150 x 100 x 30	1	6.224 986
303	151	42	260 x 110 x 30	1	6.225 054
353	253	41	310 x 210 x 30	1	6.225 055
252	252	42	210 x 210 x 30	1	6.231 216
202	151	81	140 x 90 x 70	1	6.228 312
303	151	81	240 x 90 x 70	1	6.228 313
352	252	81	290 x 190 x 70	1	6.227 810
252	252	82	200 x 200 x 70	1	7.631 628
408	300	21	380 x 270 x 10	1	6.205 063
409	300	42	360 x 250 x 30	1	6.224 951
408	299	81	340 x 240 x 70	1	6.227 811



2 Trays, stainless steel

With rounded corners.

Usbeck

Width mm	Depth mm	Height mm	PK	Cat. No.
180	120	10	1	6.273 236
300	200	15	1	6.290 283
400	270	10	1	6.273 238



3 Trays, stainless steel

Remanit® 4301. With edge rim.

RSG

Width mm	Depth mm	Height mm	PK	Cat. No.
110	170	20	1	9.150 722
120	200	20	1	9.150 723
140	220	28	1	9.150 724
180	240	30	1	9.150 726
180	260	30	1	9.150 727
180	280	30	1	9.150 728
210	310	40	1	9.150 729
250	350	40	1	9.150 730
280	420	50	1	9.150 732
340	520	50	1	9.150 733



4 Instrument boxes, stainless steel 18/10

Stainless steel 18/10. Satin finish. With knob lid.

Width mm	Depth mm	Height mm	PK	Cat. No.
80	120	40	1	9.200 412
100	160	30	1	9.200 416
100	200	50	1	9.200 420
150	260	50	1	9.200 426
200	300	50	1	9.200 430
180	280	60	1	9.200 428
200	400	80	1	9.200 440
300	500	100	1	9.200 450



5 Instrument boxes, glass

Glass. With vertical walls and polished rims.

With or without stainless steel lid. Dimensions stated are nominal.

Width mm	Depth mm	Height mm	Lid	PK	Cat. No.
60	120	40	without	1	9.200 014
90	170	45	without	1	9.200 017
100	200	50	without	1	9.200 020
100	200	100	without	1	9.200 037
150	220	55	without	1	9.200 022
150	275	60	without	1	9.200 028
220	350	70	without	1	9.200 035
60	120	40	with	1	9.200 114
90	170	45	with	1	9.200 117
100	200	50	with	1	9.200 120
100	200	100	with	1	9.200 137
150	220	55	with	1	9.200 122
150	280	60	with	1	9.200 128
220	350	70	with	1	9.200 135

1. General laboratory consumables

Vessels/Dishes

1 Laboratory trays LaboPlast®, PP



White multi-purpose trays. Injection-moulded. Durable and resist flexing, with strong, rounded rim. Stackable and hygienic. Surface is easy-to-clean. Resistant to many acids and alkaline solutions. Food-safe. Temperature resistant up to +60 °C.

Internal dimensions mm	Width mm	Depth mm	Height mm	PK	Cat. No.
130 x 180	230	180	42	1	9.200 203
180 x 240	310	250	65	1	9.200 204
240 x 300	370	310	75	1	9.200 205
300 x 400	520	420	120	1	9.200 206
400 x 500	634	534	140	1	9.200 207
500 x 700	846	648	160	1	9.200 208

Bürkle



2 Tray, PP

For multi purpose use. Durable and resist to bending, with strong rounded rim. Stackable for space solving solutions, polished surface for easy cleaning. Resistant to many acids and alkaline solutions, can be used with foods.

Width mm	Depth mm	Height mm	PK	Cat. No.
127	183	50	1	6.267 362
180	255	60	1	6.267 363
245	355	70	1	6.267 364

ISOLAB



3 Photographic trays LaboPlast®, PVC, shallow form with ribs on bottom, profile shape rounded

Temperature resistant from -30 up to max. +60 °C. Trays in red or black available on request.

Base	Depth mm	Width mm	Height mm	Colour	PK	Cat. No.
140 x 190	180	230	40	white	1	9.200 220
190 x 260	240	320	50	white	1	9.200 225
260 x 320	320	370	50	white	1	9.200 232
310 x 410	370	470	60	white	1	6.076 851
420 x 510	480	580	60	white	1	7.606 129
510 x 610	590	680	70	white	1	6.235 838
140 x 190	180	230	40	red	1	6.075 030
190 x 260	240	320	50	red	1	6.050 768
260 x 320	320	370	50	red	1	6.076 823
420 x 510	480	580	60	red	1	6.085 427
510 x 610	590	680	70	red	1	6.224 327
190 x 260	240	320	50	black	1	6.079 733
260 x 320	320	370	50	black	1	6.076 824

Bürkle



4 Photographic trays LaboPlast®, PVC, shallow form without ribs on bottom, profile shape rounded

Temperature resistant from -30 up to max. +60 °C. Trays in red or black available on request.

Base	Depth mm	Width mm	Height mm	Colour	PK	Cat. No.
110 x 160	150	200	30	white	1	9.200 269
140 x 190	180	230	40	white	1	9.200 270
190 x 260	240	320	50	white	1	9.200 275
260 x 320	320	370	50	white	1	9.200 282
310 x 410	370	470	60	white	1	6.076 676
420 x 510	480	580	60	white	1	7.200 152
510 x 610	590	680	70	white	1	7.300 202
110 x 160	150	200	30	red	1	6.070 291
140 x 190	180	230	40	red	1	6.056 853
190 x 260	240	320	50	red	1	6.200 336
260 x 320	320	370	50	red	1	6.055 292
310 x 410	370	470	60	red	1	6.200 335
510 x 610	590	680	70	red	1	7.980 112
110 x 160	150	200	30	black	1	6.070 141
140 x 190	180	230	40	black	1	6.076 753
190 x 260	240	320	50	black	1	6.076 518
260 x 320	320	370	50	black	1	6.058 845
310 x 410	370	470	60	black	1	6.054 452
510 x 610	590	680	70	black	1	7.980 111

Bürkle



Vessels/Dishes

1

1

Photographic trays LaboPlast®, PVC, deep form without ribs on bottom

Temperature resistant from -30 up to max. +60 °C.
Trays in red or black available on request.

Bürkle

Base	Depth mm	Width mm	Height mm	Colour	Form	PK	Cat. No.
190 x 260	260	340	85	white	rounded	1	6.078 868
260 x 320	330	390	100	white	rounded	1	6.055 129
310 x 410	430	530	105	white	straight	1	9.200 283
420 x 510	520	610	110	white	straight	1	9.200 292
510 x 610	630	730	110	white	straight	1	9.200 297
190 x 260	260	340	85	red	rounded	1	6.084 736
260 x 320	330	390	100	red	rounded	1	6.300 788
310 x 410	430	530	105	red	straight	1	6.056 984
420 x 510	520	610	110	red	straight	1	6.302 652
510 x 610	630	730	110	red	straight	1	7.604 058
310 x 410	430	530	105	black	straight	1	6.079 789
420 x 510	520	610	110	black	straight	1	6.090 279
510 x 610	630	730	110	black	straight	1	6.057 044

2

2

Photographic trays, PVC

PVC. With ribbed base. Stackable.

Kartell

Width mm	Depth mm	Height mm	PK	Cat. No.
150	200	45	1	9.200 372
200	250	60	1	9.200 373
260	320	70	1	9.200 374
300	350	80	1	9.200 375
330	430	90	1	9.200 376
420	520	90	1	9.200 377
530	675	100	1	9.200 378
420	540	180	1	9.200 379

3

3

Photographic trays, 18/10 steel

18/10 steel. With rounded edges.

Width mm	Depth mm	Height mm	PK	Cat. No.
140	190	50	1	9.200 700
180	250	60	1	9.200 701
190	260	50	1	9.200 702
260	320	60	1	9.200 703
240	350	70	1	9.200 704
270	400	80	1	9.200 705
330	500	100	1	9.200 706

4

4

Tidy trays, PVC

PVC. With compartments. For use as drawer trays or bench tidy trays.

Kartell

Width mm	Depth mm	Height mm	Compartment- no.	PK	Cat. No.
304	404	64	5	1	9.200 370
303	403	63	12	1	9.200 380



1. General laboratory consumables

Vessels/Crucibles

1 LLG-Porcelain crucibles, low, DIN 12904

To DIN 12904. Glazed.

Form	Capacity ml	Ext. diam. mm	Height mm	PK	Cat. No.
Low form	63	60	38	1	9.250 905
Low form	91	70	44	1	9.250 906
Low form	5	30	19	5	9.250 950
Low form	10	35	22	5	9.250 951
Low form	17	40	25	5	9.250 952
Low form	21	45	28	5	9.250 953
Low form	34	50	32	5	9.250 954

1



2 LLG-Porcelain crucibles, medium, DIN 12904

To DIN 12904. Glazed.

Form	Capacity ml	Ext. diam. mm	Height mm	PK	Cat. No.
Medium	10*	30	25	1	9.250 907
Medium	120	70	56	1	9.250 915
Medium	200*	80	62	1	9.250 916
Medium	12	35	28	5	9.250 960
Medium	20	40	32	5	9.250 961
Medium	30	45	36	5	9.250 962
Medium	45	50	40	5	9.250 963
Medium	80	60	48	5	9.250 964

* Not to DIN

2



3 LLG-Porcelain crucibles, tall, DIN 12904

To DIN 12904. Glazed.

Form	Capacity ml	Ext. diam. mm	Height mm	PK	Cat. No.
Tall form	15	30	38	1	9.250 920
Tall form	26	35	44	1	9.250 921
Tall form	35	40	50	1	9.250 922
Tall form	50	45	56	1	9.250 923
Tall form	72	50	62	1	9.250 924
Tall form	130	60	75	1	9.250 925

3



4 Porcelain lids for LLG-Crucibles, DIN 12904

Glazed.

Lid diam. mm	Crucible diam. mm	DIN	PK	Cat. No.
84	80	12904	1	9.250 937
34	30	12904	5	9.250 980
39	35	12904	5	9.250 981
44	40	12904	5	9.250 982
49	45	12904	5	9.250 983
54	50	12904	5	9.250 984
64	60	12904	5	9.250 985
74	70	12904	5	9.250 986

4



5 LLG-Crucibles, stainless steel

Temperature resistant up to 500 °C.

Ext. diam. mm	Height mm	PK	Cat. No.
40	35	1	6.267 382
50	45	1	6.267 383
63	50	1	6.267 384

5



➔ Filter crucibles please see page 745.

Vessels/Crucibles



1 Crucibles, porcelain, low form

To DIN 12904. Glazed. Without lid.

Haldenwanger

Capacity ml	Ext. diam. mm	Height mm	PK	Cat. No.
8	30	20	1	9.250 030
11	35	23	1	9.250 035
20	40	26	1	9.250 040
25	45	29	1	9.250 045
40*	50	32	1	9.250 050
65	60	38	1	9.250 060
95	70	47	1	9.250 070

* Conradson crucible in accordance with ASTM D 189-65



2 Crucibles, porcelain, medium form

To DIN 12904. Glazed. Without lid.

Haldenwanger

Capacity ml	Ext. diam. mm	Height mm	PK	Cat. No.
10*	30	25	1	9.250 130
13	35	28	1	9.250 135
20	40	32	1	9.250 140
38	45	36	1	9.250 145
49	50	40	1	9.250 150
90	60	50	1	9.250 160
150	70	60	1	9.250 170
230*	82	65	1	9.250 180

* Not to DIN.



3 Crucibles, porcelain, tall form

To DIN 12904. Glazed. Without lid.

Haldenwanger

Capacity ml	Top diam. mm	Height mm	PK	Cat. No.
11	26	34	1	9.250 225
15	30	38	1	9.250 230
24	35	44	1	9.250 235
40	40	51	1	9.250 240
50	46	58	1	9.250 245
85	51	65	1	9.250 250
140	60	79	1	9.250 260



4 Lids for porcelain crucibles, DIN 12904

Haldenwanger

Lid diam. mm	Crucible diam. mm	PK	Cat. No.
28	20	1	6.005 993
33	26	1	9.250 306
37	30	1	9.250 308
45	35	1	9.250 310
49	40	1	9.250 313
54	46	1	9.250 314
64	52	1	9.250 316
76	70	1	9.250 319
89	83	1	9.250 327



5 Crucibles, AlSiN, wide form

Conical. For use up to approx. 1700 °C.
Al₂O₃ content 99.7 %.

Haldenwanger

Capacity ml	Top diam. mm	Bottom diam. mm	Height mm	PK	Cat. No.
10	30	14	24	1	9.250 389
25	41	18	37	1	9.250 390
40	48	20	41	1	9.250 391
60	54	24	50	1	9.250 392
80	60	26	50	1	9.250 393
100	66	30	56	1	9.250 394

1 Crucibles, Alsint, tall form

Conical. Max. 1700 °C.
Al₂O₃ 99.7 %.

Haldenwanger

Capacity	Top diam.	Bottom diam.	Height	PK	Cat. No.
ml	mm	mm	mm		
10	25	15	30	1	9.250 399
15	30	18	38	1	9.250 400
20	33	18	40	1	9.250 401
30	38	21	47	1	9.250 402
45	42	25	54	1	9.250 403
80	50	27	65	1	9.250 404
150	62	32	75	1	9.250 405
250	73	35	90	1	9.250 406
350	85	35	100	1	9.250 407
500	90	47	115	1	9.250 408
750	105	54	130	1	9.250 409
1200	120	62	150	1	9.250 410



2 Lids for alsint crucibles

Haldenwanger

Lid diam.	For Ø Crucible	PK	Cat. No.
mm	mm		
28	20	1	6.241 895
33	30	1	6.801 239
37	33	1	7.602 538
45	38 - 41	1	6.304 147
49	42	1	6.900 118
54	48 + 50	1	6.236 618
64	54 + 60	1	7.970 090
70	62 - 66	1	7.620 719
76	73	1	6.231 115
89	85	1	6.253 443



3 Crucibles, quartz glass, medium form

Transparent silica (Quartz glass). Medium form.

proQuarz

Capacity	Ext. diam.	Height	PK	Cat. No.
ml	mm	mm		
15	35	28	1	6.268 880
20	40	32	1	9.250 340
38	45	36	1	6.057 366
49	50	40	1	9.250 350
90	60	48	1	9.250 351
150	70	56	1	7.602 706



4 Crucibles, quartz glass, tall form

proQuarz

Capacity	Ext. diam.	Height	PK	Cat. No.
ml	mm	mm		
15	30	38	1	7.910 136
24	35	44	1	6.059 920
40	40	50	1	7.510 775
50	45	56	1	6.079 464
75	50	62	1	6.302 989
120	60	75	1	6.070 661



5 LLG-Porcelain incinerating dishes

Form	Capacity	Ext. diam.	Height	Spout	PK	Cat. No.
	ml	mm	mm			
deep	64	60	30	with	1	6.241 972
deep	64	60	30	without	1	6.242 424
low	70	81	20	without	1	7.654 046
deep	103	70	35	without	1	7.654 045



Vessels/Crucibles



1 Incinerating dishes, porcelain, flat form

Without spout. Glazed except for base exterior.

Haldenwanger

Capacity	Ext. diam.	Height	PK	Cat. No.
ml	mm	mm		
8	37	10	1	9.115 036
10	42	11	1	9.115 041
15	48	12	1	9.115 045



2 Incinerating dishes, porcelain, cylindrical form

Deep. Without spout. Glazed, except for base exterior.

Haldenwanger

Capacity	Ext. diam.	Height	PK	Cat. No.
ml	mm	mm		
15	40	21	1	9.115 140
30	50	25	1	9.115 150
60	60	31	1	9.115 160



3 Incinerating dishes, porcelain, rectangular

With vertical side walls. Glazed, except for base exterior.

Haldenwanger

Capacity	Length	Width	Height	PK	Cat. No.
ml	mm	mm	mm		
10	48	26	10	1	9.115 245
15	55	42	16	1	6.005 795
20	70	46	13	1	9.115 265
55	96	55	16	1	9.115 295



4 LLG-Porcelain incinerating boats, with loop handle

Unglazed.

Width	Depth	Height	PK	Cat. No.
mm	mm	mm		
12	40	10	1	9.250 943
13	75	8	1	9.250 940
13	85	8	1	9.250 942
13	90	8	1	6.243 229
14	105	9	1	9.250 941



5 Incinerating boats, porcelain, with loop handle

Glazed porcelain.

Haldenwanger

Width	Depth	Height	PK	Cat. No.
mm	mm	mm		
13	85	8	1	9.201 590
13	102	10	1	9.201 596



6 Magnesia trays

Width	Depth	PK	Cat. No.
mm	mm		
9	100	100	9.152 109



7 Magnesia rods

For flame tests.

Type	PK	Cat. No.
Magnesia rods	100	9.152 125

1. General laboratory consumables

Vessels/Crucibles-Tools/Spoons, Spatulas

1 Crucibles, nickel

99.6 % nickel. Wall thickness 0.5 - 2 mm.

Bochem

Please order lid separately.

Capacity ml	Ext. diam. mm	Height mm	Wall thickness mm	PK	Cat. No.
5	20	25	0.5	1	7.200 365
10	25	30	0.5	1	6.802 851
15	30	30	0.5	1	6.076 692
25	35	35	0.5	1	6.072 219
30	40	40	0.5	1	6.070 535
50	45	45	0.5	1	6.077 737
70	50	50	0.5	1	6.076 940
130	60	60	0.5	1	6.200 970
270	80	80	0.5	1	6.078 395
15	30	30	1.0	1	9.250 630
25	35	35	1.0	1	9.250 635
30	40	40	1.0	1	9.250 640
50	45	45	1.0	1	6.070 079
70	50	50	1.0	1	9.250 650
130	60	60	1.0	1	6.070 318
270	80	80	1.0	1	6.222 402



2 Lids for Crucibles, nickel

Bochem

For Crucibles	Ext. diam. mm	PK	Cat. No.
5 ml	20	1	7.200 426
10 ml	25	1	6.401 549
15 ml	30	1	9.250 660
25 ml	35	1	9.250 665
30 ml	40	1	9.250 670
50 ml	45	1	7.620 609
60 ml	60	1	6.225 682
70 ml	50	1	9.250 680
270 ml	80	1	6.801 880



➔ Note: Platinum Crucibles available on request.

3 Pharmacist's spoon, stainless steel

Remanit® 4301. Polished. Slim form. Length 150 mm.

RSG

Dimensions Spoon (L x W) mm	Length mm	PK	Cat. No.
30 x 16	150	1	9.150 060



4 Laboratory spoon, stainless steel 18/10

Bochem

Dimensions Spoon (L x W) mm	Length mm	PK	Cat. No.
45 x 31	135	1	9.150 213
55 x 38	180	1	9.150 218
60 x 45	195	1	9.150 221
85 x 70	280	1	9.150 226



5 Reagent spoons, double-ended, 18/10 steel

18/10 steel. Double ended.

Bochem

Dimensions Spoon (L x W) mm	Length mm	PK	Cat. No.
30 x 22 - 23 x 17	120	1	9.150 012
30 x 22 - 23 x 17	150	1	9.150 015
40 x 29 - 30 x 22	180	1	9.150 018
40 x 29 - 30 x 22	210	1	9.150 021
48 x 29 - 40 x 29	250	1	9.150 025
48 x 35 - 40 x 29	300	1	9.150 030



Tools/Spoons, Spatulas

1

1 Deflagrating spoon

Steel. Cup 16 mm dia. Shaft 450 mm.

Usbeck

Type	PK	Cat. No.
Deflagrating spoon	1	9.150 610

2

2 Ladle scoops, flat handle, 18/10 steel

Bochem

Capacity ml	Diam. mm	Length mm	PK	Cat. No.
90	70	185	1	9.150 665
200	90	315	1	9.150 685
220	100	315	1	9.150 700
620	140	345	1	9.150 703
1000	160	350	1	9.150 704
1400	180	350	1	9.150 705

3

3 LLG-Spoon spatulas, 18/10 steel, wide form

18/10 steel. Wide form.

Dimensions Spoon (L x W) mm	Dimensions Spatulas (L x W) mm	Length mm	PK	Cat. No.
31 x 23	30 x 20	120	1	4.008 445
38 x 27	32 x 22	150	1	9.150 810
40 x 30	35 x 25	180	1	9.150 811
40 x 30	35 x 25	210	1	9.150 812
50 x 38	45 x 32	250	1	4.008 446
55 x 45	50 x 40	300	1	4.008 447

4

4 LLG-Spoon spatulas, 18/10 steel

- One side with curved spoon
- One side with straight, triangular spatula

For	Dimensions Spoon (L x W) mm	Dimensions Spatulas (L x W) mm	Overall length mm	PK	Cat. No.
Right hander	35 x 15	25 x 13	150	1	9.150 800
Right hander	35 x 15	25 x 13	180	1	9.150 801
Right hander	35 x 15	25 x 13	210	1	9.150 802
Right hander	35 x 15	25 x 13	250	1	9.150 073
Right hander	35 x 15	25 x 13	300	1	9.150 074
Left hander	35 x 15	25 x 13	150	1	9.150 080
Left hander	35 x 15	25 x 13	180	1	9.150 081
Left hander	35 x 15	25 x 13	210	1	9.150 082

5

6.076 904

Spoon spatulas, 18/10 stainless steel

Double-ended.

Bochem

Length mm	Type	Diam. mm	Dimensions Spatulas (L x W) mm	PK	Cat. No.
130	Micro	2	10 x 5	1	6.076 904
185	Micro	2	10 x 5	1	6.077 556
210	Micro	2	12 x 5	1	6.083 942
180	Standard	3	25 x 8	1	6.077 925
210	Standard	4	25 x 12	1	6.078 270
230	Standard	4	25 x 12	1	6.057 293
325	Analyse	4	25 x 18	1	6.900 814

6

6 Spatulas, 18/10 steel, narrow form

Non-magnetic 18/10 steel. With one spoon end and one flat end.

Bochem

Dimensions Spoon (L x W) mm	Dimensions Spatulas (L x W) mm	Length mm	PK	Cat. No.
30 x 22	35 x 10	120	1	9.220 470
30 x 22	40 x 10	150	1	9.220 471
40 x 29	50 x 12	180	1	9.220 472
40 x 29	50 x 12	210	1	9.220 473
48 x 35	70 x 14	250	1	9.220 474
48 x 35	70 x 14	300	1	9.220 475

1 Spoon spatulas, deep form

18/10 steel. Deep form.

Bochem

Length mm	Dimensions Spoon (L x W) mm	Dimensions Spatulas (L x W) mm	PK	Cat. No.
120	31 x 23	30 x 20	1	9.150 312
150	38 x 27	32 x 22	1	9.150 315
180	40 x 28	32 x 22	1	9.150 318
210	40 x 28	32 x 22	1	9.150 321
250	50 x 35	45 x 32	1	9.150 325
300	55 x 41	50 x 37	1	9.150 330

1



2 Spoon spatulas, stainless steel

Remanit® 4301. Polished. With one open spoon and one tapered flat end.
Length 200 mm.

RSG

Length mm	PK	Cat. No.
200	1	9.150 050

2



3 Spoon spatulas, Remanit® 4301

Polished. Stem 5 mm diameter. Spoon 15 x 35 mm.

RSG

Length mm	For	PK	Cat. No.
150	Right handed user	1	9.150 070
180	Right handed user	1	9.150 071
210	Right handed user	1	9.150 072

3



4 Spoon spatulas, porcelain

Glazed.

Haldenwanger

Dimensions Spoon (L x W) mm	Dimensions Spatulas (L x W) mm	Length mm	PK	Cat. No.
36 x 11	33 x 10	121	1	9.220 812
45 x 20	42 x 21	170	1	9.220 816
54 x 30	48 x 25	210	1	9.220 820
131 x 42	56 x 39	305	1	9.220 830

4



5 Powder spoon, 18/10-steel

18/10 steel. Narrow form.

Bochem

Dimensions Spoon (L x W) mm	Length mm	PK	Cat. No.
40 x 10	170	1	9.150 620

5



6 Micro spoon spatulas, 18/10 steel

With one flat end and one micro spoon end

Bochem

Length mm	Dimensions Spoon (L x W) mm	PK	Cat. No.
150	9 x 5	1	9.150 565
180	9 x 5	1	6.076 279
150	7 x 5	1	7.200 220
150	6 x 4	1	6.076 691
150	5 x 3	1	6.060 324
200	9 x 5	1	9.150 570
150	9 x 5	1	6.077 689
151	9 x 5	1	6.401 212

6



Tools/Spoons, Spatulas

1

9.220 313

Micro Spatulas, 18/10 steel

Bochem

Description	Width mm	Length mm	PK	Cat. No.
One-sided, round, bent	5	130	1	9.220 313
One-sided, round, bent	5	185	1	9.220 318
One-sided, round, bent	5	210	1	9.220 321
One-sided, round, bent	8	180	1	6.801 774
One-sided, round, bent	12	210	1	6.205 584
Double-sided, round, bent	5	130	1	9.220 363
Double-sided, round, bent	5	185	1	9.220 368
Double-sided, round, bent	5	210	1	9.220 371
Double-sided, round, bent	7	150	1	6.077 825
Double-sided, round, bent	7	200	1	6.077 767
Double-sided, round, bent	7	250	1	6.078 290
Double-sided, round, bent	7	180	1	6.077 179
Double-sided, round, bent	12	210	1	6.307 145

2

9.220 363

3

3 Micro double-ended spatulas, 18/10 steel

Stainless steel with one end having a flat spatula and the other end having a flat spatula with rounded edges.

Bochem

Spatula width mm	Length mm	PK	Cat. No.
2	100	1	6.076 838
2	130	1	6.053 239
2	150	1	6.060 303
3	100	1	9.220 210
3	130	1	9.220 213
3	150	1	6.070 797
4	100	1	6.072 631
4	130	1	6.060 304
4	150	1	6.076 543
4	185	1	6.075 892
5	100	1	6.060 305
5	130	1	9.220 216
5	150	1	9.220 215
5	185	1	9.220 218
5	210	1	9.220 221
6	150	1	6.070 485
6	185	1	6.075 894
6	210	1	6.077 279
9	150	1	7.980 952
9	185	1	6.072 130
9	210	1	6.701 453

4

4 Micro spoons

With wire end. For right-handers.

Hammacher

Length mm	PK	Cat. No.
180	1	6.312 443

5

5 Micro spoon spatulas, 18/10 steel

Excellent grade polished stainless steel with one end having a flat spatula and the other end having a micro spoon.

ISOLAB

Length mm	PK	Cat. No.
150	1	9.150 820
180	1	4.008 451
210	1	6.267 816

6

6 Micro powder spatula, stainless steel

Remanit® 4301. Polished. Very flexible.

RSG

Width mm	Length mm	PK	Cat. No.
3	150	1	6.239 195
3	210	1	9.220 205
4	130	1	9.220 206
4	150	1	9.220 207
4	185	1	9.220 208
5	150	1	6.231 957
6	130	1	9.220 201
6	150	1	9.220 202
6	185	1	9.220 203
6	210	1	9.220 204
7	150	1	6.226 081

1. General laboratory consumables

Tools/Spoons, Spatulas

1 2 Double-ended spatulas, 18/10 steel

18/10 steel. With one end having a flat spatula and the other end having a flat spatula with rounded edges.

Bochem

Type	Spatula width mm	Length mm	PK	Cat. No.
Straight	9	130	1	9.220 013
Straight	9	150	1	9.220 015
Straight	9	185	1	9.220 018
Straight	11	210	1	9.220 021
Straight	11	250	1	9.220 025
Straight	16	300	1	9.220 030
Straight	16	350	1	6.073 375
Straight	16	400	1	6.051 013
Straight	20	500	1	6.072 630
Bent	9	130	1	9.220 113
Bent	9	150	1	9.220 115
Bent	9	185	1	9.220 118
Bent	11	210	1	9.220 121
Bent	11	250	1	9.220 125
Bent	16	300	1	9.220 130



3 Double ended spatulas, 18/10 steel

18/10 steel. Narrow form.

ISOLAB

Type	Length mm	PK	Cat. No.
straight	130	1	4.008 454
straight	155	1	4.008 455
straight	180	1	4.008 456
straight	210	1	4.008 457
straight	255	1	4.008 458
straight	300	1	4.008 459
curved	150	1	6.267 385
curved	180	1	6.267 386
curved	210	1	6.267 387



4 Double ended spatulas chattaway, 18/10 steel

Polished stainless steel with one end flat and the other with a bent flat end.

ISOLAB

Spatula width mm	Length mm	PK	Cat. No.
9	100	1	4.008 452
9	130	1	4.008 453
9	150	1	9.150 815
9	180	1	9.150 816
9	210	1	9.150 817



5 Spatulas, round grooved, 18/10 steel

Polished, round grooved.

ISOLAB

Length mm	Spatula width mm	PK	Cat. No.
150	9	1	4.008 448
185	9	1	4.008 449
210	9	1	4.008 450

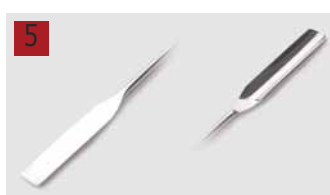

6 Spatula with knob, 18/10 steel

Drop-forged 18/10 steel. With one flat end and one knob end.

Bochem

Width mm	Length mm	Length Flat end mm	PK	Cat. No.
9	150	60	1	9.220 415
11	210	70	1	9.220 421
16	300	75	1	9.220 430



7 Vibro spatula

Teflon-coated vibration scoop with acid-proof plastic handle. Extra thin working part for fine dosing.

Hammacher

Length mm	PK	Cat. No.
220	1	6.265 732



Tools/Spoons, Spatulas

1

1 Pharmacist's spatula

Stainless steel 4310. With durofol handle. Flexible blade.

Blade width mm	Blade length mm	Length mm	PK	Cat. No.
14	75	165	1	9.220 490
18	100	190	1	9.220 491
20	130	230	1	9.220 492
22	150	250	1	9.220 493
32	200	310	1	9.220 495

2

2 Spatulas with wooden handle, stainless steel

Flexible, long blade as outlined below.

Bochem

Blade width mm	Blade length mm	Length mm	PK	Cat. No.
14	75	165	1	9.220 607
18	100	190	1	9.220 610
20	130	230	1	9.220 613
22	150	250	1	9.220 615
27	165	275	1	9.220 616
32	200	310	1	9.220 620
38	250	365	1	9.220 625
42	300	415	1	9.220 630

3

3 Spatula/section lifter, 18/10 steel

18/10 steel. With wooden handle. Short, flexible blade.

Bochem

Blade width mm	Blade length mm	Length mm	PK	Cat. No.
10	50	150	1	9.220 510
15	50	150	1	9.220 515

4

4 Sampling spoon, PP

Bel-Art Products

Length 178 mm. Long handle reaches easily into jars, bottles and other confined areas; minimizes the potential of personal contact with sampled material. Safe for food, drug and cosmetic contact. Autoclavable.

Capacity ml	Width mm	PK	Cat. No.
1.25	20	1	9.150 643
2.46	25	1	9.150 644
4.93	30	1	9.150 645
14.79	40	1	9.150 646

5

5 Disposable spoons LaboPlast®/SteriPlast®, PS

Bürkle

White. The spoons are ideal for sampling powders, granules and pastes.

- Individually packed
- SteriPlast® additionally gamma-sterilized
- Production, assembly and packaging acc. to Cleanroom class 7 (10000)
- According to EU food and FDA guidelines

Type	Sterile	Capacity ml	Length mm	PK	Cat. No.
LaboPlast®	-	2.5	127	100	6.265 033
LaboPlast®	-	10	170	100	6.265 034
SteriPlast®	+	2.5	127	100	6.265 045
SteriPlast®	+	10	170	100	6.265 046

1. General laboratory consumables

Tools/Spoons, Spatulas

1 Disposable spoons LaboPlast® Bio/SteriPlast® Bio, Green PE



White. The spoons are ideal for sampling powders, granules and pastes. The LaboPlast® Bio/SteriPlast® Bio products are entirely made of renewable resources. Not only with regard to quality but also with regard to its characteristics for high-quality sampling, it is perfectly comparable with conventional polyethylene.

- Individually packed in organic PE foil
- SteriPlast® Bio additionally gamma-sterilized
- Production and packaging acc. to Cleanroom class 7 (10000)
- According to EU food and FDA guideline

Type	Sterile	Capacity ml	Length mm	PK	Cat. No.
LaboPlast® Bio	-	2.5	127	100	6.265 059
LaboPlast® Bio	-	10	170	100	6.265 060
SteriPlast® Bio	+	2.5	127	100	6.265 053
SteriPlast® Bio	+	10	170	100	6.265 054

Bürkle



2 Disposable spoons for foodstuffs SteriPlast®, PS



Blue. The spoon for foodstuffs is available in two sizes, 2.5 ml (similar to a teaspoon) and 10 ml (similar to a tablespoon), and is ideal for sampling powders, granulates, pastes and fluids. The shade of blue that is used does not occur in a natural form in foodstuffs. Because of this, the spoons or parts of them can be quickly found and easily identified in a visual check if they are ever mixed into production. The detectable spoons have a special additive in the material that makes them visible to metal detectors or X rays. They can therefore be rejected with standard systems for checking for foreign objects, even though they are made of plastic.

- Individually packed, gamma-sterilized
- Production, assembly and packaging according to clean room class 7 (10000)
- According to EU food and FDA guidelines

Description	Capacity ml	Length mm	PK	Cat. No.
visual identification	2.5	127	100	6.284 560
visual identification	10	170	100	6.284 561
detectable	2.5	127	100	6.284 571
detectable	10	170	100	6.284 572

Bürkle



3 Disposable dosing spoon, PS



White. With the dosing spoons, small quantities of powders, granulates and liquids can be precisely measured and dosed. Excess medium is wiped off at the top edge of the spoon for precise measurement. The volume is stamped on the handle. Dosing spoon set with 8 spoons (0.5/1.0/2.5/5.0/10/15/25 und 50 ml)

- With wiping edge
- Cleanroom manufactured (cleanroom class 7)
- Food-safe

Type	Nominal capacity ml	Sterile	PK	Cat. No.
Disposable dosing spoon	0.5	-	100	4.670 771
Disposable dosing spoon	0.5	+	100	4.670 772
Disposable dosing spoon	1.0	-	100	4.670 773
Disposable dosing spoon	1.0	+	100	4.670 774
Disposable dosing spoon	2.5	-	100	4.670 775
Disposable dosing spoon	2.5	+	100	4.670 776
Disposable dosing spoon	5.0	-	100	4.670 777
Disposable dosing spoon	5.0	+	100	4.670 778
Disposable dosing spoon	10.0	-	100	4.670 779
Disposable dosing spoon	10.0	+	100	4.670 780
Disposable dosing spoon	15.0	-	100	4.670 781
Disposable dosing spoon	15.0	+	100	4.670 782
Disposable dosing spoon	25.0	-	100	4.670 783
Disposable dosing spoon	25.0	+	100	4.670 784
Disposable dosing spoon	50.0	-	100	4.670 785
Disposable dosing spoon	50.0	+	100	4.670 786
Dosing spoon set *		-	1	4.670 787

* Reusable/not for cleanrooms

Bürkle



Tools/Spoons, Spatulas

1

1

Disposable measuring spoon, PS and disposable measuring spoon, PS, detectable

Bürkle



Blue. With the measuring spoons, small quantities of powders, granulates and liquids can be precisely measured and dosed. Excess medium is wiped off at the top edge of the spoon for precise measurement. The volume is stamped on the handle. The flat bottom allows the measuring spoon to be placed without spilling the contents. The blue products, or parts of them, can be quickly found and easily identified in a visual check, if they are ever mixed into production. Measuring spoon set with 8 spoons (0.5/1.0/2.5/5.0/10/15/25 und 50 ml).

Disposable measuring spoon, detectable: In addition to the blue colour, these products have a special additive in the material that makes them visible to metal detectors or X rays. They can therefore be rejected with standard systems for checking for foreign objects.

- With wiping edge
- Cleanroom manufactured (cleanroom class 7)
- Food-safe

Type	Nominal capacity ml	Sterile	PK	Cat. No.
Disposable measuring spoon	0.5	-	100	4.670 788
Disposable measuring spoon	0.5	+	100	4.670 789
Disposable measuring spoon	1.0	-	100	4.670 790
Disposable measuring spoon	1.0	+	100	4.670 791
Disposable measuring spoon	2.5	-	100	4.670 792
Disposable measuring spoon	2.5	+	100	4.670 793
Disposable measuring spoon	5.0	-	100	4.670 794
Disposable measuring spoon	5.0	+	100	4.670 795
Disposable measuring spoon	10.0	-	100	4.670 796
Disposable measuring spoon	10.0	+	100	4.670 797
Disposable measuring spoon	15.0	-	100	4.670 798
Disposable measuring spoon	15.0	+	100	4.670 799
Disposable measuring spoon	25.0	-	100	4.670 800
Disposable measuring spoon	25.0	+	100	4.670 801
Disposable measuring spoon	50.0	-	100	4.670 802
Disposable measuring spoon	50.0	+	100	4.670 803
Disposable measuring spoon, detectable	0.5	+	100	4.670 805
Disposable measuring spoon, detectable	1.0	+	100	4.670 806
Disposable measuring spoon, detectable	2.5	+	100	4.670 807
Disposable measuring spoon, detectable	5.0	+	100	4.670 808
Disposable measuring spoon, detectable	10.0	+	100	4.670 809
Disposable measuring spoon, detectable	15.0	+	100	4.670 810
Disposable measuring spoon, detectable	25.0	+	100	4.670 811
Disposable measuring spoon, detectable	50.0	+	100	4.670 812
Measuring spoon set *		-	1	4.670 804

* Reusable/not for cleanrooms

2

2

LLG-Macro Spoon Spatula, PP



Consists of a spoon on one side which allows easy transfer of sample, while the other end is a flat construction with a knife edge which can be used to draw salt or breaking crystals.

Length mm	Colour	PK	Cat. No.
150	blue	25	4.664 539
180	blue	25	4.664 540
210	blue	25	4.664 541



1. General laboratory consumables

Tools/Spoons, Spatulas

1 Disposable spoon spatula LaboPlast®/SteriPlast®, PS



Bürkle

White. The spoon spatula is a double spatula with a 0.5 ml spoon and a 17 mm spoon blade. The spoon spatula has many different uses in labs, as a sampling spoon, for measuring or transferring small amounts, as a scraper or for mixing and stirring. Specially designed for disposable use, resistant to chemicals and corrosion-proof.

- SteriPlast®: Individually packed, additionally gamma-sterilized
- Production, assembly and packaging according to Cleanroom class 7 (10000)
- According to EU food and FDA guidelines

Type	Sterile	Length mm	PK	Cat. No.
LaboPlast®	-	178	100	6.284 543
SteriPlast®	+	178	100	6.284 544



2 Disposable double scoop spatula LaboPlast®/SteriPlast®, PS



Bürkle

White. Double scoop spatula with rounded ends. Content 1.0 and 0.25 ml, spatula width 11 mm on one side and 5.7 on the other side. The micro spatula can be used to sample, transfer or process small amounts of chemicals, powders, granulates, pastes, creams or liquids. The sturdy and convenient centre handle facilitates precise work.

- SteriPlast®: Individually packed, additionally gamma-sterilized
- Production, assembly and packaging according to Cleanroom class 7 (10000)
- According to EU food and FDA guidelines

Type	Sterile	Length mm	PK	Cat. No.
LaboPlast®	-	180	100	6.284 545
SteriPlast®	+	180	100	6.284 546



3 Spatulas, PS

Impact resistant polystyrol. Available as double-ended flat spatula or one end flat and the other with spoon.

BRAND

Type	Length mm	PK	Cat. No.
Double-ended	150	1	9.220 850
Double-ended	180	1	9.220 851
With spoon	180	1	9.220 852
With spoon	210	1	9.220 853



4 5 Powder spatula smartSPATULAS®, PP



Heathrow Scientific

Single use polypropylene lab tools reduce costly contamination errors.

- Size related designs to fit perfectly with standard 0.2, 1.5/2.0, 15 and 50 mL tubes
- Ideal for dispensing or sample collection of powders or soft solids
- Shatter-resistant in liquid nitrogen, resistant to diluted acids and bases, and can be used with hot liquids
- Anti-static, sterile and Eco-friendly versions available
- Autoclavable and complies with FDA standards for food contact

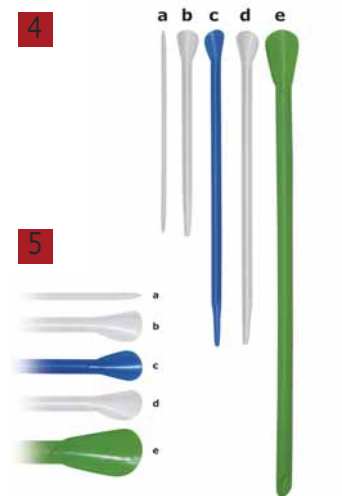

For tubes ml	Description	Colour	Diam. mm	Length mm	Figure	PK	Cat. No.
0.2	Micro Antistatic	Natural	3.5	140	a	300	6.256 896
15/1.5/2.0	Eco	Natural	7.0	140	b	300	6.256 894
15/1.5/2.0	Standard	Blue	7.0	210	c	300	6.256 893
15/1.5/2.0	Standard	Natural	7.0	210	d	300	6.256 895
15/1.5/2.0	Standard sterile	Natural	7.0	210	d	100	6.256 898
50	Macro	Green	1.0	310	e	150	6.256 897

Tools/Spoons, Spatulas



1 Glass fiber spatulas, nylon

Kartell



Glass fibre nylon. Made according to DIN 12890. Excellent chemical resistance. Scraper plus spoon or double scraper configuration. Suitable for use in food and beverage industry. Autoclavable. Suitable for food-safe. (NSF/ANSI STANDARD 51).

Length mm	Type	PK	Cat. No.
150	Flat ends	1	6.223 119
180	Flat ends	1	7.200 745
180	Spoon ends	1	7.605 126
210	Spoon ends	1	7.630 978



2 Tongue depressors, wooden

Wooden.

Length mm	PK	Cat. No.
150	100	9.165 101



3 Laboratory spatula, PC

Polycarbonate, crystal clear.

Width mm	Length mm	Weight g	PK	Cat. No.
20	145	18	1	9.220 841



4 Disposable scraper LaboPlast®/SteriPlast®, PS

Bürkle



White. The sturdy and convenient scrapers are suitable for scraping off, smoothing or cleaning as well as removing residue.

- SteriPlast®: Individually packaged, additionally gamma-sterilized
- Production, assembly and packaging according to Cleanroom class 7 (10000)
- According to EU food and FDA guidelines

Type	Width mm	Length mm	Sterile	PK	Cat. No.
LaboPlast®	80	200	-	10	6.284 547
SteriPlast®	80	200	+	10	6.284 548



5 Disposable scraper for foodstuffs SteriPlast®, PS

Bürkle



Blue. Sturdy and convenient scraper for disposable use. The scraper is suitable for scraping off, smoothing or cleaning as well as removing residue. The shade of blue that is used does not occur in a natural form in foodstuffs. Because of this, the scrapers or parts of them can be quickly found and easily identified in a visual check if they are ever mixed into production. The detectable scrapers have a special additive in the material that makes them visible to metal detectors or X rays. They can therefore be rejected with standard systems for checking for foreign objects, even though they are made of plastic.

- Individually packaged, gamma-sterilized
- Production, assembly and packaging according to Cleanroom class 7 (10000)
- According to EU food and FDA guideline

Description	Width mm	Length mm	PK	Cat. No.
visual identification	80	200	10	6.284 562
detectable	80	200	10	6.284 573

1. General laboratory consumables

Tools/Spoons, Spatulas

1 Chemist's small instrument set, 5 pieces

- 1 x micro-powder-spatula, flexible, 150 mm long
- 1 x spatula, double-ended, flexible, 150 mm long
- 1 pair of scissors, sharp/sharp, straight, 140 mm
- 1 x spoon spatula, 150 mm, 32 x 22 mm (blade L x W)
- 1 pair of thumb forceps, simple type, 130 mm long

Hammacher

Type	PK	Cat. No.
HSO 125-00	1	9.160 004

1



2 Chemist's large instrument set, 9-piece

- Large, 9-piece set, containing:
- Micro-spatula, double ended, flexible, 130 mm long
- Micro-spoon spatula, spoon 5 x 7 mm, 150 mm long
- Micro-powder spatula, double ended, flexible, 185 mm long
- Weighing scoop, 10 x 40 mm W x L, 170 mm long

- Scissors, straight, serrated, 170 mm long
- Poly-spoon, 180 mm long
- Spatula, double ended, non-flexible, 185 mm long
- Spatula, wide type, both ends round, 150 mm long
- Forceps, sharp, simple type, 160 mm

Hammacher

Type	PK	Cat. No.
HSO 126-00	1	9.160 010

2



3 Chemist's large instrument set, 13-pieces

- In zipper case, instruments attached with loops.
- Containing:
- 2 Micro-double spatula, flexible, 150 mm
- Spoon spatula, 150 mm
- Micro-spatula, 150 mm, spoon 5 x 7 mm
- Weighing spatula, 170 mm
- Micro-powder spatula, flexible, 150 mm
- Dissecting needle with plastic handle, 140 mm
- Pharmacist spoon, 150 mm
- Splinter forceps, curved, 105 mm
- Forceps, anatomical, 145 mm
- Forceps, pointed, 105 mm
- Scissors, pointed/pointed, 145 mm
- Microscope scissors, 115 mm

Hammacher

Type	PK	Cat. No.
HSO 131-00	1	6.312 441

NEW

3



4 Spatula set, 14-pieces

- In zipper case, spatula attached with loops.
- Containing:
- 2 Spoon spatula, 150 mm, 180 mm
- 3 Micro-spatula, spoon 5 x 7 mm, 100, 150, 185 mm
- 3 Double spatula, rigid, 130, 150, 185 mm
- Micro-powder spatula, flexible, 150 mm
- Pharmacist spoon, double-ended, 170 mm
- Chemical spoon, double-sided, 150 mm
- Weighing spatula, 170 mm
- 2 Micro-double spatula, spoon-shaped, 130, 150 mm

Hammacher

Type	PK	Cat. No.
HSO 132-00	1	6.312 442

NEW

4



5 Spatula set, stainless steel, 7 pieces

- Remanit® 4301.
- 7 pieces:
- 1 x pair of forceps, blunt, straight, 145 mm
- 1 x micro spoon-spatula 150/5 mm
- 1 x micro spoon-spatula 150/7 mm
- 1 x double spatula 150/9 mm
- 1 x powder spatula 150/9 mm
- 1 x micro powder spatula 150/4 mm
- 1 x micro double spatula 150/4 mm

RSG

In bag with push button. Made in Germany.

Type	PK	Cat. No.
Spatula set	1	7.630 153

5



Tools/Spoons, Spatulas-Knives, Scissors



1 Stirring rods, Soda-lime glass

Soda-lime glass. With flame-polished ends.

Ext. diam. mm	Length mm	PK	Cat. No.
3	200	10	9.197 403
4	150	10	9.197 404
4	200	10	9.197 405
5	150	10	9.197 406
5	200	10	9.197 407
6	150	10	9.197 408
6	200	10	9.197 424
6	250	10	9.197 426
7	300	10	9.197 431
8	300	10	9.197 433
9	300	10	9.197 435



2 Stirring rods, PVC

Rigid, light and unbreakable. The ideal replacement for glass rods.

Kartell

Diam. mm	Length mm	PK	Cat. No.
7.15	250	1	6.204 737
7.15	300	1	6.231 934
7.15	350	1	6.206 755

Universal scissors, stainless steel, plastic handle

All purpose scissors for use in the office and at home. Produced from stainless steel. Sharp blades for accurate cutting. Ergonomic designed handles made from ABS material feature soft-grip insert. Supplied on try-me card.

Colour: black/red

- stainless steel, polished
- special grinding for precise cuts
- ergonomic handles

Form	Length mm	PK	Cat. No.
Straight	140	1	9.160 651 3
Sharp	160	1	9.160 652 4
Straight	210	1	9.160 653 5
Straight	255	1	9.160 654 6



9.160 651



9.160 652



9.160 653



9.160 654



7 Heavy Duty Scissor, stainless steel, black

Stainless steel blades and large comfortable black ABS handles. Suitable for cutting tougher materials. Features integral groove center for opening corks from bottles, nutcracker, bottle opener, etc. Supplied on try-me card.

Description	Length mm	PK	Cat. No.
Universal scissor	215	1	9.160 655

1. General laboratory consumables

Tools/Knives, Scissors

1 LLG-Scissors general purpose, stainless steel

Excellent grade polished stainless steel with straight form and close shanks.

- Available as 3 types:
- sharp/sharp points
 - blunt/blunt points
 - sharp/blunt points

Form	Length mm	PK	Cat. No.
sharp - sharp	130	1	6.237 703
sharp - sharp	160	1	9.204 231
blunt - sharp	130	1	9.204 232
blunt - sharp	160	1	9.204 233
blunt - blunt	130	1	9.204 234
blunt - blunt	160	1	9.204 235



2 Scissors dissecting, stainless steel

Excellent grade polished stainless steel with fine sharps points and close shanks.

ISOLAB

- Available as 2 types:
- straight body form
 - curved body form

Form	Length mm	PK	Cat. No.
Straight body form	130	1	6.236 264
Curved body form	130	1	9.204 222



Scissors, stainless steel

Made of Inox, Swiss made, high quality finish, suitable for medical purposes.

Ideal-tek

Form	Length mm	PK	Cat. No.
Curved body form (miniature work), extra fine, sharp - sharp	90	1	6.280 910
Straight body form (miniature work), extra fine, sharp - sharp	90	1	4.668 556
Curved body form, extra fine, sharp - sharp	90	1	6.280 911
Straight body form, extra fine, sharp - sharp	90	1	4.668 573
Curved body form, round, strong, sharp - sharp	90	1	6.280 912
Curved body form, extra fine, strong, sharp - sharp	90	1	6.280 913
Straight body form, blunt - blunt	90	1	6.280 914

3



6.280 910

4



6.280 912

5



6.280 913

6



6.280 914

Fine surgical scissors

Stainless. Closed shanks with fine points as indicated.

Hammacher

Form	Length mm	PK	Cat. No.
Straight	140	1	9.160 602
Curved	140	1	9.160 603



9.160 602



9.160 603

Tools/Knives, Scissors

1



4.668 574

Surgical scissors, stainless steel

Ideal-tek

2



4.668 576

Form	Length mm	PK	Cat. No.
Straight	115	1	4.668 574
Straight	130	1	4.668 575
Straight, blunt	145	1	4.668 576
Straight, blunt	165	1	4.668 577
Straight, blunt	185	1	4.668 578
Straight	200	1	4.668 579

3



3 Surgical scissors, stainless steel

Straight, closed shanks. Point/blunt.

Length mm	PK	Cat. No.
130	1	9.204 220

4



4 Surgical scissors, sharp points, stainless steel

Fine-polished finish.
Closed shanks with fine sharp points, curved or straight, as outlined below.

Form	Length mm	PK	Cat. No.
Straight	105	1	9.204 206
Curved	105	1	9.204 207

5



5 LLG-Universal slicer

Heavy duty scissor for cutting almost all material even also thin layers of steel. Cutting blade is manufactured from high quality hardened stainless steel. Spring supported ergonomic plastic handle with safety lock offers easy and secure use.

Length mm	PK	Cat. No.
185	1	6.267 394

6



6 Universal slicer

Stainless steel. Sturdy with plastic coated handle. Persistard metal handle (inside).

Bochem

Blade length mm	Length mm	PK	Cat. No.
40	190	1	9.204 332

7



9.160 656

LLG-All-round Cutter with rubber grip

An easy and comfortable handling is ensured by the ergonomically shaped grip. The break-off device is integrated into the grip section of the ABS plastic casing. Comes with a metal blade guide and auto-lock system. Both cutters will be delivered on blister cards including 2 spare cutting blades.

8



9.160 657

Type	PK	Cat. No.
LLG-All-round Cutter 18 mm	1	9.160 656
LLG-All-round Cutter 9 mm	1	9.160 657
Replacement blade for LLG-All-round Cutter 18 mm	10	9.160 658
Replacement blade for LLG-All-round Cutter 9 mm	10	9.160 659

1. General laboratory consumables

Tools/Knives, Scissors

Cutter edding M 9

Small, handy pocket sized model with plastic handle and clip. With retractable blade and slotted cover for breaking off the blades safely. 13 break-off blades per knife. Barrel colour black. Replacement blades available.



9.156 027

Type	PK	Cat. No.
Cutter	1	9.156 027
Spare blade for M 9	10	9.156 030



9.156 030

Apollo blades

High-quality Swedish alloy steel. Standard quality.

Type	Width mm	Thickness mm	Height mm	PK	Cat. No.
Bail blades with handle	39	0.25	19	100	6.322 097
Bail blades with handle (20 x 5)	39	0.25	19	100	7.930 281
Bail blades with handle	57	0.28	25	5	6.800 353
Apollo Ever-Sharp-Blades	39	0.30	19	5	9.156 110



6.322 097



6.800 353



9.156 110

6 Trapezoid Ceramic Blades CERA-Safeline®

Box of 3 blades on blister card.

Advantage of ceramic blades:

- stays sharp 10x longer than steel
- safer than metal blades
- rust-free, no oil layer
- acid-proof, chemically neutral
- spark-free, non-conductive, non-magnetic

Dimensions mm	PK	Cat. No.
58 x 19	3	6.275 353



7 Cutting board, PE

HACCP conform cutting board.

- Suitable for dish washer
- Heat resistant up to 90 °C

Colour	Width mm	Depth mm	Height mm	PK	Cat. No.
White	610	460	25	1	4.666 015
Blue	610	460	25	1	6.312 665



8 LLG-Multi-purpose tool

Blue anodised housing with stainless steel screws. Specifications: Needlenose Pliers, Wire Cutters, Wire Stripper, Knife, Saw Knife, Saw, Screwdriver, Crosshead Screwdriver, Bottle/Can Opener, File. Supplied completely with Nylon Belt Pouch. Dimensions: 100 x 45 x 20 mm

Type	Weight g	PK	Cat. No.
LLG-Multi-purpose tool	230	1	9.160 000



Tools/Knives, Scissors-Workshop tools

1

1 Leatherman® Wingman Multi-Tool, Stainless Steel

Tools: Spring-action Needlenose Pliers, Spring-action Regular Pliers, Spring-action Wire, Cutters, 420HC Combo Knife, Package Opener, Wood/Metal File, thomann Scissors, Small Screwdriver, Medium Screwdriver, Phillips Screwdriver, Ruler (1.5 in), Bottle Opener, Can Opener, Wire Stripper, Features: Removeable Pocket Clip.

Weight g	Length mm	PK	Cat. No.
198	97	1	4.665 763

2

2 Glass markers, diamond-tipped

Writing diamond for writing on glass. Available as a pen with retractable tip or mounted on a wooden handle.

Type	Size	PK	Cat. No.
With wooden grip	1	1	9.032 920
With wooden grip	3	1	6.242 878
With wooden grip	5	1	6.242 879
Pen type	1	1	9.032 930

3

3 Glascribe® Pen

Mark laboratory glassware with the Glascribe® Pen with retractable tungsten carbide tip (Mohs Hardness = 9). It easily inscribes on glass, ceramics, and plastic. The pen has a pocket clip so it is always handy when needed.

Bel-Art Products

Type	PK	Cat. No.
Glascribe® pen	1	9.032 932

4

4 Glass tubing cutter

For glass tubing up to 30 mm Ø. With interchangeable hard metal wheel.

Usbeck

Type	PK	Cat. No.
Glass tubing cutter	1	9.110 510
Replacement roller	1	9.110 511

5

5 Glass cutting knife

With interchangeable blades made of metal. Length: 185 mm. With plastic handle.

Usbeck

Type	PK	Cat. No.
Glass cutting knife	1	9.110 500
Replacement blade	1	9.110 501

6

6 Hammer

DIN 1041, steel-forged hammer head, double bracketed with ash handle.

Weight g	PK	Cat. No.
300	1	9.306 127

7

7 Vernier calliper gauge, digital

Stainless steel, with 5 digit LCD display. Accuracy ± 0.03 mm, resolution 0.01 mm. Switchable between metric/imperial. 3V CR2032 lithium battery not included.

Bochem

Type	Length mm	PK	Cat. No.
Digital	150	1	9.204 610

1. General laboratory consumables

Tools/Workshop tools

1 Laboratory tool box

12 piece ring/open end spanner set: 1 piece each in sizes 6 mm to 15 mm, 17 mm and 19 mm.
 Knipex 180 mm combination pliers. Knipex 240 mm water pump pliers.
 FLEX-DOT screwdriver set: 1 slotted screwdriver each in sizes 8.0 x 1.2 mm - 5.5 x 1.0 mm and 3.0 x 0.5 mm.
 1 Phillips screwdriver, size 2. Including two stubby screwdrivers: 1 size 2 Phillips screwdriver and 1 slotted screwdriver 5.5 x 1.0 mm. Automotive light tester with cable and crocodile clip (for automotive electrical systems only).

Sockets, sizes 8 mm - 10 mm - 12 mm - 13 mm - 14 mm - 15 mm - 17 mm - 19 mm - 22 mm and 24 mm.
 Reversible ratchet. Universal joint. 1 each 125 mm and 250 mm extensions. Long T-handle with slide (for loosening wheel nuts). Special 16 mm and 21 mm spark plug sockets with ball head on longer side. Pocket Allen key set (8 piece set) from 1.5 - 8.0 mm. PROXXON ball-peen hammer (300 g), ground on all sides and partially polished.
 With inseparable graphite handle (fibre-glass reinforced, non-slip soft coating in grip area) for unparalleled vibration damping.

Type	PK	Cat. No.
PROXXON 23650	1	9.306 125



2 Screwdriver set

Hardened, chrome vanadium molybdenum steel. With impact-resistant, cadmium-free, plastic handles.
 Insulated in accordance with VDE 0680/2, 1000V, 7 screwdrivers.

4 VDE screwdriver: 2.5 x 80/3.5 x 100/4 x 100/5.5 x 125 mm
 2 VDE Phillips screwdriver: PH1 x 80/PH2 x 100 mm
 1 Voltage detector

Type	PK	Cat. No.
Wera 160i/7	1	9.306 107



3 Electronics screwdriver set with rack

6-piece screwdriver set consisting of:
 4 flat screwdrivers: 2.5 mm/3.0 mm/3.5 mm/4.0 mm
 2 PH screwdrivers: Size 0 and 1

Type	PK	Cat. No.
Electronics screwdriver set with rack	1	9.210 143



4 Side cutting pliers

Type 7001. DIN 5238 B. ISO 5749. For hard and soft wire. Inductively hardened precision cutting edges.
 Cutting hardness approx. 62 HRC. Plastic coated handles.

Length mm	PK	Cat. No.
180	1	9.306 111



5 Water pump pliers

Chrome vanadium steel. Form D. With locking groove and glide adjustment. Inductively hardened toothed grips.
 6 position jaw opening.

Length mm	PK	Cat. No.
250	1	9.306 115



6 Combination pliers

Tool steel. Light design. DIN ISO 6746. For cutting hard and soft wire. Long cutting edges for thicker cable.
 Inductively hardened cutting edges. Cutting hardness 60 HRC. Plastic coated handle grips.

Length mm	PK	Cat. No.
180	1	9.306 117



Tools/Workshop tools-Forceps

1

1 LLG-Torch

Sturdy torch with 12 energy saving LED lights for ultra-bright light. Made from metal with practical hand strap incl. 3 x 1.5 V AAA batteries.

Dimensions (Dia. x L): 30 x 120 mm

Type	PK	Cat. No.
LLG-Torch	1	9.961 000

2

2 LED-Flashlight, Lumatic Spot

3 Watt CREE LED, range up to 120 m, zoom or focus for diffused light. Durable aluminum housing, splash-proof, with carrying strap and bag, batteries 3 x 1.5 V AAA.

TFA Dostmann

Dimensions (Dia. x L): 34 x 115 mm
Weight: 170g

Type	PK	Cat. No.
Lumatic Spot	1	9.156 233

3

3 Flashlight Energizer® TAC 700, Aluminium

NEW

Made of sturdy aircraft aluminium, with unbreakable strike bezel head, waterproof. Illumination range up to 100 m, 3 light modes adjustable via rear push button (max. 700 m). The removable clip can be used with both orientations. Incl. 2 x CR123 batteries.

Type	PK	Cat. No.
Energizer® TAC 700	1	4.672 259

4

4 LLG-Forceps, 18/10 steel

Blunt-straight.

Length mm	PK	Cat. No.
105	1	4.008 471
115	1	4.008 472
130	1	4.008 473
145	1	6.255 826
160	1	4.008 474
200	1	4.008 475
250	1	4.008 476
300	1	4.008 477
115*	1	4.008 478
130*	1	4.008 479
145*	1	4.008 480
160*	1	4.008 481

* curved

5

5 LLG-Dissecting forceps, stainless steel 420

Manufactured from premium grade polished stainless steel with fine sharp points and sprung flutes.

Available as 2 types:

- straight body form
- curved body form

Length mm	PK	Cat. No.
105	1	4.008 482
115	1	9.171 121
130	1	9.171 122
150	1	9.171 123
160	1	4.008 483
200	1	4.008 484
105*	1	4.008 485
115*	1	9.171 124
130*	1	6.236 683

* curved

1. General laboratory consumables

Tools/Forceps

1 Forceps, blunt, 8/10 stainless steel

Straight, blunt.

Length mm	PK	Cat. No.
105	1	9.171 010
115	1	9.171 011
130	1	9.171 013
145	1	9.171 014
160	1	9.171 016
200	1	9.171 020
250	1	9.171 025
300	1	9.171 030



2 Tissue forceps, 18/10 steel

With tooth grips 1:2.

Length mm	PK	Cat. No.
115	1	9.171 311
130	1	9.171 313
145	1	9.171 314
160	1	9.171 316



Forceps, stainless steel 18/10

Form	Length mm	PK	Cat. No.
Straight, sharp, fine ends	105	1	9.171 110
Straight, sharp, fine ends	115	1	9.171 111
Straight, sharp, fine ends	130	1	9.171 113
Straight, sharp, fine ends	145	1	9.171 114
Straight, sharp, fine ends	160	1	9.171 115
Straight, sharp, fine ends	200	1	9.171 116
Curved (angled), sharp, fine ends	105	1	9.160 120
Curved (angled), sharp, fine ends	115	1	9.160 121
Curved (angled), sharp, fine ends	130	1	9.160 123

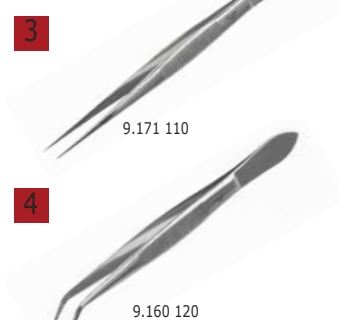

5 Forceps, curved end, 18/10 steel

Stainless 18/10 steel. Curved ends with sharp tips.

Length mm	PK	Cat. No.
115	1	9.171 221
135	1	9.171 223
145	1	9.171 224
160	1	9.171 225
200	1	9.171 226



6 Forceps, curved end, stainless steel

Remanit® 4301, with sharp ends, angled.

Length mm	PK	Cat. No.
105	1	7.637 274
115	1	9.171 211
130	1	9.171 213
145	1	9.171 214
160	1	9.171 215
200	1	9.171 217

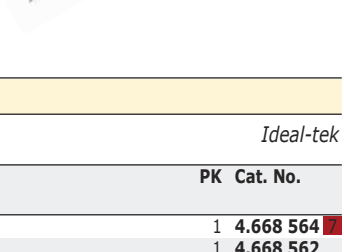

Forceps, stainless steel, anti-magnetic, anti-acid

Ideal-tek

Form	Length mm	PK	Cat. No.
Straight, strong, fine	110	1	4.668 564
Curved, fine	120	1	4.668 562
Curved, very fine	120	1	4.668 572
Curved, fine	150	1	4.668 566
Straight, fine, blunt	150	1	4.668 571
Straight, strong, fine, Nickel plated, with guide-pin	155	1	4.668 563
Straight, strong, rounded, blunt	200	1	4.668 561



Tools/Forceps

1

1

Precision Forceps, anti-Magnetic, anti-Acid, replaceable tips

130 mm high quality steel tweezers with strong plastic replaceable tips. Tips made of plastic type CF (carbon fibre), handles made of anti-magnetic anti-acid stainless steel. For laboratory applications in moderately aggressive chemical environments.

Ideal-tek

Tips made of PA66/CF30 polyamide 66 reinforced with 30 % carbon fibre. Very high rigidity, excellent tensile and flexural strength, fatigue resistance. Excellent wear and abrasion resistance. Not resistant to strong acids, alkalis and hot water or steam. Very low coefficient of linear thermal expansion.

Forceps made of Stainless Steel type SA, from 16.5 to 18.5 % chromium and nickel and molybdenum as additional alloying elements. Non-magnetizable.

Form	Length mm	PK	Cat. No.
Tip tweezers, exchangeable fine tips	130	1	6.266 878
Tip set for plastic replaceable tip tweezers, 2 tips, 3 screws for article no. 6.266 878		1	6.266 880
Tip tweezers, exchangeable extra fine tips	130	1	6.266 879
Tip set for plastic replaceable tip tweezers, 2 tips, 3 screws for article no. 6.266 879		1	6.266 881
Tip tweezers, exchangeable wide flat duckbill tips	130	1	6.272 049
Tip set for plastic replaceable tip tweezers, 2 tips, 3 screws for article no. 6.272 049		1	6.272 051
Tip tweezers, exchangeable curved, very fine tips	130	1	6.272 050
Tip set for plastic replaceable tip tweezers, 2 tips, 3 screws for article no.		1	6.272 052

2

2

High Precision Tweezers, anti-Magnetic, anti-Acid

High Precision Tweezers, swiss made, high quality finish, anti-magnetic and acid resistant stainless steel

Ideal-tek

Form	Length mm	PK	Cat. No.
flat edges, fine tips	120	1	6.266 873
flat, round tips	120	1	6.266 874
very sharp, fine tips	110	1	6.266 875
extra fine tips	110	1	6.266 876
very fine, 45° curved tips	115	1	6.266 877
extra fine tips	110	1	6.269 621
very sharp, fine tips	120	1	6.272 034
extra fine, very sharp	140	1	7.970 771

3

3

Membrane Tweezers

Swiss made. Made of austenitic steel. Non-magnetizable. Good corrosion resistance to most chemicals, salts and acids. Flat, with round tips and rounded edges. Especially suitable for safe handling of transfer membranes.

Ideal-tek

Form	Length mm	PK	Cat. No.
thin, squared, bent tips	105	1	6.272 053
flat, round tips	115	1	9.160 131
smooth and flat tips	120	1	6.269 622

4

Forceps, fine, 18/10 steel

Non-magnetic. Extra fine ends, without grooves.

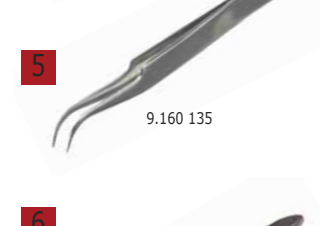
5

Form	Length mm	PK	Cat. No.
Straight	105	1	9.160 130
Curved	105	1	9.160 135

6

6

LLG-Cover glass forceps, self-locking, stainless steel

Stainless steel 4301

Form	Length mm	PK	Cat. No.
Straight	105	1	9.160 380
Curved	105	1	9.160 381

1. General laboratory consumables

Tools/Forceps

1 LLG-Cover glass forceps, type Kühne, stainless steel

Stainless steel 4301

Form	Length mm	PK	Cat. No.
Curved	115	1	9.160 386
Curved	130	1	9.160 387
Curved	145	1	9.160 388
Straight	115	1	9.160 391
Straight	130	1	9.160 392
Straight	145	1	9.160 393



2 Cover glass forceps, stainless steel NEW

Stainless steel AISI 304. With curved or straight tip.

ISOLAB

Length mm	Form	PK	Cat. No.
105	Curved	1	7.900 725
105	Straight	1	4.678 045



Cover glass forceps, stainless 18/10 steel

With flattened ends, straight or curved as outlined below. Points 6 mm wide.

Form	Length mm	PK	Cat. No.
straight	105	1	9.160 205
curved	105	1	9.160 210



Reverse Action Tweezers, antimagnetic, stainless steel

Specially intended for applications where a high precise self-closing action is required (e.g. microscopy). Extra fine tips in anti-acid/anti-magnetic stainless steel.

Ideal-tek

Form	Length mm	PK	Cat. No.
flat, accurate, round	120	1	6.272 047
very sharp, fine	120	1	6.272 048
extra fine, superior finish	110	1	6.285 207

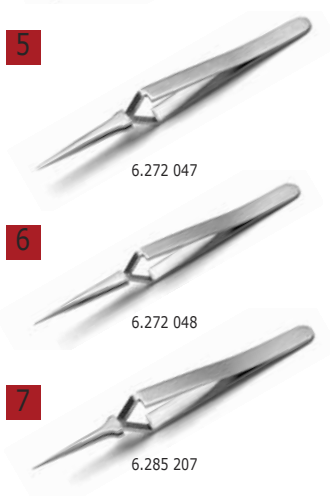

8 Tweezers for filter paper, stainless steel

Perfect tool to use for handling papers.

ISOLAB

Description	Length mm	PK	Cat. No.
Tweezers for filter paper	120	1	6.243 682



9 Forceps stands NEW

Forceps- and pliers stands. Stainless steel.

Hammacher

Width mm	Depth mm	Height mm	PK	Cat. No.
140	120	140	1	6.312 440

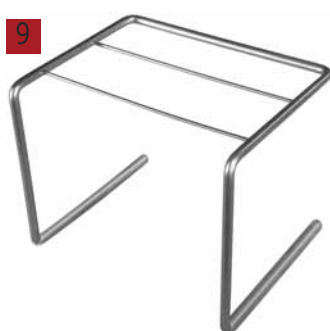

➔ Further forceps please see page 1402.

Tools/Forceps



1 Disposable tweezers, PS

NEW

Bürkle



For precise laboratory work, for gripping and holding small objects.

- Serrated handles
- Cleanroom manufactured (cleanroom class 7)
- Food-safe

Form	Length mm	Sterile	PK	Cat. No.
Pointed / angled: fine, smooth, curved gripping tip	130	+	100	4.670 759
Pointed / angled: fine, smooth, curved gripping tip	130	-	100	4.670 760
Pointed: straight, inside, serrated tip	130	+	100	4.670 761
Pointed: straight, inside, serrated tip	130	-	100	4.670 762
Wide tip: smooth and blunt tip	130	+	100	4.670 763
Wide tip: smooth and blunt tip	130	-	100	4.670 764



2 Disposable tweezers, PS and disposable tweezers, PS, detectable

Bürkle



Blue. For precise laboratory work, for gripping and holding small objects. The blue products, or parts of them, can be quickly found and easily identified in a visual check, if they ever get into production.

Disposable tweezers detectable: In addition to the blue colour, these products have a special additive in the material that makes them visible to metal detectors or X rays. They can therefore be rejected with standard systems for checking for foreign objects.

- Serrated handles
- Sterile
- Cleanroom manufactured (cleanroom class 7)
- Food-safe

Type	Form	Length mm	Sterile	PK	Cat. No.
Disposable tweezers	Pointed / angled: fine, smooth, curved gripping tip	130	+	100	4.670 765
Disposable tweezers	Pointed: straight, inside, serrated tip	130	+	100	4.670 766
Disposable tweezers	Wide tip: smooth and blunt tip	130	+	100	4.670 767
Disposable tweezers, detectable	Pointed / angled: fine, smooth, curved gripping tip	130	+	100	6.312 050
Disposable tweezers, detectable	Pointed: straight, inside, serrated tip	130	+	100	6.312 051
Disposable tweezers, detectable	Wide tip: smooth and blunt tip	130	+	100	6.312 052

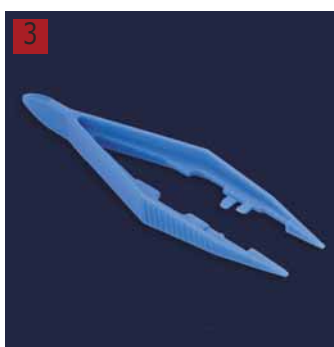

3 Disposable tweezers, ABS

NEW

ISOLAB

Blue. Corrosion and chemical resistant disposable tweezers with fine, sharp tips.

Length mm	PK	Cat. No.
110	10	7.970 670



4 Disposable tweezers, ABS, sterile

NEW

ISOLAB

Blue. Individually single packed with lot number, production date and expiry date printed on the package.

- DNase-, RNase- and pyrogen-free
- Gamma-sterilised

Length mm	PK	Cat. No.
110	1	6.254 713

1. General laboratory consumables

Tools/Forceps

1 Forceps, PMP		
White. Pointed, elastic, very good resilience. Autoclavable at 121 °C (2 bar) according to DIN EN 285.		VITLAB
Length mm	PK	Cat. No.
115	1	9.171 411
145	1	9.171 414



2 Forceps, POM			
Yellow, blunt, elastic, very good resilience. With grooves on the outside for optimum handling and grip.		VITLAB	
Length mm	Description	PK	Cat. No.
115	without grooves on the inside of the tip	1	7.009 045
145	without grooves on the inside of the tip	1	7.009 046
180	with grooves on the inside of the tip	1	9.171 418
250	with grooves on the inside of the tip	1	9.171 425



3 One-time tweezers, ABS, sterile		
One-time tweezers, 120 mm, sterile, ABS, anatomic		
Description	PK	Cat. No.
One-time tweezers, sterile	100	6.270 262



4 LLG-Forceps assortment, 4-parts, chromium-nickel steel		
LLG-Forceps assortment, 4-parts, chromium-nickel steel (1.4301) in synthetic leather bag including: 1 Sharp forcep, curved, 115 mm 1 Thumb forcep, 115 mm 1 Forcep with guide pin straight, 130 mm 1 Coverglas forcep, 115 mm 1 Synthetic leather bag, 6 subjects 100 x 175 mm		
Description	PK	Cat. No.
LLG-Forceps assortment, 4-parts	1	9.160 394



5 High Precision Tweezer kit, 5-parts, stainless steel, anti-magnetic, anti-acid		
High Precision Tweezers Kit, swiss made, high quality finish, anti-magnetic and acid resistant stainless steel in a solid cardboard box with foam insert, including 5 forceps:		Ideal-tek
120 mm, flat edges, fine tips (1 x 6.266 873)		
120 mm, flat, accurate, round tips (1 x 6.266 874)		
110 mm, very sharp, fine tips (1 x 6.266 875)		
110 mm, extra fine tips (1 x 6.266 876)		
115 mm, very fine, 45° curved tips (1 x 6.266 877)		
Description	PK	Cat. No.
High Precision forceps kit, 5-parts	1	9.160 124



Tools/Scoops



1 LLG-Dispensing scoops, HDPE

For heavy industrial use. Suitable for foodstuff.

Capacity ml	Length mm	PK	Cat. No.
250	250	1	9.201 091
500	300	1	9.201 092
1000	350	1	6.240 471
1500	400	1	9.201 093

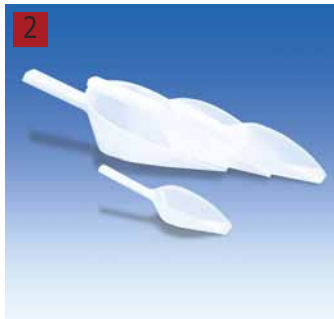

2 Measuring scoops, HDPE



VITLAB

Natural colouring. Conical in shape with tapered filling edge.
Food-safe product according to regulation (EU) No. 10/2011.

Capacity ml	Length mm	Colour	PK	Cat. No.
15	115	Natural	1	7.008 959
25	135	Natural	1	7.008 960
65	185	Natural	1	7.008 961
110	215	Natural	1	7.008 962
150	250	Natural	1	9.201 025
350	310	Natural	1	9.201 030
750	350	Natural	1	9.201 035
750	350	Ultramarin	1	6.310 292
750	350	Black	1	4.671 820
1250	400	Natural	1	9.201 040
1250	400	Ultramarin	1	6.310 293
1250	400	Black	1	4.671 821

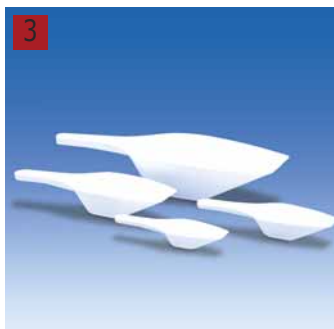

3 Measuring scoops, PP



VITLAB

White measuring scoops which are also suitable as weighing scoops. With precision formed filling edge and comfortable, stable handle. Easily readable volume quantities on the upper side of the handle.
Food-safe product according to regulation (EU) No. 10/2011.

Capacity ml	Length mm	PK	Cat. No.
2	60	12	9.201 042
5	82	12	9.201 043
10	100	12	9.201 045
25	135	12	9.201 047
50	160	12	9.201 048
100	200	12	9.201 049
250	260	6	4.678 198
250	315	6	4.678 197
1000	385	6	9.201 050



4 Dispensing scoops, Aluminium

Capacity ml	Length Scoop mm	Overall length mm	PK	Cat. No.
42	80	135	1	9.201 113
105	113	185	1	9.201 118
140	120	210	1	9.201 121
260	145	250	1	9.201 125
340	155	265	1	9.201 126
555	185	310	1	9.201 131
675	220	350	1	9.201 135
1510	270	400	1	9.201 140
3000	300	430	1	9.201 143



5 Dispensing scoops, stainless steel

Made from stainless steel Remanit® 4301.

Capacity ml	Diam. mm	Length Scoop mm	Overall length mm	PK	Cat. No.
120	50	100	190	1	9.201 219
450	75	145	250	1	9.201 222
1000	105	190	320	1	9.201 232
1500	120	240	350	1	9.201 235
2000	150	250	370	1	6.080 286

1. General laboratory consumables

Tools/Scoops-Heating/Burners

1 Scoops FoodScoop, Stainless steel



Bürkle

Very stable hand scoop for various applications, particularly suited for the food industry. Seamless connection of scoop and hollow handle, therefore without crevices and edges. Especially smooth, highly polished surface.

- Especially sturdy model
- Stainless steel V2A (1.4301)
- With handy suspension eyelet



Capacity ml	Width Scoop mm	Length Scoop mm	Overall length mm	PK	Cat. No.
100	60	120	215	1	6.254 785
200	75	140	230	1	6.252 363
250	85	155	245	1	6.254 786
350	100	180	290	1	6.242 476
500	130	220	350	1	6.072 181

2 Scoops PharmaScoop, stainless steel V4A, with long handle



Bürkle

For sampling of powders and granulates in the pharmaceutical industry.

- Stainless steel V4A, highly polished surface
- Jointless production
- Long handle, 60 cm
- Autoclavable
- Suitable for food
- GMP-conform



Nominal capacity ml	Overall length mm	Length Scoop mm	Diam. mm	PK	Cat. No.
1000	835	235	110	1	4.665 345

3 Laboratory dryer HT0141

Power: approx. 2100 W. 2 speed settings, 3 temperature settings with cold air-stream button. Metallic paint housing. Air-inlet grill detachable for cleaning. cable retracts at the touch of a button. Weight: 594 g.



Type	PK	Cat. No.
HT 0141	1	6.268 487

Spirit lamp

Soda-lime glass. Flat conical form. With ground on cover. Without filling inlet, without wick or nozzle (please order separately). Capacity 100 ml.



9.018 549

Type	PK	Cat. No.
Without filler inlet	1	9.018 549
Wick	1	9.018 553
Nozzle	1	9.018 554

5 Spirit burner

18/10 steel. With wick height adjuster and sealing cap. Capacity approx. 60 ml.

Usbeck



Type	PK	Cat. No.
Spirit burner	1	9.018 560

1

9.018 540

Flame sterilizer/Blowlamp Soudogaz® X 2000/X 2000 PZ

Air volume regulation for stepless adjustment of flame size. For operation with gas cartridge C 206 GLS:
With durable housing to protect the cartridge.

- For flaming and sterilizing
- Mobile hand-held device
- One-hand operation possible

Weight: 380 g without cartridge
Consumption: 120 g/h
Flame temperature: approx. 1750 °C

Type	PK	Cat. No.
Soudogaz® X 2000 without piezo ignition	1	9.018 540
Soudogaz® X 2000 PZ with piezo ignition	1	9.018 539

2

2 Bunsen burner, portable Labogaz® 206

For operation with gas cartridge C 206 GLS (Cat.-No.: 9.018 520). DVGW-authorized.

Weight: 380 g without cartridge
Height: 200 mm with cartridge
Consumption: 55 g/h

Type	PK	Cat. No.
Labogaz® 206	1	9.018 510

3

3 Bunsen burner, portable, Labogaz® 470

For operation with gas cartridges CV 300 Plus (Cat.-No.: 6.243 905) or CV 470 Plus (Cat.-No.: 9.018 512).

Weight: 380 g without cartridge
Height: 190 mm with cartridge CV 300 Plus
240 mm with cartridge CV 470 Plus
Consumption: 55 g/h

Type	PK	Cat. No.
Labogaz® 470	1	9.018 511

4

6.243 905

Gas cartridges

C 206 GLS pierceable cartridge

Piercing cartridge with integrated gas lock system according to EN 417: 2012. For bunsen burner without safety valve.
For bunsen burners Labogaz® 206 and Soudogaz blow torches.

CV470 Plus and CV 300 Plus valve cartridge

With safety valve. For bunsen burner Labogaz® 470.

CV 360 valve cartridge

With safety valve. For gas-safety burner schuett phoenix (Cat.-No. 9.018 761).

Safety valve allows removal of partially used valve gas cartridges.



H phrases: H220

Type	Description	Height mm	Capacity g	PK	Cat. No.
C 206 GLS	Gas ratio 80/20 Butane/Propane	90	190	1	9.018 520
C 206 GLS	Gas ratio 80/20 Butane/Propane (large pack)	90	190	36	6.261 010
CV 300 Plus	Gas ratio 80/20 Butane/Propane	105	240	1	6.243 905
CV 470 Plus	Gas ratio 80/20 Butane/Propane	140	450	1	9.018 512
CV 470 Plus	Gas ratio 80/20 Butane/Propane (large pack)	140	450	12	6.261 011
CV 360	Butane	140	52	1	9.018 519

Suitable accessories can be found in our online shop.

E & OE.

1. General laboratory consumables

Heating/Burners

1 Gas cartridges

CG 1750 : 175 g of butane/propane mixture. Operates in low temperature (-10 °C). Cartridge with universal threaded valve. *Campingaz*



H phrases: H220

Type	Capacity g	Description	PK	Cat. No.
CG1750	175	butane / propane	1	6.225 728

1



2 Gas cartridge

220g/400ml. With safety valve. Provides approx. 3 hours use. EN 417: 2012. 70 % butane, 30 % propane. *Usbeck*



H phrases: H220

Type	PK	Cat. No.
Gas cartridge	1	9.018 364

2



Burner for cartridges

With needle gas valve and air regulator.
Only for the gas cartridge 9.018 364.

6.073 253 and 6.082 974:



H phrases: H220

Height mm	Type	PK	Cat. No.
136	Cartridge Burner DIN type with cartridge	1	6.082 974
136	Burner for cartridges, Teclu, without cartridge	1	9.018 363
136	Burner for cartridges, Bunsen, without cartridge	1	9.018 370
152	Ignition fuse with cartridge	1	6.073 253

3



9.018 363

4



9.018 370

5



6.073 253

6 Bunsen burners with needle valve

DIN 30665. Air regulation, *Usbeck*

Description	Height mm	Weight g	PK	Cat. No.
Natural	155	220	1	9.018 361
Propane	155	220	1	9.018 362

6



7 Bunsen burner with needle valve

DIN 30665. Air regulation, pilot flame. *Usbeck*

Rubber sucker base (Art. Nr. 9.018 360) please order separately.

Type	Height mm	Weight g	PK	Cat. No.
Natural with needle valve	155	220	1	9.018 365
Propane with needle valve	155	220	1	9.018 366

7



8 Bunsen burners with gas tap

DIN 30665. Air regulation, spar flame. *Usbeck*

Description	Height mm	Weight g	PK	Cat. No.
Natural, stopcock	155	225	1	6.055 476
Propane, stopcock	155	225	1	6.801 322

8



Heating/Burners



1 Bunsen burner with lever cock

DIN 30665. Air regulation, low flame.

Usbeck

Type	Height mm	Weight g	PK	Cat. No.
Natural with lever cock	155	245	1	6.090 990
Propane with lever cock	155	245	1	7.600 247



2 Bunsen burners with air regulator and needle valve

With air regulator and needle gas valve. Adjustable nozzle.

Usbeck

Type	Height mm	Weight g	PK	Cat. No.
Universal burner	170	270	1	9.018 294



9.018 360

6.802 244

Accessories for Bunsen burner

Usbeck

Type	PK	Cat. No.
Rubber sucker base for bunsen burner	1	9.018 360
Heavy foot (+ 200 g) can be screwed	1	6.802 244



5 Safety burner, Ms-Ni

Maximum temperature 1300 °C, with needle valve, **thermo safety element** (bimetallic flame sensor with magnetic lock), air regulator and pilot light. Nickel-plated brass and steel. An anti-slip rubber coating under the base ensures absolute stability.

Bochem

Type	Height mm	Rating kW	PK	Cat. No.
Natural gas	180	1.53	1	9.018 388
Propane	180	2.36	1	9.018 389



6 Teclu burners with needle valve

Acc. to DIN 30665, with air regulation, with low flame.

Usbeck

Type	Height mm	Weight g	PK	Cat. No.
Natural	155	260	1	9.018 375
Propane	155	260	1	9.018 376



7 Teclu burners with needle valve

DIN 30665. Ignition protection, thermocouple, air regulation, low flame.

Usbeck

Description	Height mm	Weight g	PK	Cat. No.
Natural gas	160	370	1	9.018 380
Propane	160	370	1	9.018 381

➔ Gas safety tubing please see page 146.



8 Gas lighter

For all types of gas. Bow-shaped. With flint.

Usbeck

Type	PK	Cat. No.
Gas lighter	1	9.018 801
Flints	1	9.018 805

1. General laboratory consumables

Heating/Burners-Beaker tongs

1 Piezoelectric gas lighter, Clipper

Piezoelectric.

Type	PK	Cat. No.
Piezoelectric gas lighter, Clipper	1	9.018 820



Electric laboratory burner

Simple power supply through the electrical connector with an integrated switch for power on/off, no dangerous gas supply and gas leakage

- Electrical power supply instead of gas
- Fast heat up without a flame
- Highest security operated through an RCD: suitable for education
- No waste and storage of gas cartridges
- Continuous power regulation through the optional power regulator
- Heat protection through the optional glass support: deposition for dishes and flasks
- Improved heat protection with an improved glass support
- Clean odorless working in regular atmosphere without a flame

HORO

The components need to be ordered separately.

Specifications

Power supply:	590W/230V
Dimensions (diam. x H):	125 x 180 mm
Weight:	800 g
Max. temperature:	900 °C
Heated area:	diam. 38 mm

Type	PK	Cat. No.
Electric laboratory burner	1	9.018 601
Power regulator for electric laboratory burner	1	9.018 602
Glass support for electric laboratory burner	1	9.018 603
Safety glass support for electric laboratory burner	1	9.018 604



5 Electric Bunsen burner BA6101

Electrothermal's Electric Bunsen, combines the advantages of a regular gas burner with the clean, easy operation of their Electromantles. The Electric Bunsen is ideal for non-contact heating of test tubes, crucibles, small flasks and beakers, regardless of their shape.

Electrothermal

- Conical shaped heating element directs radiant heat to the top cavity
- Top cowl deflects heat away from your hand
- Air circulation from the vented housing keeps the base cool enough to hold during operation
- Corrosion-resistant

Specifications

Power consumption:	400 W
Dimensions (diam. x H):	120 x 177 mm
Weight:	0.5 kg
Temperature range:	800 to 1000 °C

Type	Description	PK	Cat. No.
BA6101	without controller	1	9.018 691
BA6101/C	with controller	1	4.011 122



6 Crucible tongs, 18/10 steel

18/10 steel. Electro polished. With bow and gripping tips.

Length mm	Description	PK	Cat. No.
160	18/10 E-Poli	1	9.310 116
200	18/10 E-Poli	1	9.310 120
220	18/10 E-Poli	1	9.310 122
250	18/10 E-Poli	1	9.310 125
300	18/10 E-Poli	1	9.310 130
400	18/10 E-Poli	1	9.310 140
500	18/10 E-Poli	1	9.310 150
600	18/10 E-Poli	1	9.310 160
200	18/10 Stainless	1	6.305 927
220	18/10 Stainless	1	6.078 136
250	18/10 Stainless	1	6.232 602
300	18/10 Stainless	1	7.601 876
200	Ni 99,5 %	1	9.310 172
220	Titanium	1	6.288 673

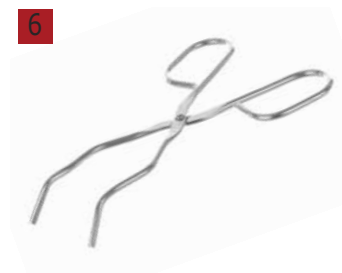

Heating/Beaker tongs-Tripod



1 Crucible tongs, chromated steel

With bow and flutes.

ISOLAB

Length mm	PK	Cat. No.
250	10	4.678 589
300	1	4.008 441
400	10	6.289 147



2 Crucible tongs, 18/10 steel, PTFE-coated

18/10 steel. With bow, and up to 100mm long PTFE-coated tips.

Length mm	PK	Cat. No.
200	1	9.310 285
250	1	9.310 290



3 Flask tongs, 18/10 steel

18/10 steel. Electro polished. Polyamide coated jaw clamps.

Length mm	Jaw opening mm	PK	Cat. No.
230	15-60	1	9.310 025



4 Flask tongs, chromated steel

Chromated steel flask tong - 300 mm length with insulated jaws, used to hold all types of flasks.

ISOLAB

For	Length mm	Temp. range max. °C	PK	Cat. No.
flasks volume up to 2000 ml	300	120	1	4.008 397



5 Beaker tongs, chromated steel

Beaker tong of 300 mm length is made out of chromated steel. Insulated jaws are used to hold all types of beakers.

ISOLAB

For	Length mm	Temp. range max. °C	PK	Cat. No.
beakers volume up to 1000 ml	300	120	1	6.237 287



6 Beaker tongs

Electro polished 18/10 steel wire frame with bowed strip-metal jaws and ceramic fibre jaw linings.

Length mm	Jaw opening mm	PK	Cat. No.
300	60 to 100	1	9.310 016



7 Beaker tongs, with rubber-sleeved jaws

Jaws protected with 2 rubber pads each. Arm length: 160 mm.

Length mm	Jaw opening mm	PK	Cat. No.
300	50 to 100	1	9.310 010



8 Tripod stand

Zinc-plated steel. With circular top and flared legs.

Usbeck

Zinc plating of tripod stands serves as temporary corrosion protection. May peel off after direct contact with open burner flame.

Diam. mm	Height mm	PK	Cat. No.
100	180	1	9.034 110
120	210	1	9.034 112
120	250	1	6.200 910
120	260	1	6.234 831
140	220	1	9.034 114
160	230	1	6.059 957

1. General laboratory consumables

Heating/Tripod

1 Tripod stand

Chrome plated steel. Tripods are meant to be used in conjunction with wire gauze, triangles or a sand bath. Holding ring with 150 mm diameter can be reduced to 125 mm with the supplied reduction attachment.

ISOLAB

Description	Diam. mm	PK	Cat. No.
total height 200 mm	125	1	6.242 704
adjustable height min 200 mm/max 300 mm	150	1	4.008 512



2 Wire gauzes

Steel wire with round ceramic centre. Sizes as outlined below.

Width mm	Depth mm	PK	Cat. No.
120	120	1	9.033 632
150	150	1	6.800 180
160	160	1	9.033 636
180	180	1	7.400 160
200	200	1	9.033 640

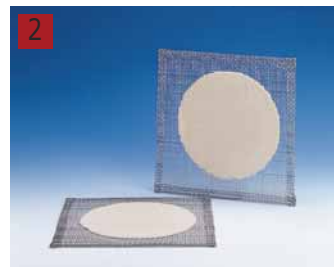

3 Wire gauzes

Plain, stainless steel wire with flanged edges. Mesh: 0.6 mm x 2.0 mm. Sizes as outlined below.

RSG

Width mm	Depth mm	PK	Cat. No.
115	115	1	9.150 717
135	135	1	9.150 718
155	155	1	9.150 719
175	175	1	9.150 720
195	195	1	9.150 721

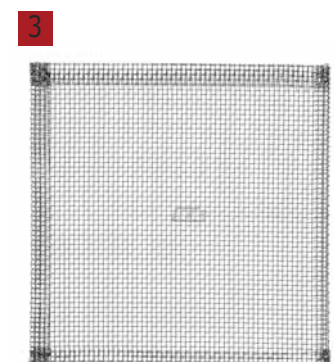

4 Wire gauzes

Plain, stainless steel wire with heat resistant center, mesh: 0.6 mm x 2.0 mm

RSG

Width mm	Depth mm	PK	Cat. No.
135	135	1	9.033 653
155	155	1	9.033 655
175	175	1	9.033 657
195	195	1	9.033 659

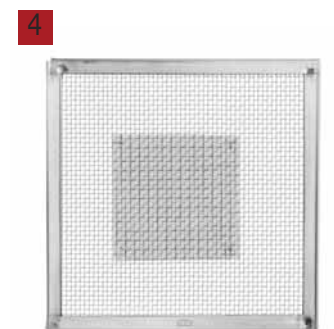

5 Glass ceramic laboratory protection plate

Glass ceramic material with a smooth, pore-free surface. Chemically resistant and operates between -200 °C and +700 °C. Ideal for use as a bench protector or heating surface in place of a wire gauze or pipeclay triangle.

DWK Life Sciences

Width mm	Depth mm	PK	Cat. No.
135	135	1	9.034 253
155	155	1	9.034 257
175	175	1	9.034 258



6 Triangle

Zinc-plated steel wire with pipeclay tubes.

Juchheim Laborgeräte

Pipeclay tube Length mm	Weight g	PK	Cat. No.
40	16	1	9.033 740
50	33	1	9.033 741
60	38	1	6.250 142
100	58	1	6.085 914





1 Safety gas hoses, rubber, without reinforcement

According to DIN 30664 section 1. Without cable armor. Connecting line for connecting between safety gas connection fitting according to DIN 3383-4 and gas burners for laboratories according to DIN 30665 section 1. For all gases according to DVGW worksheet G 260, at pressures up to 100 mbar and temperatures up to 70 °C. Installations according to DVGW-TRGI 2008 and DVGW worksheet G 621. DVGW Reg.-No. NG-4607AU2366. Supplied per metre.

Deutsch & Neumann

Int. diam. mm	Wall thickness mm	PK	Cat. No.
10	2	1	9.018 970



2 Gas safety tubing, rubber

Flexible connecting line of a rubber tubing with a contracted metal spiral and double-sided end sockets according to DVGW 5501(P). Kink resistant.

Deutsch & Neumann

For connecting between safety gas connection fitting according to DIN 3383-4 and gas burners for laboratories according to DIN 30665 section 1.

For all gases according to DVGW worksheet G 260, at pressures up to 100 mbar and temperatures up to 70 °C.

Installations according to DVGW-TRGI 2008 and DVGW worksheet G 621. DVGW Reg.-No. DG-4607AU2366.

Sold only in specified length

Length mm	PK	Cat. No.
500	1	9.018 935
600	1	9.018 936
750	1	9.018 937
1000	1	9.018 940
1250	1	9.018 942
1500	1	9.018 945
2000	1	9.018 950
3000	1	9.018 960



3 Tubing

Red. Rubber (NR). Durometer 45 Shore A. Supplied per metre or in standard coils of 25 m.

Deutsch & Neumann

Int. diam. mm	Wall thickness mm	PK	Cat. No.
2	1.0	1	9.205 157
3	1.0	1	9.205 158
3	1.5	1	9.205 159
4	1.0	1	9.205 160
4	1.5	1	9.205 166
4	2.0	1	6.076 831
5	1.5	1	9.205 170
5	2.0	1	9.205 171
6	1.5	1	9.205 173
6	2.0	1	9.205 174
7	1.5	1	9.205 179
7	2.0	1	9.205 180
8	2.0	1	9.205 184
9	2.0	1	9.205 187
10	2.0	1	9.205 192
12	2.5	1	9.205 195
15	3.0	1	6.054 526
18	3.0	1	9.205 200



4 Vacuum tubing, rubber

Red. Rubber (NR). Durometer 45 Shore A. Supplied per metre or standard coils of 25 m.

Deutsch & Neumann

Int. diam. mm	Wall thickness mm	PK	Cat. No.
4	4	1	9.205 804
5	4	1	6.075 946
5	5	1	9.205 805
6	4	1	6.079 829
6	5	1	9.205 806
7	4	1	6.077 239
7	5	1	9.205 807
8	5	1	9.205 808
8	6	1	6.053 348
10	3	1	6.078 678
10	5	1	9.205 809
10	8	1	6.078 473
12	5	1	6.054 195

1 Vacuum Tubing, Silicone

Deutsch & Neumann

Int. diam. mm	Ext. diam. mm	Wall thickness mm	PK	Cat. No.
3	9	3	1	6.071 718
4	12	4	1	6.086 397
5	15	5	1	6.302 123
6	12	3	1	6.077 377
7	13	3	1	6.052 545
7	15	4	1	6.076 513
7	17	5	1	6.210 064
8	16	4	1	6.050 803
8	18	5	1	6.077 451
10	20	5	1	6.077 452
12	22	5	1	7.604 078

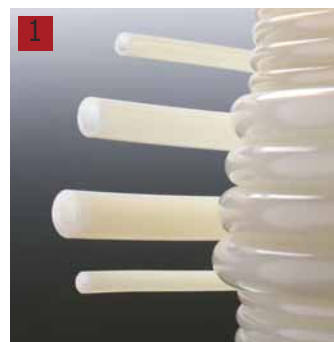

2 Tubing, Silicone

Deutsch & Neumann

Silicone rubber (VMQ), transparent, hardness 60 Shore A, food grade, temperature-resistant from -60 to 200 °C (short term up to 260 °C), suitable for peristaltic pumps. BFR XV, FDA CFR 21 § 177.2600, EP-Europ. Pharmacopoeia/DAB, biocompatibility: Cytotoxicity (USP Class 1-6), Hemolysis, Pyrogenicity, Sensitization, Dermatological Irritation, Implantation (90 days) according to ISO 10993-1. Supplied per meter.

Int. diam. mm	Ext. diam. mm	Wall thickness mm	PK	Cat. No.
0.5	1.3	0.40	1	6.056 925
0.5	2.5	1.00	1	9.205 210
0.8	1.6	0.40	1	6.077 624
1.0	1.8	0.40	1	9.205 220
1.0	4.0	1.50	1	6.090 066
1.0	6.0	2.50	1	9.205 223
1.5	2.3	0.40	1	9.205 231
1.5	3.0	0.75	1	7.510 657
1.5	3.5	1.00	1	9.205 233
1.5	4.0	1.25	1	6.070 518
2.0	2.6	0.30	1	9.205 243
2.0	2.8	0.40	1	6.077 692
2.0	5.0	1.50	1	6.077 690
2.5	3.3	0.40	1	6.200 882
2.5	4.5	1.00	1	9.205 247
3.0	3.8	0.40	1	9.205 256
4.0	5.0	0.50	1	9.205 263
4.0	9.0	2.50	1	6.800 894
5.0	6.0	0.50	1	6.510 848
5.0	9.0	2.00	1	9.205 271
5.0	10.0	2.50	1	6.051 286
6.0	8.0	1.00	1	6.054 776
7.0	9.0	1.00	1	6.078 584
8.0	11.0	1.50	1	9.205 282
8.0	14.0	3.00	1	6.076 521
8.0	15.0	3.50	1	6.052 487
9.0	12.0	1.50	1	9.205 286
10.0	13.0	1.50	1	6.077 445
10.0	15.0	2.50	1	6.077 390
10.0	16.0	3.00	1	6.075 034
10.0	18.0	4.00	1	6.078 358
11.0	15.0	2.00	1	6.076 955
12.0	18.0	3.00	1	7.059 572
13.0	19.0	3.00	1	6.051 320
14.0	20.0	3.00	1	6.054 710
15.0	21.0	3.00	1	6.059 206
16.0	21.0	2.50	1	6.056 160
18.0	24.0	3.00	1	6.056 159
20.0	26.0	3.00	1	6.085 341
25.0	34.0	4.00	1	6.078 413

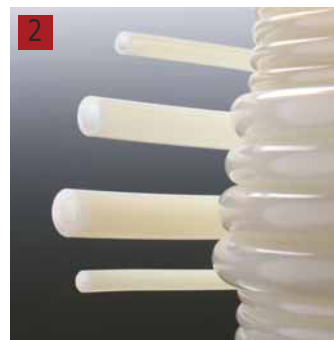

We can supply this
**manufacturer's whole
 product range !**



DEUTSCH & NEUMANN GmbH

Tubing/Plastic

1

1 Tubings RAULAB FG® SLIDETEC, Silicone

Rehau



Suitable for food use, non talc-coated, according to BfR XV (Silicone) and FDA 177.2600. Original roll 25 meters. Discharge per meter. Durometer 60 ±5 Shore A to DIN 53505.

Int. diam. mm	Ext. diam. mm	Wall thickness mm	PK	Cat. No.
1	3	1.0	1	9.205 000
2	4	1.0	1	9.205 001
2	6	2.0	1	9.205 002
3	5	1.0	1	9.205 003
3	6	1.5	1	9.205 004
3	7	2.0	1	9.205 005
4	6	1.0	1	9.205 006
4	7	1.5	1	9.205 007
4	8	2.0	1	9.205 008
5	7	1.0	1	9.205 009
5	8	1.5	1	9.205 010
6	9	1.5	1	9.205 011
6	10	2.0	1	9.205 012
7	10	1.5	1	9.205 013
7	11	2.0	1	9.205 280
8	10	1.0	1	9.205 014
8	12	2.0	1	9.205 015
9	13	2.0	1	9.205 017
10	14	2.0	1	9.205 018
12	16	2.0	1	9.205 020

2



2 PVC-Tubing



Approved by BGVO directive 2002/72/EC and 2008/39/EC for food contact. Approved by KTW-C directive - Germany Federal Environment Agency for use in cold water. Durometer 77 Shore A.

Price per metre.

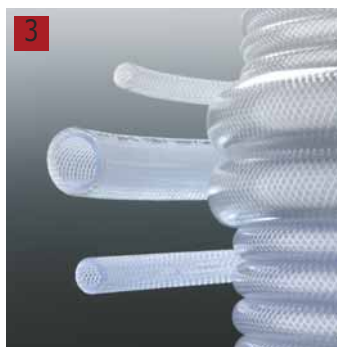
Int. diam. mm	Ext. diam. mm	Wall thickness mm	PK	Cat. No.
2	4	1.0	1	9.205 345
3	5	1.0	1	9.205 358
3	6	1.5	1	9.205 359
4	6	1.0	1	9.205 365
4	7	1.5	1	9.205 366
5	7	1.0	1	9.205 369
5	8	1.5	1	9.205 370
6	8	1.0	1	9.205 372
6	9	1.5	1	9.205 373
6	10	2.0	1	9.205 374
7	10	1.5	1	9.205 379
7	11	2.0	1	9.205 380
8	11	1.5	1	9.205 382
8	12	2.0	1	9.205 384
9	12	1.5	1	9.205 386
9	13	2.0	1	9.205 387
10	14	2.0	1	9.205 392
12	16	2.0	1	9.205 394
15	19	2.0	1	9.205 397
18	22	2.0	1	9.205 398

3

3 Fabric-reinforced tubing, PVC



Transparent. Supplied per metre or in standard coils of 50M. PVC with terylene mesh reinforcement. Certified by German TÜV with due regard to regulatory of DIN EN ISO 5774:2008. Proofed by BGVO directive 2002/72/EC bis 2008/39/EC for food contact. Durometer 77 Shore A.

Int. diam. mm	Ext. diam. mm	Wall thickness mm	PK	Cat. No.
6.0	12.0	3	10	6.291 358
8.0	14.0	3	10	6.291 359
10.0	16.0	3	10	6.291 360
12.5	18.5	3	10	6.291 361

1 Rubber Tubing, Viton®

Supplied per metre.

Deutsch & Neumann

- Fluoroelastomer Rubber (FPM), black
- Temperature range -10 to over +200 °C
- Good resistance to ozone and weathering, as well as benzene and mineral oil
- Durometer 75 Shore A

Int. diam. mm	Ext. diam. mm	Wall thickness mm	PK	Cat. No.
2	4	1.0	1	9.205 745
3	5	1.0	1	9.205 758
4	6	1.0	1	9.205 765
5	7	1.0	1	9.205 769
6	8	1.0	1	9.205 772
6	10	2.0	1	9.205 774
8	11	1.5	1	9.205 782
8	12	2.0	1	9.205 784
9	13	2.0	1	9.205 787
10	14	2.0	1	9.205 792
12	16	2.0	1	6.083 415



2 Tubing, PFA

PFA fluorocarbon resin. Highly chemical resistant and temperature resistant up to +260 °C. Supplied per metre.

BOLA

Int. diam. mm	Ext. diam. mm	Wall thickness mm	PK	Cat. No.
0.80	1.60	0.4	1	9.205 824
1.58	3.18	0.8	1	9.205 825
2.00	4.00	1.0	1	9.205 827
4.00	6.00	1.0	1	9.205 830
6.00	8.00	1.0	1	9.205 833
8.00	10.00	1.0	1	9.205 836
10.00	12.00	1.0	1	9.205 839



3 Tubing, PTFE

Highly chemical resistant and withstands temperatures from -200 °C to +250 °C. Supplied per metre.

BOLA

Int. diam. mm	Ext. diam. mm	Wall thickness mm	PK	Cat. No.
0.5	1.0	0.25	1	9.205 608
0.5	1.6	0.55	1	9.205 609
0.8	1.6	0.40	1	9.205 616
1.0	1.6	0.40	1	9.205 619
1.0	2.0	0.50	1	9.205 621
1.5	2.1	0.30	1	9.205 630
1.6	3.2	0.80	1	9.205 634
2.0	3.0	0.50	1	9.205 644
2.0	4.0	1.00	1	9.205 645
3.0	4.0	0.50	1	9.205 657
3.0	5.0	1.00	1	9.205 658
4.0	6.0	1.00	1	9.205 665
5.0	6.0	0.50	1	9.205 668
6.0	8.0	1.00	1	9.205 672
8.0	10.0	1.00	1	9.205 680



Tubing/Plastic



1 Tubing Norprene® A 60 G

Black, Thermoplastic elastomer, Shore A 61. Suitable for use as tubing for peristaltic pumps. High endurance. Resistant to many aggressive chemicals. Supplied per metre or in standard coils of 15 m.

- Temperature range -60 to +135 °C
- Superior weathering
- Abrasion resistant
- Low gas permeability versus rubber tubing
- Ozone (300 pphm) and UV light resistant

Int. diam. mm	Ext. diam. mm	Wall thickness mm	PK	Cat. No.
1.6	4.8	1.6	1	9.206 941
3.2	6.4	1.6	1	9.206 944
4.8	8.0	1.6	1	9.206 951
6.4	9.6	1.6	1	9.206 956
6.4	11.2	2.4	1	9.206 957
8.0	11.2	1.6	1	9.206 961
8.0	12.8	2.4	1	9.206 962
9.5	12.7	1.6	1	9.206 967
9.5	14.4	2.4	1	9.206 968
9.5	15.9	3.2	1	9.206 969
11.1	14.3	1.6	1	9.206 973
12.7	15.9	1.6	1	9.206 976
12.7	17.5	2.4	1	9.206 977



2 Tubing Versilic®, Silicone

Versilic® 60 shore tubing is biologically inert and does not inhibit cell culture. It stays flexible down to -50 °C and maintains its chemical, mechanical and electrical performance up to +200 °C. Versilic® meets the European Pharmacopoeia requirements for silicone elastomer for closures and tubing, USP Class VI biological tests and ISO 10993 biocompatibility (systemic toxicity, irritation, sensitization, citotoxicity, hemocompatibility and Ames test).

Saint Gobain

Int. diam. mm	Ext. diam. mm	Wall thickness mm	PK	Cat. No.
0.5	2.5	1.0	1	9.205 300
1.0	3.0	1.0	1	9.205 301
2.0	4.0	1.0	1	9.205 302
3.0	5.0	1.0	1	9.205 303
4.0	6.0	1.0	1	9.205 304
4.0	8.0	2.0	1	9.205 267
5.0	7.0	1.0	1	9.205 305
6.0	9.0	1.5	1	6.236 287
6.0	10.0	2.0	1	9.205 275
7.0	11.0	2.0	1	9.205 306
8.0	11.0	1.5	1	6.235 261
8.0	12.0	2.0	1	9.205 285
9.0	13.0	2.0	1	9.205 307
10.0	14.0	2.0	1	9.205 308
12.0	17.0	2.5	1	9.205 309



3 Tubing Iso-Versinic

Synthetic fluoroelastomer. Chemically resistant to hydrocarbons (aromatic and aliphatic), oils, strong acids, oxidizing agents and chlorous solvents. Excellent resistance to abrasion and flexing. Good ozone and radiation protection. Impermeable to gas and steam. Shore A, Density 1.9. Temperature range -20 °C to +200 °C (up to +300 °C for short periods). Elongation at tear >250 %. Suitable for transporting corrosive liquids. Supplied per metre.

Int. diam. mm	Ext. diam. mm	Wall thickness mm	PK	Cat. No.
1	3	1.0	1	9.205 700
2	4	1.0	1	9.205 701
3	5	1.0	1	9.205 702
4	6	1.0	1	9.205 703
5	8	1.5	1	9.205 704
6	9	1.5	1	9.205 705
7	10	1.5	1	9.205 706
8	12	2.0	1	9.205 707
10	14	2.0	1	9.205 708
12	17	2.5	1	9.205 709

1 Tubing Tygon® E-3603

Transparent. Shore A 55. Universal laboratory tubing with very good gripping properties on glass or plastic fittings. Very low gas permeability level similar to rubber. Resistant to most laboratory chemicals. Suitable for peristaltic pumps and for food and beverage dispensing. Meets FDA and USP class VI. Supplied per metre or in standard coils of 15 m.

- Temperature range -50 to +74 °C
- Smooth inner surface
- Contains no BPA or phthalates

Int. diam. mm	Ext. diam. mm	Wall thickness mm	PK	Cat. No.
0.8	2.4	0.8	1	9.205 515
1.6	3.2	0.8	1	9.205 536
1.6	4.8	1.6	1	9.205 537
2.4	4.0	0.8	1	9.205 550
2.4	5.6	1.6	1	9.205 551
3.2	4.8	0.8	1	9.205 561
3.2	6.4	1.6	1	9.205 562
4.0	5.6	0.8	1	9.205 564
4.0	7.1	1.6	1	9.205 566
4.8	6.4	0.8	1	9.205 568
4.8	7.9	1.6	1	9.205 567
4.8	9.5	2.4	1	9.205 569
4.8	11.1	3.2	1	9.205 570
6.4	7.9	0.8	1	9.205 575
6.4	9.5	1.6	1	9.205 576
6.4	11.1	2.4	1	9.205 577
6.4	12.7	3.2	1	9.205 578
7.9	11.1	1.6	1	9.205 583
7.9	12.7	2.4	1	9.205 584
7.9	14.3	3.2	1	9.205 585
7.9	15.9	4.0	1	9.205 586
9.5	12.7	1.6	1	9.205 588
9.5	14.3	2.4	1	9.205 589
9.5	15.9	3.2	1	9.205 590
11.1	14.3	1.6	1	9.205 591
11.1	15.9	2.4	1	9.205 592
11.1	17.5	3.2	1	9.205 593
12.7	15.9	1.6	1	9.205 595
12.7	17.5	2.4	1	9.205 596
12.7	19.0	3.2	1	9.205 597
12.7	20.6	4.0	1	9.205 598
15.9	22.2	3.2	1	9.206 524
19.0	27.0	4.0	1	9.206 545

Further products can be found in our online shop.

2 Tubing Tygon® 3350

Silicone-platinum tubing, Shore A 50. For sterile filling systems, chemistry and blood analyzers and liquid chromatography. Biocompatibility for sensitive applications. To FDA and USP Class VI, in accordance with ISO 10993. Supplied in 15 m coil.

Saint Gobain

- Temperature range -81 to +200 °C
- Smooth inner surface
- High flexibility
- Ozone and UV resistant

Int. diam. mm	Ext. diam. mm	Wall thickness mm	PK	Cat. No.
1.6	3.2	0.8	15	6.300 493
3.2	6.4	1.6	15	9.208 380
4.8	8.0	1.6	15	9.208 381
6.4	9.6	1.6	15	9.208 382
6.4	11.2	2.4	15	9.208 383
8.0	12.8	2.4	15	9.208 384
9.5	12.7	1.6	15	9.208 385
12.7	15.9	1.6	15	9.208 386
12.7	17.5	2.4	15	9.208 387

➔ More tubing in chapter 8 near the peristaltic pumps, see page 1047.

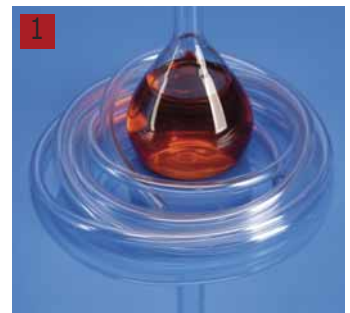

Tubing/Plastic

1

1 Tygon® tubing ELFL

Transparent, flexible, Shore A 56. *Saint Gobain*
 Temperature range -54 to +74 °C. Tygon tubing with the longest "Flex-Life" (lifespan) when used in peristaltic pumps. To FDA/USP Class VI. ISO 10993, according to REACH without phthalates. Suitable for food, drinks or pharmaceutical applications. Resists ageing and non-toxic. Resistant to many chemicals. Supplied in 7.5 m coil.

Int. diam. mm	Ext. diam. mm	Wall thickness mm	PK	Cat. No.
1.6	4.8	1.6	7	9.208 439
3.2	6.4	1.6	7	9.208 440
4.8	8.0	1.6	7	9.208 441
6.4	9.6	1.6	7	9.208 442
8.0	11.2	1.6	7	9.208 443
9.5	15.9	3.2	7	9.208 444
12.7	19.1	3.2	7	9.208 445

2

2 Flow indicators LaboPlast®

Bürkle

Gives a visual indication of liquid or gas flow in tubing. Operates in both directions and at any angle. Can accommodate flow rates down to approx. 150 ml/min Length incl. nozzle 88 mm. For tubing from 6mm to 11 mm diameter. Maximum pressure: 2 bar. Food Safe.

Choice of models:

- LiquiMobil made of SAN up to 30 °C working temperature
- CheMobil made of PMP up to 60 °C working temperature, autoclavable good, chemically resistance

Type	Colour	PK	Cat. No.
LiquiMobil/SAN	blue	1	9.003 910
LiquiMobil/SAN	red	1	9.003 911
LiquiMobil/SAN	black	1	9.003 912
CheMobil/ PMP	blue	1	9.003 913
CheMobil/ PMP	red	1	9.003 901
CheMobil/PMP	black	1	9.003 914

3

3 LLG-Hose cutter

A perfect tool to cut even thick hoses with external diameter from 6.0 mm to 25 mm. The cut edges of tubings with the tube cutter are always clean and flat. Offers a clean and sharp cut of tubings in few seconds. Hose cutter has a two end blade which can be turned when one gets blunt and the other sharp side used.

Description	PK	Cat. No.
for diam. 6 - 25 mm	1	6.267 395

Spare blades for LLG-Hose cutter

For dia. 6 - 25 mm.

Type	PK	Cat. No.
Spare blades for LLG-Hose cutter	30	4.671 809

4

4 Plastic tubing cutter

Portable, pocket-sized cutter cuts flexible tubing from 1.6 to 19 mm O.D. *Bel-Art Products*
 The jaw is lightly spring-loaded and will remain closed for safety when not in use. A replaceable, hardened steel blade makes clean, straight cuts.

Type	PK	Cat. No.
Tubing cutter	1	9.205 898
Replacement blade	1	9.205 899

1. General laboratory consumables

Tubing/Adapters, Clips, Clamps

1 Messfix tubing gauge

Small, red, handy polypropylene gauge.
For rapid measurement of internal and external diameters of tubing, test tubes etc. within the range 1.5 mm to 16 mm.

schuett-biotec



Width mm	Depth mm	Height mm	PK	Cat. No.
50	120	12	1	9.205 800

General Purpose Couplings with valve, PMC Series, Acetal

PMC coupling natural white, for standard applications, such as optical testing equipment, analytical equipment for chemicals, medical equipment and gas testing systems. Both coupling elements are fitted with a valve. When disconnecting the coupling, both sides close tightly. Main components and stop valve made of acetal. Unlocking button, springs and pins made of stainless steel 316. Material O-rings: Buna-N

Colder Products Company

- Unlocking button for one-handed operation
- Integrated connections for short installation lengths and fast installation
- With stop valve
- Combinable with MC Series couplings

Specifications

Nominal size: 1/8"
Operating pressure: Vacuum up to 8.3 bar
Operating temperature: -40 ... 82 °C



Type	Connection diam. inside	Overall length mm	PK	Cat. No.
Coupling PMCD1002BSPT, thread	1/8" BSPT	25.4	1	4.662 891
Coupling PMCD1004BSPT, thread	1/4" BSPT	27.9	1	4.662 893
Coupling PMCD1601, tubing nozzle	1/16", 1.6 mm	35.6	1	4.662 897
Coupling PMCD1602, tubing nozzle	1/8", 3.2 mm	41.9	1	4.662 899
Coupling PMCD1603, tubing nozzle	3/16", 4.8 mm	47.0	1	4.662 901
Coupling PMCD1604, tubing nozzle	1/4", 6.4 mm	47.0	1	4.662 902
Coupling PMCD1701, tubing nozzle	1/16", 1.6 mm	35.8	1	4.662 904
Coupling PMCD1702, tubing nozzle	1/8", 3.2 mm	41.9	1	4.662 906
Coupling PMCD1703, tubing nozzle	3/16", 4.8 mm	47.0	1	4.662 908
Coupling PMCD1704, tubing nozzle	1/4", 6.4 mm	47.0	1	4.662 909
Coupling PMCD13025, In-Line compression fitting	0.10", 2.5 mm	41.9	1	4.662 894
Coupling PMCD1304, In-Line compression fitting	0.17", 4.3 mm	44.5	1	4.662 895
Coupling plug PMCD2402BSPT, thread	1/8" BSPT	36.6	1	4.662 926
Coupling plug PMCD2404BSPT, thread	1/4" BSPT	36.1	1	4.662 928
Coupling plug PMCD4201, tubing nozzle	1/16", 1.6 mm	38.1	1	4.662 929
Coupling plug PMCD4202, tubing nozzle	1/8", 3.2 mm	44.5	1	4.662 930
Coupling plug PMCD4203, tubing nozzle	3/16", 4.8 mm	49.5	1	4.662 931
Coupling plug PMCD4204, tubing nozzle	1/4", 6.4 mm	49.5	1	4.662 932
Coupling plug PMCD2201, tubing nozzle	1/16", 1.6 mm	37.3	1	4.662 915
Coupling plug PMCD2202, tubing nozzle	1/8", 3.2 mm	42.4	1	4.662 917
Coupling plug PMCD2203, tubing nozzle	3/16", 4.8 mm	47.8	1	4.662 919
Coupling plug PMCD2204, tubing nozzle	1/4", 6.4 mm	43.2	1	4.662 920
Coupling plug PMCD2302, tubing nozzle	1/8", 3.2 mm	30.7	1	4.662 922
Coupling plug PMCD2304, tubing nozzle	1/4", 6.4 mm	30.7	1	4.662 924
Coupling plug PMCD20025, In-Line compression fitting	0.10", 2.5 mm	41.9	1	4.662 911
Coupling plug PMCD2004, In-Line compression fitting	0.17", 4.3 mm	39.9	1	4.662 912
Coupling plug PMCD2006, In-Line compression fitting	0.25", 6.4 mm	38.6	1	4.662 914



1

4.662 896

General Purpose Couplings with valve, PMC12 Series, PP

PMC12 coupling beige, for more demanding applications, such as microbiological analysis equipment, cleaner concentrates, electroplating fluids, sterilisation equipment and water pollutant analysis. Both coupling parts are fitted with a valve. When disconnecting the coupling, both sides close tightly. Main components and stop valve made of PP. Unlocking button, springs and pins made of stainless steel 316. *Colder Products Company*

Material O-rings: EPDM

- Unlocking button for one-handed operation
- Integrated connections for short installation lengths and fast installation
- With stop valve
- Sterilizable with gamma rays

2

4.662 923

Specifications

Nominal size valve: 1/8"
 Operating pressure: 8.3 bar, 120 psi
 Operating temperature: 0 ... 71 °C

Type	Connection diam. inside	Overall length mm	PK	Cat. No.
Coupling PMCD100212BSPT, thread	1/8" BSPT	25.4	1	4.662 890
Coupling PMCD100412BSPT, thread	1/4" BSPT	27.9	1	4.662 892
Coupling PMCD160112, tubing nozzle	1/16", 1,6 mm	35.6	1	4.662 898
Coupling PMCD160212, tubing nozzle	1/8", 3,2 mm	41.9	1	4.662 900
Coupling PMCD160412, tubing nozzle	1/4", 6,4 mm	47.0	1	4.662 903
Coupling PMCD170112, tubing nozzle	1/16", 1,6 mm	36.1	1	4.662 905
Coupling PMCD170212, tubing nozzle	1/8", 3,2 mm	42.4	1	4.662 907
Coupling PMCD170412, tubing nozzle	1/4", 6,4 mm	47.5	1	4.662 910
Coupling PMCD130412, In-Line compression fitting	0.17", 4,3 mm	44.2	1	4.662 896
Coupling plug PMCD24042812, thread	1/4" UNF	40.2	1	4.662 927
Coupling plug PMCD220112, tubing nozzle	1/16", 1,6 mm	37.3	1	4.662 916
Coupling plug PMCD220212, tubing nozzle	1/8", 3,2 mm	42.4	1	4.662 918
Coupling plug PMCD220412, tubing nozzle	1/4", 6,4 mm	43.4	1	4.662 921
Coupling plug PMCD230212, tubing nozzle	1/8", 3,2 mm	30.7	1	4.662 923
Coupling plug PMCD230412, tubing nozzle	1/4", 6,4 mm	30.7	1	4.662 925
Coupling plug PMCD200412, In-Line compression fitting	0.17", 4,3 mm	40.1	1	4.662 913

3

4.662 851

General Purpose Couplings with valve, PLC12 Series, PP

PLC12 coupling, beige, for more demanding applications, such as battery filling systems, disinfectants, dosing pumps, pharmaceutical production and chemical processing in the semiconductor industry. Both coupling parts are fitted with a valve. When disconnecting the coupling, both sides close tightly. Main components and stop valve made of PP. Unlocking button, springs and pins made of stainless steel 316. *Colder Products Company*

Material O-rings: EPDM

- Unlocking button for one-handed operation
- Integrated connections for short installation lengths and fast installation
- With stop valve
- Sterilizable with gamma rays

4

4.662 873

Specifications

Nominal size valve: 1/4"
 Operating pressure: 8.3 bar, 120 psi
 Operating temperature: 0 ... 71 °C

Type	Connection diam. inside	Overall length mm	PK	Cat. No.
Coupling PLCD1000412BSPT, thread	1/4" BSPT	29.2	1	4.662 845
Coupling PLCD1000612BSPT, thread	3/8" BSPT	29.2	1	4.662 847
Coupling PLCD1600412, tubing nozzle	1/4", 6,4 mm	49.5	1	4.662 855
Coupling PLCD1600612, tubing nozzle	3/8", 9,5 mm	49.5	1	4.662 858
Coupling PLCD1700412, tubing nozzle	1/4", 6,4 mm	49.8	1	4.662 860
Coupling PLCD1700612, tubing nozzle	3/8", 9,5 mm	49.8	1	4.662 863
Coupling PLCD1300612, In-Line compression fitting	0.25", 6,4 mm	49.8	1	4.662 851
Coupling plug PLCD2400412, thread	1/4" NPT	42.4	1	4.662 878
Coupling plug PLCD2200412, tubing nozzle	1/4", 6,4 mm	50.8	1	4.662 870
Coupling plug PLCD2200612, tubing nozzle	3/8", 9,5 mm	46.2	1	4.662 873
Coupling plug PLCD2300412, tubing nozzle	1/4", 6,4 mm	34.5	1	4.662 875
Coupling plug PLCD2300612, tubing nozzle	3/8", 9,5 mm	36.1	1	4.662 877
Coupling plug PLCD2000612, In-Line compression fitting	0.25", 6,4 mm	46.2	1	4.662 866
Coupling plug PLCD4200412, panel mounting tubing nozzle	1/4", 6,4 mm	52.1	1	4.662 886
Coupling plug PLCD4200612, panel mounting tubing nozzle	3/8", 9,5 mm	52.1	1	4.662 889

1. General laboratory consumables

Tubing/Adapters, Clips, Clamps

General Purpose Couplings with valve, PLC Series, Acetal

PMC coupling natural white, the most used coupling series, especially for applications such as floor cleaning equipment, deionized water filtration, automated machines, compression therapy and leak detectors. Both coupling elements are fitted with a valve. When disconnecting the coupling, both sides close tightly. Main components and stop valve made of acetal. Unlocking button, springs and pins made of stainless steel 316. Material O-rings: Buna-N

Colder Products Company

- Unlocking button for one-handed operation
- Integrated connections for short installation lengths and fast installation
- With stop valve
- Combinable with LC Series couplings

Specifications

Nominal size valve: 1/4"
 Operating pressure: 8.3 bar, 120 psi
 Operating temperature: -40 ... 82 °C

1



4.662 852

2



4.662 880

Type	Connection diam. inside	Overall length mm	PK	Cat. No.
Coupling PLCD10004BSPT, thread	1/4" BSPT	29.2	1	4.662 846
Coupling PLCD10006BSPT, thread	3/8" BSPT	29.2	1	4.662 848
Coupling PLCD16004, tubing nozzle	1/4", 6,4 mm	49.5	1	4.662 854
Coupling PLCD16005, tubing nozzle	5/16", 7,9 mm	49.5	1	4.662 856
Coupling PLCD16006, tubing nozzle	3/8", 9,5 mm	49.5	1	4.662 857
Coupling PLCD17004, tubing nozzle	1/4", 6,4 mm	49.5	1	4.662 859
Coupling PLCD17005, tubing nozzle	5/16", 7,9 mm	49.5	1	4.662 861
Coupling PLCD17006, tubing nozzle	3/8", 9,5 mm	49.5	1	4.662 862
Coupling PLCD13004, In-Line compression fitting	0.17", 4,3 mm	46.2	1	4.662 849
Coupling PLCD130M8, In-Line compression fitting	0.17", 6,0 mm	49.5	1	4.662 853
Coupling PLCD13006, In-Line compression fitting	0.25", 6,4 mm	49.5	1	4.662 850
Coupling PLCD130M10, In-Line compression fitting	0.25", 8,0 mm	49.5	1	4.662 852
Coupling plug PLCD24004BSPT, thread	1/4" BSPT	42.2	1	4.662 879
Coupling plug PLCD24006BSPT, thread	3/8" BSPT	41.4	1	4.662 880
Coupling plug PLCD42004, tubing nozzle	1/4", 6,4 mm	52.1	1	4.662 885
Coupling plug PLCD42005, tubing nozzle	5/16", 7,9 mm	52.1	1	4.662 887
Coupling plug PLCD42006, tubing nozzle	3/8", 9,5 mm	52.1	1	4.662 888
Coupling plug PLCD22004, tubing nozzle	1/4", 6,4 mm	50.5	1	4.662 869
Coupling plug PLCD22005, tubing nozzle	5/16", 7,9 mm	50.5	1	4.662 871
Coupling plug PLCD22006, tubing nozzle	3/8", 9,5 mm	46.0	1	4.662 872
Coupling plug PLCD23004, tubing nozzle	1/4", 6,4 mm	32.5	1	4.662 874
Coupling plug PLCD23006, tubing nozzle	3/8", 9,5 mm	32.5	1	4.662 876
Coupling plug PLCD20004, In-Line compression fitting	0.17", 4,3 mm	47.8	1	4.662 864
Coupling plug PLCD200M8, In-Line compression fitting	0.17", 6,0 mm	46.2	1	4.662 868
Coupling plug PLCD20006, In-Line compression fitting	0.25", 6,4 mm	46.2	1	4.662 865
Coupling plug PLCD200M10, In-Line compression fitting	0.25", 8,0 mm	46.2	1	4.662 867
Coupling plug PLCD40004, panel mounting compression fitting	0.17", 4,3 mm	48.5	1	4.662 881
Coupling plug PLCD400M8, panel mounting compression fitting	0.17", 6,0 mm	51.6	1	4.662 884
Coupling plug PLCD40006, panel mounting compression fitting	0.25", 6,4 mm	52.1	1	4.662 882
Coupling plug PLCD400M10, panel mounting compression fitting	0.25", 8,0 mm	52.1	1	4.662 883

General Purpose Couplings with valve, Sixtube™-Series, Acetal

The coupling elements provide a quick lock for up to six independent connections for liquid media. Stop valves can be used in the coupling, but not in the plug. With the unlocking button, six lines can be disconnected at once by pressing with the thumb. The coupling is designed for various applications, such as packaging systems, pneumatic regulators, filling of air chambers, semiconductor production, water softeners and measuring equipment. Main components, stop valve (natural white) and unlocking button (turquoise green) made of acetal, springs made of stainless steel 316. Material O-rings: Buna-N.

Colder Products Company

- Unlocking button for one-handed operation
- Integrated connections for short installation lengths and fast installation for up to six connections
- With stop valve

Specifications

Operating pressure: 6.9 bar, 100 psi
 Operating temperature: -40 ... 82 °C

3



4.662 934

4



4.662 936

Type	Connection diam. inside	Overall length mm	PK	Cat. No.
with coupling inserts, with stop valve	1/16", 1,6 mm	47.8	1	4.662 933
with coupling inserts, with stop valve	1/8", 3,2 mm	47.8	1	4.662 934
with plug inserts, without stop valve	1/16", 1,6 mm	27.9	1	4.662 935
with plug inserts, without stop valve	1/8", 3,2 mm	27.9	1	4.662 936

1

4.662 842

1 Screw caps GL 45 with general purpose coupling, BQ45GL Series

The bottle caps with quick disconnect coupling or FitQuik® tubing connection integrated in a cap for all common laboratory bottles with GL 45 thread, blue. The BQ45GL series has a hydrophobic packaging vent, a polyethylene gasket and hose barb with 1/1" (6.35 mm) ID for mounting a dip tube.

Colder Products Company

- For all bottles with thread GL 45
- Factory-installed quick couplings
- Tight closure even without seal
- One hand operation

Specifications

Nominal size: 1/4"
 Operating temperature: 0 ... 49 °C

Type	PK	Cat. No.
Coupling PMC12 Series	1	4.662 842
Coupling plug PMC12 Series	1	4.662 843
FitQuik® tubing connection	1	4.662 844

2

4.662 837

3 Accessories for General Purpose Couplings PMC, PMC12, PLC und PLC12 Series

Colder Products Company
3

Description	PK	Cat. No.
Nuts 1/16", 1.8 mm, PP, natural	1	4.662 834
Nuts 1/8", 3.0 mm, PP, natural	1	4.662 835
Nuts 1/16", 1.8 mm, acetal, black	1	4.662 836
Nuts 1/8", 3.0 mm, acetal, black	1	4.662 837
Ferrules 1/16", 1.8 mm, ETFE, blue	1	4.662 838
Ferrules 1/8", 3.0 mm, ETFE, yellow	1	4.662 839
Ferrules 1/16", 1.8 mm, ETFE, green	1	4.662 840
Ferrules 1/8", 3.0 mm, ETFE, orange	1	4.662 841

4

4 Laboratory threaded joints - GL 14/18/25

Enables GL threads to clamp easily to fluoroplastic or thick-walled tubing made out of other plastics, glass or metal. (Ideally suited for connection with Bola GL fittings, Bola pressure valves, Bola GL taps and Bola GL ball valves).

BOLA

The laboratory threaded joints consist of a red screw cap made of glass-fibre reinforced ETFE, a sealing disc and a tapered sealing ring made of PTFE, as well as a V-ring made of glass-fibre reinforced ETFE. This patented system withstands pressures up to approx. 10 bar, is suitable for a vacuum (at room temperature in the case of sizes 14 to GL 25) and is easy to assemble without tools. The substance that passes through only comes in contact with PTFE.

Bola laboratory threaded joints can, for example, be used to hold probes (including stainless steel probes), sensors, laboratory taps, submerged tubes, thermometers or as a cable feed.

For external tube diam.	Neck thread	PK	Cat. No.
mm	GL		
1.6	14	1	9.209 803
3.0	14	1	9.209 806
3.2	14	1	9.209 807
4.0	14	1	9.209 808
6.0	14	1	9.209 809
6.35	14	1	9.209 810
3.2	18	1	9.209 817
6.0	18	1	9.209 819
8.0	18	1	9.209 820
10.0	18	1	9.209 821
6.0	25	1	9.209 839
8.0	25	1	9.209 840
10.0	25	1	9.209 841
12.0	25	1	9.209 842

1. General laboratory consumables

Tubing/Adapters, Clips, Clamps

1 Laboratory Threaded Joints, GL 14/18/25/32 BOLA

Connecting equipment and fittings with GL threads with hard-walled tubing or tubes made of glass, plastic or metal. Fixing probes, thermometers, dip tubes or cables in reaction vessels. Black screw caps made of PPS, inner parts consisting of a v-ring (PPS), a tapered ring and a sealing ring (both PTFE) as well as an o-ring (FKM) for tubing diameters under 3 mm (not exposed to the medium). Good chemical resistance, the medium is only exposed to PTFE. Temperature resistant from -50 to 250 °C, pressure stable up to 10 bar, suitable for vacuum.



For external tube diam.	Neck thread	PK	Cat. No.
mm	GL		
1.0	14	1	6.901 758
1.6	14	1	6.307 933
2.0	14	1	6.307 187
3.0	14	1	6.304 933
3.2	14	1	6.303 128
4.0	14	1	7.601 156
5.0	14	1	6.237 145
6.0	14	1	6.900 068
6.35	14	1	7.603 089
8.0	14	1	6.084 147

GL fittings, PTFE BOLA

Couplings with GL connector screwthread. Connect PTFE, PFA, FEP, glass and metal tubing. Fittings are chemical and temperature resistant to approx. 250 °C. Can be used at working pressures of up to 10 bar when used in combination with Bola laboratory screwthread connections (at room temperature). A further advantage is that they can be used as expansion/reduction adapters to connect tubing of different diameters. For easy tubing connection we recommend accessory Bola Laboratory screwthread connectors which can be ordered separately.



9.207 113

Bore	Neck thread	Description	PK	Cat. No.
mm	GL			
6.5	14	straight	1	9.207 113
10.5	18	straight	1	9.207 114
14.5	25	straight	1	9.207 115
21.0	32	straight	1	9.207 116
32.5	45	straight	1	9.207 117
6.5	14	angled	1	9.207 118
10.5	18	angled	1	9.207 119
14.5	25	angled	1	9.207 120
21.0	32	angled	1	9.207 121
32.5	45	angled	1	9.207 122
6.5	14	T-shape	1	9.207 133
10.5	18	T-shape	1	9.207 134
14.5	25	T-shape	1	9.207 135
21.0	32	T-shape	1	9.207 136
32.5	45	T-shape	1	9.207 137



9.207 133

GL stopcocks, PTFE BOLA

Stopcocks with cylindrical taps and GL screwthread made of pure PTFE, giving almost total chemical resistance. Can be used at working pressures of up to 6 bar when used in combination with Bola laboratory screwthread connections (at room temperature). A further advantage is that they can be used as expansion/reduction adapters to connect tubing of different diameters. For easy tubing connection we recommend accessory Bola laboratory screwthread connectors - please order separately.



9.207 153

Description	Bore diam.	Neck thread		PK	Cat. No.
		mm	GL		
2-way	4		14	1	9.207 153
2-way	6		18	1	9.207 154
2-way	8		25	1	9.207 155
3-way, L-shape key bore	4		14	1	9.207 156
3-way, L-shape key bore	6		18	1	9.207 157
3-way, L-shape key bore	6		25	1	9.207 158



9.207 156



9.209 851

Bottle distributors

With GL-threaded necks and screw caps. Suitable for GL45 threaded bottles. The distributors are ideal for decanting liquids, whereby the necks are connected either to a liquid source or to an excess pressure or vacuum system (up to 8.5 mm max. tubing diameter). For hassle-free connection, we recommend the Bola threaded connector (please order separately) in accordance with the outer diameter of the tubing.

BOLA

Thread	Material	Neck	Description	PK	Cat. No.
GL 45	PP	3 x GL 14		1	9.209 849
GL 45	PFA	2 x GL 14		1	9.209 851
GL 45	PTFE	3 x GL 14		1	9.209 852
GL 45	PTFE	2 x GL 14	with stopcocks	1	6.226 261
GL 45	PTFE	3 x GL 14	with stopcocks	1	6.234 542
GL 25	PTFE	2 x GL 14		1	6.251 480
GL 32	PTFE	2 x GL 14		1	7.638 423
GL 45	PTFE	3 x GL 18		1	9.209 844
GL 45	PTFE	2 x GL 25		1	6.226 262
GL 45	PTFE	4 x GL 25		1	6.233 165



7.634 892

Flexible Distributors, PP

For connecting elastic tubing by simply slipping it onto hose connectors. Suitable for GL45 threaded bottles. With screw cap made of glass-fibre reinforced PP, ideal for transferring liquids or gases. The angled tubing connectors can be attached to a liquid source, a pressure source or a vacuum system. Avoid crimping of the tubing. The distributor can be loosened by simply turning the screw cap. The complete distribution system can then be fixed onto another bottle.

BOLA

For tubing bore mm	number of nozzles	PK	Cat. No.
6 - 9	2	1	7.634 892
6 - 9	3	1	9.209 858
7 - 11	2	1	9.209 859



2-way /3-way valves Laboplast®



Bürkle

Resistant to compression max. 1 bar.

- PVDF: excellent chemical resistance, transparent, suitable for food
- PP/PE: for industrial use, red/white
- Operating temperature: PVDF 0 to 40 °C, PP/PE 5 to 40 °C

For tubing bore mm	Description	Valve bore mm	Material	PK	Cat. No.
5 to 7	2-way	4	PVDF	1	9.116 771
7 to 9	2-way	6	PVDF	1	9.116 772
9 to 11	2-way	8	PVDF	1	9.116 773
11 to 13	2-way	8	PVDF	1	9.116 775
5 to 7	2-way	4	PE / PP	1	9.116 781
7 to 9	2-way	6	PE / PP	1	9.116 782
9 to 11	2-way	8	PE / PP	1	9.116 783
11 to 13	2-way	8	PE / PP	1	9.116 784
5 to 7	3-way	4	PVDF	1	9.116 776
7 to 9	3-way	6	PVDF	1	9.116 777
9 to 11	3-way	8	PVDF	1	9.116 778
11 to 13	3-way	8	PVDF	1	9.116 780
5 to 7	3-way	4	PE / PP	1	9.116 786
7 to 9	3-way	6	PE / PP	1	9.116 787
9 to 11	3-way	8	PE / PP	1	9.116 788
11 to 13	3-way	8	PE / PP	1	9.116 789

1. General laboratory consumables

Tubing/Adapters, Clips, Clamps

1 Mini tubing connectors, PP

Type	For tubing bore mm	PK	Cat. No.
Straight, AA	1.6	1	9.207 291
Straight, DD	2.5	1	9.207 292
Straight, CC	3.2	1	9.207 293
Straight, 4040	4.0	1	9.207 801
T-shape, T10	1.6	1	9.207 294
T-shape, T20	2.5	1	9.207 295
T-shape, T30	3.2	1	9.207 296
T-shape, T40	4.0	1	9.207 811
T-shape, T50	5.0	1	9.207 812
T-shape, T60	6.5	1	9.207 813
L-shape, L10	1.6	1	9.207 821
L-shape, L20	2.5	1	9.207 822
L-shape, L30	3.2	1	9.207 823
Y-shape, Y210	1.6	1	9.207 831
Y-shape, Y220	2.5	1	9.207 832
Y-shape, Y230	3.2	1	9.207 833
Reduction adapter, AD	1.6 - 2.5	1	9.207 297
Reduction adapter, AC	1.6 - 3.2	1	9.207 298
Reduction adapter, 1040	1.6 - 4.0	1	9.207 834
Reduction adapter, 1050	1.6 - 5.0	1	9.207 835
Reduction adapter, DC	2.5 - 3.2	1	9.207 299
Reduction adapter, 2040	2.5 - 4.0	1	9.207 841
Reduction adapter, 2050	2.5 - 5.0	1	9.207 842
Reduction adapter, 3040	3.2 - 4.0	1	9.207 843
Reduction adapter, 3050	3.2 - 5.0	1	9.207 844
Reduction adapter, 3060	3.2 - 6.5	1	9.207 845
Reduction adapter, 4050	4.0 - 5.0	1	9.207 846
T-reduction adapter, T230/210	1 x 1.6, 2 x 3.2	1	9.207 865
T-reduction adapter, T230/220	1 x 2.5, 2 x 3.2	1	9.207 866
T-reduction adapter, T210/220	1 x 2.5, 2 x 1.6	1	9.207 867
T-reduction adapter, T220/230	1 x 3.2, 2 x 2.5	1	9.207 869
Straight, threaded, M6210	1.6	1	9.207 871
Straight, threaded, M6220	2.5	1	9.207 872
Straight, threaded, M6230	3.2	1	9.207 873
Straight, threaded, M6240	4.0	1	9.207 874
Straight, threaded, M6250	5.0	1	9.207 875

Other materials on request!



2 Tubing connectors, TPX

Type	For tubing bore mm	PK	Cat. No.
C-1, straight	3-5	1	9.207 601
C-2, straight	5-8	1	9.207 602
Y-1, Y-shape	3-5	1	9.207 611
Y-2, Y-shape	5-8	1	9.207 612
T-1, T-shape	3-5	1	9.207 621

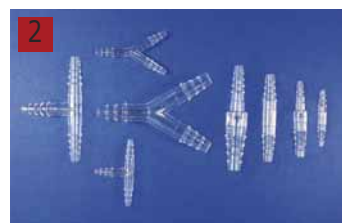

3 Tubing connectors, PP

Transparent, PP. Straight, BRAND

For tubing bore mm	Length mm	PK	Cat. No.
3 to 5	47	1	9.207 163
6 to 10	55	1	9.207 165
9 to 13	57	1	9.207 168



4 Tubing connectors, PP

Transparent, PP. Straight. Used to link tubing of different diameters. BRAND

For tubing bore mm	Length mm	PK	Cat. No.
5 to 17	110	1	9.207 270



5 Reduction adapters, PP

Transparent, PP. BRAND

For tubing bore mm	Length mm	PK	Cat. No.
3 to 5 / 6 to 10	55	1	9.207 336
6 to 10 / 9 to 13	59	1	9.207 340



➔ Glass connectors please see page 645.



1 Reduction adapters, HDPE

BRAND

For tubing bore mm	Length mm	PK	Cat. No.
8 to 10/11 to 14	66	1	9.207 356
12 to 14/18 to 20.5	73	1	9.207 357



2 L-tubing connectors, PP



Kartell

Transparent, PP. L-shape. Autoclavable.

For tubing bore mm	Length mm	PK	Cat. No.
3 to 4	15	1	9.207 251
5	21	1	9.207 252
6 to 7	25	1	9.207 253
8 to 9	30	1	9.207 254
10 to 11	36	1	9.207 255
12 to 13	42	1	9.207 256
14 to 15	48	1	9.207 257

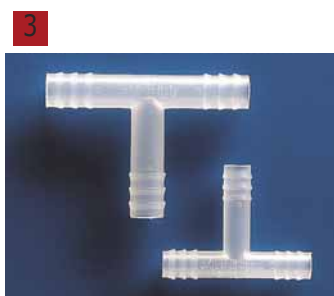

3 Tubing connectors, PP



Kartell

PP. T-shape. Autoclavable.

For tubing bore mm	Length mm	PK	Cat. No.
3 - 4	20	1	9.207 182
4 - 5	30	1	9.207 183
6 - 7	40	1	9.207 184
8 - 9	55	1	9.207 185
10 - 11	69	1	9.207 189
12 - 13	79	1	9.207 190

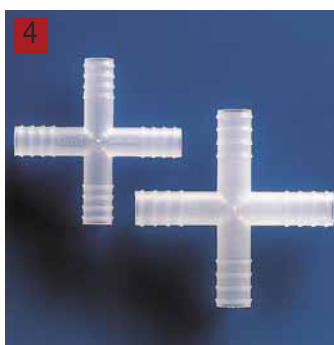

4 4 way connectors, PP



Kartell

Autoclavable.

Diam. mm	Tubing i.d. mm	PK	Cat. No.
3.5	1.5	1	9.207 241
6.0	2.7	1	9.207 242
8.0	4.6	1	9.207 243
10.0	7.0	1	9.207 244
12.0	8.0	1	9.207 245
13.5	9.5	1	9.207 246
15.0	11.6	1	9.207 247



5 Y-tubing connectors, PP



Kartell

Transparent, PP. Y-shape. Autoclavable.

For tubing bore mm	Length mm	PK	Cat. No.
3 to 4	24	1	9.207 200
4 to 5	35	1	9.207 203
6 to 7	54	1	9.207 205
8 to 9	64	1	9.207 207
10 to 11	74	1	9.207 208
12 to 13	87	1	9.207 210

1. General laboratory consumables

Tubing/Adapters, Clips, Clamps

1 120° Y connectors, PP



Kartell

Autoclavable.

Diam. mm	Tubing i.d.	PK	Cat. No.
min./max.	mm		
4/5/6	1.5	1	9.207 231
6/7/8	2.7	1	9.207 232
8/9/10	4.7	1	9.207 233
10/11/12	5.5	1	9.207 234
12/13/14	7.6	1	9.207 235
14/15/16	9.6	1	9.207 236



2 Tubing connectors, PP



Kartell

PP. Straight. White. Autoclavable.

For tubing bore mm	Length mm	PK	Cat. No.
4 to 5	39	1	9.207 221
5 to 7	52	1	9.207 222
7 to 9	59	1	9.207 223
9 to 11	59	1	9.207 224
11 to 13	66	1	9.207 225
13 to 15	66	1	9.207 226



3 Plug tubing connectors, PE

PE. Comprising of two pull-apart sections, similar to conical ground joint. Not suitable for high pressure applications.

Kartell

For tubing bore mm	Length mm	PK	Cat. No.
3 to 5	57	1	9.207 261
5 to 7	65	1	9.207 262
7 to 9	70	1	9.207 263
9 to 12	75	1	9.207 264
11 to 14	80	1	9.207 265
14 to 16	85	1	9.207 266



4 Non-return valves, HDPE

HDPE. FKM (Viton®) valve disc. Not suitable for pressure applications.

BRAND

Int. diam. mm	Length mm	PK	Cat. No.
6 to 9	80	1	9.303 039



5 Non-return valves, PP

Prevents water back-flow when pressure falls. Useful for any tubing system and vacuum line. Maximum safe working pressure: 2 bar, minimum: 0.07 bar at room temperature (20 °C).

Kartell

Int. diam. mm	PK	Cat. No.
8-10	1	9.303 028
10-15	1	9.303 029





1 Keck tubing clamps KT

Thermoplastic polyester (PBT). Continuous control of flow rate in tubing with just one finger.

For external tube diam.	Colour	PK	Cat. No.
mm			
4.5	red	1	9.205 904
6.0	yellow	1	9.205 906
10.0	blue	1	9.205 910
14.0	red	1	9.205 914



9.180 210

WILO- Curved tubing clamps

SK range. Steel. Large, plastic knurled nut with embedded brass screwthread insert which closes a metal bracket onto the curved tubing stirrup. Clamping range 10 mm to 30 mm. Temperature resistant up to 150 °C. Knurled nut made of aluminum or moulded plastic.



9.180 215

Jaw opening mm	Colour	PK	Cat. No.
10	aluminum	1	9.180 210
15	black	1	9.180 215
20	black	1	9.180 220
30	black	1	9.180 230

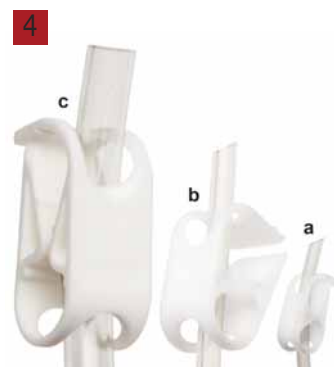

4 Tubing clamps, Acetal

Bel-Art Products



Resistant to deformation and corrosion. Autoclavable. Mini-Clamp: Single position on/off clamp. Use for thin-walled tubing with outer diameter up to 4.7 mm
 Mid-Range Clamp: Adjustable in 15 positions. Suitable for tubing with outer diameter from 3.2 to 11 mm.
 Maxi Clamp: Adjustable in 12 positions. Suitable for tubing with outer diameter up to 19 mm

Description	Figure	PK	Cat. No.
Tubing clamp, mini	a	100	6.301 574
Tubing clamp, mid-range	b	12	9.205 918
Tubing clamp, maxi	c	6	6.254 275



5 Tubing clamp, Acetal

Bel-Art Products



Clamp is molded of strong, durable plastic with serrated jaws 27 mm long. Attach at any point on tubing without disconnecting tubing. Designed to be operated with one hand, the clamp locks closed and opens when the locking tab is released.

- Autoclavable
- One hand open and close operation
- For use on tubing with a wall thickness of 0.82 mm or thinner
- When not in use, the circular opening (approximately 6 mm diameter) at hinge end allows clamp to remain attached to tubing having 6-10 mm OD with little to no restriction in flow
- Overall length is 59 mm

Type	PK	Cat. No.
Tubing clamp	12	6.200 838

1. General laboratory consumables

Tubing/Adapters, Clips, Clamps

1 2 Curved tubing clamps stop-it, PVDF

Stepless flow regulation. The micro setting screw allows very fine stepless flow control, the flow can also be shut off completely. The fully adjustable pressure plate squeezes the hose against the stable steel hook. The hose is compressed over a wide area in order to prevent it from being damaged. Easy-Click closure - Stopper can be opened and closed in any position - without tiresome screwing on and off. Stopper is with up to 140 °C heat-resistant and chemical resistant plastic PVDF, the clamp is galvanised steel. Available in 3 sizes for hose diameters up to 20 mm.

Bürkle



Colour	To fit tubing mm	PK	Cat. No.
red	0.5 to 10	1	9.303 775
red	0.5 to 15	1	9.303 776
red	1.0 to 20	1	9.303 777
yellow	0.5 to 10	1	9.303 778
yellow	0.5 to 15	1	9.303 779
yellow	1.0 to 20	1	9.303 780
blue	0.5 to 10	1	9.303 781
blue	0.5 to 15	1	9.303 782
blue	1.0 to 20	1	9.303 783
green	0.5 to 10	1	9.303 784
green	0.5 to 15	1	9.303 785
green	1.0 to 20	1	9.303 786



3 4 Tubing clamps stop-it, Metall

Tubing clamps can regulate or stop the flow through of tubings that carry fluids or gases. Stepless flow regulation: The knurled screw allows very fine stepless flow control. The flow can also be shut off completely. The fully adjustable pressure plate squeezes the hose against the stable steel hook. The hose is compressed over a wide area, in order to prevent it from being damaged, stop-it can be mounted on hoses after they have been connected. stop-it metal is extremely heat resistant and robust due to the steel and aluminum. The hose clamp is available in four different sizes up to a maximum hose diameter of 30 mm.

Bürkle



To fit tubing mm	PK	Cat. No.
0.5 to 10	1	9.303 787
0.8 to 15	1	9.303 788
1.1 to 20	1	9.303 789
2.5 to 30	1	9.303 790



5 Tubing clips, Hofmann pattern

Brass nickel plated. Bottom hinged.

Clamping range mm	PK	Cat. No.
12	1	9.180 112
17	1	9.180 117
20	1	9.180 120
25	1	9.180 125
30	1	9.180 130
40	1	9.180 140
50	1	9.180 142

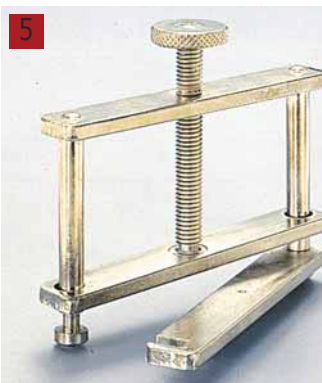

6 Tubing clips, Mohr pattern

Nickel plated. Spring pinchclip.

Length mm	PK	Cat. No.
40	1	9.180 040
50	1	9.180 050
60	1	9.180 060
70	1	9.180 070
80	1	9.180 080



7 Tubing clamps

Peau pattern. Polished stainless steel. For clamping tubing.

Bochem

Length mm	PK	Cat. No.
140	1	9.180 199
160	1	9.180 200
180	1	9.180 201





1 Tubing clamps

Hose clips, with hexagonal head.

Jaw opening mm	Material	PK	Cat. No.
5.5 ... 10	Chrome-nickel steel	1	9.207 510
8.5 ... 12	Chrome-nickel steel	1	9.207 512
9.5 ... 14	Chrome-nickel steel	1	9.207 514
12 ... 17	Chrome-nickel steel	1	9.207 517
16 ... 21	Chrome-nickel steel	1	9.207 521
20 ... 25	Chrome-nickel steel	1	9.207 525
24 ... 29	Chrome-nickel steel	1	9.207 529



2 Worm drive tubing clamps

To DIN 3017. Chrome steel 1.4016. With galvanized, worm drive screw.

Jaw opening mm	Band-width mm	PK	Cat. No.
7 to 11	5.0	1	9.207 435
11 to 19	5.0	1	9.207 436
8 to 12	7.5	1	9.207 437
10 to 16	7.5	1	9.207 439
12 to 22	9.0	1	9.207 440
16 to 25	9.0	1	9.207 445
20 to 32	9.0	1	9.207 452
25 to 40	9.0	1	9.207 460
32 to 50	9.0	1	9.207 465
40 to 60	9.0	1	6.241 130



3 Herbie tubing clamps

Beetle nylon 6.6. Simple to assemble by pressing together without the need for tools. Quick to detach with side dislocation. Good chemical resistance. Temperature resistant from -40 °C to +170 °C. Longterm temperature 125 °C, shortterm temperature 170 °C.

Type	Jaw opening mm	PK	Cat. No.
AA	6.5 to 7.9	1	9.207 707
B	7.9 to 9.2	1	9.207 708
BB	9.2 to 10.3	1	9.207 709
C	10.2 to 11.8	1	9.207 710
D	12.0 to 13.8	1	9.207 712
E	13.1 to 15.1	1	9.207 713
F	15.0 to 17.1	1	9.207 715
G	16.9 to 19.1	1	9.207 717
H	18.1 to 20.6	1	9.207 718
I	20.3 to 23.0	1	9.207 720
K	22.2 to 24.9	1	9.207 722
L	24.5 to 27.6	1	9.207 725



4 Tubing clamps POM

Hose clips made of Polyacetal (POM).

Bürkle

Jaw opening mm	PK	Cat. No.
6.0 to 6.5	10	6.052 587
9.0 to 10	10	6.052 588
10.0 to 11	10	6.052 589
11.0 to 12	10	6.052 590
12.0 to 14	10	6.052 591
13.0 to 15	10	6.052 592
15.0 to 17	10	6.052 593
17.0 to 19	10	6.052 594
18.0 to 20	10	6.052 595
20.0 to 22	10	6.052 596
23.0 to 25	10	6.052 598

1. General laboratory consumables

General laboratory aids/Labels

1 Indicator Tape, Comply™

Lead free version available now. 3M Deutschland
 Semi-crepe paper. Self adhesive. Very good adhesion on various soft packagings.
 Tape stretches to minimize tape pop-off, which reduces need for re-sterilization due to packs opening during processing. Accepts handwriting and labelling for easy use and better record keeping.
 Supplied in a roll of 55 m or strips of 200 mm.



Type	For	Size	PK	Cat. No.
Comply™	Dry-Heat Sterilisation	19 mm x 55 m	1	9.140 783
Comply™ lead free	Steam Sterilisation	18 mm x 55 m	1	9.140 786

2 Adhesive parcel tape tesapack® 4124

tesapack® 4124, transparent.



Description	Width mm	Length m	PK	Cat. No.
Adhesive parcel tape	25	66	1	9.140 814
Adhesive tape dispenser	25		1	9.140 815

3 Adhesive parcel tape tesapack® 4024

Strong, brown tape.



Width mm	Length m	PK	Cat. No.
50	66	1	9.140 813

4 Adhesive tape dispenser tesa® 6285

For sealing cardboard boxes, using accessory tesapack®, tesafilm® or tesakrepp® sealing materials.



Width mm	PK	Cat. No.
50	1	9.140 817



General laboratory aids/Labels

1

1 LLG-Labeling tapes

NEW

For labelling and colour coding of laboratory vessels and utensils. Strong and durable. Water resistant. Can withstand temperatures ranging from -23 °C to +121 °C. The tapes are easy to write-on and leave no residue when removed. Rolls of 12.7 m.

Width mm	Colour	PK	Cat. No.
12.7	white	6	4.663 401
12.7	yellow	6	4.663 402
12.7	green	6	4.663 403
12.7	red	6	4.663 404
12.7	orange	6	4.663 405
12.7	blue	6	4.663 406
12.7	pink	6	4.663 407
12.7	3 x blue, 3 x green, 3 x orange, 3 x red, 5 x white, 4 x yellow, 3 x pink	24	4.663 408
19.0	white	4	4.663 409
19.0	yellow	4	4.663 410
19.0	green	4	4.663 411
19.0	red	4	4.663 412
19.0	orange	4	4.663 413
19.0	blue	4	4.663 414
19.0	pink	4	4.663 415
19.0	2 x blue, 2 x green, 2 x orange, 2 x red, 4 x white, 2 x yellow, 2 x pink	16	4.663 416
25.4	white	3	4.663 417
25.4	yellow	3	4.663 418
25.4	green	3	4.663 419
25.4	red	3	4.663 420
25.4	orange	3	4.663 421
25.4	blue	3	4.663 422
25.4	pink	3	4.663 423
25.4	1 x blue, 2 x green, 1 x orange, 2 x red, 2 x white, 2 x yellow, 2 x pink	12	4.663 424

2

2 Adhesive label tape Write-on™, writable

Bel-Art Products

Specially coated plastic tape with adhesive backing. Makes labels of any length. Can be used with any pens. Excellent adhesion to glass, metal, PE, etc. Resistant to humidity, as well as acids and alkali solutions in weak concentrations. Leaves no residue when removed.

Temperature resistance
 up to 157 °C: 30 min
 up to 80 °C: 24 h
 Resistant to -80 °C.
 Autoclavable at 121 °C.

Colour	Width mm	Length m	PK	Cat. No.
white	12.7	36.4	1	9.040 379
white	19.0	36.4	1	9.040 380
white	25.4	36.4	1	9.040 381
white	12.7	54.6	1	9.040 351
white	19.0	54.6	1	9.040 352
white	25.4	54.6	1	9.040 353
red	12.7	36.4	1	9.040 336
red	19.0	36.4	1	9.040 341
red	25.4	36.4	1	9.040 346
yellow	12.7	36.4	1	9.040 337
yellow	19.0	36.4	1	9.040 342
yellow	25.4	36.4	1	9.040 347
green	12.7	36.4	1	9.040 338
green	19.0	36.4	1	9.040 343
green	25.4	36.4	1	9.040 348
blue	12.7	36.4	1	9.040 339
blue	19.0	36.4	1	9.040 344
blue	25.4	36.4	1	9.040 349
orange	12.7	36.4	1	9.040 340
orange	19.0	36.4	1	9.040 345
orange	25.4	36.4	1	9.040 350

1. General laboratory consumables

General laboratory aids/Labels

1 Adhesive tape dispenser Write-On™ Economy

Provides a smooth writing surface, making labeling easy and fast. When marked tape is advanced and cut off on the serrated edge, a fresh length of label tape is positioned on the writing platform. Plastic cutting edge is moulded into the housing. Various widths and colours of tape rolls can be mixed together on the spindles, which accommodates 5 or more 12 to 19 mm narrow rolls or 4 x 25 mm wide rolls. Spindles are easily removed from the unit for loading and unloading and can be adjusted to hold either 25 or 75 mm core diameter rolls.

Bel-Art Products

- Includes three plastic separating discs to assure smooth, snag free dispensing for up to four rolls of tape (additional discs on request).
- Moulded-in pen holder wells on the dispenser help to keep writing instruments handy
- Ideal for use with the full line of Write-On™ Tapes, which are available in 6 colors and 3 widths.
- Includes mounting holes for secure attachment to a benchtop (screws not included).
Can also be attached to vertical surfaces using Wall Mount Adapter
- Dimensions (W x D x H): 302 x 143 x 105 mm



Items supplied: Adhesive tape dispenser incl. 1 roll of 12 mm white Write-On™ Labeling Tape

Type	PK	Cat. No.
Write-On™ Economy	1	9.040 389

2 Adhesive tape dispenser

Suitable for holding and releasing the tape to be cut to users desire. The core perfectly fits to the inner diameter of the tape and keeps the tape rigid. Platform includes a writing surface. Finger holes on the platform enables quick release of the tape and accelerates the cutting step. Featured with a cut-off edge for efficient cutting of the tape. A weighted base with non-skid pads prevent sliding or lifting.

ISOLAB

Overall dimensions: 155 x 250 x 100 mm.
Cutting platform dimensions: 155 x 110 mm.



Type	PK	Cat. No.
Adhesive tape dispenser	1	6.286 759

3 Adhesive label tape

Manufactured from colored paper with special resin adhesive that resists to moisture and most solvents. Can be used between -5 to 110 °C temperature range. Also withstands steam autoclaving cycle and gamma irradiation. Adheres to any clean surface including PTFE coated surfaces and peels off without leaving any sticky residue. Accepts writing from almost all pen types such as pencil, ball point pen, solvent ink marker etc. Markings remain absolutely legible under the most demanding laboratory conditions.

ISOLAB

Supplied as white, color or as pack of 6 different colors matching the universal hazard color codes yellow for chemical reactivity, blue for health hazards, green for safety, red for flammability, orange tape for biohazard and white for general use.

Rolls of 30 m.



Width mm	Colour	PK	Cat. No.
19	White	1	6.286 758
19	Yellow, blue, green, red, orange, white	6	6.286 757

4 Adhesive labels

Manufactured from polypropylene flexible paper with acrylic resin adhesive back. This unique combination does not expand and retract together with temperature fluctuations and therefore always guarantees a strong adhesive bond. Chemically inert, resists to water, moisture and most organic solvents and caustic agents. Can be used between -96 to + 121 °C temperature range. Also withstands steam autoclaving cycle and gamma irradiation Adheres to any clean surface including PTFE coated surfaces without cracking, peeling and degrading. Peels off without leaving any sticky residue.

ISOLAB



Length mm	Width mm	PK	Cat. No.
30	50	1000	6.286 760
72	40	1000	6.286 761
90	50	1000	6.286 762

General laboratory aids/Labels

1

1 Adhesive Labels, white

Self-adhesive labels for hand lettering or print on printing presses. Mounted true to register on sheets with gripper and feeder margin. Each pack contains 2 extra sheets for setting-up operations. Format of the sheets 168 x 120 mm. Length varies in accordance with label size. The sheet sizes and register, however, are absolutely identical for each type. Not suitable for PC printers.

- Made of wood-free paper (75 g/qm)
- Chlorine-free bleached, PEFC-certified
- Solvent-free adhesive

Width mm	Length mm	PK	Cat. No.
12	30	10000	9.040 612
13	40	5000	9.040 614
16	22	10000	9.040 616
19	40	5000	9.040 618
20	50	5000	9.040 620
25	40	5000	9.040 625
34	53	2500	9.040 635
34	67	1000	9.040 636
52	82	1000	9.040 652

2

2 Deep freeze labels, white

Self-adhesive deep-freeze labels on A4 sheets. Perfect for all PC printers (laser/inkjet/dot-matrix), copiers and multi-functional machines. Suitable for colour printers and copiers.

- Chlorine-free bleached special paper, PEFC-certified
- Solvent-free adhesive
- Label paper and adhesive are extremely resistant to temperatures (down to -60 °C, Min. adhesive temperature: -25 °C)
- Good adhesive properties at normal temperatures

Width mm	Length mm	PK	Cat. No.
38.1	21.2	25	6.201 004
66.0	33.8	25	6.201 005

3

3 Deep freeze labels

Manufactured from polyfiber grade flexible paper with acrylic resin adhesive back. This unique combination expands and retracts together with temperature fluctuations and always guarantees a strong adhesive bond. Chemically inert, resists to water, moisture and most organic solvents and caustic agents. Can be used between -196 to +80 °C temperature range. Sticks to any clean surface including PTFE coated surfaces without cracking, peeling and degrading. Peels off without leaving any sticky residue. Recommended to be used on tube caps with different diameters.

Supplied as white color or pack of 6 different colors matching the universal hazard color codes (yellow for chemical reactivity, blue for health hazards, green for safety, red for flammability, orange tape for biohazard and white for general use).

ISOLAB

Diam. mm	Colour	For vessels	PK	Cat. No.
9.5	white	0.5 ml Tubes	1000	6.286 763
9.5	yellow, blue, green, red, orange, white	0.5 ml Tubes	6000	6.286 764
13.0	white	1.5/2.0 ml Tubes	1000	6.286 765
13.0	yellow, blue, green, red, orange, white	1.5/2.0 ml Tubes	6000	6.286 766
19.0	white	15 ml Tubes	500	6.286 767
25.0	white	50 ml Tubes	500	6.286 768

1. General laboratory consumables

General laboratory aids/Labels

1 Labels

Manufactured from polyfiber grade flexible paper with acrylic resin adhesive back. This unique combination expands and retracts together with temperature fluctuations and always guarantees a strong adhesive bond. Chemically inert, resists to water, moisture and most organic solvents and caustic agents. Can be used between -40 to +121 °C temperature range. Also withstands steam autoclaving cycle and gamma irradiation. Adheres to any clean surface including PTFE coated surfaces without cracking, peeling and degrading. Peels off without leaving any sticky residue. Recommended to be used on flat or round surfaces with different diameters. Supplied as 1000 label rolls packed in a dispenser box for practical use.

ISOLAB



Dimensions (W x D) mm	Colour	For vessels	PK	Cat. No.
24 x 13	white	0.5 ml Tubes	1000	6.286 834
24 x 13	yellow, blue, green, red, orange, white	0.5 ml Tubes	6000	6.286 835
33 x 13	white	1.5/2.0 ml Tubes	1000	6.286 836
33 x 13	yellow, blue, green, red, orange, white	1.5/2.0 ml Tubes	6000	6.286 837
38 x 19	white	general purpose	1000	6.286 838

2 Label Dispenser for Deep freeze labels

Perfect organizer for fast and efficient use of labels. Manufactured from clear acrylic and holds 6 label box. Drop the label box in the label dispenser and feed the paper through the slot. The writing surface enables easy and clean writing on the label. The sharp cutting edge helps to tear off the labels. A weighted base with nonskid pads prevents sliding or lifting. The article is delivered without pen.

ISOLAB



Type	PK	Cat. No.
Label Dispenser for Deep freeze labels	1	6.286 769

3 Deep freeze labels TOUGH-SPOTS®

Pre-cut Peel-off round lables for 0.5 and 1.5/2.0 ml microcentrifuge tube tops. Temperature resistant from -196 °C to 80 °C. Easy to write on: PVC labels accept writing from most lab markers. Convenient: Dispensing box assists in labeling individual tubes used in small experiments.

Heathrow Scientific



Colour	Diam. mm	For vessels	PK	Cat. No.
White	9.5	0.5 ml Tubes	1000	9.040 711
Blue	9.5	0.5 ml Tubes	1000	9.040 712
Green	9.5	0.5 ml Tubes	1000	9.040 713
Red	9.5	0.5 ml Tubes	1000	9.040 714
Yellow	9.5	0.5 ml Tubes	1000	9.040 715
Pink	9.5	0.5 ml Tubes	1000	6.267 506
Coffee	9.5	0.5 ml Tubes	1000	6.267 517
Orange	9.5	0.5 ml Tubes	1000	6.267 518
White	13.0	1.5/2.0 ml Tubes	1000	9.040 716
Blue	13.0	1.5/2.0 ml Tubes	1000	9.040 717
Green	13.0	1.5/2.0 ml Tubes	1000	9.040 718
Red	13.0	1.5/2.0 ml Tubes	1000	9.040 719
Yellow	13.0	1.5/2.0 ml Tubes	1000	9.040 720
Lavendel	13.0	1.5/2.0 ml Tubes	1000	6.287 530

4 Deep freeze labels Cryo-Babies®/Cryo-Tags®

Temperature resistant from -196 °C to +150 °C. All labels withstand freezer temperatures down to -196 °C (liquid and vapour phase nitrogen), boiling water baths, autoclaving and moderate ovens (150 °C). Chemically inert labels resist most organic solvents and caustic agents. They adhere to most plastics, glass and metals without cracking, peeling or degrading. Made with a flexible, polyolefin label material and acrylic adhesive. This unique combination expands and contracts together with temperature fluctuations resulting in a strong adhesive bond. Convenient dispensing box assists in labeling individual tubes used in small experiments. Easy to write on. PVC labels accept writing from most lab markers including solvent resistant pens.

Heathrow Scientific



Type	Colour	Dimensions (W x D) mm	For vessels	PK	Cat. No.
Cryo-Babies®	White	24 x 13	0.5 ml tubes	1000	9.100 030
Cryo-Babies®	White	33 x 13	1.5/2.0 ml tubes	1000	9.100 031
Cryo-Tags®	White	38 x 13	General application	1000	9.100 032

➔ Cryogenic items - please see our chapter 7.

General laboratory aids/Labels



1 Laser deep freeze labels Cryo-Babies®

Temperature resistant from -196 °C to +150 °C. All sheets withstand freezer temperatures down to -196 °C (liquid and vapor phase nitrogen), boiling water baths (100 °C), autoclaving and moderate oven temperatures (150 °C). Chemically inert label sheets resist most organic solvents and caustic agents. They adhere to most plastics, glass and metals without cracking, peeling and degrading. Made with a flexible, polyfin label material and acrylic adhesive. This unique combination expands and contracts together with temperature fluctuations resulting in a strong adhesive bond. Label sheets are specially top-coated to readily accept laser printing. Heat-resistant, stay-flat sheets will not jam in laser printers.

Heathrow Scientific

Type	Dimensions (W x D) mm	For vessels	PK	Cat. No.
Cryo-Babies®	24 x 13	0.5 ml tubes	2380	6.284 640
Cryo-Babies®	33 x 13	1.5/2.0 ml tubes	1700	9.100 033



2 Labels Tough-Tags®

Temperature resistant from -40 °C to +121 °C. Tough-Tags resist boiling water baths, autoclaving and moderate freezer temperatures. Chemically inert labels resist most organic solvents and caustic agents. They adhere to most plastics, glass and metals without cracking, peeling and degrading. Tubes are pre-cut, peel-off labels which accept many marking instruments. They are perfectly sized to fit microcentrifuge tubes and other containers in the laboratory. Tubes labeled with Tough-Tags® easily slide in and out of centrifuge rotors without binding.

Heathrow Scientific

Colour	Dimensions (W x D) mm	For vessels	PK	Cat. No.
White	24 x 13	0.5 ml tubes	1000	9.100 045
White	24 x 13	0.5 ml tubes	2975	6.282 716
Blue	24 x 13	0.5 ml tubes	1000	9.100 046
Green	24 x 13	0.5 ml tubes	1000	9.100 047
Red	24 x 13	0.5 ml tubes	1000	9.100 048
Yellow	24 x 13	0.5 ml tubes	1000	9.100 049
White	33 x 13	1.5/2.0 ml tubes	2125	6.900 300
White	33 x 13	1.5/2.0 ml tubes	1000	9.100 040
Clear	33 x 13	1.5/2.0 ml tubes	1000	6.200 977
Blue	33 x 13	1.5/2.0 ml tubes	1000	9.100 041
Green	33 x 13	1.5/2.0 ml tubes	1000	9.100 042
Red	33 x 13	1.5/2.0 ml tubes	1000	9.100 043
Yellow	33 x 13	1.5/2.0 ml tubes	1000	9.100 044
White	38 x 6	Microplates	1000	9.100 050
White	21 x 7	PCR tubes	1500	9.100 051
White	38 x 19	General application	1000	9.100 052

3



9.412 810

Label remover SOLVENT 50/SOLVENT 50 SUPER

SOLVENT 50 is a highly effective label solvent for the effortless removal of self adhesive labels on the basis of natural orange terpenes. It works on the adhesive and quickly and gently dissolves adhesive labels on glass, porcelain, metal, wood, foil and cardboard. SOLVENT 50 also removes sticky residue of any kind, such as tar spots or glue residue from stickers. Check compatibility when using on plastics. Not suitable for polystyrene.

CRC

SOLVENT 50 SUPER ist the label remover with brush and NSF K3-Registration for use in the food industry. The optimised formula has high dissolving capacity to remove paper labels and all kinds of adhesive residues.



H phrases: H222|H229|H315|H319|H336|H411|H317

4



6.270 569

Type	Capacity ml	PK	Cat. No.
Solvent 50, Spray can	200	1	9.412 810
Solvent 50 Super, Spray can, with dosing brush	200	1	6.270 569

1. General laboratory consumables

General laboratory aids/Labels

1 BMP™21 Plus Hand-held label printer

Brady

The portable label printer BMP™21 Plus creates long lasting labels which adhere securely. Even under extremely demanding industrial applications the thermal transfer printer BMP™21 labels are pin sharp and clearly legible.

Key Features:

- Hard wearing design
- 203 dpi thermal transfer print
- Large LCD Display (3 lines of text, 1 line of icons)
- Left or right handed cutter activation
- Automatic data serialisation and built-in graphics and barcodes

1



Type	PK	Cat. No.
BMP™21 Plus	1	9.040 586

2 BMP™21-LAB Hand-held label printer

NEW
Brady

The BMP21-LAB Portable Label Printer is an all-in-one labeller for research, academic and clinical labs. With label materials designed specifically for harsh environments, the BMP21-LAB printer can quickly and easily create legible labels for flat, curved or highly textured surfaces that stay stuck for years even when exposed to extreme temperatures and chemicals. It's durable (Lithium-ion battery) and easy to use (drop-lock-and-go cartridges, simple to operate, quick to print). 2 year Warranty.

Scope of delivery label printer BMP™21-LAB: printer + lanyard + instructions + label cassette

Scope of delivery Starter set BMP™21-LAB: Printer + Li-Ion accu + EU plug + lanyard + instructions + label cassette

2



Type	PK	Cat. No.
Label printer BMP™21-LAB	1	6.264 079
Starter set BMP™21-LAB	1	7.910 817

3 Accessories for BMP™21 Hand-held label printer

Brady

Description	PK	Cat. No.
Magnet	1	9.040 556
Tool	1	9.040 557
AC Adapter - Europe 220V	1	9.040 553
AC Adapter - UK 220V	1	9.040 554
AC Adapter - USA 110V	1	9.040 552

3



General laboratory aids/Labels-Documenting

Application Key for Brady labels

F =	Freezer (-70 °C)
N =	Liquid Nitrogen (-196 °C)
A =	Autoclave
H =	Hot Water Bath (100 °C)
S1 =	Self-laminating label
L =	Low-Profile (extremely thin)
V =	Vial Identification
S2 =	Slide Identification
P =	Plate Identification
G =	General Identification

Brady labels Material overview

Type B-499:	Permanent adhesive, write-on capabilities
Type B-461:	Permanent adhesive - suitable for liquid nitrogen application if label material is wrapped around itself, as in self-lamination, write-on capabilities
Type B-481:	Clear polyester will remain resistant when exposed to xylene and other chemicals that are commonly used in the slide staining process.
Type B-488:	Permanent acrylic adhesive - ideal for flat surfaces, write-on capabilities, excellent solvent resistance and xylene resistance
Type B-427:	Permanent acrylic adhesive; self-laminating, write-on capabilities, suitable for liquid nitrogen application and can be used to ID a frozen vial if label material is wrapped around itself, as in self-lamination
Type B-492:	Label material that will adhere to frozen surfaces
Type B-595:	Mark aisles, passageways, storage locations, point out safety equipment, exits. Indoor/outdoor marking film, high gloss, durable, flexible. Temperature range: -40 °C to 82 °C, durability outdoors up to 10 years.

Labels for BMP™21 Hand-held label printer

Black on white. Brady's laboratory labels are designed to withstand extreme laboratory environments. The labels are resistant against high/low temperatures, solvents and chemicals (Alcohol and DMSO).

Brady

Type	For	Width mm	Material	PK	Cat. No.
B-461	F N A H S1 L V S2	9.50	Polyester	1	9.040 562
B-461	F N A H S1 L V S2	12.70	Polyester	1	9.040 574
B-461	F N A H S1 L V S2	19.05	Polyester	1	9.040 575
B-499	F N A V P G	9.53	Nylon cloth	1	9.040 576
B-499	F N A V P G	12.70	Nylon cloth	1	9.040 577
B-499	F N A V P G	19.05	Nylon cloth	1	9.040 578
B-488	F A S2 P G	9.53	Polyester	1	9.040 579
B-488	F A S2 P G	12.70	Polyester	1	9.040 580
B-488	F A S2 P G	19.05	Polyester	1	9.040 581
B-427	F N S1 V S2 P G	19.05	Vinyl	1	9.040 582
B-427	F N S1 V S2 P G	25.40	Vinyl	1	9.040 583
B-427	F N S1 V S2 P G	30.48	Vinyl	1	9.040 584
B-427	F N S1 V S2 P G	38.10	Vinyl	1	9.040 585

1



1 Labels for Label Printer BMP21

Brady

Type	Width mm	Height mm	Colour	Material	PK	Cat. No.
M21-375-7425	9.53	6.4	black on white	PP	1	7.660 786
M21-500-7425	2.70	6.4	black on white	PP	1	7.660 784
M21-750-7425	19.05	6.4	black on white	PP	1	7.660 787

2



2 3 Laboratory markers edding 8014/8015 F

Edding

Fine nib for clear labelling on small surfaces. Particularly suited for smooth and transparent surfaces e.g. slides, reaction vessels, labware and labels. Quick-drying, smudge-proof, waterproof, lightfast and low-odour.

Tested quality: extreme resistance to abrasion and high temperatures - tested and approved by TÜV Saarland.

3



Type	Colour	Bullet Nib mm	PK	Cat. No.
8014	Black	1	10	4.667 514
8015 F	Black	0.75	10	4.678 202

1. General laboratory consumables

General laboratory aids/Documenting

1 2 Permanent markers, edding 404/400

Permanent marker with very fine round tip. Low-odour, smudge-proof, water-resistant, quick drying, lightfast, refillable (only e-400). Replaceable tips. For labelling on almost all surfaces, including glass, metal and plastics. Alcohol-based ink without toluene/xylene.

Edding

Type	Colour	Line width mm	PK	Cat. No.
404	Black	0.75	10	4.667 507
404	Red	0.75	10	4.667 512
404	Blue	0.75	10	4.667 510
400	Black	1.00	10	4.667 505
400	Red	1.00	10	4.667 509
400	Blue	1.00	10	4.667 513



3 Permanent markers edding 3000

The classic with round tip. Line width approximately 1.5 to 3 mm. Low-odour, smudge-proof and water-resistant and quick drying. Refillable. Replaceable tips. For labelling, painting and writing on virtually all materials, including glass, metal and plastics. Alcohol-based ink without toluene/xylene. Colours as outlined below.

Edding

Description	Colour	PK	Cat. No.
3000	Black	10	4.667 506
3000	Red	10	4.667 508
3000	Blue	10	4.667 511
3000/4S Prof.	Black, Red, Blue, Green	1	7.673 256



4 Permanent marker Sharpie®

Dual-tip pen set (fine and extra fine), 8 colours (black, berry, lime, navy, orange, purple, sky blue, and turquoise). Suitable for colony counter count Cat. No. 9.521 783.

Heathrow Scientific

Description	PK	Cat. No.
Permanent marker Sharpie® Set	8	7.656 684



5 Lab markers, 1.0mm point

Writes on dry or wet surfaces including glass, plastic, china and metal. Colour does not run in water or alcohol when used normally, but can be washed off.

Colour	PK	Cat. No.
black	1	9.050 601
red	1	9.050 602
blue	1	9.050 603
green	1	9.050 604



6 CD/DVD/BD markers, edding 8400

Line width approx. 0.5 mm to 1 mm. Special marker for the careful and permanent labelling of CDs, DVDs and Blu-ray discs. Soft tip and special water-based ink (solvent-free) will not damage the sensitive surface of the data layer unlike alcohol-based ink. Ink is smudge-proof and water-resistant on drying.

Edding

Colour	PK	Cat. No.
Black	1	9.050 696
Red	1	6.205 732
Blue	1	6.207 025



7 Utility marker, sterile

The utility markers are suitable for marking labels and sample vessels. They contain disinfectant-resistant, non-toxic ink. 9 adhesive labels are included.

- Sterile
- Latexfree

Description	Colour	PK	Cat. No.
Fine tip	Black	50	6.311 273



General laboratory aids/Documenting

1

1 LLG-Lab Notebook

For recording research data, experimental procedures, and design ideas. Use these notebooks to keep your information safe and well organised. Numbered, acid-free, grid pages include spaces for title, project number, book number, date, and witness signature. Lined notebooks feature college ruled pages for easy report writing. Covers are waterproof and chemical-resistant. All notebooks contain periodic and conversion tables in the back. Admissible as court evidence when used as prescribed by law.

Measures: 216 x 279 mm.

Type	Description	Colour	PK	Cat. No.
grid	100 pages	black	1	9.050 750
grid	200 pages	blue	1	9.050 751
lined	200 pages	red	1	9.050 752

2

3

2 3 Molecular model system miniDNA®/RNA Kits

The advanced miniDNA® system comprises colour-coded, abstract-shaped parts designed to represent the nitrogenous bases, pentagonal sugar and pyramidal phosphate components needed to make a double-helix model of DNA. The three hydrogen bonds that connect Cytosine to Guanine and the two that connect Thymine to Adenine are represented by the appropriate number of pegs.

Two DNA kits are available to make either a 12-layer (1 turn) or 22-layer (2 turns) DNA model. The models can be displayed on their stands, or unzipped into a ladder form to demonstrate the process of Replication.

A similar approach can be taken with the two RNA kits to model the process of Protein Synthesis.

Type	Description	PK	Cat. No.
miniDNA®	12-layer Kit	1	6.261 370
miniDNA®	22-layer Kit	1	6.261 344
RNA Kit	12-base Kit	1	6.265 752
RNA Kit	24-base Kit	1	6.265 753

4

9.883 103

Molecular model system Molymod®

The Molymod® system is a unique system of high quality molecular models. The set consists of a variety of atom parts and links designed to make a large number of possible structures relevant to a specific chemistry subject or use, e.g. Biochemistry, Organic or Inorganic. All sets are fully compatible. Atom parts are made of solid clouded plastic spheres. They are available with holes from 1 to 6 in the usual angular orientations.

Type	Description	PK	Cat. No.
Introductory Set	48 atoms, 62 links	1	9.883 101
Organic Set, large	111 atoms, 140 links	1	9.883 103
Biochemistry Set, large	257 atoms, 160 links	1	9.883 107
Organic Set, small	50 atoms, 64 links	1	9.883 108
Inorganic/Organic Set, small	51 atoms, 38 links	1	9.883 109
Inorganic/Organic Set, large	106 atoms, 86 links	1	9.883 104
Biochemistry Set, small	72 atoms, 40 links	1	9.883 110
Organic Set, Stereochemistry, large	168 atoms, 192 links	1	7.981 659
Organic Set, Stereochemistry, small	70 atoms, 92 links	1	4.658 680
Benzene, Ethane, Ethene, Ethyne	12 C atoms, 18 H atoms, 9 π -bonds, 18 σ -bonds	1	9.883 111
Atomic Orbital collection set	14 models	1	6.280 325
Shapes of Molecules	8 models	1	6.280 326
advanced level chemistry set	64 atoms, 38 links	1	6.266 240

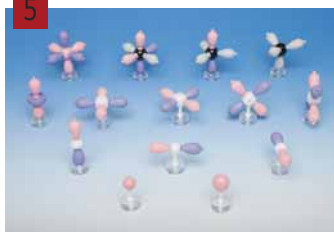
5

6.280 325

6 Molecular model system, Crystal structure Molymod®

Pre-assembled or to-be-assembled crystal structures of anorganic salts and elements.

Type	Description	PK	Cat. No.
Caesium chloride*	30 atoms	1	4.658 681
Calcium carbonate*	66 atoms	1	4.658 682
Calcium fluoride (Fluorite)*	30 atoms	1	6.280 320
Copper, iron, zinc*	40 atoms	1	6.280 321
Silicon dioxide	38 atoms	1	4.658 683
Sodium chloride	36 atoms	1	4.658 684
Sodium chloride	27 atoms	1	9.883 114
Carbon, Diamond	30 atoms	1	9.883 112
Carborundum	30 atoms	1	4.658 685
Graphite	45 atoms	1	9.883 113
Buckminster fullerene C60	60 atoms	1	6.280 318
Zinc sulphite	45 atoms	1	4.658 686
Water units (Ice)	26 units	1	9.883 115
Silicon Dioxide	66 atoms	1	4.658 687
Inorganic (sulphur)	24 atoms	1	6.280 319

*pre-assembled

6

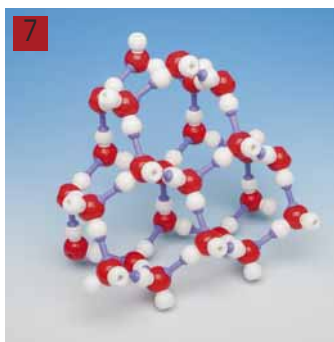
7

9.883 115

1. General laboratory consumables

General laboratory aids/Documenting-Laboratory jacks

Molecular model system, macromolecules, organic Molymod®

Monomeric units for the presentation of organic macromolecules.

Type	Description	PK	Cat. No.
PVC - Polyvinyl chloride	5 monomeric units	1	4.658 688
Polypropylene	5 monomeric units	1	4.658 689
Polystyrene	5 monomeric units	1	4.658 690
Polyester	5 monomeric units	1	4.658 691
Nylon 6.6	5 monomeric units	1	4.658 692
Glucose	2 molecules	1	4.658 693
Sucrose	1 molecule	1	4.658 694
Starch or Cellulose	3 Glucose Units	1	4.658 695
7 Amino acid Set	7 models	1	4.658 696
20 Amino acid Set	20 models	1	4.658 697
Polypeptide	5 peptide units	1	4.658 698
Protein-Beta pleated sheet	15 peptide units	1	4.658 699
Alpha Helix	15 peptide units	1	4.658 700
Amino acid	peptide upgrade 8 models	1	6.280 327

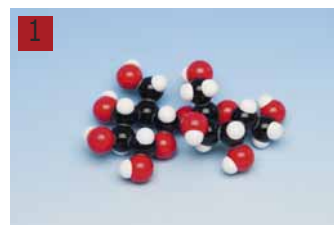

4.658 694



4.658 696

3 LLG-Laboratory jack, stainless steel

Plates made of stainless steel. Top plate with Ø 10 mm hole. With non-skid rubber feet. Acc. to DIN 12897.

Width	Depth	Min. height	Max. height	Max. stat.	Max. dyn.	PK	Cat. No.
mm	mm	mm	mm	kg	kg		
200	200	60	270	30	7	1	9.117 220



4 Swiss Boy laboratory jacks, anodised aluminium.

Anodised aluminium. Corrosion proof, stable and easily adjustable. Upper and lower end positions are adjustable. At reaching the setting, the laboratory support stops automatically. In various colours as outlined below.

Colour	Width	Depth	Min. height	Max. height	Max. stat.	PK	Cat. No.
	mm	mm	mm	mm	kg		
Green	40	50	31	93	20	1	9.117 100
Blue	75	80	49	147	30	1	9.117 105
Pink	140	120	60	243	50	1	9.117 110
Gold	150	122	80	278	80	1	9.117 115
Light blue	216	180	95	398	90	1	9.117 116
Grey	320	240	120	500	90	1	9.117 118



Suitable accessories can be found in our online shop.

5 | 6 Laboratory jacks, aluminium

For those who wish to reach the top

Bochem

New design and improved construction:

- Improved scissor technology with reduced tolerances
- Ergonomic knob, rounded and user friendly
- Scissor-construction made of 18/10-stainless steel

Properties:

- All models are manufactured according to DIN 12897.
- With the operating load we differ between the maximal dynamic operating load (Kg max. dyn.) and the maximal static operating load (Kg max. stat.) of the lab jack. These norms are also according to DIN 12897.
- Smaller models up to 240 mm x 240 mm (Type A) have a simple adjusting wheel, which can be operated by hand.
- Bigger models from 300 mm x 300 mm on (Type B) have a special adjusting wheel, which is used with the included ratchet.

Type	Width	Depth	Min. height	Max. height	Max. stat.	Max. dyn.	PK	Cat. No.
	mm	mm	mm	mm	kg	kg		
A	100	100	55	120	10	5	1	9.118 960
A	160	130	60	275	30	7	1	9.118 961
A	200	200	60	275	30	7	1	9.118 962
A	240	240	60	275	30	7	1	9.118 963
B	300	300	130	470	60	12	1	9.118 964
B	400	400	130	470	60	15	1	9.118 965
Ratchet		190					1	9.118 921



1. General laboratory consumables

General laboratory aids/Laboratory jacks

1



1 2 Laboratory jacks, aluminium anodized

Bochem

For those who wish to reach the top
 New design and improved construction:
 - Improved scissor technology with reduced tolerances
 - Ergonomic knob, rounded and user friendly
 - Scissor-construction made of 18/10-stainless steel

Properties:
 - All models are manufactured according to DIN 12897.
 - With the operating load we differ between the maximal dynamic operating load (Kg max. dyn.) and the maximal static operating load (Kg max. stat.) of the lab jack. These norms are also according to DIN 12897.
 - Smaller models up to 240 mm x 240 mm (Type A) have a simple adjusting wheel, which can be operated by hand.
 - Bigger models from 300 mm x 300 mm on (Type B) have a special adjusting wheel, which is used with the included ratchet.

2



Type	Width mm	Depth mm	Min. height mm	Max. height mm	Max. stat. kg	Max. dyn. kg	PK	Cat. No.
A	100	100	55	120	10	5	1	9.118 975
A	160	130	60	275	30	7	1	9.118 976
A	200	200	60	275	30	7	1	9.118 977
A	240	240	60	275	30	7	1	9.118 978
B	300	300	130	470	60	12	1	9.118 979
B	400	400	130	470	60	15	1	9.118 970
Ratchet		190					1	9.118 921

3



3 Laboratory jacks MAXI, aluminium

Bochem

For those who wish to reach the top:
 New design and improved construction:
 - Improved scissor technology with reduced tolerances
 - Ergonomic knob, rounded and user friendly
 - Scissor-construction made of 18/10-stainless steel

Properties:
 - The MAXI lab jacks offer 30 % more height because of an amplified construction
 - Scissor-construction made of 18/10-stainless steel
 - Adjustment of height with the help of an adjusting wheel.
 - Ergonomic knob, rounded and user friendly
 - Norms are according to DIN 12897.

Width mm	Depth mm	Min. height mm	Max. height mm	Max. stat. kg	Max. dyn. kg	PK	Cat. No.
130	160	75	400	30	7	1	9.118 946
200	200	75	400	30	7	1	9.118 947

4



4 5 Laboratory jacks, 18/10-stainless steel

Bochem

For those who wish to reach the top
 New design and improved construction:
 - Improved scissor technology with reduced tolerances
 - Ergonomic knob, rounded and user friendly
 - Scissor-construction made of 18/10-stainless steel

Properties:
 - All models are manufactured according to DIN 12897.
 - With the operating load we differ between the maximal dynamic operating load (Kg max. dyn.) and the maximal static operating load (Kg max. stat.) of the lab jack. These norms are also according to DIN 12897.
 - Smaller models up to 240 mm x 240 mm (Type A) have a simple adjusting wheel, which can be operated by hand.
 - Bigger models from 300 mm x 300 mm on (Type B) have a special adjusting wheel, which is used with the included ratchet.

5



Type	Width mm	Depth mm	Min. height mm	Max. height mm	Max. stat. kg	Max. dyn. kg	PK	Cat. No.
A	100	100	55	120	10	5	1	9.118 923
A	130	160	60	275	30	7	1	9.118 924
A	200	200	60	275	30	7	1	9.118 925
A	240	240	60	275	30	7	1	9.118 926
B	300	300	130	470	60	12	1	9.118 928
B	400	400	130	470	60	15	1	9.118 929
Ratchet		190					1	9.118 921

1. General laboratory consumables

General laboratory aids/Laboratory jacks-Stands, Fittings

1 Laboratory jacks MAXI, 18/10-stainless steel

For those who wish to reach the top:

New design and improved construction:

- Improved scissor technology with reduced tolerances
- Ergonomic knob, rounded and user friendly
- Scissor-construction made of 18/10-stainless steel

Properties:

- The MAXI lab jacks offer 30 % more height because of an amplified construction
- Scissor-construction made of 18/10-stainless steel
- Adjustment of height with the help of an adjusting wheel.
- Ergonomic knob, rounded and user friendly
- According to DIN 12897.

Bochem

1



Width mm	Depth mm	Min. height mm	Max. height mm	Max. stat. kg	Max. dyn. kg	PK	Cat. No.
130	160	75	400	30	7	1	6.225 931
200	200	75	400	30	7	1	9.118 945

2 Laboratory jacks with hydraulic drive, stainless steel

- Easy and safe lifting
- With ball-bearings in the guide rails
- Stable, parallel movement

Alternative stainless steel versions available on request.

Max. kg	Width mm	Length mm	Min. height mm	Max. height mm	PK	Cat. No.
25	200	230	91	285	1	9.118 980
25*	200	230	91	285	1	9.118 971
25**	200	230	91	285	1	9.118 981
15	200	230	108	393	1	9.118 982
25	300	300	91	285	1	9.118 983
25*	300	300	91	285	1	9.118 984

* With safety lowering device

**High-grade steel, except the pump unit

Juchheim Laborgeräte

2



3 Rectangular retort stand bases, enamel, coated steel plate

Highly stable laboratory stand due to the steel rectangular base which is stove enamel coated. With an M10 threaded hole in the middle of one short side. Rubber support feet prevents the stand from sliding. Laboratory stands are supplied without support rod. Please select the suitable rod from "support rods".

Width mm	Depth mm	Weight g	PK	Cat. No.
130	210	1725	1	6.242 701
150	300	2830	1	4.008 486
200	315	4000	1	4.008 487

3

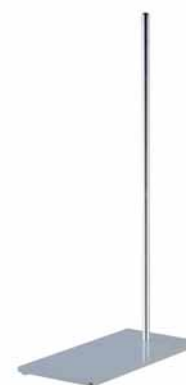

4 Retort stand bases

Lacquered steel with green finish, M10 thread hole on one short side, 1 foot adjustable.

To DIN 12892. Laboratory stands are supplied without support rod.

Please select the suitable rod from "support rods".

Width mm	Depth mm	Thickness mm	Weight g	PK	Cat. No.
100	180	6	800	1	6.900 197
130	210	6	1300	1	6.077 706
160	250	6	2000	1	6.077 369
150	300	6	2200	1	6.072 019
200	315	6	3000	1	9.224 041
130	210	8	1800	1	9.224 042
160	250	8	2600	1	9.224 043
200	315	8	4000	1	9.224 044
200	315	10	5000	1	9.224 045

Bochem

4

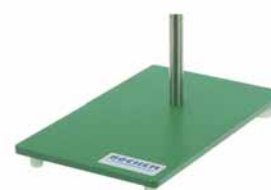

General laboratory aids/Stands, Fittings



1 Laboratory stand

Same rod can be placed either at the centre or at the rear of the base offering multi advantages. White base colour guarantees perfect visual observation of colour changes during titration applications.

ISOLAB

- Rectangular base made of ABS.
- Delivered complete with a screw-in M10 support rod of 600 mm height

Plate format mm	PK	Cat. No.
175 x 300	1	6.243 692



2 Retort stand bases, Steel

Steel, powder-coated. With an M10 bore hole in the middle of one of the shorter sides. Laboratory stands are supplied without support rod. Please select the suitable rod from "support rods".

Juchheim Laborgeräte

Width mm	Length mm	Weight g	PK	Cat. No.
130	210	1800	1	6.301 718
150	300	2900	1	6.307 252
200	315	4100	1	6.074 044



3 Retort stand bases

To DIN 12892. Steel, powder-coated, 8 mm thick. Rubber feet. With an M10 bore hole in the middle of one shorter side.

Usbeck

Width mm	Length mm	PK	Cat. No.
100	180	1	7.200 420
130	210	1	9.224 013
160	250	1	6.076 836
150	300	1	9.224 015
200	315	1	9.224 017



4 Tripod retort stand bases chromated steel

Highly stable laboratory stand due to the steel tripod base which is stove enamel coated. With an M10 threaded hole in the middle. Rubber support feet prevents the stand from sliding. Laboratory stands are supplied without support rod. Please select the suitable rod from "support rods".

Foot length mm	Weight g	PK	Cat. No.
115	805	1	4.008 488
150	1050	1	4.008 489



5 Retort stand base, tripod pattern

Cast iron varnished. Thread M10. Laboratory stands are supplied without support rod. Please select the suitable rod from "support rods".

Bochem

Foot length mm	Weight g	PK	Cat. No.
105	1200	1	6.401 256
145	2000	1	6.084 197



6 Retort stand base, tripod pattern

Type 1: steel, thickness 10 mm, powdercoated, M 10 threaded, rubber feet
Type 2: for rods up to 13 mm diam. hinged screw M 6

Usbeck

Laboratory stands are supplied without support rod. Please select the suitable rod from "support rods".

Foot length mm	Weight g	PK	Cat. No.
80	680	1	6.237 239
115	1000	1	9.224 051
150	1350	1	9.224 054
185	1700	1	6.902 265

1. General laboratory consumables

General laboratory aids/Stands, Fittings

1 Table clamps for rods, malleable cast iron, coated

For table tops with a thickness of max. 55 mm. Rod diameter 12/13 mm.

Bochem

1



Description	PK	Cat. No.
Table clamps	1	6.089 284

2 Table clamp with hinged screws, aluminium alloy, powder-coated

For rods up to 13 mm diameter, for benches/worktops up to 60 mm thick.

Usbeck

2



Description	PK	Cat. No.
Table clamp with hinged screws	1	6.801 520

3 Support rods galvaniser steel

Galvanised steel. External diameter 12 mm. With or without M10 thread.

3



Type	Length mm	PK	Cat. No.
With thread	600	1	4.008 490
With thread	750	1	6.242 703
With thread	1000	1	4.008 491
With thread	500	1	9.224 105
With thread	600	1	9.224 106
With thread	750	1	9.224 107
With thread	1000	1	9.224 110
With thread	1250	1	7.095 411
With thread	1500	1	9.224 115
Without thread	500	1	6.701 307
Without thread	600	1	9.224 126
Without thread	750	1	9.224 127
Without thread	1000	1	9.224 130
Without thread	1250	1	6.081 670
Without thread	1500	1	9.224 135

4 Support rods 18/10 stainless steel

18/10 stainless steel. 12 mm external diameter.

4



Length mm	Ext. Thread diam. mm	PK	Cat. No.
600	12 M 10	1	4.008 492
750	12 M 10	1	4.008 493
1000	12 M 10	1	4.008 494
500	12 M 10	1	6.076 621
600	12 M 10	1	9.224 206
750	12 M 10	1	9.224 207
1000	12 M 10	1	9.224 210
1250	12 M 10	1	6.201 020
1500	12 M 10	1	6.900 476
500	12 -	1	6.060 366
600	12 -	1	9.224 226
750	12 -	1	9.224 227
1000	12 -	1	9.224 230
1250	12 -	1	6.200 760
1500	12 -	1	6.053 253

General laboratory aids/Stands, Fittings

1

1 2 Support rings with or without bosshead, 18/10 Stainless/zincked

Bochem

Type	Int. diam. mm	Length mm	Material	PK	Cat. No.
Closed ring	70	200	18/10 steel	1	9.225 027
Closed ring	100	220	18/10 steel	1	9.225 030
Closed ring	130	220	18/10 steel	1	9.225 033
Closed ring	140	220	18/10 steel	1	9.225 036
Closed ring	50	160	steel zincked	1	6.239 803
Closed ring	70	200	steel zincked	1	6.239 507
Closed ring	100	220	steel zincked	1	6.239 804
Closed ring	130	220	steel zincked	1	6.239 822
Closed ring	160	220	steel zincked	1	6.239 805
Closed ring, with bosshead	50	70	steel zincked	1	4.659 172
Closed ring, with bosshead	70	70	steel zincked	1	9.225 081
Closed ring, with bosshead	100	70	steel zincked	1	6.238 844
Closed ring, with bosshead	130	70	steel zincked	1	7.651 881

3

3 4 Support ring

Steel. With or without bosshead, as outlined below.

Juchheim Laborgeräte

Type	Ext. diam. mm	Weight g	PK	Cat. No.
without bosshead	70	157	1	6.900 428
without bosshead	100	216	1	6.900 429
without bosshead	130	230	1	6.201 068
without bosshead	160	260	1	6.900 430
without bosshead	180	346	1	6.900 761
with bosshead	70	210	1	6.076 309
with bosshead	100	236	1	9.223 900
with bosshead	130	266	1	9.223 901

5

5 Scaffold bosshead, cast iron

Malleable cast iron with lacquered chrome finish. With heart screws.

Jaw opening mm	Angle	PK	Cat. No.
13	90	1	9.224 267

6

6 Bosshead

Malleable cast iron with lacquered chrome finish. DIN 12895. With lug screw.

Jaw opening mm	PK	Cat. No.
16.5	1	9.224 254
20	1	6.225 278
36	1	6.802 614

7

7 Bossheads, aluminium, angle 90°

DIN 12895. For customer designed products and high quantity orders the screw type can be chosen.

Description	Jaw opening mm	Thread	Angle	PK	Cat. No.
Thumb screw M8/M10	16,5	M8	90	1	6.076 525
Thumb screw M8/M10	16,5	M8	90	1	9.224 291
Socket screw M6/M8	16,5	M8	90	1	6.079 309
Safety screw type "heart" M8	16,5	M8	90	1	6.280 866

8

8 Bossheads, malleable cast iron, chromed

Swivelling (360°). For M8 rods.

Jaw opening mm	PK	Cat. No.
16.5	1	6.079 307

1. General laboratory consumables

General laboratory aids/Stands, Fittings

Bosshead, standard

Chrome plated cast alloy with smoothly opening distance of 0 - 20 mm.

Available as 2 types:

- with fix stem that holds the objects on fixed position.
- with swivel mechanism which enables the object to freely swivel 360° and lockable at any desired angle.



6.239 009



6.238 711

Jaw opening mm	PK	Cat. No.
swivel bosshead	1	6.239 009
solid stem bosshead	1	6.238 711

3 Bosshead

18/10 steel. To DIN 12895. Material number 4301. Electrolytically polished, with heart screw. Angle 90°.



Jaw opening mm	PK	Cat. No.
16.5	1	9.224 252

4 Bosshead, malleable iron

Double bosshead malleable iron, epoxy coated.

Juchheim Laborgeräte



Description	Jaw opening mm	PK	Cat. No.
with M8 brass thumb bolt	20	1	9.223 902

5 6 7 8 Bosshead

To DIN 12895. Zinc die casting, powder-coated. For vertical and horizontal clamping.

Usbeck

Jaw opening mm	Description	PK	Cat. No.
16	Bosshead with steel screws	1	9.224 251
16	Bosshead with brass screws	1	9.224 245
20	Double cross bosshead with brass screws	1	9.224 257



9.224 251



9.224 257



9.224 257



9.224 257

9 Swivelling bosshead

Swivelling. To DIN 12895 Part 1. Zinc die casting powder-coated .

Usbeck



Clamping range mm	PK	Cat. No.
16	1	9.224 270

General laboratory aids/Stands, Fittings



1 Bossheads, stainless steel

Stainless steel, electrolytically polished, for rods up to 16mm diameter.
With tommy-bar screws.

Usbeck

Jaw opening mm	PK	Cat. No.
16	1	6.071 888



2 Cross bosshead

Malleable cast iron with chrome finish. DIN 12895. 90° and 180° angle with lug screw.

Jaw opening mm	PK	Cat. No.
16.5	1	9.224 264



3 Bossheads, aluminium

For M8 rods. Angle 90° and 180°.

Jaw opening mm	PK	Cat. No.
13	1	6.202 021



4 Bossheads

Aluminium alloy or stainless steel 18/10.
Angle 90° and 180°.

Description	Jaw opening mm	Thread	Material	PK	Cat. No.
with thumb screw	16.5	M8	Aluminium alloy	1	9.224 268
with heart screw	16.5	M8	stainless steel 18/10	1	9.224 258
with thumb screw	27	M10	Aluminium alloy	1	9.224 269



9.223 905

Hook connector, steel/stainless steel

Hook bosshead steel, epoxy coated or stainless steel with brass pressure block.

Juchheim Laborgeräte



9.223 906

Description	Clamping range mm	Material	PK	Cat. No.
M8 stainless steel thumb bolt	13	stainless steel	1	9.223 905 5
M8 brass thumb bolt	13	steel	1	9.223 906 6



7 Cross bosshead, cast steel

Chrome plated cast steel. Suitable for frame works and fixing perpendiculars.
Can be moved vertically and horizontally along the rods.

Description	PK	Cat. No.
suitable for rods 12 mm	1	9.224 278



8 Cross bosshead, right-angle format, Aluminum alloy

LABOMECA. With hexagon socket screw.

Bochem

Jaw opening mm	PK	Cat. No.
12 to 13 x 12 to 13	1	9.224 274

1. General laboratory consumables

General laboratory aids/Stands, Fittings

1 Retort clamps

Standard to DIN 12894. With round jaws. Bochem

Jaw opening	Shaft length min.	Material	PK	Cat. No.
mm	mm			
25	150	Malleable cast iron, chromed	1	9.224 470
40	150	Malleable cast iron, chromed	1	9.224 471
60	150	Malleable cast iron, chromed	1	9.224 472
80	180	Steel, zinc coated	1	6.306 164



2 Universal clamp, with cork

Prongs with cork. Bochem

Jaw opening	Shaft length	Material	PK	Cat. No.
mm	mm			
0 to 80	180	Aluminium, DIN pattern	1	9.224 501
0 to 80	150	18/10 steel	1	9.224 502



3 Support clamps, 18/10 steel

DIN 12984. Prongs with cork and round jaws. Bochem

Type	Clamping range	Shaft length min.	PK	Cat. No.
	mm	mm		
round jaws	25	150	1	9.224 425
round jaws	40	150	1	9.224 440
round jaws	60	150	1	9.224 460
round jaws	80	180	1	7.200 026
round jaws	100	180	1	7.079 535
round jaws	120	180	1	6.076 598
round jaws	150	180	1	6.072 053



4 Three-prong clamps, aluminium

PVC-coated jaws. Bochem

Jaw opening	Shaft length min.	PK	Cat. No.
mm	mm		
0 to 70	140	1	6.510 909



5 6 Retort clamps

Flexible shaft, nickel-plated. Bochem

Description	Jaw opening	Shaft length	Material	PK	Cat. No.
	mm	mm			
Finger with silicone coating	0 to 30	220	Alu-alloy	1	6.303 841
Finger with cork	40	290	18/10 steel	1	6.300 995



7 Retort clamp

18/10 stainless steel. 3-prong with plastic covered jaws. Bochem

Jaw opening	Shaft length min.	PK	Cat. No.
mm	mm		
0 to 120	150	1	9.224 445



8 Beaker and flask clamp

18/10 steel. 4 prong with silicone covered jaws. Bochem

Jaw opening	Shaft length min.	PK	Cat. No.
mm	mm		
0 to 120	150	1	9.224 448



General laboratory aids/Stands, Fittings

1

Clamps, retort, 3-prong, chromated steel

Manufactured from chrome plated cast steel with two prongs which are PVC coated for gentle hold of the objects. Two separately adjustable clamps enables perfect control of holding pressure and precise positioning of the objects. Clamps can be opened and closed smoothly with a grip width of 0-70 mm.

ISOLAB

With solid stem of 12 mm rod diameter with the holding angle and distance from the support rod can be adjusted by a separate bosshead.

With swivel mechanism which enables the object freely swivel 360° and lockable at any desired angle. Complete with an integral bosshead usable for rods maximum diameter of 21 mm.

2

Description	Jaw opening mm	PK	Cat. No.
solid stem clamp	0 - 70	1	6.242 700 1
swivel clamp	0 - 70	1	6.243 690 2

3

Clamp, 2 prongs

Chrome plated cast steel with two PVC coated prongs for gently holding the objects. Two separately adjustable clamps enable perfect control of holding pressure and precise positioning of the objects. Clamps can be opened and closed smoothly with a grip width of 0-50 mm.

ISOLAB

Available as 2 types:

- with solid stem of 12mm rod diameter, the holding angle and distance from the support rod can be adjusted by a separate bosshead.
- with swivel mechanism which enables the object to freely swivel 360° and lockable at any angle. Complete with a integral bosshead, usable for rods maximum diameter of 21 mm.

4

Description	Jaw opening mm	PK	Cat. No.
solid stem	0 to 50	1	6.237 648 3
swivel	0 to 50	1	9.224 401 4

5

Clamps, malleable iron

Stand clamp rounded jaws, malleable iron, epoxy coated. To DIN 12894.

Juchheim Laborgeräte

Clamping range	Weight	PK	Cat. No.
mm	g		
25	180	1	6.800 204
40	204	1	6.200 398

6

Three-prong clamp, malleable iron

Malleable iron with epoxy coating for 1 burette

Juchheim Laborgeräte

Jaw opening mm	Weight	PK	Cat. No.
mm	g		
0 - 30	140	1	9.223 915

7

Clamps

To DIN 12894. B form. Zinc die casting, powder-coated. With round jaws.

Usbeck

Clamping range	PK	Cat. No.
mm		
25	1	9.224 302
40	1	9.224 304
60	1	9.224 306
80	1	9.224 319

8

Three-prong clamp

Zinc die casting, natural alloy, vinyl-coated jaws.

Usbeck

Jaw opening mm	PK	Cat. No.
mm		
0 - 25	1	6.076 892
0 - 40	1	6.076 893
25 - 80	1	6.078 655

1. General laboratory consumables

General laboratory aids/Stands, Fittings

1 Universal Clamp

With cork lined jaws, opening 0 to 80 mm. Rod diameter 10 mm.

Usbeck

Description	PK	Cat. No.
Zinc die casting, powder-coated	1	6.070 007
Zinc die casting, natural alloy	1	6.077 745
Zinc die casting, nickel plating	1	7.079 496



2 Clamp

Zinc die casting, nickel-plated, vinyl-coated jaws. Rod diameter 10 mm.

Usbeck

Description	Jaw opening mm	PK	Cat. No.
Clamp	38 to 60	1	6.070 155
Clamp	12 to 25	1	6.401 390
Clamp	20 to 40	1	6.401 391



3 Base, flexible, zinc die casting

Zinc die casting, nickel-plated, vinyl-coated jaws. Stem length 300 mm, with 82 mm diameter, heavy, stable base.

Usbeck

Description	Jaw opening mm	PK	Cat. No.
Three-prong, stable base	0 to 40	1	6.303 795
round with stable base	12 to 25	1	7.605 582



4 Clamp, flexible with bosshead, zinc die casting

Zinc die casting, nickel-plated, vinyl-coated jaws, with revolvable sleeve. Stem length 300mm.

Usbeck

Description	Jaw opening mm	PK	Cat. No.
Three-prong, with revolvable sleeve	0 to 40	1	6.088 853
Round with revolvable sleeve	12 to 25	1	6.800 733



5 Micro clamp

Lacquered green finish. Malleable cast iron. Prongs with cork.

Bochem

Type	Jaw opening mm	Shaft length min. mm	PK	Cat. No.
1	15	150	1	9.224 330



6 Micro-clamps, die-cast zinc

DIN 12894, form A. Die-cast zinc, powder coated. With angular jaws.

Usbeck

Jaw opening mm	PK	Cat. No.
10 to 25	1	9.224 307



7 Condenser clamp, malleable cast iron, chromed

Swivel type, silicone coated.

Bochem

Jaw opening mm	Shaft length mm	PK	Cat. No.
50 to 100	150	1	6.070 044



General laboratory aids/Stands, Fittings



1 Condenser clamp, malleable iron

Condenser clamp moveable support rod, malleable iron, epoxy coated.

Juchheim Laborgeräte

Jaw opening mm	Weight g	PK	Cat. No.
85 mm	480	1	9.223 907



2 Chain clamp, steel/zincked

Chain 70 cm, silicone coating.

Bochem

Jaw opening mm	Shaft length mm	PK	Cat. No.
50 to 160	250	1	6.079 772



3 Burette and thermometer clamp

'Automatic'. Sprung-clip jaws with attached chrome-plated bosshead for 13.5 mm max. diameter rods.

Bochem

Jaw opening mm	Length mm	PK	Cat. No.
0 to 25	100	1	9.224 322



4 Burette holders, aluminium

For two burettes. With bosshead. Distance between rollers 170 mm. PVC rollers.

Bochem

Jaw opening mm	PK	Cat. No.
0 to 13	1	6.076 204

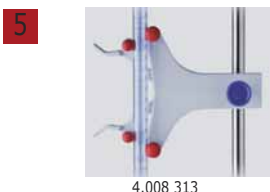

Burette clamp

- Metal burette clamps are made out of steel and can hold one burette at a time. Graduations and meniscus line of the burette are clearly visible. They can be used on support rods of 10 - 12 mm diameter.
- Polypropylene burette clamp can hold one burette at a time. Graduations and meniscus line of the burette are clearly visible. They can be used on support rods of 10 - 12 mm diameter.

ISOLAB



Description	PK	Cat. No.
Burette clamp, metal	1	4.008 313 5
Burette clamp, PP	1	6.240 474 6



7 Burette clamps, nickel plated brass

Burette clamp with boss, nickel plated brass, for 1 burette.

Juchheim Laborgeräte

Jaw opening mm	Weight g	PK	Cat. No.
0 - 40	180	1	9.223 916



8 Burette roller clamp, steel

Burette roller clamp with boss, for 1 burette, epoxy coated.

Juchheim Laborgeräte

Jaw opening mm	Weight g	PK	Cat. No.
0 - 30 mm	220	1	9.223 918

1. General laboratory consumables

General laboratory aids/Stands, Fittings-Batteries

1 Burette clamps, nickel plated brass

Burette clamp with boss, nickel plated brass, for 2 burettes. *Juchheim Laborgeräte*

Jaw opening mm	Weight g	PK	Cat. No.
0 - 40	180	1	9.223 917

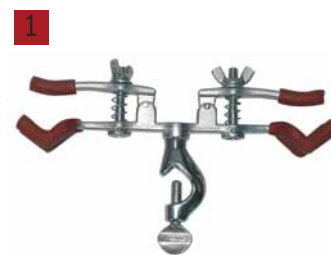

2 Burette roller clamp, steel

Burette roller clamp with boss, for 2 burettes, epoxy coated. *Juchheim Laborgeräte*

Jaw opening mm	Weight g	PK	Cat. No.
0 - 30 mm	380	1	9.223 919



Burette holders

Aluminium, powder-coated. With roller grips and bosshead for retort stand rods. *Usbeck*

Type	PK	Cat. No.
For 1 burette	1	9.225 161
For 2 burettes	1	9.225 162



9.225 162

4 Alkaline Batteries, Energizer® Industrial

Best performance for industrial, medical and laboratory applications.

Type	Volt	PK	Cat. No.
LR14/EN93/C/Baby	1.5	12	9.012 921
LR6/EN91/AA	1.5	10	9.012 939
LR03/EN92/AAA/Micro	1.5	10	9.012 944
LR20/EN95/D/Mono	1.5	12	9.012 922
LR20/EN95/D/Mono	1.5	2	6.256 131
6LR61/EN522/9V/E-Block	9.0	12	9.012 923



Alkaline Special Batteries Energizer®

For a variety of measuring devices; thermometers, digital balances, pocket calculators, watches, timers etc.

Type	Volt	PK	Cat. No.
A76/LR44/13GA	1.5	2	9.012 932
EPX76/SR44	1.5	2	9.012 933
189/LR54/10GA	1.5	2	9.012 934



9.012 932

Rechargeable NiMH batteries Energizer® Profi Akku

- Rapid recharging
- No memory effect
- Ecologically friendly
- Economical

Type	Volt	Current mAh	PK	Cat. No.
HR03/AAA/Micro	1.2	700	2	6.262 319
HR6/AA/Mignon	1.2	2000	4	9.012 925
HR6/AA/Mignon	1.2	2300	2	9.012 945
HR22/9V/E-Block	8.4	175	1	9.012 927



9.012 927

1. General laboratory consumables

General laboratory aids/Accessories for electrical device-Bags, Foils

1



9.726 000

Adaptor plugs, Swiss and UK

9.726 000: Adapter plug with earthing contact from plug with earthing contact and additional earthing socket to British version 13 A, with fine-wire fuse 3, 5 or 13 A ("non rewirable")
 9.726 001: One-way plug adapter from plug with additional earthing contact (CEE 7) to plug Swiss version type 12 ("non rewirable")

Type	PK	Cat. No.
with adapter UK	1	9.726 000
with adapter CH	1	9.726 001

2



2 LLG-Laboratory Power Failure Detector

- Immediate visual and acoustic alarm
- Alarm can sound for short power outages, or for larger periods of at least 12 hours (can be switched off manually).
- Plug safety cover offers protection against accidental disconnection of plug
- Maximum total power of connected devices. 3500W power supply 230V 50Hz
- Suitable for European plugs
- Max. Rating 16 A
- With built-in battery

Scope of supply:

- 1 x power failure detector
- 2 x plug safety caps
- 2 x screws

Type	PK	Cat. No.
LLG-Laboratory Power Failure Detector	1	6.255 819

3



3 Aluminium foil

Suitable for many laboratory applications. Resistant to liquids and gases. Ideal for sealing and wrapping of bottles and flasks. Good thermal conductivity, heat resistant.

Description	Width mm	Length m	Thickness µm	PK	Cat. No.
Dispenser box	300	100	13	1	9.106 103
Dispenser box	300	150	15	1	6.076 250
Dispenser box	300	100	30	1	6.070 786
Dispenser box	450	150	15	1	9.106 102
Dispenser box	450	100	30	1	6.070 787
Dispenser box	500	100	30	1	9.106 105
Dispenser box	600	100	30	1	6.027 813
Roll	500	200	50	1	9.106 205
Short roll	300	20	13	1	9.106 013
Short roll	300	10	15	1	9.106 106
Short roll	300	20	15	1	6.239 531
Short roll	300	10	30	1	9.106 107
Short roll	450	10	15	1	9.106 015
Short roll	450	10	30	1	6.076 351
Refilling roll	300	150	15	1	6.076 184
Refilling roll	300	100	30	1	6.060 382
Refilling roll	450	150	15	1	9.106 104
Refilling roll	450	100	30	1	7.510 894
Refilling roll	500	100	30	1	6.075 999
Refilling roll	600	100	30	1	6.510 476

4



4 Aluminium Pop-up sheets

Embossed pure aluminium foils, extremely tare resistant

- Handy for everyday use
- Heat-resistant up to 600 °C
- Air-tight and a barrier to light
- Dimensions (sheet): 230 mm x 270 mm

200 sheets in a box

Description	PK	Cat. No.
Box à 200 sheets	1	6.230 318

1. General laboratory consumables

General laboratory aids/Bags, Foils

1 Round aluminium discs

Interleaved with tissue paper. Foil thickness 0.03 mm.

Diam. mm	PK	Cat. No.
80	1000	9.106 208
100	1000	9.106 210
120	1000	9.106 212
130	1000	9.106 213
150	1000	9.106 215



2 Aluminium containers, round

Capacity ml	Top diam. mm	Bottom diam. mm	Fill height mm	PK	Cat. No.
28	64	51	13	100	9.106 240
110	80	56	34	100	9.106 241
110	99	70	25	100	9.106 242
125	96	78	24	100	9.106 261
280	114	58	50	50	9.106 263



3 Aluminium containers, square

Capacity ml	Dimensions top (D x W) mm	Dimensions bottom (D x W) mm	Fill height mm	PK	Cat. No.
250	128 x 103 *	93 x 67	34	100	6.226 802
500	191 x 127 *	156 x 92	29	60	9.106 266

* With lid.



4 Aluminium containers, square

Capacity ml	Length mm	Width mm	Fill height mm	PK	Cat. No.
160	100	64	38	100	6.510 118
330	121	83	47	100	6.510 217
340	160	110	26	100	6.273 997
550	200	103	39	100	7.652 300
930	228	176	28	100	6.200 538
2170	316	215	43	50	4.664 575

Korff

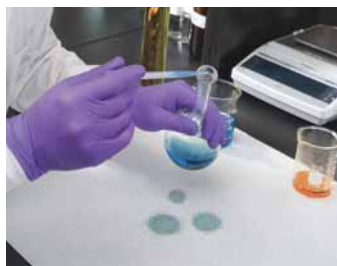

General laboratory aids/Bags, Foils

1

1 LLG-Surface protector DescProtect

DescProtect is a durable paper which quickly absorbs liquid spills. The PE-coated base layer stops liquids reaching the work surface.

- stays flat, does not ripple or curl to de-stabilise vessels
- white surface can be written on using pens or pencils
- rapid absorption of liquid spills
- excellent fluid protection
- no contamination of work surfaces or laboratory cabinets
- suitable for school laboratories, wet chemistry, industry

Surface protection paper with two layers:

- Layer 1: Highly absorbent carrier paper, sucks up spilled toxic or radioactive liquids quickly
- Layer 2: Wetness impermeable polyethylene layer, protection for lab workbenches, trays or chemical cabinets
- Additional advantages: impermeable cover in animal cages, ideal in humidity chambers for atmospheric regulation

Type	Size	PK	Cat. No.
Sheets	460mm x 570mm	50	9.160 270
Spool	400mm x 50m	1	9.160 271

2

2 Benchkote surface protector®

The upper side consists of a particularly absorbent filter paper, the lower side is a non-permeable, chemically resistant PE layer. This combination makes Benchkote into a protective paper with a particularly high wet strength for universal use, helping to meet the requirements of Good Laboratory Practice (GLP):

Whatman

- Completely absorbs escaped liquids
- Prevents spills from reaching the workbench
- Protects against contamination

Applications:

- Surface protection for lab workbenches, trays or chemical cabinets
- Contamination protection, e. g. in isotope or bacteriological labs
- Adsorption of toxic or radioactive substances
- Hygienic protection in animal cages
- Atmospheric regulation in humidity chambers

Type	Width mm	Length m	PK	Cat. No.
Pack of loose sheets	460	0.57	50	9.106 280
Sheets	460	0.57	100	7.633 130
Sheets	600	0.50	50	9.106 278
Roll	460	5.00	1	9.106 284
Roll	600	5.00	1	9.106 279
Roll	920	5.00	1	9.106 286
Pad of sheets	460	0.57	1	9.106 287

3

3 Bench protector, Labmat™

White. Labmat™ Bench Liner speeds clean-up and safeguards work surfaces from stains, spills and wear. Highly absorbent upper surface. Flexible polyethylene film backing is non-skid and prevents soak-through of most solutions. Simply roll up and discard after contamination. Easily cut custom size sheets with the Bel-Art safety cutter.

Bel-Art Products

Type	Width mm	Length m	PK	Cat. No.
Bench protector, Lab Mat™	508	15.2	1	9.106 288

4

4 Desk protector, cork

Made from natural agglomerated cork which can be easily cleaned. Non-allergenic, anti-fungal, anti-bacterial and antistatic material. Heat and erosion resistant and also reduces noise and vibration.

Width mm	Depth mm	Height mm	PK	Cat. No.
200	200	10	1	6.267 409
300	300	10	1	6.267 410

1. General laboratory consumables

General laboratory aids/Bags, Foils

1 Laboratory mats, silicone



Deutsch & Neumann

- Non-slip
- Withstands temperatures up to 260 °C
- Available in black or red

Colour	Width mm	Depth mm	PK	Cat. No.
Red	250	250	1	9.390 090
Black	250	250	1	9.390 091
Red	350	350	1	9.390 092
Black	350	350	1	9.390 093



2 3 Laboratory mats Lab Mat, silicone



Heathrow Scientific

The Lab Mats are an economical solution to help keep benchtops clean and safe from stains, spills and wear. Stain resistant washable surface, which can easily be cleaned using any standard disinfectant and even autoclavable at 121 °C for 15 minutes. The mat can also be rolled up for compact storage. The Lab Mat can be used with instruments such as centrifuges, vortex mixers, stirrers, and so much more. It offers a large working surface. Food-safe.

- Anti-skid, which helps to keep items with harsh chemicals and delicate glassware in place
- Noise dampening, reducing sound from the vibration of common benchtop equipment.
- Area with internal metal inserts to store magnet bars from magnetic stirrers
- Lip design around the outer edge, that helps contain spillage that may occur when in use
- Protects countertops from hot items up to 200 °C



Colour	Width mm	Depth mm	Height mm	PK	Cat. No.
Side one: yellow, side two: blue on grey	35	60	2	1	6.286 311
Side one: purple, side two: grey on purple	35	60	2	1	6.286 312

4 Laboratory mats Workstation Lab Mat, silicone



Heathrow Scientific

Non-slip Laboratory mats with 2 different sides for organising and thus simplifying workflow processes. One side with a completely flat surface and one side with a combination of gridded and flat surface. The gridded area avoids unwanted movement of small parts Ideal for all laboratories and more specialised areas such as cold rooms or areas with high sterility requirements such as clean rooms.

- Dimensions (W x D x H): 305 x 379 x 2 mm
- Protection of the work bench from hot items up to 200 °C
 - Lip around the edge can hold approx. 250 ml of liquid
 - Reusable
 - Chemically resistant
 - Dishwasher safe
 - Food safe
 - Noise dampening
 - Can be rolled up
 - Autoclavable at 121 °C for 15 minutes



Colour	Width mm	Depth mm	Height mm	PK	Cat. No.
Blue	379	305	2	1	6.292 160
Purple	379	305	2	1	6.292 161

General laboratory aids/Bags, Foils



1 Plastic film, rolls

Transparent. PE.
Other widths are available on request.

Width mm	Thickness mm	Package contents	PK	Cat. No.
80	0.05	1 roll of 25 m	1	9.106 508
80	0.10	1 roll of 25 m	1	9.106 538
100	0.05	1 roll of 25 m	1	9.106 510
100	0.10	1 roll of 25 m	1	9.106 540
100	0.20	1 roll of 25 m	1	7.633 673
150	0.05	1 roll of 25 m	1	9.106 515
150	0.10	1 roll of 25 m	1	9.106 545
150	0.15	1 roll of 25 m	1	6.802 434
200	0.05	1 roll of 25 m	1	9.106 520
200	0.10	1 roll of 250 m	1	6.085 976
200	0.10	1 roll of 25 m	1	9.106 550
200	0.15	1 roll of 25 m	1	6.200 595
200	0.20	1 roll of 25 m	1	6.303 277
250	0.05	1 roll of 25 m	1	9.106 525
250	0.10	1 roll of 25 m	1	9.106 555
300	0.05	1 roll of 25 m	1	9.106 530
300	0.10	1 roll of 25 m	1	9.106 560
300	0.20	1 roll of 25 m	1	6.091 294
600	0.20	1 roll of 200 m	1	7.653 010



2 SAROGOLD® foil

Extra-strong foil. PVDC-based. Good barrier properties protects the user against contact with dangerous substances (e.g. ethidium bromide or contaminated isotopes) from the sealed material and it is therefore suitable for covering sequencing gels in Electrophoresis applications.

- does not stick, easy to unravel
- with cutter
- non-flammable
- self-extinguishing
- microwaveable

Film thickness:	11.5 µm
Permeability in the visible area:	90 %
UV-filtering:	3000 Å
IR-permeability:	88 %
Width:	300 mm
Length:	300 m

Type	Size	PK	Cat. No.
SAROGOLD®	300 mm, roll 300 m	1	9.106 460



3 Cling film Toppits®

- easy to use and better adhesion
- our best freshness protection
- slight initial determination
- very easy to roll
- particularly strong
- with time beginning Finder
- tear-off cap box with stable
- role of fixation for easy rolling

Width mm	Length m	PK	Cat. No.
320	20	1	9.106 450



4 Stand-up Freezer bags

Polar One. With tear-resistant seam.

Capacity Litres	Width mm	Length mm	PK	Cat. No.
1	190	240	40	9.033 251
3	250	320	30	9.033 252
6	290	470	20	9.033 253

1. General laboratory consumables

General laboratory aids/Bags, Foils

1 LLG-Disposal bags, PE

Transparent. PE. Without seal.

Width mm	Length mm	Thickness mm	PK	Cat. No.
100	150	0.05	100	9.404 128
150	200	0.05	100	9.404 130
200	320	0.05	100	9.404 140
250	400	0.05	100	9.404 150
250	400	0.10	100	9.404 151
300	500	0.05	100	9.404 152
300	500	0.10	100	9.404 153



2 LLG-Pressure-seal bags with write on patch, PE

Transparent. PE. With rim channel seal that can be opened and closed repeatedly, and write-on patch.

Width mm	Length mm	Thickness mm	PK	Cat. No.
40	60	0.05	100	9.404 176
70	100	0.05	100	9.404 173
80	120	0.05	100	9.404 179
100	150	0.05	100	9.404 171
120	170	0.05	100	9.404 172
160	220	0.05	100	9.404 177
200	300	0.05	100	9.404 178



3 LLG-Pressure-seal bags, PE

Transparent. PE. With rim channel seal that can be opened and closed repeatedly.

Width mm	Length mm	Thickness mm	PK	Cat. No.
80	120	0.05	100	9.404 160
100	150	0.05	100	9.404 161
120	170	0.05	100	9.404 162
150	220	0.05	100	9.404 163
180	250	0.05	100	9.404 164
200	300	0.05	100	9.404 165
220	310	0.05	100	6.304 307
250	350	0.05	100	9.404 166
300	400	0.05	100	9.404 167



➔ For sterile bags see 559.

4 PARAFILM® M sealing film

Can be stretched up to 200 % and clings around irregular shapes and surfaces. Parafilm® M is resistant to many polar substances such as saline solutions, inorganic acids and alkaline solutions for up to 48 hours (After this time it may become brittle). Parafilm® M conforms to general FDA requirements if used below 55 °C.

Melting temperature: 60 °C
 Continued use temperature: -45 °C to +50 °C
 Stretching ability: 200 %

Type	Width mm	Length m	PK	Cat. No.
PARAFILM® M	50	75	1	9.170 003
PARAFILM® M	100	38	1	9.170 002
PARAFILM® M	100	75	1	9.170 005
PARAFILM® M	500	15	1	9.170 004



5 LLG-Dispenser for PARAFILM® M, orange, ABS

PARAFILM® M feeds through easily and is easy to cut using the safety cutting device. For rolls with width up to 100 mm.

Type	PK	Cat. No.
PARAFILM® M dispenser, ABS	1	9.170 006



6 PARAFILM® M dispenser

PARAFILM® M feeds through easily and is easy to cut using the safety cutting device. For rolls up to 100 mm wide.

Type	PK	Cat. No.
PARAFILM® M dispenser, Plexiglas®	1	9.170 000



General laboratory aids/Greases

1

1 KÄLTE 75 SUPER

Instant cooling of parts. Cooling agent for thermal fault location. Provides an instant solution by cooling down circuitry to -50 °C. Intermittent short circuits or interruptions in condensers, resistors, integrated circuits are quickly discovered. Especially designed for applications where 100 % safety is an absolute must. The fluid evaporates very quickly and, in doing so, extracts heat of vaporisation from the environment. As a result, the sprayed surface cools down considerably (max. - 55 °C). The spray evaporates completely and leaves no residues. It does not contain CFC's.

CRC



Attention

H phrases: H223|H229

Capacity ml	PK	Cat. No.
200	1	4.661 813

2

2 Multifunctional oil 5-56 + PTFE

NEW

Multifunctional oil with PTFE for lubrication, loosening, cleaning and protection. Ensures permanent wear protection, high pressure absorption capacity and reliable lubrication even under extreme conditions. Allows either surface spraying or spot-precise spraying.

- High quality mechanic oil
- Silicone-free
- Temperature range: -50 to 150 °C



Attention

H phrases: H223|H229

Capacity ml	PK	Cat. No.
500	1	6.312 049

3

3 Gas leak detection fluid

DIN 30657 gas, trace and leak detection fluid. Non-allergenic, non-toxic and odourless. Suitable for all pressure ranges. Non-flammable and therefore suitable for all technical gases such as ammonia, argon and other noble gases, freon, carbon dioxide, coal gas, compressed air, propane, oxygen, nitrogen, water etc. Propellant-free. Unpressurised canister. Flash-point greater than 50 °C. Unlimited shelf life. Tested and approved under DIN-DVGW-No. NG to 5170 AN 0456.

Spray head not included. Please order separately.

Type	PK	Cat. No.
Gas leak detection fluid	1	9.110 010
Sprayhead	1	9.110 011

Eye protection	196
Eyeshields	196
Panoramic eyeshields	202
Overgoggles	203
Accessories.....	204
Safety shields	205
Breathing protection	206
Hygiene masks.....	206
Half masks	207
Full face masks	212
Ear protection	214
Noise protection	214
Gloves	217
Vinyl gloves	217
Latex gloves	217
Nitrile gloves.....	220
Glove box holder	230
Chemical protective gloves.....	232
Cut resistant gloves	237
Temperature protective gloves.....	238
Protective clothing	245
Laboratory coats	245
Aprons	248
Coveralls	249
Caps.....	250
Oversleeves	251
Shoes	252
Identification of hazards	253
Safety signs.....	253
First-aid	253
Eye wash bottles	253
Eye wash stations.....	255
Body showers	256
Dressings/plasters	257
Waste disposal	258
Waste, Disposal bags	258
Waste bins.....	261
Chemical Sorbents.....	263
Safety containers	264
Transport, storage containers	264
Transport	270
Trolleys	270
Furniture	272
Chairs	272
Step-ladders	278
Furniture	279
Fume hoods.....	280
Safety cabinets	287

1

1 LLG-Safety Eyeshields *basic*

- CE approved to EN166 and EN170
- Perfect for visitors as well as over goggles for spectacles wearers
- Integrated side lens with venting, 180° visual field
- Frame made of tested hypo-allergenic material
- 100% UV protection (up to 380 nm)
- Weight: 43 g

Colour	Lens	PK	Cat. No.
Clear	Clear, uncoated, 2-1.2 U 1 F CE	10	9.006 002

2

2 LLG-Safety Eyeshields *basic +*

- CE approved to EN 166 and EN 170
- Economic Safety Eyeshields ideal for essential protection
- 180° field of vision
- Frame made of tested hypo-allergenic material
- 100 % UV protection (up to 380 nm)
- Especially light
- Weight: 23 g

Colour	Lens	PK	Cat. No.
Clear	Clear, uncoated, 2-1.2 U 1 F CE	10	6.290 868

3

3 LLG-Safety Eyeshields *classic*

- CE approved to EN166 and EN170
- Integrated side-lenses with vents, 180° field of vision
- Frame made of tested hypo-allergenic material
- Side arms adjustable in length and inclination
- 100% UV protection (up to 380nm)
- Weight: 34g only

Colour	Lens	PK	Cat. No.
Blue	Clear, anti-scratch lens, 2C-1.2 U 1 F CE	1	9.006 001

4

4 LLG-Safety Eyeshields *comfort*

- CE approved to EN166, EN170
- Panoramic wrapping lens
- 180° field of vision
- Frame made of tested hypo-allergenic material
- Side arms adjustable in length
- Nose pad and arm tips are made from soft, mouldable material offer optimal comfort and individual customisation
- Rubber eyebrow protection for greater shock absorption
- 100% UV protection (up to 400nm)
- Lightweight: 30g only

Colour	Lens	PK	Cat. No.
black/green	clear, anti-scratch plus and anti-fog lens plus, 2C-1.2 U 1 FT CE	1	6.312 450

LLG-Safety Eyeshields *lady*

- CE approved to EN 166 and EN 170
- Panoramic wrapping lens
- 180° visual field
- Frame made of tested hypo-allergenic material
- Temples with rubber tips, adjustable in length and inclination
- Nosepad and terminal tips made from soft, moldable material for optimal comfort and individual customisation
- 100 % UV protection (up to 400 nm)
- Weight only 25 g

Colour	Lens	PK	Cat. No.
white/green	clear, AF+, AS+, 2C-1.2 U 1 FT KN CE	1	9.006 007 1
white/pink	clear, AF+, AS+, 2C-1.2 U 1 FT KN CE	1	9.006 008 2
black/green	clear, AF, AS, 2C-1.2 U 1 FT CE	1	9.006 009 3



Safety Eyeshields SecureFit™ 200

- 3M Pressure Diffusion Technology allows temples to naturally adjust to individual head sizes.
- Self-adjusting feature eliminates need to stock multiple frame sizes at worksites.
- Secure, snug fit keeps eyewear in place without slippage even when the person is in motion.
- Anti-fog coating helps keep lenses free of moisture in hot and humid conditions.
- Polycarbonate lenses absorb 99.9% UVA and UVB

3M Deutschland

Colour	Lens	PK	Cat. No.
blue	2C-1.2, UV, anti-scratch, anti-fog	1	4.672 680 4
clear	2C-1.2, UV, anti-scratch, anti-fog	1	9.006 127 5
clear	2C-1.2, UV, anti-fog	1	9.006 128 5
grey	2C-1.2, UV, anti-scratch, anti-fog	1	9.006 129 6
amber	2C-1.2, UV, anti-scratch, anti-fog	1	9.006 130 7



8 Safety Eyeshields SecureFit™ 400

- Features proprietary self-adjusting 3M™ Pressure Diffusion Temple Technology
- Soft, adjustable nose pads for greater personalization
- Dual-injected, padded temple touchpoints for added comfort over the ears
- Polycarbonate lenses absorb 99.9% of UVA & UVB
- Very lightweight: 19 g only

3M Deutschland



Colour	Lens	PK	Cat. No.
black/green	clear, 2C-1.2, UV, anti-scratch, anti-fog	1	9.006 132
black/green	grey, 2C-1.2, UV, anti-scratch, anti-fog	1	9.006 133

Safety Eyeshields SecureFit™ 400 with Scotchgard™ Anti-Fog Coating

- Features proprietary self-adjusting 3M™ Pressure Diffusion Temple Technology
- Soft, adjustable nosepads
- Dual-injected, padded temple touchpoints for added comfort over the ears
- Polycarbonate lenses absorb 99.9% of UVA and UVB
- Scotchgard™ Anti-Fog Coating (SGAF)
- Indoor-outdoor mirrored lenses (I/O)

3M Deutschland

Colour	Lens	PK	Cat. No.
red/grey	clear, 2C-1.2, UV, SGAF	1	4.664 580 1
blue/grey	clear, 2C-1.2, UV, SGAF	1	4.664 581
blue/grey	clear, 2C-1.2, UV, SGAF, foam frame	1	4.664 582 2
blue/grey	grey, 5-1.7, UV, SGAF I/O	1	4.664 583
blue/grey	grey, 5-3.1, UV, SGAF	1	4.664 584
black/yellow	yellow, 2C-1.2, UV, SGAF	1	4.664 585
brown transparent/black	brown, 2C-1.2, UV, SGAF	1	4.664 586 3
brown transparent/black	orange, 2C-1.2, UV, SGAF	1	4.664 587 4

1

4.664 580

2

4.664 582

3

4.664 586

4

4.664 587

Safety Eyeshields SecureFit™ 400X

A further development of the SF400 SGAF series with 3M™ Scotchgard™ Anti-Fog coating, the 3M™ SecureFit™ 400X Series features integrated eyebrow protection for greater comfort and protection against mechanical hazards.

3M Deutschland

- Features proprietary self-adjusting 3M™ Pressure Diffusion Temple Technology
- Soft, adjustable nosepads
- Dual-injected, padded temple touchpoints for added comfort over the ears
- Polycarbonate lenses absorb 99.9% of UVA and UVB
- Scotchgard™ Anti-Fog Coating (SGAF)
- Indoor-outdoor mirrored lenses (I/O)

Colour	Lens	PK	Cat. No.
green/transparent	clear, 2C-1.2, UV, SGAF	1	4.668 580 5
blue/grey	clear, 2C-1.2, UV, SGAF	1	4.668 581
blue/grey	grey, 5-3.1, UV, SGAF	1	4.668 582
blue/grey	grey, 5-1.7, UV, SGAF I/O	1	4.668 583 6
black/yellow	yellow, 2C-1.2, UV, SGAF	1	4.668 584 7
black	vermillion,	1	4.668 585
green/black	clear, 2C-1.2, UV, SGAF	1	4.668 586
grey/black	rainbow-mirrored,	1	4.668 587 8

5

4.668 580

6

4.668 583

7

4.668 584

8

4.668 587

1 Safety Eyeshields 2730

1

Safety Eyeshields for smaller and narrow face shapes with soft temple tips and soft nose bridge.

3M Deutschland

- Various adjustment options for high wearing comfort
- Adjustable temple length
- Adjustable lens inclination in 4 fixed positions
- Polycarbonate glasses for high shock resistance
- Anti-Scratch and Anti-Fog coating



Application: Mechanical work, e.g. Grinding, milling and surface inspections

Colour	Lens	Coating	PK	Cat. No.
Blue	PC transparent/2C-1.2 3M 1 FT	Anti-Scratch / Anti-Fog	1	6.260 453

2 Safety Eyeshields 2740

2

Safety Eyeshields with a large, narrow nose bridge for good compatibility with particle masks.

3M Deutschland

- Various adjustment options for high wearing comfort
- Adjustable temple length in 4 fixed positions
- Individually adjustable lens inclination
- Polycarbonate glasses for high shock resistance
- Anti-Scratch and Anti-Fog coating



Application: Mechanical work, e.g. Grinding, milling and surface inspections

Colour	Lens	Coating	PK	Cat. No.
Blue	PC transparent/2C-1.2 3M 1 FT	Anti-Scratch / Anti-Fog	1	7.638 234

Safety Eyeshields uvex x-fit

- Classic safety spectacles with good coverage of the whole eye area
- Lightweight at just 23 grams
- Innovative hinged sidearm design
- Frame colour: transparent blue or transparent grey
- Completely metal-free
- Reliable UV 400 protection

uvex

uvex **supravision excellence** coated lenses are anti-fog (for at least 16 seconds) on the inside, while the outside offers extreme scratch and chemical resistance. The anti-fogging properties are permanent even after repeated cleaning. The lenses are also easy to clean and less susceptible to dirt due to the non-stick nanotechnology.

uvex **supravision sapphire** coated lenses are excellent scratch resistance

Colour	Lens	PK	Cat. No.
blue	transparent/UV 2-1.2, sv excellence	1	4.664 173 3
grey	transparent/UV 2-1.2, sv sapphire	1	4.664 174 4
grey	amber/UV 2-1.2, sv excellence	1	4.664 175 5
pink	transparent/UV 2-1.2, sv excellence	1	4.675 235 6

3



4.664 173

4



4.664 174

5



4.664 175

6



4.675 235

1



1 Safety Eyeshields uvex skylite 9174

Red fashionable sports-style frame. Arms can be tilted. High impact resistant, polycarbonate lens. Lenses have integral matt side panels. Weighing only 26g, these eyeshields are the lightest of their kind. The lens coating is uvex supravision sapphire, excellent scratch resistance and gives 100% UV protection.

uvex

Colour	Lens	PK	Cat. No.
red	grey / UV 5-2.5	1	9.005 127
red	transparent / UV 2-1.2	1	9.005 128
blue	grey / UV 5-2.5	1	6.200 303
blue	transparent / UV 2-1.2	1	6.900 098

Safety Eyeshields uvex sport style

Thanks to innovative uvex duo component technology, the uvex sport style goggles fit perfectly for every head shape. The adjustable, very soft nose pad always guarantees optimum fit and prevents from unpleasant pressure. Weighing just 23g, it is one of the lightest safety glasses in the market. The low weight and ergonomic design provide, even during prolonged use, the highest comfort.

uvex

- Clear, sportive design
- Unisex
- Maximum functionality
- UV400 protection
- Panorama view
- Only 23 grams weight
- Anti-fog on the inside, scratch resistant on the outside

Coating of the lens: uvex supravision extreme

Colour	Lens	PK	Cat. No.
black/blue	clear, UV 400, 2C-1.2	1	6.281 175 2
black/lime	clear, UV 400, 2C-1.2	1	4.672 690 3
black/white	clear, UV 400, 2C-1.2	1	4.672 700 4

2



6.281 175

3



4.672 690

4



6.281 177

We can **supply** this
manufacturer's
whole
product range !



Safety Eyeshields uvex pheos/pheos s (small), pheos one

The modern, fashionable design of the uvex pheos safety spectacle makes it ideal for everyday wear. In addition to an attractive design, this safety spectacle incorporates highly innovative technology. Extremely scratch-resistant on the outside and permanently anti-fog on the inside thanks to uvex supravision excellence lens coating technology.

uvex

- Modern, fashionable safety spectacle design
- Duo-spherical lens with uvex supravision excellence lens coating
- Rimless spectacles with wide field of vision and easy to clean
- Permanent anti-fog on the inside
- Extremely scratch-resistant on the outside
- Completely metal-free

uvex pheos s: Smaller version of uvex pheos for narrower heads. Same properties as the standard models.

Type	Colour	Lens	PK	Cat. No.
uvex pheos	black/green	PC clear, UV 400, 2-1.2	1	6.251 700 1
uvex pheos	black/yellow	PC amber, UV 400, 2C-1.2	1	6.255 465
uvex pheos	black/grey	PC grey, UV 400, 5-2.5	1	6.252 972 2
uvex pheos	light grey/grey	PC clear, UV 400, 2C-1.2	1	6.257 035 3
uvex pheos	black/grey	PC clear, UV 400, 2C-1.2	1	7.661 152
uvex pheos s	white/green	PC clear, UV 400, 2C-1.2	1	6.257 034 4
uvex pheos s	anthracite/grey	PC clear, UV 400, 2C-1.2	1	6.281 178

1



6.251 700

2



6.252 972

3



6.257 035

4



6.257 034

Safety Eyeshields uvex pheos cx2

High wearer comfort and protection thanks to uvex duo component injection moulded forehead and nose piece

uvex

- "x" brand modern, sporty design
- Twist-arm technology for secure fit, comfort and protection
- Robust hard components, comfortable soft components
- Also available with amber or as sunglare filter lens with UV 400 protection
- Scratch-resistant outside, anti-fog inside thanks to uvex supravision excellence coating
- Excellent ventilation for healthy eyes
- Perfect fit for all facial shapes

CBR 65 disc technology:

Contrast (contrast-enhancing), **Blue** (blue light reduction), **Relax** (relaxed vision), **65** (65% transmission)

Type	Colour	Lens	PK	Cat. No.
uvex pheos cx2	white/black	PC grey, UV 400, 5-2,5	1	6.270 937 5
uvex pheos cx2	black/yellow	PC amber, UV 400, 2C-1,2	1	6.270 938 6
uvex pheos cx2	blue/grey	PC clear, UV 400, 2C-1,2	1	6.270 936 7
uvex pheos cx2	red/grey	PC clear, UV 400, 2C-1,2	1	6.270 935
uvex pheos cx2, CBR 65	white/black	PC, light brown, UV 400, 5-1,4	1	4.664 598 8

5



6.270 937

6



6.270 938

7



6.270 936

8



4.664 598

1

1 Safety Eyeshields uvex i-vo 9160

Fashionable, sports-style design, eyeshield with comfortable, semi-elastic frame incorporating two-component technology. Ultra-transparent lenses with scratch-proof, outer coating. Eyeshields for use when carrying out all potentially hazardous work in the laboratory. uvex

The coating of the lens is supravision excellence, outside scratch-resistant, inside non-fogging and gives 100% UV protection.

supravision sapphire, easy to clean coating, excellent scratch and chemical resistance and gives 100% UV protection.

Colour	Lens	PK	Cat. No.
blue/grey	transparent/UV 2-1.2, sv excellence	1	9.005 116
blue/orange	transparent/UV 2-1.2, sv excellence	1	6.311 677
black/grey	transparent/UV 2-1.2, sv excellence	1	6.901 653
blue/orange	transparent/UV 2-1.2, sv sapphire	1	6.324 668
black/grey	grey/UV 5-2.5, sv sapphire	1	9.005 117
blue/orange	brown/UV 5-2.5, sv sapphire	1	6.318 848

2

2 LLG-Panoramic Eyeshield

- CE approved to EN166 and EN170
- Linear and compact design
- Can be worn over any prescription spectacles
- Wide, fully adjustable headband
- Frame made of tested hypo-allergenic material
- 100% UV protection (up to 380nm)
- Weight: 84 g

Colour	Lens	PK	Cat. No.
blue	clear, polycarbonate, 2C-1.2	5	6.284 811
blue	clear, polycarbonate, 2C-1.2	1	6.291 832

3

3 Panoramic Eyeshield 2890 and 2890SA

The 3M™ 2890 and 2890SA safety goggles are a classic panoramic eyeshield, with a modern, slim design. They feature acetate, anti-fog lenses, that offer reliable protection and optimized sight. The broad, comfortable and adjustable headband, variable lateral joints and grooves allow the 3M™ 2890 and 2890SA to be worn over prescription glasses, and is ideal for use in many laboratory applications. 3M Deutschland

Can be worn with the 3M™ 4000 half mask series for complete face protection.

- Suitable for over glasses
- Compatible with the 3M™ 4000 half mask series
- Type 2890 with indirect ventilation
- Type 2890SA without ventilation, gas-tight
- Protection against gas and fine dust
- Excellent chemical resistance
- UV-protection
- EN 166

Type	Colour	Lens	PK	Cat. No.
2890	transparent	clear, polycarbonate, 2C-1.2 3M 1 N BT 9	1	6.266 909
2890SA	transparent	clear, acetate, 2C-1.2 3M 1 N FT	1	6.235 920

4

4 Panoramic Eyeshield uvex 9405

- large goggle with front ventilation system uvex
- suitable for use with half masks and filtering half masks
- ideal for prescription glasses, easy headband adjustment, easy changing of lens
- crystal acrylic lens, non-fogging

Colour	Lens	PK	Cat. No.
transparent grey	transparent /UV 2-1.2, non-fogging	1	9.005 090
	Replacement lens, transparent, non-fogging	1	6.268 289

2. Occupational safety, Security Eye protection/Panoramic eyeshields-Overgoggles

1 Panoramic Eyeshield uvex ultrasonic 9302

Extremely safe and comfortable, semi-elastic frame incorporating two-component technology. Panoramic lens with two separate lacquer coatings.

uvex

Coating of the lens

uvex supravision excellence: outside scratch-resistant, inside non-fogging, 100 % UV protection

Colour	Lens	PK	Cat. No.
orange/grey	transparent / UV 2-1.2	1	9.005 115



1

2 Panoramic Eyeshield uvex megasonic

NEW

uvex

- revolutionary full-vision goggles with exceptional edge-to-edge optical clarity
- unique frameless lens design
- fits comfortable over prescription spectacles with space for side arms
- soft, adaptive face seal for incredible comfort and fit
- wide 30 mm headband for superior, no pressure grip
- easily interchangeable headband and lens
- proven high performing uvex supravision lens coating technology
- 100% UV protection (up to 400 nm)
- EN 166, EN 170

Colour	Lens	PK	Cat. No.
anthracite/blue	PC colorless/UV 400 2C-1.2W, supravision excellence	1	4.672 692



2

3 Panoramic Eyeshield pheos cx2 sonic

uvex

- uvex lightest compact wide-vision goggles (34 grams)
- Frame colors: white, black
- Clear PC lens
- Certified to EN 166 and EN 170
- Labelling: W 166 3 4 BT CE 5-1.4 W 1 BT KN CE
- Reliable UV 400 protection
- Comfortable protection thanks to soft forehead and nose piece moulded directly onto the lens
- Scratch-proof exterior, permanently anti-fog interior (uvex supravision extreme)
- Very soft, light textile headband for secure and comfortable fit
- Can be easily combined with other PPE

Colour	Lens	PK	Cat. No.
black/white	PC colorless/UV 400 5-1,4 uvex supravision extreme	1	4.664 600



3

4 LLG-Safety Eyeshields basic



- CE approved to EN166 and EN170
- Perfect for visitors as well as over goggles for spectacles wearers
- Integrated side lens with venting, 180° visual field
- Frame made of tested hypo-allergenic material
- 100% UV protection (up to 380 nm)
- Weight: 43g

Colour	Lens	PK	Cat. No.
Clear	Clear, uncoated, 2-1.2 U 1 F CE	10	9.006 002



4

5 Overgoggles uvex 9161 and uvex 9161 duo-flex®

uvex

- Designed to fit over prescription spectacles
- Unlimited side vision through super panorama lenses with a 180° field of view
- Excellent, pressure-free fit
- Effective indirect ventilation through special frame construction with side shields

Type 9161 duo-flex®

- Frame can be adjusted four ways for optimal comfort
- Scratch resistant lens, uvex supravision sapphire

Type	Colour	Lens	PK	Cat. No.
9161	transparent	transparent, PC lenses	1	9.005 166
9161 duo-flex®	blue/black	transparent, UV 2-1.2	1	9.005 107



5

Overgoggles uvex super OTG 9169

The super OTG and the super f OTG are equipped with this state-of-the-art lens technology. Alongside the tried and tested hingeless spectacles and highly flexible soft ear pieces, a hinged design has been developed. The revolutionary new design of the super f OTG with hinge combines all the principles of contemporary spectacles with the advantages of state-of-the-art materials. Both designs are well-suited to any wearer situation, and can also be used as overspecs for prescription wearers.

uvex

Coating of the lens

1. uvex supervision sapphire: excellent scratch and chemical resistance, 100% UV protection
2. uvex supervision excellence: excellent scratch and chemical resistance and easy to clean (nano clean hybrid)

Type	Colour	Lens	Coating	PK	Cat. No.
super f OTG	black	PC transparent/UV 2-1.2	1	1	6.252 619 1
super f OTG	black/white	PC light brown 5-1.4	2	1	4.672 691
super OTG	navy blue	PC transparent/UV 2-1.2	2	1	6.234 320
super OTG	navy blue	PC transparent/UV 2-1.2	1	1	7.650 112 2
super OTG	black	PC grey /UV 5-2.5	1	1	7.653 307 3

1



6.252 619

2



7.650 112

3



7.653 307

4



4 LLG-Dispenserbox, Acrylic Glass

With hinged lid. For storage of laboratory tools, e.g. laboratory goggles, gloves or other small items. Wall mounting possible (mounting material included)
- for about 12 goggles

Description	Dimensions (W x D x H) mm	PK	Cat. No.
LLG-Dispenserbox	216 x 216 x 200	1	6.286 593

5



5 Lens Cleaning Tissues 9963

- suitable for all uvex lenses
 - silicone-free
 - 100 individually sealed tissues in a box.
 - incl. clip for wall mounting
- Please order wall mounting unit separately.

uvex

Description	PK	Cat. No.
Cleaning tissues 9963	100	6.200 654
Wall mounting unit	1	6.242 313

1 2 Mini-Ultrasonic Cleaner LLG-uniSONIC 1

For convenient cleaning of goggles or smaller laboratory instruments. Eco-friendly, only needs warm water. By ultrasonic sound millions of small air bubbles are generated. Combined with a very high pressure these achieve a fast, efficient and effortless cleaning.

- Ready to use, no assembly required
- Automatic 3-minute-operation can be stopped anytime
- Removable lid
- Stainless steel tank

Scope of supply: ultrasonic cleaning device, lid

1



2



Specifications

Capacity:	approx. 340 ml
Frequency:	45 kHz
cleaning performance:	30 Watt
Outer Dimensions (W x D x H) approx.:	200 x 115 x 115 mm
Dimensions tank (W x D x H) approx.:	155 x 80 x 40 mm
Weight:	630 g
Power supply:	220 ... 240 V, 50 Hz
Warranty:	3 years

Type	PK	Cat. No.
LLG-uniSONIC 1	1	6.263 560

3 LLG-Protective Visor with chin protection

- Transparent 1 mm Flip-up protective polycarbonate visor
- 100% UV protection (to 380 nm)
- Head holder adjustable with elastic band
- Height adjustable head holder
- Can be worn over glasses and protective masks
- Weight: 224g

3



Description	PK	Cat. No.
LLG-Face visor with chin protection, clear PC shield, elastic headband	1	6.284 958

4 Face Shields Clearways

Browguard CB14:

- Light weight
- Elastic napestrap allows individual adjustment
- Adjust headband while wearing the face shield

Honeywell Safety

Face shield visors:

- Impact and chemical resistant
- Comfortable and lightweight, even during extended usage
- Visor can be tilted upwards and locked in any position
- Easy exchangeable visors

Please order browguard and visor separately.

4



Type	Description	PK	Cat. No.
CB14	Browguard with elastic napestrap	1	9.005 067
CV83 P	Face shield visor, PC with UV-protection (100 to 380nm), against mechanical hazards	1	9.005 066
CV84 A	Face shield visor, Acetat, against spilling chemical	1	6.070 565

1



1 Surgical Face Masks, Profil Elastic Bands

- soft, non-irritating, elastic bands
- three-ply, non-fibre-glass, filter material
- integral nose bridge
- bacterial filtration efficiency 99%
- EN 14683 type II R, CE

Unigloves

Colour	PK	Cat. No.
white	50	6.264 475
green	50	6.264 631
blue	50	9.405 162

2



2 Surgical Face Masks BASIC

- tear-resistant, bands
- three-ply, non-fibre-glass filter material
- integral nose bridge
- bacterial filtration efficiency 99 %
- EN 14683 Typ II R, CE

Unigloves

Colour	PK	Cat. No.
white	50	9.405 165

3



3 Surgical Masks, Tie-On and Ear-Loop

Surgical Face Masks type II with elastic ear-loop or with tie-tapes. Superb, non-allergenic material, latex-free, preferred for its comfort and breathability inner lining. According to EN 14683.

3M Deutschland

- Type 1826: Ear-Loop OP-Masks, Type II R, Pressure difference < 60
- Type 1818: Tie-On OP-Masks, Type II, Pressure difference < 40

Type	Description	PK	Cat. No.
1826	Ear-Loop	50	6.253 796
1818	Tie-On	50	9.405 106

4



Tie-on

4 5 Surgical Masks, Tie-on and Earloop

Surgical Face Masks with tie-tapes or with elastic earloop

B. Braun Deutschland

- Surgical face mask type II
- According to EN 14683:2005
- For patients and health care professionals
- Non-woven latex-free material
- Excellent fit
- Breathing resistance < 29.4 Pa/cm²
- Bacterial filtration efficiency (BFE) ≥ 98 %

5



Earloop

Type	PK	Cat. No.
Tie-on	50	6.292 221
Earloop	50	4.667 902

Protection level classification

These filter classes are minimum requirements and simply serve as a guide. It is the wearers' responsibility to make sure the breathing apparatus conforms to the requirements in terms of hazardous materials and concentration before use!

FFP 1: for particles that are neither toxic nor associated with fibrosis. For protection up to 4 times the corresponding threshold limit value

FFP 2: for hazardous or harmful particles, vapour and smoke; filters for solid and liquid particles with a medium filtering level. For protection up to 10 times the corresponding threshold value

FFP 3: for poisonous particles, vapour and smoke; filters for solid and liquid aerosols with a high filtering classification. For protection up to 30 times the corresponding threshold limit value

R labelling: The mask has been tested for reusability and has the required performance features for wearing during a second work shift.

NR: non reusable

D labelling: The mask has undergone additional dolomite dust testing and therefore affords excellent breathability, even in extremely dusty environments and during longer periods of use.

Respirator Series BARIMASK



BartelsRieger

Particle filtering half mask Series BARIMASK with exhalation valve for protection against liquid and solid particles

- Folding masks or moulded masks
- According to EN 149:2001+A1:2009,
- With two adjustable head straps,
- Adjustable noseband,
- Foam padding in the nose area
- Exhalation valve.



6.311 972

Type	Description	Protection-level	PK	Cat. No.
BARIMASK C2	moulded masks, without exhalation valve	FFP2	20	4.672 094
BARIMASK C2V	moulded masks, with exhalation valve	FFP2	10	6.311 972 1
BARIMASK C3V	moulded masks, with exhalation valve	FFP3	10	6.311 973
BARIMASK F2	folded, without exhalation valve	FFP2	20	4.672 096
BARIMASK F2V	folded, with exhalation valve	FFP2	15	6.311 970 2
BARIMASK F3V	folded, with exhalation valve	FFP3	10	6.311 971



6.311 970

Respirators silv-Air c, Moulded Masks

- highest safety (certified according EN149)
- anatomical design and soft material-edges, avoid bruising to the face
- compatible with safety spectacles because of the safe optimised nose-area
- seamless, continuous headband for comfortable and secure mask fit
- innovative shape-optimised design
- circulatory venting via the soft edges, prevents fogging of safety spectacles
- colour coding
- model silv-Air 2220 with carbon layer in the filter reduces unpleasant odors additionally

uvex



9.005 753

Type	Description	Protection-level	Colour coding	Colour	PK	Cat. No.
silv-Air 2100	with half circulatory venting	FFP1	blue	white	20	9.005 750
silv-Air 2110	with exhale valve, with half circulatory venting	FFP1	blue	white	15	9.005 751
silv-Air 2200	with half circulatory venting	FFP2	orange	white	20	9.005 752
silv-Air 2210	with exhale valve, with half circulatory venting	FFP2	orange	white	15	9.005 753 3
silv-Air 2220	with exhale valve and carbon filter, with half circulatory venting	FFP2	orange	silver	15	9.005 754
silv-Air 2310	with exhale valve	FFP3	black	white	15	9.005 755

Particle-filtering folding mask silv-Air 5110, 5210, 5310

- Particle-filtering folding mask with exhalation valve
- Individually packed
- Color: white
- Also available without exhalation valve
- Certified FFP1 face mask to EN 149 and EU Directive 89/686/EEC
- D label (dolomite dust test passed): maximum breathability even with really high dust levels
- Cannot be reused
- Flexible and adjustable nose clip
- Soft sealing lip guarantees a secure, comfortable sealed position of the mask
- Soft material edges for high wearing comfort
- Adjustable head band offering easy handling and comfortable fit

uvex

Type	Description	Protection-level	Colour coding	PK	Cat. No.
silv-Air 5110	with exhale valve	FFP1	blue	15	4.664 620 1
silv-Air 5210	with exhale valve	FFP2	orange	15	4.664 621 2
silv-Air 5310	with exhale valve	FFP3	black	15	4.664 622 3

1

4.664 620

2

4.664 621

3

4.664 622

4

4

Respirators with 2-Way-Protection Aura™ 1883+, Folding Masks

The 3M™ Aura™ Health Care Particulate Respirator 1883+ provides effective respiratory protection for use in medical environments where health care workers will be exposed to airborne dust particles, non-volatile liquid particles and bio-aerosols. This respirator limits the transmission of infectious agents from staff to patients and is suitable for use during surgical procedures and certain other medical procedures.

It protects the user as well as the product being handled.

This product also offers resistance to penetration of splashes of liquid.

Features and advantages as Aura™ 9300+ series

Authorisation: EU construction test
 Testing standards: EN 149:2001 + A1:2009
 EN14683:2005

3M Deutschland

Type	Description	Protection-level	PK	Cat. No.
Aura™ 1883+	with valve	FFP 3	8	9.005 681

Respirators Aura™ 9300+Gen3, Series, Folding Masks

The 3M™ Aura™ Particulate Respirator 9300+Gen3 Series is now the third generation. The new Cool Flow™ Comfort Valve opens 37% easier than the original Cool Flow™ valve, allowing 36% more air, together with its natural heat, to be expelled more rapidly

3M Deutschland

- Cool Flow™ Comfort Valve
- Ease of positioning
- Braided headbands
- Colour coded for easy identification (FFP1 = yellow, FFP2 = blue, FFP3 = red)
- 3M™ Advanced Electret (Filter) Media (AEM)
- Embossed top panel helps re-direct exhaled air, reducing fogging of eyewear
- Large soft nose foam material and smooth inner cover
- Hygienic individual packaging helps protect the respirator from contamination before use
- 3M Safe Guard™ Product Authentication Process

Testing standards: EN 149:2001 + A1:2009

Type	Protection-level	Description	PK	Cat. No.
Aura™ 9310+Gen3	FFP1	without valve	20	4.665 366 1
Aura™ 9312+Gen3	FFP1	with Cool-Flow valve	10	4.665 367
Aura™ 9320+Gen3	FFP2	without valve	20	4.665 368
Aura™ 9322+Gen3	FFP2	with Cool-Flow valve	10	4.665 369 2
Aura™ 9330+Gen3	FFP3	without valve	20	4.665 370
Aura™ 9332+Gen3	FFP3	with Cool-Flow valve	10	4.665 371 3
Aura™ 9312+Gen3SV	FFP1	with Cool-Flow valve, small package	5	4.665 372
Aura™ 9320+Gen3SV	FFP2	without valve, small package	5	4.665 373
Aura™ 9322+Gen3SV	FFP2	with Cool-Flow valve, small package	5	4.665 374
Aura™ 9332+Gen3SV	FFP3	with Cool-Flow valve, small package	5	4.665 375
Aura™ 9322+Gen3BV	FFP2	with Cool-Flow valve	330	4.665 376
Aura™ 9332+Gen3BV	FFP3	with Cool-Flow valve	330	6.310 598

1



4.665 366

2



4.665 369

3



4.665 371

Premium Respirators 8825+ and 8835+, Moulded Masks

Respirators Premium 8825+ and 8835+ moulded masks offer the new patented 3-dimensional face seal with integrated nose profile of 3M Premium+ Series, the convenience of a disposable mask as well as the concept of tailor-made face seal of reusable respirator masks: Flexible 3-dimensionality for an individual and securely sealed fit! The face seal of the mask 8825+ and 8835+ improves the sealing fit. The profile of the respirator directs the air escaping through the filter medium away from the face. The upward air flow is minimized as much possible reducing fogging of safety glasses.

3M Deutschland

Authorization: EU construction test
Testing standards: EN 149:2001

4



6.284 248

5



6.284 249

Type	Protection-level	Usage restrictions	PK	Cat. No.
8825+	FFP2 RD	12 x TLV	5	6.284 248 4
8835+	FFP3 RD	50 x TLV	5	6.284 249 5

1



1 Half Mask, Series 4000+

The 3M™ Maintenance-Free Reusable Half Mask, 4000+ Series incorporating a newly engineered valve assembly that helps reduce exhalation-breathing resistance by over 30 %.

3M Deutschland

- Maintenance-free construction
- Easy to fasten neck strap
- Ready to use
- Low profile design for better peripheral vision
- Lightweight, well balanced design
- Soft, non-allergenic material with textured face seal
- Central position of the exhalation valve for effective removal of heat
- Use until damaged, particulate filters clog or gas filters become saturated
- Very good compatibility with panoramic eyeshield 3M™ 2890 and 2890SA

Type	Protection-level	Usage restrictions	PK	Cat. No.
4251+	FFA1P2 R D	10 x TLV for gases/vapours 12 x TLV for particles	1	6.312 033
4255+	FFA2P3 R D	10 x TLV for gases/vapours 50 x TLV for particles	1	6.312 034
4277+	FFABE1P3 R D	10 x TLV for gases/vapours 50 x TLV for particles	1	6.312 035
4279+	FFABEK1P3 R D	10 x TLV for gases/vapours 50 x TLV for particles	1	6.312 036

2



2 Half Mask, DUETTA

Tested to EN 140 standards and certificated according to PPE guideline 89/686/EWG. With double filter connection. Plastic mask body with soft, sealing surface. Elastic adjustment straps with head gear.

BartelsRieger

- One mask size fits all face shapes
- Excellent field of vision, unrestricted freedom of movement and outstanding comfort
- Superior balance through double filter technology
- Non-allergenic
- Optimal sealing provided by newly designed sealing rim
- Easily dismantled for cleaning and maintenance
- One-piece headband for optimal fit
- Simple and secure filter attachment with bayonet connection

Type	PK	Cat. No.
Half mask, DUETTA	1	9.005 590

3



3 4 Filters for DUETTA half mask

(According to EN 143 and EN 14387)

BartelsRieger

- Filter 203 A2: Painting, varnishing, stripping
 Filter 203 P3R: Asbestos fibres, dust
 Filter 203 ABEK: Chemical industry (escape device), livestock owners
 Filter 205 A2P3: Paint spraying, dioxin

Filter 205 ABEKP3: Hydrochloric acid, formic acid, disinfection work

4



Type	Protection-level	PK	Cat. No.
Gas filter 203 A2	A2	4	9.005 592
Particle filter 203 P3R	P3 R	4	9.005 593
Gas filter 203 ABEK	ABEK1	4	9.005 594
Filter 205 A2P3	A2-P3 R	4	9.005 595
Combination filter 205 ABEKP3	ABEK1-P3 R	4	9.005 596

Half Mask, Secure Click™

NEW

3M Deutschland

Designed with smart and intuitive features 3M™ Secure Click™ Half Mask Reusable Respirator HF-800 Series is simple, comfortable and reliable. Available in three sizes: small, medium, and large.

Optionally with speaking diaphragm. Experience the greater breathability and comfort provided by the world's first quad-flow gas and vapour filter/combination filter system. Increase worker confidence that the respirator is being worn properly with the easy, one-touch, user seal check.

Please order matching filters separately.

Type	Size	Description	PK	Cat. No.
HF-801	S		1	4.672 684
HF-801SD	S	with speaking diaphragm	1	4.672 685 1
HF-802	M		1	4.672 686 2
HF-802SD	M	with speaking diaphragm	1	4.672 687
HF-803	L		1	4.672 688
HF-803SD	L	with speaking diaphragm	1	4.672 689



4.672 685



4.672 686

3 Half Mask Series 6000

3M Deutschland

Economical and easy to wear. The 3M™ 6000 Series half masks have a good price and performance ratio. They are low- maintenance, easy to handle and extremely lightweight

- Available in 3 sizes.
- Extremely lightweight mask body
- Unobstructed view due to compact design
- Double filter system for good weight distribution
- Wide range of filters for a variety of uses
- Compatible with 3M™ goggles

Please order matching filters separately.

Type	Description	PK	Cat. No.
6100	Half mask, size S	1	6.202 382
6200	Half mask, size M	1	6.303 898
6300	Half mask, size L	1	6.303 899



4 Half Mask Series 7500

3M Deutschland

The 3M™ 7500 Series Half Masks are made of skin-friendly silicone and feature "Drop-down"-Ribbons. These encircling ribbons allow you to take off the mask easily in short breaks and leave it hanging in front of the chest instead of having to take it off completely .

- "Drop-Down" ribbons
- Elastic, adjustable ribbons
- Patented 3M™ Cool Flow™ exhalation valve
- Perfect sealing fit by structured face sealing
- Double filter system for reduced breathing resistance and good weight distribution
- Wide range of spare parts and filters
- 3 sizes - fitting for every face shape
- Compatible with 3M™ Goggles

Please order matching filter separately.

Type	Description	PK	Cat. No.
7501	half mask size S	1	6.225 803
7502	half mask size M	1	7.630 104
7503	half mask size L	1	6.230 881



1

1 Full Face Mask Series 6000

Easy to wear and comfortable. The full face masks 6000 Series (Class 1) are low maintenance and impress with their easy handling and their comfort. All types of this series are equipped with a bayonet-click connection, this allows a quick and easy change of filters that you can choose from an extensive range to suit your application. The 6000 series is also characterized by an extensive range of spare parts and is easy to maintain. They are available in 3 sizes.

3M Deutschland

- Easy to maintain and economical
- Extremely lightweight mask body cares for fatigue-free work
- Compact design allows unobstructed view
- Double filter system for reduced breathing resistance and good weight distribution
- Wide range of filters for versatile applications

Please order matching filters separately.

Type	Description	Class	PK	Cat. No.
6700S	Full face mask, size S	1	1	6.234 463
6800M	Full face mask, size M	1	1	6.200 316
6900L	Full face mask, size L	1	1	6.234 464

Compatible Filter System for 3M Half and Full Masks

All filters fit via bayonet-click connection to the mask series 6000, 6500, and 7500 and 7000. The right filter for every application. No matter what the working area is, using 3M™ Respirators, the comprehensive 3M™ Filter program gives optimum safety and provides versatile application possibilities. The compatible 3M™ range of filters includes combinable changeable filters against gases, vapors and/or particles and also combination filters.

3M Deutschland

Type	Description	Protection-level	PK	Cat. No.
6051	Gas and Vapour Cartridge against organic vapours	A1	2	6.269 590
6054	Gas and Vapour Cartridge against ammonia	K1	2	6.269 584
6055	Gas and Vapour Cartridge against organic vapours	A2	2	6.269 588 2
6057	Gas and Vapour Cartridge against organic, inorganic and acid vapours	ABE1	2	6.269 589 3
6059	Gas and Vapour Cartridge against organic, inorganic and acid vapours, ammonia and particles	ABEK1	8	7.620 305 4
6000	Gas and Vapour Cartridge against organic vapours	AXP3	2	6.270 183
6075	Gas and Vapour Cartridge against organic vapours and formaldehyde	A1+ Formaldehyde	2	6.269 586
6096	Gas and Vapour Cartridge against mercury vapours and particles	A1HgP3NR	2	6.269 585
6099*	Gas and Vapour Cartridge against organic, inorganic and acid vapours and ammonia	ABEK2P3R	2	7.072 310 5
5911	Particulate Filters, for use in combination with Gas and Vapour Cartridges	P1R	2	6.267 784
5925	Particulate Filters, for use in combination with Gas and Vapour Cartridges	P2R	2	6.267 785
5935	Particulate Filters, for use in combination with Gas and Vapour Cartridges	P3R	2	6.267 786 6
501	Filter Retainer for combination of Gas and Vapour Cartridge with Particulate Filters		2	6.269 587 7

*only for Full Masks

2

6.269 588

3

6.269 589

4

7.620 305

5

7.072 310

6

6.267 786

7

6.269 587

8

8 Full Face Mask BRK 820

Tested and approved to EN 136 and CE certified. With polycarbonate visor. Speech diaphragm and round thread connection according to EN 148-1.

BartelsRieger

- Maximum field of vision thanks to low position nosepiece with two exhalation valves
- Heat resistant polycarbonate visor, tested and approved for use by firefighters
- Carefully designed airway ensures non-misting visor
- 5-point headstrap attachment
- Optimal sealing to face, can be fitted to all head sizes
- Shock-absorbing device reduces the risk of injuries caused by impacts to the mask
- Resistant PE speech membrane in stainless steel casing
- Variable fastening headstrap
- No special tools required for maintenance
- Simple operation for changing sealing rings and ventilation panels

Full face mask BRK 820 G

As facemask BRK 820, but with a scratch- and solvent-resistant surface-hardened polycarbonate lens.

Type	Class	PK	Cat. No.
BRK 820	3	1	9.005 555
BRK 820 G	3	1	6.401 235

1 Respiratory Protection - Screw-Type Filters for Full Face Mask BRK 820

1

The filters are tested and approved to EN143/EN 14387. Offer very low breathing resistance. Their lifespan depends on the toxicity, humidity and air consumption of the user. Measurements differ with application so it is impossible to predict the working lifespan.

Filter exhaustion can be detected as follows:

- Gas filters: appearance of odours, tastes or irritants in inhaled air.
- Particle filters: increase in breathing resistance.

Storage times for unused gas and combination filters (kept sealed in manufacturer's packaging) 6 years.
Particle filters can be stored for 10 years.

Individually sealed in PE bags and packed in outer boxes.

Protection level A:	Vapours from organic compounds with boiling point > 65 °C
Protection level B:	Inorganic gases and vapours e.g. chlorine, hydrogen sulphide
Protection level E:	Sulphur oxide, acidic gases
Protection level K:	Ammonia
Protection level AX:	Gases and vapors from organic compounds with boiling point < 65 °C, low boilers in groups 1 and 2
Protection level Hg:	Mercury vapours
Protection level NOST:	Nitrogen oxides, including nitric monoxide and particles P3
Protection level P 1:	Particles (fumes, smoke, dust) from inert substances
Protection level P 2:	Particles from non-toxic substances
Protection level P 3:	Particles from toxic substances

BartelsRieger



Description	Type	PK	Cat. No.
Gas filter	A2	1	9.005 558
Gas filter	AB2	1	6.224 032
Gas filter	B2	1	9.005 559
Gas filter	E2	1	7.604 410
Gas filter	K2	1	9.005 561
Gas filter	ABE2K1	1	9.005 563
Gas filter	ABEK2	1	6.224 033
Gas filter	AX	1	6.200 208
Combined filter	A2 P2 R D	1	9.005 565
Combined filter	B2 P2 R D	1	9.005 566
Combined filter	ABE2K1 P3 R D	1	7.616 476
Combined filter	AB2 P3 R D	1	6.228 471
Combined filter	B2 P3 R D	1	6.302 979
Combined filter	ABEK2 P3 R D	1	9.005 570
Combined filter	AX P3 R D	1	6.227 097
Combined filter	ABEK2Hg P3 R D	1	6.232 031
Special filter	NO P3 R D	1	6.201 023



Ear protection/Noise protection

1



1 Ear Plugs

Non-allergenic, comfortable polyurethane. Smooth surface, dirt-repellent and hygienic. Conical shape expands to fill the ear canal. Meets EN 352-2 requirements. Available with, or without connecting cord.

3M Deutschland

Sound protection (SNR): 37 dB(A)

Type	PK	Cat. No.
Without cord	200	9.005 046
With cord	100	9.005 047

2 3 4 5 Earplugs, Refill packs

The right solution for every auditory canal: Uvex ear protection plugs are available in sizes S, M and L. Their ergonomic shape offers a high wearing comfort. The soft PU foam adapts perfectly to the auditory canal, providing optimal protection. Refill packs for uvex one2click dispenser or for wall box dispenser.

uvex

Type	Sound protection (SNR)	Size	Colour	For	Package	PK	Cat. No.
com4-fit	33 dB	S	light red	Wall-mounted dispenser	packed in pairs	200	9.005 028
com4-fit	33 dB	S	light red	uvex one2click	loose	300	6.285 529
x-fit	37 dB	M	lime	Wall-mounted dispenser	packed in pairs	200	6.233 602
x-fit	37 dB	M	lime	uvex one2click	loose	300	6.268 846
xtra-fit	36 dB	L	orange	Wall-mounted dispenser	packed in pairs	200	6.285 528
xtra-fit	36 dB	L	orange	uvex one2click	loose	250	6.285 531
xact-fit	26 dB	M	lime	uvex one2click	loose	400	6.285 530

2



com4-fit

3



x-fit

4



xtra-fit

5



6



6 7 Dispenser uvex one2click and Wall-mounted dispenser

uvex one2click:

- easy-to-use and robust wall-mounted dispenser
- earplugs available to hand with just one click
- collecting tray prevents earplugs from falling on the floor
- suitable for all uvex disposable earplugs
- the transparent design makes refilling easy to monitor

uvex

Wall-mounted dispenser: Plexiglas wall-mounted dispenser, suitable for uvex x-fit, uvex com4-fit, uvex one-fit, uvex xtra-fit, uvex hi-com, uvex whisper, uvex whisper+.

7



Earplugs not included.

Description	PK	Cat. No.
uvex one2click dispenser	1	6.239 985
Wall-mounted dispenser	1	7.940 554

8



8 9 Earplugs, whisper

Easy-to-clean reusable earplugs with cord

- Reusable earplug with smooth, dirt-repellent surface
- Easy to clean with soap and water
- Hygienic storage of earplugs in hygiene box

NEW

uvex

Packing: 50 pairs in mini box or 50 pairs in hygiene box

Sound protection (SNR): 24 dB(A)

Description	PK	Cat. No.
Earplugs in hygiene box	50	7.658 725

1 Ear Plugs with Headband, 1310

These ear protectors are suitable for intermittent use. The soft plugs are made of non-allergenic material. The headband is made of hard-wearing material. Meets EN 352-2 requirements.

3M Deutschland

Sound protection (SNR): 26 dB(A)

Type	PK	Cat. No.
Ear protectors, each, 1310	10	9.005 048
Replacement plugs, pair	20	9.005 049

1



2 Ear Defender uvex K1

Soft memory foam cushions are light and extremely comfortable to wear.

uvex

- Easy length adjustment
- Padded headband for optimal comfort
- Wearer comfort is ensured through soft surface
- Designed to be lightweight with a small capsule

Sound protection (SNR): 28 dB(A)

Type	PK	Cat. No.
uvex K1	1	6.270 939

2



3 LLG-Universal dispenser, acrylic glass

LLG-Universal dispenser with hinged lid and removal opening. For clean storage of laboratory accessories, e.g. disposable hoods, overshoes or other small items. Wall mounting possible (mounting material included).

Description	Dimensions mm	PK	Cat. No.
LLG-Universal dispenser	206 x 216 x 213	1	6.289 563

3



Ear protection/Noise protection



Safety Equipment Storage Boxes SecuBox Mini/Midi/Maxi

Ideal storage containers for industrial health and safety equipment in the workplace. Labelled with international symbol, meets DIN EN ISO 7010 regulations. Easily mounted to walls or on work surfaces. Safety: Industrial health and safety equipment is available wherever it is needed. Cleanliness: Industrial health and safety equipment is protected from dirt, dust and splashes.

Dimensions (overall/internal):

Mini: 23.6 x 12.0 x 12.0 cm/23.0 x 11.2 x 11.2 cm

Midi: 23.6 x 22.5 x 12.5 cm/23.0 x 21.8 x 11.8 cm

Maxi: 23.6 x 31.5 x 20.0 cm/23.0 x 29.9 x 19.2 cm

Type	Description	Colour	PK	Cat. No.
Mini	Eye protection	blue	1	9.005 520 1
Mini	Eye protection	transparent	1	9.005 521
Mini	Ear protection	blue	1	9.005 522
Mini	Ear protection	transparent	1	9.005 523 2
Mini	Eye + ear protection	blue	1	9.005 524
Mini	Eye + ear protection	transparent	1	9.005 525
Mini	Breathing protection	blue	1	9.005 526
Mini	Breathing protection	transparent	1	9.005 527
Mini	Protection gloves	blue	1	9.005 528
Mini	Protection gloves	transparent	1	9.005 529
Mini	Hair protection	blue	1	9.005 518
Mini	Hair protection	transparent	1	9.005 519
Midi	Eye protection, without inlet	blue	1	9.005 500
Midi	Eye protection, without inlet	transparent	1	9.005 501
Midi	Ear protection	blue	1	9.005 502
Midi	Ear protection	transparent	1	9.005 503
Midi	Eye + ear protection	blue	1	9.005 504
Midi	Eye + ear protection	transparent	1	9.005 505
Midi	Breathing protection	blue	1	9.005 506
Midi	Breathing protection	transparent	1	9.005 507
Midi	Protection gloves	blue	1	9.005 508
Midi	Protection gloves	transparent	1	9.005 509
Midi	Protection gloves, long	blue	1	9.005 511
Midi	Protection gloves, long	transparent	1	9.005 512
Midi	Hair protection	blue	1	9.005 513
Midi	Hair protection	transparent	1	9.005 514
Midi	Protective overall	blue	1	9.005 515
Midi	Protective overall	transparent	1	9.005 516
Midi	Eye protection with insert for 4 safety glasses	transparent	1	9.005 548
Midi	Eye protection with insert for 4 safety glasses	blue	1	9.005 517
Midi	Inlet for Box	anthrazit	1	9.005 531
Maxi	Eye protection with insert for 12 safety glasses	transparent	1	6.286 722
Maxi	Eye protection with insert for 12 safety glasses	blue	1	9.005 549 3
Maxi	Eye and ear protection	blue	1	9.005 544 4
Maxi	Face shield	blue	1	9.005 547
Maxi	Helmet	blue	1	9.005 541
Maxi	Helmet and eye protection	blue	1	9.005 542
Maxi	Helmet and ear protection	blue	1	9.005 543
Maxi	Helmet and full face mask	blue	1	9.005 546
Maxi	Full face mask	blue	1	9.005 545



Standards for safety gloves



EN ISO 374-1:2016/Type A	Gloves with Type A must withstand a breakthrough time of 30 minutes against minimum 6 test chemicals
EN ISO 374-1:2016/Type B	Gloves with Type B must withstand a breakthrough time of 30 minutes against minimum 3 test chemicals
EN ISO 374-1:2016/Type C	Gloves with Type C must withstand a breakthrough time of 10 minutes against minimum 1 test chemicals
EN ISO 374-5 VIRUS	Protective hand gloves against microorganisms
EN 388	Protective hand gloves against mechanical risks
EN 407	Protective hand gloves against thermal risks (heat and/or fire)
EN 420	note instructions for use
EN 421	Protective hand gloves against ionising radiations and radioactive contamination
EN 511	Protective hand gloves against cold Not harmful to food stuffs
AQL-Value:	acceptable quality level for penetration

1 Disposable Gloves Premium, Vinyl



Unigloves

Non-sterile, hypoallergenic, powder-free with beaded cuff. EN 455 T 1-4, CE. Supplied in dispenser box containing 100 gloves. **Cat. I**

1



Size	PK	Cat. No.
XS (5 to 6)	100	9.005 349
S (6 to 7)	100	9.005 350
M (7 to 8)	100	9.005 351
L (8 to 9)	100	9.005 352
XL (9 to 10)	100	9.005 353

2 3 LLG-Disposable Gloves classic, Latex



The ideal glove for all applications which require a high tactile sensitivity.

- Skin-friendly
- Powder-free
- Excellent tactile sensitivity
- High durability due to special formulation
- **Cat. III Low Chemical resistant.** AQL 1.5.
- Thiuram free, reduced risk of contact eczemas

According to EN ISO 374-1:2016/Type C, EN ISO 374-5:2016, EN 420 Suitable for food handling. You can find the appropriate compatibility list on www.llg-labware.com in the Downloads section.

Glove shape:	flat with rolled edge, ambidextrous
Material:	natural latex
Colour:	natural white
Outside:	textured fingers
Inside:	powder free
Size/Length:	S, M, L, XL/med. 240 mm
Thickness (measured in double layer):	0.20 mm

2



3



Size	PK	Cat. No.
S	100	9.006 383
M	100	9.006 384
L	100	9.006 385
XL	90	9.006 386

1



1 Disposable Gloves, Vasco®, Latex, Powdered

B. Braun Deutschland

EN ISO 374-1
Type C



EN ISO 374-5



VIRUS

Protective gloves according to PPE Regulation EU 2016/425 (Cat. III)

- Powdered
- With rolled edge
- Ambidextrous
- Thickness on the palm: 0.08 mm
- Thiuram free,
- AQL 1.5
- 100 pieces per dispenser box

According to EN ISO 374-1:2016/Type C, EN ISO 374-5:2016

Size	PK	Cat. No.
S (6 to 7)	100	9.405 286
M (7 to 8)	100	9.405 287
L (8 to 9)	100	9.405 288

2



2 Disposable Gloves Vasco® Sensitive, Latex

B. Braun Deutschland

EN ISO 374-1
Type B



KPT

EN ISO 374-5



VIRUS

EN 420



Protective gloves according to PPE Regulation EU 2016/425 (Cat. III)

- Powder-free
- Chlorinated with latex-free polymer inner coating
- With rolled edge
- Ambidextrous
- Thickness on the palm: 0.12 mm
- Thiuram free,
- AQL 1.5

According to EN ISO 374-1:2016/Type B, EN ISO 374-5:2016, EN 420 Suitable for food handling.

Size	PK	Cat. No.
S (6 - 7)	100	9.405 289
M (7 - 8)	100	9.405 290
L (8 - 9)	100	9.405 291
XL (9 - 10)	90	7.657 074

3



3 Disposable Gloves Select Plus, Latex

Unigloves

EN ISO 374-1
Type C



K

EN ISO 374-5



VIRUS

EN 420



Non-sterile, powder-free, hypoallergenic, with beaded cuff and micro-roughened surface, Protein content <30µg/g. EN 455 T 1-4, CE. Type examination test acc. EN 374.

Supplied in dispenser box containing 100 gloves. **Cat. III Low Chemical resistant. AQL 1.5**

According to EN ISO 374-1:2016/Type C, EN ISO 374-5:2016, EN 420 Suitable for food handling.

Size	PK	Cat. No.
XS (5 to 6)	100	9.005 339
S (6 to 7)	100	9.005 340
M (7 to 8)	100	9.005 341
L (8 to 9)	100	9.005 342
XL (9 to 10)	100	9.005 343

1 Disposable Gloves Comfort, Latex, Powder-Free

Unigloves

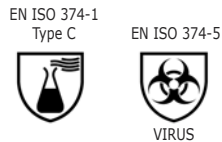

Non-sterile, hypoallergenic. With beaded cuff and micro-roughened surface. TÜV tested, AQL 1.5. Supplied in dispenser box containing 100 gloves. EN 455 T 1-3, CE. **Cat. I**
According to EN ISO 374-1:2016/Type C, EN ISO 374-5:2016

Size	PK	Cat. No.
XS (5 to 6)	100	9.405 235
S (6 to 7)	100	9.405 236
M (7 to 8)	100	9.405 237
L (8 to 9)	100	9.405 238
XL (9 to 10)	100	9.405 239

2

2 Disposable Gloves, Manufix® Sensitive, Latex

B. Braun Deutschland



Protective gloves according to PPE Regulation EU 2016/425 (Kat. III)
 - Powder-free according to MDD 93/42/EWG, EN 455
 - Natural rubber latex
 - Latex free
 - With rolled edge
 - Ambidextrous
 - Thickness on the palm: 0.12 mm
 - Thiuram free
 - AQL 1.5

According to EN ISO 374-1:2016/Type B, EN ISO 374-5:2016, EN 420 Suitable for food handling.

Type	Description	Size	PK	Cat. No.
Sensitive	powder free	S (6 - 7)	100	9.405 205
Sensitive	powder free	M (7 - 8)	100	9.405 206
Sensitive	powder free	L (8 - 9)	100	9.405 207
Sensitive	powder free	XL (9 - 10)	90	6.227 083

3

3 4 Disposable Gloves Kimtech™ Satin Plus, Latex

Kimberly-Clark

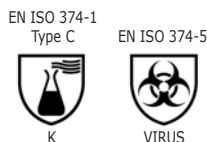

Latex, powder free, non-sterile, disposable gloves, offering excellent finger sensitivity, DIN-EN-Standard approved and certified.

- natural rubber latex
- Beaded cuff, smooth surface
- powder-free, ambidextrous, meets AQL of 1.5
- **Cat. III Low Chemical resistant.**

According to EN ISO 374-1:2016/Type C, EN ISO 374-5:2016, EN 420

Size	Length mm	PK	Cat. No.
XS (5 - 6)	240	100	9.005 390
S (6 - 7)	240	100	9.005 391
M (7 - 8)	240	100	9.005 392
L (8 - 9)	240	100	9.005 393
XL (9 - 10)	240	90	9.005 394

4



1



1 2 Disposable Gloves Kimtech™ PFE, Latex

Kimberly-Clark

 EN ISO 374-1
Type C

EN ISO 374-5



Latex, powder free, non-sterile, disposable gloves, with roughened surface providing optimal grip in wet conditions.

Supplied in dispenser box containing 100 or 90 gloves, as outlined below.

- Beaded cuff
- Ambidextrous
- Powder-free
- Meets AQL of 1.5.
- **Cat. III Low Chemical resistant**

According to EN ISO 374-1:2016/Type C, EN ISO 374-5:2016, EN 420

2



Size	Length mm	PK	Cat. No.
XS (5 to 6)	240	100	9.005 405
S (6 to 7)	240	100	9.005 406
M (7 to 8)	240	100	9.005 407
L (8 to 9)	250	100	9.005 408
XL (9 to 10)	250	90	9.005 409

3



3 4 LLG-Disposable Gloves ergo, Nitrile, Powder-Free

 EN ISO 374-1
Type B

EN ISO 374-5



EN 420



The *ergo* disposable, protective, nitrile gloves combine the comfort and "feel" of latex with the physical and chemical endurance of nitrile, with no risk of allergies. The ideal glove for all applications requiring high tactile sensation and protection against chemicals.

- **Thin - very comfortable to wear**
- Excellent tactile sensitivity - similar to latex
- Tried and tested quality product made of nitrile
- Excellent resistance to skin irritants in foodstuffs
- Specially formulated for a more resilient glove
- For single use in applications with an increased need for safety when handling chemicals
- Free from phthalates/softeners and allergenic latex proteins
- Easy to wear and particularly skin-friendly through special finishing process
- Colour: Lavender Blue
- Suitable for areas subject to HACCP standards
- **Cat. III low chemical resistant. AQL 1.5**

According to EN ISO 374-1:2016/Type B, EN ISO 374-5:2016, EN 420 Suitable for food handling. You can find the appropriate compatibility list on www.llg-labware.com in the Downloads section.

4



Glove shape:	flat with rolled edge (ambidextrous)
Material:	nitrile
Colour:	lavender blue
Outside:	textured fingers
Inside:	powder-free halogenated
Size:	XS, S, M, L, XL
Thickness (measured in double layer):	0.12mm

Size	PK	Cat. No.
XS	200	9.006 370
S	200	9.006 371
M	200	9.006 372
L	200	9.006 373
XL	180	9.006 374

1 2 LLG-Disposable Gloves, *standard*, Nitrile, Powder-Free



Disposable protective glove in nitrile with enhanced comfort in use and greater chemical protection - the standard glove for the laboratory.

- **Comfortable to wear**
- **Good tactile sensitivity**
- Tried and tested quality product made of nitrile - excellent resistance to skin irritants in foodstuffs
- More resilience through special formulation
- For single use in applications with an increased need for safety when handling chemicals
- Free from phthalates/softeners and allergenic latex proteins
- Easy to don and particularly skin-friendly through special finishing process
- Colour blue - suitable for areas subject to HACCP standards
- **Cat. III Low Chemical resistant. AQL 1.5.**

According to EN ISO 374-1:2016/Type B, EN ISO 374-5:2016, EN 421, EN 420 Suitable for food handling. You can find the appropriate compatibility list on www.llg-labware.com in the Downloads section.

Glove shape:	flat with rolled edge (ambidextrous)
Material:	nitrile
Colour:	blue
Outside:	textured
Inside:	powder-free halogenated
Size/total length:	S, M, L, XL/med. 240mm
Thickness (measured in double layer):	0.16mm

Size	PK	Cat. No.
S	100	9.006 375
M	100	9.006 376
L	100	9.006 377
XL	90	9.006 378

3 4 LLG-Disposable Gloves, *standard long*, Nitrile, Powder-Free



Disposable protective glove in nitrile with enhanced comfort in use and greater chemical protection - the standard glove for the laboratory.

- **For forearm protection, 300 mm length**
- Very comfortable to wear
- Tried and tested quality product made of nitrile - excellent resistance to skin irritants in foodstuffs
- More resilience through special formulation
- For single use in applications with an increased need for safety when handling chemicals
- Free from phthalates/softeners and allergenic latex proteins
- Easy to don and particularly skin-friendly through special finishing process
- Colour blue - suitable for areas subject to HACCP standards
- **Cat. III Low Chemical resistant. AQL 1.5.**

According to EN ISO 374-1:2016/Type B, EN ISO 374-5:2016, EN 421, EN 420 Suitable for food handling. You can find the appropriate compatibility list on www.llg-labware.com in the Downloads section.

Glove shape:	flat with rolled edge (ambidextrous)
Material:	nitrile
Colour:	blue
Outside:	textured
Inside:	powder-free halogenated
Size/total length:	S, M, L, XL/med. 300mm
Thickness (measured in double layer):	0.16mm

Size	PK	Cat. No.
S	100	6.270 366
M	100	6.270 367
L	100	6.270 368
XL	90	6.270 369



1



1 2 LLG-Disposable Gloves *strong*, Nitrile, Powder-Free

EN ISO 374-1
Type B



KTPO

EN ISO 374-5



VIRUS

EN 421



EN 420



Disposable, nitrile, heavy-walled, protective glove offering an enhanced resistance time against many chemicals. A protective glove for applications with higher safety requirements, but providing greater comfort in use than traditional chemical protective gloves.

- Very sturdy - higher material thickness

- Tried and tested quality product made of nitrile - excellent resistance to skin irritants in foodstuffs
- More resilience through special formulation
- For single use in applications with an increased need for safety when handling chemicals
- Free from phthalates/softeners and allergenic latex proteins
- Easy to don and particularly skin-friendly through special finishing process
- Colour blue - suitable for areas subject to HACCP standards

- Cat. III low chemical resistant. AQL 1.5.

According to EN ISO 374-1:2016/Type B, EN ISO 374-5:2016, EN 421, EN 420 Suitable for food handling. You can find the appropriate compatibility list on www.llg-labware.com in the Downloads section.

2



Glove shape:	flat with rolled edge (ambidextrous)
Material:	nitrile
Colour:	blue
Outside:	textured
Inside:	powder-free halogenated
Size/total length:	S, M, L, XL/med. 240mm
Thickness (measured in double layer):	0.22mm

Size	PK	Cat. No.
S	100	9.006 379
M	100	9.006 380
L	100	9.006 381
XL	90	9.006 382



1 2 Disposable Gloves Pearl, Nitrile

EN ISO 374-1
Type C



K

EN ISO 374-5



VIRUS

EN 420



Unigloves



- coloured nitrile gloves with rolling edges
- micro-roughened finger tips
- non-sterile
- powder-free
- latex-free
- AQL 1.5
- **Cat. III Low Chemical resistant**
- Dispenser box containing 100 gloves

Manufactured by EN 455, T. 1-3

According to EN ISO 374-1:2016/Type C, EN ISO 374-5:2016, EN 420 Suitable for food handling.

Type	Size	Colour	PK	Cat. No.
COBALT PEARL	XS	cobalt blue	100	6.284 466
COBALT PEARL	S	cobalt blue	100	6.284 467
COBALT PEARL	M	cobalt blue	100	6.284 468
COBALT PEARL	L	cobalt blue	100	6.284 469
COBALT PEARL	XL	cobalt blue	100	6.284 470
BLACK PEARL	XS	black	100	6.284 471
BLACK PEARL	S	black	100	6.256 325
BLACK PEARL	M	black	100	6.284 472
BLACK PEARL	L	black	100	6.255 232
BLACK PEARL	XL	black	100	6.284 473
OPAL PEARL	XS	turquoise	100	6.284 474
OPAL PEARL	S	turquoise	100	6.284 475
OPAL PEARL	M	turquoise	100	6.284 476
OPAL PEARL	L	turquoise	100	6.284 477
VIOLET PEARL	XS	violet	100	6.284 478
VIOLET PEARL	S	violet	100	6.284 479
VIOLET PEARL	M	violet	100	6.284 480
VIOLET PEARL	L	violet	100	6.243 985
VIOLET PEARL	XL	violet	100	6.243 986
PINK PEARL	XS	pink	100	6.284 481
PINK PEARL	S	pink	100	6.284 482
PINK PEARL	M	pink	100	6.284 483
PINK PEARL	L	pink	100	6.284 484
MINT PEARL	XS	mint	100	6.284 485
MINT PEARL	S	mint	100	6.284 486
MINT PEARL	M	mint	100	6.284 487
MINT PEARL	L	mint	100	6.284 488
MINT PEARL	XL	mint	100	6.284 489
PEACH PEARL	XS	apricot	100	6.284 490
PEACH PEARL	S	apricot	100	6.284 491
PEACH PEARL	M	apricot	100	6.284 492
PEACH PEARL	L	apricot	100	6.284 493
RED PEARL	XS	red	100	6.264 971
RED PEARL	S	red	100	6.282 866
RED PEARL	M	red	100	6.284 494
RED PEARL	L	red	100	6.284 495
RED PEARL	XL	red	100	6.284 496
White Pearl	XS	white	100	4.661 005
White Pearl	S	white	100	4.661 006
White Pearl	M	white	100	6.288 723
White Pearl	L	white	100	6.288 724
White Pearl	XL	white	100	4.661 009
Blue Pearl	XS	blue	100	4.661 010
Blue Pearl	S	blue	100	4.661 011
Blue Pearl	M	blue	100	4.661 012
Blue Pearl	L	blue	100	4.661 013
Blue Pearl	XL	blue	100	4.661 014
Saphir Pearl	XS	lilac	100	4.661 030
Saphir Pearl	S	lilac	100	4.661 031
Saphir Pearl	M	lilac	100	4.661 032
Saphir Pearl	L	lilac	100	4.661 033
Saphir Pearl	XL	lilac	100	4.661 034

2



1

1 2 Disposable Gloves Soft Nitril Premium, Nitrile
Unigloves

 EN ISO 374-1
Type C EN ISO 374-5 EN 420

Blue, non-sterile, powder-free, rolling edges.
Manufactured by EN 455, T. 1-4, AQL 1.5, CE.

Cat. III Low Chemical resistant

Supplied in dispenser box containing 100 gloves

According to EN ISO 374-1:2016/Type C, EN ISO 374-5:2016, EN 420 Suitable for food handling.

Size	Colour	PK	Cat. No.
XS (5-6)	blue	100	6.276 107
S (6-7)	blue	100	9.005 313
M (7-8)	blue	100	9.005 313
L (8-9)	blue	100	9.005 314
XL (9-10)	blue	100	9.005 315
XS (5-6)	white	100	4.661 058
S (6-7)	white	100	9.005 362
M (7-8)	white	100	9.005 363
L (8-9)	white	100	9.005 364
XL (9-10)	white	100	9.005 365

2

3

3 Disposable Gloves Format Blue, Nitrile
Unigloves

 EN ISO 374-1
Type C EN ISO 374-5 EN 420

Blue, powder-free, non-sterile, rolled edges.
Manufactured by EN 455, T. 1-4, EN 374, AQL 1.5, CE.

Cat. III Low Chemical resistance.

Supplied in dispenser box containing 100 gloves.

According to EN ISO 374-1:2016/Type C, EN ISO 374-5:2016, EN 420 Suitable for food handling.

Size	PK	Cat. No.
S (6-7)	100	9.005 395
M (7-8)	100	9.005 396
L (8-9)	100	9.005 397
XL (9-10)	100	9.005 398

4

4 Disposable Gloves Format, Nitrile
Unigloves

 EN ISO 374-1
Type C EN ISO 374-5 EN 420

Non-sterile, powder-free, hypoallergenic, with beaded cuff and microroughened surface.
EN 455 T 1-3, CE. Type examination test acc. EN 374. **Cat. III Low Chemical resistant.**
Supplied in dispenser box containing 100 gloves.

According to EN ISO 374-1:2016/Type C, EN ISO 374-5:2016, EN 420

Size	PK	Cat. No.
XS (5 to 6)	100	9.005 344
S (6 to 7)	100	9.005 345
M (7 to 8)	100	9.005 346
L (8 to 9)	100	9.005 347
XL (9 to 10)	100	9.005 348

1 2 Disposable Gloves TouchNTuff®, Nitrile

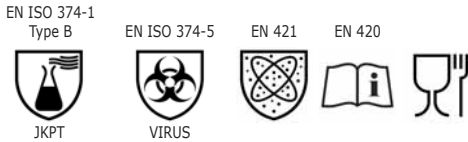

Ansell

- Manufactured from nitrile, TouchNTuff® offers up to four times the puncture resistance of comparable natural-latex gloves, and three times the resistance of similar neoprene gloves.
- It contains no natural rubber proteins, which means no risk of Type I allergies for the wearer. Primary skin irritation studies and Insult Patch tests have also shown no evidence of risk from irritation or allergic contact dermatitis.
- With a unique "Thin Nitrile Technology" formulation, this glove offers easy donning and strong grip in wet or dry conditions.
- The glove is highly versatile and suitable for many different uses.
- AQL 1.5 (EN374)
- **Cat. III Low Chemical resistant.**
- 100 % nitrile, powder-free, green, 0.12 mm thick, smooth.
- Supplied in dispenser box containing 100 gloves.

According to EN ISO 374-1:2016/Type B, EN ISO 374-5:2016, EN 421, EN 420 Suitable for food handling.

Size	Length mm	PK	Cat. No.
S (6.5 - 7)	240	100	9.005 400
M (7.5 - 8)	240	100	9.005 401
L (8.5 - 9)	240	100	9.005 402
XL (9.5 - 10)	240	100	9.005 403
S (6.5 - 7)	300	100	7.651 232
M (7.5 - 8)	300	100	6.236 916
L (8.5 - 9)	300	100	6.236 917
XL (9.5 - 10)	300	100	7.651 351

3 4 Disposable Gloves Touch N Tuff® Blue, Nitrile



Ansell

- Made from an innovative nitrile compound which offers outstanding chemical and mechanical properties, comfort and dexterity.
- Three times the puncture resistance of latex or PVC disposable. Lighter and cooler, yet safer and more durable.
- 100% nitrile; no waxes, silicone or plasticizers.
- Powder-free. No risk of contaminating food with corn starch used to powder gloves.
- Textured finish on fingertips. Improved grip.
- Rolled cuff. Provides added protection at wrist and ensures a secure fit.
- AQL 1.5 (EN374)
- **Cat. III Low Chemical resistant.**

According to EN ISO 374-1:2016/Type B, EN ISO 374-5:2016, EN 420 Suitable for food handling.

Size	Length mm	PK	Cat. No.
S	240	100	6.090 788
M	240	100	6.090 366
L	240	100	6.091 887
XL	240	100	6.304 322
S	300	100	6.231 797
M	300	100	6.233 417
L	300	100	6.234 173
XL	300	100	9.005 404

1



2



3



4



1



1 2 Disposable Gloves Kimtech™ Sterling™, Nitrile

Kimberly-Clark



- Synthetic nitrile polymer
- Contains no natural rubber latex
- Powder free
- Beaded cuff
- Textured fingertip for more sensitivity
- Ambidextrous
- Certificate of Analysis available online
- Meets AQL level of 0.65 for pinholes
- Smallest thickness 0.07mm
- **Cat. III Low Chemical resistant.**

According to EN ISO 374-1:2016/Type C, EN ISO 374-5:2016, EN 420 Suitable for food handling.

2



Size	Length mm	PK	Cat. No.
XS (5-6)	240	150	9.005 275
S (6-7)	240	150	9.005 276
M (7-8)	240	150	9.005 277
L (8-9)	250	150	9.005 278
XL (9-10)	250	140	9.005 279

3



3 4 Disposable Gloves Kimtech™ Purple Nitrile™

Kimberly-Clark

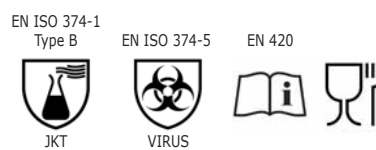

Offering the highest protection of all Kimtech™ gloves, Purple Nitrile™ gloves are latex-, silicone- and powder-free.

- Contains no natural rubber latex
- Textured fingertip, enhances wet and dry grip
- Powder-free
- Beaded cuff, for added strength and ease in donning
- Unique purple colour provides quick visual differentiation
- Ambidextrous
- Virus Protection
- AQL 0.65
- **Cat. III Low Chemical resistant**

According to EN ISO 374-1:2016/Type B, EN ISO 374-5:2016, EN 420 Suitable for food handling.

4



Size	Length mm	PK	Cat. No.
XS (5 to 6)	240	100	9.005 420
S (6 to 7)	240	100	9.005 421
M (7 to 8)	240	100	9.005 422
L (8 to 9)	250	100	9.005 423
XL (9 to 10)	250	90	9.005 424

1 2 Disposable Gloves Kimtech™ Purple Nitrile™ Xtra™

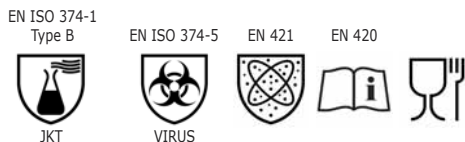

Kimberly-Clark

Disposable protective glove in nitrile with enhanced comfort in use and greater chemical protection

- Latex-, silicone- and powder-free
- Ambidextrous
- Beaded cuffs, extralong
- Textured fingertips for very good grip
- Excellent fit
- AQL 0.65
- Smallest thickness 0.11 mm
- **Cat III**

According to EN ISO 374-1:2016/Type B, EN ISO 374-5:2016, EN 421, EN 420 Suitable for food handling.

Size	Length mm	PK	Cat. No.
XS (5 - 6)	300	50	6.280 034
S (6 - 7)	300	50	6.280 035
M (7 - 8)	300	50	6.280 036
L (8 - 9)	300	50	6.280 037
XL (9 - 10)	300	50	6.280 038



3 4 Disposable Gloves Kimtech™ Green Nitrile



Kimberly-Clark

These thin nitrile gloves are durable, comfortable to wear and offer an excellent protection against chemical splashes, viruses and microorganisms hazards.

- Latex-, silicone- and powder-free
- Ambidextrous
- Beaded cuffs
- Textured fingertips for very good grip
- Excellent fit
- AQL 0.65
- Smallest thickness 0.06 mm
- **Cat. III low chemical resistant.**

According to EN ISO 374-1:2016/Type C, EN ISO 374-5:2016, EN 420 Suitable for food handling.

Size	Length mm	PK	Cat. No.
XS (5-6)	240	250	9.005 176
S (6-7)	240	250	7.970 224
M (7-8)	240	250	7.970 225
L (8-9)	250	250	7.970 226
XL (9-10)	250	225	9.005 177



1



1 2 Disposable gloves, Semperguard® Green, Nitrile

NEW
Semperit

EN ISO 374-1
Type B



EN ISO 374-5



EN 420



- Skin-friendly
- Powder free
- Non-sterile
- Flat with rolled edge
- Textured fingertips for more grip
- Easy to tighten thanks to special inner coating
- AQL 1.5
- **Cat. III low chemical resistant**

According to EN ISO 374-1:2016/Type B, EN ISO 374-5:2016, EN 420 Suitable for food handling.

2



Colour: Mint green
Thickness (measured in double layer): 0.12 mm

Size	Length mm	PK	Cat. No.
XS	240	200	6.292 175
S	240	200	6.292 176
M	240	200	6.292 177
L	240	200	6.292 178
XL	240	200	6.291 829

3



3 4 General disposable gloves MICROFLEX® 93-852, nitrile

NEW
Ansell

EN ISO 374-1
Type B



EN ISO 374-5



EN 420



The black gloves form a high-contrast background for recognizing brighter materials. The fully textured structure without foam cushioning allows a firm wet grip.

- Non-foaming
- Latex-free
- Powder-free
- With rolled edge
- Food-safe
- EN 455 part 1-4, AQL 1.5
- ISO 13485:2003
- **Cat. III low chemical resistant**

According to EN ISO 374-1:2016/Type B, EN ISO 374-5:2016, EN 420 Suitable for food handling.

4



Colour: Black
Thickness (measured in double layer): 0.12 mm

Size	Length mm	PK	Cat. No.
XS (5.5 - 6)	245	1000	6.311 698
S (6.5 - 7)	245	1000	6.311 699
M (7.5 - 8)	245	1000	4.665 733
L (8.5 - 9)	245	1000	6.273 713
XL (9.5 - 10)	245	1000	6.311 700

1 2 Disposable Gloves Microflex® 93-850, Neoprene



Ansell



- Ultimate barrier significantly reduces risk of harmful exposures and rip-tear
- 2X more chemical splash protection than leading brands* due to breakthrough polymer bonding technique**
- Exceeds every known standard for barrier quality and consistency (Low 0.40 AQL)
- Made with TNT™ Chemical Splash Resistance Technology, for soft durable protection against a wide range of chemicals
- Silicone-free formulation for product protection
- EN Norm: ISO 374-1:2016/Typ B, ISO 374-5:2016, EN 421:2010

*Based on EN 374 and ASTM F739 chemical permeation test data, when compared to performance of disposable nitrile gloves of a similar weight.

**Patent pending polymer bonding technique show less

Size	Length mm	PK	Cat. No.
5.5 - 6	240	1000	4.662 112
6.5 - 7	240	1000	4.662 113
7.5 - 8	240	1000	4.662 114
8.5 - 9	240	1000	4.662 115
9.5 - 10	240	1000	4.662 116
10.5 - 11	240	1000	4.662 117

3 4 Disposable Gloves Microflex® 93-260, Neoprene



Ansell



- Particularly thin disposable Gloves.
- Tough chemical protection unparalleled comfort.
- Three layer design for superior protection against harsh chemicals, including acids, solvents and bases.
- Thin mil construction provides enhanced tactility and dexterity.
- Extra soft material and ergonomic design for outstanding fit, feel and flexibility for longer wear time.
- Lower acceptable pinhole rate (0.65 AQL) and extended cuff for reliable protection against hazardous substances.
- Thickness 0.20 mm
- Silicone free formulation and processing ensure better product protection. **Cat. III**

According to EN ISO 374-1:2016/Type A, EN ISO 374-5:2016, EN 421, EN 388

Size	Length mm	PK	Cat. No.
XS	300	50	6.285 431
S	300	50	6.285 432
M	300	50	6.285 433
L	300	50	6.285 434
XL	300	50	6.285 435
XXL	300	50	6.285 436

1



2



1 2 Disposable Gloves NeoTouch®, Neoprene

Ansell

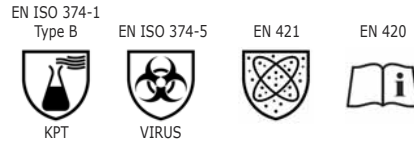

- With a latex-free formulation, NeoTouch® gloves are appropriate for the prevention of Type I allergies. Because they're powder-free, they also limit the risk of dermatitis for the wearer.
- They provide excellent resistance to acids, bases and alcohols. Thanks to an exclusive formulation, NeoTouch® gloves are convincingly the most comfortable synthetic single-use gloves available today.
- NeoTouch® gloves have a polyurethane inner-coating that ensures easy donning. Their textured fingertips provide a secure grip in both dry and wet conditions. The beaded cuff ensures a secure hold, and their green colour makes them easy to identify.
- NeoTouch® gloves are inspected to an AQL of 1.5 for pinholes, which matches the legal requirements for medical gloves.
- **Cat. III Low Chemical resistant.**

According to EN ISO 374-1:2016/Type B, EN ISO 374-5:2016, EN 421, EN 420

Size	Length mm	PK	Cat. No.
S	240	100	6.229 608
M	240	100	6.229 607
L	240	100	6.229 606
XL	240	100	6.239 416
S	280	100	6.237 656
M	280	100	7.619 653
L	280	100	6.230 923
XL	280	100	6.237 684

3 LLG-Glove Dispenser, Coated Wire

Dispenser for 3 boxes (pict. 1), with top (left illustr.) or front insert (right illustr.). Mounting material included. Dispenser for 1 box, with top or side slot. Mounting material included.

For	Description	Width mm	Depth mm	Height mm	PK	Cat. No.
3 Boxes, 250 x 80 mm	front insert	260	90	440	1	9.405 369
3 Boxes, 255 x 85 mm	top insert	265	95	400	1	9.405 370
1 Box, 72 mm depth	top/side insert	180	85	140	1	9.405 371 4
1 Box, 135 x 85 mm	side insert	265	100	155	1	9.405 372 5

3



4



9.405 371

5



9.405 372

LLG-Glove dispenser for 1 or 3 boxes, acrylic glass

LLG glove dispensers are suitable for glove packs with the dimensions approx. 240 x 75 x 125 mm, with front insert or side slot. High-quality, sturdy design. Mounting material included.

Description	For	Width mm	Depth mm	Height mm	PK	Cat. No.
side slot, sturdy material	1 Box	250	85	136	1	6.286 594 1
front insert, flexible material	3 Boxen	260	90	405	1	9.405 373 2
side slot, sturdy material	3 Boxen	280	87	460	1	9.405 374 3



Glove Dispenser Box, Stainless Steel

18/8-9 stainless steel, for wall mounting, incl. screws and wall plugs, suitable for 1 dispensing box or suitable for 3 dispensing boxes.

For	Width mm	Depth mm	Height mm	Weight g	PK	Cat. No.
250 x 80 x 135	250	80	135	730	1	6.232 327 4
258 x 96 x 392	258	96	392	1550	1	6.228 502 5



6 Glove Dispenser, PS, Stainless Steel, Anti-Microbial

Ideal for use in cleanroom, hospitals, and microbiological work areas. MICROBAN® additive prevents growth of moulds and bacteria. High impact, durable resin is resistant to harsh cleaning solutions. The versatile glove box holder can accommodate single box or adjoined together to hold multiple boxes. Modular design allows stacking horizontally. Screws and anchors provided.

Heathrow Scientific

Width mm	Depth mm	Height mm	PK	Cat. No.
254	156	97	1	9.005 427



Code letters of chemicals

Code letter	Test chemical	Substance class
A	Methanol	Primary alcohol
B	Acetone	Ketone
C	Acetonitrile	Nitrile
D	Dichloromethane	Chlorinated paraffin
E	Carbon disulphide	Organic compound containing sulphur
F	Toluene	Aromatic hydrocarbon
G	Diethylamine	Amine
H	Tetrahydrofuran	Heterocyclic or ether compounds
I	Ethyl acetate	Ester
J	n-Heptane	Aliphatic hydrocarbon
K	Sodium hydroxide, 40%	Inorganic base
L	Sulphuric acid, 96%	Inorganic mineral acid, oxidizing
M	Nitric acid 65%	Inorganic mineral acid, oxidizing
N	Acetic acid 99%	Organic acid
O	Ammonium hydroxide 25%	Organic base
P	Hydrogen peroxide 30%	Peroxide
S	Hydrofluoric acid 40%	Inorganic mineral acid
T	Formaldehyde 37%	Aldehyde

It is essential that the manufacturer's information be studied or the manufacturer consulted directly if appropriate with regard to whether the glove affords protection against the agent, and if so, for what duration.

1

1 Chemical Protection Glove Alto 405, Neoprene/Latex

MAPA

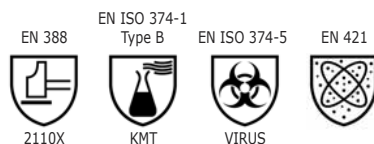

Flexible safety glove made of natural latex and neoprene offering tactile sensitivity and light chemical protection. Anatomical shape. Better grip due to embossed texture. Good dexterity. 1 pair per pack.

Length: 330 mm
 Thickness: 0.7 mm
 Colour: Yellow/Blue
 CE: **Cat. III**

Size	PK	Cat. No.
S (7)	1	9.005 308
M (8)	1	9.005 309
L (9)	1	9.005 310
XL (10)	1	9.005 311

1 Latex gloves Pro-Fit 6240, super blue



- Super Blue Chemical resistant gloves
- Back and cuff with latex coating
- Cotton jersey lining
- Palm and back of the hand has a roughened surface
- Comfortable to wear, secure grip in humid conditions and handling of slippery objects
- Good abrasion and tear protection for a long service life
- Optimal touch, seamless grip surface
- Good cold and heat insulation
- Anatomical fit
- Food contact approved
- Liquid-tight

1 pair per pack . **Cat. III**

According to EN ISO 374-1:2016/Type A, EN ISO 374-5:2016, EN 420 Suitable for food handling.

Length: approx. 300mm
Thickness: approx. 1.25mm

Size	PK	Cat. No.
7	1	6.268 358
8	1	6.268 359
9	1	6.268 360
10	1	6.268 361

1



2 Chemical Protection Glove uvex profapren CF 33, Chloroprene/Latex

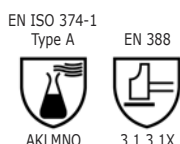

uvex

High-quality unsupported chloroprene safety glove for protection against a broad spectrum of chemicals. The silicone-free safety glove has excellent properties for protection against chemical and mechanical risks. 1 pair per pack.

Characteristics:

- good combination of flexibility and strength
- resistant to many chemicals and solvents

Applications: chemical industry, metal processing (cleaning), painting/coating, **Cat. III**

According to EN ISO 374-1:2016/Type A, EN 388

Length: 330 mm
Thickness: 0.75 mm
Colour: dark blue

Size	PK	Cat. No.
7	10	6.291 290
8	10	6.291 291
9	10	6.291 292
10	10	6.291 293
11	10	7.646 897

2



1

1 Chemical Protection Glove Ultranitrile 492, Nitrile

MAPA

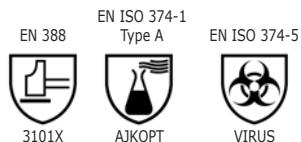

Green nitrile glove with cotton flock liner. Anatomical shape. Good grip finish on palm and fingers. High mechanical resistance. Excellent chemical protection against alcohols, oils, greases and hydrocarbons. Thin material for increased dexterity. Comfort, due to the quality of the flock-lining. **Cat. III**
Packing with 1 pair.

Length: 320mm
Thickness: 0.38mm
Colour: green
CE: **Cat. III**

Size	PK	Cat. No.
XS (6)	1	6.224 148
S (7)	1	9.005 170
M (8)	1	9.005 180
L (9)	1	9.005 190
XL (10)	1	9.005 200

2

2 Chemical Protection Glove uvex profastrong NF33, Nitrile

uvex

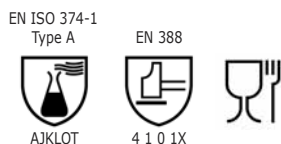

Nitrile safety gloves, proven in environments involving exposure to acids, grease and solvents. Non-sterile EN 374, 388. Packaging with 12 pairs. **Cat. III**

Characteristics

- outstanding abrasion resistance
- good grip for wet surfaces
- anatomic shape
- good dexterity

Applications

- laboratories
- food industry
- chemical industry

According to EN ISO 374-1:2016/Type A, EN 388, EN 420 Suitable for food handling.

Colour: green
Length: approx. 330 mm
Thickness: approx. 0.38 mm

Size	PK	Cat. No.
7	12	9.414 605
8	12	6.241 238
9	12	9.414 606
10	12	9.414 607



1 Chemical Protection Glove Ultranitril 381, Nitrile

1

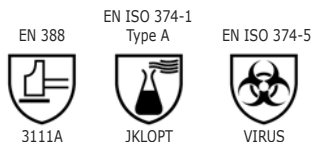

MAPA

Chemical protective glove made of nitrile with glued cotton liner for long term comfort. Anatomic shape. Z-pattern-profile for safe grip of wet things. More dexterity due to the glued cotton knit lining, which offers excellent comfort and thermal insulation. Excellent resistance against oils, greases and many solvents. 1 pair per pack.

Length: 355 mm
 Thickness: 0.85 mm
 Colour: Green
 CE: **Cat. III**

Size	PK	Cat. No.
S (7)	1	9.005 206
M (8)	1	9.005 207
L (9)	1	9.005 208
XL (10)	1	9.005 209
XXL (11)	1	9.005 199



2 Chemical Protection Gloves uvex rubiflex S, NBR

2



uvex

The comfortable NBR safety gloves, seamlessly coated in a reinforced design, with excellent chemical resistance and outstanding abrasion resistance. 1 pair per pack.

Characteristics:
 - anatomic shape
 - highly flexible
 - very good mechanical characteristics
 - excellent resistance to many chemicals, acids, alkalis, mineral oils and solvents, **Cat. III**
 - good water vapour absorption due to the cotton lining

Applications: chemical industry, automotive industry, metal processing industry, mechanical industry, sandblasting

According to EN ISO 374-1:2016/Type A, EN 388, EN 420 Suitable for food handling.

Thickness: 0.50 mm
 Colour: green

Type	Size	Length mm	PK	Cat. No.
Rubiflex S	8	350	1	9.414 608
Rubiflex S	9	350	1	9.414 609
Rubiflex S	10	350	1	9.414 610
Rubiflex S	11	350	1	9.414 611
Rubiflex S	8	400	1	6.231 389
Rubiflex S	9	400	1	6.231 425
Rubiflex S	10	400	1	6.231 447
Rubiflex S long	9	600	1	6.301 526
Rubiflex S long	10	600	1	9.414 612
Rubiflex S long	11	600	1	9.414 613



1

1 Chemical Protection Glove uvex u-chem 3200, NBR

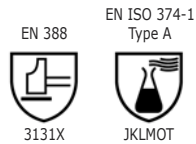
NEW
 uvex

- Good mechanical properties
- Excellent fit
- Good resistance to many chemicals
- Very good grip in wet and oily conditions
- Extremely high flexibility
- Box with 10 pairs

According to EN ISO 374-1:2016/Type A, EN 388

Material: NBR (nitrile butadiene rubber)
 Colour: petrol blue/black
 Length: 350 mm

Size	PK	Cat. No.
7	10	4.672 695
8	10	4.672 696
9	10	4.672 697
10	10	4.672 698
11	10	4.672 699

2

2 Chemical Protection Glove uvex u-chem 3300, NBR

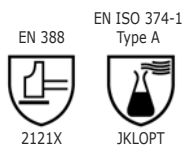
NEW
 uvex

- Good mechanical properties
- Excellent fit
- Good resistance to many chemicals
- Very good grip in wet and oily conditions
- Extremely high flexibility
- Box with 10 pairs

According to EN ISO 374-1:2016/Type A, EN 388

Material: Bamboo-rayon/Nylon
 Coating: NBR (nitrile butadiene rubber)
 Colour: blue
 Length: 320 mm

Size	PK	Cat. No.
7	10	4.675 043
8	10	4.672 693
9	10	4.675 044
10	10	4.672 694
11	10	4.675 045

1 Chemical Protection Glove Butoflex 650

1

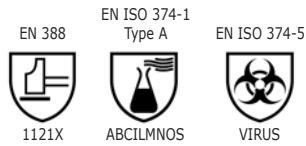

MAPA

The only Butyl glove on the market with an exclusive embossed exterior finish, meaning slippery objects can be handled without risk.

- Exceptional comfort; the first butyl glove on the market with a fabric inner lining
- Ultimate specific chemical resistance, for very corrosive acids, ketones, esters and amine derivatives
- Unrivalled flexibility and dexterity

1 pair per pack.

Length: 350 mm
 Thickness: 1.5 mm
 Colour: black
 EN: 374/388, **Cat. III**

Size	PK	Cat. No.
7	1	6.255 225
8	1	6.241 351
9	1	6.285 462
10	1	6.285 460
11	1	6.285 461



2 Undergloves, Cotton

2

100% Cotton. Monofilament, ideal to wear under chemical protection gloves. 1 pair per pack. **Cat. I**

Size	Length mm	PK	Cat. No.
6	250	1	6.235 155
7	250	1	7.623 809
8	250	1	9.005 222
9	250	1	7.625 555
10	250	1	7.623 881
11	250	1	7.623 810
12	250	1	9.005 223
13	250	1	6.224 187



3 Cut-Protection Gloves uvex C500 dry

3



uvex

- Palm with micro-nubs, for dry working areas
- Patented uvex Profas Bamboo TwinFlex® technology
- innovative SoftGrip coating
- very high cut protection (level 5)
- highest wearing comfort due to uvex climazone
- outstanding tactile feel
- high abrasion-resistance
- flexible
- silicone-free according to imprint test
- 1 pair per pack

Length: 270mm
 Colour: lime/anthracite
 EN: 388 (XX4XC)

Size	PK	Cat. No.
7	1	9.414 650
8	1	9.414 651
9	1	9.414 652
10	1	9.414 653
11	1	9.414 654



2. Occupational safety, Security Gloves/Cut resistant gloves-Temperature protective gloves

1



1 Cut-Protection Gloves uvex C500 foam

NEW

uvex

EN 388

EN 407



4X42C

X1XXXX

- Palm and fingertips coated with soft-grip foam, moisture-repellent
- Patented uvex Profas Bamboo TwinFlex® technology
- innovative SoftGrip coating
- very high cut protection (level 5)
- Analog EN 407 suitable for contact heat up to +100 °C
- highest wearing comfort due to uvex climazone
- outstanding tactile feel
- high abrasion-resistance
- flexible
- silicone-free according to imprint test
- 1 pair per pack.

Length: 270mm
 Colour: lime/anthracite
 EN: 388 (4 X 4 2 C), EN 407 (X 1 X X X X)

Size	PK	Cat. No.
7	1	9.414 655
8	1	9.414 656
9	1	9.414 657
10	1	9.414 658
11	1	9.414 659

2



2 Thermal protection glove TempDex 710 up to 125 °C

MAPA

EN 388

EN 407



4111X

X1XXXX

- Thin, anatomically-shaped glove ensures dexterity
- Excellent abrasion resistance: longer lasting
- Dot embossing for better insulation and better grip
- **Cat. II**

Size	Length mm	PK	Cat. No.
7	240	10	6.285 464
9	260	10	6.285 465
11	280	10	6.285 463

3



3 Thermal protection glove TempDex 720

NEW

MAPA

EN 388

EN 407



4343B

X2XXXX

- Thin, anatomically-shaped glove ensures dexterity
- Guaranteed without silicone
- Excellent abrasion resistance: longer lasting
- Dot embossing for better insulation and better grip
- Knitted wrist
- orange

Size	Length mm	PK	Cat. No.
7	240	1	6.311 086
8	260	1	4.674 936
9	280	1	6.311 087

1 Safety Gloves, Heat Protection, up to 232 °C

1



Heathrow Scientific



Durable Safety Gloves made of 100% knitted cotton terry cloth.

- Heat resistant when dry
- Good abrasion resistance
- Designed with a straight thumb
- Gauntlets provide extra safety for wrist and forearm protection
- One size fits all
- Washable

Length: 480 mm
 Palm width: 135 mm
 Colour: natural
 EN: EN388:2003 2X4X, EN407:2004 X2XXXX

Size	PK	Cat. No.
One size	1	4.664 781

2 Safety Gloves Clavies®, Heat Protection up to 232°C

2

Soft, pliant, all-cotton terry cloth gloves are superb for handling hot objects out of the autoclave or oven, or for other heat protection in the lab, school or industry. Note: Gloves are not waterproof and should not be used to handle dry ice. CE approved.

Bel-Art Products



Length gauntlet mm	Overall length mm	PK	Cat. No.
130	330	1	9.005 271
280	470	1	9.005 272

3 Safety Gloves Nomex®, Heat Protection up to 250 °C

3

EN 420



Very supple, offering excellent movement. Knitted construction, without seams. Temperature resistant up to 250 °C. 1 pair per pack. **Cat. II**



Description	Size	PK	Cat. No.
Gloves, standard	7 - 8	1	7.656 103
Gloves, standard	9 - 10	1	9.005 250
Gloves with forearm protection	9 - 10	1	9.005 260



1

1

Safety Gloves uvex k-basic extra 6658, Cut and Heat-Protection up to +250°C

uvex

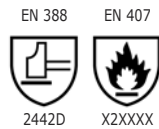

This coarse-knitted glove made of 100% Kevlar® is lined with cotton, making it ideal for protecting the wearer against heat and cuts.

The combination of Kevlar® and cotton guarantees good heat insulation and enables the handling of objects up to +250 °C without losing anything in terms of cut resistance. 1 pair per pack.

Characteristics:

- Very good protection against cut injuries
- Additional cotton cladding
- Comfortable to wear

Applications: metal processing, automotive industry, glass industry, foundries

Length: 220mm to 270mm
 Colour: yellow
 EN: 388 (2 4 4 2 D), EN 407 (X 2 X X X X)

Size	PK	Cat. No.
8	1	9.414 660
10	1	9.414 661
12	1	9.414 662

2

2

Safety Gloves, Heat Protection up to 500 °C

Jutec

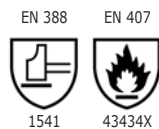

- 5-finger glove
- Protection against contact heat short term up to 500 °C
- Made of aramide fabric with special insulation
- Usable on both sides
- Abrasion resistant

Length: 400mm
 EN: 388, 407

Description	PK	Cat. No.
Heat Protection, 5 finger	1	9.006 893

3

3

Hand Protectors Hot Hand®

Bel-Art Products

Made of thick-walled silicone.

Safe, non-slip protection against very hot or cold surfaces.

Measures 10 x 19 cm with durable silicone rubber construction that remains flexible from -57 °C to +260 °C.

End pockets accept thumb and fingers to grasp objects.

Mitts have multiple studs with concave tips thus providing secure grip on virtually all hot/cold surfaces.

Type	PK	Cat. No.
Hot Hand®	1	9.119 900

1 Cold-resistant gloves TempIce 700



1



Thermal protection gloves

- Flexible, knitted cuffs
- Special Grip & Proof nitrile coating
- Cold protection down to -10 °C
- Comfortable to wear, dexterity and flexibility
- Color: blue/black

Size	Length mm	PK	Cat. No.
7	240	1	4.674 933
9	260	1	4.674 934
10	280	1	4.674 935



2 Protection Gloves CRYOLITE

2



CRYOLITE is a fully waterproof glove to protect the hand and forearm in operations that involve the use of liquid nitrogen (or other cryogenic gases) and heat. Made by materials specifically designated for this application, it keeps the hands warm and dry for long periods of use. Tested, with success, by contact with liquid nitrogen (-195.82 °C) for one minute and following test of flexibility (RCT method). Suitable for contact with Liquid Oxygen (Oxygen Index O.I. 25.4 external layer - Test Report 166/2016 Dipartimento di Ingegneria Padova). The multilayered construction allows a high level of thermal protection, flexibility and dexterity from -200 °C to 250 °C.
Cat. III

Size	PK	Cat. No.
8	1	6.291 647
9	1	6.291 648
10	1	6.291 649
11	1	6.291 650



3 Cryo Protection Gloves CRYOKIT 400, CRYOKIT 550

3

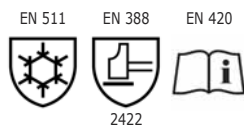

Suitable for all work with liquid nitrogen and other cryogenic gases up to approx. minus 196 °C. Protects against cold and contact burns in case of leakage of liquid gas. The waterproof glove is made of a special elastic and laminated fabric. Interior insulation: polyester multi-layer fabric (410 g/m²) and polyolefin porelle membrane. According to normative EN 511, EN 420, EN 388, Cat III. Warning: Not intended for immersion in liquid nitrogen or other liquid cryogens.
1 pair per pack

Type	Size	Length mm	PK	Cat. No.
Cryokit400	7	400	1	6.270 632
Cryokit400	8	400	1	6.270 633
Cryokit400	9	400	1	6.270 634
Cryokit400	10	400	1	6.270 635
Cryokit400	11	400	1	6.270 636
Cryokit550	8	550	1	6.270 637
Cryokit550	9	550	1	6.270 638
Cryokit550	10	550	1	6.270 639
Cryokit550	11	550	1	6.270 640



Cryokit 400

1 Protection Gloves Cryo Gloves® Standard/Waterproof

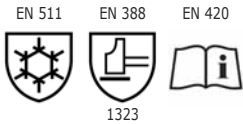

Developed to provide protection while working in very cold environments or handling ultra-cold objects and media (in the range of -160 °C). Especially for secure handling of dry ice (-79 °C), sample handling (-86 °C/-152 °C) and handling ultra cold specimens - those stored in the vapour phase of liquid nitrogen. According to normative EN 511, EN 420, EN 388, **CAT. III**

CAUTION: Not intended for immersion in liquid nitrogen or other liquid cryogens.

Cryo Gloves Waterproof :

Additional seamless PTFE inner glove; unsurpassed protection against the danger of a longer stay in ultra-low temperatures down to -160 °C .

1 pair per pack.

Type	Description	Size	PK	Cat. No.
Standard	wrist length	S (8)	1	9.405 116
Standard	wrist length	M (9)	1	9.405 117
Standard	wrist length	L (10)	1	9.405 118
Standard	wrist length	XL (11)	1	9.405 119
Standard	forearm length	S (8)	1	9.405 120
Standard	forearm length	M (9)	1	9.005 446
Standard	forearm length	L (10)	1	9.005 447
Standard	forearm length	XL (11)	1	9.405 121
Standard	elbow length	M (9)	1	9.005 451
Standard	elbow length	L (10)	1	9.005 452
Standard	elbow length	XL (11)	1	9.405 122
Standard	shoulder length	M (9)	1	9.405 123
Standard	shoulder length	L (10)	1	9.405 124
Standard	shoulder length	XL (11)	1	9.405 125
Waterproof	wrist length	S (8)	1	9.405 126
Waterproof	wrist length	M (9)	1	9.405 127
Waterproof	wrist length	L (10)	1	9.405 128
Waterproof	wrist length	XL (11)	1	9.405 129
Waterproof	forearm length	S (8)	1	9.405 130
Waterproof	forearm length	M (9)	1	9.405 131
Waterproof	forearm length	L (10)	1	9.405 132
Waterproof	forearm length	XL (11)	1	9.405 133
Waterproof	elbow length	M (9)	1	9.405 134
Waterproof	elbow length	L (10)	1	9.405 135
Waterproof	elbow length	XL (11)	1	9.405 136
Waterproof	shoulder length	M (9)	1	9.405 137
Waterproof	shoulder length	L (10)	1	9.405 138
Waterproof	shoulder length	XL (11)	1	9.405 139

1





1 Cryo-Temperature Protection Kit CRYO-TEMP-SHIELD®

Consisting of:

- 1 pair Cryo Gloves® Standard, size: optional, **see table**
- 1 x face protection shield with adjustable head mounting
- 2 x safety labels, 300 mm diameter, entitled "Face protection" and "Wear gloves"
- 1 x protection apron, Cryo Apron®, width: 610 mm, length: 1070 mm

Type	Type	Size	PK	Cat. No.
1001-S	Gloves forearm length	S (8)	1	9.405 140
1001-M	Gloves forearm length	M (9)	1	9.405 141
1001-L	Gloves forearm length	L (10)	1	9.405 142
1001-XL	Gloves forearm length	XL (11)	1	9.405 143
1102-M	Gloves elbow length	M (9)	1	9.405 144
1102-L	Gloves elbow length	L (10)	1	9.405 145
1102-XL	Gloves elbow length	XL (11)	1	9.405 146
1103-M	Gloves shoulder length	M (9)	1	9.405 147
1103-L	Gloves shoulder length	L (10)	1	9.405 148
1103-XL	Gloves shoulder length	XL (11)	1	9.405 149

2



2 Skin Protection Cream LINDESA® PROFESSIONAL with Beeswax

Non-greasy, quickly absorbed. The cream strengthens the defensive functions of the skin, preventing skin damage from external pollution and soothes irritation. Smooths and cleans without leaving a residue. LINDESA® PROFESSIONAL gives the skin elasticity and suppleness through its special caring agents. The sense of touch is not affected. For low levels of soiling it provides protection against weak acids, alkalis and organic substances.

Peter Greven

Description	PK	Cat. No.
50 ml	1	9.191 159
100 ml	1	9.191 161
50 ml	10	4.665 408
100 ml	10	4.665 407
100 ml, unperfumed *	1	9.191 162

* LINDESA® PURE PROFESSIONAL

3



3 Skin Protection Cream LINDESA® O PROFESSIONAL with Beeswax

Moderately greasy. Particularly suitable for protecting the skin against varnishes, oils, petroleum spirit, resins, dyes, paints etc. as well as for after-work care for dry skin.

Peter Greven

Capacity ml	PK	Cat. No.
100	1	9.191 148

4



4 Skin Protection Cream LINDESA® K PROFESSIONAL with Beeswax and Chamomile

Quickly absorbed. The cream strengthens the defensive functions of the skin, preventing skin damage from external pollution and soothes irritation. Smooths and cleans without leaving a residue. Using LINDESA® K PROFESSIONAL avoids greasy smears on surfaces and is therefore suitable for workers involved with enamelling, electronics production, or final inspection.

Peter Greven

Capacity ml	PK	Cat. No.
100	1	9.191 149

1 LLG-Laboratory coat, 100% cotton

- Very solid material, excellent wearing comfort
- Snap fasteners (press buttons); easy and quick to open
- With fold-down collar
- One outside breast pocket and two side pockets
- Washable up to 60°C
- Ladies coat with stitched-down back belt

Material: 100% cotton
 Colour: White
 Weight: 220 g/m²

Description	Size	PK	Cat. No.
Ladies coat	36/38	1	9.414 342
Ladies coat	40/42	1	9.414 343
Ladies coat	44/46	1	9.414 344
Mens coat	44/46	1	9.414 345
Mens coat	48	1	9.414 346
Mens coat	50	1	9.414 347
Mens coat	52	1	9.414 348
Mens coat	54	1	9.414 349
Mens coat	56	1	9.414 350

1



2 Ladies laboratory coat Type 81509, 100% cotton

With long sleeves and fitted waist. Reversible collar, concealed buttons with press buttons, 1 outside breast pocket left, 2 side pockets with diagonal access, straight sleeve seam with press buttons for width adjustment, Öko-Tex Standard 100.

uvex

Material: 100% cotton
 Colour: White
 Weight: approx. 210g/m²
 Length: approx. 105cm

Size	PK	Cat. No.
36	1	9.414 351
38	1	9.414 352
40	1	9.414 353
42	1	6.323 052
44	1	9.414 355
46	1	9.414 356
48	1	9.414 357

2



3 Mens laboratory coats Type 81996, 100% cotton

Reversible collar, concealed buttons, 1 outside breast pocket left, 1 inside breast pocket right, 2 side pockets with diagonal access with light grey piping, 2 short side slits, straight, untapered back, straight sleeve seam, Öko-Tex Standard 100

uvex

Material: 100% cotton
 Colour: White
 Weight: approx. 240g/m²
 Length: approx. 96cm

Size	PK	Cat. No.
44/46	1	9.414 371
48/50	1	9.414 373
52/54	1	9.414 375
56/58	1	9.414 377
60/62	1	9.414 379

3



1



1 Women and mens laboratory coats (Unisex) 1656

Made from 100% cotton. Offers good protection against minor spills and droplets of acids and other chemicals.

BP

- fold-down collar
- with press studs
- long sleeved
- two side pockets are provided
- one outer breast pocket
- without belt at the back

Material: Sanfor 100% cotton diagonal twill
 Colour: white
 Weight: approx. 205g/m²
 Length: approx. 103cm (Size L)

Size	PK	Cat. No.
XS	1	9.414 320
S	1	9.414 321
M	1	9.414 322
L	1	9.414 323
XL	1	9.414 324
XXL	1	9.414 325
XXXL	1	7.930 249

2



2 Women and mens laboratory coats 1654

BP

- stand-up collar
- with press studs
- long sleeved
- two side pockets are provided
- one outer breast pocket
- without belt at the back

Material: 100 % Cotton
 65% PES/35% Cotton
 Colour: white
 Weight: approx. 205 g/m²
 approx. 215g/m²
 Length: approx. 103cm

Size	Material	PK	Cat. No.
XS	100% cotton	1	6.272 965
S	100% cotton	1	6.289 933
M	100% cotton	1	6.289 934
L	100% cotton	1	6.289 935
XL	100% cotton	1	6.272 966
XS	65% PES / 35% Cotton	1	9.414 326
S	65% PES / 35% Cotton	1	9.414 327
M	65% PES / 35% Cotton	1	9.414 328
L	65% PES / 35% Cotton	1	9.414 329
XL	65% PES / 35% Cotton	1	9.414 330
XXL	65% PES / 35% Cotton	1	9.414 331



1 LLG-Disposable Visitor Gowns, PP

White PP nonwoven 30 g/m², universal size with shirt collar and elastic at the wrists, latex-free, without pocket, 4 push buttons



Description	PK	Cat. No.
LLG-Visitors gown	50	6.282 796

2 Laboratory coat Kimtech™ A7 P+, PP

Kimberly-Clark

EN 1149



- Certified PPE Cat III acc. to directive 89/686/EEC
- Type 6 limited chemical splash protection
- Micro-organism protection tested
- EN1149-1:1995 Antistatic clothing
- High performance chemical resistant fabric
- Low lint fabric, Helmke Drum Category II
- 99% particle and bacterial filtration efficiency
- Individually packed, 15 p. in an outer package for ISO 7 Grade C areas
- Silicon-Free

- Abrasion-resistant film-coated polypropylene
- Mandarin collar
- Elastic cuff, thumb-loops and extra-length arms
- High strength triple stitched seams



Size	PK	Cat. No.
S	15	4.653 906
M	15	4.653 907
L	15	4.653 908
XL	15	4.653 909
XXL	15	4.653 910

3 Laboratory Coat Tyvek® 500, PL309

Protective coat DuPont™ Tyvek® PL309, size S - XXL, 2 pockets, with zipper, white, PE-Spunbond non-woven.

DuPont de Nemours

Tyvek® garments are composed of flash spun high density polyethylene, providing an ideal balance of protection, durability and comfort.

Tyvek® is permeable to both air and water vapour, yet repels water-based liquids and aerosols. It offers an excellent barrier against fine particles and fibres (down to 1 micron in size), is ultra-low-linting and antistatically treated. Silicon non-added.



Size	PK	Cat. No.
S	50	9.390 049
M	50	9.390 050
L	50	9.390 051
XL	50	9.390 052
XXL	50	9.390 053



1 LLG-Working and Chemical Protective Apron Guttasyn®, PVC/PE

Made from PVC with reverse side made of PE. Material thickness: 0.5mm. Side and neck ribbons made of woven plastic fabric and securely attached to the apron with welded PVC eyelets. Easy to clean, hygienic and dirt-repellent PVC surface. Liquids will not be absorbed but drain off the surface. Machine wash at 60 °C. Colour: white. Acc. to 89/686/EWG (Cat. III), EN 467 and EN 14605:2005.

Width mm	Length mm	PK	Cat. No.
800	1000	1	9.414 415
800	1200	1	9.414 417
1000	1200	1	9.414 419



2 Cryogenic Apron T-Cryo Light

Waterproof. Suitable for all laboratory applications using liquid nitrogen or other cryogenic gases. Made of a special, extra durable and coated composite fabric. Tested in contact with liquid nitrogen (-195.82 °C) for one minute and with subsequent flexibility test (RCT method). With adjustable clip closures. According to normative EN 511, EN 388, **CAT. III**

Width mm	Length mm	PK	Cat. No.
700	900	1	6.283 413
700	1100	1	4.668 440
700	1200	1	4.668 441
700	1350	1	4.668 442



3 Cryogenic Apron Cryo Apron®

The Cryo-Apron® provides a high-level of thermal protection to the operator's torso and upper legs against cryogenic splashes and ultra-cold vapour in harsh cryogenic atmospheres, typically whilst transferring cryogenics (in a range of minus 160°C). With adjustable straps at neck and waist. Also useable in cleanroom environments. According to normative EN 511, EN 420, EN 388, **CAT. III**

Width mm	Length mm	PK	Cat. No.
610	1070	1	6.228 898
610	1210	1	6.227 849

1 LLG-Disposable Protective Suits, PP

White PP non-woven 30 g/m², with hood and zipper, elastic band on the hood and on the wrists and ankles, latex-free

1



Size	PK	Cat. No.
L	10	6.282 791
XL	10	6.282 792
XXL	10	6.282 793

2 LLG-Overall tritex® pro White, Type 5/6, PP

Particle-tight, and to a limited extent, spray-tight chemical protective clothing.

The coverall made of 3-layer SMS material (spunbond-meltblown-spunbond) is robust and breathable. A meltblown filter membrane is embedded between two durable outer layers. Comfortable to wear, this coverall is a pleasant, protective companion in many work areas. Special features are the hood, the zipper cover strip, the back rubber element, and the arm and leg rubber elements.

- antistatic
- lint-free
- abrasion resistant
- breathable

Cat. III/CE 0624/Type 5/6

Coverall individually packed!

2



Size	PK	Cat. No.
M	5	6.266 640
L	5	6.266 641
XL	5	6.266 642
XXL	5	6.266 643
XXXL	5	6.266 644



1

1 Disposable Overall AlphaTec® 2000 STANDARD

AlphaTec® 2000 is designed to allow water vapour (perspiration) to escape from the suit yet will withstand saturation of liquid chemicals and filter 100% of particulates down to 0.01 microns in size*

Ansell

The use of a high quality two-way stretch microporous film provides an effective liquid and particle barrier combined with a high water vapour transmission rate from inside to outside.

- Excellent liquid penetration resistance and barrier to fine particulates
- Moisture vapour permeable ("breathable") to help reduce the risk of heat stress
- Silicone free
- Low linting
- Optimised body fit
- Anti-static - Tested according to EN 1149-5

*EMSL test method

Size	PK	Cat. No.
S	40	4.661 347
M	40	4.661 348
L	40	4.661 349
XL	40	4.661 350
2XL	40	4.661 351
3XL	40	4.661 352
4XL	40	4.661 353
5XL	40	4.661 354

2

2 Disposable Chemical Protection Coverall Tyvek® 500 Xpert, Type 5/6

DuPont™ Tyvek® 500 Xpert, model CHF5. Hooded coverall available in white, in sizes S to XXXL. Robust yet lightweight (<180g per garment). 3-piece hood for optimal fit to head and face when turning. Elasticated face, wrists and ankles as well as glued-in waist elastic. Wide crotch area for freedom of movement. Large, easy-to-grasp zipper puller.

DuPont de Nemours

Tyvek® garments are composed of flash spun, high density polyethylene, providing an ideal balance of protection, durability and comfort. Tyvek® is permeable to both air and water vapour, yet repels water-based liquids and aerosols. It offers an excellent barrier against fine particles and fibres (down to 1 micron in size), is ultra-low-linting and antistatically treated. Silicon non-added.

Applications for Tyvek® Classic Xpert garments include those found in pharmaceutical handling, chemical processing, the oil and gas industry, general maintenance and operations and many others.

- Chemical protective clothing, Category III, Type 5-B and 6-B
- EN 14126 (barrier to infective agents), EN 1073-2 (protection against radioactive contamination)
- Antistatic treatment (EN 1149-5) - on both sides
- Stitched external seams featuring patent-pending technology for enhanced liquid spray tightness
- Very low inward leakage thanks to optimised design
- Tyvek® auto-lock zipper and zipper flap for increased protection

Size	PK	Cat. No.
S	1	9.390 055
M	1	9.390 056
L	1	9.390 057
XL	1	9.390 058
XXL	1	9.390 059
XXXL	1	9.390 054

3

3 LLG-Disposable Bouffant Caps, PP

PP nonwoven 10 g/m², universal fit Ø 52 cm, with all-around elastic, latex-free

Colour	PK	Cat. No.
green	100	6.282 788
white	100	6.282 789
blue	100	6.282 790

1 Clip hood

- non-woven fabric
- soft quality with double-sheathed cotton elastic band
- gathered
- food-safe
- Packaging 10 x 100 pieces

Unigloves

Colour	Size	Diam. mm	PK	Cat. No.
white	medium	520	1000	4.665 805
blue	medium	520	1000	6.286 653



2 Protective Hood Tyvek® 500, PH30L

Protective hood DuPont™ Tyvek® 500, PH30LO, white, PE-Spunbond nonwoven.

DuPont de Nemours

Colour	PK	Cat. No.
white	100	9.390 013



3 Beard masks

- non-woven fabric
- non-irritating elastic bands
- food-safe
- 100 pieces per package
- 1.000 pieces per shipping unit

Unigloves

Description	Colour	PK	Cat. No.
Beard covers	white	1000	6.229 401



4 Beard Mask, White, PP, Detectable



This beard mask has a detectable strip on the inside. That's why it can be detected by a detector machine at any time—even if the beard mask gets into the production.

- air-permeable and breathable
- ideal for special hygienic-sensitive areas

Description	Colour	PK	Cat. No.
Beard mask, detectable	white	100	6.260 903



5 LLG-Disposable Protective Sleeves, PE

PE film with elastic, latex-free, length 40 cm

Colour	Thickness µm	PK	Cat. No.
blue	20	100	6.282 797
white	20	100	6.282 798
blue	40	100	6.282 799



6 Sleeve Guard Tyvek® 500

- 50 cm long sleeve, white and in one size.
- Adjustable arm opening.
- Stitched internal seams.
- Upper-arm in blue-coloured thread for identification purposes

DuPont de Nemours

Type	PK	Cat. No.
Sleeve guard Tyvek®, 50 cm	200	6.263 193



Protective clothing/Shoes

1



1 LLG-Disposable Shoe Covers, CPE

Blue embossed CPE film, 30 µm, with elastic, latex-free, universal size, length 41 cm

Type	PK	Cat. No.
LLG-Disposable Overshoes, CPE	100	6.282 795

2



2 LLG-Disposable Shoe Covers, PP, with CPE sole

White PP non-woven, 38 g/m² with blue, non-slip sole CPE, 38 µm, with elastic, latex-free, universal size, length 40 cm

Type	PK	Cat. No.
LLG-Disposable Overshoes, CPE sole	50	6.282 794

3



3 Overshoe dispenser HYGOMAT COMFORT/CLEANROOM

- no electrical power needed
- easy to use, no need for bending over
- easy and quick handling
- with handrail for extra comfort
- capacity: two packs of overshoes
- with window for easy control of rest capacity
- refilled with overshoes within seconds
- weight: 21 kg

Description	PK	Cat. No.
Overshoes dispenser HYGOMAT COMFORT, 740 x 300 x 730 mm	1	6.257 283
Overshoes dispenser HYGOMAT CLEANROOM, stainless steel, 740 x 300 x 730 mm	1	6.269 779

4



4 5 Overshoes for dispenser HYGOMAT

6257285:

- Polypropylene nonwoven, CPE coated, white
- Waterproof sole
- Very slip resistant
- Perfect for smooth surface

6257286:

- PP overshoe with CPE sole, blue
- Polypropylene nonwoven
- At the top nonwoven, at the bottom strong waterproof CPE sole
- Very tearproof and slip resistant

6257287:

- CPE (Cast Polyethylene), blue
- Strong quality, approx. 60 micron
- Light protection against liquids

6257288:

- Polypropylene nonwoven, blue
- At the bottom structure made of CPE
- Permeable to air and light slip resistant
- For dry areas

Mensch

5



Length mm	PK	Cat. No.
440	80	6.257 285
440	70	6.257 286
470	110	6.257 287
460	100	6.257 288

2. Occupational safety, Security Identification of hazards/Safety signs-First-aid/Eye wash bottles

1 2 3 4 LLG-GHS Warning Labels, Self-Adhesive, Roll in Dispenser Box

Dispenser box of 250 labels. These labels are produced using an extremely resistant 100µm PE film. Due to their special surface coating they are resistant to most solvents and excellent for indoor or outdoor use. The strong adhesive, although permanent, can be removed from glass containers without leaving any trace.

Trilingual signal word: German, English, French.

Available in 2 sizes.

Type	Description	Label	Dimensions mm	PK	Cat. No.
GHS 01	warning	exploding bomb	26 x 37	250	9.105 700
GHS 01	danger	exploding bomb	26 x 37	250	9.105 701
GHS 02	warning	flame	26 x 37	250	9.105 702
GHS 02	danger	flame	26 x 37	250	9.105 703
GHS 03	warning	flame over circle	26 x 37	250	9.105 704
GHS 03	danger	flame over circle	26 x 37	250	9.105 705
GHS 04	warning	gas cylinder	26 x 37	250	9.105 706
GHS 05	warning	corrosive	26 x 37	250	9.105 707
GHS 05	danger	corrosive	26 x 37	250	9.105 708
GHS 06	danger	skull and crossbones	26 x 37	250	9.105 709
GHS 07	warning	exclamation mark	26 x 37	250	9.105 710
GHS 08	warning	health hazard	26 x 37	250	9.105 711
GHS 08	danger	health hazard	26 x 37	250	9.105 712
GHS 09	warning	environment	26 x 37	250	9.105 713
GHS 01	warning	exploding bomb	37 x 52	250	9.105 720
GHS 01	danger	exploding bomb	37 x 52	250	9.105 721
GHS 02	warning	flame	37 x 52	250	9.105 722
GHS 02	danger	flame	37 x 52	250	9.105 723
GHS 03	warning	flame over circle	37 x 52	250	9.105 724
GHS 03	danger	flame over circle	37 x 52	250	9.105 725
GHS 04	warning	gas cylinder	37 x 52	250	9.105 726
GHS 05	warning	corrosive	37 x 52	250	9.105 727
GHS 05	danger	corrosive	37 x 52	250	9.105 728
GHS 06	danger	skull and crossbones	37 x 52	250	9.105 729
GHS 07	warning	exclamation mark	37 x 52	250	9.105 730
GHS 08	warning	health hazard	37 x 52	250	9.105 731
GHS 08	danger	health hazard	37 x 52	250	9.105 732
GHS 09	warning	environment	37 x 52	250	9.105 733



5 LLG-Labels with "Biohazard" Symbol

Ø 9.5mm. Self-adhesive. Printing protected. For labeling of 0.5 to 2.0ml microtubes that contains potentially hazardous substances. The labels have excellent heat resistance, chemical resistance and UV resistance and a very good adhesion to various materials, even on rough or non-polar surfaces such as on plastics with low surface energy. The material is UL certified. (File MH26760).

1000 labels per roll, in dispensing box.

Description	PK	Cat. No.
"biohazard" symbol	1000	9.105 740



6 Eye-Wash Bottle, Barikos KS

Barikos KS and Mini Barikos KS are maintenance-free models of eye wash bottles. Containing water, they can be kept ready for use for at least two years in the sealed state. Both models are ideal for first aid boxes and sets. All above mentioned Barikos eyewash bottles comply with EN 15154-4. A protective cover clips onto the spray head of the eye wash bottle thus preventing any leakage. All bottles with sliding valve are suitable for use with upright and with the downward spray head.

- Filled eyewash bottle, ph-neutral eyewash on water basis without chemical additives
- Ergonomically shaped eye recess

Description	PK	Cat. No.
Barikos KS, 620ml, filled	1	9.005 009
Mini Barikos KS, 175ml, filled	1	9.005 008



Accessoires for Eye-Wash Bottle, Barikos

Description	PK	Cat. No.
Barikos K / KS wall unit for 1 eye wash bottle, plastic coated steel wire	1	9.005 015
Barikos K / KS wall unit for 2 eye wash bottles, plastic with transparent lid	1	9.005 017
Barikos K / KS wall unit for 1 eye wash bottle, plastic with transparent lid	1	6.076 057
Sticker "52 weeks" for eye wash bottle	10	6.053 310



First-aid/Eye wash bottles

1



9.733 794

2



6.240 397

Eye Wash Bottle, 0.9 % NaCl, Sterile

- choice of 0.2 litre (washing time approx. 2 minutes) or 0.5 litre (washing time approx. 5 minutes) bottles
- Duo wash bottle for both eyes 1000 ml (washing time approx. 5 minutes)
- Ergonomic eye cup - keeps the eyes open during application
- Saline solution (0.9 %), conforming to the natural salinity of the eye
- According to DIN EN 15154-4
- Shelf life: 3 years

B-SAFETY

Applications:

- Mobile application
- Transportation of dangerous goods acc. GGVS
- Emergency medication
- First-aid boxes
- Refill unit for eye wash emergency station
- NEW: eye wash bottle DUO for simultaneous washing of both eyes

Description	PK	Cat. No.
Eye wash bottle 0,9% NaCl, 200ml	1	9.733 794 1
Spare eyewash bottle, 0,9% NaCl, 500ml	1	9.733 793
Eye wash bottle DUO 0,9% NaCl, 1000ml	1	6.240 397 2

3



9.733 788

4



9.733 817

Eyewash Bottle pH-neutral

A small, handy bottle containing 4.9 % sterile phosphate buffer solution, that neutralises the eye's fluid after accidents involving acids and alkalies.

- shelf life: 3 years
- rinsing time: about 2 minutes
- according to DIN EN 15154-4

Applications:

- mobile application
- emergency medication
- First-aid boxes
- refill unit for eye wash emergency station
- NEW: eye wash bottle DUO for simultaneous washing of both eyes.

Description	PK	Cat. No.
Eyewash bottle, pH neutral, 200ml, single	1	9.733 788 3
Eyewash bottle pH neutral DUO, 500ml	1	9.733 817 4

5



5 Eye Wash Emergency Station DUO

B-SAFETY

For parallel treatment of both eyes. With one pH neutral DUO eye wash bottle with 500ml sterile phosphate buffer solution (4.9%) and one DUO eye wash bottle with 1000ml sterile sodium chloride solution (0.9%). With wall mounting, enclosed pictogram and mirror. Instructions included. Especially suitable for workplaces where chemicals and contaminants can penetrate the eye. Advice: Also after treatment with pH neutral solution continued flushing until medical treatment with sodium chloride solution is recommended. Shelf life: 3 years. According to DIN EN 15154-4:2009.

Description	PK	Cat. No.
Eye wash emergency station DUO	1	9.733 816
Eye wash bottle DUO, pH neutral , 500ml	1	9.733 817
Eye wash bottle sodium chloride solution DUO, 1000ml	1	6.240 397

Eyewash Emergency Station, Wall-Mounting

A dust-proof wall mounted station containing one bottle of 200 ml sterile phosphate buffer solution and one bottle of 500 ml sterile sodium chloride solution complete with instructions and a mirror or eye wash emergency station DUO with one bottle of 500 ml sterile phosphate buffer solution and one bottle of 1000 ml sterile sodium chloride solution. Especially suitable for workplaces where on the spot rinsing is required, smaller workplaces. Bottles according to DIN EN 15154-4.

B-SAFETY

1



9.733 787

Dimensions eye wash station (W x D x H): 227 x 110 x 265mm
 Dimensions eye wash station DUO (W x D x H): 250 x 115 x 355mm
 Durability: 3 years
 Flush time: about 7 minutes

Description	PK	Cat. No.
Eyewash emergency station, wall-mounting	1	9.733 787 1
Eyewash emergency station DUO, for both eyes, wall-mounting	1	6.253 311
Eyewash bottle, pH-neutral, 200ml	1	9.733 788
Eyewash bottle DUO, pH neutral, 500ml	1	9.733 817
Eyewash bottle, 0,9% NaCl, 500ml	1	9.733 793
Eyewash bottle DUO, 0,9% NaCl, 1000ml	1	6.240 397

2 Mini Eyewash Station Eyes Fresh

Ideal for the lab, filling stations or all work places where aggressive substances are used. "Eyes Fresh" can be attached to any standard cold water tap. For normal use of the tap, just press the button and the function changes back from the eye wash (returns automatically to eyewash-function when the tap is closed). Can be fitted onto taps with M22x1, 1/2" or 3/8" outer thread.

Bürkle

2



Description	PK	Cat. No.
Mini eyewash station EyesFresh	1	6.076 887

Hand-Held Drench Hoses

Two sprays in one. The hose can be used as a fixed eyewash when fitted into the mount. This allows the injured person to use both hands to hold open the eyes. The hose can also be removed from the mount so that other body parts and reclining patients can be treated.

B-SAFETY

3

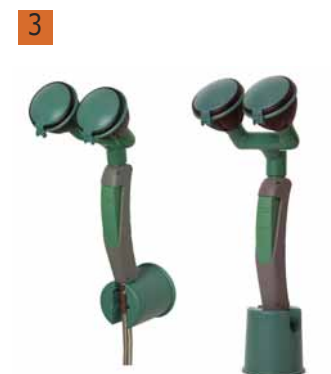

9.733 779

- For wall and table mounting
- Wall-/ table mount included
- according to DIN 1988 und DIN EN 1717
- according to DIN EN 15154-2:2006 and ANSI Z358.1-2014
- DIN-DVGW tested and certificated
- DIN certification label included
- The spray heads ensure a wide distribution of water so that areas around the eyes are also covered and the exact positioning of the eyes is therefore not critical
- Large holes in the spray heads protect against limescale. The spray heads can be removed for cleaning purposes
- Rubber shrouds on the nozzles help prevent accidental injury
- Self-closing valve with squeeze lever operation
- Lightweight dust caps fall off automatically on operation
- Integral jet regulator keeps the water jet constant independent of the water pressure
- Built-in non-return valve prevents any backflow of contaminated water

Spray height: 250mm
 Hose length: 1500mm
 Connection: 1/2" swivel nut
 Water output: 7 litres/min per spray head, regulated
 Inlet fitting: M 28 x 80mm.

4



9.733 786

Description	Connection	PK	Cat. No.
1 spray head, 45° angle	1/2" female	1	9.733 778
2 spray heads, 45° angle	1/2" female	1	9.733 779 3
1 spray head, vertical	1/2" female	1	9.733 786 4

1 Safety Eye Showers

- With two high performance spray heads
- Dust caps, which open automatically on operation, protect against dirt inside the spray heads
- Rubber sleeves protect the person seeking help against further injuries
- Table and wall mounting bracket
- Stainless steel covered hose 1500 mm
- Flow rate: 7 liter/minute/spray head
- Integrated flow regulation which guarantees uniform jet of water independent from water pressure
- According to ANSI Z358.1-2014 and DIN EN 15154-2:2006
- DIN-DVGW tested and certified

B-SAFETY

Description	Connection	Attachment	PK	Cat. No.
with two spray heads 45°	½" female	Table mounted	1	6.254 947 2
with two spray heads 45°	½" female	Wall mounted	1	9.733 819 3
stainless steel bowl	¾" female	Wall mounted, exposed pipework	1	7.653 251 4



6.254 947



9.733 819



7.653 251

5



9.733 810

Body Showers/Emergency Showers

Special showering heads ensure that large water quantities in gentle streams reaches the injured person without damaged the injured skin.

B-SAFETY

- The showers meet EN 15154-1:2006
- DIN-DVGW tested and certified
- Marked sign according to DIN is included
- Large dimensioned maintenance-free ball tap for large throughput quantities
- Throughput quantity: approx. 60 litres/min.
- Simple assembly
- Stable structure
- Chemical-resistant PE powder painting
- High speed showering heads made from plastic, with improved spray pattern. Corrosion resistant, calcify- and maintenance free, very durable, even emptying.
- Large, easy-to-use release bar
- Comes with all mounting materials
- Connection ¾"

Inlet	Length	Attachment	PK	Cat. No.
	mm			
Surface mount	625	Wall flange	1	9.733 810 5
Concealed mount	625	Wall/60 mm - ¾" pipe	1	9.733 811
Surface mount	565	Over door wall flange	1	9.733 812

6



6 Safety Shower Test Cart, Tank Capacity 30 litres, Mobile

With the safety shower test cart you can keep the monthly required functional test simple and easy.

B-SAFETY

- mobile collecting tray equipped with 4 roles made of black plastics
- two integrated grip recesses
- one drain screw
- funnel made of black plastics, diameter 440 mm, height 160 mm
- total height 2100 mm
- pipe material aluminium 47 mm, pluggable
- tank capacity 30 litre
- total weight 7 kg
- detachable in 3 parts for simple storage

Description	PK	Cat. No.
Safety shower test cart	1	7.656 739

Plaster Dispenser aluderm®-aluplast

Plaster dispenser with wall mounting. Can be used mobile or stationary. 115 individual aluderm®-aluplast plasters of various sizes and shapes, each individually sealed, and a mini block of emergency medical care verification are available.
Content: 115 elastic, aluminum-coated wound plasters for adults:

- 30 strips about 1.9 x 7.2 cm
- 30 strips about 2.5 x 7.2 cm
- 25 fingertip bandages
- 20 finger bandages approx. 12 x 2 cm
- 10 finger joint bandages

- Dimensions: approx. 160 x 122 x 57 mm
- Color orange
- Material: ABS plastic

Söhngen



9.264 146



9.264 147

Description	PK	Cat. No.
Plaster Dispenser aluderm®-aluplast, filled with 115 plasters	1	9.264 146 1
Refill pack, complete for aluderm®-aluplast, with 115 plasters	1	9.264 147 2

Plaster Dispenser QuickFix

Pull and you immediately have a plaster ready for use. Each plaster is individually packed. This provides great hygienic safety. Ready for use at critical workplaces. The plasters are made of protective, PE material that allows the skin to breathe and are especially suitable for damp workplaces. The QuickFix dispenser is only 23cm wide and 13.5cm high. It contains 90 plasters in spite of its modest size so it can be installed precisely in those places where the need is greatest. Refilling of the dispenser is also possible with other types of the QuickFix range.

B-SAFETY

QuickFix Elastic Long Refill, 30-parts finger dressing
Elastic plasters, conforming to the movements of the skin and therefore very comfortable to wear. The plasters allow the skin to breathe.
- Solves most accidents quickly, easily and hygienically



9.733 808



9.733 825

Description	PK	Cat. No.
QuickFix plaster dispenser including two water-resistant plaster refills	1	9.733 808 3
QuickFix plaster dispenser including two finger dressing refills	1	4.661 250
QuickFix water resistant plaster refill containing 45 plasters	1	9.733 809
QuickFix 30-parts finger dressing	1	9.733 825 4

5 First Aid Case EUROPA

The cases are labelled in the following languages:
- German - English - Portuguese - Spanish - French - Dutch - Italian - Czech - Polish - Hungarian - Slovenian - Finnish - Danish - Slovak.
The instructions and lists of contents are also available in all the languages listed above.
ABS thermoplastic, orange, wall bracket with 90° lock for horizontal positioning

Söhngen



EUROPA I
- Contents: accordance with German standard DIN 13157
- Dimensions: 310 x 210 x 130 mm

EUROPA II
- Contents: accordance with German standard DIN 13169
- Dimensions: 400 x 300 x 130 mm

Type	PK	Cat. No.
EUROPA I	1	6.286 491
EUROPA II	1	6.286 492

2. Occupational safety, Security

First-aid/Dressings/plasters-Waste disposal/Waste, Disposal bags

1



1 First Aid Kit Special for Laboratories and Chemistry

Basic contents to DIN 13157. Additionally includes industrial risk equipment for laboratories and chemistry, medical, technical and chemical research institutes and laboratories. With wall bracket, handle and turn-lock fasteners. Sealing tag provided. With screen-printed label with text in German.

Söhngen

- Dimensions: approx. 400 x 300 x 150 mm
- Colour orange
- Material: ABS plastic
- Wall bracket with 90 ° stop lock
- Suitcase sealable
- Marking with pictograms and screen printing labelling

Type	PK	Cat. No.
Laboratory and Chemistry	1	9.264 163

2



2 Holder for Waste Sacks

Warning: Never place sharp objects such as hypodermic needles, etc., in plastic bags! Always steam-sterilize bags unsealed.
Injury hazard!

- White
- Steel wire
- Epoxy resin coating
- With rubber feet

Description	Int. diam. mm	Height mm	PK	Cat. No.
Stand with 100 disposal bags of PP	120	250	1	9.404 030
Stand with 50 disposal bags of PA	120	250	1	6.310 692
Stand	120	250	1	7.060 716

3



3 LLG-Autoclavable bags, PP

Constructed from very strong PP film with a broad seam at the bottom. For the disposal of contaminated labware. When autoclaving, the neck of the bag must be left open. Film thickness: 50 µm.

Description	Width mm	Length mm	Capacity L	auto-clavable at °C	Package contents	PK	Cat. No.
standard	200	300	1.5	134 °C	Dispenser box of 100 bags	100	9.404 099
standard	300	500	6.0	134 °C	Box of 500 bags	500	9.404 220
standard	400	780	22.0	134 °C	Box of 250 bags	250	9.404 221
standard	500	780	25.0	134 °C	Box of 250 bags	250	9.404 222
standard	600	800	32.0	134 °C	Box of 250 bags	250	9.404 223
standard	600	780	32.0	134 °C	Box of 100 bags	100	9.404 103
standard	700	1100	72.0	134 °C	Box of 250 bags	250	9.404 224
standard	700	1100	72.0	134 °C	Box of 75 bags	75	9.404 105
highly transparent	200	300	1.5	121 °C	Dispenser box of 100 bags	100	9.404 020
highly transparent	300	500	6.0	121 °C	Box of 500 bags	500	9.404 100
highly transparent	400	780	22.0	121 °C	Box of 500 bags	500	9.404 101
highly transparent	600	800	32.0	121 °C	Box of 500 bags	500	9.404 102
highly transparent	700	1100	72.0	121 °C	Box of 350 bags	350	9.404 104

4



4 5 LLG-Autoclavable Bags, PP, with Biohazard printing



Autoclavable bags imprinted with biohazard labelling. Made of polypropylene. Strong side seams for securely holding items. Front write-on panel. Autoclavable.

5



Width mm	Length mm	Capacity L	Colour	Description	auto-clavable at °C	Thickness µm	PK	Cat. No.
310	660	12	transparent		121	45	50	9.404 050
415	600	14	transparent		121	45	50	9.404 051
610	810	35	transparent		121	45	50	9.404 052
500	600	20	red	with sterilisation indicator	134	50	200	6.285 813
630	890	40	red	with sterilisation indicator	134	50	200	6.285 814
910	1150	80	red	with sterilisation indicator	134	50	100	6.285 815

1 Biohazard Disposal Bags, PP, Red, 38 µm



Bel-Art Products

Red. With pre-printed sterilization indicator patch, which darkens when bag is autoclaved.

- ASTM 1709 and ASTM 1922
- Can be autoclaved at 135°C
- Print: standard biohazard warning symbol
- Precautionary protocols in four languages: English, French, German and Spanish

Width mm	Length mm	Thickness µm	PK	Cat. No.
360	480	38	200	6.240 465
480	580	38	200	9.404 010
640	890	38	200	6.301 637
790	970	38	200	6.253 096
970	1220	38	100	9.404 011



2 Biohazard Disposal Bags, Super Strength, PP, 50 µm



Bel-Art Products

Red-orange. With pre-printed sterilization indicator patch, which darkens when bag is autoclaved.

- Maximum protection against dangerous tears and leaks
- Material: blended polymer
- ASTM 1709 and ASTM 1922
- Autoclavable at 135 °C
- Print: standard biohazard warning symbol
- Precautionary procedures in four languages: English, French, German and Spanish

Width mm	Length mm	Thickness µm	PK	Cat. No.
360	480	50	200	9.404 012
480	580	50	200	9.404 013
640	890	50	200	6.253 092
790	960	50	200	6.253 093
940	1220	50	100	9.404 014



3 Benchtop holder and biohazard bags set



Bel-Art Products

The set includes bench top holder and 100 red bench top biohazard bags (HDPE). For collecting pipette tips and microcentrifuge tubes.

- Rectangular steel wire frame for polyethylene bags (22 x 28 cm, 0.018 mm thickness)
- Coated in easy to clean, orange color epoxy
- Snug fitting polypropylene plastic cover
- Autoclavable

Description	PK	Cat. No.
Benchtop holder and biohazard bags set	1	6.280 859
Biohazard bags	100	9.404 070



4 Stand for safety pouch Poxygrid®



Bel-Art Products

The bright orange, epoxy-coated steel wire stand provides a stable support to keep the safety pouch upright and open for easy access. This hard to pierce pouch offers protection against the danger of being cut by contaminated sharp objects. After filling, the top flaps close and lock in place for safe disposal.

- Solid oval paperboard pouch
- Printed with bold biohazard symbol

Type	Dimensions mm	PK	Cat. No.
Stand for safety pouch	100 x 130 x 200	1	4.675 024
Paperboard pouch	140 x 330	200	6.250 052





1 Waste Bags, HDPE



HDPE. With adhesive strips. Can be fixed anywhere, e.g. walls and tables etc. Without holder. Carrying weight approx. 1.36 kg.

- ASTM 1709 and ASTM 1922
- Autoclavable (121 °C)

Width mm	Length mm	PK	Cat. No.
203	254	50	9.404 065
305	406	50	9.404 066



2 Bench-top stand for waste disposal bags

Plastic coated iron. With non-slip rubber feet.

Ratiolab

Description	Int. diam. mm	Height mm	PK	Cat. No.
For waste disposal bags (200 x 300 mm)	150	250	1	6.230 832
For waste disposal bags (300 x 500 mm)		350	1	6.312 243



3 Quick-Lock Ties

Red. Polyethylene, round, can be reopened. Further colours available on request.

Württ. Allplastik

Diam. mm	Length mm	PK	Cat. No.
3.5	120	1000	9.404 182
3.5	180	1000	9.404 184
3.9	240	1000	9.404 186
4.4	320	1000	6.235 096

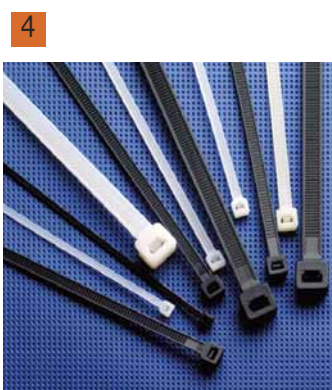

4 Cable Ties

Nylon, flat, single use - cannot be reopened

Württ. Allplastik

Colour	Width mm	Length mm	PK	Cat. No.
Natural	2.2	75	1000	9.404 301
Natural	2.5	98	1000	9.404 303
Natural	2.5	135	1000	9.404 305
Natural	2.6	160	100	6.311 824
Natural	2.6	200	1000	9.404 307
Natural	3.5	140	1000	9.404 309
Natural	3.5	200	1000	9.404 314
Natural	3.5	290	500	9.404 310
Natural	4.5	160	1000	9.404 311
Natural	4.8	250	100	9.404 316
Natural	7.8	300	100	9.404 326

Needles and waste containers Medibox®

Sharps disposal containers complying with EN ISO 23907

B. Braun Deutschland

- No-touch, twist-off and insertion inlets
- For all kinds of used luer and luer-lock needles as well as pen needles
- Large opening to ease the insertion of various medical sharps
- Irreversible final lock mechanism
- Easy to use temporary closure
- Overfill warning by maximum fill line

Volume litres	Filling volume L	Dimensions (W x D x H) mm	PK	Cat. No.
0,8	0,67	98 x 98 x 180	1	6.315 045 1
2,4	2,0	151 x 151 x 200	1	4.661 837 2
4,7	3,9	190 x 190 x 200	1	4.661 838 3
5,7	4,8	190 x 190 x 257	1	4.661 839 4

1



6.315 045

2



4.661 837

3



4.661 838

4



4.661 839

5 6 Disposal Container SHARPSAFE®, PP



Sharpsafe® offers a convenient range of disposal containers and accessories that meet high requirements of hygiene and safety. The disposal of waste at its source is thus very convenient and easy.

- Container consists of 2 parts: yellow base with semi-transparent cover, safe and quick installation by simply pressing and hearing 4 clearly audible "clicks"
- The Sharpsafe® 0.6 l is a pocket container and is already pre-assembled
- The Sharpsafe® 9 l is also available with a height of 498 mm for the disposal of long items such as serological pipettes
- Equipped with a carrying handle
- Secure one-hand use possible with different mounting accessories
- Wide opening for the disposal of large objects
- Disconnection for all types of needles (2 l to 7 l), insulin pens (2 l to 7 l) and scalpel blades (2 l to 9 l)
- Opening with integrated safety flap for additional protection (2 l to 7 l)
- The closure cap can be locked in the open position if required
- 2 locking positions: provisional and final, open simply by pressing the tab
- Maximum filling level clearly visible by a black line on the lid
- Safety distance between the container opening and the clear marking line of maximum filling level
- Inscription on a label fused into the container, label will not be removed by moisture or autoclaving
- Information on the label in different languages (see table)
- The empty and open container is autoclavable up to 134 °C for 18 minutes
- Sharpsafe® is conform to ADR, TRBA 250, ISO 23907: 2013, NFX30-500 and owner of the label NF302
- Country of origin: European Union

5



6



Type	Capacity ml	Dimensions (W x D x H) mm	Dimensions large opening mm	Labeling	PK	Cat. No.
0,6 L	580	108 x 52 x 224	40 x 30	FR/NL	1	9.264 210
1,0 L	1000	108 x 90 x 187	58 x 36	DE/FR/IT/ES/EN	1	9.264 211
2,0 L	2000	195 x 20 x 178	55 x 50*	DE/FR/IT/ES/EN	1	9.264 212
3,0 L	2600	197 x 120 x 205	55 x 50*	DE/FR/IT/ES/EN	1	9.264 213
4,0 L	4000	175 x 175 x 245	55 x 50*	DE/FR/IT/ES/EN	1	9.264 214
7,0 L	6700	175 x 175 x 380	55 x 50*	DE/FR/IT/ES/EN	1	9.264 215
9,0 L	9000	292 x 195 x 291	210 x 60	FR/NL	1	9.264 216
9,0 L h	8200	175 x 175 x 498	55 x 77	FR/NL	1	9.264 217

* Picture cover



1 2 Disposal Cartons for Broken Glass

Bel-Art Products



- Safe puncture resistant receptacles for broken glassware
- Reduces chances for accidents
- Clearly labeled, dedicated containers available in 2 sizes: floor model: 18kg of waste; bench top: 5.5kg
- Lined with a 50 micron, clear polyethylene bag to store
- Printed in four languages: English, German, French, Spanish

Reusable cover for floor model:

Reusable safety cover for glass disposal carton. Dishwasher-safe and autoclave-safe. The Disposal Carton Cover opens quickly and easily by pressing the built-in release tab. Please do not dispose but reuse for the next glass disposal carton.

Description	Dimensions (W x D x H) mm	PK	Cat. No.
Disposal cartons for broken glass, floor model	300 x 300 x 690	6	6.236 025
Disposal cartons for broken glass, benchtop	200 x 200 x 250	6	9.264 190
Cover for glass disposal cartons with 300 x 300 mm opening	-	1	9.264 191

LLG-Absorbent, oil and chemical binder, granules

Universal chemical and oil binder for all liquids, also for solvents. Very high absorption capacity (up to 1:75 of aqueous solutions). Almost dust-free granules with colour indicator: colour changes to yellow in contact with acids, to red in contact with alkalis. Disposal according to the pollutant recorded.

Capacity kg	Package	PK	Cat. No.
0.7	Laboratory bottle	1	6.283 036 3
1.5	Square handle bottle	1	6.283 037 4
5.0	Bucket	1	6.270 479 5

3

6.283 036

4

6.283 037

5

6.270 479

6

6 Absorbent, oil and chemical binder FastSorb 4.0

LABORGERÄTESÜD

FastSorb 4.0 is a spreadable absorbent agent for a rapid binding of hazardous liquids. This quick binder should be used on all places of operation where dangerous leaks are possible.

- Tested by TÜV Rheinland according to the BAM test method
- Occupational health and environmental safe absorbent

Optional wall mount with shovel and hand brush available.



Description	PK	Cat. No.
1500 g Quick binder for mineral oil and chemicals	1	4.664 658
50 L Quick binder for mineral oil and chemicals	1	4.664 659
Wall bracket incl. Handbrush, with rubber bristles, shovel, plastic bag and mounting kit, without FastSorb 4.0	1	4.664 660

2. Occupational safety, Security Waste disposal/Waste bins-Chemical Sorbents

1 Mercury collector

Bürkle's mercury collector enables the easy collection of spilt mercury, which can then be used again. The mercury collector is composed of a PE tub. Within the screw cap lid there is a special plastic foam insert. On pressing this foam gently on the spilt mercury, the foam's pores are opened and the mercury globules are absorbed. When raised, the foam's pores are sealed again, thus keeping hold of the mercury. The cap is then screwed on the tub, the globules are released again and fall through the perforated separation into the tub.

Bürkle

1



Description	PK	Cat. No.
Mercury collector	1	7.300 223
Replacement foam insert	1	7.300 224

Chemical Sorbents

The sorbents have a high performance. Due to their new microfibre structure, they provide very high absorbing capacities. The light and absorbent material is easy to use and committed to absorb quickly and store the liquid. The absorbed liquid can be extracted, to be used again or to be disposed of separately. The optimal combination of features such as light weight, low volume, very high absorbance, easy handling and low sorbent disposal weight significantly reduces disposal costs in comparison to conventional binding materials. To reduce the final waste content, the used sorbets can be burnt.

3M Deutschland

Can be used to absorb a variety of lab chemicals:

- acids, such as acetic acid, hydrofluoric acid, phosphoric acid, nitric acid, hydrochloric acid, sulphuric acid
- alkalis, such as sodium hydroxide, potassium hydroxide
- hydrazine: N₂H₄
- hydrogen peroxide

Type	Description	Dimensions (W x D)	Absorption*	PK	Cat. No.
PF 2001	Multi-Format	15.2m x 12cm	39 l	1	9.264 101 2
P 110	Wipes	33cm x 28cm	0.25 l	50	9.264 102 3
P 300	Pillows	28cm x 18cm	2 l	16	9.264 103 4

*Capacity per piece

2



9.264 101

3



9.264 102

4



9.264 103

5 Chemical Sorbents Emergency Kits

Each kit has the optimal combination of different sorbents. Ready to use. Quick and safe aid for accidental spillages of almost all hazardous liquids.

3M Deutschland

Type	Size	Absorption*	Capacity	PK	Cat. No.
SK5	7 x 40 x 28 cm	approx. 5	10 wipes, 1 pillow, 1 waste bag	1	9.264 104

5



1

1 Safety Box

Kartell

PC. Completely autoclavable. Used to carry tubes and containers under safe conditions. With silicone gasket and 4 sidelocks. Provided with a stainless steel handle and user sheet with instructions approved by WHO. With bio-hazard symbol printed on the box.

Description	Width mm	Depth mm	Height mm	PK	Cat. No.
Safety box	175	391	190	1	9.301 567
Safety box rack				1	9.301 568
Set 4 sidelocks				4	6.235 082
silicone gasket				1	9.301 569

2

2 Portable Desiccator DURAPorter™, PC

Heathrow Scientific

Ideal for transporting biological and clinical samples, as well as instruments and products that you want to keep clean and dry under testing environmental conditions. Are light weight and easy to carry; they are ideal for moving samples that must be protected from humidity, dust and other environmental influence. The clarity of the DURAPorter™ enables the user to visibly check sample integrity, so that it can be opened using the right precautions.

- Polycarbonate construction are available in three colours for use/owner identification
- Silicone water-tight seal and three lid clasps provide secure closure
- Carry handle folds neatly into body space allowing the units to be stacked
- Lid opens a full 180°, allowing total access to contents and making it easier to clean
- Will accommodate 13 and 16 mm tubes in a 72-place one rack®, or similar sized/brand of rack
- Use the separators provided to create your own compartment sizes, or use empty to transport larger products and equipment
- Autoclavable

Matching rack (e.g. Cat. No. 9193 997, 9193 998) please order separately. Further colours available on request.

Type	Colour	Dimensions (l x w x h) mm	Material	PK	Cat. No.
DURAPorter™	Clear with blue handles	380 x 196 x 160	PC	1	9.194 005
DURAPorter™	Yellow with yellow handles	380 x 196 x 160	PC	1	9.194 006
DURAPorter™	Red with red handles	380 x 196 x 160	PC	1	9.194 007



Safety Funnels with Hinged Lid, HDPE

This compact funnel with lid is optimally suited for restricted space conditions in the laboratory. The hinged lid closes the funnel clean and safely. The removable sieve collects magnetic stirrers and solid substances during fluid discharge.

- Chemically resistant HDPE
- With removable sieve for easy cleaning
- Funnel diameter: 130 mm
- Different thread sizes with free rotatable cap
- Safety lance ensures clean outflow without contaminating the container opening. Lance length: 200 mm
- Also available without safety lance
- Chromatography vials can be disposed completely when the sieve is removed.
- Black Safety funnels are made of electrostatic conductive HDPE and have a grounding connection to avoid ignition risks. Grounding cable (1.5 m) and grounding clamp are included.

Further thread sizes available on request.

1 Safety Funnels with Hinged Lid, White, HDPE

S.C.A.T.

Description	Thread	PK	Cat. No.
Funnel with safety lance	GL45	1	6.248 077
Funnel without safety lance	GL45	1	6.241 723
Funnel with safety lance	S50	1	9.042 881
Funnel without safety lance	S50	1	9.042 882
Funnel with safety lance	S51	1	9.042 871
Funnel without safety lance	S51	1	9.042 872
Funnel with safety lance	S55	1	7.655 618
Funnel without safety lance	S55	1	9.042 873
Funnel with safety lance	S60/61	1	6.242 856
Funnel without safety lance	S60/61	1	6.242 855
Funnel with safety lance	S65	1	6.241 661
Funnel without safety lance	S65	1	9.042 874
Replacement sieve, PE-HD, for funnel with hinged lid		1	9.042 875



Safety Funnels with Hinged Lid, Black, HDPE, Electrostatic Conductive

S.C.A.T.

Description	Diam.	Thread	PK	Cat. No.
Funnel without Safety lance	130	GL45	1	9.042 862
Funnel with Safety lance	130	S55	1	9.042 864
Funnel without Safety lance	130	S55	1	9.042 861
Funnel with Safety lance	130	S60/61	1	7.626 422
Funnel without Safety lance	130	S60/61	1	9.042 860
Funnel with Safety lance	130	S65	1	9.042 866
Funnel without Safety lance	130	S65	1	9.042 863
Funnel without Safety lance	130	R2" BSP/G2" + 2" Tri-Sure	1	9.042 880
Funnel, without Safety lance	180	GL45	1	4.653 858
Funnel, without Safety lance	180	S60/61	1	6.261 363
Replacement sieve for funnels with lid	130		1	9.042 867
Replacement sieve for funnels with lid	180		1	9.042 850



7.626 422



9.042 860

Safety Funnels with Ball Valve, HDPE

The Safety funnel with ball valve closes automatically after the disposal of the liquid. The removable sieve collects magnetic stirrers and solid substances during fluid discharge.

- Chemically resistant HDPE
- With removable sieve for easy cleaning
- Funnel diameter: 180 mm
- Different thread sizes with free rotatable cap
- Splash protection for safe discharge without splashes
- Safety lance ensures clean outflow without contaminating the container opening, lance length: 200 mm
- Black Safety funnels are made of electrostatic conductive HDPE and are supplied with a grounding wire.

1



1 Safety Funnels with Ball Valve, White, HDPE

S.C.A.T.

Description	Thread	PK	Cat. No.
Funnel with safety lance	GL45	1	6.248 078
Funnel with safety lance	S50	1	9.042 876
Funnel with safety lance	S51	1	6.252 181
Funnel with safety lance	S55	1	9.042 869
Funnel with safety lance	S60/61	1	9.042 868
Replacement sieve, PE-HD for ball valve funnels		1	6.241 673

2



2 Safety Funnel with Level Control

S.C.A.T.

- Electrostatic conductive HDPE
- 9.75 litres throughput per minute
- Level Control with 1.5 litres filling buffer when using a 10 litre container
- S 60 thread with freely rotatable closure
- Drip edge prevents from fluid deposition at the closure
- Grounding cable and clamp included
- 1.5 litre reservoir clearance from movement of the level control
- Removable sieve for easy cleaning
- Space saving construction, suitable for every safety cabinet
- Dimensions (W x D x H): 140 x 150 x 200 mm

Type	PK	Cat. No.
Safety Funnel with Level Control	1	6.286 921

3



3 Waste Disposal Unit Standard, HDPE

S.C.A.T.

Disposal unit for liquid waste, HDPE, useful for the collection of solvent and sample waste. With funnel, hinged lid and removable sieve to collect magnetic stirrers and residues. The sieve is detachable for cleaning. Delivered with container and funnel, ready to use.

Capacity	Dimensions (W x D x H)	PK	Cat. No.
L	mm		
2.5	115 x 150 x 305	1	9.139 892
5.0	150 x 195 x 345	1	9.139 893
10.0	190 x 230 x 395	1	9.139 894

1 Disposal Unit with Safety Funnel, HDPE, Electrostatic Conductive

1
S.C.A.T.

This set contains a safety funnel with ball valve and a container both made of electrostatic conductive HDPE to prevent ignition risks. The Safety funnel with ball valve closes automatically after the disposal of the liquid. The built-in level control floater gives a warning in time to prevent overfilling of the container. The removable sieve collects magnetic stirrers and solid substances during fluid discharge.

- Chemically resistant HDPE, electrostatic conductive
- Delivered with grounding cable
- With removable sieve for easy cleaning
- Funnel diameter: 180 mm
- Splash protection for safe discharge
- Safety lance ensures clean outflow without contaminating the container opening, Lance length: 200 mm
- Container with 10L or 20L capacity
- With level control floater to prevent overfilling



Description	Thread	PK	Cat. No.
with canister 10L and level control	S60/61	1	4.005 954
with canister 20L and level control	S60/61	1	4.005 955

2 Waste Disposal Unit Set, HDPE, Electrostatic Conductive

2
S.C.A.T.

Ready-to-use complete set as disposal unit for liquid waste. Consisting of safety funnel, container and collecting tray. All components are made of electrostatic conductive HDPE to avoid ignition risks. Only one part number for the entire safety system. No time consuming compilation of a configuration. Price advantage compared to ordering piece by piece. The delivery is made complete - the system is immediately ready for use

Funnel

- Hinged Lid
- Sieve
- HDPE, electrostatic conductive
- Grounding cable

Container

- 10 Liter, S60/61 thread
- HDPE, electrostatic conductive
- Float for level control
- With collecting tray
- 445 x 405 x 350 mm



Type	PK	Cat. No.
Waste disposal unit Set	1	6.255 403

Safety container, HDPE

Suitable for the S.C.A.T. safety system. Electrically conductive, with or without floater for level control.

3
S.C.A.T.

Please note: The containers can be grounded with a suitable grounding cable (4.005 653, please order separately).

Type	Capacity	Dimensions (W x D x H) mm	Thread	PK	Cat. No.
Without floater*	10	185 x 290 x 265	S 60 / 61	1	4.005 602
Without floater*	20	185 x 290 x 500	S 60 / 61	1	4.005 671
Without floater*	30	240 x 364 x 455	S 60 / 61	1	4.664 150
Without floater*	60	330 x 395 x 625	S 70 / 71	1	4.005 593
With floater	10	185 x 290 x 265	S 60 / 61	1	4.005 682
With floater	20	185 x 290 x 500	S 60 / 61	1	4.005 683

* with UN approval



4.005 602



6.259 834

Collecting trays, HDPE

Suitable for the S.C.A.T. Safety System. Electrically conductive.

S.C.A.T.

Type	Internal dimensions (W x D x H) mm	External dimensions (W x D x H) mm	PK	Cat. No.
Collecting tray*	235 x 335 x 160	300 x 400 x 170	1	4.005 794
Collecting tray with base insert	285 x 385 x 95	355 x 445 x 135	1	6.253 713
Collecting tray with base insert	295 x 415 x 200	365 x 490 x 240	1	6.259 834 1

*Not electrically conductive



2 Safety container with viewing stripe, HDPE, electrostatic conductive, with UN-approval

Electrostatic conductive container for a safe collection and transportation of flammable solvents and solvent waste. Made of electrostatic conductive HDPE to avoid ignition risks.

S.C.A.T.

The viewing strip allows a permanent control of the solvent level. Also available as set with safety funnel.

- weight: 450 g
- with UN-approval

Please note: The container 6.251 593 must be grounded with a suitable grounding cable (6.254 171, please order separately).

Description	Capacity l	Dimensions (W x D x H) mm	Thread S	PK	Cat. No.
Container 10 l	10	195 x 195 x 380	90	1	6.251 593
Container 10 l	10	190 x 230 x 319	50	1	6.270 296



3 Safety Funnels

For safe filling of plastic canisters. With overflow protection, liquid level control, flame trap, earthing und cap. Filter to extract solid matter. From high quality and chemically resistant stainless steel, screw cap from PE.

Rötzheimer

Upon request: available in flat design (height above thread: 70 mm), with thread G2" or with 2"-butress thread (S56x4).

Type	Diam. mm	Height mm	Weight kg	DIN	PK	Cat. No.
TK 50	140	125	0.5	50	1	9.042 978
TK 51	140	125	0.5	51	1	9.042 979
TK 61	140	125	0.6	61	1	9.042 980
TK 71	140	125	0.6	71	1	9.042 988



4 Safety cans for solvents

For safe storage, use and in-plant transports of flammable liquids. Explosion-proof by flame traps and pressure control valves. Metering devices are self-closing. From high quality and chemically resistant stainless steel 316, electro-polished, gaskets from PTFE, ergonomic handholds.

Rötzheimer

Type	Description	Capacity L	Diam. mm	Height mm	Weight kg	PK	Cat. No.
0 HD	with self-closing, metering device 1/4"	0.5	99	198	0.66	1	6.287 541
01 D	with self-closing, metering device 1/4"	1.0	111	235	0.70	1	9.042 900
02 D	with self-closing, metering device 1/4"	2.0	131	295	0.80	1	9.042 901
05 D	with self-closing, metering device 1/4"	5.0	165	405	1.20	1	9.042 902
0 HK	with screw-cap 1/4"	0.5	99	178	0.62	1	6.287 542
01 K	with screw-cap 1/4"	1.0	111	235	0.65	1	9.042 905
02 K	with screw-cap 1/4"	2.0	131	295	0.75	1	9.042 906
05 K	with screw-cap 1/4"	5.0	165	400	1.15	1	9.042 907
D 125	self-closing, metering device 1/4"				0.13	1	9.042 940
TR 1	Plug-in funnel, tube dia. 23mm		120	120	0.30	1	9.042 975

1 Safety barrels for solvents

For safe storage, use, decanting and in-plant transports of flammable liquids.

Rötzmeier

Explosion-proof by flame traps and pressure control valves in screw caps and metering devices (self-closing). From high quality and chemically resistant stainless steel 316/304, electro-polished, gaskets from PTFE, ergonomic handles.

Models with self-closing taps at the bottom to tap liquid stationary, optionally with unbreakable content level indicator from PFA.



Type	Description	Capacity Litres	Diam. mm	Height mm	Weight kg	PK	Cat. No.
10 Z	with self-closing tap 3/4"	10	260	330	2.48	1	9.042 925
25 Z	with self-closing tap 3/4"	25	315	540	6.54	1	9.042 926
50 Z	with self-closing tap 3/4"	50	365	600	12.20	1	9.042 927
10 ZI*	with self-closing tap 3/4"	10	260	330	2.82	1	9.042 934
25 ZI*	with self-closing tap 3/4"	25	315	540	7.52	1	9.042 935
50 ZI*	with self-closing tap 3/4"	50	365	600	13.20	1	9.042 936
10 K	with screw-cap 1 1/2"	10	260	330	2.20	1	9.042 930
25 K	with screw-cap 1 1/2"	25	315	540	6.40	1	9.042 931
50 K	with screw-cap 2"	50	365	600	12.10	1	9.042 932
10 D*	with self-closing, metering device 1 1/2"	10	260	340	2.25	1	9.042 937
Z 34	with self-closing tap 3/4"				0.22	1	9.042 942
TR 3	Plug-in funnel, straight-lined, tube dia. 34mm		120	120	0.35	1	9.042 977

* With PFA level indicator (type ZI) and separate vent on the tank.

2 Safety canisters for solvents

For safe storage, use and in-plant transports of flammable liquids. Explosion-proof by flame traps and pressure control valves in screw caps and metering devices (self-closing). From high quality and chemically resistant stainless steel 316/304, electro-polished, gaskets from PTFE, ergonomic handles. Space-saving shape, e.g. in safety cabinets. Models with self-closing taps designed for horizontal storage and decanting.

Rötzmeier



Type	Description	Capacity Litres	Dimensions (W x D x H) mm	Weight kg	PK	Cat. No.
05 KD	with self-closing, metering device 1 1/2"	5	130 x 200 x 310	1.65	1	9.042 910
10 KD	with self-closing, metering device 1 1/2"	10	130 x 280 x 380	2.50	1	9.042 911
20 KDL*	with self-closing, metering device 1 1/2"	20	175 x 345 x 470	3.70	1	9.042 912
05 KK	with screw-cap 1 1/2"	5	130 x 200 x 310	1.65	1	9.042 915
10 KK	with screw-cap 1 1/2"	10	130 x 280 x 380	2.50	1	9.042 916
20 KK	with screw-cap 1 1/2"	20	175 x 345 x 470	3.70	1	9.042 917
05 KZ*	with self-closing tap 1 1/2"	5	130 x 200 x 310	1.65	1	9.042 920
10 KZ*	with self-closing tap 1 1/2"	10	130 x 280 x 380	2.50	1	9.042 921
20 KZ*	with self-closing tap 1 1/2"	20	175 x 345 x 470	3.70	1	9.042 922
D 150	self-closing metering device 1 1/2" with vent for 5 + 10 L			0.17	1	9.042 941
Z 150	self-closing tap 1 1/2"			0.17	1	9.042 943
TR 2	Plug-in funnel, inclined, tube dia. 34mm		H: 120, Ø: 120	0.35	1	9.042 976

* with separate ventilation.

3 Safety transportation containers for solvents

For safe transports of flammable liquids. UN-approval (ADR, RID, IMDG, ICAO-TI) for all carriers (street, railway, air, sea). From high quality and chemically resistant stainless steel 316/304, gaskets from PTFE, screw caps without pressure control valve. Upon request: available with valve.

Rötzmeier



Type	Description	Capacity Litres	Dimensions mm	Height mm	Weight kg	PK	Cat. No.
01 T	Safety transport can	1	Ø 111	230	0.65	1	9.042 945
02 T	Safety transport can	2	Ø 131	295	0.75	1	9.042 946
05 T	Safety transport can	5	Ø 165	400	1.15	1	9.042 947
05 KT	Safety transport canister	5	130 x 200	310	1.65	1	9.042 950
10 KT	Safety transport canister	10	130 x 280	380	2.50	1	9.042 951
20 KTL*	Safety transport canister	20	175 x 345	470	3.70	1	6.241 199
10 TZ*	Safety transportation barrel	10	Ø 260	330	2.29	1	6.287 543
25 TZ*	Safety transportation barrel	25	Ø 300	530	6.40	1	9.042 956
LB 1	Bearing bracket for stand 25 l		Ø 260	100	2.29	1	6.287 588
Z 150	self-closing tap 1 1/2" for TZ 25				0.17	1	9.042 943

* with separate ventilation.

1



1 LLG-Trolleys, Stainless Steel

Made of CNS 18/10, material no. 1.4301, with micro-polished surface. All shelves are produced with an all round raised profile edge. This prevents anything from slipping over the edge. The shelves are welded to the car. The load capacity per shelf is 80 kg. A noise-insulation mat is mounted on the bottom side of each shelf. The round tubes at the front edges are used as handgrips.

The trolleys are equipped with galvanized steel castors (4 swivel castors, 2 with brakes, castor diam. 125mm) which are inserted in the tubular frame. Wall bumpers made of plastic (polyamide) on all four corners protect against damage.

Description	Width mm	Depth mm	Height mm	PK	Cat. No.
2 shelves, vertical spacing 585mm	900	600	950	1	9.148 101
3 Shelves, vertical spacing 275mm	900	600	950	1	9.148 104

2



6.312 923

Laboratory Trolleys, HDPE

Hard-wearing, sturdy, HDPE construction resists chemicals and routine knocks and scratches in use, ensuring a long working life.

Langkavel

- stable and high load bearing capacity, long life
- Load capacity per tray approx. 40 kg
- Trolley frame, square, beige
- not electrically conductive, easy to clean
- hygienic, high density polyethylene
- easy to assemble without screws, legs and bases can be recycled
- top tray has integral handles
- 4 rolls (10 cm diameter), 2 of them with brake locks

Type	Description	Colour	Width mm	Depth mm	Height mm	PK	Cat. No.
WTLK 26	2 trays	grey	460	610	660	1	6.312 923 2
WTLK 34	3 trays	grey	460	610	860	1	6.312 924
WTLK 42	3 trays	grey	460	610	1060	1	6.312 925

Further colours available on request.

Carts for laboratory and more...

Since 1979

Langkavel
Office + Lab

For example

The classic cart in various colors

With tubs

Multi-purpose carts

Minis



...or with lockable drawer



...in different colors



...for heavy loads up to 250 kg with 2 or 3 shelves



More carts at www.langkavel.de

– also made of steel

and full Metro series available



Microban
antimicrobial product protection

Langkavel Office + Lab • Hedwig-Kohn-Strasse 4 • D-63457 Hanau • Phone +49 6181 918215 • info@langkavel.de • www.langkavel.de

1 2 Laboratory Trolley clax Mobil comfort with Box



Stable, multi-use trolley with parking brake.
Push-button collapsing/unfolding.
Made in Germany.

Load capacity

Total: 60kg
Upper shelf: 20kg
Lower shelf: 40kg

Dimensions and weight

unfolded (L x W x H): 900 x 580 x 1020mm
collapsed (L x W x H): 710 x 550 x 190mm
Weight without box: 6.9 kg

Folding box dimensions

Inner dimensions (W x D x H): 335 x 495 x 258mm
Outer dimensions (W x D x H): 350 x 500 x 260mm

1



2



Type	PK	Cat. No.
Laboratory Trolley clax Mobil comfort, incl. 1 clax folding box, 46 litres	1	9.148 100

3



3 Clax folding box, 46 litres

Sturdy folding box, made of high-quality plastic, for use with the clax Mobil comfort laboratory trolley.

External dimensions (W x D x H) mm	Internal dimensions (W x D x H) mm	PK	Cat. No.
350 x 500 x 260	335 x 495 x 258	1	9.148 099

4 Trolley, PP

Safe and easy transport of Folding and Euronormboxes with external dimension of 60x40cm. Weight 3.3kg, load capacity 200kg . High quality, smooth running castors.

4



Colour	PK	Cat. No.
blue	1	9.301 502

5 Bowl Trolleys

Trolley

- Blue-grey solid rubber (non-marking) tyres
- Welded frame for 85 or 100 litres plastic bowls
- Height with red bowl approx. 760 mm, with white bowl approx. 840mm
- 4 swivel castors with 75 mm diam.
- ball bearing mounted
- powder coated
- Carrying weight approx. 100 kg

Gorr

5



Bowl, red: PE, 85 litres

Bowl, white: PE, 100 litres

Description	Colour	Width mm	Depth mm	Height mm	PK	Cat. No.
Trolley	black-silver	500	750	720	1	9.148 300
Bowl	red	540	765	350	1	9.148 301
Bowl	white	540	900	400	1	9.148 302

➔ Suitable euronormboxes please see page 792

LLG-Lab Stool



The extra-large seat provides optimum comfort. The solid black plastic star base and the upholstery edge protector that runs all the way round guarantee a long working life. The practical gas spring system with easy ring control allows a comfortable seat height adjustment.

- Resistant to all of the usual disinfectants and chemicals.
- Seat upholstery made of artificial leather (soft and comfortable, washable and antibacterial) or soft-touch PU foam (extremely robust, washable and antibacterial) in black.
- Extra-large seat: Encourages healthy posture and upright seating in the laboratory.
- Round front edge of the seat: Prevents blocked circulation in the thighs.
- Seat height adjustment by gas spring.
- Practical ring release: The height adjustment can be operated comfortably and easily in sitting position.
- Solid black plastic star base, flat design.
- The chrome-plated foot ring for the high chairs provides support through the wide tread area and can be easily and quickly adjusted in height.
- With certificate "Tested Safety" (GS mark).
- 10 years warranty, Made in Germany.

Type	Material	Description	Seat height adjustment mm	PK	Cat. No.
LLG-Lab Stool	PU foam	Castors	460 ... 630	1	6.287 757 ¹
LLG-Lab Stool	PU foam	Castors, foot ring	570 ... 850	1	6.314 807
LLG-Lab Stool	PU foam	Glides, foot ring	570 ... 850	1	6.287 759
LLG-Lab Stool	Artificial leather	Castors	460 ... 630	1	6.287 758
LLG-Lab Stool	Artificial leather	Glides, foot ring	570 ... 850	1	6.287 760 ²

1

6.287 757

2

6.287 760

LLG-Lab Chair



Entry model for healthy sitting! The permanent contact backrest provides best support when working sitting down in the laboratory. The generously proportioned seat and backrest with integrated lumbar support provide additional support and therefore offer best laboratory ergonomics.

- Minimal joints: Hygienic design for easy cleaning and disinfection
- Resistant to disinfectants and chemicals: Resistant to all of the usual disinfectants and chemicals.
- Seat and backrest upholstery made of artificial leather (soft and comfortable, washable and antibacterial) or soft-touch PU foam (extremely robust, washable and antibacterial) in black.
- Quick adjustment: Every function can be operated comfortably and easy in sitting position.
- Seat height adjustment by gas spring.
- Permanent contact backrest.
- Backrest adjustable in height and inclination.
- Solid black plastic star base, flat design.
- The chrome-plated foot ring for the high chairs provides support through the wide tread area and can easily and quickly be adjusted in height.
- With certificate "Tested Safety" (GS mark).
- 10 years warranty, Made in Germany.

Accessories: Multifunctional armrests (pair): Adjustable in height, width and depth as well as swivelling.

Type	Material	Description	Seat height adjustment mm	PK Cat. No.
LLG-Lab Chair	PU Foam	Castors	440-620	1 6.287 750
LLG-Lab Chair	PU Foam	Glides, Foot Ring	580-850	1 6.287 751 1
LLG-Lab Chair	PU Foam	Stop and Go Castors, Foot Ring	620-890	1 6.287 752 2
LLG-Lab Chair	Artificial Leather	Castors	440-620	1 6.287 753 3
LLG-Lab Chair	Artificial Leather	Glides, Foot Ring	580-850	1 6.287 754
LLG-Lab Chair	Artificial Leather	Stop and Go Castors, Foot Ring	620-890	1 6.287 755
Armrests			-	1 6.287 756

1



6.287 751

2



6.287 752

3



6.287 753

LLG-Lab Standing Rest



The LLG-Lab Standing Rest is the practical solution for laboratory workplaces where people have to sit as well as to stand. To cope with this, it has a particularly wide range of heights that can be adjusted steplessly. Its ergonomic backrest and non-slip wave seat surface ensure that you feel completely safe and comfortable when you sit on it.

- Resistant to all of the usual disinfectants and chemicals.
- Seat upholstery made of soft-touch PU foam (extremely robust, washable and antibacterial) in black.
- Adheres to biosafety level BSL1 and BSL2 of the Directive for Biological Agents.
- GMP-conform.
- Rippled wave seat surface: Slip-resistant and offers a very good support and excellent ventilation.
- Integrated backrest: Best support of the lumbar region.
- Its low weight provides maximum mobility and easy handling in the laboratory.
- Seat height adjustment by gas spring.
- Seat swivel range of 360°.
- Solid black plastic star base, flat design.
- The chrome-plated foot ring provides support through the wide tread area and can be easily and quickly adjusted in height.

Type	Material	Description	Seat height adjustment mm	PK	Cat. No.
LLG-Lab Standing Rest	PU Foam	Glides	510-780	1	6.288 956 1
LLG-Lab Standing Rest	PU Foam	Glides, Foot Ring	510-780	1	6.288 957 2



6.288 956



6.288 957

Laboratory Chair Labsit



Labsit is the new chair for all kinds of laboratories. Its intelligent Flex function offers comfort and laboratory ergonomics with minimal adjustments required. Labsit has all the properties required for laboratory work and, at the same time, it is light and universally applicable. Labsit is therefore a laboratory specialist and all-rounder all in one.

- Minimal joints: Hygienic design for easy cleaning and disinfection.
- Resistant to disinfectants and chemicals: Resistant to all of the usual disinfectants and chemicals.
- Seat upholstery made of artificial leather (soft and comfortable, washable and antibacterial) or soft-touch PU foam (extremely robust, washable and antibacterial) in black.
- Suitable for cleanrooms: Certified for the use in cleanrooms category 3 in accordance with ISO 14644-1.
- Adheres to biosafety level BSL1, BSL2 and BSL3 of the Directive for Biological Agents, GMP-conform.
- The backrest made of plastic with its 3D-Flex function automatically adapts to the movements of the user and therefore follows the upper body when leaning back or turning sideways.
- The Flex function on the front edge of the seat supports the forward-angled working which is typical for laboratory work.
- Its low weight and integrated handle provide maximum mobility and easy handling in the laboratory.
- Seat height adjustment by gas spring.
- Solid polished aluminium star base, flat design.
- The chrome-plated foot ring for the high chairs provides support through the wide tread area and can be easily and quickly adjusted in height.
- With certificate "Tested Safety" (GS mark).
- 10 years warranty, Made in Germany.

Accessories: Armrests (pair). Lab-Clip: The intelligent Lab-Clip enables Labsit to be easily, individually and quickly labelled, this creates order. Can be added or removed any time.

Type	Material	Description	Seat height adjustment mm	Colour	PK	Cat. No.
Lab Chair	Artificial Leather	Castors	450-650	Blue	1	6.287 729 ¹
Lab Chair	Artificial Leather	Castors	450-650	Anthracite	1	6.287 730
Lab Chair	Artificial Leather	Castors	450-650	Orange	1	6.287 731
Lab Chair	PU Foam	Castors	450-650	Blue	1	6.287 732
Lab Chair	PU Foam	Castors	450-650	Anthracite	1	6.287 733
Lab Chair	PU Foam	Castors	450-650	Orange	1	6.287 734
Lab Chair	Artificial Leather	Glides, Foot Ring	520-770	Blue	1	6.287 735
Lab Chair	Artificial Leather	Glides, Foot Ring	520-770	Anthracite	1	6.287 736
Lab Chair	Artificial Leather	Glides, Foot Ring	520-770	Orange	1	6.287 737 ²
Lab Chair	PU Foam	Glides, Foot Ring	520-770	Blue	1	6.287 738
Lab Chair	PU Foam	Glides, Foot Ring	520-770	Anthracite	1	6.287 739
Lab Chair	PU Foam	Glides, Foot Ring	520-770	Orange	1	6.287 740
Lab Chair	Artificial Leather	Stop and Go Gastors, Foot Ring	560-810	Blue	1	6.287 741
Lab Chair	Artificial Leather	Stop and Go Gastors, Foot Ring	560-810	Anthracite	1	6.287 742
Lab Chair	Artificial Leather	Stop and Go Gastors, Foot Ring	560-810	Orange	1	6.287 743
Lab Chair	Artificial Leather	Stop and Go Gastors, Foot Ring	560-810	Anthracite	1	6.310 404
Lab Chair	PU Foam	Stop and Go Gastors, Foot Ring	560-810	Blue	1	6.287 744
Lab Chair	PU Foam	Stop and Go Gastors, Foot Ring	560-810	Anthracite	1	6.287 745 ³
Lab Chair	PU Foam	Stop and Go Gastors, Foot Ring	560-810	Orange	1	6.287 746
Armrests					1	6.287 748
Clip		writable			1	6.287 749 ⁴

1



6.287 729

2



6.287 737

3



6.287 745

4



6.287 749

1 Laboratory stool Labsit, with castors

Bimos



The space-saving laboratory stool is a good solution for short-term sitting. The black integral foam cushion is very comfortable. The release ring enables infinitely variable seat height adjustment.

- Robust and washable
- Disinfectant-resistant
- Suitable for cleanrooms: Certified for the use in cleanrooms category 3 in accordance with ISO 14644-1
- Adheres to biosafety level BSL1, BSL2 and BSL3 of the Directive for Biological Agents
- GMP-conform
- Solid polished aluminium star base
- With certificate "Tested Safety" (GS mark)
- 10 years warranty, Made in Germany

Description	Seat height adjustment	PK	Cat. No.
	mm		
Lab Stool	450-650	1	6.287 747

1



2



7.671 311

Laboratory stool Labster, with castors

NEW

Bimos



The space-saving laboratory stool is a good solution for short-term sitting. The large seat, with artificial leather Skai cover, is very soft and comfortable. The ring release enables infinitely variable seat height adjustment.

- Washable
- Resistant to disinfectants
- Certified for the use in cleanrooms category 3 in accordance with ISO 14644-1
- GMP-conform
- Round, basalt grey, polyamide flat base plate
- Double castors for hard floors
- With certificate "Tested Safety" (GS mark)
- 5 years warranty, Made in Germany

Colour	Seat height adjustment	PK	Cat. No.
	mm		
Black	450 ... 650	1	7.671 311 2
Red	450 ... 650	1	6.275 991
White	450 ... 650	1	6.275 990

1 | 2 Laboratory Chair Neon

Bimos



Neon new generation laboratory chairs. Neon offers the best possible support for the body and excellent sitting comfort to wellbeing at work in the laboratory. Neon supports the forward-leaning sitting position that is often necessary for the laboratory work. So Neon is always the ideal solution for the laboratory, when a really comfortable chair is needed.

- Resistant to disinfectants and chemicals: Resistant to all of the usual disinfectants and chemicals.
- Seat and backrest upholstery made of artificial leather (soft and comfortable, washable and antibacterial) or soft-touch PU foam (extremely robust, washable and antibacterial) in black.
- Contaminant-free: No toxic substance and emission.
- Award winning for shape and sustainability. Neon is the first laboratory chair to be awarded the "Blue Angel" eco-label.
- Extra large, ergonomically designed backrest.
- Neon can be adjusted in every possible way to cater for different body sizes and weights on the one hand and the most varied activities on the other.
- The synchronous technology provides an active-dynamic sitting experience. The seat and backrest accompany the body as it moves.
- Innovative changeable upholstery system.
- The 1+1 system makes the change of upholstery very easy: The upholstery elements are simply placed on the chair and fixed with a click. .
- Seat height adjustment by gas spring.
- Synchronous technology including ergonomics package with seat height, seat inclination, seat depth and backrest height adjustment as well as weight regulation.
- Solid black aluminium star base, flat design.
- The chrome-plated foot ring for the high chairs provides support through the wide tread area and can be easily and quickly adjusted in height.
- With certificate "Tested Safety" (GS mark).
- 10 years warranty, Made in Germany

Accessories: Multifunktional armrests (pair): Adjustable in height, width and depth as well as swiveling.

Type	Material	Description	Seat height adjustment mm	Colour	PK Cat. No.
Lab Chair	Artificial Leather	Castors	450-620	Orange	1 6.287 721
Lab Chair	Artificial Leather	Castors	450-620	Grey	1 6.287 722 ³
Lab Chair	PU Foam	Castors	450-620	Orange	1 7.672 157 ⁴
Lab Chair	PU Foam	Castors	450-620	Grey	1 6.287 723
Lab Chair	Artificial Leather	Stop and Go Castors, Foot Ring	630-910	Orange	1 6.287 724 ⁵
Lab Chair	Artificial Leather	Stop and Go Castors, Foot Ring	630-910	Grey	1 6.287 725
Lab Chair	PU Foam	Stop and Go Castors, Foot Ring	630-910	Orange	1 6.287 726
Lab Chair	PU Foam	Stop and Go Castors, Foot Ring	630-910	Grey	1 6.287 727
Multifunktional Armrests					2 6.287 728

1



2



3



6.287 722

4



7.672 157

5



6.287 724

1

Complete Bubble

1 2 Mat Complete Bubble, Complete Smooth

Polyurethane anti-fatigue mat. The mat has a very good chemical and UV resistance.

Ergomat A/S

- Solid workstation mat with filled nubs
- Dimensions 600 x 900 mm
- Shaped bevelled edges
- Silicone und Latex-free
- Anti-static properties
- Suitable for use in cleanrooms of class ISO 5
- 5 years warranty

2

Complete Smooth

Description	Colour	Dimensions mm	Height mm	PK	Cat. No.
Complete Bubble	light grey	600 x 900	15	1	4.665 400
Complete Bubble	light grey	900 x 1200	15	1	4.665 401
Complete Smooth	grey	600 x 900	11	1	4.665 402
Complete Smooth	grey	900 x 1200	11	1	4.665 403

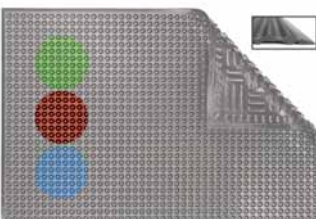
3

3 Mat Hygiene grey

Premium rubber anti-fatigue mat.

Ergomat A/S

- Shaped bevelled edges
- Silicone und Latex-free
- Suitable for use in cleanrooms of class ISO 5
- 3 years warranty

Description	Colour	Dimensions mm	Height mm	PK	Cat. No.
Hygiene grey	grey	600 x 900	11	1	4.665 404
Hygiene grey	grey	900 x 1200	11	1	4.665 406

4

4 Roller Steps, WEDO-Step

Manufactured from recyclable UV resistant polypropylene. Mounted on 3 castors allowing complete mobility which retract when stool is in use, providing a secure platform. No tools required for assembling. TÜV and GS approved.

Werner Dorsch

Colour	Int. diam. mm	Ext. diam. mm	Height mm	Max. load kg	PK	Cat. No.
Blue	290	440	430	150	1	9.700 400
Red	290	440	430	150	1	9.700 401
Light grey	290	440	430	150	1	6.055 095
White	290	440	430	150	1	6.239 322
Black	290	440	430	150	1	6.289 953
Grey	290	440	430	150	1	7.600 593

5

4.668 331

Folding steps K80

Made of aluminum, with large steel steps of 30 x 21 cm and anti-slip mats. Narrowly foldable to 5 cm.

Hailo

- Stands securely due to the non-slip plug-in foot that stands up over the entire surface.
- Folding safety mechanism (safety lock)
- Ergonomic square tube bracket
- Can be loaded up to 150 kg

Number of steps	Height*	Colour	PK	Cat. No.
2	46	black	1	4.668 331 5
3	69	black	1	7.623 704

* Height of first step (cm)

Flexible laboratory solutions made of steel.

Safe. Resistant. Hygienic.



Laboratory furniture



Fume cupboards



Safety cabinets



Service supply



1 Heavy-duty benches

Heavy-duty benches with a mobile TopResist® melamine worktop and one steel shelf.
Carring capacity: 200 kg.

Köttermann

Width mm	Height mm	Depth mm	PK	Cat. No.
1200	750	600	1	4.658 911
1500	750	600	1	4.658 912
1200	750	750	1	4.658 913
1500	750	750	1	4.658 914
1800	750	750	1	4.658 915
1200	900	600	1	4.658 916
1500	900	600	1	4.658 917
1200	900	750	1	4.658 918
1500	900	750	1	4.658 919
1800	900	750	1	4.658 920

Mobile underbench cabinets

Mobile underbench cabinets offer a maximum in adaptability. The castors can be locked if necessary. Mobile underbench cabinets are available with open fronts, hinged doors and/or drawers, and as office cabinets with pencil tray for sitting and standing work height (750 and 900 mm).

Köttermann

Description	Dimensions (W x D x H) mm	PK	Cat. No.
1 drawer 150mm, 1 drawer 300mm, pencil tray, hand., file, lockable	450 x 516 x 590	1	4.658 966
1 door, lockable	450 x 516 x 590	1	4.658 967
3 drawers 150mm, lockable	450 x 516 x 590	1	4.658 968
1 door, 1 shelf, lockable	450 x 516 x 740	1	4.658 969
1 door, 1 drawer 150mm, lockable	450 x 516 x 740	1	4.658 970
4 drawers 150mm, lockable	450 x 516 x 740	1	4.658 971
1 door, lockable	600 x 516 x 590	1	4.658 972
3 drawers 150mm, lockable	600 x 516 x 590	1	4.658 973
3 drawers 150mm, 1 pencil tray, lockable	600 x 516 x 590	1	4.658 974
1 door, 1 shelf, lockable	600 x 516 x 740	1	4.658 975
1 door, 1 drawer 150mm, lockable	600 x 516 x 740	1	4.658 976
4 drawers 150mm, lockable	600 x 516 x 740	1	4.658 977 ²
2 doors, lockable	900 x 516 x 590	1	4.658 978
2 doors, 1 shelf	900 x 516 x 740	1	4.658 979 ³
2 doors, 2 drawers 150mm, lockable	900 x 516 x 740	1	4.658 980

2



4.658 977

3



4.658 979

4

4 Benchtop Fume Hood

Designed for small facilities or installations in which a number of fume hoods are needed, this unit is excellent for use in schools, junior colleges and universities.

Bel-Art Products

- One-piece shell molded of chemical resistant polyethylene with rounded inside corners for easy cleaning
- Clear acrylic sash slides on a track featuring stop pins for open, closed or intermediate positions; bottom gap allows for continuous air flow
- Front opening (W x H): 560 x 300 mm
- Stepped exhaust duct can be used with either a 12 or 15cm diameter duct
- Overall dimensions (W x D X H): 690 x 330 x 560 mm
- Shipping weight: 17 kg



Description	PK	Cat. No.
Benchtop Fume Hood	1	6.284 935

Glove Boxes Vitrum/Pure/Air Stream

Front panel with two glove ports and one pair of gloves size 9, two lead-ins for cables on the back side (upper left and upper right). Transfer chamber with two doors, external door with latch to prevent accidental opening, the tray extends into the workspace with opening of the internal door for easy removal of inserted products.

SICCO

Specifications

Capacity Box:	290 l
Internal Dimensions Box (W x D x H):	850 x 540 x 650 mm
Max. Load Box:	40 kg
Inlet openings:	Ø 190 mm
Hinged lid opening (W x H):	850 x 425 mm
Capacity Transfer chamber:	24 l
Internal Dimensions Transfer chamber (W x D x H):	220 x 320 x 275 mm
Max. Load Transfer chamber:	3 kg
Power supply:	240 V, 50/60 Hz

1 Glove box Vitrum, borosilicate glass 3.3



SICCO

Aluminium frame with panels made of borosilicate glass 3.3. The workspace is made of materials with good chemical resistance (aluminium, stainless steel, borosilicate glass) for handling of aggressive products. With gloves made of natural rubber. Workspace including two hose connectors for gas-filling and aeration and 2 x 5 m PVC tubing for gas-filling and 2 x 5 m PE aeration tubing. Transfer chamber with two doors, external door with latch to prevent accidental opening, the tray extends into the workspace with opening of the internal door for easy removal of inserted products.

Working Temperature range: -20 ... 120 °C

Type	External dimensions (W x D x H) mm	Weight kg	PK	Cat. No.
Vitrum	1210 x 600 x 700	20	1	6.266 223



2 Glove Box Pure, PMMA



SICCO

Aluminium frame with panels made of acrylic glass (PMMA), base panel made of polyethylene. With gloves made of UV-resistant EPDM. Integrated ultraviolet lamp with life-time monitoring on the top side for air and surface disinfection in the workspace, exchangeable lamp. The ultraviolet lamp is an ozone-free radiation source that does not emit any radiation below 220 nm.

Working Temperature Range: -20 - 70 °C

Type	External dimensions (W x D x H) mm	Weight kg	PK	Cat. No.
Pure	1210 x 600 x 700	22	1	6.312 313



3 Glove Box Air Stream, PMMA



SICCO

Aluminium frame with panels made of acrylic glass (PMMA), base panel made of polyethylene. With gloves made of natural rubber. Integrated HEPA filtering unit in the top side for a high-purity atmosphere in the workspace. Manometer to display the degree of filter saturation. Pipe sockets made of PE are included in delivery for converting to the different operating modes: internal air circulation, fresh air supply and exhaust. Exchangeable filter cartridge. Maintenance-free and trouble-free motor.

Working Temperature range: -20 - 70 °C

Type	External dimensions (W x D x H) mm	Weight kg	PK	Cat. No.
Air Stream	1210 x 660 x 1015	42	1	6.312 314



1



1 Fume Hood Workstations LABOPUR® H Series

Manipulation of liquid chemicals and powders where and when needed.

ECOSAFE

Advantages: eliminates installation costs, saves substantially capital and running costs, mobile and easy to relocate wherever needed; protects the user and environment against toxic fumes. Low Energy consumption: less than 200 KWh /year (for 2100 hours usage)

Choice of activated charcoal filters (Please order separately!):

- "ORG" filter for flammables and organics
- "CORG" filter suitable for the most common laboratory chemicals, for organic and corrosive vapors
- "FOR" filter for formaldehyde vapors
- "AMM" filter for ammonia vapors

Standard equipment:

- Built in 15/10 steel, covered with white Epoxy (RAL 9010) with blue stripes
- HPL or tempered glass worktop on removable retention tank (optional)
- Transparent PMMA glazed walls on all four sides for comfortable working or lectures
- Ergonomic hand traps or trapeze opening
- 4 protective caps for easy use of external supplies (e.g. power cables, water, gas)
- Air velometer; sampling outlet for reactive tube measurement

Recirculating air filter system (CLASS 2) and coal filters Norm NFX 15-211

- Noiseless fan: 57 dB(A), 220-240 V, 50 Hz, 10 W, 0.1 A
- Air flow: 170 m³/h; face velocity: 0.4 to 0.6 m/s
- Ventilation system with lighting control in case of system failure

Please choose fume hoods, charcoal filters, trolleys and accessories according to your needs. Delivered mounted.

The fume hood will be delivered without bottom retention tank and work top.

2 Fume Hoods LABOPUR® H Series

ECOSAFE

Type	External dimensions (W x D x H) mm	Weight kg	Description	PK	Cat. No.
H 70	455 x 455 x 605	25	2 hand traps	1	7.910 932
H 061D	600 x 650 x 950	41	2 hand traps, 1 filter unit	1	6.288 042
H 061Z	600 x 650 x 950	41	trapezoidal opening, 1 filter unit	1	6.288 043
H 091D	900 x 750 x 1160	67	2 hand traps, 1 filter unit	1	6.288 044
H 092D	900 x 750 x 1160	67	2 hand traps, 2 filter units	1	6.288 045
H 092Z	900 x 750 x 1160	67	trapezoidal opening, 2 filter units	1	6.288 046
H 121D	1200 x 750 x 1160	85	2 hand traps, 1 filter unit	1	6.288 047
H 122D	1200 x 750 x 1160	85	2 hand traps, 2 filter units	1	6.288 048
H 122Z	1200 x 750 x 1160	85	trapezoidal opening, 2 filter units	1	6.288 049
H 152D	1500 x 750 x 1160	102	2 hand traps, 2 filter units	1	6.288 050
H 152Z	1500 x 750 x 1160	102	trapezoidal opening, 2 filter units	1	6.288 051
H 153D	1500 x 750 x 1160	102	2 hand traps, 3 filter units	1	6.288 052
H 153Z	1500 x 750 x 1160	102	trapezoidal opening, 3 filter units	1	6.288 053
H 153G	1500 x 750 x 1160	102	larger trapezoidal opening, 3 filter units	1	6.288 054

2



1 Charcoal Filters for Ductless Fume Hoods LABOPUR® H Series

Charcoal filter "ORG": for organic vapors
 Charcoal filter "CORG": for organic and corrosive vapors
 (suitable for the most common laboratory chemicals)
 HEPA filter "HEP": for Particle
 Frame for HEPA filter "SH"

ECOSAFE



For models (H092D, H092Z, H122D, H122Z, H152D, H152Z) with 2 fans, please order 2 charcoal filters or rather HEPA filters with additional frame.
For models (H153D, H153Z, H153G) with 3 fans, please order 3 charcoal filters or rather HEPA filters with additional frame.

For model	Type	PK	Cat. No.
H50, H60, H70	CORG51	1	4.007 805
H200, H201, H210, H211, H061D, H061Z, H091D, H092D, H092Z, H121D, H122D, H122Z, H152D, H152Z, H153D, H153Z, H153G	CORG201	1	4.007 802
H300, H301, H400, H401, H1300, H1301, H2300, H2301	CORG1301	1	4.007 801
H3500, H3501	CORG3501	1	4.007 804
H201, H211, H061D, H061Z, H091D, H092D, H092Z, H121D, H122D, H122Z, H152D, H152Z, H153D, H153Z, H153G	HEP200	1	6.252 313
H401, H411	HEP400	1	6.261 238
H301, H311, H401, H411, H1301, H1311, H2301, H2311	HEP300	1	6.270 348
H501, H511, H1501, H1511, H2501, H2511, H3501, H3511	HEP500	1	6.280 880
H3501, H3511	HEP3500	1	6.280 453
H50, H60, H70	ORG50	1	9.840 202
H201, H211, H061D, H061Z, H091D, H092D, H092Z, H121D, H122D, H122Z, H152D, H152Z, H153D, H153Z, H153G	ORG200	1	4.007 817
H300, H301, H400, H401, H1300, H1301, H2300, H2301	ORG1300	1	4.007 816
H3500, H3510, H3501, H3511	ORG3500	1	4.007 819
H200, H201, H210, H211, H061D, H061Z, H091D, H092D, H092Z, H121D, H122D, H122Z, H152D, H152Z, H153D, H153Z, H153G	SH200	1	6.264 727

2 Workstation with Deaerated Storage Cabinet LABOPUR® H Series Package

Manipulation and storage in the laboratory: all in one.

ECOSAFE

The storage cabinet is connected to the fume hood in order to extract and absorb the toxic fumes from both items. The self-contained system provides mobility, security and highly reduces running costs. No ductwork or exhaust system required, no discharge of toxic gases to the environment. No heating or cooling of air.

Technical specifications of the cabinet:

- Built in steel 15/10, white Epoxy paint (RAL 9010) pictogram ISO 3864, EU 92/58/CEE
- Self-closing wing doors, locking system
- 1 height-adjustable retention shelf, 1 retention tank
- 4 castors (height of castors: 70 mm)
- Vent grids in the lower part, connection element to the fume hood

LABOPUR® Workstation supplied with:

- Ventilated storage cabinet
- Fume hood with recirculating air filtration system CLASSE 2, certified Norm NF X 15-211, May 2009
- Charcoal filter "CORG": absorbs inorganic/organic acids vapors and organic preparations and solvents
- Containment sump + melamine wotktop (tempered glass available on request)
- Connecting kit between the fume hood and the safety cabinet below



Type	External dimensions (W x D x H) mm	Weight kg	PK	Cat. No.
PMSF061Z	615 x 630 x 1840	85	1	6.288 067
PMSF092Z	915 x 780 x 1950	121	1	6.288 068
PMSF122Z	1215 x 780 x 1950	159	1	6.288 069
PMSF152Z	1520 x 780 x 1950	178	1	6.288 070
PMSF153Z	1520 x 780 x 1950	190	1	6.288 071

1

1 Ductless Fume Hoods Type Ascent Opti™

Compact, energy saving fume hood without ducting system.

ESCO

- Independently tested and complies with AFNOR NFX 15-211 standard
- Average Inflow Air Velocity: 0.5m/s
- Easy Filter change
- Sentinel-Microprocessor with LCD-Display, air velocity alarm and 24-hour-clock
- Fluorescent lighting provides superior illumination of the work zone
- Sloped acrylic front window
- With transparent back wall (for type SPD-4B1)
- Acrylic side walls
- ISOCIDE™ antimicrobial coating on all painted surfaces minimises contamination.
- Stainless steel spill-retaining work top.
- Sampling port
- Pass-through ports in the back wall
- Pre-filter made of polyester fibre, EU3 rating is included

Hood is delivered unassembled. On-site assembly can be completed in 60 mins. Without special tools.

Options on request:

Support stands, installation

For operation the main filters have to be ordered separately.

Type	Size	External dimensions (W x D x H) mm	Internal dimensions (W x D x H) mm	PK	Cat. No.
SPD-4A1	1.2 m	1140 x 700 x 1125	1116 x 651 x 855	1	4.658 854
SPD-4B1	1.2 m	1140 x 700 x 1125	1116 x 651 x 855	1	4.676 174

Main filters for Ductless Fume Hoods Type Ascent Opti™



ESCO

Type	Description	For	PK	Cat. No.
CFA-4	Standard filter	Ascent Opti™, 1,2 m	1	6.286 430
CFB-4	Acid filter	Ascent Opti™, 1,2 m	1	4.669 324
CFC-4	Mercury filter	Ascent Opti™, 1,2 m	1	4.669 325
CFD-4	Sulphur filter	Ascent Opti™, 1,2 m	1	4.669 326
CFE-4	Halogen filter	Ascent Opti™, 1,2 m	1	4.669 327
CFF-4	Aldehyde filter	Ascent Opti™, 1,2 m	1	4.669 328
CFG-4	Ammonia / Amine filter	Ascent Opti™, 1,2 m	2	6.311 106
CFH-4	Ether / Chloroform filter	Ascent Opti™, 1,2 m	1	4.669 329
CFA-6	Standard filter	Ascent Opti™, 0,9 m	1	6.286 270
CFB-6	Acid filter	Ascent Opti™, 0,9 m	1	4.669 330
CFC-6	Mercury filter	Ascent Opti™, 0,9 m	1	4.669 331
CFD-6	Sulphur filter	Ascent Opti™, 0,9 m	1	4.669 332
CFE-6	Halogen filter	Ascent Opti™, 0,9 m	1	4.669 333
CFF-6	Aldehyde filter	Ascent Opti™, 0,9 m	1	4.669 334
CFG-6	Ammonia / Amine filter	Ascent Opti™, 0,9 m	1	4.669 335
CFH-6	Ether / Chloroform filter	Ascent Opti™, 0,9 m	1	4.669 336

2

2 Chemical laboratory exhaust APA

- Safe handling of chemicals, protection from hazardous vapours and potentially explosive atmospheres
- Suitable for Pharmacies
- Easily mounted on a table top
- Robust construction made of chemically resistant, antibacterial powder-coated sheet steel
- Testing of the air equipment by recognized test institute

asecos

Standard equipment:

- Exhaust air fan
- Monitoring electronics with visual and audible alarm
- Stepless height adjustable front sash made from acrylic glass
- Workplace light
- 2 sockets

Type	External dimensions (W x D x H) mm	Weight kg	PK	Cat. No.
APA.145.090	900 x 600 x 1460	74	1	6.256 393
APA.145.075	750 x 600 x 1460	84	1	6.257 135

1 Ductless Fume Hoods Type Ascent™ Max

Compact, energy saving fume hood without ducting system.

ESCO

- Independently tested and complies with AFNOR NFX 15-211 standard
- Easy Filter Change
- Average Inflow Air Velocity: 0.4m/s
- Sentinel-Microprocessor with LCD-Display, air velocity alarm and 24-hour-clock
- Fluorescent lighting provides superior illumination of the work zone
- Tempered glass sliding sash
- Tempered glass side panel
- ISOCIDE™ antimicrobial coating on all painted surfaces minimizes contamination.
- Stainless steel worktop

Model variations:

Model type B: Pre-filter, main filter (activated carbon, different filter types available)

Model type C: Pre-filter, main filter (activated carbon, different filter types available), back-up filter (activated carbon, different filter types available)

Model type E: Pre-filter, main filter (activated carbon, different filter types available), back-up filter (HEPA filter)

Options on request:

Filter, electrical outlet, VOC sensor, service fixture, swan-neck faucet, Drip Cup (PP), support stand, installation

For operation the main filters and the back-up filter (Modell type C) have to be ordered separately.

Type	Size	External dimensions (W x D x H) mm	Internal dimensions (W x D x H) mm	PK	Cat. No.
ADC-2B1	0.6 m	730 x 736 x 1460	660 x 596 x 765	1	4.658 982
ADC-3B1	0.9 m	1035 x 736 x 1455	965 x 596 x 765	1	4.658 983
ADC-4B1	1.2 m	1340 x 736 x 1455	1268 x 596 x 765	1	4.658 984
ADC-5B1	1.5 m	1645 x 736 x 1455	1575 x 596 x 765	1	4.658 985
ADC-6B1	1.8 m	1950 x 736 x 1455	1880 x 596 x 765	1	4.658 986
ADC-3C1	0.9 m	1035 x 736 x 1455	965 x 596 x 765	1	4.658 987
ADC-4C1	1.2 m	1340 x 736 x 1455	1268 x 596 x 765	1	4.658 989
ADC-5C1	1.5 m	1645 x 736 x 1455	1575 x 596 x 765	1	4.658 990
ADC-6C1	1.8 m	1950 x 736 x 1455	1880 x 596 x 765	1	4.658 991
ADC-3E1	0.9 m	1035 x 736 x 1455	965 x 596 x 765	1	4.658 992
ADC-4E1	1.2 m	1340 x 736 x 1455	1268 x 596 x 765	1	4.658 996
ADC-5E1	1.5 m	1645 x 736 x 1455	1575 x 596 x 765	1	4.658 997

1



➔ More safety cabinets please see chapter 13.

➔ Suitable Filters - please see page 286.

Main filters for Ductless Fume Hoods Type Ascent™ Max



ESCO

Type	Description	For	PK	Cat. No.
CFA-11	Standard filter	ADC-2B	1	6.272 630
CFB-11	Acid filter	ADC-2B	1	4.678 462
CFC-11	Mercury filter	ADC-2B	1	4.678 463
CFD-11	Sulphur filter	ADC-2B	1	4.678 464
CFE-11	Halogen filter	ADC-2B	1	4.678 465
CFF-11	Aldehyde filter	ADC-2B	1	4.678 466
CFG-11	Ammonia / Amine filter	ADC-2B	1	4.678 467
CFH-11	Ether / Chloroform filter	ADC-2B	1	4.678 468
CFA-1	Standard filter	ADC-3B/C/D/E	1	6.272 951
CFB-1	Acid filter	ADC-3B/C/D/E	1	6.275 961
CFC-1	Mercury filter	ADC-3B/C/D/E	1	4.678 447
CFD-1	Sulphur filter	ADC-3B/C/D/E	1	4.678 448
CFE-1	Halogen filter	ADC-3B/C/D/E	1	4.678 449
CFF-1	Aldehyde filter	ADC-3B/C/D/E	1	4.678 450
CFG-1	Ammonia / Amine filter	ADC-3B/C/D/E	1	7.939 181
CFH-1	Ether / Chloroform filter	ADC-3B/C/D/E	1	4.678 451
CFA-2	Standard filter	ADC-4B/C/D/E	1	4.664 626
CFB-2	Acid filter	ADC-4B/C/D/E	1	6.312 417
CFC-2	Mercury filter	ADC-4B/C/D/E	1	4.678 452
CFD-2	Sulphur filter	ADC-4B/C/D/E	1	4.678 453
CFE-2	Halogen filter	ADC-6B/C/D/E	1	4.664 140
CFF-2	Aldehyde filter	ADC-6B/C/D/E	1	7.939 201
CFG-2	Ammonia / Amine filter	ADC-6B/C/D/E	1	4.678 454
CFH-2	Ether / Chloroform filter	ADC-6B/C/D/E	1	4.678 455
CFA-3	Standard filter	ADC-5B/C/D/E	1	6.272 953
CFB-3	Acid filter	ADC-5B/C/D/E	1	4.678 456
CFC-3	Mercury filter	ADC-5B/C/D/E	1	4.678 457
CFD-3	Sulphur filter	ADC-5B/C/D/E	1	6.290 675
CFE-3	Halogen filter	ADC-5B/C/D/E	1	4.678 458
CFF-3	Aldehyde filter	ADC-5B/C/D/E	1	4.678 459
CFG-3	Ammonia / Amine filter	ADC-5B/C/D/E	1	4.678 460
CFH-3	Ether / Chloroform filter	ADC-5B/C/D/E	1	4.678 461

Further models can be found in our online shop.

Back-up filters for Ductless Fume Hoods Type Ascent™ Max



ESCO

Type	Description	For	PK	Cat. No.
CFA-7	Standard filter	ADC-3C	1	6.258 408
CFB-7	Acid filter	ADC-3C	1	7.939 217
CFC-7	Mercury filter	ADC-3C	1	4.678 469
CFD-7	Sulphur filter	ADC-3C	1	4.678 470
CFE-7	Halogen filter	ADC-3C	1	4.678 471
CFF-7	Aldehyde filter	ADC-3C	1	4.678 472
CFG-7	Ammonia / Amine filter	ADC-3C	1	6.265 311
CFH-7	Ether / Chloroform filter	ADC-3C	1	4.678 473
CFA-8	Standard filter	ADC-4C	1	4.678 474
CFB-8	Acid filter	ADC-4C	1	6.259 546
CFC-8	Mercury filter	ADC-4C	1	4.678 475
CFD-8	Sulphur filter	ADC-4C	1	4.678 476
CFE-8	Halogen filter	ADC-4C	1	4.678 477
CFF-8	Aldehyde filter	ADC-4C	1	7.642 799
CFG-8	Ammonia / Amine filter	ADC-4C	1	4.678 478
CFH-8	Ether / Chloroform filter	ADC-4C	1	4.678 479
CFA-9	Standard filter	ADC-5C	1	6.312 551
CFB-9	Acid filter	ADC-5C	1	4.678 480
CFC-9	Mercury filter	ADC-5C	1	4.678 481
CFD-9	Sulphur filter	ADC-5C	1	4.678 482
CFE-9	Halogen filter	ADC-5C	1	4.678 483
CFF-9	Aldehyde filter	ADC-5C	1	4.678 484
CFG-9	Ammonia / Amine filter	ADC-5C	1	4.678 485
CFH-9	Ether / Chloroform filter	ADC-5C	1	4.678 486
CFA-10	Standard filter	ADC-6C	1	4.678 487
CFB-10	Acid filter	ADC-6C	1	4.678 488
CFC-10	Mercury filter	ADC-6C	1	4.678 489
CFD-10	Sulphur filter	ADC-6C	1	4.678 490
CFE-10	Halogen filter	ADC-6C	1	4.678 491
CFF-10	Aldehyde filter	ADC-6C	1	4.678 492
CFG-10	Ammonia / Amine filter	ADC-6C	1	7.939 346
CFH-10	Ether / Chloroform filter	ADC-6C	1	4.678 493

Further models can be found in our online shop.

1 Underbench Cabinet with Refrigerating Unit

1

asecos

- Safe and approved cooled storage of hazardous materials in workrooms
- Type proofed according to DIN EN 14470-1, fire resistance 90 minutes
- Mobile: integrated castors with plinth, easy moving of the cabinet
- Convenient handling: drawer can be opened with minimal effort
- Safe access to all containers: interior of the drawer is completely visible,
- Convenient: drawer remains open in any position, self-closing in the event of a fire
- No unauthorised use: drawer is lockable with cylinder locking and locking state indicator (red/green)
- Quickly put into operation: integrated technical recirculating air system with multi-stage filter system and power cord
- 7-Segment/LED-Display: function monitoring directly in view. Display shows the refrigeration temperature (TARGET/ ACTUAL), air exchange rate and filter saturation, easy setting of the required temperature
- High flexibility in choosing the installation location
- Active personal protection through safe capture of harmful vapours with retention in the filter system
- VDE tested electronic monitoring system with visual and audible alarm including potential-free alarm contact
- Safe, permanent min. 10-fold air exchange, no areas inside and outside of the cabinets are at risk of explosion
- Maximum refrigeration temperature of +2 °C (with max. 25 °C room temperature)



Scope of delivery: Model UB90.060.110.KU.S incl. drawer made of stainless steel, load capacity 50 kg

Specifications

Outer dimensions (W x D x H):	1108 x 574 x 631 mm
Inner dimensions (W x D x H):	770 x 440 x 484 mm
Drawer (W x D x H):	422 x 369 x 80 mm

Description	PK	Cat. No.
Underbench cabinet with refrigerating unit UB90.060.110.KU.S incl. drawer with stainless steel sump and castors with plinth H=30 mm	1	6.267 271
Perforated insert (stainless steel) for sump	1	6.267 273
Second level drawer (perforated plate) made of stainless steel	1	6.267 272

Underbench Cabinets

2

asecos

- Safe and approved storage of hazardous materials in workrooms
- Type proofed according to DIN EN 14470-1, fire resistance 90 minutes, GS approved, CE conformal
- Mobile: integrated castors with plinth, easy moving of the cabinet
- Quickly put into operation: integrated air ducts ready for connection (NW 50) to a technical exhaust system
- Safe access to all containers: interior of the drawer is completely visible, 135° opening of the wing doors
- Convenient: doors and drawer remain open in any position
- Safety: drawer standard fitted with earthing wire incl. clamp and with seal welded sump, doors and drawer are self-closing in the event of a fire
- No unauthorised use: doors and drawer are lockable with cylinder locking and locking state indicator (red/green)

Scope of delivery: Models UB90.060.059.S and UB90.060.110.S incl. drawer with sump and perforated insert, Model UB90.060.059.T incl. bottom collecting sump and perforated insert as a storage level

Further cabinet versions available on request.



6.267 275

Specifications

Outer dimensions (W x D x H)	
UB90.060.059.S/UB90.060.059.T:	593 x 574 x 600 mm
UB90.060.110.S/UB90.060.110.2T:	1102 x 574 x 600 mm
Inner dimensions (W x D x H)	
UB90.060.059.S/UB90.060.059.T:	470 x 450 x 500 mm
UB90.060.110.S/UB90.060.110.2T:	980 x 450 x 500 mm
Sump (W x D x H)	
UB90.060.059.S:	422 x 441 x 80 mm
UB90.060.110.S:	930 x 441 x 80 mm

Description	PK	Cat. No.
Underbench cabinet with drawer UB90.060.059.S	1	6.267 275
Underbench cabinet with door UB90.060.059.T	1	7.671 305
Underbench cabinet with drawer UB90.060.110.S	1	6.263 207
Additional shelf for model UB90.060.059.T	1	6.267 277
Additional shelf for model UB90.060.110.2T	1	6.267 278

Safety Storage Cabinets V-Move 90

The space saving vertical drawer Safety storage cabinets provide an overview and simple access to the stored containers. Safe and approved storage of flammable hazardous substances in working areas.

asecos

- Space saving vertical drawer
- Robust construction and longevity: stable, high quality and scratch proof cabinet body with powder-coated surface
- Electronic opening and closing
- Standard serial closing after approx. 60 seconds with visual and acoustic signal for drawer closure
- Lockable with cylinder lock (integration in an existing locking system possible) and locking state indicator (red/green)
- Adjusting aids to compensate for uneven floor
- Integrated air ducts ready for connection (DN 75) to a exhaust system
- Guard rail system (option)
- 2 different colour versions available: Light grey RAL 7035 and Pure white RAL 9010

Scope of supply versions:

- 1) Cabinet without interior equipment
- 2) Cabinet with 4 x shelves (2.5-l bottles), 1 x perforated insert, 1 x bottom collecting sump
- 3) Cabinet with 5 x shelves (1-l bottles), 1 x perforated insert, 1 x bottom collecting sump
- 4) Cabinet left/right: 4 x shelves (2.5-l bottles), 1 x perforated insert, 1 x bottom collecting sump
- 5) Cabinet left/right with 5 x shelves (1-l bottles), 1 x perforated insert, 1 x bottom collecting sump
- 6) Cabinet left: 4 x shelves (2.5-l bottles), 1 x perforated insert, 1 x bottom collecting sump, right: 5 x shelves (1-l bottles), 1 x perforated insert, 1 x bottom collecting sump

Option:

- Recirculating air filter system with exhaust air monitoring (Cat. No. 9.840 650)
- Ventilation system with exhaust air monitoring (Cat. No. 6.238 986)
- Ventilation system without exhaust air monitoring (Cat. No. 9.840 616)

Specifications

Outer dimensions (W x D x H):

Internal dimensions (W x D x H):

Net weight (corpus):

V90.196.045.VDAC // V90.196.081.VDAC

450 x 863 x 1966 mm // 819 x 863 x 1966 mm

331 x 773 x 1750 mm // 701 x 773 x 1750 mm

344 kg // 500 kg

Type	Version	Colour	PK	Cat. No.
V90.196.045	1	Light grey	1	6.291 072
V90.196.045	2	Light grey	1	6.310 090
V90.196.045	3	Light grey	1	4.662 147 ¹
V90.196.045	1	Pure white	1	6.291 071
V90.196.045	2	Pure white	1	4.662 146
V90.196.045	3	Pure white	1	6.290 792
V90.196.081	1	Light grey	1	6.291 078
V90.196.081	4	Light grey	1	4.662 145
V90.196.081	5	Light grey	1	4.662 144
V90.196.081	6	Light grey	1	4.662 143
V90.196.081	1	Pure white	1	6.291 079
V90.196.081	4	Pure white	1	4.662 142
V90.196.081	5	Pure white	1	4.662 141 ²
V90.196.081	6	Pure white	1	4.662 140

1



4.662 147

2



4.662 141

Safety Storage Cabinets Q-PEGASUS-90 with Wing Doors

asescos

- Safe and approved storage of hazardous materials in workrooms
- Type proved according to EN 14470-1, fire resistance 90 minutes
- GS-approved
- Outer body made of sheet steel, interior with chemical resistant surface, colour: body anthracite grey RAL 7016, doors light grey (RAL 7035), door colour pure white(RAL 9010) available on request
- Convenient handling: one-hand operation for double-door cabinets (AGT)
- Standard door open arrest system holds doors open, safe and convenient storage and removal
- Serial automatic door closing (TSA) releases arrested doors after approx. 60 seconds. Acoustic and visual signal before closing
- Lockable doors with cylinder lock (integration into a locking system possible), integrated locking state indicator (red/green)
- Integrated transport base with removable, optional base cover, easy indoor transport
- Adjusting aids for compensation for uneven floor
- Ventilation connection (NW 75) in the cabinet ceiling

Shelves, height adjustable (32 mm increments), load capacity 75 kg (evenly distributed load), bottom collecting sump with perforated insert as a first storage level. Capacity bottom collecting sump: 33 litre (model width 1200 mm), 22 litre (model width 600 mm)

Supplied with: Safety Storage Cabinet Q-PEGASUS-90 Model Q90.195.120.WDAC or Q90.195.060.WDAC incl. interior equipment with 3 shelves, bottom collecting sump with perforated insert

Option:

- Recirculating air filter system with exhaust air monitoring (Cat. No. 9.840 650)
- Ventilation system with exhaust air monitoring (Cat. No. 6.238 986)
- Ventilation system without exhaust air monitoring (Cat. No. 9.840 616)

A wide variety of cabinet versions is available. Please enquire.

Specifications

Outer dimensions (W x D x H)

Q90.195.120.WDAC: 1193 x 615 x 1953mm
 Q90.195.060.WDAC: 599 x 615 x 1953mm

Inner dimensions (W x D x H)

Q90.195.120.WDAC: 1050 x 522 x 1647mm
 Q90.195.060.WDAC: 450 x 522 x 1647mm

Shelf dimensions (W x D x H)

Q90.195.120.WDAC: 1040 x 432 x 30mm
 Q90.195.060.WDAC: 440 x 432 x 30mm

Weight

Q90.195.120.WDAC: 434kg
 Q90.195.060.WDAC: 265kg

Description	PK	Cat. No.
Safety storage cabinet Q90.195.120.WDAC	1	9.840 681 ¹
Safety storage cabinet Q90.195.060.WDAC	1	9.840 682 ²
Plinth panel for Safety storage cabinet Q90.195.120.WDAC	1	9.840 700
Plinth panel for Safety storage cabinet Q90.195.60.WDAC	1	9.840 699

1



9.840 681

2



9.840 682

1

9.840 696

Safety Storage Cabinets S-PHOENIX Vol. 2-90 with Folding Doors

- safe and approved storage of hazardous materials in workrooms
- Approved according to EN 14470-1, fire resistance 90 minutes
- GS-approved
- outer body made of sheet steel in light grey (RAL 7035), interior with chemical resistant surface
- space saving folding doors, less required space in front of the cabinet while doors are open
- convenient handling - one-hand operation for double-door cabinets (AGT)
- standard door open arrest system holds doors open, safe and convenient storage and removal
- serial automatic door closing (TSA) releases arrested doors after approx. 60 seconds. Acoustic and visual signal before closing
- lockable doors with cylinder lock (integration into a locking system possible)
- adjusting aids for compensation of uneven floor
- ventilation connection (NW 75) in the cabinet ceiling

asecos

Model S90.196.120.FDAC and Model S90.196.060.FDAC with shelves:

Shelves, height adjustable (32 mm increments), load capacity 75 kg (evenly distributed load), bottom collecting sump with or without perforated insert as a first storage level
 Capacity bottom collecting sump: 33 litre (model width 1200 mm), 22 litre (model width 600 mm)

Model S90.196.120.FDAC and Model S90.196.060.FDAC with drawer:

Large storage capacity, optimal to maximize storage space, ideal for the storage of containers < 5 litre
 Model width 1200 mm: self-closing in the event of fire, load capacity: 60 kg (evenly distributed), capacity 30 litre
 Model width 600 mm: permanent self-closing, load capacity: 25 kg (evenly distributed), capacity 5 litre

Option:

- Recirculating air filter system with exhaust air monitoring (Cat. No. 9.840 650)
- Ventilation system with exhaust air monitoring (Cat. No. 6.238 986)
- Ventilation system without exhaust air monitoring (Cat. No. 9.840 616)

A wide variety of cabinet versions is available. Please enquire.

2

9.840 697

Specifications

Outer dimensions (W x D x H)

S90.196.120.FDAC: 1196 x 616 x 1968mm
 S90.196.060.FDAC: 596 x 616 x 1968 mm

Inner dimensions (W x D x H)

S90.196.120.FDAC: 1050 x 524 x 1742mm
 S90.196.060.FDAC: 450 x 524 x 1742mm

Shelf (W x D x H)

S90.196.120.FDAC: 1040 x 432 x 30mm
 S90.196.060.FDAC: 440 x 432 x 30 mm

Drawer (W x D x H)

S90.196.120.FDAC: 844 x 488 x 90mm
 S90.196.060.FDAC: 345 x 500 x 50mm

Weight

S90.196.120.FDAC: 420kg
 S90.196.060.FDAC: 260kg

Type	Description	Material	PK	Cat. No.
S90.196.120FDAC	3 shelves, perforated insert, 1 bottom collecting sump	steel	1	6.262 417
S90.196.120FDAC	3 shelves, 1 bottom collecting sump	steel	1	9.840 695
S90.196.120FDAC	4 shelves, 1 bottom collecting sump	steel	1	6.280 330
S90.196.120FDAC	5 shelves, 1 bottom collecting sump	steel	1	7.639 227
S90.196.120FDAC	6 drawers, 1 bottom collecting sump	steel	1	9.840 696 1
S90.196.120FDAC	3 shelves, perforated insert, 1 bottom collecting sump	stainless steel	1	6.286 226
S90.196.60FDAC	4 shelves, perforated insert, 1 bottom collecting sump	steel	1	7.639 691
S90.196.60FDAC	3 shelves, 1 bottom collecting sump	steel	1	9.840 697 2
S90.196.60FDAC	6 drawers, 1 bottom collecting sump	steel	1	9.840 698

Safety Storage Cabinets Q-CLASSIC-30 with Wing Doors

asecos

- safe and approved storage of hazardous materials in workrooms
- type proved according to EN 14470-1, fire resistance 90 minutes
- GS-approved
- outer body made of flame retardant, melamine coated special plates, door front made of sheet steel with structured paint finish, colour: body anthracite grey (similar to RAL 7016), doors light grey (RAL 7035), door colour pure white (RAL 9010) available on request
- easy handling with comfort: doors stop in any position, self-closing in the event of fire
- standard door open arrest system holds doors open, safe and convenient storage and removal
- integrated transport base for an easy indoor transport
- removable base cover with integrated adjusting aids optional
- lockable doors with cylinder lock (integration into a locking system possible)
- ventilation connection (NW 75) in the cabinet ceiling

Shelves, height adjustable (32 mm increments), load capacity 75 kg (evenly distributed load), bottom collecting sump with perforated insert as a first storage level. Capacity bottom collecting sump: 33 litre (model width 1200 mm), 22 litre (model width 600 mm)

Supplied with: Safety Storage Cabinet Q-CLASSIC-30 Model Q30.195.116 or Q30.195.056 incl. interior equipment with 3 shelves, bottom collecting sump with perforated insert

Option:

- Recirculating air filter system with exhaust air monitoring (Cat. No. 9.840 650)
- Ventilation system with exhaust air monitoring (Cat. No. 6.238 986)
- Ventilation system without exhaust air monitoring (Cat. No. 9.840 616)

A wide variety of cabinet versions is available. Please enquire.

Specifications

Outer dimensions (W x D x H)	
Q30.195.116:	1164 x 620 x 1947mm
Q30.195.056:	564 x 615 x 1947mm
Inner dimensions (W x D x H)	
Q30.195.116:	1050 x 519 x 1626mm
Q30.195.056:	450 x 519 x 1626mm
Shelf dimensions (W x D x H)	
Q30.195.116:	1040 x 432 x 30mm
Q30.195.056:	440 x 432 x 30mm
Weight	
Q30.195.116:	240kg
Q30.195.056:	146kg

Description	PK	Cat. No.
Safety Storage Cabinet Q30.195.116	1	9.840 693 1
Safety Storage Cabinet Q30.195.056	1	9.840 694 2

1



9.840 693

2



9.840 694

1



6.260 928

Safety Storage Cabinets S-CLASSIC-90 with Wing Doors

- safe and approved storage of hazardous materials in workrooms
- type proved according to EN 14470-1, fire resistance 90 minutes
- GS-approved
- outer body made of sheet steel, colour light grey (RAL 7035), interior with chemical resistant surface
- lockable doors with cylinder lock (integration into a locking system possible)
- adjusting aids for compensation for uneven floor
- ventilation connection (NW 75) in the cabinet ceiling
- standard door open arrest system holds doors open, safe and convenient storage and removal

asecos

Shelves, height adjustable (32 mm increments), load capacity 75 kg (evenly distributed load), bottom collecting sump with perforated insert as a first storage level. Capacity bottom collecting sump: 33 litre (model width 1200 mm), 22 litre (model width 600 mm).

Supplied with: Safety Storage Cabinet S-CLASSIC-90 Model S90.196.120.WDAS or S90.196.060.WDAS incl. interior equipment with 3 shelves, bottom collecting sump with perforated insert

Option:

- Recirculating air filter system with exhaust air monitoring (Cat. No. 9.840 650)
- Ventilation system with exhaust air monitoring (Cat. No. 6.238 986)
- Ventilation system without exhaust air monitoring (Cat. No. 9.840 616)

A wide variety of cabinet versions is available. Please enquire.

2



9.840 690

Specifications

Outer dimensions (W x D x H)

S90.196.120.WDAS:	1196 x 616 x 1968mm
S90.196.090.WDAS:	896 x 616 x 1968 mm
S90.196.060.WDAS:	596 x 616 x 1968 mm

Inner dimensions (W x D x H)

S90.196.120.WDAS:	1050 x 524 x 1742mm
S90.196.090.WDAS:	750 x 524 x 1742 mm
S90.196.060.WDAS:	450 x 524 x 1742mm

Shelf dimensions (W x D x H)

S90.196.120.WDAS:	1040 x 432 x 30mm
S90.196.090.WDAS:	740 x 432 x 30 mm
S90.196.060.WDAS:	440 x 432 x 30mm

Weight

S90.196.120.WDAS:	420kg
S90.196.090.WDAS:	310kg
S90.196.060.WDAS:	260kg

Description	PK	Cat. No.
Safety Storage Cabinets S90.196.120.WDAS, light grey*	1	9.840 689
Safety Storage Cabinets S90.196.120.WDAS, light grey	1	6.260 928 1
Safety Storage Cabinets S90.196.120.WDAS, warning yellow	1	6.270 910
Safety Storage Cabinets S90.196.090.WDAS, light grey	1	6.286 539
Safety Storage Cabinets S90.196.090.WDAS, warning yellow	1	6.286 540
Safety Storage Cabinets S90.196.060.WDAS, light grey*	1	9.840 690 2
Safety Storage Cabinets S90.196.060.WDAS, light grey	1	6.269 868
Safety Storage Cabinets S90.196.060.WDAS, warning yellow	1	6.286 542
shelf for S90.196.120.WDAS	1	9.840 532
shelf for S90.196.090.WDAS	1	6.286 541
shelf for S90.196.060.WDAS	1	9.840 514

*without perforated insert

We can **supply** this
manufacturer's
whole
product range !



1 2 Cabinets for Acids and Alkalis SL-CLASSIC with Wing Doors

- safe and approved storage of aggressive, non-flammable hazardous materials in workrooms
- robust construction and longevity, safety elements assembled outside the storage compartment for increased protection against corrosion, easy to clean
- safe storage with two hermetically separated storage compartments
- doors lockable with cylinder locking (integration in locking system possible)
- integrated adjusting aids to compensate for uneven floor
- integrated metal-free air ducts ready for connection (NW 75) to a technical exhaust system with only one extraction air inlet
- pull-out shelves: high quality and sturdy construction with removable plastic sump, load capacity 25 kg (evenly distributed load), capacity 15 litre

asecos

Supplied with: Cabinet for acids and alkalis SL-CLASSIC incl. interior equipment, Model SL.196.120.MV with 8 or 12 pull-out shelves, Model SL.196.060.MH with 4 or 6 pull-out shelves

A wide variety of cabinet versions is available. Please enquire.

Specifications

Outer dimensions (W x D x H)

SL.196.120.MV: 1197 x 603 x 1965 mm

SL.196.60.MH: 597 x 603 x 1965 mm

Inner dimensions (W x D x H)

SL.196.120.MV: 2 x 485 x 570 x 1869 mm

SL.196.60.MH: 2 x 485 x 570 x 914 mm

Weight

SL.196.120.MV: 160 kg

SL.196.60.MH: 125 kg

Description	PK	Cat. No.
Cabinets for acids and alkalis SL.196.120.MV, 8 pull-out shelves	1	9.840 691
Cabinets for acids and alkalis SL.196.120.MV, 12 pull-out shelves	1	9.840 701
Cabinets for acids and alkalis SL.196.060.MH, 4 pull-out shelves	1	9.840 692
Cabinets for acids and alkalis SL.196.060.MH, 6 pull-out shelves	1	9.840 702



Fire Resistant Gas Cylinder Cabinets G90 Series

- colour: grey RAL 7035
- exhaust air connection (NW75) on top of the cabinet
- adjusting aids to compensate for uneven floor
- large interior height of 1858mm (Model for two 10 litre bottles interior height of 1246mm)
- lead-through points for pipes, sensors etc. in the ceiling of the cabinet
- complete with mounting rails, rolling ramp, bottle retainer with ratchet straps

asecos

Approved and safe

- labelling in accordance with EN 14470-2, fire resistance of 90 minutes
- GS approved



6.261 842

Description	Dimensions (W x D x H) mm	Weight kg	PK Cat. No.	
			PK	Cat. No.
for two 10 litre bottles	600 x 615 x 1450	278	1	6.260 435
for one 50 litre bottle	600 x 615 x 2050	365	1	6.265 442
for two 50 litre bottles	600 x 615 x 2050	365	1	6.261 842
for two 50 litre bottles, with F90 glass-fronted wing door	600 x 615 x 2050	365	1	4.678 134
for three 50 litre bottles	900 x 615 x 2050	490	1	9.840 609
for four 50 litre bottles	1200 x 615 x 2050	610	1	9.840 608
for four 50 litre bottles	1400 x 615 x 2050	690	1	6.267 279
lateral cylinder retainer for 50 l gas cylinders, sheet steel powder-coated, height adjustable without tools			1	6.286 543
radial ventilator 230/400 V, IP 55, EX-Zone 2			1	6.253 657



1 Gas Cylinder Regulators

To EN ISO 2503. Valve body and cap made of high quality, hot-pressed brass. Provide sensitive adjustment of working pressure. Safety valve blows off upwards.

Type	Pressure bar	PK	Cat. No.
Argon/Carbon dioxide	0 - 1,5	1	7.650 159
Oxygen	0 - 10 / 16	1	9.223 701
Acetylene	0 - 1,5 / 2,5	1	9.223 705
Argon/Carbon dioxide	0 - 10 / 16	1	9.223 710
Compressed air	0 - 10 / 16	1	9.223 721
Compressed air	0 - 20 / 40	1	9.223 722
Hydrogen	0 - 1,5 / 2,5	1	9.223 730
Hydrogen	0 - 10 / 16	1	9.223 731
Nitrogen	0 - 10 / 16	1	9.223 741
Nitrogen	0 - 20 / 40	1	9.223 742
Propane	0 - 1,5 / 2,5	1	9.223 751
Propane with 1 pressure gauge	0 - 1,5 / 2,5	1	9.223 752
Helium	0 - 10 / 16	1	9.223 756
Test gas	0 - 10 / 16	1	9.223 771
Nitrous oxide	0 - 10 / 16	1	9.223 791



2 Gas Cylinder Supports

Aluminum, powder coated. For holding gas cylinders up to 230 mm diameter in a vertical position. For benches/worktops up to 60 mm thick. Rapid release, safety catch.

Usbeck

Type	PK	Cat. No.
Gas cylinder support	1	7.605 462



3 Steel Bottle Cart KKR-832/01 and KKR 820/1

Steel bottle cart with solid rubber tyres Ø 200 mm and powder coated black-silver. Bottle holder with chain protection. Wheels: metal rim, roller bearing.

Gorr

For	Type	PK	Cat. No.
50 l	KKR-832/01 for 1 flask	1	9.148 303
10 l	KKR-820/01 for 1 flask	1	9.148 304



pH-measurement	296
Paper, chopstick	296
Portable devices	299
Table devices	309
pH-Electrodes	315
Redox-Electrodes.....	322
Ion selective Electrodes	323
Electrode accessories	324
Buffer solutions	325
Conductivity measurement	329
Portable devices	329
Table devices	333
Electrodes	337
Solutions	339
Oxygen measurement	340
Devices	340
Electrodes and accessories.....	342
Multiparameter measurement	345
Devices	345
Balances	354
Pocket balances	354
Precision balances	358
Analytical balances	367
Other balances	375
Moisture balances	376
Weights.....	379
Accessories.....	381
Thermometers	385
Laboratory thermometers	385
Surface, Insertion thermometers	392
Temperature meters.....	399
Temperature data logger	402
Temperature-Humidity logger	408
Timing	414
Timers	414
Clocks	417
Climate and environment measurement	418
Hygrometer	418
Special climate meters	420
Density determination	425
Density meter	425
Pycnometer	427
Density meters.....	428
Viscosity determination	432
Viscosimeter	432
Material testing	437
Force measurement	437
Hardness measurement.....	438
Surface analysis	440
Analytical instruments and systems	443
Melting point determination	443

pH-measurement/Paper, chopstick

1

1 LLG-Universal indicator paper, rolls

For the determination of pH values. Plastic dispensing reel with 1 roll of 5m.

Range	Description	PK	Cat. No.
pH			
1 - 11	Dispensing reel with 1 roll	1	9.129 800
1 - 14	Dispensing reel with 1 roll	1	9.129 802
1 - 11	Refill packs with 3 rolls	3	9.129 801
1 - 14	Refill packs with 3 rolls	3	9.129 803

2

2 LLG-Universal indicator paper, strips

For determination of pH value. Vial with snap lid of 100 pre-cut indicator paper strips.

Range	Package contents	PK	Cat. No.
pH			
1 - 14	100 strips per vial with snap lid	100	9.129 805

3

3 Universal indicator papers

For determination of pH- value. Plastic dispensing reel with 1 roll of indicator paper and colour scale.

MACHERY-NAGEL

Range	Description	PK	Cat. No.
pH			
1 - 11	Dispensing reel with 1 roll	1	9.130 200
1 - 14	Dispensing reel with 1 roll	1	9.130 210
1 - 11	Refill packs with 3 rolls	3	9.130 203
1 - 14	Refill packs with 3 rolls	3	9.130 213

Further indicatorpapers available on request.

4

4 Special indicator papers

For determination of pH- value. Plastic dispensing reel with 1 roll of indicator paper and colour scale.

MACHERY-NAGEL

Range	Description	PK	Cat. No.
pH			
0,5 - 5,5	Roll 5 m	1	9.130 305
0,5 - 5,5	Refill packs with 3 rolls	3	9.130 306
5,5 - 9,0	Roll 5 m	1	9.130 325
5,5 - 9,0	Refill packs with 3 rolls	3	9.130 326

Further indicator papers available on request.

5

5 Indicator paper, Duotest

Roll length 5 m, 10 mm width. With two colour zones. Plastic box with 1 roll of indicator paper and colour scale. Duotest indicator papers combine two different indicator zones on a single strip. The zones are separated by a hydrophobic barrier, which effectively prevents mixing of the reaction colors, simplifying and precisely assigning the pH value.

MACHERY-NAGEL

Range	Description	PK	Cat. No.
pH			
1,0 - 12,0	Dispensing reel with 1 roll	1	9.130 344
1,0 - 4,3	Dispensing reel with 1 roll	1	9.130 356
3,5 - 6,8	Dispensing reel with 1 roll	1	9.130 359
5,0 - 8,0	Dispensing reel with 1 roll	1	9.130 347
7,0 - 10,0	Dispensing reel with 1 roll	1	9.130 362
9,5 - 14,0	Dispensing reel with 1 roll	1	9.130 363

3. Analytical measurement and testing pH-measurement/Paper, chopstick

1 Indicator paper, Tritest

For determination of pH-value.
Roll length 5m, 10mm width. With three colour zones, without hydrophobic zone.
Plastic container with 1 roll of indicator paper and colour scale.

MACHEREY-NAGEL

Range pH	Description	PK	Cat. No.
1 - 11	Dispensing reel with 1 roll	1	9.130 367
1 - 11	Refill packs with 3 rolls	3	9.130 368

1



2 Litmus paper

Litmus paper, available in blue, red and neutral.
Supplied in booklets of 100 strips, 10 x 70mm W x L.

MACHEREY-NAGEL

Measuring range	Type	Colour change	PK	Cat. No.
8.0 to 5.0	Litmus paper, blue	blue - red	100	9.130 112
5.0 to 8.0	Litmus paper, red	red - blue	100	9.130 116
5.0 to 8.0	Litmus paper, neutral	red - violett - blue	100	9.130 118

Also available as reel. Refill packs available separately.

2



3 LLG-Indicator paper sticks

For pH determination. Box of 100 indicator paper sticks of 80mm length.

Range pH	Package contents	PK	Cat. No.
0 - 14	50 sticks per pack	50	9.129 806
0 - 14	100 sticks per pack	100	9.129 807

3



4 LLG-Universal Indicator strips "Premium", in vial with snap lid

Flip-top vial is easy to open and close with one hand. The new LLG pH strips offer the utmost in convenience and ease of use in laboratory-grade testing. With a single colour match, and a 12 mm reagent pad, these universal pH strips (0.0-14.0) belong in every lab.

- pH measuring range: 0 - 14
- 12 mm matching area for quick matches,
- Flip-top vial stays closed when dropped, but is easy to open with one-hand.
- Vial keeps strips safe from the elements
- 1 pack (vial) of 100 strips

Range pH	Package contents	PK	Cat. No.
0 - 14	100 strips per vial with snap lid	100	9.129 808

4



5 pH-Fix indicator strips, universal

For determination of pH- value. Permanent colour. Non bleeding.

MACHEREY-NAGEL

Range pH	PK	Cat. No.
0.0 - 6.0	100	9.130 382
0 - 14	100	9.130 381
0 - 14 PT*	100	9.130 379
7.0 - 14.0	100	9.130 384

* PlopTop tube.

5



pH-measurement/Paper, chopstick

1



1 pH-Fix indicator strips, special

For determination of pH- value. Permanent colour. Non bleeding.

MACHEREY-NAGEL

Range pH	PK	Cat. No.
0,3 - 2,3	100	9.130 385
1,7 - 3,8	100	9.130 386
2,0 - 9,0 CE**	100	9.130 380
3,1 - 8,3 CE**	100	9.130 377
3,6 - 6,1 PT* CE**	100	9.130 378
3,6 - 6,1 CE**	100	9.130 387
4,0 - 7,0	100	6.280 450
4,5 - 10,0 CE**	100	9.130 383
5,1 - 7,2	100	9.130 388
6,0 - 7,7	100	9.130 389
6,0 - 10,0	100	9.130 392
7,5 - 9,5	100	9.130 390
7,9 - 9,8	100	9.130 391

* PlopTop tube.

2



2 Indicator paper, PEHANON®

For determination of pH-value in coloured solutions.
Supplied in packs of 200, 11 x 100mm W x L strips.

MACHEREY-NAGEL

Range pH	PK	Cat. No.
1 - 12	200	9.130 657
1,0 - 2,8	200	9.130 651
1,8 - 3,8	200	9.130 652
3,8 - 5,5	200	9.130 603
6,0 - 8,1	200	9.130 626

3



3 Special indicator strips

Non-bleeding. Supplied in packs of 100 strips.

Range pH	PK	Cat. No.
0.0 - 2.5	100	9.130 002
2.0 - 9.0	100	9.130 003
2.5 - 4.5	100	9.130 004
4.0 - 7.0	100	9.130 007
5.2 - 7.2	100	9.130 009
6.5 - 10.0	100	9.130 010
11.0 - 13.0	100	9.130 013

4



4 pH indicator strips

Non-bleeding. Ranges as indicated. Supplied in packs of 100 strips.

Range pH	Increments pH units	Type	PK	Cat. No.
0 - 14	1	Universal	100	9.130 001
0 - 6	0.5	Acilit	100	9.130 016
5 - 10	0.5	Neutralit	100	9.130 017
7.5 - 14	0.5	Alkalit	100	9.130 018

3. Analytical measurement and testing pH-measurement/Portable devices

1 2 LLG-pH Pen

Cost efficient pH tester, ideal for testing small amounts of liquid and in narrow vessels. The supplied storage container prevents the electrode from drying out.

- ATC from 0 °C to 50 °C
- Large, easy-to-read LCD display
- **3-point calibration**

Scope of supply: pH meter

Specifications

pH Measuring range:	0 ... 14
pH Accuracy:	±0.1
pH resolution:	±0.1
Dimensions with electrode (W x D x H):	36 x 20 x 210 mm
Dimensions electrode (diam. x L):	12 x 110 mm
Weight:	72 g
Power supply:	2 x 3 V CR2032 button cell
IP code:	IP 65
Warranty:	2 years

Type	PK	Cat. No.
LLG-pH Pen	1	6.263 690



3 4 LLG-pH Meter 5

The LLG-pH meter 5 is a very easy to use pH/mV/°C handheld meter. The pH value and temperature can be stored directly on the SD card (Excel file) or transferred directly from the pH meter to a PC via the RS-232 interface.

- Gel filled pH electrode with external temperature sensor with 1m cable
- BNC connector
- Automatic temperature compensation (ATC)
- Large, easy-to-read LCD display
- 3 point calibration
- Suitable for all standard SD cards with 1 to 16 GB

Please order batteries separately (6 x 1.5 V AA)
Optional: power cable, PC connection cable, PC software

Scope of supply: pH meter, pH electrode with temperature sensor, buffers pH 4 and pH 7, 4 GB SD-Memory card, transport case.

Specifications

Measuring range pH:	0 ... 14
pH resolution:	0.01
pH accuracy:	±0.02 + 2d
Ambient conditions:	0 ... 50 °C, max. 85 % r.H.
Temperature range electrode:	0 ... 60 °C
Dimensions (W x D x H):	68 x 177 x 45 mm
Weight:	490 g
Power supply:	6 x 1.5 V AA batteries/9 V mains adapter (optional)
IP code:	IP 51
Warranty:	3 years (1 year on the electrode)

Description	PK	Cat. No.
LLG-pH Meter 5	1	6.263 691



Accessories for LLG-pH meter 5

Description	PK	Cat. No.
Electrode + temperature sensor for LLG-pH meter 5	1	6.263 692
SD card 4GB for LLG-pH meter 5	1	6.263 693
Case for LLG-pH Meter 5	1	6.263 694
Power cable for LLG-pH Meter 5	1	6.263 695
Connecting cable PC for LLG-pH Meter 5	1	6.263 696
Software for LLG-pH Meter 5	1	6.263 697

1



1 pH Meter PAL-pH

NEW

ATAGO

For the pH measurement this droplet type pH meter only needs 0.6 ml of sample. Suitable for e.g. foods, soil, water-soluble cutting oil or alkaline cleaning liquid.

- Quick measuring results in 3 seconds
- Unconsumable KCl due to internal electrode liquid
- Completely flat measurement unit allows easy cleaning
- 100 measured data can be wirelessly transferred via near field communication (NFC)

Specifications

Measuring range	0 ... 14 pH
Resolution:	0.01 pH
Accuracy:	±0.10 pH (2.0 ... 12.0 pH)
Calibration points:	at 4.01 pH, 6.86 pH, 9.18 pH
Temperature compensation:	0.0 ... 50.0 °C
Dimensions (W x D x H):	66 x 31 x 109 mm
Power supply:	2 x AAA alkaline batteries
IP code:	IP 65

Type	PK	Cat. No.
PAL-pH	1	6.312 228

2



2 pH tester PHX 800

ebro

- Housing made of ABS
- Automatic switch-off after 15 minutes
- Hold-function
- Auto-lock-function
- Automatic deactivation
- Battery level indicator
- Exchangeable battery
- Robust
- Waterproof
- Adjustable

Specifications

Measuring range:	0 to 14pH
Accuracy:	±0.1pH
Resolution:	±0.2pH
Operating temperature:	0 to +50°C
Storage temperature:	-25 to +60°C
Battery:	4 x 1.5V A76/LR44
Battery lifetime:	approx. 150 hours
Dimensions (W x L x H):	170 x 32 x 15mm
Weight:	approx. 70 g
IP code:	IP 65

Type	Description	PK	Cat. No.
PHX 800	pH tester	1	6.266 914

3



3 Pocket pH testers Eutech™ EcoTestr

Thermo Scientific

Valuable and waterproof pH testers, easy to use. Suitable for general and industrial purposes, e.g. in laboratories, pools, aquariums and cooling towers.

- Sensor protective cap can be used as a container for samples
- Easy battery change
- Auto-calibration and auto-buffer recognition
- Up to 3 calibration points (only EcoTestr® pH 2)
- Water and dustproof housing
- Long-lasting, fixed sensor
- Automatic temperature compensation (only EcoTestr® pH 2)
- Hold function freezes last reading temporarily

Specifications:

Range:	0.0 ... 14.0 pH
Resolution:	0.1 pH
Accuracy:	±0.1 pH
Protection class:	IP 67
Power supply:	4 x 1.5 V A76 batteries

Type	PK	Cat. No.
EcoTestr pH 2	1	6.233 465

1 Tester Expert pH

Simultaneously measure pH and temperature with a pocket sized tester designed to provide accurate measurements on the go for a variety of applications.

Thermo Scientific

- Large 4 digit double line display
- Display of battery life, status and recalibration
- Automatic temperature compensation (ATC)
- Automatic buffer recognition and calibration
- Auto-power-off

Specifications

pH range:	0 ... 14
Resolution:	0.1
Accuracy:	±0.1
pH calibration points:	1 to 3 points
Temperature range:	0 ... 50 °C
Resolution:	0.1 °C
Accuracy:	±0.5 °C + 1 digit
Operating temperature:	5 ... 45 °C
Dimensions (W x L x H):	43 x 170 x 30 mm
Weight:	90 g
Power supply:	Incl. 4 batteries (A76 or LR44 equivalent)
IP code:	IP 67
Warranty:	1 year



Type	PK	Cat. No.
Expert	1	6.284 896

2 pH Pocket Tester Elite pH/Elite pH Spear

Simultaneously measure pH and temperature with a pocket sized tester designed to provide accurate measurements on the go for a variety of applications. The Pocket Tester Elite pH has a leakproof, transparent wide-base cap for upright standing with fill line indicator. The Elite pH Spear pocket tester features a spear tip open pore sensor. This rugged and user-friendly tester is ideal for direct measurement of solid or semi-solid samples.

Thermo Scientific

- 1-push calibration
- Large 4-digit double line display
- Backlit graphic display
- Auto-hold readings
- Easy-to-operate, intuitive keypad
- Auto-off

Scope of supply:

Elite pH and Elite pH Spear: Tester incl. batteries and lanyard

Elite pH Kit and Elite pH Spear Kit: Tester incl. batteries, lanyard, soft carry case, buffer sachets set (pH 4.01, 7.00, 10.01, deionized water, 5 x 20 ml each)

Specifications

pH range:	-1.00 to 15.00
Resolution:	0.01 pH
Accuracy:	±0.01 pH ±1 LSD
pH calibration points:	1 to 3 points
Temperature range:	0 to 60 °C
Resolution:	0.1 °C
Accuracy:	0 to 50 °C (±0.5 °C + 1 LSD) 5 to 60 °C (±1.0 °C + 1 LSD)
Operating temperature:	5 to 45 °C
Relative humidity:	5 to 85 %, non-condensing
Temperature compensation Elite pH/pH Spear:	ATC/MTC
Dimensions (W x L x H) Elite pH/pH Spear:	200 x 45 x 36 mm/280 x 45 x 36 mm
Weight Elite pH/pH Spear:	160 g/150 g
Power supply:	4 x AAA 1.5 V batteries
IP code:	IP 67



6.290 131



6.290 136

Type	PK	Cat. No.
Elite pH	1	6.290 131 2
Elite pH Kit	1	6.290 137
Elite pH Spear	1	6.290 136 3
Elite pH Spear Kit	1	6.290 142

pH-measurement/Portable devices

1



6.222 767

Pocket tester Eutech™ pHTestr/pH Spear, waterproof

Thermo Scientific

Waterproof, rugged pH testers with one hand operation for general and industrial purposes, e.g. frequent testing of pools, aquariums, cooling towers, in the chemical industry and food processing.

- Large LCD display
- Easy maintenance and cleaning
- Waterproof and dustproof housing
- User-replaceable, rugged sensor
- Double junction sensor, pHTestr 10BNC only with BNC connector, without sensor
- Push-Button calibration with up to 3 points and Auto-Buffer recognition
- Buffer solutions USA 4.01/7.00/10.01 and NIST 4.01/6.86/9.18 usable
- Hold function, the last measured value remains on the display
- pHTestr 30, 10BNC and pH Spear with temperature display
- pH Spear tester with glass tip electrode for direct measurement of solid or semi-solid samples, e.g. in food processing
- Up to 500 hours operation time with single battery set

2



6.252 022

Specifications

pH range (pHTestr 10):	-1.00 -15.00 (-1.0 bis 15.0)
Resolution (pHTestr 10):	0.01 pH (0.1 pH)
Accuracy (pHTestr 10):	±0.01 pH (±0.1 pH)
pH calibration points:	3 points
Temperature range (only pHTestr 30, 10BNC, pH Spear):	0 to 50 °C
Resolution:	0.1 °C
Accuracy (only pHTestr 30):	±0.5 °C
Operating temperature:	0 to 50 °C
Temperature compensation (pHTestr 10BNC, pH Spear):	ATC (MTC)
Dimensions (B x L) (pH Spear):	165 x 38 mm (240 x 38 mm)
Weight (pH Spear):	90 g (103 g)
Power supply:	4 x 1.5 V A76 batteries
IP code:	IP 67

Type	PK	Cat. No.
pHTestr 30	1	6.222 767 1
pHTestr 20	1	6.902 406
pHTestr 10	1	6.223 017
pHTestr 10BNC	1	6.225 666
pH Spear	1	6.252 022 2

3



3 pH meter PHT 810

ebro

Portable pH meter with external electrode.

- BNC connection
- With automatic pH calibration
- Handy and robust
- Current value memory
- Simple calibration with keypad
- Electrodes for different applications
- Min/Max- and hold function

pH meter set contains: pH meter PHT 810, penetration electrode AT 206, punching pin, buffer solutions pH4 and pH7, KCl solution, carrying case, 2-point calibration certificate



Warning

H phrases: H315|H319

Specifications

Measuring range:	0 to 14pH
Accuracy:	±0.03pH
Resolution:	±0.01pH
Operating temperature:	0 to +50°C
Storage temperature:	-25 to +60°C
Battery:	Lithium 3V/1Ah
Battery lifetime:	approx.. 5 years
Dimensions (W x L x H):	54 x 110 x 22mm
Weight:	approx. 200g

Type	Description	PK	Cat. No.
PHT 810	pH meter (without electrode)	1	6.262 991
ST 1000	pH meter set	1	6.266 915

1 Electrodes for pH meter PHT 810

Plastic electrode AT 200: Housing material: Plastic, Diam.: 12mm, Length shaft: 120mm

ebro

Glass electrode AT 201: Housing material shaft: Glass, Diam. shaft: 12mm, Length shaft: 120mm

Penetration electrode AT 206 for measurements in semi-solid food stuff and other materials. Housing material: Glass, Diameter shaft/electrode: 25mm/5mm, Length shaft/electrode: 65mm/12mm, with 1m cable and BNC plug

Type	Description	PK	Cat. No.
AT 200	Plastic electrode for PHT 810	1	6.267 164
AT 201	Glass electrode for PHT 810	1	6.267 165
AT 206	Penetration electrode for PHT 810	1	6.252 036

1



pH meter Eutech™ pH150/pH450 series

The best value waterproof meter for measuring pH, mV and temperature.

Thermo Scientific

- Large, three line LCD, shows pH or mV measurement with temperature and % slope
- Built-in memory function, stores up to 150 measurements along with temperature
- Auto buffer recognition, automatically identifies USA, NIST or DIN buffer sets for rapid calibration
- Indication of necessary recalibration
- Power with AA batteries or use optional AC adapter
- Features mV offset, calibrate to a Redox/ORP standard or use for pH electrode diagnostics
- Ready indicator, manual or automatic measurement hold feature and optional automatic shutoff function
- % slope and temperature displayed with each measurement
- Includes innovative Grip-Clip™, quickly and easily secures the electrode to your beaker or container

Additional features PH450

- Backlit display
- Extended memory stores up to 500 data sets, easy USB or RS232 output with optional data cables
- Built-in real-time clock stamps storedata and calibration data with time and date, meets standards for GLP (Good Laboratory Practices)
- Ability to use ion selective electrodes

Scope of supply PH15002K and PH45002K: Meter with electrode, ATC probe, Grip-Clip™ electrode holder, 2 x AA batteries, hard carry case, pH buffers, storage solution, rinse solution

2



6.284 900

Specifications

pH range:	-2.00 to 16.00
Resolution:	0.01
Accuracy:	±0.01
pH calibration points:	Up to 5 points (USA & NIST), up to 6 points (DIN)
mV range:	±2000 mV
Accuracy:	±0.2 mV +2 digits or +0.5 % of reading
Temperature range:	-10.0 to +110.0 °C
Resolution:	0.1 °C
Accuracy:	±0.5 °C
Power supply:	incl. 2 x AA batteries, >700 h continuous use, AC adapter (optional)
Dimensions (W x L x H):	83 x 200 x 57 mm
Weight:	500 g
IP code:	IP 67
Warranty:	3 years on the meter

3



6.284 308

Type	Description	PK	Cat. No.
PH15000	Meter only	1	6.284 899
PH15002K	with double-junction pH electrode, ATC probe	1	6.284 900 2
PH45000	Meter only	1	6.284 901
PH45002K	with double-junction pH electrode, ATC probe	1	6.284 308 3

pH-measurement/Portable devices

1



6.280 112

pH meter FiveGo™ F2

Portable pH meter for field work and laboratories.

Mettler-Toledo Online

- Measurement made easy: A large, well-structured display, intuitive button arrangement and simple menu ensure measurements can be performed in just a few clicks.
- Ergonomic design for one handed operation: Thanks to its ergonomic design, handling the FiveGo™ is a comfortable experience. The foldable stand provides optimal viewing on flat surfaces.
- IP67 Water and dustproof: The IP67 waterproof protection makes the FiveGo™ portables able to withstand wet and demanding environments.

Scope of delivery:

- F2-Meter:** Meter only
- F2-Standard kit:** Meter with LE438 sensor
- F2-Food kit:** Meter with LE427 sensor and carrying case
- F2-Field kit:** Meter with LE438 sensor and carrying case

Specifications

pH	
Measuring range:	0.00 ... 14.00
Resolution:	0.01
Accuracy:	±0.01
mV	
Measuring range:	-1999...1999 mV
Resolution:	1 mV
Accuracy:	±1 mV
Temperature Compensation:	ATC and MTC
Calibration:	3 points, 4 predefined buffer groups
Memory size:	200 measurements, current calibration
Temperature	
Measuring range:	0 ... 100 °C
Resolution:	0.1 °C
Accuracy:	±0.5 °C
Dimensions (W x D x H):	188 x 77 x 33 mm
Protection class:	IP 67 (meter + electrode)

Type	PK	Cat. No.
F2-Meter	1	6.280 111
F2-Standard kit	1	6.280 112 1
F2-Field kit	1	6.280 113
F2-Food kit	1	6.280 114

2



6.243 880

3 pH/mV/°C Meter Eutech™ pH6+/pH5+ series

The pH6+ and pH5+ offer you the greatest value-for-money for your basic pH measurement needs. Both meters measure pH and Temperature, the pH6+ additionally measures mV/ORP. Rugged and user-friendly, these meters come with rubber boots for protection against harsh field elements.

Thermo Scientific

- 3-point-calibration with auto-buffer recognition
- Automatic temperature compensation (ATC)

Scope of delivery: Meter with Rubber Armour/Stand and plastic carrying case (except pH601+ and pH501+)

Specifications

pH range:	0.00 to 14.00 pH
Resolution:	0.01 pH
Accuracy:	±0.01 pH
pH calibration points:	1 to 3 points
mV range (pH6+ only):	±1000 mV
Accuracy:	±0.2 mV
Temperature range:	0.0 to 100.0 °C
Resolution:	0.1 °C
Accuracy:	±0.5 °C
Dimensions (W x L x H):	85 x 157 x 42 mm
Weight:	255 g
Power supply:	4 x 1.5 V AAA alkaline batteries, >200 h
IP code:	IP 54
Warranty:	3 years on the meter

Type	Description	PK	Cat. No.
PH603+K	with "3-in-1" pH/Temperature combi electrode	1	6.243 880 2
PH602+K	with single junction pH electrode, ATC probe	1	6.240 654
PH601+K	with ATC probe, stand and plastic carrying case	1	6.284 898
PH601+	with ATC probe	1	6.240 739
PH503+K	with "3-in-1" pH/Temperature combi electrode	1	6.244 042
PH502+K	with single junction pH electrode, ATC probe	1	6.240 492
PH501+	with ATC probe	1	6.262 080

3



pH-meter Seven2Go™ S2

Portable routine model for pH measurement

Mettler-Toledo Online

- New, intuitive menu structure with fast and easy T-Pad navigation in 12 languages
- Robust design with IP67 protection for use in harsh and demanding environments
- Intelligent Sensor Management (ISM®) functionality reduces the risk of errors
- Up to 5 point calibration with automatic buffer recognition and temperature compensation
- 4 predefined buffer groups and 1 user defined buffer group
- Automatic, manual and time dependant endpoint recording
- Data memory storage for 200 data points
- Power requirements: 4 x 1.5V AA or 1.3V NiMH accumulators

Items supplied:

S2-Meter: Instrument, electrode clip, operating instructions, quick guide, test certificate, declaration of conformity and batteries.

S2-Standard kit: As S2-Meter, but also with InLab Expert Pro-ISM-IP67, buffer sachets for pH 4.01, 7.00, 9.21 and 10.00.

S2-Field kit: As S2-Standard kit, but also with bottles for calibration and uGo™ carrying case.

S2-Food kit: As S2-Field kit, but with InLab Solids Pro-IP67 instead of InLab Expert Pro-ISM-IP67.

S2-Light kit: As S2-Standard kit, but with InLab Versatile Pro instead of InLab Expert Pro-ISM-IP67.



6.265 415

Specifications

pH

Measuring range: -2 to 20 pH
 Resolution: 0.01/0.1
 Accuracy: ±0.01

mV

Measuring range: -1999 ... +1999mV
 Resolution: 1
 Accuracy: ±1
 Relative mV-measurement: yes

Temperature

Measuring range: -5.0 ... 105.0°C
 Resolution: 0.1°C
 Accuracy: ±0.5°C
 Dimensions (W x D x H): 222 x 70 x 35mm

Type	PK	Cat. No.
S2-Meter	1	6.265 414
S2-Standard kit	1	6.265 415 1
S2-Field kit	1	6.265 416
S2-Food kit	1	6.265 417
S2-Light kit	1	6.265 418

Pocket pH meters ProfiLine Series

The WTW ProfiLine, hand-held, pH/mV meters are robust and waterproof, according to IP67. They have LCD or graphics displays. The proven DIN socket for connecting pH electrodes permits pH measurement even in wet environments. The instruments can be operated by standard alkaline or rechargeable batteries.

2 3 pH and redox meter pH 3110 ProfiLine

Make testing of pH and redox potential simple. Easy operation virtually eliminates errors. All function keys of the 3110 can be operated even when wearing gloves; automatic calibration and AutoRead functions ensure stable and reproducible results. The multifunctional display for pH, mV and temperature is always easy to read.

WTW®

Measuring ranges

pH: -2.0 ... +20.0
 -2.00 ... +20.0
 -2.000 ... +19.999
 Accuracy: ±0.01 pH (±1 digit)
 ±0.005 from +15 °C to +35 °C
 mV/Accuracy: ±1200.0/±0.3
 ±2000/±1
 Temperature: -5.0 to +105.0 °C
 Accuracy: ±0.1 °C
 Temperature compensation: Automatic via pH electrodes with integral temperature probe, TFK 325 or Pt1000



Type	Description	PK	Cat. No.
pH 3110	meter only	1	9.774 367
pH 3110 Set 2	case set including SenTix 41 and accessories	1	9.774 354

pH-measurement/Portable devices

1



1 2 pH meter pH 3310 ProfiLine

Convenient and versatile pH/mV meter with backlit graphics display and menu controlled operation. Waterproof and robust. With 5 point calibration for WTW technical or DIN/NIST buffers. Additional 20 pre-programmed buffer sets. The CMC function (Continuous Measurement Control) helps maintain the optimum measuring range and warns when limits are exceeded. The pH/mV handheld meter with integral, time controlled, data logger and memory for 5000 GLP compliant records is ideal for extended data collection. With 1 to 5-point pH calibration. Menu controlled, with backlit graphics display for comfortable and safe operation. 100% waterproof, USB interface for fast data transfer. Includes driver software and cable. WTW®

2



Measuring ranges

pH:	-2.0 ... +20.0
	-2.00 ... +20.00
	-2.000 ... +19.999
Accuracy:	±0.005 pH from +15°C to +35°C
mV/Accuracy:	±1200.0/±0.3 mV
	±2500/±1 mV
Temperature:	-5.0 to +105°C
Accuracy:	±0.1°C
Interface:	Mini USB-B
Memory:	5000 records (measured value, temperature, date, time, ID)

Type	Description	PK	Cat. No.
pH 3310	meter only	1	9.774 337
pH 3310 Set 2	case set including SenTix 41 and accessories	1	9.774 356

3



4.678 216

pH/Redox-Meter SD 305 pH

NEW
Lovibond®

Robust and waterproof hand-held meter for field use. For measurements in drinking water, cooling/boiler water, waste water, pool water and surface water.

- Automatic temperature compensation
- Buffer recognition of Lovibond® standards (pH 4.01/7.00/10.01) and buffers according to DIN 19266
- Choice between 1-, 2- or 3-point calibration
- Evaluation of the sensor quality after each calibration
- Alarm function with adjustable limits
- Auto hold function
- Battery status indicator
- Redox measurement in mV or mVH according to DIN 38404-6
- Data transfer and evaluation via software possible

Scope of supply:

SD 305 pH/ORP (Set 1): Instrument, protective covering with electrode holder, carrying case, pH/Temp. electrode Type 231, pH buffer solution (4.01/7.00/10.01), storage solution for pH/ORP electrodes, batteries, manual

SD 305 pH/ORP (Set 2): Instrument, protective covering with electrode holder, carrying case, pH/Temp. electrode Type 226, temperature probe Pt1000, pH buffer solution (4.01/7.00/10.01), storage solution for pH/ORP electrodes, batteries, manual

SD 305 pH/ORP (Set 3): Instrument, protective covering with electrode holder, carrying case, Redox electrode Type 242, temperature probe Pt1000, ORP control solution (470 mV), storage solution for pH/ORP electrodes, batteries, manual

Specifications

pH:	-2.000 ... 16.000
Accuracy:	±0.005
Temperature:	-5.0 ... 150 °C
Accuracy:	±0.2 °C
Redox (ORP):	-2000.0 ... 2000.0 mV
Accuracy:	±0.05 % FS (mV or mVH)
Datalogger:	10000 Data sets automatically
	1000 Data sets manually
Dimensions (W x D x H):	100 x 164 x 37 mm
Weight:	302 g
Power supply:	2 x AAA battery
IP code:	IP 67

Type	PK	Cat. No.
SD 305 pH/ORP (Set 1)	1	4.678 215
SD 305 pH/ORP (Set 2)	1	4.678 216 3
SD 305 pH/ORP (Set 3)	1	4.678 217

3. Analytical measurement and testing pH-measurement/Portable devices

1 pH-meter HandyLab 100

SI Analytics

The portable allrounder for pH/mV measurements. The HandyLab 100 increases the measuring speed and accuracy thanks to the AutoRead and the CMC function. AutoRead displays when the measuring value is stable and eliminates the risk of a premature reading of the faulty measuring value. CMC (Continuous Measurement Control) visualizes whether the measuring value is still within the calibration limits. Having storage capacity for up to 200 data sets, stored data can be viewed. The HandyLab 100 can process 1- to 5-point calibration with a choice of 22 stored buffer sets easily and comfortably.

Supplied with:

HL100Versatile: pH meter set HandyLab 100 with pH/T combination electrode A7780-NTC30-DIN-N for general applications

HL100Field: pH meter set HandyLab 100 with pH-T-electrode BlueLine 24 pH and reinforcement for on-site measurements



Specifications

pH	
Measuring range:	-2 ... 20 pH
Resolution:	±0.1/±0.01/±0.001 pH
Accuracy:	±0.005 pH
mV	
Measuring range:	-2500 ... +2500 mV
Resolution:	±1 mV
Accuracy:	±0.3 mV
Temperature	
Measuring range:	-5.0 ... +105.0 °C
Resolution:	±0.1 °C
Accuracy:	±0.1 °C

Type	PK	Cat. No.
HL100Versatile	1	6.265 283
HL100Field	1	7.910 240

2 pH meter HandyLab 700/750

SI Analytics

Portable pH measuring devices by SI Analytics with Memosens® technology offers increased safety and a user-friendly interface

- Durable design for daily measurements
- Connection: 2 x 4mm diam. for integrated or separate temperature sensor
- Contrast-rich and scratch-resistant clear glass LCD display
- Self-explanatory operation with one clear text line
- Display of the sensor status at one glance with Sensoface
- Calibration of up to 3 points with automatic buffer detection (from 10 buffers)
- Manual calibration by indicating random buffer values
- Real-time clock and display of battery charging status
- Extended operating time of more than 1.000 hours with standard batteries (4 x AA)

HandyLab 750 additional features:

- Store up to 5.000 data points.
- Micro-USB connection to communicate with the software HandyLab Pilot software for evaluation of data from digital Memosens® sensors.
- HandyLab Pilot software (included with delivery), allows easy management and evaluation of stored data and can be used for device configuration.

Supplied with: Set with pH meter, AquaLine 90pH, SKK K1A and DIN buffer solutions in ampoules

Specifications

pH measurement Memosens (also ISFET)	
Measuring range:	-2.000 ... +16.000pH
mV measurement Memosens Redox	
Messbereich:	-2000 ... +2000mV
pH/mV measurement (analog)	
pH measurement measuring range:	-2 ... 16pH
mV measurement measuring range:	-1300 ... +1300mV
Temperature measurement	
Measuring range with sensor NTC 30kOhm:	-20 ... +120°C
Measuring range with sensor Pt 1000:	-40 ... +250°C

Type	PK	Cat. No.
HL700AL90pH	1	6.266 645
HL750AL90pH	1	6.266 646



pH-measurement/Portable devices

1



6.265 259

pH/Ion-Meter Seven2Go™ pro S8

Mettler-Toledo Online

Portable professional model for pH measurement

- New, intuitive menu structure with fast and easy T-Pad navigation
- Robust design with IP67 protection for use in harsh and demanding environments
- Intelligent Sensor Management (ISM®) functionality reduces the risk of errors
- New sunlight-proof screen guarantees screen readability even in direct sunlight
- New StatusLight gives a fast, visual confirmation showing if the meter is ready to measure or not
- Operating support for 12 languages with information shown in complete words and sentences
- Up to 5 point calibration with automatic buffer recognition and temperature compensation
- 8 predefined buffer groups and 1 user defined ion-standard
- Automatic, manual and time dependant endpoint recording
- Data memory storage for 2000 GLP data points with weatherproof Micro-USB connection for data export
- Power requirements: 4 x 1.5V AA or 1.3V NiMH accumulators

Items supplied:

S8-Meter: Instrument, LabX direct pH, USB cable, electrode clip, base accessory, operating instructions, quick guide, test certificate, declaration of conformity and batteries.

S8-Standard kit: As S8-Meter, but also with InLab Expert Pro-ISM-IP67 and buffer sachets for pH 4.01, 7.00, 9.21 and 10.00.

S8-Field kit: As S8-Standard kit, but also with bottles for calibration and uGo™ carrying case.

S8-Biotech kit: As S8-Field kit, but with InLab Routine Pro ISM (incl. cable) instead of InLab Expert Pro-ISM-IP67.

S8-Fluoride kit: As S8-Standard kit, but with perfectION Fluoride instead of InLab Expert Pro-ISM-IP67, without buffer sachets.

Specifications

pH

Measuring range: -2 to 20 pH
 Resolution: 0.001/0.01/0.1
 Accuracy: ±0.002

mV (rel. mV)

Measuring range: -2000 ... +2000 mV
 Resolution: 0.1/1
 Accuracy: ±0.1

Ion

Measuring range: 1.00e-09 ... 9.99e+09
 Resolution: 3 or 4 digits (auto-range)
 Accuracy: ±0.5%

Temperature

Measuring range: -5.0 ... 130°C (ATC)
 -30.0 ... 130°C (MTC)
 Resolution: 0.1°C
 Accuracy: ±0.2°C if T = 0°C ... 105°C
 ±0.5°C if T < 0°C or T > 105°C

Dimensions (W x D x H): 222 x 70 x 35mm

Units: mg/L, mmol/L, mol/L, %, ppm, pX

Type	PK	Cat. No.
S8-Meter	1	6.265 258
S8-Standard kit	1	6.265 259 1
S8-Field kit	1	6.265 260
S8-Biotech kit	1	6.265 261
S8-Fluoride kit	1	6.265 262

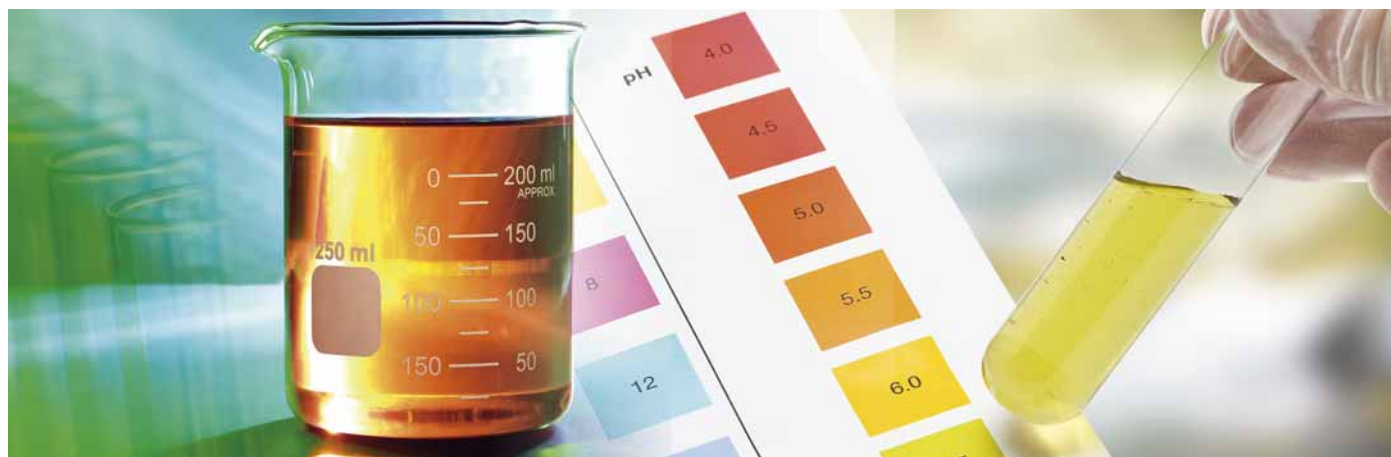

3. Analytical measurement and testing pH-measurement/Table devices

LLG pH meter 7

The LLG pH Meter 7 is an easy-to-use, robust table-top instrument for measuring pH and redox potential. The large color-touch-display and the intuitive, language-independent user interface ensure fast and easy use. Particularly suitable for routine applications in laboratories, production plants and schools.

- Available as set with gel combination electrode ("Made in Germany") with temperature sensor
- Large color-touch-display with language-independent graphical user interface
- Automatic temperature compensation
- Memory for 500 values
- 3-point calibration
- Reminder function for upcoming calibrations
- BNC connection for the electrode
- RS232 interface for data transfer
- Electrode holder can be mounted left and right

Scope of supply:

LLG pH meter 7: pH meter, electrode holder, protective cover, power supply unit

LLG-pH Meter 7 set: pH meter, combination electrode, electrode holder, protective cover, power supply unit



6.263 601

Specifications

pH range:	0 ... 14
pH resolution:	0,01
pH accuracy:	±0.01
Temperature range electrode:	0 ... 80 °C
Dimensions (W x D x H):	180 x 240 x 80 mm
Weight:	0.7 kg
Power supply:	9 V DC/1A
IP code:	IP 54
Warranty:	3 years

Type	Plug type	PK	Cat. No.
LLG-pH Meter 7	EU	1	6.263 600
LLG-pH Meter 7 set	EU	1	6.263 601 1
LLG-pH Meter 7	UK	1	6.263 606
LLG-pH Meter 7 set	UK	1	6.263 607
UK plug for LLG-pH Meter 7	UK	1	6.263 634

Suitable accessories can be found in our online shop.

pH meter LAB 845

Due to the intuitive operation and robust aluminum housing the pH-Meter LAB 845 is perfect for training and routine purposes.

SI Analytics

- Made in Germany
- USB Interface
- Data logger (storage of up to 4000 entries: Date, time, main measured value, secondary measured value, measured temperature) with adjustable interval
- Numerical password protection
- Selectable user language (German, English, French and Spanish)
- Configurable turn-off time
- Sturdy aluminium housing
- Graphic LCD display, backlit



6.270 548

Scope of supply: Stand, mains adapter, electrode as indicated and 6 DIN buffers (2 x pH 4.01, 2 x pH 6.87 and 2 x pH 9.18)

Specifications

	Measuring range // Resolution // Accuracy
pH:	0 - 14 // 0.01 // ±0.01 (±2 at calibration point)
mV:	-1999 ... 1999 mV // 1 mV // ±0.3 mV
ISE:	0 ... 30000 ppm
Temperature:	-10 ... 100 °C // 0.1 °C // ±0.1 °C
Temperature compensation:	automatic with PT1000 or fix temperature

Description	PK	Cat. No.
LAB 845 without electrode	1	6.270 548 2
Lab 845 set with BlueLine electrode BL19pH	1	6.281 380
Lab 845 set with BlueLine electrode BL25pH	1	6.281 620
Lab 845 set t with BlueLine electrode BL29pH	1	6.281 621

pH meters Eutech™ PH700/PH2700 series

Economical, user-friendly and accurate, the PH700 is the ideal choice for routine applications in laboratories, production plants and schools. The advanced PH2700 offers an easy to read screen that says more. View pH or ORP readings, with temperature, electrode status, calibration points, date and time all at once.

Thermo Scientific

- Large, easy-to-read display
- Ready indicator
- 5-point calibration with auto-buffer recognition
- Memory holds up to 100 data points
- Integral electrode holder

Additional features PH2700

- Up to 6-point calibration with auto-buffer recognition
- Quick, easy electrode diagnosis with multiple pH slopes and offset display
- Extended memory holds up to 500 data points, time and date-stamped for GLP compliance
- Alarm for re-calibration
- Auto-Log function for convenient continuous monitoring
- Password protection for setup and calibration

Scope of delivery: Meter with Integral Electrode Holder (except PH70040) and electrodes as indicated.

Specifications

pH700 // pH2700

pH range:	0.00 to 14.00 // -2.000 to 20.000
Resolution:	0.01 // 0.001
Accuracy:	±0.002
pH calibration points:	Up to 5 points // Up to 6 preset or 5 custom
mV range:	±1999 mV // ±2000 mV
Accuracy:	±0.2 mV (±199.9 mV) // ±2 mV (beyond)
Temperature range:	0.0 to 100.0 °C
Resolution:	0.1 °C
Accuracy:	±0.5 °C
Dimensions (W x L x H):	155 x 175 x 69 mm
Weight:	650 g
Power supply:	100-240 V adapter
IP code:	IP 54
Warranty:	3 years on the meter

Type	Description	PK	Cat. No.
PH70040	Meter only	1	7.910 491
PH70040S	Meter with Integral Electrode Holder	1	6.284 902
PH70042S	with pH Electrode, ATC Probe	1	7.910 099 1
PH70042GS	with Glass body, open pore pH electrode, ATC Probe	1	6.284 903
PH270040S	With RS232 cable	1	6.284 904 2
PH270042GS	With pH Electrode, ATC Probe, RS232 cable, pH Electrode Refill Solution	1	6.284 905

1



7.910 099

2



6.284 904

1 2 Laboratory instrument inoLab® pH 7110

Basic pH/mV laboratory instrument for all tasks where reliable, accurate readings are required quickly and easily. With large LCD segment display and easy-to-read keyboard. The AutoRead function ensures correct and repeatable measurement results. A built-in timer reminds the user of periodical calibration.

WTW®

Scope of supply: Instrument, mains power adapter, stand

Specifications

Ranges All values ±1 digit
 pH: -2.0 ... 20.0 ±0.1 pH
 -2.00 ... 20.00 ±0.01 pH
 -2.000 ... 19.999 ±0.005 pH
 mV: ±(1200.0 ±0.3) mV
 ±(2000 ±1) mV
 Calibration: 1-, 2- or 3 point WTW technical buffer or DIN/NIST
 Temperature: -5.0 ... 105.0°C ±0.1°C
 Power supply: Universal power supply 100 to 240V, 50/60Hz, 4 x 1.5V AA or 4 x 1.2V NiMH rechargeable batteries



Type	Description	PK	Cat. No.
pH 7110	Stand-alone instrument with DIN connection	1	9.920 090
pH 7110 BNC	Stand-alone instrument with BNC connection	1	9.920 093
pH 7110 SET 2	Instrument incl. SenTix® 41, buffer 4.7 / 10.01 and 3 mol/l KCl	1	9.920 091
pH 7110 SET 4	Instrument incl. SenTix® 81, buffer 4.7 / 10.01 and 3 mol/l KCl	1	9.920 092

3 Laboratory instrument inoLab® pH 7310

Reliable Documentation for pH measurement, if desired also available with built-in printer. A modern backlit graphic display with menu controlled user interface allows easy and intuitive operation. The mini USB-B interface provides fast data transfer to a PC. The internal memory can record up to 5000 GLP complying data including ID, date and time. The housing and the keypad are easy-to-clean. Up to five calibration points cover almost the complete pH range. A calibration history of the 10 last calibrations allows conclusions on the state of the sensor. An integrated thermal printer (58mm width) is ready for printout of the measured data (option). **Supplied with:** meter, power supply, stand and USB cable.

WTW®



Specifications

Ranges All values ±1 digit
 pH: -2.0 ... 20.0 ±0.1 pH
 -2.00 ... 20.00 ±0.01 pH
 -2.000 ... 19.999 ±0.005 pH
 mV: ±(1200.0 ±0.3) mV
 ±(2500 ±1) mV
 Temperature: -5.0 ... 105.0 °C ±0.1 °C
 Calibration: 1-, 2-, 3-, 4-, 5 point WTW technical. DIN, NIST and 20 additional buffer sets
 Calibration memory: Up to 10 calibrations recallable
 Display: LCD Graphic, backlit
 Memory: manual 200/5000 automatic
 Logger: manual/time controlled
 Interface: Mini USB-B
 Power supply: Universal power supply, 100 to 240V, 50/60 Hz, 4 x 1.5V AA or 4 x 1.2V NiMH

Type	Description	PK	Cat. No.
pH 7310	Meter only incl. accessories	1	9.920 100
pH 7310 Set 2	Meter incl. SenTix® 41 and accessories	1	9.920 101
pH 7310 Set 4	Meter incl. SenTix® 81 and accessories	1	9.920 102
pH 7310P	Meter incl. integrated printer	1	9.920 104
pH 7310P BNC	Meter with integrated printer, incl. accessories, BNC input	1	9.920 107
RP 58 HQ	Printer paper	1	6.252 725

pH-measurement/Table devices

1

pH meter FiveEasy™ pH F20/FiveEasy Plus™ pH FP20

FiveEasy™ and FiveEasy™ Plus benchtop meters provide high quality pH/mV measurements with the simple click of a button.

Mettler-Toledo Online

- Large, easy to read and easy to understand display with all information visible at a glance
- Five self-explanatory buttons making operation simple and easy
- Fast and easy connectivity for simple and secure data transfer (FP only)
- Electrode arm extension pole included

F20-Meter: Meter with CD operating instructions, QuickGuide, declaration of conformity, test certificate and power supply

F20-Standard: as F20-Meter, plus plastic LE438 3-in-1 pH electrode and 1 each x 4.01, 7.00 and 9.21 buffer sachets

FP20-Meter: Meter with CD operating instructions, QuickGuide, declaration of conformity, test certificate and power supply

FP20-Standard: as FP20-Meter, plus plastic LE438 3-in-1 pH electrode and 1 each x 4.01, 7.00 and 9.21 buffer sachets

FP20-Bio: as FP20-Meter, plus glass LE410 3-in-1 pH electrode and 1 each x 4.01, 7.00 and 9.21 buffer sachets

FP20-Micro: as FP20-Meter, plus glass LE422 micro pH electrode and 1 each x 4.01, 7.00 and 9.21 buffer sachets

FP20-TRIS: as FP20-Meter, plus glass LE420 pH electrode with moveable sleeve diaphragm and 1 each x 4.01, 7.00 and 9.21 buffer sachets



6.280 101

Specifications

Measuring range (Accuracy)

pH F20/FP20: 0.00 to 14.00pH/-2.00 to 16.00pH (±0.01pH)

mV: -2000 to 2000mV (±1mV)

Temperature F20/FP20: 0 to 100°C (0.5°C)/-5 to 105°C (0.3°C)

Input: BNC, Cinch (NTC 30kΩ)

Temperature compensation: ATC and MTC

Power supply: 100-240V/50-60Hz/12V DC

Calibration F20: 3 points, linear, 4 predefined buffer groups

Calibration FP20: 5 points, linear/segmented, 4 predefined buffer groups

FP20 only:

Memory: 200 measurements

Interface: RS232, USB, Reference input

Type	PK	Cat. No.
F20-Meter	1	6.280 100
F20-Standard Kit	1	6.280 101 ¹
FP20-Meter	1	6.280 102
FP20-Standard Kit	1	6.280 103
FP20-Bio	1	6.280 104
FP20-Micro	1	6.280 105
FP20-TRIS	1	6.280 106

We can **supply** this
manufacturer's
whole
product range !



1 pH meter SevenCompact™ S210

Mettler-Toledo Online

The SevenCompact™ pH meter S210 is the perfect choice for a wide range of applications. At the same time, working with the S210 is like child's play. Starting a measurement or calibration has never been easier, requiring only a single keypress.

- Fast and accurate measurements
- User-friendly operation
- Menu guidance in 12 languages
- Clear, well arranged color display
- Many peripheral options
- GLP compliant

Supplied with:

S210-Basic: Instrument, electrode holder, protective cover, operating instructions, quick guide, declaration of conformity and test certificate

S210-Kit: As per S210-Basic, additionally with InLab® Expert Pro-ISM, guide to pH measurements and 2 buffer sachets for pH 4.01, 7.00, 9.21 and 10.00.

S210-Bio: As per S210-Kit, but with InLab® Routine Pro-ISM cable kit instead of InLab® Expert Pro-ISM.

S210-U: As per S210-Kit, but with InLab® Versatile Pro instead of InLab® Expert Pro-ISM.



Specifications:

pH-range:	-2 ... 20
pH-relative accuracy:	±0.002
pH-resolution User-definable:	0.001/0.01/0.1
mV-range:	-2000.0 ... 2000.0
mV-relative accuracy:	±0.2
mV-resolution User-definable:	0.1/1
Temperature range	
MTC:	-30.0 ... 130.0 °C
ATC:	-5.0 ... 130.0 °C
Temperature accuracy:	±0.1 °C
Display:	4.3 inch, TFT color
Ext. power supply:	9-12V/10W
IP code:	IP 54

Type	PK	Cat. No.
S210-Basic	1	9.704 156
S210-Kit	1	9.704 157
S210-Bio	1	9.704 158
S210-U	1	9.704 159

Printers for Mettler Toledo instruments

Suitable for the following Mettler Toledo instruments:

Mettler-Toledo Online

RS-P25, RS-P26, RS-P28: SevenExcellence™, SevenCompact™, FiveEasy Plus™, SevenMulti™

RS-P25/USB-P25: SevenExcellence™

RS-P26, RS-P28: SevenGo pro™, SevenGo pro Duo™, Densito, Refracto, SevenEasy™

Supplied with: Printer, power cable (country specific), interface cable, paper roll (1 pcs), ribbon cartridge (1 pcs)

Features

- Built-in real-time clock, Zero/Tare key:
- Statistic application, totalling application:
- RS232 Schnittstelle:
- Printer unit:
- Ribbon cartridge:
- Paper roll:
- Print quality:
- Interface:
- Dimensions (W x D x H):
- Net weight:

For model

- RS-P26, RS-P28
- RS-P28
- RS-P25, RS-P26, RS-P28
- Dot matrix printer
- Exchangeable, black ink
- Standard paper 57.5 mm (W), max. Ø 60 mm
- Thermally stable and lightfast paper (GxP)
- RS232C, 9pin male connector or USB* (*SevenExcellence ONLY)
- 120 x 203 x 73mm
- 740g (paper roll included)

2



6.252 178

3



9.773 710

Type	PK	Cat. No.
RS-P25/USB-P25	1	6.252 178 2
RS-P26	1	6.251 155
RS-P28	1	9.773 710 3

pH-measurement/Table devices



1 pH/Ion meter SevenCompact™ S220

Mettler-Toledo Online

The colour display with its well-designed icons and menu settings in 10 languages makes operation genuinely intuitive. Applications range from routine measurements through sample analysis, data handling and data archiving in compliance with GLP regulations. Simply innovative design that meets the requirements for a universal, easy-to-operate pH/Ion meter.

- User friendly instrument for demanding users
- Security and high reproducibility thanks to Intelligent Sensor Management (ISM®)
- Improved quality of measurements through professional calibration support
- Comprehensive service package including IQ/OQ
- Integrated USB and RS232 interfaces for data exchange

Supplied with:

S220-Basic: Instrument, electrode holder, protective cover, operating instructions, quick guide, declaration of conformity and test certificate

S220-Kit: As per S220-Basic, additionally with InLab® Expert Pro-ISM, guide to pH measurements and 2 buffer sachets for pH 4.01, 7.00, 9.21 and 10.00.

S220-Bio: As per S220-Kit, but with InLab® Routine Pro-ISM cable kit instead of InLab® Expert Pro-ISM.

S220-U: As per S220-Kit, but with InLab® Versatile Pro instead of InLab® Expert Pro-ISM.

S220-Micro: As S220-Kit but with InLab® Ultra Micro instead of InLab® Expert Pro-ISM

S220-uMix: As S220-Kit but also including the uMix™ magnetic stirrer

Specifications:

pH-range:	-2.000 to 20.000
pH-relative accuracy:	±0.002
pH-resolution User-definable:	0.001/0.01/0.1
mV-range:	-2000.0 to 2000.0
mV-relative accuracy:	±0.2
mV-resolution User-definable:	0.1/1
Ion-Concentration range:	1.00E-9 to 9.99E+9
Ion-Concentration accuracy:	±0.5%
Temperature range	
MTC:	-30.0 to 130.0°C
ATC:	-5.0 to 130.0°C
Temperature accuracy:	±0.1°C
Display:	4.3 inch, TFT color
Ext. power supply:	9-12V/10W

Type	PK	Cat. No.
S220-Basic	1	9.704 160
S220-Kit	1	9.704 161
S220-Bio	1	9.704 162
S220-U	1	9.704 163
S220-Micro	1	6.284 504
S220-uMix	1	6.284 505

Accessories for Printers for Mettler Toledo instruments

Mettler-Toledo Online

Description	PK	Cat. No.
Normal paper	5	9.947 538
Paper roll adhesive	1	9.947 540
Ribbon cartridge, black	2	4.668 465



1 LLG pH electrode

Low maintenance combination electrode with integrated temperature sensor. Robust design with plastic shaft, protective basket and fixed cable connection. Made in Germany.

Specifications

Temperature range:	0 ... 80 °C
Temperature sensor:	NTC 30 kΩ
pH range:	0 ... 14
Diaphragm:	2 x ceramic
Membrane shape:	Cylindrical
Electrolyte:	Gel, 3M
Min. immersion depth:	15 mm
Cable length:	1 m
Length/Ø:	120/12 mm
Electrode connection:	BNC
Temperature sensor connection:	Cinch 3 mm

Type	PK	Cat. No.
LLG pH electrode	1	6.263 602



pH combination electrode, gel electrolyte, SenTix®

Basic pH combination electrodes, with plastic body, gel reference system. SenTix® 20 with plug head (AS/DIN or AS/BNC cable combination please order separately). WTW®
 Sentix 21-3 and Sentix 41-3 with 3 m fixed cable.

Specifications

Temperature range:	0 to 80 °C
pH range:	0 to 14 pH
Length/diam.:	120 mm/12 mm
Electrolyte:	Gel
Diaphragm:	Fibre
Membrane shape:	Cylindrical
Membrane resistance at 25°C:	1 GΩ

Type	Temperature sensor	Connector	Cable m	PK	Cat. No.
SenTix® 20	-	Plug-in head	-	1	9.040 851
SenTix® 21	-	DIN, waterproof	1	1	9.040 872
SenTix®21-3	-	DIN, waterproof	3	1	9.040 873
SenTix® 22	-	BNC	1	1	9.040 840
SenTix® 41	NTC 30 kΩ	DIN, waterproof	1	1	9.040 876 2
SenTix® 41-3	NTC 30 kΩ	DIN, waterproof	3	1	9.040 877
SenTix® 42	NTC 30 kΩ	BNC	1	1	9.040 841



9.040 876

pH combination electrodes, liquid electrolyte, SenTix®, refillable

Standard pH combination electrodes with glass shaft, non-solid electrolytes. With fixed cable (1m). SenTix® 60 with screw head (AS/DIN or AS/BNC cable combination please order separately). WTW®

Specifications

Temperature range:	0 to 100°C
pH range:	0 to 14pH
Length/diam.:	120/12mm
Electrolyte:	Liquid, KCl 3mol/l
Diaphragm:	Platinum
Membrane shape:	Conical
Membrane resistance at 25°C:	600 MΩ
Refill hole cover:	Slide

Type	Temperature sensor	Connector	PK	Cat. No.
SenTix® 60	-	Plug head	1	9.040 842
SenTix® 61	-	DIN, watertight	1	9.040 881
SenTix® 62	-	BNC	1	9.040 843
SenTix® 81	NTC 30 kΩ	DIN, watertight	1	9.040 886 3
SenTix® 82	NTC 30 kΩ	BNC	1	9.040 844



9.040 886

pH-measurement/pH-Electrodes



1 IDS pH electrodes SenTix® 940

Low maintenance pH electrodes with plastic shaft and gel electrolyte, with built-in temperature sensor NTC 30 kOhm. Cable length 1.5 m, SenTix® 940-3 with 3 m cable.

WTW®

Specifications

Temperature range:	0 ... 80 °C
pH range:	0 ... 14 pH
Length/diam.:	120 mm/12 mm
Electrolyte:	Gel
Diaphragm:	Fibre
Membrane shape:	Cylinder
Membrane resistance at 25°C:	< 1GΩ

Type	PK	Cat. No.
SenTix® 940	1	6.240 824
SenTix® 940-3	1	6.239 769



2 pH combination electrode, SenTix® H/SenTix® HW, refillable

Precision pH combination electrodes with glass shaft and liquid electrolyte. With plug head (AS/DIN or AS/BNC cable combination please order separately). SenTix® H for high alkaline solutions, SenTix® HW for low conductive samples.

WTW®

Specifications

Temperature range:	0 to 80 °C // 0 to 60 °C	SenTix® H // SenTix® HW
pH range:	0 to 14 pH	
Length/diam.:	170/12 mm	
Electrolyte:	Liquid, KCl 3 mol/l	
Diaphragm:	Ground joint	
Membrane shape:	Cylindrical	
Membrane resistance at 25°C:	2 GΩ // 800 MΩ	
Refill hole cover:	Slide	

Type	Temperature sensor	Connector	PK	Cat. No.
SenTix® H	-	plug head	1	9.040 845
SenTix® HW	-	plug head	1	7.058 767



3 pH electrodes, SenTix® SP, not refillable

pH electrodes with plastic shaft and liquid electrolyte. SenTix® SP with plug head (AS/DIN or AS/BNC cable combination please order separately). SenTix® SP-DIN with 1m-fixed cable. For penetration measurements.

WTW®

Specifications

Temperature range:	0 to 80°C
pH range:	2 to 13pH
Length // diam.:	65/25 mm // 15/5 mm
Electrolyte:	Polymer
Diaphragm:	Hole
Membrane shape:	Spear
Membrane resistance at 25°C:	400MΩ

Type	Temperature sensor	Connector	PK	Cat. No.
SenTix® SP	-	plug head	1	9.040 890
SenTix® SP-DIN	-	DIN	1	7.655 158



4 pH/ORP electrodes SensoLyt® ProcessLine

For the SensoLyt® armature, for the installation in a flow vessel or in a replacement fitting

WTW®

- For drinking water, wastewater or in the process
- Also for high pressure and temperature conditions
- Easy to maintain by easy measuring chain replacement

Type	Description	Range pH	PK	Cat. No.
SensoLyt® SEA	For strongly contaminated waste water	2 - 12	1	6.223 033
SensoLyt® SE	As SensoLyt® SEA, but without arming for installation	2 - 12	1	7.008 185
TA-SensoLyt® SEA	As SensoLyt® SEA, also for installation in TA-197 pH	2 - 12	1	9.774 218
SensoLyt® SEA-HP	For increased pressure/temperature conditions	4 - 12	1	7.656 875
SensoLyt® ECA	For normal contaminated wastewater	2 - 12	1	6.223 031
SensoLyt® EC	As SensoLyt® ECA, but without arming for installation	2 - 12	1	7.618 407
SensoLyt® DWA	For drinking water applications	0 - 14	1	6.223 010
SensoLyt® DW	As SensoLyt® DWA, but without arming for installation	0 - 14	1	6.222 876

IDS pH electrodes SenTix® 980

Precision pH electrodes with glass shaft and liquid electrolyte KCl 3 mol/l Ag+ free, with built-in temperature sensor NTC 30 kOhm. Cable length 1.5 m, SenTix® 980-P wireless-ready.

WTW®

Specifications

Temperature range:	0 ... 100 °C
pH range:	0 ... 14 pH
Length/diam.:	120 mm/12 mm
Electrolyte:	KCl 3 mol/l Ag+ free
Diaphragm:	Platinum wire
Membrane shape:	Cone
Membrane resistance at 25°C:	< 600 MΩ

Type	PK	Cat. No.
SenTix® 980	1	6.238 921 1
SenTix® 980-P	1	6.285 212



6.238 921

Accessories for combination electrodes

Connection cable for pH electrodes with plug head connection to plugs as indicated.

WTW®

Type	Connector	Cable m	PK	Cat. No.
AS/DIN	DIN	1	1	9.040 895 2
AS/DIN-3	DIN	3	1	9.040 896
AS/BNC	BNC	1	1	9.040 897



9.040 895

3 pH-electrodes, BlueLine, not refillable

Low-maintenance pH combination electrode with plastic body, Ag/AgCl reference system. With fixed cable, length 1 m (BlueLine 24 pH IDS 1.5 m, BlueLine 24-3 pH IDS 3 m). BlueLine 22 pH with plug head (LB 1A or LB 1BNC cable combination please order separately).

SI Analytics

Specifications

Temperature range:	-5 to 80°C
pH range:	0 to 14pH
Zero point:	pH=7.0 ±0.3
Length/diam.:	120mm/12mm
Electrolyte:	Gel
Diaphragm:	Fibre
Membrane shape:	Cylindrical
Membrane resistance at 25 °C:	400MΩ

Type	Temperature sensor	Connector	PK	Cat. No.
BlueLine 22 pH	-	Plug head	1	9.041 147
BlueLine 23 pH	-	DIN	1	9.041 148
BlueLine 24 pH	NTC 30 kΩ	DIN + Banana	1	9.041 149
BlueLine 24 pH IDS	NTC 30 kΩ	Digital plug	1	6.265 622
BlueLine 24-3 pH IDS	NTC 30 kΩ	Digital plug	1	6.265 623
BlueLine 25 pH	-	BNC	1	9.041 150
BlueLine 26 pH	NTC 30 kΩ	BNC + Banana	1	9.041 151
BlueLine 26 pH-Cinch	NTC 30 kΩ	BNC + Cinch	1	6.251 893
BlueLine 28 pH	Pt 1000	DIN + Banana	1	7.075 024
BlueLine 28 pH-P	Pt 1000	DIN + 2-mm-pin	1	6.204 522
BlueLine 29 pH	Pt 1000	BNC + Banana	1	6.261 445
BlueLine 29 pH-P	Pt 1000	BNC + 2-mm-pin	1	6.226 741



4 Spear-tip electrode, BlueLine 21 pH, not refillable

pH combination electrode with plastic body, Ag/AgCl reference system and spear membrane tip. BlueLine 21 pH IDS mit 1.5 m fixed cable and digital plug. BlueLine 21 pH with plug head. LB 1 A or LB 1 BNC cable combination please order separately. Particularly suitable for penetration measurements in semi-solid media.

SI Analytics

Specifications

Temperature range:	-5 to + 80°C
pH range:	2 to 13 pH
Temperature sensor:	No
Taper length // Dia. max./min.	65/25mm // 12/5mm
Electrolyte:	Referid®
Diaphragm:	Hole
Membrane resistance at 25 °C:	400 MΩ

Type	PK	Cat. No.
BlueLine 21 pH	1	9.041 146
BlueLine 21 pH IDS	1	6.265 621



pH-measurement/pH-Electrodes



9.041 140

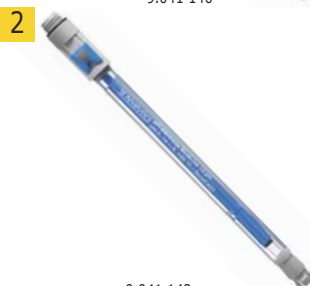

9.041 142

pH electrodes BlueLine, refillable

pH combination electrode with glass body, Ag/AgCl reference system. With fixed cable, length 1 m (BlueLine 14 pH IDS 1.5 m). BlueLine 11 pH and BlueLine13 pH with screw head (LB 1A or LB 1BNC cable combination please order separately).

SI Analytics

Specifications

Temperature range:	-5 to 100°C
pH range:	0 to 14pH
Zero point:	pH=7.0 ±0.3
Length/diam.:	120/12mm
BlueLine 13 pH:	170/12mm
Electrolyte:	Liquid, KCl 3mol/l
Diaphragm:	Platinum
BlueLine 13 pH:	Ground joint
Membrane shape:	Conical
BlueLine 13 pH:	Cylindrical
Membrane resistance at 25°C:	250MΩ
BlueLine 13 pH:	300MΩ
Refill hole cover:	Slide

Type	Temperature sensor	Connector	PK	Cat. No.
BlueLine 11 pH	-	Plug head	1	9.041 140 1
BlueLine 12 pH	-	DIN	1	9.041 141
BlueLine 13 pH	-	Plug head	1	9.041 142 2
BlueLine 14 pH	NTC 30 kΩ	DIN + Banana	1	9.041 143
BlueLine 14 pH ID	NTC 30 kΩ	DIN + 4-mm-banana, ID function	1	6.233 381
BlueLine 14 pH IDS	NTC 30 kΩ	Digital plug	1	6.265 620
BlueLine 15 pH	NTC 30 kΩ	BNC + Banana	1	9.041 144
BlueLine 15 pH ID	NTC 30 kΩ	BNC + 4-mm-banana, ID function	1	9.041 155
BlueLine 15 pH Cinch	NTC 30 kΩ	BNC + Cinch	1	6.240 767
BlueLine 17 pH	-	BNC	1	7.608 144
BlueLine 18 pH	Pt 1000	DIN + Banana	1	7.054 864
BlueLine 19 pH	Pt 1000	BNC + Banana	1	7.658 006
BlueLine 15 pH	NTC 10 kΩ	BNC + jack connector	1	7.672 009



3 pH combination electrodes with gel electrolyte

Low-maintenance pH combination electrode for use in water management and process chemistry. Not refillable.

SI Analytics

- With glass shaft and Silamid® reference
- Gel electrolyte with visible KCl reserve
- With factory test certificate 2.1 for pressure and temperature resistance

Scope of delivery: Electrode with screw plug head (Pg 13.5 installation thread), HD seal, connection cable.

Specifications

Temperature range:	-5 ... 80 °C
Pressure range	1 ... 12 bar
pH range:	2 ... 12
Length/diam.:	120 mm/12 mm
Electrolyte:	Gel
Diaphragm:	Ceramic
Membrane shape:	Sphere
Membrane resistance at 25 °C:	30 MΩ



9.041 120

Type	PK	Cat. No.
L7781 HD	1	7.070 780

pH-combination electrodes

With plug head, glass shaft, platinum diaphragm (N 64 with sleeve diaphragm), 3mol/l KCl electrolyte, Silamid® reference system and 12mm dia. spherical membrane.

SI Analytics

Type	Temp. range max. °C	Length mm	Membrane	Diam. mm	PK	Cat. No.
N 61	-5 ... +100	170	A-glass	12	1	9.041 100
H 61	+10 ... +100	170	H-glass	12	1	9.041 105
N 62	-5 ... +100	120	A-glass	12	1	9.041 110
H 62	+10 ... +100	120	H-glass	12	1	9.041 112
N 64	-5 ... +100	170	A-glass	12	1	9.041 120 4

pH-Electrodes ScienceLine plus



With glass shaft, Silamid®-reference system with silver ion barrier and double-electrolyte, electrolyte KCl 3 mol/l, banana plug. pH range 0 to 14 pH. SCPpHT-A170MF-3M-DIN-N additionally with ID function.

SI Analytics

Type	Temp. range max. °C	Length mm	Diam. mm	Membrane	Diaphragm type	Connector	Temperature sensor	Glass	PK	Cat. No.
SCPpHT-SP-A-3M-DIN-N	-5 ... 100	120	12/8	Spear	3 x Ceramic	DIN	Pt 1000	A	1	4.672 216 1
SCPpHT-SP-A-3M-BNC-N	-5 ... 100	120	12/8	Spear	3 x Ceramic	BNC	Pt 1000	A	1	4.672 217
SCPpHT-H170MF-3M-DIN-N	-5 ... 100	170	12	Sphere	Ceramic	DIN	Pt 1000	H	1	4.672 222
SCPpHT-A170MF-3M-DIN-N	-5 ... 100	170	12	Sphere	Platinum	DIN	Pt 1000	A	1	4.672 219
SCPpHT-A170MF-3M-BNC-N	-5 ... 100	170	12	Sphere	Platinum	BNC	Pt 1000	A	1	4.672 218
SCPpH-H120MF	-5 ... 100	120	12	Sphere	Platinum	Plug head	-	A	1	4.672 220 2
SCPpH-H170MF	-5 ... 100	170	12	Sphere	Platinum	Plug head	-	H	1	4.672 221
SCPpHT-MIC-AMF-3M-DIN-N	-5 ... 100	70/130	12/5	Cylinder	Platinum	DIN	Pt 1000	A	1	4.672 224 3
SCPpHT-MIC-AMF-3M-BNC-N	-5 ... 100	70/130	12/5	Cylinder	Platinum	BNC	Pt 1000	A	1	4.672 225
SCPpH-MIC-AMF	-5 ... 100	70/130	12/5	Cylinder	Platinum	Plug head	-	A	1	4.672 223



4 Cable combinations

For BlueLine pH electrodes, ScienceLine, IoLine and TopLine. Cable length: 1 m coaxial cable.

SI Analytics

Type	Connector	PK	Cat. No.
LB 1 A	DIN	1	9.041 303
LB 1 BNC	BNC	1	9.041 304
L 1 N	Banana, 4 mm	1	6.225 150
L 1 A	DIN	1	9.041 235
L 1 BNC	BNC	1	9.041 301



pH electrodes InLab® Routine Series

Combined pH electrode, glass shaft, ARGENTHAL™ reference with silver-ion trap, detachable cable. For InLab®Routine please order separately InLab® cable S7 and for InLab®Routine Pro and InLab®Routine Pro ISM please order separately InLab® cable MultiPin-BNC/RCA.

Mettler-Toledo Online

Specifications:
 Temperature range: 0 to +100 °C
 pH range: 0 - 14
 Electrode Dia.: 12 mm
 Electrolyte: Liquid, KCl 3 mol/l
 Diaphragm: ceramic
 Membrane resistance at 25 °C: < 600 M Ω
 Shaft length: min. 120 mm

Description	Temperature sensor	Electrode head	PK	Cat. No.
InLab® Routine	-	S7	1	9.041 450 5
InLab® Routine Pro	NTC 30 kΩ	MultiPin™	1	9.041 454 6
InLab® Routine Pt1000	Pt1000	MultiPin™	1	9.041 456
InLab® Routine Pro ISM	NTC 30 kΩ	MultiPin™	1	7.629 195
InLab® cable S7-BNC 1.2 m			1	9.041 613
InLab® cable MultiPin-BNC/RCA, 1,2 m			1	9.041 611 7



8 pH combination electrode InLab® Solids

With spear-tip membrane. With glass shaft, Argenthal™ reference system and S7 plug head. Cable - please order separately.

Mettler-Toledo Online

Specifications:
 Temperature range: 0 to +80°C
 pH range: 0 - 11
 Temperature sensor: no
 Length/Diam.: 25mm/6mm
 Electrolyte: XEROLYT® PLUS polymer electrolyte, non-refillable
 Diaphragm: open junction
 Membrane resistance at 25 °C: < 250 M Ω

Type	Connector	Temperature sensor	PK	Cat. No.
InLab® Solids	S7	-	1	9.041 553
InLab® Solids Pro-ISM	MultiPin™	NTC 30 kΩ	1	9.041 555
InLab® Solids Go-ISM	BNC/RCA IP67	NTC 30 kΩ	1	6.270 667



pH-measurement/pH-Electrodes



1 pH electrode InLab® Micro

pH-combination electrode with glass shaft, ARGENTAL™ reference system with Ag⁺ trap and S7 electrode head. Cable - please order separately.

Mettler-Toledo Online

Specifications

Temperature range:	0 to +80°C
pH range:	0 - 14
Temperature sensor:	no
Length/Diam.:	60mm/3mm
Electrolyte:	Fluid, KCl 3mol/l
Diaphragm:	Ceramic type Z (pore size 0.9µm)
Membrane resistance at 25 °C:	< 1000MΩ

Type	PK	Cat. No.
InLab® Micro	1	9.041 560



2 pH electrodes InLab® 413

For portable applications in the lab and outdoors, robust and maintenance-free. pH-combination electrode with chemically resistant PEEK shaft, ARGENTAL™ reference system. Fixed BNC/RCA (Cinch) cable. InLab® 413 IP67 with MultiPin™ electrode head.

Mettler-Toledo Online

Specifications

Temperature range:	0 to +100 °C
pH range:	0 - 14
Temperature sensor:	NTC 30 kΩ
Length/Diam.:	120 mm/12 mm
Electrolyte:	XEROLYT® polymer
Diaphragm:	double open junction
Membrane resistance at 25 °C:	< 250 MΩ
IP code:	IP67

Type	Connector	Cable m	PK	Cat. No.
InLab® 413 SG Expert Go	BNC / RCA (Cinch)	1,8	1	6.233 316
InLab® 413 IP67	BNC / RCA (Cinch)	1,2	1	6.900 314



pH electrodes InLab® Expert Pro

pH-combination electrode with chemically resistant PEEK shaft, ARGENTAL™ reference system. Fixed BNC/RCA (Cinch) cable.

Mettler-Toledo Online

InLab® Expert Pro ISM for SevenCompact and SevenExcellence.

Specifications

Temperature range:	0 to +100°C
pH range:	0 - 14
Temperature sensor:	NTC 30kΩ
Length/Diam.:	120mm/12mm
Electrolyte:	XEROLYT® polymer
Diaphragm:	open junction
Membrane resistance at 25 °C:	< 250MΩ

Type	Connector	Temperature sensor	Cable m	PK	Cat. No.
InLab® Expert Go-ISM	BNC/RCA IP67	NTC 30 kΩ	1,8	1	7.626 196
InLab® Expert	S7	-	-	1	9.041 500
InLab® Expert Pro-ISM	BNC/RCA	NTC 30 kΩ	1,2	1	9.041 508
InLab® Expert Pro	BNC/RCA	NTC 30 kΩ	1,2	1	9.041 506 3
InLab® Expert DIN	DIN 19262 / 4 mm	Pt1000	1,2	1	9.041 503
InLab® Expert NTC30	MultiPin™	NTC 30 kΩ	1,2	1	9.041 504

9.041 506



4 pH electrode InLab® Micro Pro ISM

pH-combination electrode with glass shaft, ARGENTAL™ reference system with Ag⁺ trap and MultiPin™ electrode head. Cable - please order separately.

Mettler-Toledo Online

Specifications

Temperature range:	0 to +100°C
pH range:	0 - 14
Temperature sensor:	NTC 30kΩ
Length/Diam.:	130mm/5mm
Electrolyte:	Fluid, KCl 3mol/l
Diaphragm:	Ceramic
Membrane resistance at 25 °C:	< 300MΩ

Type	PK	Cat. No.
InLab® Micro Pro ISM	1	6.243 633

3. Analytical measurement and testing pH-measurement/pH-Electrodes

1 pH combination electrode LE 438

With epoxy body and gel electrolyte, fixed cable with BNC/Cinch connection. For simple measurements, particularly suitable for portable pH meters, with temperature sensor.

Mettler-Toledo Online

Electrolyte:	3 mol/L KCl sat. with AgCl as gel, non-refillable
Body length:	120 mm
pH:	0 to 14
Temperature:	0 to 80 °C
Temperature sensor:	NTC 30 kΩ

Type	Connection	PK	Cat. No.
LE 438	BNC / Cinch	1	9.041 400



2 pH electrode InLab® Science Pro ISM

pH-combination electrode with glass shaft, ARGENTAL™ reference system with Ag⁺ trap and MultiPin™ electrode head. Cable - please order separately.

Mettler-Toledo Online

Specifications

Temperature range:	0 to +100°C
pH range:	0 - 12
Temperature sensor:	NTC 30kΩ
Length/Diam.:	170mm/12mm
Electrolyte:	Fluid, KCl 3mol/l
Diaphragm:	movable glass sleeve
Membrane resistance at 25 °C:	< 600MΩ

Type	PK	Cat. No.
InLab® Science Pro ISM	1	9.041 472



3 pH electrode InLab® Pure Pro-ISM

For ion-weak samples like ultra-pure water, deionized water. pH-combination electrode with glass shaft, ARGENTAL™ reference system with Ag⁺ trap and MultiPin™ electrode head.

Mettler-Toledo Online

Cable - please order separately.

Specifications

Temperature range:	0 to +80 °C
pH range:	0 - 11
Temperature sensor:	NTC 30 kΩ
Length/Diam.:	170 mm/12 mm
Electrolyte:	Fluid, KCl 3mol/l
Diaphragm:	Glass sleeve
Membrane resistance at 25 °C:	< 50 MΩ

Type	PK	Cat. No.
InLab® Pure Pro-ISM	1	7.629 193



Connection cables

For connecting pH electrodes with built-in temperature sensors and MultiPin plug head or with S7 plug head (without temperature sensor) as indicated. Cables suitable for a variety of other manufacturers meters.

Mettler-Toledo Online

Connector	Electrode head	Length m	PK	Cat. No.
DIN	S7	1.2	1	9.041 634 4
BNC	S7	1.2	1	9.041 613 5
2 mm	S7	1.2	1	9.041 662
4 mm	S7	1.2	1	9.041 661 6
-	S7	5.0	1	9.041 669
BNC/RCA	MultiPin™	1.2	1	9.041 611
BNC/1x4 mm	MultiPin™	1.2	1	6.282 405
DIN/RCA	MultiPin™	1.2	1	9.041 649
Lemo 00/2x4 mm	MultiPin™	1.2	1	9.041 650 7



pH-measurement/Redox-Electrodes



IDS ORP electrodes SenTix® ORP-T 900

Universel ORP electrodes with platinum disc for laboratory applications.

WTW®

Specifications

Measuring range:	-1250.0 ... +1250.0 mV
Working temperature range:	0 ... 100 °C
Length/diam.:	120 mm/12 mm
Electrolyte:	KCl 3 mol/l
Sensor:	Platinum
Diaphragm:	Ceramic

Type	PK	Cat. No.
SenTix® ORP-T 900	1	6.267 995 1
SenTix® ORP-T 900-P	1	7.644 433



2 Combined redox electrodes InLab®

Redox combination electrodes for measuring the oxidation/reduction potential in aqueous solutions. The signal is generated on the surface of the indicator electrode by an electron exchange with the oxidation/reduction system of the measured medium. Without temperature sensor.

Mettler-Toledo Online

With Safelock™ end ring for easy refilling of the reference electrolyte and complete sealing in closed position. For use with a wide variety of measuring instruments.

InLab® Redox: For general purpose. With platinum ring indicator electrode

InLab® Redox Pro: For emulsions, wastewater analysis and general purpose. With movable ground joint junction and platinum ring indicator electrode

InLab® Redox L: For large samples. With platinum ring indicator electrode

InLab® Redox Au: Combined redox electrode with gold ring indicator electrode

InLab® Redox Ag: Combined redox electrode with silver ring indicator electrode

InLab® Redox Micro: For small samples. With platinum ring indicator electrode

Please order connection cable separately.

Specifications

Temperature range:	0 ... 100 °C
Connection:	S7
Reference system:	Silver/silver chloride
Reference electrolyte:	3 mol/l KCl (InLab® Ag: 1 mol/l KNO ₃)
Type of junction:	Ceramic
Shaft material:	Glass

Type	Length mm	Shaft diameter mm	PK	Cat. No.
InLab® Redox	120	12	1	9.041 540
InLab® Redox Pro	120	12	1	9.041 541
InLab® Redox L	170	12	1	9.041 542
InLab® Redox Au	120	12	1	9.041 544
InLab® Redox Ag	120	12	1	9.041 545
InLab® Redox Micro	100	6	1	9.041 543



3 ORP electrodes SenTix® ORP, analogue

With glass shaft, Ag/AgCl reference system, connections for AS/DIN, AS/DIN-3, AS/BNC, S7 plug head.

WTW®

Specifications

Temperature range:	0 ... 100 °C
Length/Diam.:	120 mm/12 mm
Electrolyte:	KCl 3 mol/l
Sensor:	Platinum
Sensor shape:	Disc (4 mm)
Diaphragm:	Ceramic

Type	PK	Cat. No.
SenTix® ORP	1	7.050 767

Ion-selective electrodes

Combined ISE and GSE electrodes.

WTW®

Type	For	Measuring range	Range	Connector	Membrane	PK	Cat. No.
pH							
NH 500/2	Ammonium	0.02 ... 900 mg/l	4-12	S7	-	1	7.008 136
Ca 800	Calcium, Magnesium	0.02 ... 40000 mg/l 5 x 10 ⁻⁷ ... 1 mol/l	2.5-11	DIN	Matrix	1	6.803 397
Ag/S 800	Silver, Sulfide	0.01 ... 108000 mg/l 10 ⁻⁷ ... 1 mol/l	2-12	DIN	Solid state	1	6.226 445
Cl 800	Chloride	0.003 ... 32000 mg/l 10 ⁻⁷ ... 1 mol/l	2-12	DIN	Solid state	1	6.204 775
CN 800	Cyanide	2 ... 35000 mg/l 5 x 10 ⁻⁵ ... 1 mol/l	0-14	DIN	Solid state	1	7.634 542
CU 800	Copper, Nickel	8 x 10 ⁻⁶ ... 10 ⁻² mol/l 0.0006 ... 6400 mg/l	2-6	DIN	Solid state	1	7.620 500
K 800	Potassium	10 ⁻⁸ ... 10 ⁻¹ mol/l 0.04 ... 39000 mg/l	2-12	DIN	Matrix	1	7.624 548
Br 800	Bromide	10 ⁻⁶ ... 1 mol/l 0.4 ... 79000 mg/l	1-12	DIN	Solid state	1	6.225 474
F 800	Fluoride, Aluminium, Phosphate, Lithium	5 x 10 ⁻⁶ ... 1 mol/l 0.02 ... sat. mg/l 10 ⁻⁶ ... sat. mol/l	5-7	DIN	Solid state	1	7.615 487
NO 800	Nitrate	0.46 ... 2000 mg/l	2.5-11	DIN	Matrix	1	6.204 944
Na 800/S7	Sodium	0.01 ... 23000 mg/l	8-11	S7	Glass	1	6.313 274

1 Ion selective combination electrodes perfectION™

With integrated reference electrode. Easy cleaning of the diaphragm between measurements with Click & Clear™ (except Na electrode): by pressing the electrode head, the electrolyte solution flows through the diaphragm. The electrolyte can be easily emptied and refilled. Optimum contact between sample and electrolyte solution is always guaranteed.

Mettler-Toledo Online

Scope of delivery: Sensor with permanently connected 1.2 m cable with BNC connection, 60 ml reference electrolyte, operating instructions.

Scope of delivery Na-electrode: Sensor with S7 plug head, diaphragm made of glass with higher sensitivity to sodium, 25 ml reference electrolyte, operating instructions.



Type	Membrane	Measuring range mol / l	Temp. range max. °C	Range pH	PK	Cat. No.
F	Solid	10 ⁻⁶ ... saturated	0 ... 80	4.5 ... 5.5	1	6.239 828
Na	Na ⁺ glass	10 ⁻⁷ ... 1	0 ... 80	8 ... 11	1	6.239 927
Cl	Solid	5 x 10 ⁻⁵ ... 1	0 ... 80	2 ... 12	1	6.240 856
NO3	Polymer	7 x 10 ⁻⁵ ... 1	0 ... 40	2.5 ... 11	1	6.251 376
Ca	Polymer	5 x 10 ⁻⁷ ... 1	0 ... 40	2.5 ... 11	1	9.041 169
Ag/S2	Solid	10 ⁻⁷ ... 1	0 ... 80	2 ... 12	1	9.041 170
CN	Solid	8 x 10 ⁻⁵ ... 10 ⁻²	0 ... 80	10 ... 14	1	9.041 171
Cu	Solid	10 ⁻⁸ ... 0.1	0 ... 80	2 ... 12	1	9.041 172
I	Solid	5 x 10 ⁻⁸ ... 1	0 ... 80	0 ... 12	1	9.041 173
K	Polymer	10 ⁻⁶ ... 1	0 ... 40	2.5 ... 11	1	9.041 174
Pb	Solid	10 ⁻⁶ ... 0.1	0 ... 80	4 ... 7	1	9.041 175

2 Ion selective, gas-sensitive electrodes

Modular half cell with exchangeable diaphragm and S-7 plug head for determining the concentration of individual ions in aqueous solutions. Easy to use and require comparatively low expenditure on apparatus thereby offering advantages over wet chemistry and instrument analysis methods. Ion selective electrodes must be used in conjunction with a suitable reference electrode (InLab® Reference, cat no. 9.041 590).

Mettler-Toledo Online

Type	Measuring range mol / l	Temp. range max. °C	Membrane	PK	Cat. No.
Bromide DX280	1 to 10 ⁻⁶	0 to 80	Solid state	1	9.041 721
Chloride DX235	1 to 10 ⁻⁵	0 to 80	Solid state	1	9.041 723
Fluoride DX219	1 to 10 ⁻⁶	0 to 80	Solid state	1	9.041 725
Calcium DX240	1 to 10 ⁻⁶	0 to 50	Polymer matrix	1	9.041 730
Potassium DX239	1 to 10 ⁻⁶	0 to 50	Polymer matrix	1	9.041 731
Nitrate DX262	1 to 10 ⁻⁵	0 to 50	Polymer matrix	1	9.041 732
Ammonium DX218	1 to 10 ⁻⁶	0 to 50	Polymer matrix	1	9.041 733
Copper DX264	1 to 10 ⁻⁶	0 to 50	Polymer matrix	1	9.041 736
Sodium DX223*	1 to 10 ⁻⁷	0 to 60	Glass	1	9.041 735
NH3	10 ⁻² - 10 ⁻⁶	0 to 50	Foil	1	9.041 745
InLab® Reference		0 to 100		1	9.041 590

* Module not exchangeable.

Further ions sensitive electrodes on request.





6.252 026

Ammonia gas sensing ISE Electrode

Gas and ion selective electrode for determination of ammonia content in aqueous solutions. For rapid and precise measurement of ammonia.

Thermo Scientific

Scope of delivery: Waterproof BNC connector, 1 m cable, 20 loose membranes, preassembled outer body and membrane cap, 2 x 60 ml bottles of electrode filling solution, spout cap and tweezers.

Specifications

Concentration range:	0.01...17000 ppm ammonia (NH ₃) 0.01...14000 ppm nitrogen (N)
Temperature range:	0...50 °C
Electrode resistance:	<5000 MΩ
Length/∅:	150 mm/16 mm
Cable length:	1 m

Type	PK	Cat. No.
Ammonia ISE electrode 9512BNWP	1	6.252 026 1
Replacement membranes for 9512BNWP	3	6.260 763
Replacement membranes for 9512BNWP	20	6.252 027



7.659 280

Fluoride electrodes

For quick and easy measurement of fluoride ions in aqueous solutions. When using the half cell electrodes 9409BN and 9409SC, a separately available reference electrode is needed.

Thermo Scientific

Specifications

Measurement range:	0.02 ppm...saturated
Temperature range:	0...80 °C
Length/∅:	110 mm/13 mm
Cable length:	1 m

Type	Description	Electrode head	PK	Cat. No.
9409BN	Solid state, half cell	BNC	1	7.659 280 2
9409SC	Solid state, half cell	Screw cap	1	6.285 489
9609BNWP	Solid state, combination	BNC	1	6.091 369



3 LLG-Electrode stand for 3 electrodes

With cable duct. For three electrodes, 3 opening with diam. 16 mm. Additional opening for temperature sensor. Three joints for high flexibility and adjustment options.

Base plate:	105 x 125 mm
Base plate weight:	0.7 kg
Arm weight:	0.1 kg
Max. arm height:	320 mm

Type	PK	Cat. No.
LLG-Electrode stand	1	6.286 248



4 Electrode stand

With flexible electrode holder for two electrodes and temperature sensor.

WTW®

Type	PK	Cat. No.
Electrode stand	1	9.040 870



5 Electrode vessel Z 453

Free standing electrode vessel for storing electrodes with 12mm diam. shaft.

SI Analytics

Type	PK	Cat. No.
Z 453	1	7.624 578

3. Analytical measurement and testing pH-measurement/Buffer solutions

1 LLG-pH-Buffer solutions with colour coding in twin-neck dispensing bottles

The ready-to-use buffer solutions offer excellent quality, precision and advantages in use. The calibration vessel, integrated into the twin-neck dispensing bottles, allows the particularly economical dispensing of solution and prevents contamination.

Features

- Accuracy ±0.01, tested and certified at 25°C
- Temperature dependence data table printed on the label
- Traceable to NIST
- Shelf-life: 24 months (pH 7 and 10) or 36 months (pH 4) from date of production
- Colour-coded

pH-value at 25 °C	Colour	Capacity ml	PK	Cat. No.
4.00	red	250	1	9.040 868
7.00	yellow	250	1	9.040 869
10.00	blue	250	1	9.040 871



2 LLG-pH buffer solutions with colour coding

The ready-to-use colour coded LLG-pH buffer solutions offer excellent quality, precision and are designed to suit all end user requirements. Supplied in 1L bottles and conveniently colour coded to eliminate any risk of confusion between the 3 pH values.

- Accuracy ±0.01, tested and certified at 25 °C
- Temperature dependence data table printed on the label
- Traceable to NIST

pH-value at 25 °C	Colour	Capacity ml	PK	Cat. No.
4.00	red	1000	1	9.040 865
7.00	yellow	1000	1	9.040 866
10.00	blue	1000	1	9.040 867



3 LLG-pH-Buffer solution

Tested and certified at 20°C. Provided with label that gives the pH value at different temperatures. Tolerance ±0.02 pH. Supplied in HDPE containers. Traceable to NIST (SRM). Temperature dependence data is printed on the label as well as batch numbers and expiry dates. Buffers have a 24 month shelf life from date of manufacture.

pH-value at 20 °C	Buffer	Capacity ml	PK	Cat. No.
4.00	Citrate	1000	1	4.664 603
7.00	Phosphate	1000	1	9.041 368
9.00	Borate	1000	1	9.041 374
10.00	Borate	1000	1	9.041 369



4 pH buffer solutions

Clear, Colourless pH Buffer Solutions. Tested and ISO17025 Certified at 20 °C, supplied with a detailed Certificate of Analysis which outlines traceability to N.I.S.T. Temperature dependence data is printed on the label as are lot numbers and expiry dates. Containers made of HDPE.

Reagecon

pH-value at 20 °C	Accuracy (±)	Capacity ml	PK	Cat. No.
1,00	0,02	500	1	6.235 385
2,00	0,02	500	1	6.228 059
3,00	0,02	500	1	6.206 738
4,00	0,01	500	1	9.040 911
4,00*	0,01	500	1	4.011 211
5,00	0,10	500	1	4.011 214
6,00	0,01	500	1	6.203 561
6,80	0,01	500	1	6.206 693
7,00	0,01	500	1	9.040 913
8,00	0,01	500	1	4.011 221
9,00	0,01	500	1	6.225 161
10,00	0,01	500	1	9.040 915
11,00	0,05	500	1	4.011 226
12,00	0,05	500	1	6.234 641
13,00	0,05	500	1	6.230 322

* Phthalate free



pH-measurement/Buffer solutions

1



1 Buffer solutions

Sealed sachets in boxes as indicated. For single use only. Packaging ensures that buffer solution is always fresh, has not been used before and is not contaminated.

Mettler-Toledo Online



Warning

H phrases: H319

pH-value at 25 °C	Capacity Tolerance		PK	Cat. No.
	ml	± ml		
4.01/7.00/9.21	20	0.02	30	9.041 813
4.01/7.00/10.01	20	0.02	30	9.041 814
4.01	20	0.02	30	9.041 816
7.00	20	0.02	30	9.041 817
9.21	20	0.02	30	9.041 818
10.01	20	0.02	30	9.041 815

2



2 Standard buffer solutions

To DIN/NIST. Supplied in 250ml bottles. Tolerance ±0.02 pH.

WTW®



Warning

H phrases: H319

pH-value at 25 °C	Capacity ml	PK	Cat. No.
4.01	250	1	9.040 744
6.87	250	1	9.040 746
9.18	250	1	9.040 749
12.47	250	1	9.040 752

3



3 pH buffer solutions

Colour coded. pH values at 25°C. Provided with label that gives the pH value at different temperatures. Supplied in 250ml containers. Tolerance ±0.02 pH.

SI Analytics

pH-value at 25 °C	Colour	Capacity ml	PK	Cat. No.
7.00	green	250	1	9.041 051
10.01	orange	250	1	9.041 052

4



4 Cleaning solution



Warning

H phrases: H315|H319

WTW®

Type	Description	Capacity ml	PK	Cat. No.
RL-G	Cleaning solution for galvanic oxygen sensors	30	1	9.822 552

5



5 Electrolytes and cleaning solutions

Electrolytes are used as refill solutions for liquid filled electrodes as well as a storage solution for all types of pH electrodes. With the pepsin cleaning solution, you can remove protein precipitation from the diaphragm of electrodes with liquid electrolyte.

WTW®



Danger

H phrases: H290|EUH208

Type	Description	Capacity ml	PK	Cat. No.
KCl-50	Reference electrolyte, 3 mol/l KCl	50	1	7.059 778
KCl-250	Reference electrolyte, 3 mol/l KCl	250	1	7.008 211
PEP/pH	Pepsin cleaning solution	3 x 250	3	9.040 796

3. Analytical measurement and testing pH-measurement/Buffer solutions

1 Technical pH buffer solutions

Colour coded. Tested and ISO 17025 Certified at 25 °C. Uncertainty of measurement ±0.02 pH. Temperature dependence data is printed on the label as are lot numbers and expiry dates. These pH buffer solutions are suitable for use where very accurate measurements are required and are supplied with a detailed Certificate of Analysis which outlines traceability to N.I.S.T (the N.I.S.T SRM(s) Lot No. is stated on the certificate). This item has a 12 to 36 month shelf life from date of manufacture depending on pH value. Reagecon

pH-value at 25 °C	Colour	Capacity ml	PK	Cat. No.
2,00	Red	250	1	9.040 949
4,01	Red	250	1	9.040 950
7,00	Yellow	250	1	6.240 744
9,21	Blue	250	1	9.040 951
10,00	Blue	250	1	6.240 745
4,01	Red	500	1	6.206 907
7,00	Yellow	500	1	6.229 762
4,01	Red	1000	1	9.040 955
7,00	Yellow	1000	1	6.238 677
10,00	Blue	1000	1	6.238 676



2 Technical buffer solutions

Identified by colour-coded labels. Tolerance ±0.03 pH. WTW®

pH-value at 25 °C	Capacity ml	PK	Cat. No.
2.00	1000	1	9.040 721
4.01	50	1	9.040 734
4.01	250	1	9.040 727
4.01	1000	1	9.040 722
7.00	50	1	9.040 735
7.00	250	1	9.040 728
7.00	1000	1	9.040 723
10.01	250	1	7.401 072
10.01*	1000	1	9.040 725

* For handheld meters 315i, 330i, 340i, 350i, 3110, 3210, 3310, MultiLine® 3410, 3420, 3430, 3510, 3620, 3630 and Inolab® versions from 2004 onwards



3 Redox calibration solutions

To test redox (ORP) of electrodes. Supplied in bottles as indicated. Mettler-Toledo Online



H phrases: H314|H319

pH-value	Redox potential at 25°C	Volume	PK	Cat. No.
7	220 mV, U _{ref} = 427 mV	250ml	1	9.041 872
7	220 mV, U _{ref} = 427 mV	250ml	6	6.801 283
0.1	468 mV, U _{ref} = 675 mV	6 x 30ml	6	9.041 878



4 Redox buffer solution

For testing ORP electrodes. 427mV, pH7. Supplied in pack of 250ml. WTW®

Type	PK	Cat. No.
Redox	1	9.040 782



1



1 LLG-Electrolyte solutions, KCL

Potassium chloride electrolyte for pH electrodes - Filling solution for reference electrolyte.

Type	Capacity ml	PK	Cat. No.
3mol/l	1000	1	9.041 370
3mol/l	250	1	9.041 371
3mol/l, (AgCl saturated.)	250	1	9.041 372

2



2 KCL electrolyte solutions

For refilling or replacing reference electrolyte. Supplied in 250ml DURAN® bottles.

SI Analytics

Danger

H phrases: H225

Type	Description	Capacity ml	PK	Cat. No.
L 2114	2mol/L KNO ₃ + 0.001mol/l KCl for Ag-probes	250	1	9.041 072
L 3004	potassium chloride solution 3 mol/l, sterilized	250	1	9.041 092
L 3014	potassium chloride solution 3 mol/l, Ag/AgCl saturated	250	1	9.041 036
L 4204	potassium chloride solution 4.2 mol/l	250	1	9.041 033

3



3 Cleaning and storage solutions for pH-electrodes

Cleaning, rinse, regeneration and storage solution. Designed to extend the useful life of pH electrodes.

Reagecon

Danger

H phrases: H334

Type	Capacity ml	PK	Cat. No.
Pepsin / HCL, for protein removal	500	1	9.040 940
Organic cleaning solution	500	1	9.040 942
Electrode Storage solution	100	1	9.040 945
Electrode Storage solution	500	1	9.040 944
Electrode Storage solution	1000	1	6.226 124
Electrode Rinse solution	500	1	6.287 444

4



7.400 760

ISE reference electrolyte

Bridge electrode for reference electrodes as well as combined ISE electrodes of the 800 series for adaptation to the sample composition.

WTW®

Type	Description	PK	Cat. No.
ELY/BR/503	Standard electrolyte (Cl-free)	1	7.400 760 4
ELY/BR/503/N	Electrolyte for nitrate measurement	1	6.204 945
ELY/BR/503/K	Electrolyte for potassium measurement	1	6.250 333

ISE sample conditioning solutions

For sample preparation with pre-made ion strength adjuster solutions (ISA and TISAB) for the direct concentration determination with ion selective electrodes.

WTW®

Warning

H phrases: H315|H319

Type	For	Capacity ml	PK	Cat. No.
ISA/K	Potassium ions	250	1	6.204 398
TISAB	Fluoride measurement	1000	4	7.008 227
ISA/FK	Other suspended solids electrodes	250	1	7.008 228
ISA/Ca	Calcium ions	250	1	7.008 229
ISA/Ag	Silver and sulfide ions	1000	1	7.008 230
TISAB/NO3	Nitrate	1000	1	7.008 231
ISA/Na	Sodium	1000	1	7.008 232

1 Conductivity testers Expert CTS

For accurate measurement of conductivity, TDS, and salinity in one single instrument, making it an ideal solution for many applications.

Thermo Scientific

- Large 4 digit double line display
- Display of battery life, status and re-calibration
- Automatic temperature compensation (ATC)
- Auto conductivity buffer recognition and calibration
- Selectable TDS factor: 0.40 to 1.00
- Auto off

Specifications

Conductivity range:	0.00 ... 20.00 mS/cm
Resolution:	10 µS/cm below 2.00 mS/cm, 0.10 mS/cm above 2.00 mS/cm
Accuracy:	±2 % full scale ±1 LSD
TDS range:	0 ... 20000 ppm
Resolution:	10 ppm below 2000 ppm, 100 ppm above 2000 ppm
Accuracy:	±2% full scale ±1 LSD
Salinity range:	0 ... 10000 ppm
Resolution:	100 ppm
Accuracy:	±2 % of full scale ±1 LSD
Calibration points:	1 per parameter
Temperature range:	0 ... 50 °C
Resolution:	0.1 °C
Accuracy:	±0.5 °C + 1 digit
Operating temperature:	5 ... 45 °C
Dimensions (W x L x H):	45 x 170 x 30 mm
Weight:	90 g
Power supply:	Incl. 4 batteries (A76 or LR44 equivalent)
IP code:	IP 67
Warranty:	1 year

1



Type	PK	Cat. No.
Expert CTS	1	6.284 906

2 Salt Meter SSX 210

For determination of the relative salt content in fluid and semi-solid food products, such as meat, cold cuts, cheese, salads etc. The measurement is performed by determination of the electrical conductivity, as it is dependent on the salt content. Easy handling, robust and impact-resistant. With 2-conductor measuring probe with gold plated electrodes and silicone cable. Case included.

ebro

Specifications

Measuring range:	0 ... 100
Accuracy:	±1 digit
Resolution:	1 digit
Operating Temperature:	+10 ... 40 °C
Sample Rate:	1 ... 15 s, adjustable
Dimensions:	100 x 46 x 25 mm
Weight:	approx. 200 g
IP code:	IP 54
Power supply:	Lithium 3V/1Ah, Type CR2477

2



Type	PK	Cat. No.
Salt Meter SSX 210	1	6.228 196

Conductivity measurement/Portable devices

1



1 Conductivity meters Eutech™ CON6+

Thermo Scientific

Sturdy and economical, ease-of-use with high performance. The handy meter is IP54 splashproof and comes with a conductivity electrode with automatic temperature compensation function.

- 5-point-calibration with ±1% full scale accuracy
- Option of quick, easy automatic calibration or customised, near-to-sample manual calibration.
- Auto-Ranging for Conductivity/TDS measurements for fast response and best resolution over wide measurement range
- Easy-To-Read Display
- Available in kit version with plastic carrying case
- Auto off

Scope of supply: Meter with electrode, CON603+K additionally with conductivity carrying kit set (1 x 1413 µS, 12.88 mS, 84 µS KCL Standard Solutions and 1 x Deionised (Rinse) Water, 60 ml each).

Specifications

Conductivity range:	0 µS/cm to 200 mS/cm
Resolution:	0.05 % full scale
Accuracy:	±1 % of full scale ±1 LSD
Temperature range:	0.0 to 100.0 °C
Resolution:	0.1 °C
Accuracy:	±0.5 °C
Power supply:	4 x 1.5 V AAA alkaline batteries, >500 h
Dimensions (W x L x H):	85 x 157 x 42 mm
Weight:	255 g
IP code:	IP 54
Warranty:	3 years on the meter

Type	PK	Cat. No.
CON603+	1	6.281 845
CON603+K	1	6.263 037

2



6.280 116

Conductivity meter FiveGo™ F3

Mettler-Toledo Online

Portable conductivity meter for field work

- Measurement made easy: A large, well-structured display, intuitive button arrangement and simple menu ensure measurements can be performed in just a few clicks.
- Ergonomic design for one handed operation: Thanks to its ergonomic design, handling the FiveGo is a comfortable experience. The foldable stand provides optimal viewing on flat surfaces.
- IP67 Water and dustproof: The IP67 waterproof protection makes the FiveGo portables able to withstand wet and demanding environments.

Supplied with:

- F3-Meter:** Meter only
- F3-Standard kit:** Meter with LE703 sensor
- F3-Field kit:** Meter with LE703 sensor and carrying case

Specifications

Conductivity

Measuring range:	0.00 µS/cm ... 200 mS/cm
Resolution:	automatic range
Accuracy:	±0.5% of the measured value

Temperature

Measuring range:	0 ... 100 °C
Resolution:	0.1 °C
Accuracy:	±0.5 °C

TDS (Total Dissolved Solids)

Measuring range:	0.01 mg/l ... 200 g/l
Resolution:	automatic range
Temperature compensation:	Linear 0.00 ... 10.00 %/°C, reference temperature 20 and 25 °C
Calibration:	1 point, 3 predefined standards
Memory size:	200 measurements, current calibration
Dimensions (W x D x H):	188 x 77 x 33 mm
IP code:	IP 67 (meter + sensor)

Type	PK	Cat. No.
F3-Meter	1	6.280 115
F3-Standard kit	1	6.280 116 2
F3-Field kit	1	6.280 117

Conductivity meter Seven2Go™ S3

Portable routine model for conductivity measurement

Mettler-Toledo Online

- New, intuitive menu structure with fast and easy T-Pad navigation
- Robust design with IP67 protection for use in harsh and demanding environments
- Intelligent Sensor Management (ISM®) functionality reduces the risk of errors
- Easy 1 point calibration with option of manual cell constant entry
- 3 predefined standards and 1 user defined standard
- Automatic, manual and time dependant endpoint recording
- Data memory storage for 200 data points
- Power requirements: 4 x 1.5V AA or 1.3V NiMH accumulators

Supplied with:

S3-Meter: Includes instrument, electrode clip, operating instructions, quick guide, test certificate, declaration of conformity and batteries.

S3-Standard kit: As S3-Meter, but also with InLab 738-ISM and sachets of conductivity standards 1413 µS/cm and 12.88 mS/cm.

S3-Field kit: As S3-Standard kit, but also with bottles for calibration and uGo™ carrying case.

S3-Bioethanol kit: As S3-Field kit, but also with InLab 725 instead of InLab 738-ISM.

1



6.265 248

Conductivity

Measuring range: 0.010µS/cm ... 500mS/cm

Resolution: 0.001 ... 1 (auto-range)

Accuracy: ±0.5%

Temperature

Measuring range: -5.0 ... +105.0°C

Resolution: 0.1°C

Accuracy: ±0.2°C

TDS (Total Dissolved Solids)

Measuring range: 0.01mg/l ... 300g/l

Resolution: 0.01 ... 1 (auto-range)

Accuracy: ±0.5%

Specific resistance

Measuring range: 0.01 ... 100.0MΩcm

Salinity

Measuring range: 0.01 ... 42psu

Type	PK	Cat. No.
S3-Meter	1	6.265 247
S3-Standard kit	1	6.265 248 1
S3-Field kit	1	6.265 249
S3-Bioethanol kit	1	6.265 250

2 Conductivity meter CT 830

With automatic measuring range switching.

ebro

The meter is the ideal choice for determination of conductivity, salinity and temperature and combines the features for mobile application in the field with the precision and comfort of a laboratory meter. In the standard version the meter CT 830 is supplied with conductivity sensor AT 830 C and 1.50m cable. It is ideally suited for overall applications in the field and in laboratories. Two parallel, largely dirt-insensitive graphite electrodes, the integrated temperature sensor for parallel temperature measurement, an automatic temperature compensation and the wide measuring range are the benefits of the conductivity sensor.

Supplied with: Meter incl. conductivity sensor, calibration solution 0.1N/KCL 1288µs and case

Specifications

Measuring range

Conductivity: 0 to 200µS/0 to 20mS/0 to 500mS

TDS: 0 to 200mg/l/0 to 2000mg/l/0 to 20g/l/0 to 500g/l

Temperature: -10 °C to +100 °C

Display: 128 x 64 pixel, backlighted

Interface: USB with "Interface HMG USB", isolated

Ambient temperature: -10 °C to +55 °C

Rel. humidity: Max. <95% (non-condensing)

Connections: Connector BK for sensor (4-pole USB interface socket)

Housing: ABS

Dimensions (W x D x H): 200 x 40 x 95 mm

Batteries: 3 batteries Type AA, IEC R6, LR6, 1.5V

Protection class: IP 65

2



Type	Description	PK	Cat. No.
CT 830 Set	Conductivity meter incl. conductivity sensor AT 830 C	1	6.268 947
AT 830 C	C-sensor for CT 830, 3mm	1	6.268 948

1



4.678 226

Conductivity meter SD 325 CON

NEW

Lovibond®

The portable instrument with data logger is ideal for determining electrical conductivity in aqueous media. With a simple keystroke, further parameters such as TDS, salinity or resistance can be selected and conveniently read off. The selection of different measuring cells allow the determination of low (< 200 µS/cm) and very high conductivities (< 1000 mS/cm) with highest precision.

- Automatic recognition of conductivity standards
- Alarm function with adjustable limit values
- Auto hold function
- Selectable reference temperature (20 °C/25 °C)
- Automatic temperature compensation
- Battery status indicator
- Low power consumption
- Data transfer and evaluation via software possible

Scope of supply:

SD 325 CON (Set 1): Conductivity meter, protective covering, transport case, 4-pol graphite electrode (diam. 12 mm, < 200 mS/cm), conductivity standards, batteries, manual

SD 325 CON (Set 2): Conductivity meter, protective covering, transport case, 4-pol graphite electrode (diam. 16 mm, < 1000 mS/cm), conductivity standards, batteries, manual

SD 325 CON (Set 3): Conductivity meter, protective covering, transport case, 2-pol stainless steel electrode (diam. 10 mm, < 200 µS/cm, pure water), flow through cell for pure water, batteries, manual

Specifications

Conductivity:	0.000 ... 1000.0 mS/cm
Temperature:	-5.0 ... 100.0 °C
TDS:	0.000 ... 5000 mg/l
Resistance:	0.000 ... 50.0 MOhm/cm
Salinity:	0.0 ... 70.0 PSU
Datalogger:	10000 Data sets automatically 1000 Data sets manually
Interface:	USB
Dimensions (W x D x H):	100 x 164 x 37 mm
Weight:	302 g
Power supply:	2 x AAA batteries (incl.)
IP code:	IP 67

Type	PK	Cat. No.
SD 325 CON (Set 1)	1	4.678 226 1
SD 325 CON (Set 2)	1	4.678 227
SD 325 CON (Set 3)	1	4.678 228

Pocket conductivity meters ProfiLine

The ProfiLine hand-held conductivity meters have a waterproof (IP 67) housing and a completely sealed silicone membrane keypad with tactile feedback. A separate battery compartment allows easy exchange of standard alkaline, or rechargeable, batteries. The carefully laid out, large displays indicate the reading and other important information. The 3310 series meters have a backlit, graphics display and menu-controlled operation. A selection of application specific conductivity cells cover virtually all measurement tasks.

2



2 3 Conductivity meter ProfiLine Cond 3310

WTW®

Comfortable and versatile conductivity meter with integral, time controlled, data logger and 5000 GLP-compliant record memory for extended data collection. Menu controlled, with backlit, graphics display for comfortable, safe operation. Wide range of conductivity cells attachable. GLP-supporting functions, enhanced choice of cell constants, automatic and manual temperature compensation (which can be switched off) with linear and non-linear functions for pure water and natural waters acc. to EN 27888.

Specifications:

Measuring ranges/Resolution:	
Conductivity:	as Cond 3110, but additionally with 0.00µS/cm to 19.99µS/cm (when K=0.1cm ⁻¹) 0.000µS/cm at 1.999µS/cm (when K=0.01 cm ⁻¹)
TDS:	0 to 1999mg/l, 0.0 to 199.9g/l
Spec. resistance:	0.0 to 999MΩ/cm
Memory:	5000 records (measured value, temperature, date, time, ID)

3



Type	Description	PK	Cat. No.
Cond 3310	meter only	1	9.774 409
Cond 3310 Set 1	case set including conductivity probe TetraCon 325 and accessories	1	9.774 400

The inoLab® series from WTW

The inoLab® benchtops are perfectly designed for modern laboratory surroundings. The key pads are clearly outlined and easy-to-operate, their smooth surfaces are easy-to-clean and the operation is self-explanatory. All meters include a universal power supply and a convenient stand with sensor support. If desired they can be ordered in application oriented sets including sensors and accessories.

1 Laboratory instrument inoLab® Cond 7110

Modern conductivity measurement is easy to do. the inoLab® Cond 7110 has all important functions for measuring conductivity like adjustable reference temperature and different methods of temperature compensation. A big LCD segment display makes readings easy and a well-arranged keypad provides convenient operation. The automatic AutoRead function supports correct and repeatable results. Each meter come with a stand and accessories. WTW®

Specifications

Ranges:	All values ±1 digit
Conductivity:	0.00 ... 1000 mS/cm ±0.5 % of measured value 0.00 ... 19.99 µS/cm at K= 0.1 cm ⁻¹
Salinity:	0.0 ... 70.0 (acc. IOT)
Temperature:	-5.0 ... 105.0 °C ±0.1 °C
AutoRead:	automatic
Power supply:	Universal power supply, 100V to 240V, 50/60Hz, 4 x 1.5V AA or 4 x 1.2V NiMH

1



Type	Description	PK	Cat. No.
Cond 7110	Meter only including accessories	1	9.920 096
Cond 7110 Set 1	Meter including TetraCon® 325 and accessories	1	9.920 097

Conductivity meter inoLab® Cond 7310

This is the inoLab® Cond 7310 or inoLab® Cond 7310P. A modern backlit graphic display with menu controlled user interface allows easy and intuitive operation. The mini USB-B interface provides fast data transfer to a PC. The internal memory can record up to 5000 GLP complying data including ID, date and time. The housing and the keypad are easy-to-clean. The inoLab® Cond 7310 has the possibility to connect different standard and special conductivity electrodes and has automatic and manual temperature compensation (can even be switched off for pure water measurements according pharmacopeia) for linear and non-linear function according EN 27 888. An integrated thermal printer (58mm width) is ready for printout of the measured data (option). The scope of delivery includes meter, stand, power supply and USB cable. WTW®

Specifications

Ranges:	All values ±1 digit
Conductivity additional:	0.00 ... 1000 mS/cm ±0.5 % of measured value 0.000 ... 1.999 µS/cm, K= 0.01 cm ⁻¹ 0.00 ... 19.99 µS/cm, K= 0.1 cm ⁻¹
Spific resistance:	0.00 ... 20 MOhm cm
Salinity:	0.0 ... 70.0 (acc. IOT)
TDS:	1 ... 1999 mg/l, 0 to 199.9 g/l
Temperature:	-5.0 ... 105.0°C ±0.1°C
Cell constants:	Fix 0.01 cm ⁻¹ , calibratable 0.450... 0.500 cm ⁻¹ , 0.800 to 0.880 cm ⁻¹ , calibratable 0.09 ... 0.110 cm ⁻¹ , 0.250 ... 25.0 cm ⁻¹
Calibration:	1 point
T _{ref} :	20 °C/25 °C
Temperature compensation:	none, nI, 0.000 ... 10.00 %/K
Calibration memory:	Up to 10 calibrations recallable
Display:	LCD Graphic, backlit
Memory:	manual 200/5000 automatic
Logger:	manual/time controlled
Interface:	Mini USB-B
Power supply:	Universal power supply, 100V to 240V, 50/60Hz, 4 x 1.5V AA or 4 x 1.2V NiMH

2



9.920 114

3



9.920 117

Type	Description	PK	Cat. No.
Cond 7310	Meter incl. accessories	1	9.920 114 2
Cond 7310 Set 1	Meter incl. TetraCon® 325 and accessories	1	9.920 115
Cond 7310P	Meter with built-in printer and accessories	1	9.920 117 3

1



6.270 549

Conductivity meter LAB 945

Due to the intuitive operation and robust aluminum housing the conductivity meter LAB 945 is perfect for training and routine purposes.

SI Analytics

- Made in Germany
- USB Interface
- Data logger (storage of up to 4000 entries: Date, time, main measured value, secondary measured value, measured temperature) with adjustable interval
- Numerical password protection
- Selectable user language (German, English, French and Spanish)
- Configurable turn-off time
- Sturdy aluminium housing
- Graphic LCD display, backlit

Scope of supply: Stand, mains adapter, electrode as indicated and 6 ampoules with test solutions 0.01 M KCl

Specifications

Conductivity:

Measuring range // Resolution // Accuracy

0 ... 200 µS/cm // 0.1µS // ±1 digit

0 ... 2000 µS/cm // 1µS // ±1 digit

0 ... 20 mS/cm // 0.01 mS // ±1 digit

0 ... 500 mS/cm // 0.1 mS // ±1 digit

TDS:

0 ... 200 mg/l // 0.5 % of measured value

0 ... 2000 mg/l // 0.5 % of measured value

0 ... 20 g/l // 0.5 % of measured value

0 ... 500 g/l // 0.5 % of measured value

Temperature:

-10 to 100 °C // 0.1 °C // ±0.1 °C (50 ... 50 °C)

Temperature compensation:

automatic with NTC30kOhm or fix temperature

Type	PK	Cat. No.
Lab 945 without electrode	1	6.270 549 1
LAB 945 Set with LF435T, 4-pole cell	1	6.281 623
LAB 945 Set with LF513T, 2-pole cell	1	6.281 624
LAB 945 Set with LF613T, 4-pole cell	1	6.281 625

2



6.280 108

Conductivity meters FiveEasy™ F30/FiveEasy™ Plus FP30

FiveEasy™ and FiveEasy™ Plus benchtop meters provide high quality conductivity measurements with the simple click of a button. They are the perfect choice for reliable measurement data at a reasonable price.

Mettler-Toledo Online

- Large, easy to read and easy to understand display with all information visible at a glance
- Five self-explanatory buttons making operation simple and easy
- Fast and easy connectivity for simple and secure data transfer (FP only)
- Electrode arm extension pole included

F30/FP30-Meter: Meter with CD operating instructions, QuickGuide, declaration of conformity, test certificate and power supply

F30/FP30-Standard: as F30/FP30-Meter, plus LE703 conductivity sensor and 1 each x 1413µS/cm and 12.88mS/cm standard sachets

Specifications

Measuring range (Accuracy)

0.01µS/cm to 200mS/cm/0.01µS/cm to 500mS/cm (±0.5 % of measured value)

Conductivity F30/FP30:

0.01mg/l to 200g/l/0.01mg/l to 300g/l

TDS F30/FP30:

0 to 100°C (0.5°C)/-5 to 105°C (0.3°C)

Temperature F30/FP30:

1 point, 3 predefined standards

Calibration F30:

1 point, 3 predefined standards, manual cell constant input

Calibration FP30:

Input:

Mini-DIN

Temperature compensation:

Linear: 0.00%/°C to 10.00%/°C

Reference temperature:

20°C and 25 °C

Power supply:

100-240 V/50-60 Hz/12V DC

FP30 only:

Salinity:

0.00 to 42psu

Memory:

200 measurements

Interface:

RS232, USB

Type	PK	Cat. No.
F30-Meter	1	6.280 107
F30-Standard Kit	1	6.280 108 2
FP30-Meter	1	6.280 109

Conductivity meters SevenCompact™ S230

The colour display with its well-designed icons and menu settings in 10 languages makes operation genuinely intuitive. Applications range from routine measurements through sample analysis, data handling and data archiving in compliance with GLP regulations. Simply innovative design that meets the requirements for a universal, easy-to-operate conductivity meter.

Mettler-Toledo Online

- User friendly instrument for demanding users
- Security and high reproducibility thanks to Intelligent Sensor Management (ISM®)
- Improved quality of measurements through professional calibration support
- Comprehensive service package including IQ/OQ
- Integrated USB and RS232 interfaces for data exchange

Supplied with:

S230-Basic: Instrument, electrode holder, protective cover, operating instructions, quick guide, declaration of conformity and test certificate

S230-Kit: As per S230-Basic, additionally with InLab® 731-ISM, guide to conductivity measurements and 2 calibraton sachets for 1413µS/cm and 12.88mS/cm.

S230-USP/EP: As per S230-Kit, but with InLab® 741-ISM instead of InLab® 731-ISM and without calibration sachets for 12.88mS/cm.



9.704 165

Specifications:

Calibration:	13 pre-defined and 1 user-defined standard
Conductivity range:	0.001µS/cm to 1000mS/cm, autoscaling
Conductivity accuracy:	±0.5%
Salinity range:	0.00 to 80.00psu
TDS range:	0.00mg/L to 1000g/L, autoscaling
Resistivity range:	0.00 to 100MΩ*cm, autoscaling
Conductivity ash range:	0.000 to 2022%, autoscaling
Temperature range	
MTC:	-30.0 to 130.0°C
ATC:	-5.0 to 130.0°C
Temperature accuracy:	±0.1°C
Display:	4.3 inch, TFT color
Ext. power supply:	9-12V/10W

Type	PK	Cat. No.
S230-Basic	1	9.704 164
S230-Kit	1	9.704 165 1
S230-USP/EP	1	9.704 166

Printers for Mettler Toledo instruments

Suitable for the following Mettler Toledo instruments:

Mettler-Toledo Online

RS-P25, RS-P26, RS-P28: SevenExcellence™, SevenCompact™, FiveEasy Plus™, SevenMulti™

RS-P25/USB-P25: SevenExcellence™

RS-P26, RS-P28: SevenGo pro™, SevenGo pro Duo™, Densito, Refracto, SevenEasy™

Supplied with: Printer, power cable (country specific), interface cable, paper roll (1 pcs), ribbon cartridge (1 pcs)

Features

Built-in real-time clock, Zero/Tare key:
 Statistic application, totalling application:
 RS232 Schnittstelle:
 Printer unit:
 Ribbon cartridge:
 Paper roll:
 Print quality:
 Interface:
 Dimensions (W x D x H):
 Net weight:

For model

RS-P26, RS-P28
 RS-P28
 RS-P25, RS-P26, RS-P28
 Dot matrix printer
 Exchangeable, black ink
 Standard paper 57.5 mm (W), max. Ø 60 mm
 Thermally stable and lightfast paper (GxP)
 RS232C, 9pin male connector or USB* (*SevenExcellence ONLY)
 120 x 203 x 73mm
 740g (paper roll included)



6.252 178



9.773 710

Type	PK	Cat. No.
RS-P25/USB-P25	1	6.252 178 2
RS-P26	1	6.251 155
RS-P28	1	9.773 710 3

1 2 Conductivity meter SevenExcellence™ S470

Modular professional system for measurements of pH, redox potential, conductivity, salinity/TDS and ion concentration. Fits up to three modules in any composition and order, can be expanded with additional measurement parameters at any time.

Mettler-Toledo Online

- Large, high resolution 7" colour touch display (capacitive), very clear and easy to operate
- Modularity and flexibility; up to 3 measuring modules can work in parallel, expansion to 3 channels possible
- Universal communication via 2 x USB, Ethernet (LAN) and RS232
- Plain text user interface in 10 languages with menu guidance in full sentences
- OneClick™ operation concept to quickly start frequently used functions and preferred methods
- Storage for user methods
- Highest security and GxP support (ID protection, sophisticated user management, limits/alarms, integrated radio clock, etc.)
- Intelligent sensor management (ISM®)
- Connection of stirrer, sample changer, PC, barcode reader, keyboard, local or network printer possible
- Storage up to 20000 data sets (measurements, calibrations, methods)
- 17 predefined, 60 user-defined methods
- 5 point calibration (pH), 13 pre-defined and 20 user-defined buffer groups, incl. temperature chart
- uPlace™ electrode arm with perfect vertical movement
- Compatible with all METTLER TOLEDO electrodes (Recommended: ISM® electrodes)

S470-Basic: Includes instrument, 1 x conductivity expansion unit, 1 x pH/mV expansion unit, 1 x blank expansion unit, uPlace™ electrode holder, semi-transparent cover, operating instructions, installation and quick guide, LabX® direct pH PC software, declaration of conformity and test certificate.

S470-Kit: As S470-Basic but with InLab® Expert Pro-ISM, guide to pH measurements and 2 buffer sachets for pH 4.01, 7.00, 9.21 and 10.00.

S470-USP/EP: As S470-Kit but with InLab® 741-ISM instead of InLab® 731-ISM and InLab® Pure Pro-ISM instead of InLab® Expert Pro-ISM, BNC/RCA-MultiPin™ ISM-cable (1.2 m), and without 1413 µS/cm and 12.88 mS/cm calibration sachets.

Specifications

Temperature MTC/ATC:

pH:

mV:

Rel. mV:

ISFET pH:

Conductivity:

TDS:

Salinity:

Resistivity:

Conductivity Ash:

Measuring range // Resolution // Accuracy

-30.0 to 130.0 °C // 0.1 °C // ±0.1 °C

-2.000 to 20.000 // 0.001/0.01/0.1 // ±0.002

-2000.0 to 2000.0 // 0.1/1 // ±0.1

-2000.0 to 2000.0 // 0.1/1 // ±0.1

0.000 to 14.000 // 0.001/0.01/0.1 // ±0.05

0.001 to 999999 µS/cm // 0.001 to 1 // ±0.5%

0.001 to 2000 mS/cm // 0.001 to 1 // ±0.5%

0.001 to 200 S/m // 0.0001 to 1 // ±0.5%

0.001 to 200000 mS/m // 0.0001 to 1 // ±0.5%

0.1 to 999999 µS/m // 0.001 to 1 // ±0.5%

0.001 to 1000 g/L, ppt // 0.001 to 1 // ±0.5%

0.001 to 999999 mg/L, ppm // 0.001 to 1 // ±0.5%

0.01 to 80.0 psu, ppt // 0.01 to 0.1 // ±0.5%

0.01 to 100.0 MΩxcm // 0.0001 to 1 // ±0.5%

0.01 to 999999 Ωxcm // 0.01 to 1 // ±0.5%

0.000 to 2022% // 0.001 to 1 // ±0.5%

Type	PK	Cat. No.
S470-Basic	1	9.704 361
S470-Kit	1	9.704 362
S470-USP/EP	1	9.704 363



Conductivity cell probes

Standard conductivity cell probe TetraCon® 325:

4-pole cell with integral temperature sensor. Cable length 1.5 metres. Measuring range: 1µS/cm to 2S/cm.

WTW®

TetraCon® 325-3:

Like TetraCon® 325, but cable length 3 m

Special conductivity cell probe TetraCon® 325/C:

As TetraCon® 325, 4-pole cell with integral temperature sensor, but with sensor head made of chemically resistant PEEK. Cable length 1.5 metres. Measuring range: 1µS/cm to 2S/cm

Ultra-pure water conductivity cell probe LR 325/01:

With integral temperature sensor and flowthrough vessel D 01/T for measuring very low conductivity ranges (<1 µS/cm) e.g. boiler feed water or deionised water. Cable length 1.5 metres. Min./max. insertion depth 35/110mm and flowthrough, measuring range: 0.001µS/cm to 200µS/cm.

Conductivity flowthrough cell TetraCon® DU/T:

4-pole conductivity cell with integral temperature sensor for standard applications. Connection via 10mm diameter tubing nozzles (the adapter cable KKDU with 1 metre cable is required for connection). Filling volume 7ml. Measuring range: 1µS/cm to 1000µS/cm.

IDS conductivity cell probe TetraCon® 925:

Intelligent digital 4-pole cell with integral temperature sensor. Automatical transfer of the cell constant. For connection to WTW IDS measuring instruments. Cable length 1.5 metres. Measuring range: 1µS/cm to 2S/cm.

TetraCon® 925-3:

Like TetraCon® 925, but cable length 3 m

IDS conductivity cell probe TetraCon® 925/LV:

Intelligent digital 4-pole cell with integral temperature sensor. Fork design, suitable for small volumes (at least 2.5ml) as well as for viscous samples. Automatical transfer of the cell constant. For connection to WTW IDS measuring instruments. Cable length 1.5 metres. Measuring range: 1µS/cm to 2S/cm.

IDS conductivity cell probe LR 925/01:

Intelligent digital 2-pole cell with integral temperature sensor and flowthrough cell D 01/T for measuring of low conductivity values (<1µS/cm) e.g. in boiler feed water or ion exchange water. Automatical transfer of the cell constant. Cable length 1.5 metres. Min./max. immersion depth 35/110mm and flow through measurement. Measuring range: 0.01µS/cm to 200µS/cm.

Type	Length mm	Electrode	Shaft	Cell constant	PK	Cat. No.
TetraCon® 325	120	Graphite	Epoxy resin	K =0.475	1	9.704 081 1
TetraCon® 325/C	120	Graphite	Epoxy resin	K =0.475	1	6.229 561
TetraCon® 325-3	120	Graphite	Epoxy resin	K =0.475	1	7.008 434
LR 325/01	121	V4A steel	V4A steel	K = 0.1	1	9.704 083
LR 925/01	120	V4A steel	V4A steel	K = 0.1	1	7.656 781 2
TetraCon® DU/T	155	Graphite	Epoxy resin	K approx. 0.8	1	9.704 078 3
TetraCon® 925	120	Graphite	Epoxy resin	K =0.475	1	7.653 077 4
TetraCon® 925-3	120	Graphite	Epoxy resin	K =0.475	1	6.239 576
TetraCon® 925/LV	120	Graphite	Epoxy resin	K = 0.469	1	6.269 370
KKDU 325	100	Connection cable	-	-	1	9.704 079



9.704 081



7.656 781



9.704 078



7.653 077

5 Conductivity measuring cell LF413TIDS

For versatile applications. IDS® 4-pole cell, plastic shaft, 1.5m cable with digital plug, sensor material graphite, temperature sensor NTC 30 kOhm.

SI Analytics

Specifications

Temperature range: -5 to +80°C
 Conductivity range: 1µS/cm to 2000mS/cm
 Taper length/Dia.: 120mm/15.3mm



Type	Length mm	Electrode	Shaft	Cell constant	PK	Cat. No.
LF413TIDS	120	Graphite	Plastic	K=0.475	1	6.265 636

Conductivity sensors InLab® for Mettler Toledo conductivity meters

710: 4 platinum poles

720 + 751-4 + 752-6: 2 platinum poles

731 + 738: 4 graphite poles

741 + 742: 2 steel poles

ISM® (Intelligent Sensor Management) is a sophisticated safety concept that leaves nothing to chance. The instrument automatically detects the connected sensor and uses the most up-to-date calibration data stored on the sensor chip.

Mettler-Toledo Online

All Conductivity sensors with integrated probe sensor (NTC 30 k Ω), shaft length 120 mm, shaft diameter 12, only type 751-4 has diam. 4 mm and 752-6 diam. 6 mm.

Type	Measuring range	Cell constant	Material shaft	Cable m	PK	Cat. No.
710	0,01 ... 500 mS/cm	0,80	Glass	1.2 Mini-DIN	1	9.041 443 1
720	0,1 ... 500 μ S/cm	0,06	Glass	1.2 Mini-DIN	1	9.041 446
731	0,01 ... 1000 mS/cm	0,57	Graphite	1.2 Mini-DIN	1	9.041 447
731-ISM	0,01 ... 1000 mS/cm	0,57	Graphite	1.2 Mini-DIN	1	9.041 448
731-2m ISM	0,01 ... 1000 mS/cm	0,57	Graphite	2.0 Mini-DIN	1	9.041 449
738-ISM	0,01 ... 1000 mS/cm	0,57	Epoxy	1.8	1	7.626 197
738	0,01 ... 1000 mS/cm	0,57	Epoxy	1.8	1	7.636 591
738-ISM	0,01 ... 1000 mS/cm	0,57	Epoxy	10.0	1	9.041 519
741	0,1 ... 500 μ S/cm	0,105	Stainless steel	1.2 Mini-DIN	1	6.242 844
741-ISM	0,1 ... 500 μ S/cm	0,105	Stainless steel	1.2 Mini-DIN	1	9.041 442 2
742	0,001 ... 500 μ S/cm	0,105	Stainless steel	1.8	1	9.041 524
751-4	0,01 ... 100 mS/cm	1,0	Glass	1.2 Mini-DIN	1	9.041 475
752-6	0,01 ... 112 mS/cm	1,0	Glass	1.2 Mini-DIN	1	9.041 476 3



9.041 443



9.041 442



9.041 476



6.230 491

Conductivity sensors for Eutech™ conductivity meters

2-pole cells made of PP and ultem plastic with stainless steel rings.

Thermo Scientific

CONSEN91B: Ag/AgCl reference system, sealed.

Used with COND 6+/TDS 6+/Salt 6+

CONSEN91W: Ag/AgCl reference system, refillable.

Used with CON 510/CON 400 /CON 410/PC 300/PC 510/CON 11/CON 110

CONSEN9103J: Ag/AgCl reference system, refillable.

Used with COND 610/COND 600/CD 650/PC 650/PCD 650

Specifications

Measuring range:	0 ... 150 mS
Temperature range:	0 ... 80 °C
Cell constant:	K = 1.0
Temperature compensation:	ATC
Length/diam.:	144 x 16 mm

Type	Connector	Sensor type	Cable m	PK	Cat. No.
CONSEN91B	BNC, phono	Platin pin	1	1	6.230 491 4
CONSEN91W	6-pin	Plating band	1	1	6.205 314
CONSEN9103J	8-pin	Plating pin	3	1	6.281 895

1 LLG-Conductivity Solutions

- Values stated at 25°C: Accuracy ±1%
- Directly traceable to NIST
- Certificate including actual value, expiration date and uncertainty of measurement

Type	Capacity ml	PK	Cat. No.
84 µS/cm	500	1	9.040 861
147 µS/cm	500	1	9.040 862
1.413 µS/cm	500	1	9.040 863
12.880 µS/cm	500	1	9.040 864

1



2 Conductivity Standards

Conductivity standards tested and ISO 17025 certified at 25 °C. Uncertainty of measurement of ±1%. Directly traceable to N.I.S.T. Temperature dependence data is printed on the label as are lot numbers and expiry dates. Supplied in 500 ml HDPE bottle. 1.3 µS/cm in 250 ml bottle. Calibration values 84, 147, 1413, 12880 µS/cm. Control Values 1.3 - 350000 µS/cm. Reagecon

Type µS/cm	Capacity ml	PK	Cat. No.
1,3*	250	1	6.225 059
5	500	1	6.901 629
10	500	1	6.901 622
20	500	1	6.802 901
23,8	500	1	6.259 883
50	500	1	6.074 754
84	500	1	9.040 904
100	500	1	6.234 859
147	500	1	9.040 905
200	500	1	6.802 902
500	500	1	6.205 415
1000	500	1	6.901 670
1413	500	1	9.040 906
3000	500	1	9.040 964
5000	500	1	6.205 412
10000	500	1	6.901 671
12880	500	1	9.040 907
50000	500	1	6.210 129
100000	500	1	6.205 413
350000	500	1	9.040 987

*1.25 - 1.35 µS/cm at 25 °C.

2



3 Calibration and test material for conductivity measurements

Test resistors and calibration solutions to test the meters with conductivity function as well as to calibrate the system from the device and conductivity measuring cell WTW®

- Optimal measuring safety by PTB/NIST traceable standard solutions
- Easy device check by highly precise test resistors
- Pharmacopeia conforming test kits

3



Type	Description	PK	Cat. No.
USP KIT 2	Kit according to pharmacopeia: LR 325/01 with stainless steel flow vessel, test resistor set, calibration standard 5 µS/cm	1	6.227 656
USP KIT 1	Kit according to pharmacopeia: LR 325/01 with glass flow vessel, test resistor set, calibration standard 5 µS/cm	1	6.093 356
E-SET Trace	Test and calibration standard 1413 µS/cm at 25 °C	1	9.704 137
KS 100 µS	Test and calibration standard 100 µS/cm at 25 °C	1	6.801 249
KS 5 µS	Test and calibration standard 5 µS/cm at 25 °C	1	6.222 865
6R/SET/LAB1	Precision resistor set with calibration certificate	1	7.085 924

1



6.280 119

Dissolved oxygen meter FiveGo™ F4

Portable dissolved oxygen meter for field work.

Mettler-Toledo Online

- Measurement made easy: A large, well-structured display, intuitive button arrangement and simple menu ensure measurements can be performed in just a few clicks.
- Ergonomic design for one handed operation: Thanks to its ergonomic design, handling the FiveGo is a comfortable experience. The foldable stand provides optimal viewing on flat surfaces.

F4-Meter: Meter only

F4-Standard kit: Meter with LE621 sensor

F4-Field kit: Meter with LE621 sensor and carrying case

Specifications

Measuring range (O ₂ Saturation):	0.1 ... 400 %
Resolution:	0.1 %
Accuracy:	±1 %
Measuring range (Temperature):	0 ... 50 °C
Resolution:	0.1 °C
Accuracy:	±0.3 °C
Measuring range (O ₂ concentration):	0.01 ... 45.00 mg/l (ppm)
Resolution:	0.01 mg/l
Accuracy:	±1 %
Temperature compensation:	ATC and MTC
Calibration:	2 points, 100 % and 0 %
Memory size:	200 measurements, current calibration
Dimensions (W x D x H):	188 x 77 x 33 mm
IP code:	IP 67 (meter + sensor)

Type	PK	Cat. No.
F4-Meter	1	6.280 118
F4-Standard kit	1	6.280 119 1
F4-Field kit	1	6.280 120

2



2 Oxygen meter SD 315 Oxi

Lovibond®

The portable hand-held measuring instrument SD 315 Oxi meets the daily requirements for a robust and reliable instrument for the determination of dissolved oxygen in aqueous media. The Clark oxygen sensor with integrated temperature probe enables immediate measurements without time-consuming run-in time (polarisation time).

- Simple calibration against air or according to DIN EN ISO 5814
- Alarm function with adjustable limits
- Automatic pressure and temperature compensation
- Auto Hold Function
- Automatic switch-off individually selectable from 1 to 120 min
- Backlit LCD display
- Sensor status display in % after each calibration
- Salinity correction
- Parameter: dissolved oxygen (O₂), O₂ concentration in mg/l, O₂ saturation in %, temperature in °C/°F
- Battery status indicator
- Flexible stand at the rear allows the unit to be set up or fastened to a belt.
- Data transfer and evaluation via software possible

Scope of supply: Instrument, protective covering, electrode holder, carrying case, galvanic oxygen sensor, KOH refill electrolyte, spare membrane, calibration bottle with sponge, batteries, manual

Specifications

O ₂ concentration:	0.0 ... 70.0 mg/l
O ₂ saturation:	0.0 ... 600.0 %
Temperature:	0.0 ... 50.0 °C
Memory:	10000 data sets automatically 1000 data sets manually
Dimensions (W x D x H):	164 x 100 x 37 mm
Weight:	302 g
Power supply:	2 x AAA
IP code:	IP 67

Type	Cable length m	PK	Cat. No.
SD 315 Oxi (Set 1)	2.0	1	4.678 221
SD 315 Oxi (Set 2)	10.0	1	4.678 222

1 Portable dissolved oxygen meter Oxi 3205

Robust and easy to use dissolved oxygen meter for standard alkaline, or rechargeable, batteries. Menu-controlled with backlit graphics display for ease of use under all lighting conditions. Suitable for use in harsh environments.

WTW®



Warning

H phrases: H315|H319

Measuring ranges:

O₂ concentration: 0.00 to 20.0mg/l (19.9mg/l*)
 0.0 to 90.0mg/l (90mg/l*)
 O₂ saturation: 0.0 to 200.0% (200%*)
 0 to 600%
 Temperature: 0.0 to +50°C, ±0.1°C
 * when using DurOx oxygen sensor probes

Accuracy:

O₂ concentration: ±0.5% of reading
 O₂ saturation: ±0.5% of reading

Type	Description	PK	Cat. No.
Oxi 3205	meter only	1	9.774 378
Oxi 3205 Set 1	case set including DO sensor CellOx 325 and accessories	1	9.774 340



The inoLab® series from WTW

The inoLab® benchtops are perfectly designed for modern laboratory surroundings. The key pads are clearly outlined and easy-to-operate, their smooth surfaces are easy-to-clean and the operation is self-explanatory. All meters include a universal power supply and a convenient stand with sensor support. If desired they can be ordered in application oriented sets including sensors and accessories.

2 Oxygen meter inoLab® Oxi 7310

Reliable Documentation for dissolved oxygen measurement, if desired also available with built-in printer. This is the inoLab® Oxi 7310 or inoLab® Oxi 7310P. A modern backlit graphic display with menu controlled user interface allows easy and intuitive operation.

WTW®

The mini USB-B interface provides fast data transfer to a PC. The internal memory can record up to 5000 GLP complying data including ID, date and time. The housing and the keypad are easy-to-clean. The inoLab® Oxi 7310 supports the long proven WTW galvanic sensors, CellOx® 325 and StirrOx® G. A calibration history of the 10 last calibrations allows conclusions on the state of the sensor. Calibrations versus external standards e.g. Winkler titration, are possible, too. The meter includes automatic barometric pressure and temperature compensation. An integrated thermal printer (58 mm width) is ready for printout of the measured data (option). The scope of delivery includes meter, stand, power supply and USB cable.

Specifications

Ranges: All values±1 digit
 Dissolved oxygen concentration: 0.00 ... 20.00 mg/l ±0.5 % of measured value
 0 ... 90 mg/L ±0.5 %
 Saturation: 0.0 ... 200.0 % ±0.5 % of measured value
 0 ... 600 % ±0.5 % of measured value
 Partial pressure: 0 ... 200.0 hPa, 0 ... 1250 hPa
 Temperature: -5.0 ... 105.0 °C ±0.1 °C
 Calibration: 1-point air calibration (water vapour saturated air) or versus external standard
 Calibration memory: Up to 10 calibrations recallable
 Display: Backlit graphic LCD
 Memory: manual 5/5000 automatic
 Logger: manual/time controlled
 Interface: Mini USB-B
 Power supply: Universal power supply, 100 to 240 V, 50/60 Hz, 4 x 1.5 V AA



Type	Description	PK	Cat. No.
Oxi 7310	Meter only including accessories	1	9.920 108
Oxi 7310 Set 1	Meter including CellOx® 325 and accessories	1	9.920 109
Oxi 7310 Set 4	Meter including StirrOx® G and accessories	1	9.920 110
Oxi 7310P	Meter including integrated printer	1	9.920 111

1

1 2 Portable dissolved oxygen meter Oxi 3310

Comfortable and versatile DO meter with integral, time controlled, data logger and memory for 5000 GLP compliant records for extended data collection. Menu controlled, with backlit graphics display for comfortable and safe operation. Calibration against external standards possible. Automatic temperature, barometric pressure and salinity compensation. 100 % waterproof, USB interface for fast data transfer. Includes driver software and cable. WTW®



H phrases: H315|H319

2

Measuring ranges:

O₂ concentration: 0.00 to 19.99mg/l (19.9mg/l*)
 0.0 to 90.0mg/l (90mg/l*)
 O₂ saturation: 0.0 to 199.9% (199%*)
 0 to 600%
 Temperature: -5.0 to +50.0°C
 * when using DurOx oxygen sensor probes

Accuracy:

O₂ concentration: ±0.5% of reading
 O₂ saturation: ±0.5% of reading
 Memory: 5000 records (measured value, temperature, date, time, ID)

Type	Description	PK	Cat. No.
Oxi 3310	meter only	1	9.774 338
Oxi 3310 Set 1	cased set including DO sensor CellOx 325 and accessories	1	9.774 339

Thermal printer P 3001 for WTW® instruments with serial interface

WTW® devices with serial interface can be directly connected to a PC and therefore use the PC printer. WTW®

Description	PK	Cat. No.
Thermal printer P 3001	1	7.510 044
Printer paper RP 3001	1	7.089 804

3

3 Galvanic Dissolved Oxygen Sensor CellOx® 325

Membrane covered galvanic dissolved oxygen for measurement of water and aqueous solutions. Low maintenance and without polarization time. The CellOx® 325 is a dissolved oxygen sensor with built-in temperature compensation by a NTC 30 kOhm sensor and membrane leakage monitoring for field and laboratory applications. It has a fast response (t₉₉<60 s) and a low-maintenance operation. The application ranges from surface water, waste water treatment, BOD measurement to industrial and special applications. An electrolyte filling is sufficient for up to 6 months service life. The calibration vessel is included in the delivery. For Oxi 3xx, Oxi 3xxi, ProfiLine Oxi 197, ProfiLine Oxi 197i, ProfiLine Multi 197i, Multi 340i, Oxi 3205, Oxi 3210, Oxi 3310, ProfiLine Oxi 1970i, ProfiLine Multi 1970i, inoLab®. WTW®



H phrases: H315|H319

Specifications

Temperature range: 0 to 50 °C
 DO-concentration: 0 to 50 mg/l
 DO-saturation: 0 to 600 %
 Partial pressure: 0 to 1250 hPa
 Shaft length/diam.: 145 mm/15.3 mm
 Plug: 8 pole plug, waterproof

Type	Cable m	PK	Cat. No.
CellOx® 325	1.5	1	9.822 551
CellOx® 325-3	3	1	7.008 258

Accessories for Oxygen Sensor CellOx® 325

H phrases: H315|H319

Type	Description	PK	Cat. No.
ZBK 325	Replacement and maintenance agent for dissolved oxygen sensor CellOx®325 und TA 197 Oxi	1	7.008 272

1 Oxygen sensor StirrOx® G

For inoLab® Oxi 730, ProfiLine 197i/1970i, inoLab® 740 Oxi, inolab Oxi 7310

WTW®

Self-stirring oxygen sensor.

- single-handed use
- high reproducibility
- ready for immediate use, no polarisation period necessary
- extremely low internal consumption of oxygen by the electrode
- no zero point calibration necessary
- OxiCal®-SL calibration and storage vessel included
- 6 months operation with one electrolyte filling
- IMT function compensation
- membrane leakage monitoring, damaged membranes are indicated.

Supplied with case, spare parts and maintenance solutions.

1



Type	PK	Cat. No.
StirrOx® G	1	9.822 560
Accessories kit with replacement and maintenance equipment	1	7.008 273

2 Oxygen sensor DurOx® 325

For use with Oxi 3xxi, ProfiLine Oxi 1970i, ProfiLine 3205, 3210, 3310.

WTW®

Membrane-covered oxygen sensor with low flow requirement and removable cage guard, for field applications (fish farm revival pools) and for educational purposes.

- ready to measure - no polarisation time
- IMT compensation via two integral temperature sensors
- service life with one electrolyte filling approx. 6 months
- minimal flow requirement
- no zero current
- sensor is watertight (IP 68 - 2)
- standard with 3m cable and watertight plug
- standard with calibration/storage vessel OxiCal® -D
- standard with cage guard SK-D



Warning

H phrases: H315|H319

2



Type	PK	Cat. No.
DurOx® 325	1	9.920 045

Optical D.O. Sensor FDO® 925

Optical IDS D.O. sensor for portable MultiLine® IDS and InoLab® Multi IDS benchtop

WTW®

meters. Measures the dissolved oxygen according DIN ISO 17289:2014-12. For applications in the lab and in process, outdoor and waste water treatment plants. Low maintenance (t99 < 60 s).

No oxygen consumption, with inclined membrane for avoiding air bubbles. Factory calibrated membrane with smart chip. Built-in NTC 30 kOhm temperature sensor.

Specifications

Temperature range:	0 ... 50.0 °C ±0.2 °C
DO concentration:	0.00 ... 20.00 mg/l ±0.5 % of value
DO saturation:	0.0 ... 200.0 % ±0.5 % of value
Partial pressure:	0.0 ... 400 hPa ±0.5 % of value
Shaft length/diam.:	150 mm/15.3 mm

3



6.238 174

Type	Description	PK	Cat. No.
FDO® 925	1.5 m fix cable	1	6.238 174 3
FDO® 925-3	3 m fix cable	1	6.239 577
SC-FDO® 925	Changing cap	1	6.242 048
FDO® 925-P	Plug head, AS/IDS cable or wireless module necessary	1	6.259 423

Accessories for Oxi

Suitable for all laboratory and field electrodes except StirrOx® G.

WTW®

Type	Description	PK	Cat. No.
WP3-ST	Replacement membrane heads for StirrOx® G	3	9.822 594
WP 90/3	Replacement membrane heads for all dissolved oxygen sensors, except StirrOx®G, DurOx®325	3	9.822 595

BOD (Karlsruher) bottles - please see page 1259.



1 Oxygen sensor InLab® 605/InLab® 605-ISM

Sensor for polarographic oxygen measurement with high accuracy and repeatability. For use in laboratory, field and industry. Robust construction. Diaphragm mechanically protected by steel mesh, shaft made of glass-fibre reinforced PPS. With integrated temperature sensor. *Mettler-Toledo Online*

- he InLab® oxygen sensors are designed for use with the SevenExcellence™ multi-channel tabletop meter and the portable SevenGo™ 6 meters.

- InLab®-ISM oxygen sensors are equipped with Intelligent Sensor Management, which enables simple calibration in the air and permanent monitoring of the sensor status.

Designed for use with the SevenExcellence™ multi-channel tabletop meter and the portable SevenGo™ 68 dual-channel instruments.

Specifications

Sensor type:	Polarographic sensor
Measuring range oxygen:	0 ... 200 %/0 ... 20 mg/l
Measuring range temperature:	0... 60 °C
Connections:	BNC (IP 67)/Cinch (RCA)
Shaft diameter:	12 mm
Shaft length:	120 mm

Type	Cable m	PK	Cat. No.
InLab® 605	5	1	6.239 016
InLab® 605	10	1	9.041 601
InLab® 605-ISM	2	1	9.041 583
InLab® 605-ISM	5	1	9.041 584
InLab® 605-ISM	10	1	9.041 585



2 Electrolyte solution for dissolved oxygen electrodes

WTW®

Type	Capacity ml	PK	Cat. No.
ELY/G	50	1	9.822 553
ELY/A	50	1	9.822 604

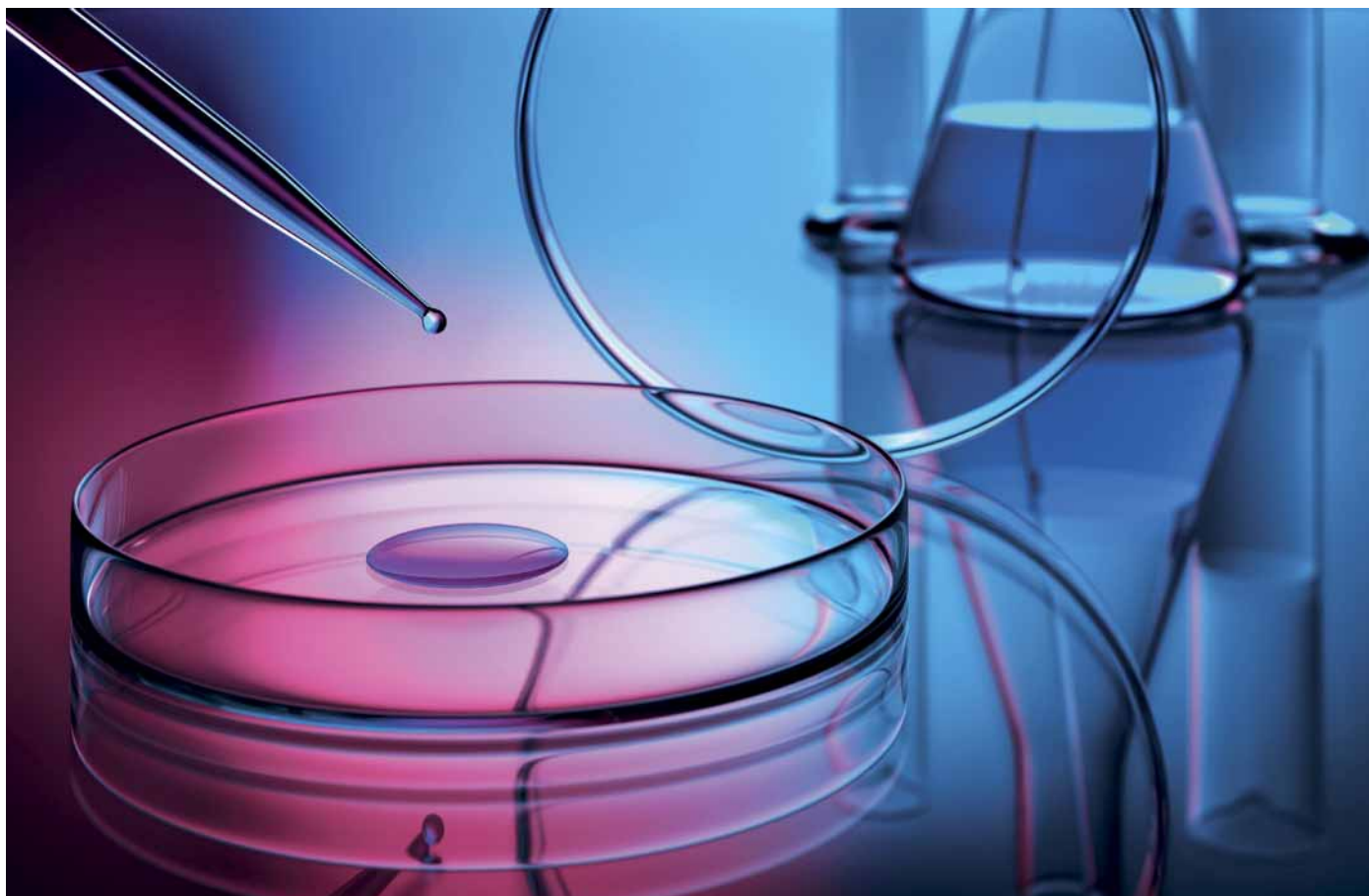

1 Multi-Parameter meter Eutech™ PCTestr 35

Versatile multi-parameter meter for measuring pH, conductivity and temperature. Waterproof, with user-replaceable sensor. Suitable for general and industrial purposes, e.g. in the chemical industry and food processing, pools, aquariums and cooling towers.

- Multi-sensor for pH, conductivity and temperature
- Simply toggle the parameters
- Up to 5 calibration points for pH and 3 calibration points for conductivity
- Water- and dustproof housing
- Big LCD Display
- Auto-Off

Thermo Scientific

1



Specifications

pH range: 0.0 ... 14.0
 Resolution: 0.1 pH
 Accuracy: 0.1 pH
mV range: 0 ... 1999 µS/cm/2.00 ... 20.00 mS/cm
 Resolution: 1 µS/cm/0.01 mS/cm
 Accuracy: ±1 % (full scale)
Temperature range: 0 ... 50 °C
 Resolution: 0.1 °C
 Accuracy: 0.5 °C
 Protection class: IP 67
 Power supply: 4 x 1.5 V A76 batteries

Type	PK	Cat. No.
PCTestr 35	1	6.258 988

2 Multiparameter meters SensoDirect 150

The SD 150 Multi-Parameter handheld instrument is ideal for the sequential determination of pH, Redox/ORP, conductivity, TDS and dissolved oxygen and combines the applications of several instruments in one portable device.

Lovibond®

2



- Large, easy to read LCD display with contrast adjustment
- Automatic recognition of standard solutions
- Automatic temperature compensation
- Real time data logger

Scope of supply: Instrument, batteries, protective armoring, electrode holder, pH electrode type 226, temperature sensor Pt1000, pH buffer, manual

SensoDirect 150 (Set 1) pH/Con/TDS/Oxi/Temp. additionally: Conductivity cell, oxygen sensor, electrolyte, membrane heads

SensoDirect 150 (Set 2) pH/Con/TDS /Temp. additionally: Conductivity cell

SensoDirect 150 (Set 3) pH/Oxi/Temp. additionally: Oxygen sensor, electrolyte, membrane heads

SensoDirect 150 (Set 4) pH/Redox/Temp. additionally: Redox electrode

Specifications

pH: 0 ... 14 pH
 ORP: -1999 ... 1999 mV
 Conductivity: 0 ... 200.0 mS/cm
 TDS: 0 ... 132000 ppm
 Temperature: 0 ... 60 °C
 Oxygen: 0 ... 20.0 mg/l
 Interface: USB, RS 232
 Dimensions (W x D x H): 76 x 203 x 38 mm
 Weight: 320 g
 Power supply: DC 1.5V battery (UM3, AA) x 4 PCs or DC 9V Adapter
 IP code: IP 51

Type	PK	Cat. No.
SensoDirect 150 (Set 1) pH/Con/Oxi	1	6.241 474
SensoDirect 150 (Set 2) pH/Con	1	6.241 983
SensoDirect 150 (Set 3) pH/Oxi	1	6.256 805
SensoDirect 150 (Set 4) pH/Redox	1	9.699 295

1 Multiparameter meters SD 335



Depending on the set, the portable multi-parameter measuring device is ideally suited for the precise determination of pH, redox, temperature, conductivity/TDS/salinity as well as saturation and concentration of dissolved oxygen.

- Intuitive user interface thanks to graphical LCD display
- Simultaneous determination of up to three parameters due to galvanic isolation
- Selection between multi-parameter display or single value display
- Setting of alarm limits for parameter monitoring
- Micro-USB connection for software-free data transmission and power supply
- Data logger records measurement data incl. time stamp and measuring point ID in a fixed time interval or manually at the push of a button
- Automatic recognition of standard solutions
- Evaluation of the sensor quality after calibration
- Rechargeable NiMH batteries

Scope of supply: Meter, protective armouring, electrode holder for 2 electrodes, pH/temp. electrode type 231, pH buffer (4.01/7.00/10.01), storage solution for pH/ORP electrodes, 3 x AAA-NiMH rechargeable batteries, user manual

SD 335 Multi (Set 1) pH/Con/Temp. additionally: Conductivity electrode LC 12 (< 200 mS/cm), conductivity solution 1413 µS/cm (NIST)

SD 335 Multi (Set 2): pH/DO/Temp. additionally: Galvanic oxygen sensor (2 m cable), refill electrolyte, membrane heads, calibration bottle with sponge

SD 335 Multi (Set 3): pH/Con/DO/Temp. additionally: Conductivity electrode LC 12 (< 200 mS/cm), conductivity solution 1413 µS/cm (NIST), galvanic oxygen sensor (2 m cable), refill electrolyte, membrane heads, calibration bottle with sponge

Specifications

pH:	-2.00 ... 16.00 pH
mV:	-2000 ... 2000 mV
Conductivity:	0.000 ... 500 mS/cm
TDS:	0.000 ... 500 g/l
Salinity:	0.0 ... 70.0 PSU
O ₂ -concentration:	0.00 ... 50.00 mg/l
O ₂ -saturation:	0.0 ... 500.0 %
Temperature:	-10.0 ... 110.0 °C
Data logger:	8 GB
Interface:	Micro-USB
Dimensions (W x D x H):	100 x 164 x 37 mm
Weight:	310 g
Power supply:	3 x AAA NiMH rechargeable batteries, Micro-USB
IP code:	IP 67

Type	PK	Cat. No.
SD 335 Multi (Set 1) pH / Con / Temp.	1	4.678 204
SD 335 Multi (Set 2) pH / DO / Temp.	1	4.678 205
SD 335 Multi (Set 3) pH / Con / DO / Temp.	1	4.678 206

1



New logo - new name:
Aqualytic® becomes Lovibond®!

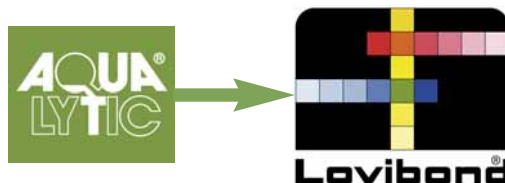

1 Multi parameter HandyLab 680

SI Analytics

The HandyLab 680 increases the measuring accuracy via:

- IDS technology. The digitalization of the measuring signal eliminates interferences.
- AutoRead function. Autoread provides a stable, precise measuring value.
- CMC (Continuous Measurement Control) visualizes whether the measuring value is within the calibration range.
- QSC (Quality Sensor Control) informs about the actual condition of the electrode and therefore increases operation safety.

The HandyLab 680 increases the operator comfort via:

- IDS Technology. The secure allocation of the calibration data to the sensor eliminates any uncertainty about the date and results of its last calibration. This saves time and money while assuring the highest confidence in your measurements.
- Traceability of the measuring values by the digital and automatic capture of all sensor data.
- User administration can be activated to allow tiered access and capabilities ensuring security and confidence of your data.
- Transmission of all data in *.csv format via USB interface to the PC or the USB memory stick, or, as an alternative, formatted transfer to Excel by means of MultiLabImporter (included in the delivery).

Supplied with:

HL680pH/CondVersat: pH/Cond meter Set HandyLab 680 with conductivity electrode LF413T IDS, pHTelectrode A7780 IDS, case Z530 and protective armouring Z389 for general applications

HL680pH/Cond/OxVer: pH/Cond/OX meter Set HandyLab 680 with oxygen electrode FDO1100 IDS, conductivity electrode LF413T IDS, pHT electrode A7780 IDS, case Z530 and protective armouring Z389 for general applications

Specifications

pH

Measuring range: 0.000 ... 14.000pH
 Resolution: ±0.001pH
 Accuracy: ±0.004pH

mV

Measuring range: ±1200.0 mV
 Resolution: ±0.1mV
 Accuracy: ±0.2mV

Temperature

Measuring range: -5.0 ... +105.0°C
 Resolution: ±0.1°C
 Accuracy: ±0.2°C

Conductivity

Measuring range: 0.00 ... 2000mS/cm
 Resolution: ±0.1mS/cm, ±0.01µS/cm, ±0.001µS/cm
 Accuracy: ±0.5% of mean value
 Specific resistance: 0.00 Ωcm ... 100 MΩcm ±0.5% of mean value
 Salinity: 0.0 ... 70.0 (acc. to IOT)
 TDS: 0 ... 1999 mg/l, 0 ... 199.9g/l ±0.5% of mean value

Oxygen measurement

DO concentration: 0.00 ... 20.00mg/l ±0.5% of mean value
 DO saturation: 0.0 ... 200.0 % ±0.5% of mean value
 DO partial pressure: 0 ... 400 hPa ±0.5% of mean value

Type	PK	Cat. No.
HL680pH/CondVersat	1	6.265 601
HL680pH/Cond/OxVer	1	6.265 299

1



Multiparameter measurement/Devices

1



1 Multiparameter meters ProfiLine pH/Cond 3320

The pH/Cond 3320 has a robust, waterproof housing (IP67) and is equipped with a memory as well as a data logger with an adjustable interval between 1 s and 60 min. All entries contain GLP-supporting data, like the date, time and ID number. The modern, waterproof USB interface is used for easy and quick data transfers. Applications: Process chemistry, Life Science, food and beverage industry, pharmaceutical industry (measurement of pH and conductivity according to pharmacopeia).

WTW®

- Two inputs for the simultaneous measurement of pH/mV/ISE/redox potential and conductivity
- Backlit graphic display for the parallel display of the measured values
- Perfect for monitoring process applications
- Waterproof USB interface

Scope of delivery pH/Cond 3320 Set 2: Professional pH and redox meter for mobile measurements. Meter in transport case with SenTix® 41, TetraCon® 325, buffer solution STP 4 and STP 7, conductivity standard 0.01 mol/l KCl, manual, stand, beaker, CD-ROM, driver software for USB, batteries, cable.

Specifications

Measuring range/Resolution

pH:	-2.000 ... 19.999 ±0.005 pH
mV:	-2500 ... +2500 ±1 mV
ISE (mg/l, µmol/l, mg/kg, ppm, %):	0.000 ... 999999
Conductivity:	0.000 µS/cm ... 1000 mS/cm
Salinity:	0.0 ... 70.0
TDS:	0 mg ... 199.9 g/l
Temp.:	-5.0 ... 105.0 °C ±0.1 °C
Memory:	manually 200/5000 automatically
Power supply:	4 x 1.5 V AA or 4 x 1.2 V NiMH battery
IP code:	IP 67

Type	Description	PK	Cat. No.
pH/Cond 3320	only device	1	6.264 057
pH/Cond 3320 Set 2	with SenTix® 41, TetraCon® 325 and accessories	1	6.262 509

2



2 Multiparameter meter ProfiLine Multi 3320

The Multi 3320 for the measurement of pH, ORP, conductivity and dissolved oxygen (electro-chemical) is an ideal meter for environmental applications in the areas of ground and surface water measurement, in aquatic cultures as well as in wastewater treatment plants and much more.

WTW®

The Multi 3320 has a robust waterproof housing (IP 67) and memory with data logger with adjustable interval between 1 s and 60 min. The keypad can also be operated when wearing gloves and is easy to clean under a water jet.

- Two inputs for simultaneous measurement of pH and conductivity or pH and dissolved oxygen
- Backlit graphic display for parallel output of measured values
- All conventional WTW pH electrodes, combined ISE electrodes, conductivity measuring cells and galvanic oxygen sensors can be connected to the meter.
- Waterproof USB interface

Scope of delivery Multi 3320 Set 1: Professional pH and conductivity meter for mobile measurements. Meter in field case with SenTix® 41, CellOx® 325, TetraCon® 325, sensor accessories, manual, stand, beaker, CD-ROM, driver software for USB, batteries, cable.

Specifications

Measuring range/Resolution

pH:	-2.000 ... 19.999 ±0.005 pH
mV:	-2500 ... +2500 ±1 mV
ISE (mg/l, µmol/l, mg/kg, ppm, %):	0.000 ... 999999
O ₂ concentration:	0.00 ... 20.00 mg/l or 0.0 ... 90.0 mg/l*
O ₂ saturation:	0.00 ... 200.0 % or 0.0 ... 600 %*
O ₂ partial pressure:	0.0 ... 200.0 hPa, 0 ... 1250 hPa*
Conductivity:	0.000 µS/cm ... 1000 mS/cm
Salinity:	0.0 ... 70.0
TDS:	0 mg ... 199.9 g/l
Temp.:	-5.0 ... 105.0 °C ±0.1 °C
Memory:	manually 200/5000 automatically
Power supply:	4 x 1.5 V AA or 4 x 1.2 V NiMH battery
IP rating:	IP 67

Type	Description	PK	Cat. No.
Multi 3320 Set 1	with SenTix® 41, TetraCon® 325, CellOx® 325 and accessories	1	7.660 051

*depending on oxygen sensor and measuring media

The inoLab® series from WTW

The inoLab® benchtops are perfectly designed for modern laboratory surroundings. The key pads are clearly outlined and easy-to-operate, their smooth surfaces are easy-to-clean and the operation is self-explanatory. All meters include a universal power supply and a convenient stand with sensor support. If desired they can be ordered in application oriented sets including sensors and accessories.

Laboratory instruments inoLab® Multi 9620 IDS/ 9630 IDS

Securely traceable with the cutting edge inoLab® Multi 9630 IDS and inoLab® Multi 9620 IDS.

WTW®

- Secure measurement data
- Digital sensor recognition
- Complete documentation
- Wireless ready

High-tech made by WTW for challenging applications. Two digital inoLab® multi parameter instruments for IDS sensors for simultaneous measurement of equal or different parameters and sensors. Two (inoLab® Multi 9620 IDS) or three sensors (inoLab Multi 9630 IDS) could be connected either by cable or via wireless modules. A large color graphic display protected by a glass plate supports the representation of readings and information, The anti-bacterial keypad minimizes the danger of microbiological contaminations. The robust lower case made of zinc diecast provides proper stand and perfect shielding against interferences. A high quality stand for alternative left or right mounting allows easy adaptation to the requirements at the working place.

Secure measurements

- Digital data transfer eliminates interferences, provide secure calibration data and makes documentation of sensor data easy.
- The smart sensor rating (QSC) gives information about the true condition of an IDS pH electrode and increases safety of operation
- The CMC function for pH visualizes the optimum measuring range and supports correct measurements.
- Visual display for the channel in order to provide correct allocation of channel and sensor.

Documentation according GLP/AQA

- Automatic digital recording of all sensor data for distinct documentation
- Optional user administration for clear allocation of user and measurement results and assigning different access levels
- Transfer of data as *.csv format via USB to PC, if desired transfer direct to Excel (MultiLab Importer, part of scope of delivery or as download from internet)
- Additional transfer to USB memory drive or selected printer

Compatible to conventional pH measurement

- pH module (accessory) capable of being integrated for pH, ISE and ORP electrodes with DIN or BNC plug and 4 mm banana plug. For temperature sensor.

IDS WLM Kit. For wireless measurement of pH/ORP, conductivity, dissolved oxygen, or turbidity. Consisting of a wireless module for sensor and meter, USB charger and universal USB power supply.

Specifications

Measuring channels

inoLab® Multi 9620 IDS: 2
inoLab® Multi 9630 IDS: 3

Display: Color graphic, glass plate protected

Memory: manual: 500/automatic: 10000

Logger: manual/time controlled

Interface: USB-A, Mini USB-B

Power supply: Universal power supply, 100 to 240 V, 50/60 Hz

1



6.283 614

2



6.285 517

3



6.283 612

Type	Description	PK	Cat. No.
Multi 9620 IDS	Single instrument	1	6.283 614 1
Multi 9620 Set C	With SenTix® 980, TetraCon® 925	1	7.644 960
Multi 9630 IDS	Single instrument	1	6.285 517 2
Multi 9630 Set K	With SenTix® 980, TetraCon® 925	1	6.285 439
IDS WLM KIT	Accessory Kit for wireless equipment	1	6.283 612 3

Separate IDS electrodes available on request.

Multiparameter measurement/Devices

1



1 | 2 Multiparameter meters

Selected IDS-Sensors:

2



SenTix® 940: Low maintenance combined pH electrode with ATC, QSC suitable, memory for 10 calibrations, stored serial number, pH 0.000 to 14.000 ($\pm 0.004\text{pH}$), temperature range 0.0 to 80.0°C, $\pm 0.2^\circ\text{C}$. Also available with plug head for cable or wireless modules.

SensoLyt® 900: Low maintenance polymer electrolyte pH electrode with built-in temperature sensor, pressure resistant up to 10 bar, QSC suitable, memory for 10 calibrations, saved serial number, pH 2.000 to 12.000 ($\pm 0.004\text{pH}$), temperature range from 0.0 to 60.0°C, $\pm 0.2^\circ\text{C}$. Only available with plug head for cable, MPP or wireless modules.

SenTix® 950: Combined pH-electrode with plastic shaft, 3 mol/l KCl, ATC, QSC-suitable, memory for 10 calibrations, stored serial number, pH 0.000 to 14.000 ($\pm 0.004\text{pH}$), temperature range 0.0 to 80.0°C, $\pm 0.2^\circ\text{C}$. Also available with plug head for cable or wireless modules.

SenTix® 980: Combined pH-electrode with plastic shaft, 3 mol/l KCl, ATC, platinum wire junction, QSC-suitable, memory for 10 calibrations, stored serial number, pH 0.000 to 14.000 ($\pm 0.004\text{pH}$), temperature range 0.0 to 100.0°C, $\pm 0.2^\circ\text{C}$. Also available with plug head for cable or wireless modules.

TetraCon® 925: Robust, general purpose 4-electrode conductivity cell with graphite electrodes incorporating integral temperature sensor. Memory for 10 calibrations, stored serial number, measuring range 10 $\mu\text{S}/\text{cm}$ to 2000 mS/cm $\pm 0.5\%$ of value, 0.0 to 100.0°C, $\pm 0.2^\circ\text{C}$. Also available with plug head for cable or wireless modules.

LR 925/01: 2-electrode stainless steel conductivity cell for low conductivities, integrated temperature sensor, flow through vessel, memory for 10 calibrations, stored serial number, measuring range 0.01 $\mu\text{S}/\text{cm}$ to 200 $\mu\text{S}/\text{cm}$ $\pm 0.5\%$ of value, 0.0 to 100.0°C, $\pm 0.2^\circ\text{C}$. Also available with plug head for cable or wireless modules.

FDO® 925: Extremely fast (T99 < 60 s) and precise optical DO sensor for field and laboratory applications. Handy, suits in different BOD bottles. Waterproof for depth measurement to 100m. Bevelled, air bubble repelling membrane, Green light technology for extended operation time. Insensitive against H₂S. O₂ concentration: 0.00 to 20.00mg/l, O₂ saturation: 0.0 to 200.0% O₂ partial pressure: 0.0 to 400hPa. Accuracy: $\pm 0.5\%$ of value. Also available with plug head for cable or wireless modules.

The information for meter precision refers to the sensors' built-in, electronic, measuring technology.

Multiparameter meters MultiLine® IDS

Professional digital multiparameter meters for mobile measurement, with 3, 2 or 1 universal measurement channels, wireless preparation, colour graphic display (black/white display for Multi 3510), data logger manually or automatically (timed) and 2 (1 for Multi 3510) waterproof USB interfaces suitable for field use. Easy to clean with a soft brush under water jet.

WTW®

Multi 3630: The Multi 3630 IDS with three universal measurement channels is suitable for all WTW IDS pH, ORP, dissolved oxygen sensors, conductivity cells and turbidity sensors, whether connected to cable or wireless. Documentation of meter and sensor data. User control over MultiLab® users. With USB-A and Mini USB-B interface and colour display.

Multi 3620: The Multi 3620 IDS with two universal measurement channels is suitable for all WTW IDS pH, ORP, dissolved oxygen sensors, conductivity cells and turbidity sensors, whether connected to a cable or wireless. Documentation of meter and sensor data. User control over MultiLab® users. With USB-A and Mini USB-B interface and colour display.

Multi 3510: Sequential multi-parameter measurement. All WTW IDS pH, ORP, dissolved oxygen sensors, conductivity cells and turbidity sensors can be connected to the universal channel, either with cable or wireless module. Data transfer to PC with MultiLab® Importer. With Mini USB-B interface and black/white display.

Specifications

Measuring range:

Memory Multi 3510 IDS:

Memory Multi 3630 IDS/Multi 3620 IDS:

Dimensions (W x D x H):

Weight:

Power supply Multi 3510 IDS:

Power supply Multi 3630 IDS/Multi 3620 IDS:

IP code:

depending on IDS sensor

manual: 500 data records

automatic: 4500 data records

manual: 500 data records

automatic: 10.000 data records

approx. 180 x 80 x 55 mm

400 g

4 alkaline batteries, USB

PSU with charging function,

4 NiMH batteries (AA type), USB

IP 67

1 Multiparameter meters MultiLine® 3630 IDS

Multi 3630 IDS: Single meter in a carrying case, buffers 4 and 7, 3 mol/l KCl, conductivity standard, batteries, cables, power supply, arming SM Pro WTW®

Multi 3630 IDS SET F: Single meter in a field case with IDS sensors (digital pH sensor SenTix® 940, digital conductivity cell TetraCon® 925, optical sensor FDO® 925), QSC Kit, stand, beaker, buffers 4 and 7, conductivity standard, batteries, cables, power supply, arming SM Pro

Multi 3630 SET G: Meter in a large carrying case with IDS sensors (digital pH sensor SenTix® 940-3, optical sensor FDO® 925-3, digital conductivity cell TetraCon® 925-3), QSC Kit, buffers 4 and 7, conductivity standard, stand, beaker, CD-ROM, batteries, cables, power supply, arming SM Pro

Multi 3630 SET KS2: Single meter in a carrying case, with QSC Kit, buffers 4 and 7, conductivity standard, stand, beaker, CD-ROM, batteries, cables, power supply, arming SM Pro



Type	Description	PK	Cat. No.
Multi 3630	3 channels, meter only	1	6.283 309
Multi 3630 SET F	3 channels, with SenTix® 940, TetraCon® 925, FDO® 925	1	6.282 980
Multi 3630 SET G	3 channels, SenTix® 940-3, FDO® 925-3, TetraCon® 925-3	1	6.283 709
Multi 3630 SET KS2	3 channels, meter only, armor SM Pro	1	6.283 615

2 Multiparameter meters MultiLine® 3620 IDS

Multi 3620 IDS: Single meter in a carrying case with Quick Start Guide, CD-ROM and batteries, driver software for USB, cable, power supply WTW®

Multi 3620 IDS SET C: Meter in a carrying case with IDS sensors (digital pH sensor SenTix® 940, digital conductivity cell TetraCon® 925), QSC Kit, buffer 4 and 7, conductivity standard, stand, beaker, CD-ROM, batteries, cables, power supply, arming SM Pro

Multi 3620 IDS SET G: Meter in a large carrying case with IDS sensors (digital pH sensor SenTix® 940-3, optical sensor FDO® 925-3, digital conductivity cell TetraCon® 925-3), QSC Kit, stand, beaker buffer 4 and 7, conductivity standard, CD-ROM, batteries, cable, power supply, arming SM Pro



Type	Description	PK	Cat. No.
Multi 3620	2 channels, meter only	1	6.282 919
Multi 3620 SET C	2 channels, with SenTix® 940, TetraCon® 925	1	6.270 419
Multi 3620 SET G	2 channels, with SenTix® 940, FDO® 925-3, TetraCon® 925-3	1	6.283 708

3 Multiparameter meters MultiLine® 3510 IDS

Multi 3510 IDS: Single meter in a carrying case with buffer 4, 7, KCl 3 mol/l, conductivity standard, batteries, USB cable WTW®

Multi 3510 SET 1: Meter in a carrying case with pH electrode SenTix® 940, buffer 4, 7, KCl 3 mol/l, conductivity standard, batteries, USB cable

Multi 3510 SET 3: Meter in a carrying case with conductivity sensor TetraCon® 925, conductivity standard, batteries, USB cable

Multi 3510 IDS SET 4: Meter in a carrying case with optical sensor FDO® 925, batteries, USB cable

Multi 3510 SET KS1: Single meter in a carrying case with buffer 4, 7, KCl 3 mol/l, conductivity standard, batteries, USB cable, arming SM Pro



Type	Description	PK	Cat. No.
Multi 3510	1 channel, meter only	1	6.282 979
Multi 3510 SET U	1 channel, meter only, armor SM Pro	1	6.283 706
Multi 3510 SET 1	1 channel, SenTix® 940	1	6.282 978
Multi 3510 SET 3	1 channel, TetraCon® 925	1	6.283 710
Multi 3510 SET 4	1 channel, with FDO® 925	1	6.270 393

We can supply this
manufacturer's
 whole
product range !



Multiparameter measurement/Devices

1



6.283 612

Wireless module MultiLine® IDS WLM-S

Wireless measurement of pH/Redox, conductivity, dissolved oxygen and turbidity. WTW®

- Bluetooth® LE
- Universal plug head
- Opening for electrolyte solution refilling (only pH electrodes with liquid electrolyte)
- Signal LED (RGB)

Suitable for IDS portable meters MultiLine® Multi 3630 IDS/3620 IDS/3510 IDS, as well as for IDS laboratory meters inoLab® Multi 9630 IDS/9620 IDS/9310 IDS.

Specifications

Range:	About 10 m
Continuous operating times	
IDS pH/ORP electrodes:	60 h
IDS Conductivity cells:	30 h (conductivity up to 1 S)
IDS Oxygen sensor:	9 h
IDS Turbidity sensor:	5 h
Protection class:	IP43
Power supply:	Re-chargeable LiPo battery 230mAh

Type	Description	PK	Cat. No.
Wireless module IDS WLM-S	for plug head sensor	1	6.283 617
Wireless module IDS WLM KIT	incl. USB-Charger, USB-Power supply	1	6.283 612 1
WLM-Charger	USB-Charger, cascable	1	6.283 618

2



2 Laboratory instrument inoLab® Multi 9310 IDS

Intelligent, digital IDS sensors promotes the inoLab® Multi 9310 IDS to a perfect all-rounder. The universal digital input is ready for all available laboratory IDS sensors. WTW®

No matter whether pH, conductivity or dissolved oxygen, when plugged into a suitable sensor the inoLab® Multi 9310 becomes either a pH, conductivity or dissolved oxygen meter. An integrated thermal printer (58mm width) is ready for printout of the measured data (option). Includes meter, power supply, stand and USB cable. The inoLab® Multi 9310 IDS is wireless ready.

Specifications

Display:	backlit graphic LCD
Memory:	manual: 500/automatic: 5000
Logger:	manual/time controlled
Interface:	Mini USB-B
Power supply:	Universal power supply, 100 to 240 V, 50/60 Hz

Type	Description	PK	Cat. No.
Multi 9310	Single instrument	1	9.920 120
Multi 9310 Set 1	Incl. SenTix® 940	1	9.920 121
Multi 9310 Set 2	Incl. SenTix® 980	1	9.920 122
Multi 9310 Set 3	Incl. TetraCon®925	1	9.920 123
Multi 9310 Set 4	Incl. FDO® 925	1	9.920 124
Multi 9310 Set C	Incl. SenTix® 940, TetraCon® 925	1	9.920 125
Multi 9310P*	Single instrument	1	9.920 127

*Meter with integrated printer



pH/conductivity meters SevenCompact™ Duo S213

Compact, universal dual-channel meter for measuring pH and conductivity as well as resistivity, salinity and TDS.

Mettler-Toledo Online

- Suitable for digital and analogue sensors
- Quick and easy calibration with up to 5 calibration points
- Automatic temperature compensation
- Memory for 2000 values
- Large TFT colour display
- Robust construction
- Intuitive, simple operation

Scope of supply:

S213 Meter: Device incl. electrode holder, power adapter, protective cover, operating instructions, declaration of conformity and calibration certificate

S213 Standard kit: Same as S213 meter, additionally with InLab® Expert Pro-ISM pH sensor and InLab® 731 ISM conductivity sensor, 2 bags each of buffer pH 4.01, 7.00, 9.21, and 10.01, 2 bags each of conductivity standards 1413 µS/cm and 12.88 mS/cm

S213 Water Kit: Same as S213 meter, additionally with InLab® Pure Pro ISM pH sensor and InLab® 741 ISM conductivity sensor, 2 bags each of buffer pH 4.01, 7.00, 9.21 and 10.01, 2 each of conductivity standard 1413 µS/cm

Specifications

	Measuring range // Resolution // Accuracy
Temperature range:	-5/-30.0 ... 130 °C // 0.1 °C // ±0.1 °C
pH:	0 ... 14 // 0.001/0.01/0.1 // ±0.002
mV:	-2000 ... 2000 mV // 0.1/1 // ±0.1 mV (-1000 ... 1000); ±0.2 mV (>1000 mV)
Conductivity:	0.001 µS/cm ... 1000 mS/cm // 0.001 ... 1 // ±0.5 %
Resistivity:	0.00 ... 100.0 MΩ x cm // 0.00 ... 1.0 // ±0.5 %
Salinity:	0.00 ... 80.00 psu/ppt // 0.00 ... 1.0 // ±0.5 %
TDS:	0.00 mg/l ... 1000 g/l // 0.01 ... 1 // ±0.5 %
Outputs:	RS232, USB-A/-B
Dimensions (W x D x H):	204 x 174 x 74 mm
Weight:	890 g
IP code:	IP 54



6.284 460



6.284 461



6.284 462

Type	PK	Cat. No.
SevenCompact™ Duo S213-Meter	1	6.284 460 1
SevenCompact™ Duo S213-Standard Kit	1	6.284 461 2
SevenCompact™ Duo S213-Water Kit	1	6.284 462 3

4 pH/mV, Conductivity, Oxygen meter, SevenExcellence™ S479

Triple channel instrument with pH/mV, conductivity and DO/BOD expansion units.

Mettler-Toledo Online

S479-Kit: Includes instrument, pH/mV, conductivity and DO/BOD expansion units, uPlace™ electrode holder, semi-transparent cover, operating instructions, installation and quick guide, LabX® direct pH PC software, declaration of conformity and test certificate. Included kit sensors: InLab® Expert Pro-ISM, InLab® 731-ISM and InLab® OptiOx™.

Type	PK	Cat. No.
S479-Kit	1	6.284 512



5 pH/Ion, Conductivity, Oxygen meter, SevenExcellence™ S975-uMix

Triple channel instrument with pH/Ion, DO/BOD and conductivity expansion units

Mettler-Toledo Online

S975-uMix (kit): Includes instrument, pH/Ion, DO/BOD and conductivity expansion units, uPlace™ electrode holder, semi-transparent cover, operating instructions, installation and quick guide, LabX® direct pH PC software, declaration of conformity and test certificate. Also includes the uMix™ magnetic stirrer. Kit includes the following sensors: InLab® Expert Pro-ISM, InLab® 731-ISM and InLab® OptiOx.

Type	PK	Cat. No.
S975-uMix	1	6.282 736



Balances/Pocket balances

1



1 Hanging Scales HDB-N

Convenient for hanging loads.

Kern & Sohn

- Ideal for quick checking in goods receiving and shipping, also suitable for cases.
- Data hold function: For easy reading of the weight, the display can be "frozen" in different ways. Either automatically when the weighing value remains unchanged or manually by pressing the Hold key
- Hook (stainless steel), can be hinged
- Batteries included, 2 x 1.5 V AAA, operating time approx. 180 h, AUTOOFF function to preserve the battery (can be switched off)

Type	Dimensions (W x D x H) mm	Capacity	Readability	Weight	PK	Cat. No.
		kg	g	g		
HDB 5K5N	72 x 25 x 105	5	5	200	1	6.231 173
HDB 10K10N	72 x 25 x 105	10	10	450	1	7.633 920
HDB 30K-2XL	107 x 25 x 101	30	20	200	1	4.660 770
HDB 10K-2XL	107 x 25 x 101	15	10	200	1	4.660 771
HDB 6K-3XL	107 x 25 x 101	6	5	200	1	4.660 772

2



2 Pocket balances TGC



Slim pocket balance with large stainless steel weighing plate and practical tare pan.

Kern & Sohn

- High-resolution
- Particularly rapid reaction and stabilisation time
- Cover made of shock proof plastic, can also be used as a weighing pan
- Stainless steel weighing plate
- LCD display

Specifications

Total dimension (W x D x H):	100 x 130 x 18 mm
Weight:	200 g
Temperatur range:	0 ... 40°C
Power supply:	Batteries 2 x CR2032
Operating time:	33 h

Type	Capacity	Readability	Plate diam.	PK	Cat. No.
	g	g	mm		
TGC 150-2	150	0.01	81	1	4.671 678
TGC 500-1	500	0.1	81	1	4.671 679
TGC 1K-3	1000	1.0	81	1	4.671 680

3



3 Precision balances Type EMB

The Precision balances EMB are entry-level devices in the field of laboratory balances. They can be stacked with a stack frame (optionally available) and can also be operated by battery, as an alternative to mains power, which means that they have the flexibility to be used in different locations.

Kern & Sohn

- Simple and convenient 2-key operation
- Tare function facilitates formulation work
- Flat design
- Batteries included
- EMB 100-3 with ring-shaped draught shield
- Hook for underfloor weighing
- Large LCD display
- AUTO-OFF function after 3 min

Dimensions (W x D x H):	170 x 240 x 39 mm
EMB 100-3/EMB1000-2:	170 x 240 x 54 mm
Net weight:	approx. 750 g

Type	Capacity	Readability	Reproducibility	Linearity	Plate diam.	PK	Cat. No.
	g	g	g	± g	mm		
EMB 100-3	100	0.001	0.001	0.005	82	1	6.238 426
EMB 200-3	200	0.001	0.001	0.005	82	1	7.655 256
EMB 200-2	200	0.01	0.01	0.02	105	1	9.901 320
EMB 600-2	600	0.01	0.01	0.03	105	1	9.901 321
EMB 1000-2	1000	0.01	0.01	0.05	150	1	6.235 728
EMB 2000-2	2000	0.01	0.01	0.05	150	1	7.670 022
EMB 500-1	500	0.1	0.1	0.2	150	1	9.901 322
EMB 1200-1	1200	0.1	0.1	0.3	150	1	9.901 323
EMB 3000-1	3000	0.1	0.1	0.3	150	1	6.258 933
EMB 6000-1	6000	0.1	0.1	0.3	150	1	6.254 494
EMB 2200-0	2200	1.0	1.0	2.0	150	1	9.901 371
EMB 5.2K1	5200	1.0	1.0	3.0	150	1	9.901 324
EMB 5.2 K 5	5200	5.0	5.0	10.0	150	1	9.901 372

1 Precision balance EHA



Kern & Sohn

The compact all-round model for laboratory, industry and teaching.

- High precision
- Large, shock proof weighing plate made from stainless steel
- Particularly flat design
- Simple and convenient 5-key operation
- Level indicator and levelling feet as standard
- Adjusting program CAL for quick setting of the balance accuracy
- Battery operation
- Universal mains adapter EU, GB

1



Type	Capacity	Readability	Reproducibility	Linearity	Plate dimensions	PK	Cat. No.
	g	g	g	± g	mm		
EHA 500-2	500	0.01	0.03	0.02	∅ 105	1	4.671 682
EHA 500-1	500	0.1	0.3	0.2	∅ 105	1	4.671 681
EHA 3000-1	3000	0.1	0.3	0.3	120 x 120	1	4.671 684
EHA 3000-0	3000	1	3	2	120 x 120	1	4.671 683

2 Compact balances Compass™ CX

Balance series with high battery life for daily weighing tasks. With a large weighing platform for a variety of mobile weighing applications in laboratories, industry and education.

OHAUS

- Battery life up to 1000 hours in continuous operation
- Backlit LCD display, digit height 18 mm
- Easy and convenient 2-button operation
- ABS housing and stainless steel weighing platform with non-slip feet

Scope of delivery: Balance incl. 3 AA batteries included.

Please order power adapter separately.

Dimensions (W x D x H): 135 x 201 x 41 mm
 Dimensions plate (W x D): 128 x 142 mm
 Weight: 500 g

2



Type	Capacity	Readability	PK	Cat. No.
	g	g		
CX221	220	0.1	1	6.275 393
CX621	620	0.1	1	6.275 416
CX1201	1200	0.1	1	6.275 417
CX2200	2200	1.0	1	6.275 418
CX5200	5200	1.0	1	6.275 419

3 Compact balances Compass™ CR

Economic balance series for basic weighing. With a large weighing platform for a variety of mobile weighing applications in laboratories, industry and education.

OHAUS

- Battery life up to 300 hours in continuous operation
- Backlit LCD display, digit height 15 mm
- Easy and convenient 2-button operation
- ABS housing and weighing platform with non-slip feet

Scope of supply: Balance incl. 3 AA batteries included.

Please order power adapter separately.

Dimensions (W x D x H): 140 x 205 x 41 mm
 Dimensions plate (W x D): 125 x 132 mm
 Weight: 400 g

3



Type	Capacity	Readability	PK	Cat. No.
	g	g		
CR221	220	0.1	1	6.275 420
CR621	620	0.1	1	6.275 421
CR2200	2200	1.0	1	6.275 422
CR5200	5200	1.0	1	6.275 423

Suitable accessories can be found in our online shop.

Balances/Pocket balances

1



6.281 350

2



6.281 354

Portable Balances, Scout® SKX

- Superior overload protection and practical stackable design for convenient storage
- Bright backlit LCD and 4 button operation make the new scout easy to see and use
- Multiple connectivity options are available for data logging and communication
- Fast weighing speed and high resolution delivers repeatable and reliable results
- Application: Weighing, density determination, mole weighing
- Display: Backlit LCD: 6-digit 7-segment with white LED backlight
- Operation: AC adapter (included), batteries (not included)
- Communication: Optional RS232, USB host, USB device, Bluetooth or Ethernet
- Construction: ABS housing, stainless steel pan, replaceable in-use cover
- Design Features: Fast stabilization time, menu lock switch, stackable design, security slot, integral weigh below hook for below balance weighing applications, transportation lock, removable stainless steel weighing platform, stability indicator, overload and underload indicators, low battery indicator, auto shut-off

OHAUS

Type	Plate dimensions	Capacity	Readability	PK	Cat. No.
	mm	g	g		
SKX123	diam. 93	120	0.001	1	6.281 344
SKX222	diam.120	220	0.01	1	6.281 345
SKX422	diam. 120	420	0.01	1	6.281 346
SKX622	diam. 120	620	0.01	1	6.281 347
SKX1202	170 x 140	1200	0.01	1	6.281 348
SKX2202	170 x 140	2200	0.01	1	6.281 349
SKX421	diam. 120	420	0.1	1	6.281 350 1
SKX621	170 x 140	620	0.1	1	6.281 351
SKX2201	170 x 140	2200	0.1	1	6.281 352
SKX6201	170 x 140	6200	0.1	1	6.281 353
SKX8200	170 x 140	8200	1	1	6.281 354 2

3



6.281 362

4



6.281 366

Portable Balances, Scout® STX

- Navigate quickly and efficiently using the informative color touchscreen display
- Fast weighing speed and high resolution deliver repeatable and reliable results
- Superior overload protection and stackable storage drive overall durability
- Multiple weighing modes and languages for simplified weighing
- Application: Weighing, percent weighing, parts counting, check weighing, dynamic/animal weighing, totalization, density determination, display hold, mole weighing
- Display: Full-color touchscreen WQVGA graphic LCD (4.3" diagonal), QWERTY keyboard and numeric keypad to quickly input GLP and GMP data and other application data
- Operation: AC adapter (Included), batteries (not included)
- Communication: Optional RS232, USB host, USB device, Bluetooth or Ethernet
- Construction: ABS housing, stainless steel pan, replaceable in-use cover
- Design Features: Fast stabilization time, up-front level indicator, up to 9 operating languages, save-to-USB function, menu lock switch, stackable design, security slot, integral weigh below hook for below balance weighing applications, transportation lock, removable stainless steel weighing platform, stability indicator, overload and underload indicators, low battery indicator, auto shut-off

OHAUS

Type	Plate dimensions	Capacity	Readability	PK	Cat. No.
	mm	g	g		
STX123	diam. 93	120	0.001	1	6.281 355
STX223	diam. 93	220	0.001	1	6.281 356
STX222	diam. 120	220	0.01	1	6.281 357
STX422	diam. 120	420	0.01	1	6.281 358
STX622	diam. 120	620	0.01	1	6.281 359
STX1202	170 x 140	1200	0.01	1	6.281 360
STX2202	170 x 140	2200	0.01	1	6.281 361
STX421	diam. 120	420	0.1	1	6.281 362 3
STX621	170 x 140	620	0.1	1	6.281 363
STX2201	170 x 140	2200	0.1	1	6.281 364
STX6201	170 x 140	6200	0.1	1	6.281 365
STX8200	170 x 140	8200	1	1	6.281 366 4

Suitable accessories can be found in our online shop.

Portable Balances Navigator™

The rugged and multifunctional Navigator™ is a powerful balance for essential weighing applications as weighing, parts counting, percent weighing and checkweighing, providing high accuracy and repeatability for laboratory, industry and education.

OHAUS

- Backlit LCD display, digit size 20 mm
- 4 quick keys for easy operation of multiple weighing modes
- User-selectable external span calibration or linearity calibration, digital with external weight
- ABS housing with stainless steel weighing plate
- Stability indicator and low-battery indicator
- Optional RS232, USB or Ethernet interfaces

Please note:

Models with type suffix M are approved devices according to EN 45501 Class III

Scope of supply: Balance, mains adapter

Type	Capacity	Readability	Plate dimensions	Dimensions (W x D x H)	Weight	PK	Cat. No.
	g	g	mm	mm	kg		
NV222	220	0.01	Ø 145	204 x 230 x 70	1.0	1	4.668 242 1
NV422	420	0.01	Ø 145	204 x 230 x 70	1.0	1	4.668 243
NV622	620	0.01	Ø 145	204 x 230 x 70	1.0	1	4.668 244
NV221	220	0.1	190 x 144	204 x 230 x 70	1.0	1	4.668 245 2
NV621	620	0.1	190 x 144	204 x 230 x 70	1.0	1	4.667 893
NV1201	1200	0.1	190 x 144	204 x 230 x 70	1.0	1	4.668 246
NV2201	2200	0.1	190 x 144	204 x 230 x 70	1.0	1	4.668 247
NVT2201	2200	0.1	230 x 174	240 x 250 x 74	1.5	1	4.668 248
NVT4201	4200	0.1	230 x 174	240 x 250 x 74	1.5	1	4.668 249
NVT6201	6200	0.1	230 x 174	240 x 250 x 74	1.5	1	4.668 251
NVT2200	2200	1.0	230 x 174	240 x 250 x 74	1.5	1	4.668 250
NVT6200	6200	1.0	230 x 174	240 x 250 x 74	1.5	1	4.668 252
NVT12000	12000	1.0	230 x 174	240 x 250 x 74	1.5	1	4.668 253
NVT22000	22000	1.0	230 x 174	240 x 250 x 74	1.5	1	6.275 499
NVT1601M	1600	0.5	230 x 174	240 x 250 x 74	1.5	1	4.668 254
NVT3200M	3200	1.0	230 x 174	240 x 250 x 74	1.5	1	4.668 255
NVT6400M	6400	2.0	230 x 174	240 x 250 x 74	1.5	1	4.668 256
NVT16000M	16000	5.0	230 x 174	240 x 250 x 74	1.5	1	4.668 259



4.668 242



4.668 245

3 4 Digital weighing platforms KDP



Kern & Sohn

Universal weighing platforms for flexible connection into process chains. All recorded values can be transferred to the system as digital data using the available interfaces and processed further.

Searching and remote control of the balance using external control devices or computers with the KERN Communication Protocol (KCP). KCP is a standardised interface command structure for KERN balances and other instruments which allows you to recall and manage all relevant parameters and device functions. You can therefore simply connect KERN devices with KCP to computers, industrial control systems and other digital systems. In a large number of cases the KCP is compatible with the MT-SICS protocol. DAkkS calibration certificate optionally available.

- PRE-TARE function
- Freely programmable weighing unit
- Level indicator and levelling feet

Scope of supply: Digital weighing platform KDP, Software balance connection, universal mains adapter (EU, GB, CH, USA), KDP 300-3 additionally with draught shield

Specifications

Overall dimensions (W x D x H):	165 x 166 x 75 mm
Cable length:	1.2 m
Weight:	1.2 kg
Permissible ambient temperature range:	5 ... 35 °C
Material weighing plate:	plastic, with conductive lacquer
KDP 300-3	stainless steel
KDP 3000-2, KDP 10K-4, KDP 10K-3	stainless steel
Data interface:	USB

Type	Weighing range	Readability	Reproducibility	Linearity	Plate dimensions	PK	Cat. No.
	g	g	g	± g	mm		
KDP 300-3	350	0.001	0.002	0.005	Ø 105	1	4.671 671
KDP 3000-2	3500	0.01	0.02	0.05	160 x 160	1	4.671 672
KDP 10K-4	10000	0.1	0.1	0.3	160 x 160	1	4.671 673
KDP 10K-3	10000	1	1	3	160 x 160	1	4.671 674

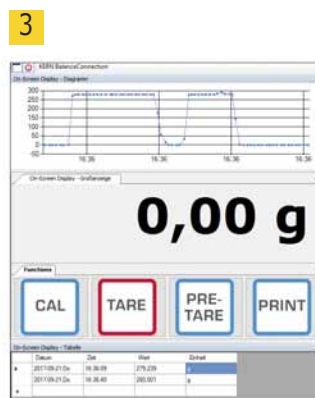

Balances/Pocket balances-Precision balances



4.672 673



4.672 674

Compact Balances EK-AEP, Ex-protected

NEW
A&D Inst.



Compact, lightweight balance for precise weighing in potentially explosive atmospheres (zones 0, 1 and 2). Equipped with an optical data output for transferring measuring results to device in a distant, safe area.

- Easy-to-read backlit LCD display, digit size 16 mm
- Hygienic and chemically resistant stainless steel (SUS304) weighing pan
- Comparator function for faster and more accurate filling, packing, sorting, etc
- Adjustable response characteristics depending on the degree of drafts and vibrations at the location
- Multiple weighing units: g, oz, lb, ozt, ct, mom, dwt, gr, N, in addition to pcs (counting mode), % (percent mode), SG (specific gravity)
- Battery operation (4 x AA alkaline batteries 1.5 V, approx. 250 hours)
- Auto power OFF function

Please order fibre optic cable and optical communication interface AD-1611 separately.

Type	Capacity	Readability	Plate dimensions	Dimensions (W x D x H)	Net weight	PK	Cat. No.
	g	g	mm	mm	kg		
EK-300AEP	300	0.01	Ø 110	190 x 218 x 54	1.2	1	4.672 673 1
EK-3000AEP	3000	0.1	133 x 170	190 x 218 x 53	1.5	1	4.672 674 2
EK-12AEP	12000	1.0	133 x 170	190 x 218 x 53	1.5	1	4.672 675

Precision balance Type PCB

Compact scale for your laboratory. Due to the Recipe and piece counting function, as well as the grand precision this scale is perfect for the daily use in the Laboratory.

Kern & Sohn

- Protective working cover over keyboard and housing is enclosed o standard.
- Modern, backlit LCD display, digit height 15 mm
- Optional battery operation, 9V Block, not included.
- AUTO-OFF funktion to preserve the battery, can be switched off
- Stainless steel weighing plate, the models PCB 100-3, PCB 250-3 and PCB 350-3 has a plastic weighing plate

Overall (W x D x H): 163 x 245 x 85mm
Weight: approx. 1kg

Type	Plate dimensions	Capacity	Readability	Reproducibility	Linearity	PK	Cat. No.
	mm	g	g	g	± g		
PCB 100-3	Ø 81	100	0.001	0.001	0.003	1	7.619 757 3
PCB 250-3	Ø 81	250	0.001	0.001	0.005	1	6.238 044
PCB 350-3	Ø 81	350	0.001	0,002	0.005	1	6.241 856
PCB 200-2	Ø 105	200	0.01	0.01	0.02	1	7.635 868 4
PCB 1000-2	130 x 130	1000	0.01	0.01	0.03	1	6.228 513
PCB 2500-2	130 x 130	2500	0.01	0.01	0.05	1	6.235 556
PCB 3500-2	130 x 130	3500	0.01	0.02	0.05	1	6.240 408
PCB 1000-1	130 x 130	1000	0.1	0.1	0.2	1	6.235 098 5
PCB 2000-1	130 x 130	2000	0.1	0.1	0.2	1	6.229 399
PCB 6000-1	150 x 170	6000	0.1	0.1	0.3	1	6.231 685 6
PCB 10000-1	150 x 170	10000	0.1	0.1	0.3	1	7.625 237
PCB 6000-0	150 x 170	6000	1	1	2	1	9.901 300



7.619 757



7.635 868



6.235 098



6.231 685

1 Precision balance KB

Convenience model at an economical price

Kern & Sohn

- User guidance step by step in the display
- Freely programmable weighing units, e.g. display directly in special units such as the length of thread g/m, paper weight g/m², or similar
- Precise counting. The automatic reference optimization gradually improves the average value of the piece weighing
- Numerical tare deduction for container weighing. Useful when checking loads
- Ring-shaped draft shield standard, 90 x 40mm dia. x ht. for models with readability d = 0.001g

Also available with DKD certified calibration weight, thermal printer, statistics printer at additional cost.



Type	Capacity	Readability	Reproducibility	Linearity	Plate dimensions	PK	Cat. No.
	g	g	g	± g	mm		
KB 120-3N	120	0,001	0,001	0,003	Ø 81	1	6.234 511
KB 240-3N	240	0,001	0,001	0,003	Ø 81	1	6.235 214
KB 360-3N	360	0,001	0,002	0,005	Ø 81	1	9.901 402
KB 650-2N	650	0,01	0,01	0,03	130 x 130	1	4.671 690
KB 1200-2N	1200	0,01	0,01	0,03	130 x 130	1	6.233 613
KB 2000-2N	2000	0,01	0,01	0,03	130 x 130	1	6.231 607
KB 2400-2N	2400	0,01	0,01	0,03	130 x 130	1	9.901 403
KB 3600-2N	3600	0,01	0,02	0,05	130 x 130	1	9.901 404
KB 6500-1N	6500	0,1	0,1	0,3	150 x 170	1	6.291 473
KB 10K0.05N	10000	0,05	0,05	0,15	150 x 170	1	9.901 405
KB 10000-1N	10000	0,1	0,1	0,3	150 x 170	1	9.901 406

Precision balance EWJ

Verifiable entry level model in the upper laboratory class

Kern & Sohn

- Concept of easy use: All primary functions have their own key on the keypad
- Automatic internal adjustment time-controlled every 2 hours. Guarantees high degree of accuracy and makes the location irrelevant
- Compact size, practical for small spaces
- Capacity display: A bar lights up to show how much of the weighing range is still available
- RS-232 and USB interfaces for transferring weighing data to the PC, printer, USB sticks etc. Excluded the -SM Models.

EWJ 300-3/EWJ 600-2SM/EWJ 600-2M: Draft shield with removable cover and opening for using a pipette, with a weighing chamber of (W x D x H) 134 x 128 x 80 mm

EWJ 300-3H: Large glass draft shield with a weighing chamber (W x D x H) 175 x 155 x 217 mm



9.900 938

Type	Plate dimensions	Weighing range	Readability	Linearity	PK	Cat. No.
	mm	g	g	± g		
EWJ 300-3	Ø 80	300	0.001	0.005	1	9.900 938 2
EWJ 300-3H	Ø 80	300	0.001	0.005	1	6.287 029
EWJ 3000-2	Ø 120	3000	0.01	0.05	1	6.283 420

Balances, electronic, compact, 440 series

With features including formulation, piece counting programmes and high accuracy these balances are ideal for routine laboratory tasks. Safety cover for keyboard and housing standard. Calibration adjustment programme maintains accuracy. LCD display with digit height 15 mm. Can be battery operated (9 V Block). With stainless steel balance platform, except 440-21A.

Kern & Sohn

Overall (W x D x H): 165 x 230 x 80mm
 Weight: approx. 1kg
 Power supply: 100-240V, 50/60Hz



9.901 348

Type	Plate dimensions	Capacity	Readability	Reproducibility	Linearity	PK	Cat. No.
	mm	g	g	g	± g		
440-21A	81 dia.	60	0.001	0.001	0.003	1	9.901 340
440-33N	105 dia.	200	0.01	0.01	0.02	1	9.901 348 3
440-35N	105 dia.	400	0.01	0.01	0.03	1	9.901 349
440-35A	105 dia.	600	0.01	0.01	0.03	1	9.901 341
440-43N	130 x 130	400	0.1	0.1	0.2	1	9.901 344 4
440-45N	130 x 130	1000	0.1	0.1	0.2	1	9.901 346
440-47N	130 x 130	2000	0.1	0.1	0.2	1	9.901 347
440-49N	170 x 150	4000	0.1	0.1	0.3	1	9.901 343
440-49A	170 x 150	6000	0.1	0.1	0.3	1	9.901 342
440-51N	170 x 150	4000	1.0	1.0	2.0	1	9.901 345
440-53N	170 x 150	6000	1.0	1.0	2.0	1	9.901 350



9.901 344

Balances/Precision balances

1



9.901 011

Precision balances type EW-N and EG-N

High quality laboratory balances, housed in a robust and stable plastic casing. With bar graph capacity display which shows the current available weighing range remaining. Fitted with protective working cover for casing and keyboard. Suitable for EC verification (only EG-N models, factory option at additional cost - details on request). Convenient, internal automatic calibration (only type EG-N) as well as extensive configuration and a menu of applications. Draught shield supplied with all 0.001g readability models. Additionally supplied with parts counting facility, percentage weighing function, flush-mounted platform. Optional available: Thermal printer, statistics printer, internal Akku-Pack, DKD calibration certificate for balance and optional test weight.

Kern & Sohn

Type	Plate dimensions	External dimensions (W x D x H)	Capacity	Readability	Reproducibility	Linearity	PK	Cat. No.
	mm	mm	g	g	g	± g		
EW220-3NM	Ø 118	182 x 235 x 75	220	0.001	0.001	0.002	1	9.901 007
EW420-3NM	Ø 118	182 x 235 x 75	420	0.001	0.001	0.003	1	9.901 008
EW620-3NM	Ø 118	182 x 235 x 75	620	0.001	0.001	0.003	1	9.901 009
EW820-2NM	170 x 140	182 x 235 x 75	820	0.01	0.01	0.01	1	9.901 010
EW2200-2NM	180 x 160	192 x 275 x 87	2200	0.01	0.01	0.01	1	9.901 011 1
EW4200-2NM	180 x 160	192 x 275 x 87	4200	0.01	0.01	0.02	1	9.901 012
EW6200-2NM	180 x 160	192 x 275 x 87	6200	0.01	0.01	0.03	1	9.901 013
EW12000-1NM	180 x 160	192 x 275 x 87	12000	0.1	0.1	0.2	1	9.901 014
EG220-3NM*	Ø 118	182 x 235 x 75	220	0.001	0.001	0.002	1	9.901 018
EG420-3NM*	Ø 118	182 x 235 x 75	420	0.001	0.001	0.003	1	9.901 019
EG620-3NM*	Ø 118	182 x 235 x 75	620	0.001	0.001	0.004	1	9.901 015
EG2200-2NM*	180 x 160	192 x 275 x 87	2200	0.01	0.01	0.01	1	9.901 016
EG4200-2NM*	180 x 160	192 x 275 x 87	4200	0.01	0.01	0.02	1	9.901 017

*calibratable
Outer dimensions without wind shield.

2



6.072 474

3



6.223 158

Printers for KERN® balances

For printing weights. Compatible for all balances with RS232 interface. Please state your balance model when ordering, so that the printer can be preconfigured in the factory to suit your balance.

Kern & Sohn

Matrix needle printer for archiving: Not suitable for the PNS/PNJ and PES/PEJ models
Thermal printer with statistics functions: Not suitable for counting scales, EWJ models, PFB models and moisture analyzers

Description	Width	Depth	Height	Width paper strip	PK	Cat. No.
	mm	mm	mm	mm		
Matrix needle printer for archiving	100	180	106	57	1	6.072 474 2
Matrix needle printer	106	158	40	44	1	7.659 886
Thermal printer, GLP capable	165	140	50	112	1	6.223 158 3
Thermal printer with statistics functions	165	140	50	112	1	6.255 389

4



6.270 591

Precision balance PNS/PNJ

With robust tuning fork weighing system for fast display of the weight value, accurate dosing and high mechanical load capacity.

Kern & Sohn

- PNJ models with internal calibration function and guaranteed high accuracy, thus location-independent and ideal for mobile applications which require verification
- PNS models with external calibration function
- Capacity display: A bar lights up to show how much of the weighing range is still available
- Accurate counting: The automatic reference optimization gradually improves the average value of the part weight
- Compact dimensions, advantageous when space is limited
- Stainless steel weighing plate
- Models 600-3 and 600-3M have a large removable glass draft shield and a weighing chamber measuring (W x D x H) 172 x 171 x 160 mm.
- Large LCD display, digit height 16.5 mm
- Permissible ambient temperature range: 5 to 40 °C

5



7.643 634

Type	Plate dimensions	External dimensions (W x D x H)	Capacity	Readability	Reproducibility	Linearity	Weight	PK	Cat. No.
	mm	mm	g	g	g	± g	kg		
PNS 600-3	Ø 140	202 x 293 x 266	620	0.001	0.001	0.004	4.2	1	6.281 583
PNS 3000-2	190 x 190	196 x 293 x 89	3200	0.01	0.01	0.02	3.5	1	6.284 227
PNS 12000-1	190 x 190	196 x 293 x 89	12000	0.1	0.1	0.2	3.5	1	6.284 228
PNJ 600-3M*	Ø 140	202 x 293 x 266	620	0.001	0.001	0.004	4.2	1	6.270 591 4
PNJ 3000-2M*	190 x 190	196 x 293 x 89	3200	0.01	0.01	0.02	3.5	1	7.643 634 5
PNJ 12000-1M*	190 x 190	196 x 293 x 89	12000	0.1	0.1	0.2	3.5	1	7.644 987

*calibratable

1 Precision balances PR

The precision balances PR combine the basic weighing functions, weighing, piece counting and percent weighing with competitive performance, providing high accuracy and repeatability for laboratory, industrial and educational applications.

OHAUS



- Backlit LCD display
- 4 quick keys for easy operation of multiple weighing modes
- RS 232 interface
- User-selectable span calibration points
- Detachable stainless steel weighing platform
- Integrated weigh-below-hook
- Auto-tare
- Overload, underload and stability indicator

Please note:

Models with extra code /E with external calibration, all other models with internal calibration, models with extra code M are approved instruments according to EN 45501; OIML R76.

Specifications

Permissible ambient temperature:	10 ... 30 °C
Weighing plate (Ø):	180 mm
Dimensions (W x D x H):	201 x 317 x 93 mm
Weight:	3.5 kg
Power supply:	100 ... 240 V, 50/60 Hz

Type	Weighing range g	Readability g	Reproducibility g	Linearity ± g	PK	Cat. No.
PR1602	1600	0.01	0.01	0.02	1	4.668 281
PR1602/E*	1600	0.01	0.01	0.02	1	4.668 279
PR1602M **	1600	0.01	0.01	0.02	1	4.668 280
PR2202	2200	0.01	0.01	0.02	1	4.668 283
PR2202/E*	2200	0.01	0.01	0.02	1	4.668 282
PR2202M **	2200	0.01	0.01	0.02	1	4.668 284
PR4202	4200	0.01	0.01	0.02	1	4.668 286
PR4202/E*	4200	0.01	0.01	0.02	1	4.668 285
PR4202M **	4200	0.01	0.01	0.02	1	4.668 287
PR4201	4200	0.1	0.1	0.2	1	4.668 289
PR4201/E*	4200	0.1	0.1	0.2	1	4.668 288
PR4201M **	4200	0.1	0.1	0.2	1	4.668 290
PR6201	6200	0.1	0.1	0.2	1	4.668 292
PR6201/E*	6200	0.1	0.1	0.2	1	4.668 291
PR6201M **	6200	0.1	0.1	0.2	1	4.668 293

*external calibration
**approved acc. to EN 45501; OIML R76

2 Precision balances PES/PEJ

Robust laboratory and industrial precision scale for heavy items.

Kern & Sohn

- Only PEJ: Automatic internal adjustment
- Only PES: Adjusting program CAL for quick setting of the balance accuracy, with an external test weight (must be purchased separately)
- Metal housing: robust and sturdy
- Weighing with tolerance range (checkweighing): Input of 2 upper and 2 lower limit values through 4 arrow keys. An audible and visual signal assists with the portioning, dispensing or grading
- Draught shield standard on all models with readout = 0.001 g, weighing space (W x D x H): 170 x 150 x 100 mm. Removable metal cover with pipette opening
- Underfloor weighing: load support with hook on the underside of the balance (only for models with a weighing plate size of 140x120 mm and 200x200 mm)
- Fluorescent display, bright with high contrast, digit height 13 mm
- Permissible ambient temperature: 10 °C/30 °C



Type	Plate dimensions mm	External dimensions (W x D x H) mm	Capacity g	Readability g	Reproducibility g	Linearity ± g	Weight kg	PK	Cat. No.
PES 620-3M	140 x 120	220 x 330 x 90	620	0.001	0.001	0.003	4	1	7.651 840
PES 2200-2M	200 x 200	220 x 339 x 80	2200	0.01	0.01	0.02	6	1	6.225 841
PES 4200-2M	200 x 200	220 x 339 x 80	4200	0.01	0.01	0.02	6	1	6.229 872
PES 6200-2M	200 x 200	220 x 339 x 80	6200	0.01	0.01	0.03	6	1	6.236 499
PES 15000-1M	200 x 200	220 x 339 x 80	15000	0.1	0.1	0.2	6	1	7.920 074
PES 31000-1M	250 x 220	260 x 330 x 113	31000	0.1	0.1	0.4	10	1	6.237 670
PEJ 620-3M*	140 x 120	220 x 330 x 90	620	0.001	0.001	0.003	4	1	7.670 597
PEJ 2200-2M*	200 x 200	220 x 339 x 80	2200	0.01	0.01	0.02	6	1	7.623 390
PEJ 4200-2M*	200 x 200	220 x 339 x 80	4200	0.01	0.01	0.02	6	1	6.235 603

*calibratable
Outer dimensions without wind shield.

Balances/Precision balances

1



1 Precision balances Pioneer® PX

OHAUS

High-performance, economical balances with high accuracy and repeatability for applications in laboratories, industry and education. For basic weighing, parts counting, percent weighing, dynamic weighing and density determination.

- 2 line, backlit LCD display
- 4 quick keys enable the most common weighing modes
- USB and RS 232 interface for data exchange with PCs and PLCs
- User-selectable span calibration points
- Real time clock with GLP/GMP data
- Cast metal lower housing, removable stainless steel weighing pan
- Integrated weigh-below-hook
- Auto-tare
- Many weighing units selectable, a custom unit can be defined
- Overload, underload and stability indicator
- 4 menu languages

Please note:

Models with extra code /E with external calibration, all other models with internal calibration, models with extra code M are approved instruments according to EN 45501; OIML R76.

Specifications

Permissible ambient temperature:	10 ... 30 °C
Weighing plate (Ø):	180 mm
Height in draftshield:	235 mm
Dimensions (W x D x H):	209 x 321 x 98 mm
Weight:	3.5 kg
Power supply:	100 ... 240 V, 50/60 Hz

Type	Weighing range g	Readability g	Reproducibility g	Linearity ± g	PK	Cat. No.
PX3202	3200	0.01	0.01	0.02	1	4.663 339
PX3202/E*	3200	0.01	0.01	0.02	1	4.663 338
PX3202M**	3200	0.01	0.01	0.02	1	4.663 340
PX5202	5200	0.01	0.01	0.02	1	4.663 342
PX5202/E*	5200	0.01	0.01	0.02	1	4.663 341
PX5202M**	5200	0.01	0.01	0.02	1	4.663 343
PX4201	4200	0.1	0.1	0.2	1	4.663 345
PX4201/E*	4200	0.1	0.1	0.2	1	4.663 344
PX4201M**	4200	0.1	0.1	0.2	1	4.663 346

*external calibration

**approved acc. to EN 45501; OIML R76



Precision balance Type PLS/PLJ

- ergonomically optimised keypad for left and right-handed users
- ring-shaped glass draught shield standard for all models with a weighing plate size of 110 mm dia. Removable metal cover with pipette opening. Weighing space 150 mm dia., height 60 mm
- The PLJ with a weighing plate size of 110 mm dia. also includes a rectangular draft shield with a weighing chamber of 160 x 140 x 205 mm
- count/weight switchover at the press of a button
- precise counting. The automatic optimisation of reference weight gradually improves the average value of the piece weight. The automatic optimisation of reference weight gradually improves the average value of the piece weight
- weighing with tolerance range Input of an upper/lower limit value. A visual signal assists with portion division, dispensing or grading
- percentage determination makes it possible to store a given weight value (100%) and to determine deviations from this target value in %
- density determination of liquids and solids with immediate display of the density on the display
- pre-Tare function for manual deduction of a known container weight. Useful for checking fill-levels

Kern & Sohn

1



9.901 444

2



6.270 252

Type	Plate dimensions	Weighing range	Readability	Reproducibility	Linearity	PK	Cat. No.
	mm	g	g	g	± g		
PLS 420-3F	Ø 110	420	0.001	0.001	0,004	1	9.901 442
PLS 720-3A	Ø 110	720	0.001	0.001	0,002	1	9.901 413
PLS 1200-3A	Ø 110	1200	0.001	0.001	0,003	1	9.901 414
PLS 4200-2F	Ø 160	4200	0.01	0.01	0,04	1	9.901 422
PLS 6200-2A	Ø 160	6200	0.01	0.01	0,03	1	9.901 418
PLS 8000-2A	Ø 160	8200	0.01	0.01	0,04	1	9.901 443
PLS 20000-1F	200 x 175	20000	0.1	0.1	0,4	1	9.901 444 1
PLJ 420-3F	Ø 110	420	0.001	0.001	0,003	1	6.257 142
PLJ 720-3A	Ø 110	720	0.001	0.001	0,002	1	7.656 106
PLJ 1200-3A	Ø 110	1200	0.001	0.001	0,003	1	7.655 341
PLJ 2000-3A	Ø 110	2100	0.001	0.002	0,004	1	6.270 252 2
PLJ 4200-2F	Ø 160	4200	0.01	0.02	0,04	1	7.970 683
PLJ 6200-2A	Ø 160	6200	0.01	0.01	0,03	1	7.627 832
PLJ 720-3AM*	Ø 110	720	0.001	0.001	0,002	1	6.284 455
PLJ 6200-2AM*	Ø 160	6200	0.01	0.01	0,03	1	6.266 315

*calibratable

Precision balance Type PBS/PBJ

- only PBJ: Automatic internal adjustment in case of a change in temperature or time-controlled at defined intervals
- Metal housing: robust and sturdy
- Large backlit, LCD display, digit height 14 mm
- Dosage aid: High-stability mode and other settings can be selected
- Weighing with tolerance range (checkweighting): Input of an upper/lower limit value. A visual signal assists with portion division, dispensing or grading
- Totalizing of individual weighing results
- Identification number: 4 numeric positions, printed on calibration protocol
- Automatic data output to the PC/printer every time the balance is steady
- Draft shield standard, on all models with readout d = 0.001 g, weighing space (W x D x H): 180 x 193 x 87mm

Kern & Sohn

3



7.657 889

4



6.245 038

Single-cell advanced technology:

- Fully automatic manufactured weighing cell from one piece of material
- Stable temperature behaviour
- Short stabilisation time: 3 sec
- Shock proof construction
- High corner load performance

Specifications

Overall dimensions, without draft shield (W x D x H): 209 x 322 x 78mm
 Dimensions weighing space (W x D x H): 180 x 193 x 87mm
 Permissible ambient temperature: 10°C/30°C
 Weight: approx. 3kg

Type	Readability	Capacity	Reproducibility	Linearity	Plate dimensions	PK	Cat. No.
	g	g	g	± g	mm		
PBS 620-3M	0,001	620	0,001	0,002	108 x 105	1	7.657 889 3
PBS 4200-2M	0,01	4200	0,01	0,02	170 x 180	1	6.255 611
PBS 6200-2M	0,01	6200	0,01	0,02	170 x 180	1	9.901 445
PBJ 620-3M	0,001	620	0,001	0,002	108 x 105	1	7.910 128
PBJ 4200-2M	0,01	4200	0,01	0,02	170 x 180	1	6.245 038 4
PBJ 6200-2M	0,01	6200	0,01	0,02	170 x 180	1	6.236 719
PBJ 8200-1M	0,1	8200	0,1	0,2	170 x 180	1	6.257 002

Balances/Precision balances

1



1 Precision Balances Adventurer® AX

OHAUS

- Fast stabilization and reliable operation to ensure solid weighing performance and accurate, repeatable results.
- Two USB ports with GLP/GMP tracking capabilities assist the monitoring and reporting of the data.
- The wide viewing angle 4.3" colour touchscreen provides access to all applications.
- Reduced footprint due to two piece, top-mounted draft shield doors
- The 0.01g models feature large weighing pans
- AutoCal™ automatic internal calibration system or traditional external calibration (external calibration models -/E)
- EC Type Approved models available
- Applications: Weighing (17 units + custom unit), parts counting, percentage weighing, check weighing, dynamic weighing, totalization/statistics, formulation, density determination, display hold.
- Display: 4.3" (109 mm) Full-colour VGA graphic touchscreen with user-controlled brightness,
- Operation: Mains operation.
- Communication: RS232, USB Host, USB Device (included). GLP/GMP compliant data output with real-time clock
- Construction: Die-cast metal base, ABS top housing, stainless steel pan, glass draft shield with two piece top mounted side doors and sliding top door (0.1 and 1mg models only), illuminated up-front level indicator, integral weigh below hook, security bracket, calibration lock, full housing in-use cover
- Design features: Two-piece, top mounted, space-saving draft shield with removable panels on 0.1mg and 0.001g models. AutoCal™ automatic internal calibration or external calibration. Level assist feature with illuminated level indicator. Selectable environmental and auto-print settings. Integral weigh below hook. Protective full housing in-use cover. Software lock switch.

Type	Plate dimensions	Weighing range	Readability	PK	Cat. No.
	mm	g	g		
AX223	Ø 130	220	0.001	1	6.268 208
AX223/E	Ø 130	220	0.001	1	6.266 893
AX423	Ø 130	420	0.001	1	6.268 210
AX423/E	Ø 130	420	0.001	1	6.268 212
AX523	Ø 130	520	0.001	1	6.268 213
AX523/E	Ø 130	520	0.001	1	6.268 215
AX422	175 x 195	420	0.01	1	6.280 937
AX422/E	175 x 195	420	0.01	1	6.280 938
AX822	175 x 195	820	0.01	1	6.280 939
AX822/E	175 x 195	820	0.01	1	6.280 940
AX1502	175 x 195	1520	0.01	1	6.268 218
AX1502/E	175 x 195	1520	0.01	1	6.268 220
AX2202	175 x 195	2200	0.01	1	6.267 263
AX2202/E	175 x 195	2200	0.01	1	6.268 222
AX4202	175 x 195	4200	0.01	1	6.268 223
AX4202/E	175 x 195	4200	0.01	1	6.268 225
AX5202	175 x 195	5200	0.01	1	6.268 226
AX2201	175 x 195	2200	0.1	1	6.280 941
AX2201/E	175 x 195	2200	0.1	1	6.280 942
AX4201	175 x 195	4200	0.1	1	6.280 943
AX4201/E	175 x 195	4200	0.1	1	6.280 944
AX8201	175 x 195	8200	0.1	1	6.280 945
AX8201/E	175 x 195	8200	0.1	1	6.280 946



Precision balances Entris® II

- Modern sensors ensure very fast stabilisation time
- Automatic, internal calibration and adjustment function (isoCAL) for all "i" models
- Weighing platform made of stainless steel
- Excellent readability and operability with hybrid touch display
- Automatic detection of connected Sartorius accessories
- Direct data transfer to connected PCs with USB-C and RS232 interface without need of additional software
- 12 integrated applications with GLP/GMP-compliant protocol
- Easy to clean, high chemical resistance
- Multilingual interface

Sartorius Lab Instruments

1 Precision balances Entris® II

NEW

All models also available as approved versions for EU/France.

Sartorius Lab Instruments

Scope of supply: Precision balance, power supply unit, display protection cover**Specifications**

Weighing platform: 182 x 182 mm
 Dimensions (W x D x H): 219 x 317 x 94 mm
 Power supply: 100 ... 240 V, 50 ... 60 Hz

Type	Capacity	Readability	Reproducibility	Linearity	Weight	PK	Cat. No.
	g	g	g	± g	kg		
BCE622-1S	620	0.01	0.005	0.006	4.3	1	4.669 157
BCE622i-1S	620	0.01	0.005	0.006	6.2	1	4.669 160
BCE822-1S	820	0.01	0.005	0.006	4.3	1	4.669 181
BCE822i-1S	820	0.01	0.005	0.006	6.2	1	4.669 184
BCE1202-1S	1200	0.01	0.005	0.006	4.3	1	4.669 105
BCE1202i-1S	1200	0.01	0.005	0.006	6.2	1	4.669 108
BCE2201-1S	2200	0.1	0.05	0.06	4.3	1	4.669 113
BCE2201i-1S	2200	0.1	0.05	0.06	6.2	1	4.669 116
BCE2202-1S	2200	0.01	0.005	0.006	4.3	1	4.669 117
BCE2202i-1S	2200	0.01	0.005	0.006	6.2	1	4.669 120
BCE3202-1S	3200	0.01	0.005	0.006	4.6	1	4.669 129
BCE3202i-1S	3200	0.01	0.005	0.006	6.2	1	4.669 132
BCE4202-1S	4200	0.01	0.005	0.006	4.6	1	4.669 137
BCE4202i-1S	4200	0.01	0.005	0.006	6.2	1	4.669 140
BCE5201-1S	5200	0.1	0.05	0.06	4.3	1	4.669 145
BCE5201i-1S	5200	0.1	0.05	0.06	6.2	1	4.669 148
BCE6200-1S	6200	1	0.5	0.6	4.3	1	4.669 149
BCE6200i-1S	6200	1	0.5	0.6	6.2	1	4.669 152
BCE6202-1S	6200	0.01	0.005	0.006	4.6	1	4.669 153
BCE6202i-1S	6200	0.01	0.005	0.006	6.2	1	4.669 156
BCE8200-1S	8200	1	0.5	0.6	4.3	1	4.669 173
BCE8200i-1S	8200	1	0.5	0.6	6.2	1	4.669 176
BCE8201-1S	8200	0.1	0.05	0.06	4.3	1	4.669 177
BCE8201i-1S	8200	0.1	0.05	0.06	6.2	1	4.669 180

2 Precision balances Entris® II with square windshield

NEW

High weighing space, easy access to weighing platform through side doors and upper sliding door. Specially coated windscreen against electrostatic charge.

Sartorius Lab Instruments

All models also available as approved versions for EU/France.

Scope of supply: Precision balance, power supply unit, display protection cover**Specifications**

Readability: 1 mg
 Reproducibility: ±1 mg
 Linearity: ±0.6 mg
 Weighing platform: Ø 120 mm
 Weighing space height: 240 mm
 Dimensions (W x D x H): 219 x 317 x 345 mm
 Weight: 6.3 kg
 Power supply: 100 ... 240 V, 50 ... 60 Hz

Type	Capacity	PK	Cat. No.
	g		
BCE223-1S	220	1	4.669 121
BCE223i-1S	220	1	4.669 124
BCE323-1S	320	1	4.669 133
BCE323i-1S	320	1	4.669 136
BCE423-1S	420	1	4.669 141
BCE423i-1S	420	1	4.669 144
BCE623-1S	620	1	4.669 161
BCE623i-1S	620	1	4.669 164



Balances/Precision balances

1 2 3 Precision balances Cubis® II

Modular premium balances for research and development or analytical laboratories. The Cubis® II platform is a completely configurable, high-performance portfolio of both lab weighing hardware and software. The combinability of the display unit, weighing module, draft shield and software packages for various applications and functions allows the individual adaptation to all weighing tasks.

Sartorius Lab Instruments

- Monolithic weighing system
- Seamless connectivity to diverse laboratory information systems without the need of additional software
- Integrated climate sensor
- Status center notifications
- Full data integrity following ALCOA+ principles
- Supports all requirements for FDA directive 21 CFR part 11 and EU Annex 11 compliance
- Complete traceability via advanced audit trail and reporting function

MCE Essential User Interface:

- Large, high-contrast TFT touch display
- Factory-installed basic set of essential weighing applications
- Activated by touch key, touch-free using IR sensor or gesture sensor (optional)

MCA Advanced User Interface:

- Large 7" color touch display
- Factory-installed basic set of essential weighing applications
- Various QApp packages for optional software extension
- Activated by touch key, touch-free using IR sensor or gesture sensor (optional)



4 5 6 Precision balances Cubis® II

NEW

- Automatic motorised leveling
 - Draft shield:
- O: Balance without draft shield
 E: Small glass draft shield
 R: Stainless steel draft shield

Sartorius Lab Instruments

Height and weight depending upon weighing pan size, filter weighing pan and draft shield. Verified balances and other configurations are available online or on request.

Type	With	Capacity	Readability	Plate dimensions	Dimensions (W x D x H)	Weight	PK	Cat. No.
		g	g	mm	mm	kg		
623S, MCA	E	620	0.001	140 x 140	240 x 425 x 122	5.9	1	4.670 883
3203S, MCA	R	3200	0.001	140 x 140	240 x 425 x 122	5.9	1	4.670 873
5203S, MCA	E	5200	0.001	140 x 140	240 x 425 x 122	5.9	1	4.670 855
2202S, MCA	O	2200	0.01	206 x 206	240 x 425 x 95	5.4	1	4.670 866
4202S, MCA	O	4200	0.01	206 x 206	240 x 425 x 95	5.4	1	4.670 877
6202S, MCA	O	6200	0.01	206 x 206	240 x 425 x 95	5.4	1	4.670 856
8201S, MCA	O	8200	0.1	206 x 206	240 x 425 x 95	5.4	1	4.670 886
12201S, MCE*	O	12200	0.1	206 x 206	240 x 425 x 95	5.4	1	4.670 888

* manual Leveling



1 Analytical balance KERN ABS-N/ABJ-NM

The bestseller in analytical balances, now with high-quality single-cell weighing system and EC type approval (Type ending M)

Kern & Sohn

- Only ABJ-NM: Automatic internal adjustment in the case of a change in temperature $> 2\text{ }^{\circ}\text{C}$ or time-controlled every 4 hours
- Only ABS-N: Adjusting program CAL, external test weights at an additional price
- Dosage aid: High-stability mode and other filter settings can be selected
- Simple recipeweighing and documenting with a combined tare/print function. In addition, the mixing ingredients for the recipe are numbered automatically and printed out with their corresponding number and weight value
- Identification number: 4 numeric positions, printed on calibration protocol
- Automatic data output to the PC/printer each time the balance reaches a steady state
- Large LCD display, digit height 14 mm

Single-cell advanced technology:

- Fully automatic manufactured weighing cell from one piece of material
- Stable temperature behaviour
- Short stabilisation time: Steady weight values within approx. 3sec under laboratory conditions
- Shock proof construction
- High corner load performance

Specifications

Overall dimensions (W x D x H):	210 x 340 x 325mm
Dimensions weighing space (W x D x H):	174 x 162 x 227mm
Permissible ambient temperature:	10°C/30°C
Net weight:	approx. 6kg

Type	Plate diam.	Capacity	Readability	Reproducibility	Linearity	PK	Cat. No.
	mm	g	mg	± mg	± mg		
ABS 80-4N	91	82	0.1	0.2	0.3	1	9.901 451
ABS 120-4N	91	120	0.1	0.2	0.3	1	9.901 452
ABS 220-4N	91	220	0.1	0.2	0.3	1	9.901 453
ABS 320-4N	91	320	0.1	0.2	0.3	1	9.901 454
ABJ 80-4NM	91	82	0.1	0.2	0.3	1	9.901 455
ABJ 120-4NM	91	120	0.1	0.2	0.3	1	9.901 456
ABJ 220-4NM	91	220	0.1	0.2	0.3	1	6.257 572
ABJ 320-4NM	91	320	0.1	0.2	0.3	1	9.901 457

1



2 Analytical balances ALS-A/ALJ-A

Analytical balances with large weighing ranges.

Kern & Sohn

- Only ALJ-A: Automatic internal adjustment in the case of a change in temperature $> 1.2\text{ }^{\circ}\text{C}$
- Only ALS-A: Adjusting program CAL for quick setting of the balance accuracy, external test weights at an additional price
- Ergonomically optimised keypad for left and righthanded users
- Large glass draught shield with 3 sliding doors for easy access to the items being weighed
- Compact size, practical for small spaces
- Percentage determination: makes it possible to store a given weight value (100 %) and to determine deviations from this target value
- Backlit LCD display, digit height 17 mm
- Weighing plate made of stainless steel

Specifications

Overall dimensions, incl. draught shield (W x D x H):	210 x 340 x 330 mm
Weighing space (W x D x H):	160 x 140 x 205 mm
Net weight:	approx. 5.7 kg
Permissible ambient temperature (ALS-A/ALJ-A/ALJ-DA):	5 °C/35 °C
Permissible ambient temperature (ALJ-AM):	15 °C/30 °C

Type	Plate diam.	Weighing range	Readability	Reproducibility	Linearity	PK	Cat. No.
	mm	g	mg	± mg	± mg		
ALS 160-4A	80	160	0.1	0.1	0.3	1	7.656 611
ALS 250-4A	80	250	0.1	0.1	0.3	1	6.254 783
ALJ 160-4A	80	160	0.1	0.1	0.3	1	6.261 152
ALJ 160-4AM	80	160	0.1	0.2	0.3	1	6.284 443
ALJ 250-4A	80	250	0.1	0.1	0.3	1	6.257 891
ALJ 250-4AM	80	250	0.1	0.2	0.3	1	6.269 644
ALJ 310-4A	80	310	0.1	0.1	0.3	1	6.284 459
ALJ 500-4A	80	510	0.1	0.2	0.4	1	4.658 462
ALJ 200-5DA	80	82 / 220	0.01 / 0.1	0.04 / 0.2	0.1 / 0.2	1	4.660 773

2



Balances/Analytical balances

1



6.310 582

Analytical balance ADB/ADJ

Compact analytical balance with special carat function. A low cost and space-saving balance that is easy to operate with an optimized 6-key control panel.

Kern & Sohn

- Only ADJ: Automatic internal adjustment in the case of a change in temperature >2 °C or time-controlled every 2 h
- Only ADB: Adjusting program CAL, external test weights at an additional price
- Large backlit LCD display
- Digit height 16 mm
- Glass draught shield with 3 sliding doors
- Stainless steel weighing plate
- Adapted to small space requirements

2



6.310 583

Specifications

Overall dimensions, incl. draught shield (W x D x H)

ADB/ADJ:	230 × 310 × 330 mm
ADB-C/ADJ-C:	205 × 310 × 210 mm
Dimensions weighing space (W x D x H):	
ADB/ADJ:	170 × 160 × 205 mm
ADB-C/ADJ-C:	170 × 160 × 110 mm
Dimensions weighing plate (diam.):	90 mm
Permissible ambient temperature:	10 ... 30 °C

Type	Weighing range		Readability	Reproducibility	Linearity	Plate diam.	Plug type	Weight	PK	Cat. No.
	g	mg								
ADB 100-4	120	0.1	0.2	0.2	0.4	90	EU, UK, CH	4.4	1	6.310 582 1
ADB 200-4	210	0.1	0.2	0.2	0.4	90	EU, UK, CH	4.4	1	6.282 811
ADB 600-C3	120 (600 ct)	0.1 (0.001 ct)	0.2 (0.002 ct)	0.4 (0.004 ct)	0.4 (0.004 ct)	90	EU, UK, CH	3.8	1	6.310 583 2
ADJ 100-4	120	0.1	0.2	0.2	0.4	90	EU, UK, CH	5.0	1	6.275 587
ADJ 200-4	210	0.1	0.2	0.2	0.4	90	EU, UK, CH	5.0	1	6.275 588
ADJ 600-C3	120 (600 ct)	0.1 (0.001 ct)	0.2 (0.002 ct)	0.4 (0.004 ct)	0.4 (0.004 ct)	90	EU, UK, CH	4.5	1	6.275 589

3



3 Balances, electronic, analytical, ABT series

Analytical and semi-microbalances which are suitable for verification.

Kern & Sohn

All models have automatic calibration adjustment function by internal, motor-driven, calibration weight. It is possible to log ISO/GLP-compliant weighing or calibration data at any time via an accessory printer (not supplied) or data interface (bi-directional RS232-C).

Additionally, the balances have formulation, piece counting and percentage determination functions, as well as a flush-mounted weighing platform. All models are supplied with a modern, all-glass draught shield with sliding doors to the left, right and top.

Also available with DKD certified, ionizer, thermal printer, statistic printer at additional cost.

Single-cell advanced technology:

- Fully automatic manufactured weighing cell from one piece of material
- Stable temperature behavior
- Short stabilisation time: Steady weight values within approx. 4 sec under laboratory conditions
- Shock proof construction
- High corner load performance

Weighing pan, stainless steel:	80mm dia.
Weighing chamber (W x D x H):	168 x 172 x 223mm
Dimensions (W x D x H):	217 x 356 x 338mm
Mains adapter:	220V

Type	Plate Weighing diam. range		Readability	Reproducibility	Linearity	PK	Cat. No.
	mm	g					
ABT 120-4NM	80	120	0.1	0.1	0.2	1	9.900 955
ABT 220-4NM	80	220	0.1	0.1	0.2	1	9.900 956
ABT 320-4NM	80	320	0.1	0.1	0.3	1	9.900 957
ABT 100-5NM	80	101	0.01	0.05	0.15	1	6.241 274
ABT 120-5DNM	80	42 / 120	0.01 / 0.1	0.02 / 0.1	0.05 / 0.2	1	9.900 958
ABT 220-5DNM	80	82 / 220	0.01 / 0.1	0.05 / 0.1	0.1 / 0.2	1	9.900 959

1 Analytical balance ABP

This new generation of analytical balances combines the highest level of precision with large weighing capacities. Thanks to the new Single-Cell Generation, the weighing result is displayed in a fraction of the time with comparable models.

Kern & Sohn

Together with the intuitively structured menu, this means that you can work efficiently and rapidly.

- Navigation pad for super quick navigating through the menus
- Automatic internal adjustment in the case of a change in temperature ≥ 1 °C or timecontrolled every 4 h, guarantees high degree of accuracy and makes the balance independent of its location of use
- The minimum weight of sample can be manually stored in the balance or automatically calculated, with warning message when the weighing is below this value
- Dosage aid: High-stability mode and other filter settings can be selected
- Simple recipe weighing and documenting with a combined tare/print function
- Menu language DE, GB
- Automatic data output to the PC/printer each time the balance is steady
- Large glass draught shield with 3 sliding doors for easy access to the items being weighed
- DM-models: Incl. Multi-function weighing plate for minimising the effect of currents of air in the weighing space and for easy fixing and weighing of protruding samples as sample paper, PCR containers or micro centrifuge tubes

1



Specifications

Overall dimensions, incl. draught shield (W x D x H): 213 x 407 x 344 mm
 Weighing space (W x D x H): 166 x 156 x 220 mm
 Net weight: 8 kg
 Power supply: 220 ... 240 V AC, 50 Hz

Type	Weighing range	Readability	Reproducibility	Linearity	Plate diam.	PK	Cat. No.
	g	mg	± mg	± mg	mm		
ABP 100-4M	120	0.1	0.1	0.2	91	1	4.667 748
ABP 200-4M	220	0.1	0.1	0.2	91	1	4.667 749
ABP 300-4M	320	0.1	0.1	0.3	91	1	4.667 750
ABP 100-5DM	52 / 120	0.01 / 0.1	0.02 / 0.1	0.03 / 0.3	91	1	4.667 751
ABP 200-5DM	102 / 220	0.01 / 0.1	0.02 / 0.1	0.03 / 0.3	91	1	4.667 752

Analytical balances Entris® II

The evolution of the Entris® balance series. The large portfolio offers the right model for every weighing task. With many convenience functions for efficiency and accuracy in the laboratory. Quality "Made in Germany".

Sartorius Lab Instruments

- Modern sensors ensure very fast stabilisation time
- Automatic, internal calibration and adjustment function (isoCAL) for all "i" models
- Weighing platform made of stainless steel
- Excellent readability and operability with hybrid touch display
- Automatic detection of connected Sartorius accessories
- Direct data transfer to connected PCs with USB-C and RS232 interface without need of additional software
- 12 integrated applications with GLP/GMP-compliant protocol
- Easy to clean, high chemical resistance
- Multilingual interface

2 Analytical balances Entris® II



High weighing space, easy access to weighing platform through side doors and upper sliding door. Specially coated windscreen against electrostatic charge. All models also available as approved versions for EU/France.

Sartorius Lab Instruments

Scope of supply: Analytical balance, power supply unit, display protection cover

Specifications

Readability: 0.1 mg
 Reproducibility: ± 0.1 mg
 Linearity: ± 0.06 mg
 Weighing platform: $\varnothing 90$ mm
 Weighing space height: 240 mm
 Dimensions (W x D x H): 219 x 317 x 345 mm
 Weight: 6.2 kg
 Power supply: 100 ... 240 V, 50 ... 60 Hz

2



Type	Weighing range	PK	Cat. No.
	g		
BCE64-1S	0.0001 ... 60	1	4.669 165
BCE64i-1S	0.0001 ... 60	1	4.669 168
BCE124-1S	0.0001 ... 120	1	4.669 109
BCE124i-1S	0.0001 ... 120	1	4.669 112
BCE224-1S	0.0001 ... 220	1	4.669 125
BCE224i-1S	0.0001 ... 220	1	4.669 128

Balances/Analytical balances

1



1 Analytical balances Adventurer® AX

- Fast stabilization and reliable operation to ensure solid weighing performance and accurate, repeatable results. OHAUS
- Two USB ports with GLP/GMP tracking capabilities assist the monitoring and reporting of the data.
- The wide viewing angle colour touchscreen provides access to all applications.
- Reduced footprint due to two pieces, top-mounted draft shield doors
- AutoCal™ automatic internal calibration system or traditional external calibration (external calibration models -/E)
- EC Type Approved models available
- Applications: Weighing (17 units + custom unit), parts counting, percentage weighing, check weighing, dynamic weighing, totalization/statistics, formulation, density determination, display hold.
- Display: 4.3" (109 mm) Full-colour VGA graphic touchscreen with user-controlled brightness,
- Operation: Mains operation.
- Communication: RS232, USB Host, USB Device (included). GLP/GMP compliant data output
- Construction: Die-cast metal base, ABS top housing, stainless steel pan, glass draft shield with two piece top mounted side doors and sliding top door, replaceable in-use cover
- Design features: Two-piece, top mounted, space-saving draftshield with removable panels on 0.1mg and 0.001g models. AutoCal™ automatic internal calibration or external calibration. Level assist feature with illuminated level indicator. Selectable environmental and auto-print settings. Integral weigh below hook. Protective full housing in-use cover. Software lock switch.

Specifications

Readability: 0.1 mg
 Ø weighing plate: 90 mm
 Power supply: 100...240 V/50/60 Hz

Type	Weighing range g	PK	Cat. No.
AX124	120	1	6.268 193
AX124/E	120	1	6.268 195
AX224	220	1	6.268 196
AX224/E	220	1	6.268 198
AX324	320	1	6.268 199

2



2 Analytical balances Quintix®

Intuitive application guidance, start of applications with only one keystroke. Sartorius Lab Instruments
 Maximum accuracy at all times. Made in Germany.

- The balance automatically adjusts itself when the pre-set temperature and time is exceeded
- Coloured Touchscreen Display
- Easy cleaning
- "Plug & Work" connectivity to printer or computer via USB port for simple GLP-compliant logging, direct data transfer to Microsoft® Windows programs without further software
- Password protection and supervisor lock for protection against unintentional changes
- Integrated underfloor weighing
- Easy cleaning: For cleaning of the windshield, the side windows, the sliding cover and all stainless steel parts are easily removable.
- Extra large adjustable feet for easy levelling

Specifications

Overall dimensions (W x D x H): 216 x 360 x 320mm
 Height weighing space: 209mm
 Permissible ambient temperature: +10 to +30°C
 Mains adapter: 100 - 240V, 50/60Hz

Type	Plate diam. mm	Weighing range g	Readability mg	Reproducibility ± mg	Linearity ± mg	PK	Cat. No.
QUINTIX64-1S	90	60	0,1	0,1	0,2	1	6.262 848
QUINTIX124-1S	90	120	0,1	0,1	0,2	1	6.262 421
QUINTIX224-1S	90	220	0,1	0,1	0,2	1	6.262 424

1 Printer for balances and moisture analysers

Data Printer, with GLP- and GMP-function for all Sartorius balances and moisture analysers. With alphanumeric dot-matrix printing unit (safety printing unit with 5x8 matrix) as well as the ASCII character set and application-specific special characters, for the documentation of weighing data. Membrane keyboard for easy and safe operation.

Sartorius Lab Instruments



Description	PK	Cat. No.
Printer	1	6.289 719
Printer paper, rolls of 50 m	5	7.100 679
Printer paper, rolls of 14 m	5	9.902 636

Analytical balances Explorer® EX

Highest performance, most technically advanced balance from OHAUS

OHAUS

- High resolution multi-lingual colour VGA touch display with icons for simple operation
- Programmable multi-functional touch-free sensors for cleanliness, speed and safety
- Multiple application modes plus library for storage of personal application settings
- External calibration, High capacity and EC type approved models also available
- Application: Weighing (17 units + custom units), Parts Counting, % weighing, Animal/Dynamic Weighing, Checkweighing, Filling, Totalization, Formulation, Differential weighing, Density determination, Peak hold, Ingredient costing, Pipette adjustment, Gross/Net/Tare Weighing
- Display: High resolution full-color VGA graphic display (5.7" diagonal), 4-wire resistive touch screen. QWERTY keyboard and numeric keypad to quickly input GLP and GMP data and other application data.
- Operation: Mains Operation
- Communication: Easy access communication ports including USB host, USB device, RS232 and an optional 4th port for either RS232 or Ethernet. GLP/GMP Data Output with Real Time Clock. Direct Data Transfer Function.
- Construction: Metal base, ABS top housing, stainless steel pan, anti-static glass draftshield with flip-top door, replaceable in-use cover, automatic draftshield doors on selected models
- Design features: 3-door frameless draftshield with removable panels on 0.1mg and 1mg models. Optional automatic draftshield doors on 0.1mg and 0.01mg models, with built in ionizer on 0.01mg automatic draftshield door models. Modular display design with adjustable angle (attach to base, wall or optional tower). AutoCal™ fully-automatic internal calibration system. Level assist feature with illuminated level indicator. Selectable environmental and auto-print settings. Integral weigh below hook. Protective in-use cover. Software lock switch.



9.902 371



6.268 205

Type	Plate dimensions	Weighing range	Readability	PK	Cat. No.
	mm	g			
EX124	Ø 90	120	0.1 mg	1	9.902 370
EX124/AD*	Ø 90	120	0.1 mg	1	6.268 206
EX125	Ø 80	120	0.01 mg	1	6.268 202
EX125D	Ø 80	52 / 120**	0.01 / 0.1 mg	1	6.268 201
EX223	Ø 130	220	1 mg	1	9.902 375
EX224	Ø 90	220	0.1 mg	1	9.902 371 2
EX224/AD*	Ø 90	220	0.1 mg	1	6.266 074
EX225D	Ø 80	120 / 220**	0.01 / 0.1 mg	1	6.268 203
EX225D/AD*	Ø 80	120 / 220**	0.01 / 0.1 mg	1	6.268 204
EX225/AD*	Ø 80	220	0.1 mg	1	6.268 205 3
EX324	Ø 90	320	0.1 mg	1	9.902 373
EX324/AD*	Ø 90	320	0.1 mg	1	6.268 207

*Automatic door

**Dual range

Accessories for analytical balance Explorer®

OHAUS

Type	PK	Cat. No.
Ethernet interface	1	9.902 361
Terminal extension cable	1	9.902 362
Density determination kit	1	9.902 363
Tower kit	1	9.902 364
Draft Shield Kit	1	9.902 366
USB Interface Cable (Type A to B)	1	9.902 368
Theft protection clamp	1	9.947 316

1

1 Analytical Balances PR

The analytical balance PR combines the basic weighing functions, weighing, piece counting and percent weighing with competitive performance, providing high accuracy and repeatability for laboratory, industrial and educational applications.

OHAUS

- Backlit LCD display
- Draftshield
- 4 quick keys for easy operation of multiple weighing modes
- RS 232 interface
- User-selectable span calibration points
- Detachable stainless steel weighing platform
- Integrated weigh-below-hook
- Auto-tare
- Overload, underload and stability indicator

Please note:

Models with extra code /E with external calibration. All other models are equipped with an internal calibration. Models with extra code M are approved instruments according to EN 45501; OIML R76.

Specifications

Permissible ambient temperature range:	10 ... 30 °C
Height in draftshield:	205 mm
Dimensions (W x D x H):	201 x 317 x 303 mm
Weight:	4.5 kg
Power supply:	100 ... 240 V/50 ... 60 Hz

Type	Weighing range	Readability	Reproducibility	Linearity	Plate diam.	PK	Cat. No.
	g	mg	± mg	± mg	mm		
PR124	120	0.1	0.1	0.2	90	1	4.668 265
PR124/E*	120	0.1	0.1	0.2	90	1	4.668 264
PR124M **	120	0.1	0.1	0.2	90	1	4.668 266
PR224	220	0.1	0.1	0.2	90	1	4.668 268
PR224/E*	220	0.1	0.1	0.2	90	1	4.668 267
PR224M **	220	0.1	0.1	0.2	90	1	4.668 269
PR223	220	1.0	1.0	2.0	120	1	4.668 271
PR223/E*	220	1.0	1.0	2.0	120	1	4.668 270
PR223M **	220	1.0	1.0	2.0	120	1	4.668 272
PR423	420	1.0	1.0	2.0	120	1	4.668 274
PR423/E*	420	1.0	1.0	2.0	120	1	4.668 273
PR423M **	420	1.0	1.0	2.0	120	1	4.668 275
PR523	520	1.0	1.0	2.0	120	1	4.668 277
PR523/E*	520	1.0	1.0	2.0	120	1	4.668 276
PR523M **	520	1.0	1.0	2.0	120	1	4.668 278

*external calibration

**approved acc. to EN 45501; OIML R76



1 Analytical balances Pioneer® PX

OHAUS

1

High-performance, economical balances with high accuracy and repeatability for applications in laboratories, industry and education. For basic weighing, parts-counting, percent weighing, dynamic weighing and density determination.

- 2 line, backlit LCD display
- 4 quick keys enable the most common weighing modes
- Draftshield
- USB and RS 232 interface for data exchange with PCs and PLCs
- User-selectable span calibration points
- Real-time clock with GLP/GMP data
- Cast metal lower housing, removable stainless steel weighing pan
- Integrated weigh-below-hook
- Auto-tare
- Many weighing units selectable, a custom unit can be defined
- Models with removable side draftshield doors and static removal bar made from ABS
- Overload, underload and stability indicator
- 4 menu languages



Please note:

Models with extra code /E with external calibration. All other models are equipped with an internal calibration. Models with extra code M are approved instruments according to EN 45501; OIML R76. Models with extra code D are with dual range function.

Specifications

Permissible ambient temperature range:	10 ... 30 °C
Height in draftshield:	235 mm
Dimensions (W x D x H):	209 x 321 x 309 mm
Weight:	4.5 kg
Power supply:	100 ... 240 V/50 ... 60 Hz

Type	Plate diam.	Weighing range	Readability	Reproducibility	Linearity	PK	Cat. No.
			mg	± mg	± mg		
PX125D ***	80	52 / 120	0.01 / 0.1	0.02 / 0.1	0.1	1	4.663 320
PX125DM **/***	80	52 / 120	0.01 / 0.1	0.02 / 0.1	0.1	1	4.663 321
PX85	80	82	0.01	0.02	0.1	1	4.663 322
PX85M **	80	82	0.01	0.02	0.1	1	4.663 323
PX225D ***	80	82 / 220	0.01 / 0.1	0.02 / 0.1	0.1	1	4.663 324
PX225DM **/***	80	82 / 220	0.01 / 0.1	0.02 / 0.1	0.1	1	4.663 325
PX124	90	120	0.1	0.1	0.2	1	4.663 327
PX124/E *	90	120	0.1	0.1	0.2	1	4.663 326
PX124M **	90	120	0.1	0.1	0.2	1	4.663 328
PX224	90	220	0.1	0.1	0.2	1	4.663 330
PX224/E *	90	220	0.1	0.1	0.2	1	4.663 329
PX224M **	90	220	0.1	0.1	0.2	1	4.663 331
PX323	120	320	1.0	1.0	2.0	1	4.663 333
PX323/E *	120	320	1.0	1.0	2.0	1	4.663 332
PX323M **	120	320	1.0	1.0	2.0	1	4.663 334
PX523	120	520	1.0	1.0	2.0	1	4.663 336
PX523/E *	120	520	1.0	1.0	2.0	1	4.663 335
PX523M **	120	520	1.0	1.0	2.0	1	4.663 337

*external calibration
 **approved acc. to EN 45501; OIML R76
 ***Dual range

We can supply this
 manufacturer's
 whole
 product range !



Balances/Analytical balances

1



4.671 854

Micro Balances BM

NEW

A&D Inst.

Analytical Balances with easy removal of static electricity via a built-in fan-free ionizer and anti-static windshield. Wide range of accessories for a variety of applications, e.g. holder for microcentrifuge tubes or aluminium vessels.

- Clearly readable, white-lit LCD display
- Large weighing chamber, suitable for flasks
- Integrated sensors for temperature, humidity and air pressure
- Internal calibration automatic, based on temperature change, manual, triggered by the operator
- Weighing units: g, mg, oz, ozt, ct, mom, dwt, GN, Tael, Tola, piece (counting),%
- Memory up to 200 data sets
- RS-232C interface and Quick USB Standard.

Specifications

Permissible ambient temperature range:	5 ... 40 °C
Height in draftshield:	252 mm
Dimensions (W x D x H):	259 x 466 x 326 mm
Weight:	approx. 10 kg
Power supply:	12 V, 1 A

Type	Weighing range	Readability	Reproducibility	Linearity	Plate diam.	PK	Cat. No.
	g	mg	± mg	± mg	mm		
BM-20	22	0.001	0.0025	0.010	25	1	4.671 854 1
BM-22	5.1 / 22	0.001 / 0.01	0.004 / 0.01	0.010 / 0.02	25	1	4.671 855
BM-252	250	0.01	0.03	0.10	90	1	4.671 856

2



2 3 4 Analytical balances Cubis® II

Modular premium balances for research and development or analytical laboratories.

Sartorius Lab Instruments

The Cubis® II platform is a completely configurable, high-performance portfolio of both lab weighing hardware and software. The combinability of the display unit, weighing module, draft shield and software packages for various applications and functions allows the individual adaptation to all weighing tasks.

- Monolithic weighing system
- Seamless connectivity to diverse laboratory information systems without the need of additional software
- Integrated climate sensor
- Status center notifications
- Full data integrity following ALCOA+ principles
- Supports all requirements for FDA directive 21 CFR part 11 and EU Annex 11 compliance
- Complete traceability via advanced audit trail and reporting function

3



MCE

MCE Essential User Interface:

- Large, high-contrast TFT touch display
- Factory-installed basic set of essential weighing applications
- Activated by touch key, touch-free using IR sensor or gesture sensor (optional)

4



MCA

MCA Advanced User Interface:

- Large 7" color touch display
- Factory-installed basic set of essential weighing applications
- Various QApp packages for optional software extension
- Activated by touch key, touch-free using IR sensor or gesture sensor (optional)

5



5 Semi-micro- and analytical balances Cubis® II

NEW

Sartorius Lab Instruments

- Automatic motorised leveling
- Automatic glass draft shield with integrated ionizer

Height and weight depending upon weighing pan size, filter weighing pan and draft shield. Verified balances and other configurations are available online or on request.

Type	Capacity	Readability	Plate dimensions	Dimensions (W x D x H)	Weight	PK	Cat. No.
	g	mg	mm	mm	kg		
225S, MCA	220	0.01	85 x 85	240 x 404 x 373	10.2	1	4.670 853
224S, MCA	220	0.1	85 x 85	240 x 425 x 373	8.2	1	4.670 852
524S, MCA	520	0.1	85 x 85	240 x 425 x 373	8.2	1	4.670 879
324S, MCE *	320	0.1	85 x 85	240 x 425 x 373	8.2	1	4.670 899

* manual glass draft shield

1 Ultra-micro- and micro balances Cubis® II



1

- Titanium inner parts
- Automatic motorised levelling
- Automatic, motorized, round, glass draft shield with learning capability, illumination and integrated motion sensor

Sartorius Lab Instruments

Height and weight depending upon weighing pan size, filter weighing pan and draft shield. Verified balances and other configurations are available online or on request.



Specifications

Dimensions (W x D x H): 139 x 340 x 129 mm
 Weight: 6.4 kg

Type	Weighing range	Readability	Plate dimensions	PK	Cat. No.
2.7S, MCA	2.1	0.0001	Ø 20	1	4.670 864
2.7S, MCA *	2.1	0.0001	Ø 50	1	4.670 863
6.6S, MCA	6.1	0.001	Ø 30	1	4.670 882
10.6S, MCA	10.1	0.001	Ø 30	1	4.670 851

* with filter draft shield

2 Platform balance DE-D

Kern & Sohn

2

Compact, lightweight construction suitable for production, warehouse, dispatch department etc.. The display device positioned free-standing or can be mounted to the wall. With the recipe function you can weigh the different ingredients of a mixture. PRE-TARE function for manual subtraction of a known container weight. Protective working cover included with delivery.

- Large backlit LCD display, digit height 25 mm
- Optional battery operation, 9 V block, operating time up to 12 h
- Weighing plate stainless steel, painted steel base



Specification

Permissible ambient temperature: 5 ... 35 °C

Display device

Material: plastic
 Dimensions (W x D x H): 225 x 110 x 45 mm
 IP code: IP65

Type	max. load	Readability	Linearity	Min. piece weight (PW min)	Weight	Plate dimensions	PK	Cat. No.
DE 6K1D	3 / 6	1 / 2	3 / 6	40	4,8	318 x 308 x 75	1	6.251 045
DE 15K2D	6 / 15	2 / 5	6 / 15	100	4,8	318 x 308 x 75	1	6.262 467
DE 35K5D	15 / 35	5 / 10	15 / 30	100	4,8	318 x 308 x 75	1	7.628 620
DE 60K10D	30 / 60	10 / 20	30 / 60	200	4,8	318 x 308 x 75	1	6.255 790
DE 60K10DL	30 / 60	10 / 20	30 / 60	200	16	522 x 406 x 98	1	6.253 642
DE 150K20D	60 / 150	20 / 50	60 / 150	400	5,0	318 x 308 x 75	1	7.655 178
DE 150K20DL	60 / 150	20 / 50	60 / 150	400	16	522 x 406 x 98	1	7.639 620
DE 150K20DXL	60 / 150	20 / 50	60 / 150	400	28	650 x 500 x 89	1	7.654 881
DE 300K50DL	150 / 300	50 / 100	150 / 300	2000	28	650 x 500 x 89	1	6.280 971
DE 6K0.5A	6	0.5	1.5	10	4,8	318 x 308 x 75	1	6.253 821
DE 12K1A	12	1	3	20	4,8	318 x 308 x 75	1	7.655 229
DE 24K2A	24	2	6	40	4,8	318 x 308 x 75	1	6.240 150
DE 60K5A	60	5	15	100	4,8	318 x 308 x 75	1	6.242 923
DE 120K10A	120	10	30	200	5,0	318 x 308 x 75	1	6.242 589
DE 15K0.2D	6 / 15	0.2 / 0.5	0.8 / 2	4	4,0	318 x 308 x 88	1	6.239 797
DE 35K0.5D	15 / 35	0.5 / 1	2 / 4	10	7	318 x 308 x 88	1	7.656 917
DE 60K1D	30 / 60	1 / 2	4 / 8	20	7	318 x 308 x 88	1	6.254 014
DE 150K2DL	60 / 150	2 / 5	8 / 20	40	15	522 x 403 x 83	1	6.254 284



1

1 Halogen Moisture Analyser DBS 60-3

Modern moisture analyser with 10 memories and graphic display

Kern & Sohn

- Halogen quartz glass heater 400 W
- Backlit LCD display, digit height 15 mm: Previous drying time, current temperature, unit for displaying the results, current moisture content in %, drying mode/Status display drying
- Observation window over the sample, useful during initial adjustment
- Internal memory for automatic sequence of 10 drying programs and 100 drying processes carried out
- The last value measured remains on the display until it is replaced by a new measurement
- Sample description for up to 99 samples, 2 digits, freely programmable, and is printed in the measuring protocol
- Date and time display as standard
- 10 sample plates included
- Table of applications: There are many practical examples in the operating instructions

Specifications

Readability:	0.01 % or 0.001 g
Weighing range, max:	60 g
Reproducibility, weight of sample 2 g:	0.15 %
Reproducibility, weight of sample 10 g:	0.02 %
Temperature range:	+50 to +200 °C
Dimensions (W x D x H):	240 x 336 x 167 mm

Type	PK	Cat. No.
DBS 60-3	1	9.901 441

Suitable accessories can be found in our online shop.

Moisture analyser DAB 200-2/DAB 100-3

Moisture analyser with user-friendly graphics display and 15 memories for drying programs.

Kern & Sohn

- Halogen quartz glass heater 400 W
- Backlit LCD display, digit height 14 mm
- Display of: Drying process active, Active heating profile, Active switch-off criteria, Previous drying time, Current temperature, Moisture display in %, Interim result in moisture-%
- Observation window above the sample, useful during initial setting
- Internal memory for automatic sequence of 15 complete drying processes and 5 drying processes carried out
- The last value measured remains on the display until it is replaced by a new measurement
- 50 sample plates included

Specifications

Recommended humidity range:	5 ... 80 %
Temperature range:	40 ... 199 °C in steps of 1°C
Dimensions (W x D x H):	240 x 365 x 180 mm
Weight:	4.82 kg
Power supply:	230 V AC, 50 Hz

2

2 Moisture analyser DAB 200-2

Model with lower resolution, whereby the switch-off criterion is reached faster, which saves time. Ideal for quick tests and spot checks.

Kern & Sohn

Specifications

Readability:	0.05 % or 0.01 g
Weighing range, max:	200 g
Reproducibility, weight of sample 2 g/10 g:	1.5 %/0.3 %

Type	PK	Cat. No.
DAB 200-2	1	6.292 002

3

3 Moisture analyser DAB 100-3

Kern & Sohn

Specifications

Readability:	0.01 % or 0.001 g
Weighing range, max:	110 g
Reproducibility, weight of sample 2 g/10 g:	0.15 %/0.02 %

Type	PK	Cat. No.
DAB 100-3	1	6.281 836

3. Analytical measurement and testing Balances/Moisture balances

1 Moisture balances MB23 and MB25

The Moisture Analyzers MB-23 and MB-25 provide stable results with 0.1% or 0.05 % moisture resolution because of precision weighing technology. They are supplied with either an infra-red, or halogen, heating system. Applicable for most applications. Graphical interface control. No programming necessary.

OHAUS

1



- Halogen (MB-25) or infra-red (MB23) technology
- Sample holder included in MB25 but as option in MB23
- Delivered with 50 x 90 mm aluminium sample dishes and protective cover

Specifications	MB23 // MB25
Capacity:	110 g
Repeatability 3 g/10 g:	0.3 %/0.2 % // 0.2 %/0.05 %
Readability:	0.1 % or 0.01 g // 0.05 % or 0.005 g
Timer:	1 ... 99 min, 30-second increments to 60 min
Temperature range:	50 ... 160 °C
Operating temperature:	5 ... 40 °C
Pan size (diam.):	90 mm
Dimensions (W x D x H):	170 x 130 x 280 mm
Net weight:	2.3 kg
Power supply:	100 - 240 V, 50/60 Hz

Type	PK	Cat. No.
MB23	1	9.947 604
MB25	1	9.947 605

2 Halogen Moisture balance MB27

Ideal for routine moisture determinations, that require precise results up to 0.01 % and high capacity up to 90 g. Optimal for applications e.g. in the food, agriculture, chemical and pharmaceutical sector. Easy setting of the parameters. Compact instrument with easy-to-clean heating chamber.

OHAUS

2



- Backlit LCD display
- Tare Range to capacity by subtraction
- Displays % moisture or % solids or weight (g), temperature, time
- Bidirectional interface(RS-232)

Specifications	
Capacity:	90 g
Repeatability 3 g/10 g:	0.2 %/0.05 %
Readability:	0.01% or 0.001 g
Timer:	1 to 99 min, 30-second increments to 60 min
Temperature range:	50 ... 160 °C (in 5 °C increments)
Operating temperature:	5 ... 40 °C
Pan size (diam.):	90 mm
Dimensions (W x D x H):	170 x 280 x 140 mm
Weight:	2.3 kg
Power supply:	100 - 240 V, 50/60 Hz

Type	PK	Cat. No.
MB27	1	4.663 998

3 Accessories Moisture balances MB series

OHAUS

3



Description	For	PK	Cat. No.
Dot matrix printer	MB23/25/27/90/120	1	6.260 786
Protective cover	MB90/120	1	6.282 767
Disposable sample dishes, 90 mm	MB23/25/27/90/120	80	9.947 310
Glass fibre filter	MB23/25/27/90/120	200	9.947 312
Reusable Pan, 7 mm	MB23/25/27/90/120	3	6.282 770
Reusable Pan, 14 mm	MB23/25/27/90/120	3	6.282 771
Pan Holder	MB90/120	1	6.282 766
Cage	MB23/25/27/90/120	1	6.282 769
Scoop	MB90/120	1	6.282 768

Balances/Moisture balances

1



6.282 764

2



6.282 765

Halogen moisture balances MB90 and MB120

Moisture Analysis Made Simple and Powerful.

OHAUS

- The precisely controlled halogen heating dries samples quickly and ensures uniform heating to yield fast, precise and repeatable results of 0.01 % readability
- Designed with effortless maintenance in mind; removable pan handler and heating chamber components that make cleaning quick and easy, no tools needed
- Icon-based menu navigation on the easy-to-read touchscreen display makes operating intuitive
- MB120's Temperature Guide analyzes a sample and determines the optimal drying temperature
- Applications: Percent Moisture Determination, Percent Moisture Regain Determination, Percent Solid Determination, Weighing
- Display 4.3": TFT color touchscreen display
- Operation: Power cord (included)
- Communication: RS232 with GLP/GMP data output, USB Host and USB Device (included)
- Construction: Metal base, ABS top housing, halogen heat source, stainless steel pan support, stainless steel pan handler, in-use cover

Design Features MB90: Three shut-off criteria (manual, timed or auto), two drying profiles (standard and fast), storage up to two methods, user guide, 40 to 200 °C heating temperature range (1 °C increments), 13 operational languages

Design Features MB120: Seven shut-off criteria (manual, timed, autofree %/s, autofree mg/s, A30, A60 and A90), four drying profiles (standard, fast, ramp and step), storage up to 100 methods and 1000 test results for all methods, user guide, 40 to 230 °C heating temperature range (1 °C increments), 13 operational languages

Specifications

	MB90 // MB120
Capacity:	90 g // 120 g
Repeatability 3 g/10 g:	0.18 %/ 0.02 % // 0.05 %/0.015 %
Readability:	0.01 % or 0.001 g
Temperature range:	40 ... 200 °C // 40 ... 230 °C
Operating temperature:	10 ... 40 °C
Pan size (diam.):	90 mm
Dimensions (W x D x H):	210 x 350 x 180 mm
Weight:	5.23 kg
Power supply:	120 or 240 VAC, 50 ... 60 Hz

Type	PK	Cat. No.
MB90	1	6.282 764 1
MB120	1	6.282 765 2

3



3 Moisture Analyser MA35

Sartorius Lab Instruments

- Fully automatic heating of a sample by two powerful metal tubular-shaped heating elements (also called dark radiators)
- Particularly simple operator guidance using self-explanatory pictograms
- Sample quantity 5-15g
- % moisture content, % dry weight, ATRO value, g residue, mg weight loss
- Shutoff criteria (optional): fully automatic, timer setting (0.1-99min.), manual
- Access to sample chamber through hinged cover with large opening angle
- 1 program saved in a non-volatile memory (freely selectable parameters)
- Printout using an optional, external printer (Cat. No. 6.238 838)
- Fixed standard configuration GLP report for measuring results, calibration, adjustment (5 languages selectable)
- External calibration using optional weight sets
- Data interface RS232 C-S/V24-V28, 7 data bits (ASCII) 1 parity bit

Specifications

Readability:	0.01 % or 0.001 g
Weighing range, max:	35 g
Reproducibility, weight of sample 1g:	±0.2 %
Reproducibility, weight of sample 5g:	±0.05 %
Temperature range:	40 ... 160 °C, in increments of 1 °C
Power consumption:	400 VA
Dimensions (W x D x H):	224 x 366 x 191mm

Type	max. load	Min. temp.	Max. temp.	PK	Cat. No.
	g	°C	°C		
MA35M-230N	35	40	160	1	6.272 569

1 Moisture Analyser MA160

The MA160 moisture analyzer is designed for quick and reliable determination of the moisture content of liquids, pastes and solids using the thermogravimetric method. Suitable for the use in QA laboratories and for process control. For testing of foods, beverages, pharmaceuticals, chemicals, sugar, paper materials and products for environmental protection.

Sartorius Lab Instruments

1



- High-performance AURI heating unit for homogeneous drying
- Heating elements are fast, extremely rugged and durable
- Exceptionally high-speed measurements (up to 30 % faster)
- Fast and precise method development
- Memory capacity for storage of methods and results
- Method import and export via SD card
- Reliable performance testing
- Effortless cleaning
- User-friendly operation
- Downward compatibility with MA150 and MA35

Specifications

Readability:	0.01 % or 0.001 g
Weighing range, max:	200 g
Reproducibility, 1 g/5 g:	±0.2 %/±0.05 %
Temperature range:	40 ... 200 °C (in 1 °C increments)
Recommended humidity range:	1 ... 99 %
Power consumption:	600 W
Dimensions (W x D x H):	215 x 400 x 210 mm
Weight:	6.2 kg
Power supply:	230 V

Type	PK	Cat. No.
MA160	1	4.653 450

Accessories for Moisture Analyser MA series

Sartorius Lab Instruments

Description	For	PK	Cat. No.
Disposable sample dishes, aluminium, round	MA35 / 37 / 100 / 160	80	9.902 612
Glass fibre filter, hard quality	MA35 / 37 / 100 / 160	80	9.601 426
Glass fibre filter, soft quality	MA35 / 37 / 100 / 160	200	6.232 716
Data printer (external)	MA35 / 37 / 100 / 160	1	6.238 838
Premium GLP printer	MA35 / 37 / 100 / 160	1	6.284 497
Data printer (built-in)	MA50 / 100	1	9.902 611
Data cable for printer	MA35 / 37 / 100 / 160	1	6.261 483
Temperature adjustment set	MA35 / 37 / 100 / 160	1	6.282 022
ReproEasy Pads	MA37 / 160	10	6.289 754

OIML classes

Classes of Accuracy Nominal value	(Tolerance ±)						
	E1	E2	F1	F2	M1	M 2	M 3
1mg	± 0.003 mg	± 0.006 mg	± 0.020 mg	± 0.006 mg	± 0.20 mg		
2mg	± 0.003 mg	± 0.006 mg	± 0.020 mg	± 0.006 mg	± 0.20 mg		
5mg	± 0.003 mg	± 0.006 mg	± 0.020 mg	± 0.006 mg	± 0.20 mg		
10mg	± 0.003 mg	± 0.008 mg	± 0.025 mg	± 0.008 mg	± 0.25 mg		
20mg	± 0.003 mg	± 0.010 mg	± 0.03 mg	± 0.10 mg	± 0.3 mg		
50mg	± 0.004 mg	± 0.012 mg	± 0.04 mg	± 0.12 mg	± 0.4 mg		
100mg	± 0.005 mg	± 0.016 mg	± 0.05 mg	± 0.16 mg	± 0.5 mg	± 1.6 mg	
200mg	± 0.006 mg	± 0.020 mg	± 0.06 mg	± 0.20 mg	± 0.6 mg	± 2.0 mg	
500mg	± 0.008 mg	± 0.025 mg	± 0.08 mg	± 0.25 mg	± 0.8 mg	± 2.5 mg	
1g	± 0.010 mg	± 0.03 mg	± 0.10 mg	± 0.3 mg	± 1.0 mg	± 3.0 mg	± 10 mg
2g	± 0.012 mg	± 0.04 mg	± 0.12 mg	± 0.4 mg	± 1.2 mg	± 4.0 mg	± 12 mg
5g	± 0.016 mg	± 0.05 mg	± 0.16 mg	± 0.5 mg	± 1.6 mg	± 5.0 mg	± 16 mg
10g	± 0.020 mg	± 0.06 mg	± 0.20 mg	± 0.6 mg	± 2.0 mg	± 6.0 mg	± 20 mg
20g	± 0.025 mg	± 0.08 mg	± 0.25 mg	± 0.8 mg	± 2.5 mg	± 8.0 mg	± 25 mg
50g	± 0.03 mg	± 0.10 mg	± 0.3 mg	± 1.0 mg	± 3.0 mg	± 10 mg	± 30 mg
100g	± 0.05 mg	± 0.16 mg	± 0.5 mg	± 1.6 mg	± 5.0 mg	± 16 mg	± 50 mg
200g	± 0.10 mg	± 0.3 mg	± 1.0 mg	± 3.0 mg	± 10 mg	± 30 mg	± 100 mg
500g	± 0.25 mg	± 0.8 mg	± 2.5 mg	± 8.0 mg	± 25 mg	± 80 mg	± 250 mg
1kg	± 0.5 mg	± 1.6 mg	± 5.0 mg	± 16 mg	± 50 mg	± 160 mg	± 500 mg
2kg	± 1.0 mg	± 3.0 mg	± 10 mg	± 30 mg	± 100 mg	± 300 mg	± 1000 mg
5kg	± 2.5 mg	± 8.0 mg	± 25 mg	± 80 mg	± 250 mg	± 800 mg	± 2500 mg
10kg	± 5.0 mg	± 16 mg	± 50 mg	± 160 mg	± 500 mg	± 1600 mg	± 5000 mg
20kg	± 10 mg	± 30 mg	± 100 mg	± 300 mg	± 1000 mg	± 3000 mg	± 10 g
50kg	± 25 mg	± 80 mg	± 250 mg	± 800 mg	± 2500 mg	± 8000 mg	± 25 g
100kg		± 160 mg	± 500 mg	± 1600 mg	± 5000 mg	± 16 g	± 50 g
200kg		± 300 mg	± 1000 mg	± 3000 mg	± 10 g	± 30 g	± 100 g
500kg		± 800 mg	± 2500 mg	± 8000 mg	± 25 g	± 80 g	± 250 g
1000kg		± 1600 mg	± 5000 mg	± 16 g	± 50 g	± 160 g	± 500 g
2000kg			± 10 g	± 30 g	± 100 g	± 300 g	± 1000 g
5000kg			± 25 g	± 80 g	± 250 g	± 800 g	± 2500 g

Balances/Weights

1



1 Calibration weights, class M1

Brass, finely turned (also available in stainless steel). Plastic box with internal foam support available on request. Also available with internationally recognised DAkkS calibration certification on request.

Kern & Sohn

Weight g	Accuracy ± mg	PK	Cat. No.
1	1.0	1	9.900 501
2	1.2	1	9.900 502
5	1.5	1	9.900 505
10	2.0	1	9.900 510
20	2.5	1	9.900 512
50	3.0	1	9.900 515
100	5.0	1	9.900 520
200	10	1	9.900 522
500	25	1	9.900 525
1000	50	1	9.900 531
2000	100	1	9.900 532
5000	250	1	9.900 535

Also available: Single weights or complete weight sets in OIML-classes E1, E2, F1, F2, M1, M2, M3.

2



2 Calibration weights, class F1, cylindrical

Stainless steel, polished. Plastic boxes with internal foam support or wooden boxes and internationally recognised DAkkS certificates are separately available.

Kern & Sohn

Weight g	Accuracy ± mg	PK	Cat. No.
1	0,1	1	7.630 402
2	0,12	1	7.651 146
5	0,16	1	7.651 098
10	0,2	1	7.608 143
20	0,25	1	6.056 393
50	0,3	1	6.054 634
100	0,5	1	6.253 660
200	1	1	6.056 390
500	2,5	1	6.901 628
1000	5	1	6.229 584
2000	10	1	6.056 389
5000	25	1	6.054 631

Also available: Single weights or complete weight sets in OIML-classes E1, E2, F1, F2, M1, M2, M3.

3



3 Calibration weights, class F1, compact shape

Stainless steel, polished. Plastic boxes with internal foam support or wooden boxes and internationally recognised DAkkS certificates are separately available.

Kern & Sohn

Weight g	Accuracy ± mg	PK	Cat. No.
1	0.1	1	6.285 539
2	0.12	1	4.659 260
5	0.16	1	4.659 261
10	0.2	1	6.267 155
20	0.25	1	7.940 456
50	0.3	1	6.267 562
100	0.5	1	6.242 987
200	1	1	4.659 262
500	2.5	1	6.274 992
1000	5	1	6.236 357
2000	10	1	4.659 263
5000	25	1	6.275 891

Also available: Single weights or complete weight sets in OIML-classes E1, E2, F1, F2, M1, M2, M3.

4



4 Calibration weights, class E2, compact shape

Stainless steel, polished. Plastic boxes with internal foam support or wooden boxes and internationally recognised DAkkS certificates are available separately.

Weight g	Accuracy ± mg	PK	Cat. No.
1	0.03	1	6.233 989
2	0.04	1	6.234 003
5	0.05	1	7.639 008
10	0.06	1	7.653 221
20	0.08	1	7.653 222
50	0.10	1	6.233 196
100	0.16	1	6.233 990
200	0.30	1	6.233 991
500	0.80	1	6.233 992
1000	1.60	1	4.652 699
2000	3.00	1	7.653 223
5000	8.00	1	7.671 083

Also available: Single weights or complete weight sets in OIML-classes E1, E2, F1, F2, M1, M2, M3.

1 Undergloves, Cotton

100% Cotton. Monofilament, ideal to wear under chemical protection gloves. 1 pair per pack. **Cat. I**

Size	Length mm	PK	Cat. No.
6	250	1	6.235 155
7	250	1	7.623 809
8	250	1	9.005 222
9	250	1	7.625 555
10	250	1	7.623 881
11	250	1	7.623 810
12	250	1	9.005 223
13	250	1	6.224 187

2 Balance brush

Oval.

Type	Size	Diam. mm	PK	Cat. No.
Brush	1	5	1	2.600 069
Brush	2	6	1	6.266 807
Brush	4	9	1	6.074 169
Brush	6	12	1	6.266 808
Brush set*	2, 4, 6		1	6.266 825

*consisting of one brush each size 2/6mm, size 4/9mm and size 6/12mm

3 Forceps with silicone-coated tips, stainless steel

Kern & Sohn

Type	Length mm	PK	Cat. No.
for weights 1mg to 200g, for E1 to F1	105	1	9.900 790
for weights 500g to 2kg, for E1 to F1	250	1	6.054 809

4 LLG weighing scoops, porcelain

Length mm	PK	Cat. No.
37	1	9.115 350
53	1	6.241 255
64	1	9.115 351

5 Weighing scoops, stainless steel 18/10

ISOLAB

Length mm	PK	Cat. No.
95	1	6.238 169
117	1	6.238 170
125	1	6.238 171

6 Weighing scoops, aluminium

Without counterweight.

Length mm	PK	Cat. No.
70	1	9.301 006
90	1	9.301 008
105	1	9.301 010
120	1	6.203 560

7 Weighing scoops, Borosilicate glass 3.3

Without counterweight.

Length mm	PK	Cat. No.
60	1	9.301 026
80	1	9.301 028
100	1	9.301 030

8 Weighing scoops, glass

Made of high quality Borosilicate glass 3.3. Ideal for powders or granules which are dispensed via the tubular stem.

Funnel shape for loss-free ejection of the weighing sample.

Capacity ml	Length mm	PK	Cat. No.
3	80	1	9.301 066
6	85	1	9.301 067
10	110	1	9.301 068



1

1

Weighing boat parchment paper, Kjeldahl 609, nitrogen-free

Ideal for weighing and transporting all types of sample. Especially for determination of nitrogen according to Kjeldahl (e.g. determination of total protein content in foodstuff). Made of nitrogen-free parchment paper. Can be dropped into the Kjeldahl flask and be dissolved together with the sample.

Whatman

Type	Width mm	Length mm	Height mm	PK	Cat. No.
Kjeldahl 609	10	55	10	100	9.069 011

2

2

Weighing boats MN 808, Paper, nitrogen-free

Pack of 100 pieces.
Paper

MACHERY-NAGEL

Dimensions: 58mm x 10mm x 10mm

Type	Length mm	Width mm	Height mm	PK	Cat. No.
MN 808	58	10	10	100	9.301 069

Other sizes and weighing aids available on request.

3

3

LLG-Weighing paper

- Not treated with nitrogen during production
- Smooth surface
- 45 g/m² paper
- Block of 500 sheets

Dimensions (D x W) mm	PK	Cat. No.
76 x 76	500	6.272 246
102 x 102	500	6.272 247
152 x 152	500	6.272 248

4

4

Weighing paper MN 226

Transparent, smooth. 40 g/m² paper
Block of 100 sheets.

MACHERY-NAGEL

Type	Width mm	Length mm	PK	Cat. No.
MN 226	90	115	100	9.058 975

Further weighing aids available on request.

Weighing Papers, Grade 2122

The weigh paper sheets reliably allow samples to be transferred to scales without adding unwanted substances that could impact analytical results.

Whatman

- Smooth surface allows samples to slide off with ease and not be retained on paper.
- Shiny pergamyne paper allows visual determination that all sample has been removed.
- Extremely thin (0.03 mm) and lightweight (40 g/m²) for safe and secure sample transport.
- No glue or additives (residue-free).

Note: This paper is not low in nitrogen. Therefore, it should not be used for Kjeldahl analysis.

Dimensions (D x W) mm	PK	Cat. No.
150 x 150	500	7.009 805
100 x 100	500	7.009 806

5

5

Playing card rejects

Standard size for use as disposable sample carriers or spatulas. Pack size: 1 kg, not sorted.

Type	PK	Cat. No.
Printed and laminated on both sides	1	9.190 940

1 LLG-Weighing bottles with NS lid, Borosilicate glass 3.3

With writing area.
Available in tall or low shape.

Form	Capacity ml	Diam. mm	Height mm	NS	PK	Cat. No.
low	3	25	25	19/12	1	9.300 151
low	10	35	30	29/12	1	9.300 152
low	11	40	25	34.5/12	1	9.300 150
low	20	50	30	45/12	1	9.300 153
low	29	60	30	50/12	1	9.300 154
low	60	80	30	80/12	1	9.300 155
tall	9	25	40	19/12	1	9.300 160
tall	19	30	50	24/12	1	9.300 161
tall	42	35	70	29/12	1	9.300 162
tall	66	40	80	34.5/12	1	9.300 163
tall	105	50	80	45/12	1	9.300 164



2 Weighing bottles DURAN® tube, with NS stopper

DIN 12605. With white inscription label. Burned-in imprint of capacity and size. Available in high or low shape.

Nominal capacity ml	Form	Body diam. mm	Height mm	NS	PK	Cat. No.
6	low	25	25	24/12	1	9.300 022
15	low	40	25	40/12	1	9.300 021
15	low	35	30	34/12	1	9.300 023
30	low	50	30	50/12	1	9.300 032
45	low	60	30	60/12	1	9.300 037
80	low	80	30	80/12	1	9.300 041
8	tall	20	40	19/12	1	9.300 345
10	tall	25	40	24/12	1	9.300 113
20	tall	30	50	29/12	1	9.300 118
25	tall	35	50	34/12	1	9.300 356
30	tall	40	50	40/12	1	9.300 357
45	tall	40	65	40/12	1	9.300 360
45	tall	35	70	34/12	1	9.300 123
70	tall	40	80	40/12	1	9.300 124
110	tall	50	80	50/12	1	9.300 127



LLG-Sample dishes, Aluminium

High quality aluminium sample dishes, for moisture determination.

Description	Diam. mm	Height mm	PK	Cat. No.
Sample dishes	90	7	80	6.282 670
Sample dishes	100	7	80	6.265 408 3
Sample dishes with rim	100	7	80	6.281 537 4



5 6 LLG-Weighing dishes, aluminium

Made from oil-free, lightweight aluminium. With a flanged, crimped wall for rigidity. Finger-tab handle can be etched for identification prior to weighing.

Ø mm	Height mm	PK	Cat. No.
43	12	100	6.238 138
57	14	100	6.238 139
70	16	100	6.238 140
101 *	8	50	6.236 854

* without Finger-tab handle



7 LLG-Weighing boats, diamond, antistatic, PS

Biologically inert and resistant to dilute and weak acids, aqueous solutions, alcohols, and bases. Temperature range -10 to +70°C. Can be used with microwave moisture analysers. Features a diamond shape that easily flexes for accurate pouring and a wide, flat bottom to resist tipping.

Capacity ml	Colour	Dimensions mm	PK	Cat. No.
5	white	55 x 35 x 6	1000	9.900 788
30	white	85 x 65 x 14	500	9.950 194
100	white	125 x 100 x 19	250	9.950 195
5	black	55 x 35 x 6	1000	9.900 801
30	black	85 x 65 x 14	500	9.950 196
100	black	125 x 100 x 19	250	9.950 197





1 LLG-Hexagonal weighing boats, antistatic, PS

Biologically inert and resistant to dilute and weak acids, aqueous solutions, alcohols, and bases. Temperature range -10 to +70°C. Can be used with microwave moisture analyzers. Bend flexible boats at points to form pour spouts. Flat bottoms to resist tipping. Sloping sides provide accurate transfer.

Colour	Size	Dimensions mm	PK	Cat. No.
white	Small	38 x 25 x 9	500	9.900 893
white	Medium	64 x 51 x 19	500	9.900 894
white	Large	102 x 76 x 22	500	9.900 895
white	X-Large	127 x 89 x 31	500	9.900 896

2 LLG-Weighing boats, square, antistatic, PS

Biologically inert and resistant to dilute and weak acids, aqueous solutions, alcohols, and bases. Temperature range -10 to +70°C. Can be used with microwave moisture analysers. Boats are shallow with a wide, flat bottom to resist tipping. Rounded corners simplify transfer.

Capacity ml	Colour	Dimensions (W x D x H) mm	PK	Cat. No.
7	White	44 x 44 x 8	1000	9.900 785
100	White	80 x 80 x 24	1000	9.900 786
250	White	140 x 140 x 22	1000	9.900 787
7	Black	44 x 44 x 8	1000	9.900 789
100	Black	80 x 80 x 24	1000	9.900 791
250	Black	140 x 140 x 22	1000	9.900 800

3 Balance bench with granite slab

Constructed to absorb vibrations and oscillations, which would otherwise distort the weighing result. With a granite slab positioned on absorbing rubber components as surface for placing the analytical balance. The work surface surrounds the slab and offers many storage options. The sturdy aluminium frame has four height-adjustable feet, which can be used to accurately level the balance bench on an uneven floor. The inlet on front of the table offers the possibility to work at the bench in an ergonomic standing or seated position without touching the table. All surfaces are easy and hygienic to clean.

Kern & Sohn

Specifications

Dimensions (W x D x H): 800 x 650 x 800 mm (height adjustable)
 Dimensions granite slab (W x D x H): 400 x 450 x 70 mm
 Net weight: approx. 55 kg

Description	PK	Cat. No.
Balance bench with granite slab	1	6.262 477

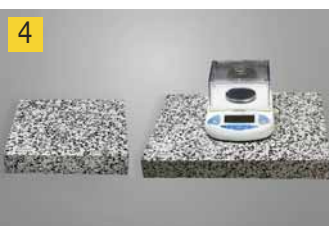

4 Anti-vibration platform, Vibrasorb

For absorbing and damping vibrations down to 16Hz. Comprises of a moulded terrazzo slab supported on four vibration absorbers with non-slip feet. Suitable for isolating sensitive analytical instruments such as balances and microscopes. Will support up to 16kg.

Bel-Art Products

- Polished surface
- Resists scratches and chemical attack

Width mm	Depth mm	Height mm	Weight kg	PK	Cat. No.
350	350	76	19	1	9.941 600
450	560	76	39	1	9.951 600

3. Analytical measurement and testing Thermometers/Laboratory thermometers

LLG-General purpose thermometers *economy*

Solid stem, with loop, capillary yellow enameled, graduation resistant against acids and alkalis. Red filling or environmentally friendly blue filling.

Measuring range °C	Graduations °C	Length mm	Diam. mm	Immersion depth	Charge colour	PK	Cat. No.
-10 ... +50	1	300	6	total	red	1	9.237 010
-10 ... +100	1	300	6	total	red	1	9.237 011
-10 ... +150	1	300	6	total	red	1	9.237 012 1
-10 ... +200	1	300	6	total	red	1	9.237 013
-10 ... +250	1	300	6	total	red	1	9.237 014
-10 ... +110	1	300	6	76 mm	blue	1	9.237 015
-10 ... +110	0.5	300	6	76 mm	blue	1	9.237 016 2
-10 ... +150	1	300	6	76 mm	blue	1	9.237 017
-10 ... +250	1	300	6	76 mm	blue	1	9.237 018
-10 ... +360	2	300	6	76 mm	blue	1	9.237 019

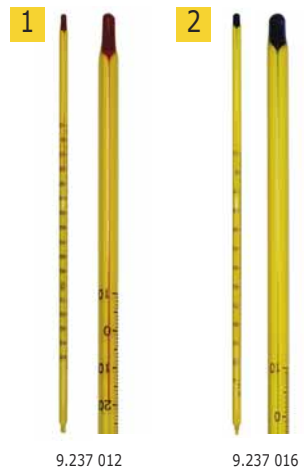

9.237 012

9.237 016

3 LLG-General purpose thermometer, red filling

Graduation resistant against acids and alkalis.

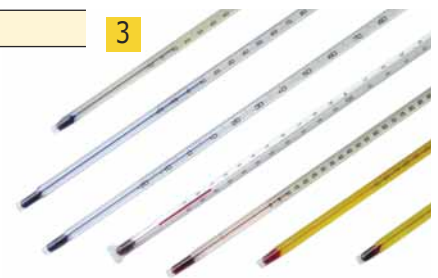

3

Measuring range °C	Graduations °C	Length mm	Diam. mm	Immersion depth	Capillary	PK	Cat. No.
-35 ... +50	1	300	6 ±1	total	white enameled, round	1	9.236 720
-20 ... +110	1	300	6 ±1	total	white enameled, round	1	6.206 594
-20 ... +150	1	300	6 ±1	total	white enameled, round	1	9.236 723
-20 ... +150	1	300	6 ±1	76 mm	white enameled, round	1	9.236 731
-10 ... +110	1	260	6 ±1	total	yellow enameled, round	1	9.236 721
-10 ... +110	1	270	6 ±1	76 mm	yellow enameled, round	1	9.236 727
-10 ... +150	1	260	6 ±1	total	yellow enameled, round	1	9.236 722
-10 ... +200	1	300	6 ±1	total	yellow enameled, round	1	9.236 724
-10 ... +200	1	300	6 ±1	total	white enameled, round	1	9.236 725
-10 ... +200	1	300	6 ±1	76mm	white enameled, round	1	9.236 730
-10 ... +250	1	300	6 ±1	total	yellow enameled, round	1	9.236 726

4 LLG- General-purpose thermometers, red filling

Enclosed-scale type, with eyelet. With uncoated, prismatic measuring capillary. Red spirit filling (except 9.235 265: blue).

Measuring range °C	Graduations °C	Length mm	Diam. mm	Immersion depth	PK	Cat. No.
-10/0 ... +50	1	200	7 - 8	total	1	9.235 245
-10/0 ... +100	1	260	7 - 8	total	1	9.235 250
-10/0 ... +150	1	260	7 - 8	total	1	9.235 255
-10/0 ... +200*	1	300	7 - 8	total	1	9.235 260
-10/0 ... +250*	1	300	7 - 8	total	1	9.235 265

* Note: With these types the colour can fade after extended periods of use at higher temperatures.



4

5 LLG- General-purpose thermometers, green filling

Glass, solid stem, with loop, white backed. Environmentally friendly thermometer, with biodegradable, green spirit filling.

Measuring range °C	Graduations °C	Length mm	Diam. mm	Immersion depth mm	PK	Cat. No.
-10/0 ... +110	1.0	300	6-7	76	1	9.235 275
-10/0 ... +110	0.5	300	6-7	76	1	9.235 276
-10/0 ... +150	1.0	300	6-7	76	1	9.235 277
-10 ... +250	2.0	300	6-7	76	1	9.235 278
-10 ... +360	2.0	300	6-7	76	1	9.235 279



5

Thermometers/Laboratory thermometers

1



1 LLG-Precision thermometer, calibratable, red filling

Capillary: yellow enameled, round.

Measuring range °C	Graduations °C	Length mm	Diam. mm	PK	Cat. No.
-50 ... +50	1.0	280	6 ±1	1	9.236 800
-10 ... +100	1.0	305	6 ±1	1	9.236 783
-10 ... +150	1.0	305	6 ±1	1	9.236 784
-10 ... +200	1.0	350	6 ±1	1	9.236 788
-50 ... +50	0.5	300	6 ±1	1	9.236 801
-10 ... +100	0.5	270	6 ±1	1	9.236 785
-10 ... +150	0.5	350	6 ±1	1	9.236 786
-1 ... +101	0.1	610	6 ±1	1	9.236 790
-0 ... +50	0.1	420	6 ±1	1	9.236 787

2

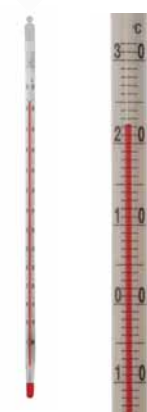

2 LLG-Low temperature thermometers, -200 to +30°C

Suitable for official calibration. Enclosed scale type, 8 to 9mm diameter, with translucent glass scale and Richter seal. Prismatic, uncoated measuring capillary. The -200 to +30°C thermometer has a luminous blue measuring capillary, and is pentane filled. Further thermometers are available, red toluene filled with uncoated measuring capillary. Graduated every 1°C.

Measuring range °C	Length mm	PK	Cat. No.
-50 ... +50	300	1	9.235 705
-100 ... +30	300	1	9.235 710
-200 ... +30	300	1	9.235 720

3



3 Thermometers, ground glass joint

With NS14.5/23 cone. Enclosed-scale type, NS 14.5/23. Translucent glass scale. Upper section approx. 11mm diameter, lower section 7.5mm diameter. Richter-top finish seal without button. Suitable for official calibration. Graduated every 1°C.

Measuring range °C	Graduations °C	Corpus mm	Immersion depth mm	Charge colour	PK	Cat. No.
-10 ... +150	1	250	52	red	1	9.236 021
-10 ... +15	0.5	350	52	red	1	9.236 022
-10 ... +25	1	300	52	blue	1	9.236 023
-10 ... +360	1	350	52	green	1	9.236 024
-10 ... +150	1	250	77	red	1	9.236 025
-10 ... +150	0.5	350	77	red	1	9.236 026
-10 ... +250	1	300	77	blue	1	9.236 027
-10 ... +360	1	350	77	green	1	9.236 028

(Built-in length = Immersion depth + 23 mm for ground joint)

4

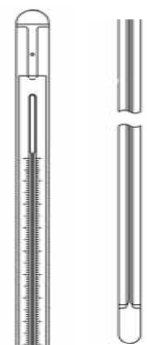

4 Precision ground thermometer, enclosed-scale type, with works calibration certificate

Acc. to DIN 12784, with standard ground joint NS 14.5/23. Enclosed-scale type, capillary: **transparent prismatic**, diam. top: 11 mm (±0.5 mm), suitable for calibration.

Ludwig Schneider

Measuring range °C	Graduations °C	Built-in length mm	Charge	Joint size NS	PK	Cat. No.
-10 ... +150	1	175	blue	14,5/23	1	6.289 969
-10 ... +150	1	200	blue	14,5/23	1	6.289 970

5



5 Adapter for thermometer, borosilicate glass 3.3

Manufactured from borosilicate glass 3.3 according to DIN 12257 standard, ideal to use for thermometers with Ø 6 - 8 mm. Screw joint provides easy depth adjustment of thermometer. Seal material: NBR

ISOLAB

Adapter bore diam. mm	Cone NS	Neck thread GL	PK	Cat. No.
6 - 8	14/23	14	1	4.008 360
6 - 8	29/32	14	1	6.244 589

1 ASTM-Thermometers ACCU-SAFE, stem type

High precision and mercury free. ASTM-Thermometers with blue, environmental safety filling, suitable for calibration, immersion total. With DAkkS-calibration or works-calibration certificate on request.

Ludwig Schneider

1



Further types available on request, also in °F.

Measuring range °C	Graduations °C	Length mm	Immersion depth	Charge	Type ASTM	PK	Cat. No.
-38 ... +50	1,0	260	108	blue	S 5C	1	9.236 850
-20 ... +102	0,2	435	total	blue	S12C	1	9.236 852
-2 ... +80	0,2	415	total	blue	S15C	1	9.236 854
+34 ... +42	0,1	300	total	blue	S18C	1	9.236 856
+95 ... +103	0,1	300	total	blue	S22C	1	9.236 858
+19 ... +35	0,02	610	total	blue	S56C	1	9.236 860
-34 ... +49	0,5	300	total	blue	S58C	1	9.236 862
-18 ... +82	0,5	300	total	blue	S59C	1	9.236 864
-38 ... +2	0,1	401	total	blue	S62C	1	9.236 866
-8 ... +32	0,1	401	total	blue	S63C	1	9.236 868
+25 ... +55	0,1	* 401	total	blue	S64C	1	9.236 870
+50 ... +80	0,1	* 401	total	blue	S65C	1	9.236 872
+75 ... +105	0,1	* 401	total	blue	S66C	1	9.236 874
+95 ... +155	0,2	* 401	total	blue	S67C	1	9.236 876
+18,9 ... 25,1	0,01	615	total	blue	S116C	1	9.236 879
23,9 ... 30,1	0,01	615	total	blue	S117C	1	9.236 880
38,6 ... 41,4	0,05	* 300	total	blue	S120C	1	9.236 881
-7 ... 105	0,5	300	total	blue	S130C	1	9.236 882
+20 ... +50	0,1	390	76	blue	S91C	1	9.236 878

*With auxiliary scale at 0 °C

2 Precision thermometer, calibrated, enclosed form

Capillary: colourless prismatic, diam. Ø 9 ±1 mm, environmentally friendly red filling, with DAkkS calibration certificate. 3 checkpoints.

Ludwig Schneider

2



Measuring range °C	Graduations °C	Length mm	Immersion depth	PK	Cat. No.
-10 ... +100	1	305	total	1	4.658 575
-10 ... +150	1	305	total	1	4.658 580
-10 ... +100	0,5	270	total	1	4.658 576
-10 ... +150	0,5	350	total	1	6.289 516
-5 ... +100	0,2	420	total	1	4.658 577
0 ... +50	0,1	420	total	1	4.658 579
-10 ... +50	0,1	420	total	1	4.658 578

3 Precision thermometer, calibrated, stem type

Capillary: yellow back round, diam. 6 ±1 mm, environmentally friendly red filling, with DAkkS calibration certificate, 3 points.

Ludwig Schneider

3



Measuring range °C	Graduations °C	Length mm	Immersion depth	PK	Cat. No.
-10 ... +100	1	305	total	1	4.658 581
-10 ... +150	1	305	total	1	4.658 582
-10 ... +100	0,5	270	total	1	4.658 583
-5 ... +100	0,2	420	total	1	4.658 584
0 ... +50	0,1	420	total	1	4.658 585
-10 ... +50	0,1	420	total	1	4.658 586

4 Thermometer holder

Bel-Art. PP.

For mounting standard glass thermometers onto the rims of containers. Temperature resistant up to 121 °C. Holds thermometer from 3.2 mm to 11 mm diam.

4



Type	PK	Cat. No.
BEL-ART	1	9.207 922



1 LLG-Exact-Temp thermometers

For monitoring critical temperature conditions in deep freezes, refrigerators, cold rooms, blood bank refrigerators, incubators and warming chambers.

- thermometer certifiable to National Standards
- supplied with works test certificate
- thermometer stem safely encapsulated in PTFE
- each thermometer is mounted in a square-shaped shatter-proof plastic bottle filled with a liquid to ensure accurate readings despite the opening and closing of instrument doors.
- each thermometer has an individual serial number.

LLG-Exact-Temp Standard thermometers, red spirit-filled

Measuring range °C	Length mm	Graduations °C	Bottle filling	PK	Cat. No.
-90 ... +20	145	1.0	Sand	1	9.235 663
-30 ... 0	125	0.50	Ethylene Glycol	1	9.235 664
-5 ... +20	145	0.50	Ethylene Glycol	1	9.235 665
-5 ... +15	125	0.50	Ethylene Glycol	1	9.235 666
+18 ... +50	135	0.50	Ethylene Glycol	1	9.235 667
+20 ... +130	135	1.0	Vermiculite	1	9.235 668
+35 ... +200	145	1.0	Vermiculite	1	9.235 669

LLG-Exact-Temp precision thermometers, blue spirit-filled

Measuring range °C	Graduations °C	Length mm	Bottle filling	PK	Cat. No.
-2 ... +10	0.10	180	Ethylene Glycol	1	9.235 676
+15 ... +30	0.10	180	Ethylene Glycol	1	9.235 678
+25 ... +45	0.10	190	Ethylene Glycol	1	9.235 679
+50 ... +115	0.10	200	Vermiculite	1	9.235 680

2



2 Digital Maxima-Minima-Thermometers Exact-Temp

The unbreakable plastic bottle is filled with a special medium to ensure accurate measurements even at open doors.

Ludwig Schneider

- Thermometers traceable to international standards (with certificate of conformance and accuracy)
- Accuracy: $\pm 0.5^{\circ}\text{C}$, resolution 0.1°C
- Temperature units: $^{\circ}\text{C}$ or $^{\circ}\text{F}$
- 3 display modes: maximum, minimum and ambient temperature
- Alarm function
- 3 m long cable (diameter: 1mm)
- Alkaline battery (AAA) included
- Breakage protected PETG plastic bottles (with 30ml ethylene glycol mixture)
- Bottles with magnets attached for easy wall or door mounting
- Individual serial numbers
- The instruments are available with works certificate on request.

Application	Measuring range °C	Certified Temperature °C	PK	Cat. No.
Freezers	-50 ... 70	-20	1	9.236 710
Freezing point	-50 ... 70	0	1	9.236 711
Refrigerators	-50 ... 70	4	1	9.236 712
Incubators/Water baths	-50 ... 70	37	1	9.236 713
Climate chambers	-50 ... 70	21	1	9.236 714

Mini temperature indicators

Self-adhesive, temperature-sensitive films that respond to certain temperature increases by changing colour. If the respective temperature is exceeded, the corresponding field changes colour permanently within 2-3 seconds. For monitoring products or processes where a certain maximum temperature should not be exceeded.

Testo

1



7.036 852

Specifications

Dimensions: diam. 15 mm
 Storing conditions: max. 25 °C (storage in freezer recommended)

Temp. range °C	Accuracy	PK	Cat. No.
60 ... 82	±1.5 °C	10	7.036 852 1
88 ... 110	±1.5 °C	10	7.036 853
116 ... 138	±1.5 °C	10	7.036 854
143 ... 166	±2 °C (+143 ... +154 °C) ±(1 °C + 1 % of measured value) (remaining range)	10	7.036 855
171 ... 193	±(1 °C + 1 % of measured value)	10	7.036 856
199 ... 224	±(1 °C + 1 % of measured value)	10	7.036 857

Temperature indicators WarmMark™

Self-adhesive indicators to monitor temperature exceedance and duration, e.g. when transporting temperature-sensitive goods. The indicator reliably indicates whether the temperatures were above the selected temperature limit by red dots. In addition, the indicator provides information on the duration of the temperature exceedance (the time is based on a constant temperature overrun of 2 °C above the limit value of the indicator).

Transport Control

2



4.668 451

- Selection of different temperatures
- Clear display of temperature exceedances and the duration of the exceedance
- Self-adhesive, easy to apply
- ISO-certified
- Dimensions (W x D x H): 19 x 46 x 1.5 mm

Type	PK	Cat. No.
-18 °C	100	4.668 449
0 °C	100	4.668 450
8 °C	100	4.668 451 2
25 °C	100	4.668 452

Temperature indicators 3M™ Freeze Watch™

The Freeze Watch consists of a highly sensitive indicating liquid inside a specially designed ampule. The ampule fractures when exposed to freezing temperatures, irreversibly staining the paper backing of the ampule, reliably indicates if the product has been exposed to too high or too low a temperature.

3M Deutschland

3



7.672 572

- Selection of different temperatures
- Self-adhesive, easy to apply

Type	Temp. range °C	PK	Cat. No.
9800FW	-4 °C	400	4.668 640
9805FW	0 °C	400	7.672 572 3

Time/Temperature indicators 3M™ MonitorMark™

3M™ MonitorMark™ Time Temperature Indicator 9860C solves the challenge of monitoring thermal exposure of temperature-sensitive products during transportation and storage. The large indicator window displays exposure, the smaller windows to the right indicate for how long temperature exposure took place.

3M Deutschland

4



4.668 641

- Clear display of temperature exceedances and the duration of the exceedance
- Self-adhesive, easy to apply

Type	Temp. range °C	For	PK	Cat. No.
9860C	10 °C	48 H	500	4.668 641 4
9860H	31 °C	1 Week	500	4.668 642
9860E	26 °C	48 H	500	4.668 643
9861A	10 °C	2 Week	500	6.274 756
9860D	10 °C	1 Week	500	6.284 635

1

9.246 310

2

9.246 314

5-step irreversible temperature strips Thermax®

5-step irreversible temperature measuring strips covering the temperature range 29 to 290°C. Each strip measures 35 x 15mm.

Type	Measuring range °C	PK	Cat. No.
S	+29 ... +40	10	9.246 310 1
A	+37 ... +46	10	9.246 311
B	+49 ... +71	10	9.246 312
C	+77 ... +99	10	9.246 313
D	+104 ... +127	10	9.246 314 2
E	+132 ... +154	10	9.246 315
F	+160 ... +182	10	9.246 316
G	+188 ... +210	10	9.246 317
H	+ 216 ... +249	10	9.246 318
I	+249 ... +290	10	9.246 319

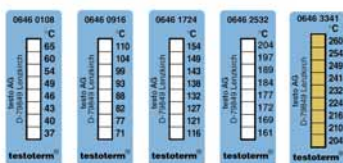
3

3 8-step irreversible temperature strips testoterm®

Strips for 8 temperatures. 5 types cover the measuring range +37 to +280 °C, each strip displays 8 different temperatures. Each strip measures 50 x 18mm.

Testo

Measuring range °C	PK	Cat. No.
+37 ... +65	10	9.246 002
+71 ... +110	10	9.246 003
+116 ... +154	10	9.246 004
+161 ... +204	10	9.246 005
+204 ... +260	10	9.246 006

4

4 Min/Max-Thermometer

- ivory plastic
- beige
- with push button
- mercury-free

TFA Dostmann

Type	Dimensions mm	Weight g	PK	Cat. No.
Min/Max-Thermometer, beige	85 x 45 x 232	88	1	9.241 134

5

5 LLG-Min/Max Thermometer with outdoor sensor

- Digital thermometer with outdoor sensor.
- Two-tier LCD display
 - Measuring temperature range -50°C to +70°C, can be switched to °F
 - Display resolution 0.1°C
 - Accuracy ±1°C
 - Dimensions 110 x 70 x 20mm
 - Display size 40 x 30mm
 - AAA 1.5V battery included
 - Length of the cable 190cm

Type	PK	Cat. No.
LLG Min/Max Thermometer with outdoor sensor	1	9.243 165

6

6 Maximum/Minimum Indoor/outdoor thermometer

Optimal for controlling of refrigerator and freezer temperatures. With temperature alarm.

Amarell

- Measuring range: -50 to +70°C
- Accuracy: 0.1°C
- External remote sensor cable PVC, length 3m
- Dimensions: approx. 65 x 67 x 23 mm

Type	PK	Cat. No.
Dual Thermo Max / Min with temperature alarm	1	6.273 798

Min/Max alarm thermometer, type 13030, digital

Display of 3 temperatures, with min/max alarm, memory date/time and pull-out stand. *Ludwig Schneider*
 - Without Certificate: temperature sensor with 3 m cable, response time T 90 = 10 sec.
 - With Certificate: temperature sensor with 3 m cable attached in 5 ml plastic bottle filled with ethylene glycol/water (for measuring delay/alarm lag during opened door). With serial number, certified at a defined temperature, certificate traceable to international standards (PTB, NIST, ILAC)



Type	Description	PK	Cat. No.
Without Certificate	-	1	6.263 179 1
With Certificate	for freezers, approved at -20 °C	1	6.261 440
With Certificate	for refrigerators, approved at +4 °C	1	6.261 441

2 Digital Maxima-Minima-Thermometer

Digital thermometer, wall hanging, for indoor or outdoor use. With blue, splash-proof casing, selectable °C/°F ranges and battery. *TFA Dostmann*
 weight: 161g



Width mm	Depth mm	Height mm	Description	PK	Cat. No.
75	44	115	-20 ... +50 °C	1	9.241 131

3 Laboratory Max./Min. thermometer

Display of current, highest and lowest temperature, hold function, alarm at freely adjustable temperature values optical and audibly (upper/lower limit), selectable °C/°F readout. Supplied with table stand and magnet. 3V Lithium CR2032 button cell (acc. to EN 13485).



Specifications **LT101 | LT102**
 Sensor: NTC
 Resolution: 0.1 °C
 Response time t90: appr. 15 seconds in water
 Dimensions (L x W x H): 86 x 57 x 30 mm
 Sensor tube (L x diam.): 100 x 3.5 mm | 30 x 5 mm
 Weight: 100 g

Type	Measuring range °C	Accuracy (±) °C	Cable m	PK	Cat. No.
LT101	-40 ... +200	2	1	1	6.234 373

Refrigerator thermometers TMX series

Digital minimum/maximum thermometers for monitoring refrigerator temperatures. *ebro*
 Display of the current temperature and the set minimum/maximum limit values. Models 310 and 320 are equipped with an internal and an external temperature sensor, models 410 and 420 with 2 external temperature sensors.

- Visual and acoustic alarm when limit values are exceeded
- The external temperature sensor is located in a glycol bottle or in a metal capsule, depending on the device.
- With 3-point calibration option
- Incl. factory calibration certificate for -20 and 60 °C



Specifications
 Temperature range external sensor: -50 ... 70 °C
 Temperature range internal sensor: 0 ... 50 °C
 Resolution: 0.1 °C
 Accuracy: -20 ... 40 °C: ±0.5 °C/±1.0 °C for remaining temperature range
 Cable length: 3 m
 Housing material: ABS
 IP code: IP 20
 Dimensions (W x D x H): 100 x 23 x 110 mm
 Power supply: 1 x AAA



Type	PK	Cat. No.
310, with internal and external sensor in glycol bottle	1	4.666 540 4
320, with internal and external sensor in metal capsule	1	4.666 541 5
410, with 2 external sensors in glycol bottle	1	4.666 542
420, with 2 external sensors in metal capsule	1	4.666 543

Thermometers/Surface, Insertion thermometers

1



1 LLG-Digital pocket thermometer Type 12050

Measuring range -50 to +150°C, accuracy ±1°C. Probe made of stainless steel, 120 x 3.5mm, with protective plastic sleeve and clip, with battery 1 x 1.5V (LR44). Overall dimensions (L x W): 75 x 20mm.

Type	PK	Cat. No.
LLG-Digital pocket thermometer Type 12050	1	9.236 706

2



2 LLG-Digital pocket thermometer Type 12060

Measuring range -50 to +150 °C, accuracy ±1 °C. With hold function. Probe made of stainless steel, 125 x 3.5mm, with protective plastic sleeve and clip, with battery 1 x 1.5V (LR44). Dimensions (L x W): 60 x 20mm.

Type	PK	Cat. No.
LLG-Digital pocket thermometer Type 12060	1	9.236 701

3



3 LLG-Digital pocket thermometer Type 12070

Measuring range -50 to +300°C, accuracy ±1°C until 150°C, above ±2°C. With hold function. Probe 200 x 3.5mm with tip made of stainless steel, with adjustable protective plastic sleeve and clip, with battery 1 x 1.5V (LR44). Dimensions (L x W): 78 x 25mm.

Type	PK	Cat. No.
LLG-Digital pocket thermometer Type 12070	1	9.236 702

4



4 Thermometer Pocket-Digitemp

Waterproof instrument in plastic housing (food-grade). Low budget, durable instrument for measuring temperature in air, gas, liquid and ductile substances (acc. to EN 13485).

Dostmann electronic

Range of applications: Food (HACCP), industry and agriculture.

Features: waterproof, 1-second measuring frequency, Max-Min-Hold function, °C/°F-selectable.

Sensor:	NTC
Measuring range:	-40°C to +200°C
Resolution:	0.1°C
Accuracy:	±0.8°C (at 0°C to 100°C) others 1.5°C
Dimensions:	202 x 20 x 16mm (long version) 150 x 20 x 16mm (short version)
Probe dimensions:	126 x 3.5mm (long version) 75 x 3.5mm (short version)
Weight:	40g
Protection class:	IP65

Type	PK	Cat. No.
short version	1	9.851 028
long version	1	9.851 029

5



5 Digital pocket thermometer ThermoJack/ThermoJack PRO

Foldable pocket thermometer, watertight. Ideal for measuring foods (acc. to EN13485), liquids etc. ThermoJack PRO with calibration certificate.

Dostmann electronic

Type	Measuring range °C	Accuracy °C	Resolution °C	Probe	PK	Cat. No.
ThermoJack	-40 ... +250	± 0.5 (-20 ... +150)*	0.1	70	1	9.851 997
ThermoJack PRO	-50 ... +350	± 0.5 (-30 ... +150)*	0.1	110	1	9.851 999

*otherwise ±1.0°C or 1%, the larger value applies

3. Analytical measurement and testing Thermometers/Surface, Insertion thermometers

1 Digital pocket thermometer TLC 700

The practical folding thermometer TLC 700 is suitable for measuring the core temperature during transport, storage and receiving of goods. Thanks to the foldable penetration probe the waterproof thermometer (IP 65) can be stored safely. The device is primarily characterized by its small size and the large display and comes with a calibration certificate.

ebro



Specifications

Measuring range/Resolution:	-30 to +220°C/ 0.1°C
Accuracy:	±0.5°C (-30 to +100°C) ±1.0°C (remaining range)
Probe:	70mm
Battery type:	1 x 3V (CR 2032)
Dimensions (W x D x H):	118 x 33 x 15mm
Weight:	approx. 41g

Type	PK	Cat. No.
Digital pocket thermometer TLC 700	1	9.908 018

2 Digital hand held thermometer Type 12200

Waterproof. Measuring range -50 to +300°C/-58 to +572°F, accuracy ±1°C until 150°C above ±2°C. With hold function and Max/Min function. Penetration probe made of stainless steel, 140 x 3.5mm with 1m cable and handle. With battery 1 x 1.5V AAA. Overall dimensions (L x W): 140 x 75mm.

2



Type	PK	Cat. No.
Digital hand held thermometer Type 12200	1	9.236 705

Core Thermometer TTX 110

The robust and shock-resistant insertion thermometer TTX 110 are suitable for HACCP core temperature measurement during transport, storage and incoming goods department in accordance with DIN EN 13485 as well as for laboratory temperature measurements.

ebro

- Battery included and replaceable by the user if required
- Splash-proof
- Factory calibration certificate
- Temperature probe for TTX 110 is permanently attached, needle Ø 3 mm, length = 90 mm, pointed

3



6.230 658

Specifications

Measuring range:	-50 to 350°C
Accuracy:	±0.8°C or ±0.8%, with the bigger value being applicable
Resolution:	0.1°C from -60°C to 199°C and 1°C for the remaining measuring range
Housing material:	ABS
Operating temperature:	-20°C to 50°C
Storage temperature:	-30°C to 70°C
Reaction time (90%):	5s
Dimensions:	90 x 42 x 17 mm (without probe)
Battery lifetime:	typical 100 h with uninterrupted use
Battery:	CR 2032, replaceable
IP code:	IP 55

Type	Description	PK	Cat. No.
TTX 110	Fixed probe without cable	1	6.230 658 3
TTX-WM	Wall holder for TTX 100/TTX 110	1	9.908 026

1

1 Digital hand held thermometer TTX 200

For measuring the core temperature with fixed probe with cable and handle.

ebro

- Very large display with large figures
- Easy handling, easy to read
- Replaceable battery
- Factory calibration certificate

Specifications

Temperature range:	-30 ... +199.9 °C
Resolution:	0.1 °C
Accuracy:	±0.5 °C (-30 ... +100 °C), otherwise ±1 %
Temperature sensor:	Type T
Sensor length/diam.:	120 mm/3 mm
Cable length:	600 mm
Housing:	ABS
Working temperature:	-20 .. +60 °C
Storage temperature:	-30 .. +70 °C
Dimensions (L x W x H):	127 x 60 x 16 mm (without sensor)
Weight:	approx. 220 g
Power supply:	CR 2032
Battery life time:	approx. 100 h (continuous use)
Protection class:	IP 55

Type	PK	Cat. No.
TTX 200	1	6.291 272

2

2 Hand held thermometer Type 13100

Digital temperature measuring device with 2 input channels, incl. 1 sensor with flat plug (measuring range up to approx. +150 °C, cable length: 3 m). For measuring sensors type K (NiCr-Ni). Measuring range: -200...+1370 °C/-328...+2498 °F. Resolution: 0.1 °C/F.

Ludwig Schneider

Accuracy: ±0.1 %. With hold function, with max/min memory and automatic switch-off after 30 min. With PC interface and bag. Battery: 1 x 9 V block. Dimensions: 184 x 64 x 30 mm

Description	PK	Cat. No.
Hand held thermometer Type 13100	1	9.236 715
Power adapter (100-240V, 50-60Hz)	1	9.236 716
Insertion sensor with handle type K, measuring range: -50 to +600°C (±2.5°C)	1	9.236 717
Insertion/immersion sensor with handle type K, measuring range: -100 to +200 °C (±2.5 °C)	1	6.313 326
Immersion sensor with handle type K, measuring range: -100 to +800 °C (±2.5 °C)	1	6.313 337
Surface sensor with handle type K, measuring range: -50 to +400°C (±2.5°C)	1	9.236 718
90° Surface sensor with handle type K, measuring range: -50 to +400°C (±2.5°C)	1	9.236 719

3

3 Precision hand-held measuring instrument Type 13760

NEW

Precision hand-held measuring instrument with Pt100 temperature sensor and data logger function for resistance thermometers.

Ludwig Schneider

- Functions: °C/°F selection, min/max memory, freeze display, calibration mode, data logger, automatic switch-off
- Relative measurement: saves the last measured temperature and shows the difference to the most similar measurement
- Display: date/time, backlit, battery status
- Pt100 temperature sensor 4-wire, class A, IEC751 (replaceable)

Scope of supply: Thermometer, Pt100 temperature sensor, carrying case, power adapter

Specifications

Measuring range:	-100 ... +400 °C
Accuracy:	±0.2 °C (-50 ... +150 °C)
Resolution:	0.01 °C
Ambient temperature:	0 ... +50 °C
Memory:	16000 values
Material Thermometer/Probe:	plastic/platinum
Dimensions Thermometer (W x D x H)/Probe (Ø x L):	185 x 65 x 36 mm/5 x 230 mm
Cable length:	1.5 m
Power supply:	9 V battery or 9 V DC power adapter

Type	PK	Cat. No.
13760	1	6.313 342

3. Analytical measurement and testing Thermometers/Surface, Insertion thermometers

1 Core thermometer Testo 106

Ideal for quick, simple core temperature measurements in various fields, e.g. restaurants, hotels, service kitchens, supermarkets etc. Wide measurement range and highly accurate. With Auto-Hold function for final reading. Includes sensor protection cap and battery. Calibration certificate on request.

Testo

The testo 106-T1 kit also contains a TopSafe protective case and a holster clip for belt or wall.

Specifications

Temperature range (°C): -50 to +275
 Accuracy ±1 digit (°C): ±1% of measurement value (+100 to +275)
 ±0.5 (-30 to +99.9)
 ±1 (-50 to -30.1)
 Resolution (°C): 0.1
 Battery type: Lithium (CR2032)

Type	PK	Cat. No.
Testo 106	1	9.718 208
Testo 106-T1 Kit	1	9.718 209
TopSafe protective sleeve (IP67)	1	9.718 232

1



2 Digital thermometer ama-digit ad 15 th

- Available in five colours
- Precise and cost-effective
- With stainless steel sensor approx. 30 x 2.5 mm (L x dia)
- With battery

Amarell

Colour	Dimensions (W x D x H) mm	Temp. range °C	Resolution temperature °C	PK	Cat. No.
blue	90 x 60 x 25	-40 ... 120	0.1	1	6.077 362
yellow	90 x 60 x 25	-40 ... 120	0.1	1	6.084 555
red	90 x 60 x 25	-40 ... 120	0.1	1	6.084 856
green	90 x 60 x 25	-40 ... 120	0.1	1	6.200 783
black	90 x 60 x 25	-40 ... 120	0.1	1	9.243 101

2



3 Digital thermometer ama-digit ad 20 th

Temperature range: -50 to +300°C. Resolution 0.1°C from -50 to +180°C, 1°C for the rest of the range. Dimensions (W x D x H) 90 x 60 x 25mm. With battery. For appropriate temperature probes see order no. 9.243 111 to 114.

Amarell

Type	PK	Cat. No.
ama-digit ad 20 th	1	9.243 102

3



4 Temperature probes, Pt100 for ama-digit ad 20 th

Class A. Stainless steel sheathed probe, approx. 105 x 3mm L x dia. With handle and approx. 1m cable.

Amarell

Type	PK	Cat. No.
Pt100 immersion probe	1	9.243 111
Pt100 penetration probe	1	9.243 112
Pt100 surface probe	1	9.243 113
Pt100 air probe	1	9.243 114

4

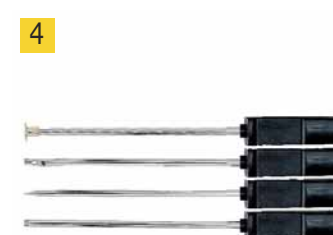

5 Temperature measuring instrument testo 108

- Easy operation and handling
- Instrument and probe waterproof (IP67)
- Conform to HACCP and EN 13485
- Universally applicable

Testo

Specifications

Measuring range: -50 to +300 °C
 Accuracy: ±0.5 °C (-30 to +70 °C)
 ±0.5 °C ±0.5 % of mv (Remaining Range)
 Resolution: 0.1 °C
 Battery type: 3 x AAA

Description	PK	Cat. No.
testo 108	1	6.254 472

5



1
1 Stem thermometer, bluetooth H-B®, stainless steel
NEW
Bel-Art Products

Monitor the temperature of critical environments remotely with Bluetooth wireless data transfer from the thermometer to the THERMSmart app (available for iPhone and Android devices).

- Maximum signal distance is approximately 40 meters
- Alarm sounds to alert user if temperature falls outside of the set parameters
- Includes countdown timer function
- Alarm and timer settings savable for reuse
- LCD screen
- Includes certificate of compliance indicating accuracy for 4 temperature points and multi-language (English, French, German, Italian, Portuguese and Spanish) instructions
- Individually serialised and RoHS compliant
- Batteries included (CR2032)

Specifications

Temperatur range: -50 ... 300 °C
 Accuracy: ±1 °C (0 - 40 °C)
 ±2 °C (-50 - 0 °C, 40 - 200 °C)
 ±2 % (>200 °C)

Type	PK	Cat. No.
Stem thermometer, bluetooth	1	4.674 979

2
2 Temperature meter, digital, testo 925
Testo

Without probe. Economical. Very robust. With 1 measuring input.

With battery and calibration protocol. For °C, °F, °K. Hold function and battery display.

Digital thermometers, testo 925, accessory probes:

- Waterproof immersion/penetration probe
- Precise and rapid, waterproof immersion probe
- Rapid reaction surface probe
- Robust, economical, air probe

Measuring range: -50 to +1000°C
 Sensor: Type K (NiCr-Ni)
 Accuracy: -40 to +900°C : ±0.5°C, ±0.3%
 remaining range: ±0.7°C, 0.5%
 Battery: 9V, 6F22

Type	PK	Cat. No.
Temperature meter, digital, testo 925	1	9.851 324
TopSafe testo 925, protective cover against impact and dust	1	9.718 011
Immersion / penetration probe	1	9.718 200
Immersion probe	1	9.718 202
Surface probe	1	9.718 222
Air probe	1	9.718 230

3
3 Thermocouples with TC adapter for testo 925
Testo

Flexible, TC adapter type K.

Length mm	Material	PK	Cat. No.
800	Fibre glass	1	9.851 724
1500	Fibre glass	1	7.036 710
1500	PTFE	1	7.036 711

3. Analytical measurement and testing Thermometers/Surface, Insertion thermometers

Digital thermometer testo 110

Without probe. For use with accessory NTC sensor probes (option). For control measurements in the food industry and laboratories. Features: switchable °C readout, with Hold function, low battery indicator and battery saving automatic switch-off after a period without use. With battery and calibration certificate.
Accuracy: System accuracy using immersion/penetration probes.

Testo

1



9.851 300

Measuring range: -50 to +150 °C
 Sensor: ±0.2 °C (-20 to +80 °C)
 ±0.3 °C (Remaining Range)
 Accuracy: 0.1 °C
 Battery: 9V block battery

Description	Measuring range °C	PK	Cat. No.
Digital thermometer testo 110	-50 ... +150	1	9.851 300 1
TopSafe (IP68 protective boot)		1	9.718 020
NTC foodstuffs sensor	-35 - +120	1	9.851 714
NTC immersion/penetration probe, diam. 4mm, length 110mm	-50 ... +150	1	9.851 716
NTC surface probe, with widened measuring tip, diam. 5mm, length 115mm	-50 ... +150	1	9.851 720
NTC air probe, robust, diam. 5mm, length 115mm	-50 ... +125	1	9.851 723
Robust food penetration probe with special handle, diam. 5mm, length 115mm	-25 ... +150	1	9.851 352

2 Electronic Contact Thermometer GFX 460

Attributes:
 - high accuracy through fuzzy logic algorithm
 - minimizes temperature overshoot
 - suitable for all magnetic stirrers

ebro

2



Safety features: Probe failure identification, Probe limit warning.
 Safety and control circuit according to DIN 12878 Class 1 and 2

Also suitable for Heidolph Magnetic stirrers MR-Hei Standard constructed up to June 2014.

Specifications

Measuring range: -50 to +300 °C
 Resolution: 1 °C
 Accuracy: ±1 °C
 Measuring rate: 1s
 Measuring probe: Pt1000
 Operating temperature: -5 to +60 °C
 Storage temperature: -30 to +70 °C
 Type of control: Fuzzy logic control
 IP code: IP 65
 Connection: 5-pin diode plug DIN 45322
 Display: Background illumination LED display for control status
 Power supply: external 9-12 V d.c., 20 mA
 Dimensions (W x D x H): 54 x 22 x 110 mm without probe
 Housing material: Polyamide, acid-resistant
 Weight: approx. 150 g

Type	Description	PK	Cat. No.
GFX 460	with V2A probe, 205 x 3 mm L x dia.	1	9.908 056
GFX 460-G	with glass-coated probe, 235 x 7 mm L x diam.	1	9.908 057
GFX 460-B	without probe	1	6.235 187
Relay box		1	9.908 059

1

1 Laboratory Thermometer TFX 410-1/TFX 420

Robust and impact resistant temperature measurement device for Pt 1000 penetration probe (connection Lemo size 0). TFX 420 with MIN, MAX & Hold function. For control measurements in laboratories, food sector, storage and incoming goods. For temperature determination of air, liquids, plastic substances and food. Conform to HACCP and DIN EN 13485. With battery and factory calibration certificate.

- Probes made of stainless steel, for temperatures up to +400 °C
- Accuracy: exceeds DIN IEC 584, class 1

Specifications:

Measurement range TFX 410-1/TFX 420:	-50 ... +300 °C/-50 ... +400 °C
Accuracy:	±0.3 °C
Resolution:	0.1 °C
Sensor:	Pt 1000 (connection Lemo size 0)
Housing material:	ABS
Certificate:	3-point factory calibration
Operating temperature:	-25 °C to +50 °C
Storage temperature:	-30 °C to +70 °C
Automatic switch-off:	After 2 hours, optional
Dimensions (L x W x H):	54 x 22 x 109 mm (without probe)
Weight:	Approximately 90 g
Battery:	3.0 V Lithium, replaceable
Battery lifetime:	Approximately 5 years
IP code:	IP 67

Type	Description	Length mm	Diam. mm	PK	Cat. No.
TFX 410-1	Laboratory thermometer (without probe)			1	6.207 171
TFX 410-1 + TPX 400-150	Laboratory thermometer with probe			1	6.243 018
TFX 410-1 + TPX 440	Laboratory thermometer with probe			1	6.224 896
TFX 420 + TPX 400-150	Laboratory thermometer with probe			1	6.243 019
TPX 100	Blunt probe, without cable	120	3	1	9.908 021
TPX 200	Pointed probe, without cable	120	3	1	6.251 438
TPX 200-20	Pointed probe, without cable	200	3	1	9.908 022
TPX 200-30	Pointed probe, without cable	300	3	1	9.908 023
TPX 200-40	Pointed probe, without cable	400	3	1	9.908 024
TPX 400	Pointed probe with 60 cm silicone cable (red) and grip	120	3	1	6.233 543
TPX 400-150	Pointed probe with 150 cm silicone cable (red) and grip	120	3	1	6.254 169
TPX 400-40	Pointed probe with 40 cm silicone cable (red) and grip	120	3	1	9.908 025

2

2 Precision thermometer TFX 430

Features:

- high accuracy
- four-wire measuring system
- waterproof IP67
- approx. 5 years battery life
- factory calibration certificate
- different probes for different applications

Specifications

Measuring range:	-100 to +500 °C
Accuracy:	±0.05 °C (from -50 to +199.99 °C); remaining measuring range: ±0.2 °C
Resolution:	0.01 °C (from -100 to +199.99 °C); remaining measuring range: 0.1 °C
Operating temperature:	-20 to +50 °C
Storage temperature:	-30 to +70 °C
Probes:	Pt100
Measurement interval:	1 to 15 secs, adjustable
Battery:	Lithium 3V, 1Ah, Type CR2477
Deactivation:	Automatically after 2 hours, deactivatable
Dimensions:	109 x 54 x 22 mm
Weight:	approx. 90 g
IP code:	IP 67
Housing material:	ABS

Type	Description	PK	Cat. No.
TFX 430	Precision-Thermometer, without probe	1	9.908 075
TFX 430 + TPX 130	Precision-Thermometer, with Pt100 probe (length 130 mm, 3 mm diam., blunt)	1	9.908 076
TFX 430 + TPX 230	Precision-Thermometer, with Pt100 probe (length 200 mm, 3 mm diam., pointed)	1	9.908 077
TFX 430 + TPX 330	Precision-Thermometer, with Pt100 probe (length 190 mm, 8 mm diam., glass-coated)	1	9.908 078
TPX 130	Probe, Pt100, length 130mm, 3mm dia., blunt	1	6.235 806
TPX 230	Probe, Pt100, length 200 mm, 3mm diam., pointed	1	6.233 571
AX 110	Extention cable, length 1 m, silicone for TFX 430	1	6.226 725

3. Analytical measurement and testing Thermometers/Surface, Insertion thermometers-Temperature meters

1 Temperature data logger Type 15210

NEW

1

Temperature data logger with 4 channels, suitable for temperature sensors type K, J, E, T, N, R, S.

Ludwig Schneider

- Functions: °C/°F selection, min/max/AVG memory, freeze display, hi/low alarm, Bluetooth, data logger, automatic switch-off
- Display: 4 channels at the same time, date/time, backlit, battery status
- Data transfer via Bluetooth or USB

Scope of supply: Data logger, 2 x cable sensors type K with flat plug (1 m length), software, Bluetooth adapter, micro USB cable, carrying case



Specifications

- Temperature range: -200 ... +1370 °C
- Resolution: 0.1 °C (> 600 °C 1 °C)
- Accuracy: ±0.1 % (> 600 °C 0.7 °C) of measured value
- Memory: 32000 data per input
- Dimensions (L x W x H): 187 x 75 x 29 mm
- Weight: 290 g
- Power supply: 4 x 1.5 V battery UM-4 or AAA

Type	PK	Cat. No.
15210	1	6.313 339

2 Combination Infrared and Penetration Thermometer TLC 750i

ebro

2

Handy, waterproof infrared thermometer with large measurement range for non-contact measurement of the surface temperature and secure core temperature measurement with the folding penetration probe. For time-saving, precise temperature measurements at incoming goods, production and storage of diverse goods and food. Conform to HACCP and DIN EN 13485. With battery and factory calibration certificate.

- Display with backlight for reading in dark environments
- Display can be upside down for reading from both sides
- Double laser pointer

Specifications

- Measurement range: -50 to +250 °C
- Accuracy infrared: ±4 °C (-50 to -30.1 °C)
±2.5 °C (-30 to -18.1 °C)
±1.5 °C (-18 to -0.1 °C)
±1.0 °C (0 to +65 °C)
±2.0 °C or 2 % (+65 to +250 °C)
- Accuracy penetration probe: ±0.5 °C (-30 to +99 °C)
otherwise ±1 °C (1 %), larger value applies
- Resolution: 0.1 °C
- Distance : spot ratio: 8 : 1
- Sensor: Type T
- Operating temperature: -25 to +50 °C
- Dimensions (L x W x H): 169.5 x 44 x 23 mm
- Weight: approx. 140 g
- Battery: 2 x AAA (Micro), replaceable
- Deactivation: automatically after 15 sec., deactivatable
- IP code: IP 65



Type	PK	Cat. No.
TLC 750i	1	6.289 927

Thermometers/Temperature meters

1



1 Infrared thermometer, DualTemp Pro, with penetration probe

For simple, rapid, non-contact, temperature measurement.

- dual display
- wide measurement ranges:
 - infra-red: -33 to +250°C
 - conventional penetration probe: -55 to + 250°C
- measuring spot: distance ratio 2.5:1
- Max./ Min., Hold functions
- auto-off after 15 secs.
- belt-clip included
- accessories: certificate of calibration & pilot drill for taking measurements from frozen items

Resolution:	0.2°C
Accuracy (IR):	-33°C to 0°C ±1.0°C ±0.1/1°C 0°C to +65°C ±1.0°C +65°C to +200°C ±1.5%
Accuracy (penetration probe):	below -5°C ±1.0°C -5°C to +65°C ±0.5°C above +65°C ±1%
Spectral sensitivity:	6 to 14µm
Adjustable emissivity:	0.10 to 1.00
Operating temperature:	0 to 50°C
Battery:	Lithium cell CR2032
Dimensions:	24.2 x 39.8 x 156mm
Weight:	380g (incl. packaging)

Type	PK	Cat. No.
DualTemp Pro	1	9.851 023

2



2 Infrared-Thermometer Slim Flash

Non-contact temperature measurement via infrared. Response time 1 second.
Measuring range -33 to +199°C, Accuracy ±2°C or 2%, incl. CR2032 button cell.

Dostmann electronic

Type	PK	Cat. No.
Infrared-Thermometer Slim Flash	1	9.851 998

3



3 Infra-red thermometer ScanTemp 385

With IR thermometers you can measure surface temperature. A short response time and non-contact measurement are key advantages. ideal for monitoring applications such as:

- moving parts (running paper webs...)
- registering the surface temperature of gears and motors
- checking live electrical parts (components, transformers...)
- newly coated or painted parts
- food and corrosive substances

Specifications	
Temperature range:	-35°C ... 365°C
Precision:	±2% or 2 °C, the higher value counts
Response time:	< 1 sec
Spectral sensitivity:	6 ... 14µm
Operating temperature:	0 ... 50 °C
Optical resolution:	12:1
Laser:	Spot laser
Dimensions (L x W x H):	147.9 x 112.6 x 41.4mm
Weight:	150 g (incl. packaging)
Battery:	2 x 1.5V AAA Batteries

Type	PK	Cat. No.
ScanTemp 385	1	9.851 996

3. Analytical measurement and testing Thermometers/Temperature meters

1 Infra-red thermometer with double-laser sighting, ScanTemp 485

For contact-free measuring of surface temperature, highest precision due to special glass lens, with double-laser sighting.

TFA Dostmann

Specifications

Temperature range: -50 ... +800°C
 Precision: ±2 % or 2 °C, the higher value counts
 Response time: 0.5 seconds
 Dimensions (L x W x H): 42 x 85 x 152 mm
 Weight: 140 g
 Battery: 1x 9V battery included

1



Type	PK	Cat. No.
ScanTemp 485	1	6.240 840

2 Infrared Thermometers TFI 260/TFI 54

Non-contact measurement of the surface temperature with infrared. Ideal for fast and secure measurements of moving or energized parts and food. With batteries and factory calibration certificate.

ebro

Specifications:

Measurement range: -60 °C to +550 °C
 Accuracy: ±2 °C or 2 % (at 0 °C to +550 °C), whichever is larger
 Resolution: 0.1 °C
 Distance : spot ratio: 12:1
 Operating temperature: 0 °C to +50 °C
 Response time: 1 sec.
 Emissivity factor: 0.95 fixed (0.1 to 1.0 possible)
 Dimensions (L x W x H): 153 x 115 x 48 mm (TFI 260)
 144 x 117 x 43 mm (TFI 54)
 Weight (with batteries): 177 g (TFI 260), 180 g (TFI 54)
 Battery: 2 x 1.5 V AAA, replaceable
 IP code: IP 20 (TFI 260), IP 54 (TFI 54)

2



Type	Description	PK	Cat. No.
TFI 260	Infrared thermometer	1	6.272 762
TFI 54	Splash water proof infrared thermometer	1	9.908 032

3 Infra-red thermometers, testo 830-T1



Infrared thermometer for non-contact measurement of surface temperatures. Laser measurement point marker and large optics for exact measurement even at medium distances.

Testo

- Fast recording of measurement values at 2 measurements per second
- Adjustable emissivity
- 2 adjustable alarm limit values
- Hold function and display of min./max. values

Scope of supply: Thermometer, batteries, works calibration certificate

Specifications

Measuring range: -30 ... +400 °C
 Accuracy: ±1.5 °C or 1.5 % of measured value (+0.1 ... +400 °C)
 ±2 °C or ±2 % of measured value (-30 ... 0 °C)
 larger value counts
 Resolution: 0.1 °C
 Measuring spot marking: 1-point-laser
 Distance to measured spot: 10:1
 Dimensions (W x D x H): 38 x 75 x 190 mm
 Weight: 200 g
 Power supply: 9 V block batterie

3



Type	PK	Cat. No.
testo 830-T1	1	9.718 418

1



1 Disposable data logger TempMate-S1

Dostmann electronic

The single-use data logger TempMate-S1 with its built-in USB connector, is the ideal solution for low-cost temperature monitoring of transports. TempMate-PDF loggers directly useable with pre-programmed configuration or reprogrammable with Tempbase Software according to each customer's specifications. To download the recorded data, simply connect TempMate-S1 directly to the USB port. A PDF and CSV report will automatically be generated, covering temperature graph, detailed data list and statistical information. No hardware (cable, interface) or software is required.

- Auto generating PDF and CSV format data report
- 110 days run time 16.000 measurements, 10 minuteinterval
- Reprogrammable with Tempbase Software free of charge
- Up to 5 alarm points configurable
- Integrated USB connector
- LED Alarm indicators
- Serial number sticker
- Inclusive certificate
- Food proof according to HACCP

Specifications

Temperature Range:	-30 ... 70 °C
Accuracy:	±0.5 °C at -20 ... +40 °C/±1.0 °C in remaining range
Resolution:	0.1 °C
Data Memory:	16.000 measurements
Recording Cycle:	110 days
Sampling Interval:	10 min
Shelf Life:	24 months
Dimensions (L x W x H):	80 x 47 x 7 mm
Weight:	14.6 g
IP code:	IP 67/NEMA 6
Certifications:	Calibration Certificate, EN 12830 S, T, C, D, 1

Type	PK	Cat. No.
TempMate-S1	1	6.285 049

2



2 Data Logger LOG32T

Dostmann electronic

The LOG32T is perfectly designed for product transportation or storage applications. Ambient conditions in power plants.

- Memory size: 60 000 measurements
- Usable without software (default settings) (15-minute-interval, without alarm settings)
- Optional free of charge software download for alarm setting and free adjustable recording interval (30sec to 24h)
- Automatic PDF creation
- Battery lifetime > 3 years (recording interval >15 minutes)
- Status and Alarm-LEDs, acoustic signal
- Includes wall mount
- HACCP (EN12830) conform
- IP65 watertight

Specifications

Measuring range:	-40 ... +70°C
Accuracy:	±0.5°C (-10 ... +40°C), otherwise ±1.0°C
Resolution:	0.1°C
Memory:	60 000 measurements
Interface:	USB (integr.)
Housing:	ABS
Dimensions (L x W x H):	100 x 19 x 19mm
Weight:	70g
Battery:	1 x 3.6 Volt Lithium ½ AA

Type	PK	Cat. No.
LOG32T	1	9.726 431

Data Logger EBI 20-T1/EBI 20-TE1

Applications:

- transport
- storage monitoring
- refrigeration areas and coldrooms

Features:

- waterproof
- visual Alarm
- max/min values on display
- stores 40.000 readings, can be read off at any time
- replaceable battery

Scope of supply:

EBI 20-T1: Temperature Logger

EBI 20-T1-Set: Temperature Logger, evaluation software, Interface

EBI 20-TE1: Temperature Logger with external probe

EBI 20-TE1-Set: Temperature Logger with external sensor, evaluation software, Interface

Specifications

Measuring range temperature:	-30 to +70 °C
Accuracy, temperature:	±0.5 °C (-20 to +40 °C); ±0.8 °C for remaining measuring range
Resolution temperature:	0.1 °C
Memory:	40.000 samples
Sensor:	NTC
Operating temperature:	-30 to +70 °C
Storage temperature:	-40 to +70 °C
Measuring period:	1 minute to 24 hours
Measuring mode:	immediate loop measurement, measurement from starting point, start immediately until memory full, start/stop measuring, start when button pressed
Battery:	3V lithium (CR 2450), can be replaced by user
IP code:	IP 67
Housing:	ABS
Dimensions:	69 x 48 x 22 mm
Weight:	approx. 45 g

Type	PK	Cat. No.
EBI 20-T1	1	9.908 069 1
EBI 20-T1-Set	1	9.908 073
EBI 20-TE1	1	6.228 382
EBI 20-TE1-Set	1	6.240 382 2

1

ebro



9.908 069

2



6.240 382

3 Temperature data logger LOG200

- Memory size: 150.000 measurements
- Usable without software (default settings) (15-minute-interval, without alarm settings)
- Automatic PDF creation
- Free adjustable recording interval: 10 seconds to 24 hours
- Max-Min-Display memory (resettable)
- Time marking functions for measuring results
- Movement sensor for shock recording e.g.: door or windows closing
- Battery lifetime approx. 4 years (recording interval >15 minutes)
- Includes wall mount
- Status- and Alarm-LEDs
- HACCP conformity according EN 12830

Dostmann electronic

Free software LogConnect, for configuring (alarms, interval, changing display settings) or LogGraph2 for comfortable graphical and tabular display of measured values, incl. drag and zoom. Software is available as download.

Specifications

Measuring range:	-40 to +70 °C
Accuracy:	0.1 °C
Precision:	±0.5 °C (-20 to +50 °C), otherwise ±1.0 °C
Interface:	USB (integr.)
Housing:	Plastic (ABS)
Battery:	1 x 3.6 Volt Lithium 1/2 AA
Dimensions:	91.5 x 42 x 20 mm
Weight:	approx. 70 g

Type	PK	Cat. No.
LOG200	1	6.284 757

3



Thermometers/Temperature data logger

1



7.626 604

Mini data logger testo 174T

The mini data logger for temperature, testo 174T, is ideal for accompanying transports. Simply positioned close to the goods, e. g. in containers and refrigerated rooms, the data logger monitors temperature continuously, securely and unobtrusively. The free software ComSoft testo 174 allows fast programming of the data logger and easy analysis.

Testo

- High data integrity, even with empty battery
- Large measurement data memory
- Watertight in accordance with IP65
- Compact and robust
- Conforms to EN12830
- Issue of alarms via display
- Data transfer to the PC via USB interface
- Reliable temperature measurement for the monitoring of sensitive goods and cold chain during storage and transport

testo 174T: Mini data logger, 1-channel, incl. wall bracket, battery (2 x CR 2032 Lithium) and calibration protocol.

testo 174T-Set: Mini data logger, 1-channel, incl. USB interface for programming and reading out the logger, wall bracket, battery (2 x CR 2032 lithium) and calibration protocol.

Specification

Probe type:	Internal NTC temperature sensor
Measuring range:	-30 to +70°C
Accuracy:	±0.5°C
Resolution:	0.1°C
Operating temperature:	-30 to +70°C
Storage temperature:	-40 to +70°C
Battery type:	2 x 3V button cell (2 x CR 2032 lithium), can be changed by user
Battery life:	500 days (15 min measuring cycle, +25°C)
Protection class:	IP65
Meas. cycle:	1min - 24h (can be selected)
Memory:	16.000 readings
Software:	can be used with Windows XP, Vista, Win7

Type	PK	Cat. No.
testo 174T	1	7.626 604 1
testo 174T-Set	1	7.626 614

2



2 Temperature logger LOG200E



Data logger with motion sensor, integrated USB interface for automatic PDF output and wall mount. For internal temperature measurement and recording. With connection for an external PT100 temperature sensor.

Dostmann electronic

- Freely adjustable recording interval from 10 seconds to 24 hours
- Min- and Max-values can be reset in the display
- Time marking function ("Time Marker") during data recording
- With movement sensor for shock recording
- Memory for approx. 60000 measurements
- Automatic output as PDF file, device can also be used without software
- No driver installation needed
- Status and alarm LEDs, with buzzer
- Display can be switched off
- Battery life > 4 years at > 15 min measuring interval
- Software available for download on the manufacturer's website (free of charge)

Temperature sensors are available as accessory.

Scope of supply: Data logger, wall mount, battery, USB cover, screws and dowels

Specifications

Temperature range internal:	-40 ... 70 °C
Temperature accuracy internal:	±0.4 °C (-10 ... 40 °C), otherwise ±1 °C
Temperature range external:	-200 ... 850 °C
Temperature accuracy external:	±0.2 °C or 0.3 % (the greater value applies)
Temperature resolution:	0.1 °C
Housing:	ABS
Dimensions (W x D x H):	42 x 20 x 91.5 mm
Weight:	70 g
Power supply:	1/2 AA 3.6 V

Type	PK	Cat. No.
LOG200E	1	6.311 945

Standard PDF Data Logger EBI 300

ebro

PDF data logger with different temperature sensors.

- For temperature monitoring related to HACCP/IFS issues or other perishable goods
- Transportation of fresh, cool and deep cool products
- Monitoring of fridges and deep freezers
- Evaluation without software, PDF are automatically generated
- Minimise training, user errors and IT costs using EBI 300's simple, easy to use design and standard software.
- Ensure data integrity since no data manipulation is possible
- EN 12830, ATP, VO(EG) 37/2005 Compliant
- Factory calibration certificate included
- Programmable via the free online configurator at www.ebi300.com
- No separate interface for programming and reading

EBI 300: PDF data logger with internal temperature sensor

EBI 300 TE: PDF data logger with external temperature sensor, internal temperature sensor can be used additionally.

EBI 300 TH: PDF data logger with external humidity and temperature sensor, internal temperature sensor can also be used.

Specifications

Ambient Temperature:	-30 to +70 °C
Measuring range Temp. EBI 300/300 TH:	-30 to +70 °C
Measuring range Temp. EBI 300 TE:	-35 to +70 °C
Measuring range Humidity EBI 300 TH:	0 to 100 % r.F.
Accuracy Temperature:	±0.5 °C (-20 to +40 °C), ±0.8 °C for remaining range
Accuracy Humidity:	±3 % (10 to 90 % rh), ±5 % for remaining range
Resolution Temperature/Humidity:	0.1°C/0.1 % rh
Memory:	40.000 samples
Sensor:	NTC for temperature
Battery life time:	up to two years
Measuring period:	1 minute to 24 hours
Maximum Start Delay:	72 h
Housing material:	Polycarbonate
Measuring modes:	Start/Stop, endless loop, start with button
Alarms:	2 values, high and low limits
Weight:	35 g
IP code:	IP 65

1



7.655 865

2



6.266 910

3



6.266 911

Type	PK	Cat. No.
EBI 300	1	7.655 865 1
EBI 300 TH	1	6.266 910 2
EBI 300 TE	1	6.266 911 3



Thermometers/Temperature data logger

1



9.908 098

High Precision PDF Data Logger EBI 310

PDF data logger with different temperature sensors. Compared to the EBI 300, the EBI 310 is characterized by shorter measuring intervals and higher storage capacity.

ebro

- Automatic pdf-report creation with temperature/time values
- Transport of drugs, inoculants, blood products and primary products
- Transport of all temperature sensitive products
- Storage of reference samples in refrigerators and deep-freezers
- "Traffic light principle" by limit exceeded
- IQ/OQ procedures through standardized software and standard reporting process possible
- GMP, pharmaceutical law compliant; EN 12830, ATP, VO (EG) 37/205 compliant, 21 CFR Part 11 conform (Winlog.basic)
- Programmable via the free online configurator at www.ebi300.com

EBI 310: Data logger with internal temperature sensor

EBI 310 TE: Data logger with external precision temperature sensor, internal temperature sensor can be used additionally. Measurements in high and low temperature range

EBI 310 TH: Data logger with external humidity and temperature sensor, internal temperature sensor can be used additionally. Monitoring the relative humidity in storage and transport

EBI 310 DI: Data logger with external precision temperature sensor, internal temperature sensor can be used additionally. Precise temperature measurement for dry ice and freezers. Logger also works in dry ice.

EBI 310 TX: Data logger with temperature dual adapter for two exchangeable temperature sensors (not included in the scope of supply), internal temperature sensor can be used additionally.

Specifications

Ambient Temperature:	-30 to +75 °C
Measuring range Temp. EBI 310/310 TH:	-30 to +75 °C
Measuring range Temp. EBI 310 TE:	-200 to +250 °C
Measuring range Humidity EBI 310 TH:	0 to 100 % rh
Accuracy Temperature:	±0.2 °C (-30 to +30 °C); ±0.5 °C for remaining range
Accuracy Humidity EBI 310 TH:	±3 % (10 to 90 % rh)
Resolution Temperature/Humidity:	0.1 °C/0.1 % rh
Memory Capacity:	120.000 measurements
Sensor:	Pt1000/NTC
Battery life time:	up to two years
Measuring period:	1 s to 24 h
Maximum Start Delay:	72 h
Housing material:	Polycarbonate
Measuring modes:	Start/Stop, endless loop, start with button
Alarms:	5 values
Weight:	35 g
IP code:	IP 65

Type	PK	Cat. No.
EBI 310	1	9.908 098 1
EBI 310 TE	1	6.266 913
EBI 310 TH	1	6.266 912
EBI 310 DI	1	6.282 436
EBI 310 TX	1	7.643 731

2



9.908 017

3



6.281 570

Accessories for PDF Data Logger EBI 300/EBI 310

ebro

Type	Description	PK	Cat. No.
EBI 300-WM2	Wall Bracket	1	9.908 017 2
EBI 300 WM3	Wall Bracket, stainless steel	1	6.281 570 3
TPC 300	Replacement probe for EBI 300 TE	1	9.908 027
TPX 220	Replacement probe for EBI 310 TE	1	9.908 099
TPX 250	Replacement probe for EBI 310 DI	1	9.908 100
TPH 500	Replacement probe for EBI 310 TH	1	6.263 842
AH 300	Stainless Steel-Sinter-Filter	1	6.281 569

Wireless temperature data loggers EBI 25-T/TE

Wireless temperature data loggers for storage rooms and refrigerated cabinets.

ebro

- Readout via wireless interface
- Replaceable battery
- High protection class IP67
- LCD display
- Memory for 288 values

EBI 25-T: with internal NTC temperature sensor

EBI 25-TE: with external NTC temperature sensor

The IF 400 base station and the Winlog.web/Winlog.wave PC software (see "Accessories for EBI 25 data loggers) are required for programming and evaluating the EBI 25-T/TE data loggers.

Scope of delivery: temperature data logger, operating manual

Specifications

Sensor:	NTC
Channels:	1
Measuring cycle:	1 min. ... 24 Hrs. user definable
Measuring range EBI 25-T:	-30 ... 60 °C
Measuring range EBI 25-TE:	-40 ... 85 °C
Accuracy EBI 25-T (±1 digit):	±0.5 °C (-20 ... 40 °C) ±0.8 °C (40.1 ... 60 °C)
Accuracy EBI 25-TE (±1 digit):	±0.5 °C (-20 °C ... 40 °C) ±0.8 °C (-30 °C ... -20 °C; 40 °C ... 60 °C) ±1.5 °C (-40 °C ... -30 °C; 60 °C ... 85 °C)
Resolution:	0.1 °C
IP code:	IP 67
Battery life:	approx. 2 years
Operation and storage temperature:	-30 ... 60 °C/-40 ... 85 °C
Dimensions (W x D x H):	48 x 27 x 95 mm
Power supply:	1 x Lithium battery 3.6 V, replaceable

1



6.252 642

Type	Description	PK	Cat. No.
EBI 25-T	with internal temperature sensor	1	6.252 642 1
EBI 25-TE	with external temperature sensor	1	6.252 678

Temperature data logger testo 175 T3

Temperature data logger with 2 connections for external temperature sensors, e.g. immersion sensor, surface or air sensor. Data is stored even if the battery is changed or empty.

Testo

- Suitable for rough environmental conditions
- Protected against splashing and jetting water
- With the appropriate temperature sensors, temperatures from -50 to 1000 °C can be measured and recorded
- Memory for 1 million values
- With easy-to-read LCD display
- Battery life up to 3 years
- With Mini USB connection and SD card slot
- Software for reading out the values is available as free download on the manufacturer's website

Scope of delivery: Temperature data logger with 2 connections for external temperature sensors type T and type K, flexible immersion probe type K, wall bracket, lock, batteries and calibration protocol.

Specifications

Channels:	2 x external
Measurement cycle:	10 sec. ... 24 Hrs. user definable
Measuring range:	-50 ... 1000 °C
Accuracy ±1 digit:	±0.5 °C (-50 ... 70 °C) ±0.7 % (+70.1 ... 1000 °C)
Resolution:	0.1 °C
Protection class:	IP65
Battery life:	3 years
Operation and storage temperature:	-20 ... 55 °C
Dimensions (W x D x H):	55 x 30 x 95 mm
Power supply:	3 x AAA

2



6.243 831

Type	Description	PK	Cat. No.
testo 175 T3	Device only	1	6.243 831 2
testo 175 T3	testo 175 T3 incl. flexible immersion probe, type K	1	6.268 630

1



1 Wireless temperature data logger EBI 25-TX

Wireless temperature data logger for low temperatures. With external temperature sensor.

ebro

- Measuring range down to -200 °C
- External temperature sensor with 3 m cable
- Readout via wireless interface
- Replaceable battery
- High protection class IP67
- LCD display
- Memory for 288 values

The IF 400 base station and the Winlog.web/Winlog.wave PC software (see "Accessories for EBI 25 data loggers) are required for programming and evaluating the EBI 25-TX data logger.

Scope of delivery: temperature data logger, operating manual

Specifications

Sensor:	PT1000, Binder series 620
Channels:	1
Measuring cycle:	1 min. ... 24 Hrs. user defineable
Measuring range:	-200 ... 199.9 °C
Accuracy (±1 digit):	±2.0 °C (-200 °C ... -100 °C) ±0.5 °C (-100 °C ... -20 °C) ±0.2 °C (-20 °C ... 60 °C) ±0.5 °C (60 °C ... 199.9 °C)
Resolution:	0.1 °C
IP code:	IP 67
Battery life:	approx. 2 years
Operation and storage temperature:	-30 ... 60 °C/-40 ... 85 °C
Dimensions (W x D x H):	48 x 27 x 95 mm
Power supply:	1 x Lithium battery 3.6 V, replaceable

Type	Description	PK	Cat. No.
EBI 25-TX	With external temperature sensor	1	7.659 065

2



2 Temperature/Humidity logger LOG32TH

TFA Dostmann

- Memory size: 60 000 measurements
- Usable without software, 5-minute-interval default setting
- With free software, free adjustable recording interval: 30 seconds to 24 hours
- Automatic PDF creation (no drivers required)
- Battery lifetime >2 years (recording interval >5 minutes)
- Status and Alarm-LEDs
- Includes wall mount

Application profile:

The LOG 32TH is perfectly designed for product transportation or storage applications.

- Quality surveillance in laboratories during production in storage areas
- Monitoring conditions in manufacturing facilities
- Maintaining product storage according to HACCP
- Ambient conditions in power plants
- Monitoring of fridges for the pharmaceutical industry

Specifications

Measuring range:	-40 to +70°C
Accuracy:	0.1°C
Precision:	±0.5°C (-10 to +40°C), otherwise ±1.0°C
Measuring range:	0 to 100%R.H.
Resolution:	0.1% R.H.
Accuracy:	±3% R.H. (40 to 60%), ±3.5% R.H. (20 to 40% and 60 to 80%), otherwise ±5% R.H.
Interface:	USB (integr.)
Housing:	Plastic (ABS)
Battery:	1 x 3.6V ½ AA Lithium
Dimensions:	100 x 19 x 19mm
Weight:	70g

Type	PK	Cat. No.
LOG32TH	1	9.726 422

1 Temperature/Humidity data logger LOG 210

Dostmann electronic

1



- PDF-data logger with display
- Memory size: 100.000 measurements
- Usable without software (default settings) (5-minute-interval, without alarm settings)
- Automatic PDF creation
- Movement sensor for shock recording e.g.: door or windows closing
- Free adjustable recording interval: 10 seconds to 24 hours
- Max-Min-Display memory (resettable)
- Time marking functions for measuring results
- Battery lifetime approx. 4 years (recording interval >15 minutes)
- Status- and Alarm-LEDs
- Includes wall mount

Free software LogConnect, for configuring (alarms, interval, changing display settings) or LogGraph2 for comfortable graphical and tabular display of measured values, incl. drag and zoom. Software is available as download.

Specifications

Temperature

- Measuring range: -40 to +70 °C
- Accuracy: 0.1 °C
- Precision: ±0.5 °C (0 to +60 °C), otherwise ±1.0 °C

Humidity

- Measuring range: 0 to 100 % R.H.
- Resolution: 0.1% R.H.
- Accuracy: ±3 % R.H. (40 to 60 %), ±3.5 % R.H. (20 to 40 % and 60 to 80 %), otherwise ±5 % R.H.
- Interface: USB (integr.)
- Housing: Plastic (ABS)
- Battery: 1 x 3.6 Volt Lithium ½ AA
- Dimensions: 91.5 x 42 x 20 mm
- Weight: approx. 70 g

Type	PK	Cat. No.
LOG210	1	6.284 758

2 Temperature and humidity logger LOG210 TC

NEW

2

Dostmann electronic



Data logger with motion sensor, integrated USB interface for automatic PDF output and wall mount. For measurement and recording of temperature and humidity and 2 connections for external type K thermocouples.

- Freely adjustable recording interval from 10 seconds to 24 hours
- Min- and Max-values can be reset in the display
- Time marking function ("Time Marker") during data recording
- With movement sensor for shock recording
- Memory for approx. 60000 measurements
- Automatic output as PDF file, device can also be used without software
- No driver installation needed
- Status and alarm LEDs, with buzzer
- Display can be switched off
- Battery life > 4 years at > 15 min measuring interval (free of charge)
- USB interface for data transfer
- Software available for download on the manufacturer's website

Temperature and humidity sensors are available separately.

Scope of supply: Data logger, 2 thermocouples type K (1 m length), wall mount, battery, USB cover, screws and dowels

Specifications

- Temperature range internal: -40 ... 70 °C
- Temperature accuracy internal: ±0.5 °C (0 ... 60 °C), otherwise ±1 °C
- Temperature range external: -150 ... 1370 °C
- Temperature accuracy external: ±0.5 °C or 0.5 % (the greater value applies)
- Temperature resolution: 0.1 °C
- Humidity range: 0 ... 100 % r.H.
- Humidity accuracy: ±3 % r.H. (40 ... 60 % r.H.), ±3.5 % r.H., (20 ... 40 and 60 ... 80 % r.H.), otherwise ±5 % r.H.
- Humidity resolution: 0.1 % r.H.
- Housing: ABS
- Dimensions (W x D x H): 42 x 20 x 91.5 mm
- Weight: 70 g
- Power supply: 1/2 AA 3.6 V

Type	PK	Cat. No.
LOG210 TC	1	6.311 944

Thermometers/Temperature-Humidity logger

1



9.908 070

Temperature/Humidity data logger EBI 20-TH1

Applications:

- reliable temperature and temperature/humidity recording
- transport
- storage monitoring
- refrigeration areas and coldrooms

Features:

- excellent price/performance ratio
- visual Alarm
- max/min values on display
- stores 40.000 readings, can be read off at any time
- replaceable battery

ebro

Specifications

Measuring range temperature:	-30 to +70°C
Measuring range humidity:	0% to 100% R.H.
Accuracy, temperature:	±0.5°C (-20 to +40°C); ±0.8°C for remaining measuring range
Accuracy, humidity:	±3% R.H. (10 to 90% R.H.)
Resolution temperature:	0.1°C
Resolution humidity:	0.1% R.H.
Memory:	40.000 samples
Sensor:	NTC for temperature/capacitive for humidity
Measuring period:	1 minute to 24 hours
Measuring mode:	immediate loop measurement, measurement from starting point, start immediately until memory full, start/stop measuring, start when button pressed
Battery:	3V lithium (CR 2450), can be replaced by user
IP code:	IP 52
Housing:	ABS
Dimensions:	69mm x 48mm x 22mm

Type	PK	Cat. No.
EBI 20-TH1	1	9.908 070 1
EBI 20-TH1-Set	1	9.908 074

2



6.239 884

Temperature/Humidity data logger testo 174 H

The mini data logger for temperature and humidity, testo 174 H, is ideal for monitoring temperature and humidity sensitive goods in storage. The testo 174 H also monitors building climate, continuously, securely and unobtrusively. The free software ComSoft basic allows fast programming of the data logger and easy analysis.

Testo

- Humidity sensor with long-term stability
- High data integrity, even with empty battery
- Display of the current temperature or humidity value
- Issue of alarms via display
- Data transfer to the PC via USB interface

testo 174H: Mini data logger, 2-channel, incl. wall bracket, battery (2 x CR 2032 lithium) and calibration protocol.

testo 174H-Set: Mini data logger, 2-channel, incl. USB-interface for programming and reading out the logger, wall bracket, battery (2 x CR 2032 lithium) and calibration protocol.

Specification

Probe type:	NTC temperature sensor and internal capacitive humidity sensor
Measuring range:	0 to 100% RH, -20 to +70°C
Accuracy:	±0.5°C, ±3% RH
Resolution:	0.1% RH, 0.1°C
Operating temperature:	-20 to +70°C
Storage temperature:	-40 to +70°C
Battery type:	2 x CR 2032 lithium
Battery life:	1 year (15 min measuring cycle, +25°C)
Protection class:	IP20
Meas. cycle:	1min to 24h (can be selected)
Memory:	16000 readings
Software:	ComSoft basic (Windows)

Type	PK	Cat. No.
testo 174H	1	6.239 884 2
testo 174H-Set	1	6.239 883

1 Temperature/Humidity data logger LOG 110

Large display for actual value, battery status display, easy to use software. Perfect designed instrument for transportation or storage.

Dostmann electronic

- quality surveillance in laboratories, at the production or in the storage
- ambient conditions in manufacturing facilities
- monitoring from storages after HACCP
- ambient conditions in power plants
- monitoring of fridges for the pharma industry
- memory for 60 000 data sets

Please order Software with USB-Cabel separately (9.726 413)

Specifications

Temperature

Measuring range: -30 to +70 °C
 Accuracy: 0.1 °C
 Precision: ±0.5 °C (0 to +40 °C), otherwise ±0.7 °C

Humidity

Measuring range: 0 to 99 % R.H.
 Resolution: 0.1% R.H.
 Accuracy: ±3 % R.H.
 Housing: Plastic (ABS)
 Battery: 1 x CR2032 3 V
 Dimensions: 92 x 55 x 21mm
 Weight: 95 g (incl. packaging)
 Alarm function: Alarm for too low or too high temperature and/or humidity values
 Calibration reminder

1



Type	PK	Cat. No.
LOG 110	1	9.726 412

2 Wireless temperature data logger EBI 25-TH

Wireless temperature and humidity data logger. With internal temperature sensor and external humidity sensor.

ebro

- Readout via wireless interface
- Replaceable battery
- LCD display
- Memory for 288 values per channel

The IF 400 base station and the Winlog.web/Winlog.wave PC software (see "Accessories for EBI 25 data loggers") are required for programming and evaluating the EBI 25TH data logger.

Scope of delivery: temperature and humidity data logger, operating manual

Specifications

Sensors: Temperature: NTC/Humidity: capacitive
 Channels: 1 x internal, 1 x external
 Measuring cycle: 1 min ... 24 Hrs..
 Temperature measuring range: -30 ... 60 °C
 Humidity measuring range: 0 ... 100 % r.H.
 Temperature accuracy (±1 digit): ±0.5 °C (-20 °C ... 40 °C)
 ±0.8 °C (40.1 ... 60 °C)
 Humidity accuracy (±1 digit): ±3 %
 Temperature resolution: 0.1 °C
 Humidity resolution: 0.1 % r.H.
 IP code: IP 20
 Battery life: approx. 2 years
 Operation and storage temperature: -30 ... 60 °C/-40 ... 85 °C
 Dimensions (W x D x H): 48 x 27 x 95 mm
 Power supply: 1 x Lithium battery 3.6 V, replaceable

2



Type	PK	Cat. No.
EBI 25-TH	1	7.656 516

Thermometers/Temperature-Humidity logger

1



1 Temperature/Humidity/Pressure data logger LOG 220

Dostmann electronic

- PDF-data logger with display
- Memory size: 60.000 measurements
- Usable without software (default settings) (5-minute-interval, without alarm settings)
- Automatic PDF creation
- Free adjustable recording interval (10 seconds to 24 hours)
- Max-Min-Display memory (resettable)
- Time marking functions for measuring results
- Movement sensor for shock recording e.g.: door or windows closing
- Battery lifetime approx. 4 years (recording interval >15 minutes)
- Includes wall mount
- Status- and Alarm-LEDs

Free software LogConnect, for configuring (alarms, interval, changing display settings) or LogGraph2 for comfortable graphical and tabular display of measured values, incl. drag and zoom. Software is available as download.

Specifications

Temperature

Measuring range: -40 to +70 °C
 Accuracy: 0.1 °C
 Precision: ±0.5 °C (0 to +60 °C), otherwise ±1.0 °C

Humidity

Measuring range: 0 to 100 % R.H.
 Accuracy: 0.1% R.H.
 Resolution: ±3 % R.H. (40 to 60 %), ±3.5 % R.H. (20 to 40 % and 60 to 80 %), otherwise ±5 % R.H.

Pressure

Measuring range: 300 to 1100 hPa
 Accuracy: 0.1 hPa
 Precision: ±1 hPa (900 to 1100 hPa), otherwise 0.5 % of end value
 Interface: USB (integr.)
 Housing: Plastic (ABS)
 Power supply: 1 x 3.6 Volt Lithium ½ AA
 Dimensions: 91.5 x 42 x 20 mm
 Weight: approx. 60 g

Type	PK	Cat. No.
LOG220	1	6.284 759

2



2 Data logger LOG32THP

Dostmann electronic

- Temperature-humidity-pressure logger with integrated USB-interface and automatic PDF-creation, inclusive wall mount.
- Memory for 3 x 60.000 measurements
 - Useable without software (default settings with 5 minuteintervals)
 - Automatic PDF creation (no drivers required), optional software download
 - Free adjustable recording interval 30 seconds up to 24 hours (via Software Log Connect)
 - Battery lifetime > 2 years (recording interval >15 minutes)
 - Statusand alarm-LEDs, includes wall mount

Specifications

Measuring range: -40 ... +70 °C, 0 ... 99 %rh, 300 ... 1100 hPa
 Accuracy: ±0.5 °C (-10 ... 40 °C) ±3 % (40 ... 60 % rh), ±1 hPa (900 ... 1100 hPa)
 otherwise 0.5 %
 Resolution: 0.1 °C/0.1 %rh/0.1 hPa
 Memory: 3x 60 000 measurements
 Interface: USB (intergr.)
 Housing: ABS
 Dimensions (L x W x H): 102 x 20 x 21 mm
 Weight: 70 g
 Battery: 1x 3.6 V lithium 1/2 AA

Type	PK	Cat. No.
LOG32THP	1	7.971 350

1 Temperature, humidity, pressure and CO₂ logger LOG220E

NEW

1

Data logger for temperature, humidity and pressure recording with an external connection for a CO₂ sensor or humidity, pressure and temperature sensor. Incl. wall mount.

Dostmann electronic

- Freely adjustable recording interval from 10 seconds to 24 hours
- Min- and Max-values can be reset in the display
- Time marking function ("Time Marker") during data recording
- With movement sensor for shock recording
- Memory for approx. 60000 measurements
- Automatic output as PDF file, device can also be used without software
- No driver installation needed
- Status and alarm LEDs, with buzzer
- Display can be switched off
- Battery life > 4 years at > 15 min measuring interval
- USB interface for data transfer
- Software available for download on the manufacturer's website (free of charge)

Temperature, pressure humidity and CO₂ sensors are available separately.

Scope of supply: Data logger, wall mount, battery, USB cover, screws and dowels



Specifications

Temperature range internal:	-40 ... 70 °C
Temperature accuracy internal:	±0.5 °C (0 ... 60 °C), otherwise ±1 °C
Temperature range external:	-200 ... 850 °C
Temperature accuracy external:	±0.2 °C or 0.3 % (the greater value applies)
Temperature resolution:	0.1 °C
Humidity range:	0 ... 100 % r.H.
Humidity accuracy:	±3% r.H. (40 ... 60 % r.H.), ±3.5 % r.H. (20 ... 40 % and 60 ... 80 % r.H.), otherwise ±5 % r.H.
Humidity resolution:	0.1 %
Pressure range:	300 ... 1100 hPa
Pressure accuracy:	±1 hPa (900 ... 1100 hPa), otherwise 0.5 % of end value
Pressure resolution:	0.1 hPa
Housing:	ABS
Dimensions (W x D x H):	42 x 20 x 91.5 mm
Weight:	70 g
Power supply:	1/2 AA 3.6 V

Type	PK	Cat. No.
LOG220E	1	6.311 947

We can **supply** this
manufacturer's
whole
product range !



DOSTMANN electronic GmbH

Timing/Timers

1



1 LLG-Short period timer with alarm

Easy-to-use combination timer and stopwatch, with large display and alarm function from/up to 99 min. and 59 sec. With magnet for easy fixing. Battery LR 44 inclusive.

Dimensions (Ø x H): 54 x 16.5mm
Weight: approx.40g

Type	PK	Cat. No.
LLG-Short period timer with alarm	1	9.260 150

2



2 LLG-Timer Cube

With 4 pre-set countdown times. Place the cube with the desired time facing up and the counting down starts immediately.

- Pulsing LED when timer is counting
- Automatically rotating flip display shows the remaining time
- After expiration, the elapsed time is displayed until the alarm ends
- Optional pre-alarm shortly before time expires

Dimensions (W x H x D): 60 x 60 x 60 mm
Weight: 58 g
Power supply: 2 x 1.5 V AAA (not incl.)

Type	PK	Cat. No.
5-15-30-60 minutes	1	6.291 217

3



3 LLG-Timer pro

NEW

The LLG-Timer pro can be used simultaneously as real time clock and timer. The countdown timer also runs when time is visible.

- Big 6-digit LCD display
- Digital stopwatch (counting up)
- Short timer (counting down)
- With memory function
- Stopwatch and countdown up to 23 h 59 min. 59 sec.
- Optical and acoustic alarm when timer expires
- Incl. magnet for mounting, hanging bracket and stand (fold-out)

Dimensions (W x H x D): 82 x 68 x 20.5 mm
Weight (with battery): 82 g
Power supply: 2 x AAA 1.5 V (not included)
Warranty: 12 months

Type	PK	Cat. No.
LLG-timer pro	1	6.311 351

4



4 LLG-Dual-Timer, 2-channel

NEW

The LLG-Dual-Timer offers two separate timers in one instrument. One fixed time can be stored per channel.

- Big 6-digit LCD display
- Digital stopwatch (counting up)
- Short timer (counting down)
- With memory function
- Stopwatch with tenths of a second
- Stopwatch and countdown up to 99 h 59 min. 59 sec
- Optical (red LED) and acoustic alarm (2 volume levels), when timer expires
- Incl. magnet for mounting, hanging bracket and stand (fold-out)

Dimensions (W x H x D): 97 x 79 x 21 mm
Weight (with battery): 95 g
Power supply: 2 x AAA 1.5 V (not included)
Warranty: 12 months

Type	PK	Cat. No.
LLG-Dual-Timer	1	6.311 350

1 LLG-Timer Triple pro



The **LLG-Timer Triple pro** offers three separate timers in one instrument. One time can be stored per channel. This Timer can be used simultaneously as real time clock and timer. The countdown timer also runs when time is visible.

- Big 6-digit LCD display
- Digital stopwatch (counting up)
- Short timer (counting down)
- With memory function
- Stopwatch and countdown up to 23 h 59 min. 59 sec.
- Optical and acoustic alarm when timer expires
- Incl. magnet for mounting, hanging bracket and stand (fold-out)

Dimensions (W x H x D): 68 x 88.7 x 16.2 mm
 Weight (with battery): 87 g
 Power supply: 2 x AAA 1.5 V (not included)
 Warranty: 12 months

Type	PK	Cat. No.
LLG-Timer Triple pro	1	6.313 417

1



2 LLG-Timer with Triple Alarms, 1-channel

Choice of vibration, sound and/or light alarms makes this timer perfect for high noise locations.

- Vibration, light and loud buzzer sound alarms can function at one time, or be independently turned off
- Maximum run time: 19 hours: 59 minutes/99 minutes: 59 seconds;
- Timer accuracy: ±7 seconds/day
- Count direction: up/down; displays elapsed time after countdown
- Last time set memory
- Key press confirmation feature gives an audible indication of data entry
- Lay it flat on a bench, use the flip-open stand for a vertical view, carry it on a lab coat with the convenient pocket clip, or use the magnetic back for metal surface attachment
- Requires two AAA batteries (included)
- Individually tested, inspected, and calibrated using NIST
- Includes Certificate of Calibration with unique report number, stated corrections and standard used for the calibration, and multi-language instructions (English, French, German, Italian, Portuguese and Spanish)

Dimensions (W x H x D): 45 x 75 x 20 mm (without clip portion)

Type	PK	Cat. No.
LLG Timer with Triple Alarms, 1-channel	1	6.266 707

2



3 LLG-Timer with White Board, 4 channel

This four-channel timer has a built-in white board that helps keeping track of time and other critical information.

- Audible alarm for each channel
- Built-in white board and dry erase marker with eraser tip (included) helps keep track of crucial information
- Programs: hours/minutes; Displays: hours/minutes/seconds
- Maximum run time: 23 hours: 59 minutes
- Timer accuracy: ±5 seconds/day
- Count direction: up/down; displays elapsed time after countdown
- Last time set memory
- Key-press confirmation feature gives an audible indication of data entry
- Lay flat on a bench, use the flip-open stand for a vertical view, or use the magnetic back for metal surface attachment
- Requires two AAA batteries (included)
- Individually tested, inspected, and calibrated using NIST
- Includes Certificate of Calibration with unique report number, stated corrections and standard used for the calibration, and multi-language instructions (English, French, German, Italian, Portuguese and Spanish)

Dimensions (W x H x D): 114.3 x 88.9 x 25.4 mm

Type	PK	Cat. No.
LLG Timer with White Board, 4 channel	1	6.266 706

3



Timing/Timers

1

1 Interval timer with alarm

Benchtop mechanical timer. Suitable for standing, hanging and in addition on the back of two magnets, which allows the fitting of metal parts. Casing and rotary setting knob are white, the dial is black. Running time max. 60mins. Metal movement.

Dimensions (W x H x D): 70 x 70 x 40 mm

Type	PK	Cat. No.
Interval timer with alarm	1	9.260 020

2

2 Short period timer Timer II

Electronic timer and stopwatch with large display and 10-key setting. Counts up or down from 10 hours to 1 second. With pocket clip, bench stand, magnetic attachment and AAA 1.5V battery.

Dimensions (W x H x D): 60 x 70 x 25mm

Weight: 95g

Type	PK	Cat. No.
Timer II	1	9.851 027

3

3 Electronic timer clock

Count down/count up timer with loud alarm signal at end of timed period. With Clock, Stopwatch and Memory functions. Timer up to 24 hours. Fittings: magnet, stand and clip. With battery.

Dimensions (W x H x D): 68 x 53 x 20 mm

Amarell

Type	PK	Cat. No.
Electronic Timer Clock	1	9.235 145

4

4 3-channel-short period timer

Indispensable for laboratories. Triple timer with large display.
 - Indicates three separate times simultaneously, Measuring range: 1sec to 20hours
 - Stopwatch function
 - Integrated quartz watch
 - Supplied with magnet and clip
 - Operating temperature: 0 to 50 °C
 - Battery 1.5V AAA inclusive

Dimensions (W x H x D): 71 x 88 x 24mm

Weight: 115g

Dostmann electronic

Type	PK	Cat. No.
3-channel timer	1	6.233 690

5

5 Laboratory Short period timer Compact

Compact.
 Countdown/Countup.
 Digital reading, with alarm and repeat function.
 12hr. clock function.
 Countdown and countup display: 23hrs, 59mins, 59secs.
 Battery SR 44 inclusive.

Dimensions (W x H x D): 64 x 60 x 16 mm

Weight: 40 g

Hanhart

Type	PK	Cat. No.
Compact	1	9.262 071

3. Analytical measurement and testing Timing/Timers-Clocks

Crown stopper, mechanical

Impact resistant, dustproof and water resistant.
With diamond-turned metal case. 55mm diameter. Built-in strap ring.

Hanhart

Type	Measuring capacity hr: min: sec	PK	Cat. No.
Crown stopper 1 / 5 s	00:30:00	1	9.262 005 1
Crown stopper 1 / 10 s	00:15:00	1	9.262 010

1



9.262 005

Stopwatch Amigo, mechanical

Impact resistant. Unbreakable spring movement. 55mm diameter ABS case.
Supplied with 120cm lanyard.

Hanhart

Type	Measuring capacity hr: min: sec	PK	Cat. No.
Amigo 1/5 s	00:30:00	1	9.262 411 2
Amigo 1/10 s	00:15:00	1	6.205 734

2



9 262 411

3 Stopwatch, digital

1/100 seconds, split time, clock, date with weekday, hourly chime, alarm with snooze function, lanyard.
Measuring range: Time up to 23h, 59min, 59sec. Dimensions (W x H x D): 65 x 79 x 21mm, weight: 50g, incl. 1x 1.5V LR44 battery, EK-EL

TFA Dostmann

Type	PK	Cat. No.
Stopwatch	1	9.851 018

3



4 Stopclock, analogue, Mesotron

Quartz-accurate timer with large, analogue display.
Measuring range: 0 to 60 secs, 0 to 60 mins. Inner scale 1 to 100 secs/100 mins. 110 mm dia.
Battery life over 18 months with a 1.5 V button cell.

Hanhart

Dimensions (W x D x H): 130 x 40/95 x 175 mm
Weight: 375 g

Type	PK	Cat. No.
Mesotron	1	9.262 080

4



5 Radio controlled wall clock

- Highest precision radio-controlled clock
- Analogue display with second hand
- Digital display of date
- Large dial
- Ideal for home, office, waiting room, lobby or entrance hall and as a gift
- Ø 300mm
- Battery included 1.5 V AA

Dostmann electronic

Type	PK	Cat. No.
Radio controlled wall clock	1	9.851 019

5



1

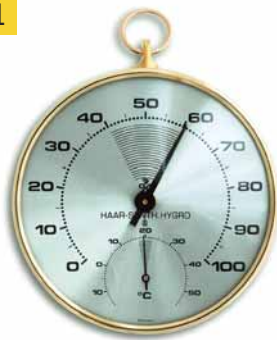

1 Thermohygrometer, analogue

Synthetic hair, spun metal case with dial and brass hanging ring.

TFA Dostmann

Measuring range

 Relative humidity: 0 to 100%
 Temperature: -15 to 55°C
 Weight: 105g

Diam. mm	PK	Cat. No.
100	1	9.726 403

2



2 Thermohygrometer

Universal application thermohygrometer with outdoor probe and stand/attachment device. Accessory wall mounting (screws or adhesive tape) are available on request.

Amarell

Specifications

 Measuring range: 0 to +50 x 0.1°C
 switchable to °F
 20 to 99 x 1% R.H.
 Dimensions (W x D x H): approx. 65mm x 20mm x 97mm

Type	PK	Cat. No.
Thermohygrometer	1	9.235 135

3



3 Digital Thermo-/Hygrometer EXACTO

NEW

For monitoring temperature and humidity. With display of min and max values.

TFA Dostmann

- Permanent display of daily maximum and minimum values with automatic reset after 24 hours.
- Additional max/min memory with manual reset
- Calibration function
- Backlighting
- With magnet, stand and mounting hole
- Precision sensor
- Stainless steel frame

Specifications

 Temperature range: -20 ... 70 °C
 Temperature accuracy: ±1 °C
 Temperature resolution: 1 °C
 Humidity range: 1 ... 99 %
 Humidity accuracy: ±3 % at 35 ... 75 %, otherwise ±5 %
 Humidity resolution: 1 %
 Power supply: 2 x 1.5 V AAA (not included in scope of supply)
 Dimensions (W x D x H): 74 x 26 x 90 mm
 Weight: 106 g

Type	PK	Cat. No.
EXACTO	1	4.670 846



1 Digital wireless thermometer/hygrometer INFO



TFA Dostmann

For monitoring outdoor temperature and room temperature/humidity. Display of minimum and maximum values and observation over an individual period.

- Wireless transmission of outdoor temperature via transmitter (max. 80 m)
- Indication of indoor temperature and humidity
- Permanent display of maximum and minimum values with manual reset
- Additional max/min memory with automatic reset after 24 hours
- Precision sensor
- 80 m range of the transmitter

Scope of supply: Wireless thermometer, temperature transmitter

Specifications

Temperature range (internal):	-10 ... 60 °C
Temperature range (external):	-40 ... 60 °C
Temperature accuracy:	±1 °C
Humidity range:	10 ... 99 %
Humidity accuracy:	±3 % at 35 ... 75 %
Transmission frequency:	433 MHz
Power supply:	2 x 1.5 V AA
Dimensions (W x D x H):	77 x 22 x 86 mm
Weight:	70 g

1



Type	PK	Cat. No.
Thermometer/hygrometer INFO	1	4.670 847

2 Thermohygrometer, TA 100

TFA Dostmann

- Very fast humidity sensor
- Dewpoint and max./min. function
- °C/°F-switchable
- Hi-Lo alarm with red warning LED

Specifications

Temperature	
Measuring range:	-40°C to +70°C
Display resolution:	0.1°C
Accuracy:	±1°C
Humidity	
Measuring range:	1% to 99% R.H.
Display resolution:	0.1%
Accuracy:	±4% from 35% to 75% remaining range ±5%
Working temperature:	-40°C to +70°C
Batteries:	2 x 1.5 Volt AAA
Dimensions:	105mm x 105mm x 44mm
Weight:	150g (incl. packaging)

2



Type	PK	Cat. No.
TA 100	1	9.726 405

3 Digital thermo-hygrometer for room and outdoor measurement



TFA Dostmann

For simultaneous monitoring of indoor and outdoor temperature/humidity.

- Measurement of outdoor data via cable sensor (cable length approx. 1.5 m)
- Display of minimum and maximum values and observation over a freely selectable period of time
- Min-/Max function
- For hanging and standing

Scope of supply: Thermo-hygrometer, battery

Specifications

Temperature range:	-10 ... 60 °C
Temperature accuracy:	±0.8 °C at 10 ... 30 °C, otherwise ±1 °C
Temperature resolution:	0.1 °C
Humidity range:	10 ... 99 %
Humidity accuracy:	±3.5 % at 30 ... 80 %, otherwise ±5 %
Humidity resolution:	1 %
Power supply:	1 x 1.5 V AAA
Dimensions (W x D x H):	102 x 21 x 110 mm
Weight:	144 g

3



Type	PK	Cat. No.
Digital thermometer/hygrometer	1	9.726 418

3. Analytical measurement and testing

Climate and environment measurement/Hygrometer-Special climate meters

1



9.726 964

Thermohygrometer testo 608

Continuous monitoring of indoor climate

Testo

The economic thermohygrometer testo 608-H1 measures humidity, temperature and dewpoint continuously. The large display is easy to read even at a distance. With wall mounting and table holder for flexible positioning. The accurate testo 608-H2 alarm hygrometer reliably indicates when humidity and temperature limits have been exceeded, for example in greenhouses, warehouses, cleanrooms, museums, laboratories etc.

- Continuous display of temperature and humidity or dewpoint
- With dew point calculation and max/min display
- Battery monitoring

Additional features testo 608 H2:

- LED alarm, warns if limits are exceeded
- High accuracy $\pm 2\%rH$

Specifications

Measuring rate:

Battery type:

Dimensions:

Housing:

Display:

Sensor type NTC:

Measuring range:

Accuracy (at 25°C):

Resolution:

Sensor type testo humidity sensor capacitive:

Measuring range:

Accuracy (at 25°C):

Resolution:

Operating temperature:

testo 608-H1 // testo 608-H2

18sec

9V block battery

111 x 90 x 40mm

ABS

LCD, 2 lines

0 ... 50 °C // -10 ... 70 °C

± 0.5 °C (± 1 digit)

0.1 °C

+10 ... 95 % rH // 2 ... 98 % rH

± 3 % rH // ± 2 % rH

0.1% rH

0 ... 50 °C // -10 ... 70 °C

Type	PK	Cat. No.
testo 608-H1	1	9.726 964 1
testo 608-H2	1	9.726 965

2



2 Digital Anemometer

For the measurement of wind speed (in m/s, km/h, mph, knots, ft/min), maximum and average wind speed, indication of temperature (in °C or °F). LCD backlight display. Auto/Manual power off. Useful for the functional check of fume hoods and safety cabinets.

Wind speed range:

0.2 to 30 m/s

Resolution:

0.1 m/s

Accuracy:

± 5 %

Temperature range:

-10 ... +45 °C (-14 ... + 113 °F)

Power supply:

3V CR2032 (included)

Height mm	Width mm	Depth mm	PK	Cat. No.
104	58	19	1	6.264 198



1 Sound level meter SU 130, class II

SAUTER

1

Sound level meter for noise measuring.

- Delivered in a hard carrying case
- Multi measuring functions: Lp: Standard sound level measuring function, Leq: Energy equivalent sound level measuring mode (type A), Ln: Shows the deviation from a pre-defined limit in %
- Selectable methods of evaluation: A: As sensitive as the human ear, C: Sensitive for noisier environmental conditions, where there are machines, plant, motors etc., F: For areas where sound intensity does not vary
- Function to set limits: Programmable target value for go/no-go test values
- Track function for continuous recording of variable environmental conditions
- Peak Hold Mode to capture peaks
- Internal memory for measured values, for 30 measurements. Can be displayed on the PC
- Data interface RS-232, included



Specifications

Measuring range

Lp A:	30 to 130 dB
Lp C/Lp F:	35 to 130 dB
Leq:	30 to 130 dB
Ln:	0 to 100 %
Readability:	0.1 dB
Dimensions (W x D x H):	236 x 63 x 26 mm
Net weight:	approx. 170 g
Power supply:	4 x 1.5 V AAA (not included)

Type	PK	Cat. No.
Sound level meter SU 130, class II	1	6.270 977

2 Sound level meter class I and II

NEW
SAUTER

2

For measurements for workplaces which are outdoors, e.g. at airports, on building sites, in road construction etc. with broad access to spectrum thanks to the highly-accurate 24-Bit A/D converter.

- Different sound pressure levels can be selected, such as, for example, Laeq, LcPeak, LaF, LaFMax, LaFMin, SD, SEL, E
- The optimised analogue frontend switch reduces the ambient noise and increases the linear measuring range
- Three profiles and 14 user-defined measurements can be calculated in parallel with different frequency and time weighting
- LN statistics and display of the graph showing the progression of time
- User-defined integral interval measurement up to a maximum of 24 hours is possible
- Frequency weighting (filter) A, B, C, Z
- Time interval during measurement: F (fast), S (slow), I (pulse)
- Freely-definable limits for the output of an optical alarm signal
- Peak Hold Mode to capture peaks
- Octavo function for targeted sound analysis
- Track function with graphic display of a measurement
- Calibration mode (with optional calibrator)
- Trigger mode: Analogue signal to switch the device on or off with 3.5 mm plug
- Automatic measurement for timer function is possible
- Measured value recording frequency selectable: 10, 5, 2 Hz
- Data transfer using MicroSD (4 GB), RS-232 or USB
- Option of fitting a column on the rear of the housing, ¼ thread



Scope of supply: Sound level meter, memory card, hard carrying case

Specifications

	SW 1000 // SW 2000
Measuring capacity linear:	20 ... 134 dB // 25 ... 136 dB
Frequency range:	0.003 ... 20 kHz // 0.02 ... 12.5 kHz
Sensitivity:	50 m V/Pa // 40 m V/Pa

Type	PK	Cat. No.
SW 1000, class I	1	6.311 638
SW 2000, class II	1	4.676 252

1

1 Light measuring instrument SO

Light measuring instrument for precise light measurement up to 200.000 Lux

SAUTER

- Measures illumination in the workplace
- Helps to determine whether a workstation has insufficient light or whether there is too much light
- Photo sensor: silicon diode
- Cosine correction for angular incident light
- Sturdy protective cover for the photo sensor
- Increased service life: Impact protection through a protective casing
- Track function for continuous recording of variable environmental conditions
- Peak Hold Mode to capture peaks
- Selectable measuring units: fc (foot-candle), lx
- AUTO-OFF function
- Delivery in a robust box

Specifications

Measuring range/Readability:	200 lx/0.1 lx 2000 lx/1 lx 20000 lx/10 lx 200000 lx/100 lx
Measuring frequency:	2 Hz
Cable length (Photo sensor):	approx. 1 m
Dimensions (W x D x H):	100 x 60 x 28 mm
Net weight:	approx. 250 g
Power supply:	9 V Block (not included)

Type	PK	Cat. No.
Light measuring instrument SO	1	6.259 057

2 CO₂ Meter, Air CO₂ntrol 5000

 With data logger function, ideal for monitoring the CO₂ concentration in buildings.

Dostmann electronic

- Logger function saves the data as a CSV file on Micro SD card
- LEDs for visual identification of CO₂ concentration
- Displays temperature, Humidity and CO₂ content
- Individual alarm setting
- Bench- and wall mounting

Scope of supply: Meter incl. USB mains adapter and Micro SD card

Specifications

CO₂ range:	0 ... 5000 ppm
Resolution:	1 ppm (0-1000 ppm), 5 ppm (1001-2000 ppm), 10 ppm (>2000 ppm)
Accuracy:	±50 ppm or 5 % larger value applies, >3000 ppm ±7%
Temperature range:	0 ... 50 °C
Resolution:	0.1 °C
Accuracy:	±0.5 °C
Relative humidity:	5 ... 95 %
Resolution:	1 %
Accuracy:	±5 %
Display:	7 segment LCD
Housing:	Plastic
Dimensions:	120 x 66 x 33 mm
Weight:	103 g (without mains adapter)
Power supply:	100-240 VAC 50/60 Hz

Type	PK	Cat. No.
Air CO ₂ ntrol 5000	1	6.291 253

2

1 Precision handheld instruments P700 series

For temperature, moisture and airflow.

Dostmann electronic

For highly accurate temperature measurements with USB PC online interface.

(Optional: Windows SmartGraph software for graphical and tabular documentation, etc). Integral probe calibration for sensor tolerance compensation. Min.- Max.- Hold- and AVG- functions. The large LCD shows two measurements synchronously, even temperature differences can be displayed (P705, P755, P755-Log, P770).

Specifications

General (all models):

USB interface, Max-Min memory, Hold function, true average calculation over a freely selectable period, Auto-off function, measured quantities can be freely assigned to instrument channels, comprehensive calibration options (selectable 1-point, 2-point or 3-point calibration), large display with bar graph for simultaneous display of 2 measured values

P700/P705:

1/2 measurement channels (Pt100 4-wire probe, thermocouples type J, K, L, N, T, R, S), measurement ranges and accuracies: Pt100: -200 to +850°C (±0.1 °C -100 to +200°C, otherwise ±0.1% of measurement value) thermocouples, DIN types (-200 to +1760°C)

P710/P715:

1/2 measurement channels (Thermocouples type K, J, L, N, T), measurement ranges and accuracies: -200 to +1370°C (±0.2 °C from 0 to +200 °C, ±0.5 °C to 1000 °C, otherwise ±1.0 °C of measurement value)

Thermocouples acc. to EN 60584

P750/P755/P755-Log:

1/2 measurement channels (Pt100 4-wire probe, thermocouples type J, K, L, N, T, R, S, moisture, flow), measurement ranges and accuracies: Pt100: -200 to +850°C (±0.03°C -50 to +200°C, ±0.05°C -200 to +200°C, otherwise ±0.05% of measurement value), thermocouples, DIN type (types J, K, L, N, T 0 to 200 °C, ±0.3°C, +200 to +1000°C ±1.0 °C, otherwise ±1.5°C;

type R, S ±1.0 °C +0.1% of measurement value) humidity 0 to 100% R.H. (±1.5%R.H.), flow 0 to 40 m/s (±0.5% of measurement value +1.0% of final value)

P770:

2 measurement channels (Pt100, thermocouples type J, K, L, N, T, R, S, moisture, flow), measurement ranges and accuracies: Pt100: -200 to +850°C (±0.1 °C -100 to +200°C, otherwise ±0.1% of measurement value)

thermocouples, DIN types, humidity 0 to 100%R.H. (±1.5%R.H.), flow 0 to 40 m/s (±0.5% of measurement value)

Dimensions (L x W x D)/ weight: 200 x 85 x 40mm/300g

P700-P755 for Ex-use Zone 1 and Zone 2 according to ATEX approval II 2 G Ex ib IIB T4 Gb available on request.



Type	Description	PK	Cat. No.
P700	1 channel, Pt100	1	9.852 000
P705	2 channel, Pt100	1	9.852 001
P710	1 channel thermocouples Type K, J, L, N, T	1	9.852 002
P715	2 channel thermocouples Type K, J, L, N, T	1	9.852 003
P750	1 channel, Pt100, moisture, dew point, flow	1	9.852 004
P755	2 channel, Pt100, moisture, dew point, flow	1	9.852 005
P755-Log	2 channel, Pt100, moisture, dew point, flow, with datalogger for 6000 values	1	9.852 006
P770	2 channel, Pt100, moisture, dew point, flow	1	9.852 007
P770-Log	2 channel, Pt100, moisture, dew point, flow, with datalogger for 6000 values	1	9.852 008

Accessories for hand-held meters Serie P700

Description	PK	Cat. No.
Immersion probe Pt100, -50 to +350°C, Cl. B, 150x3mm	1	9.851 935
Immersion probe Pt100, -50 to +350°C, Cl. B, 300x3mm	1	9.851 936
Immersion probe Pt100, -200 to +450°C, ±0.03°C, 150x3mm	1	9.851 937
Immersion probe Pt100, -200 to +450°C, ±0.03°C, 300x3mm	1	9.851 938
Insertion probe Pt100, -50 to +350°C, Cl. B, 150x4mm	1	9.851 948
Immersion probe NiCr-Ni/Type K, -40°C to +1100°C, Cl. 1, 300x1.5mm	1	9.851 949
Surface probe NiCr-Ni/Type K, T90 3 sec., -65 to +550°C, 150 x 15.0mm	1	9.851 961
Temp. / relative Humidity -40 to 80°C / 0 to 100%, 120x20mm	1	9.851 954
Airflow Turbine probe 0 to 20m/s, diam. 22 x 28mm, 150mm lg.	1	9.851 955
Software DE-Graph for 95 / 98 / 2000 / NT / Vista	1	9.851 925
P700 adapter for type K probe with mini plug	1	9.851 995
Service case suitable up to 3 probes & accessories	1	9.851 924
ISO certificate for temperature CERT	1	9.851 992
PC-Cable for USB port	1	6.242 171
Power supply 230 V	1	9.851 959

1 Thermometer testo 440 Laboratory kit



Laboratory kit with Pt100 probe for reliable and precise temperature measurement and documentation. Particularly suitable for use in corrosive media due to the laboratory probe, whose coating is made of the tried-and-tested DURAN® laboratory glass. The testo 440 air velocity & IAQ measuring instrument automatically detects the connected probes, and the stored, structured measurement menus makes work considerably easier in a wide variety of applications. For example it can be used to optimally adjust air conditioning and ventilation systems.

Testo

- Structured measurement menu for long-term measurements
- Internal data storage and USB port for flexible data export
- Parallel connection of up to three probes possible: one Bluetooth® probe, one wired probe and one temperature probe with thermocouple type K connection
- Versatile, expandable with an extensive selection of digital probes

Scope of supply: Climate measuring instruments, 3x AA batteries, USB cable and calibration protocol, glass-coated digital Pt100 laboratory probe, basic case for testo 440 and 1 probe

Specifications

Temperature measuring range (NTC):	-50 ... +400 °C
Accuracy:	±0.3 °C (-50 ... 300 °C) ±0.4 °C (300.01 ... 400 °C)
Resolution:	0.01 °C
Memory:	7500 measurement protocols
testo 440	
Operating/storage temperature:	-20 ... +50 °C
Dimensions (W x D x H):	65 x 32 x 154 mm
Weight:	250 g
Power supply:	3 x Mignon, Type AA
Pt100 probe	
Operating/storage temperature:	-5 ... 45 °C/-20 ... 60 °C
Cable length:	1.6 m
Dimensions (L x Ø):	200 x 6 mm
Weight:	160 g

Type	PK	Cat. No.
testo 440 Laboratory kit	1	6.314 325

Probes for Climate measuring instrument testo 440



Testo

Description	Measuring range °C	PK	Cat. No.
Fume cupboard probe (digital), wired	0 ... +50	1	6.312 182 2
Laboratory probe glass-coated (digital) with Pt100 temperature sensor	-50 ... +400	1	6.312 183 3
Immersion/Piercing probe (digital) with Pt100 temperature sensor	-80 ... +300	1	6.312 184

1



2



3



3. Analytical measurement and testing Density determination/Density meter

1 LLG-Precison-Hydrometer, Alcoholmeters, with thermometer, calibratable

Measuring range, graduation: 0.1% vol, with thermometer 0 to +30°C, graduation: 0.5°C, calibrated at 20°C.
Filling: blue. Overall length: 380mm

Type	Measuring range % vol	PK	Cat. No.
1	0 - 10	1	9.236 810
2	10 - 20	1	9.236 811
3	20 - 30	1	9.236 812
4	30 - 40	1	9.236 813
5	40 - 50	1	9.236 814
6	50 - 60	1	9.236 815
7	60 - 70	1	9.236 816
8	70 - 80	1	9.236 817
9	80 - 90	1	9.236 818
10	90 - 100	1	9.236 819

1



2 Hydrometers, relative density (S.G.)

Shot poised. Without thermometer. Reference temperature: +20°C.

Length mm	Measuring range g / ml	Sub-divisions g / ml	PK	Cat. No.
280	0.600 - 0.800	0.002	1	9.004 006
280	0.800 - 1.000	0.002	1	9.004 008
280	1.000 - 1.200	0.002	1	9.004 010
280	1.200 - 1.400	0.002	1	9.004 012
280	1.400 - 1.600	0.002	1	9.004 014
280	1.600 - 1.800	0.002	1	9.004 016
300	0.700 - 1.000	0.005	1	9.004 057
300	1.000 - 1.500	0.005	1	9.004 060
300	1.500 - 2.000	0.005	1	9.004 065

Further models available on request.

2



3 Hydrometers, Baumé

Baumé type. Shot poised. Without thermometer. Reference temperature: +15°C.

Length mm	Measuring range Bé	Sub-divisions Bé	PK	Cat. No.
260	0 - 5	0.1	1	9.004 305
220	0 - 10	1.0	1	9.004 310
230	0 - 15	1.0	1	9.004 315
230	0 - 20	1.0	1	9.004 320
250	0 - 30	1.0	1	9.004 330
250	0 - 40	1.0	1	9.004 340
280	0 - 50	1.0	1	9.004 350
300	0 - 70	1.0	1	9.004 370

Further models available on request.

3



4 Hydrometers, density

DIN 12791 (and BS718). M100 series. Shot poised.
Without thermometer. Reference temperature: +20 °C.

Length mm	Measuring range g / ml	Sub-divisions g / ml	PK	Cat. No.
250	0.800 - 0.900	0.002	1	9.004 108
250	0.900 - 1.000	0.002	1	9.004 109
250	1.000 - 1.100	0.002	1	9.004 110
250	1.100 - 1.200	0.002	1	9.004 111
250	1.200 - 1.300	0.002	1	9.004 112
250	1.300 - 1.400	0.002	1	9.004 113
250	1.400 - 1.500	0.002	1	9.004 114
250	1.500 - 1.600	0.002	1	9.004 115

Further models available on request.

4



Density determination/Density meter



1 Hydrometers, density

Shot poised. Without thermometer. Reference temperature: +20°C.

Length mm	Measuring range g / ml	Sub- divisions g / ml	PK	Cat. No.
160	0,760 - 0,820	0.001	1	9.004 153
160	0,820 - 0,880	0.001	1	9.004 154
160	0,880 - 0,940	0.001	1	9.004 155
160	0,940 - 1,000	0.001	1	9.004 156
160	1,000 - 1,060	0.001	1	9.004 157
160	1,060 - 1,120	0.001	1	9.004 158
160	1,120 - 1,180	0.001	1	9.004 159
160	1,180 - 1,240	0.001	1	9.004 160
160	1,240 - 1,300	0.001	1	9.004 161
160	1,300 - 1,360	0.001	1	9.004 162
160	1,360 - 1,420	0.001	1	9.004 163

Further models available on request.

2



2 ASTM Hydrometers

Precision hydrometers acc. to ASTM E2995-14 for determination of density for mineral oil, with thermometer "mercury free".

Ludwig Schneider

Hydrometer with thermometer, error-limit for density: $\pm 0.5 \text{ kg/m}^3$, with thermometer -20 to +65°C in 1°C, blue filling, error-limit $\pm 1^\circ\text{C}$. With works calibration on request. With blue, environmental friendly filling of thermometers. Each item packed in plastic tubes for breakage protection.

Length mm	Measuring range kg/m ³	Reference temperature °C	Scale	PK	Cat. No.
380	600 - 650	15	0,5	1	6.267 132
380	650 - 700	15	0,5	1	6.267 133
380	700 - 750	15	0,5	1	6.267 134
380	750 - 800	15	0,5	1	6.267 135
380	800 - 850	15	0,5	1	6.267 136
380	850 - 900	15	0,5	1	6.267 137
380	900 - 950	15	0,5	1	6.267 138
380	950 - 1000	15	0,5	1	6.267 139
380	1000 - 1050	15	0,5	1	6.267 140
380	1050 - 1100	15	0,5	1	6.267 141
380	775 - 825	15	0,5	1	6.267 142

3



3 Hydrometers, high-quality plastics, PC

Hydrometers made of high-quality plastics (polycarbonate).

Ludwig Schneider

- Breakage protected (no glass breakage)
- Fully made of resistant polycarbonate (PC)
- High transparency (like glass), easy-to-read scales
- High precision and reproducibility
- Suitable for applications in food, pharmaceutical and cosmetic industries as well as many others
- Measuring units: specific gravity, density, Oechsle, % mass, Brix, saturation, ° Baumé, etc.
- Made in Germany
- Works certificate available on request (option)
- Food safety according to HACCP

For	Length mm	Measuring range	Reference temperature °C	Scale	PK	Cat. No.
Density	300	1,000 - 1,220 g/cm ³	20	0,002 g/cm ³	1	9.236 840
Density	300	1,200 - 1,420 g/cm ³	20	0,002 g/cm ³	1	9.236 841
Density	300	1,400 - 1,620 g/cm ³	20	0,002 g/cm ³	1	9.236 842
Salt saturation	300	0 - 100°	20	1°	1	9.236 843
Sodium chloride	300	0 - 26,4 %mas.	20	0,2 %	1	9.236 847
Sugar / Salt	250	0 - 12 °Bé	15	0,2 °Bé	1	9.236 844
Sugar / Salt	250	0 - 12 °Bé	20	0,2 °Bé	1	6.291 763
Sugar / Salt	300	0 - 25 °Bé	15	0,2 °Bé	1	7.658 786
Sugar / Salt	250	9 - 21 °Bé	15	0,2 °Bé	1	9.236 845
Sugar / Salt	250	19 - 31 °Bé	15	0,2 °Bé	1	9.236 846
Sugar / Salt	250	29 - 41 °Bé	15	0,2 °Bé	1	6.273 071
Sugar / Salt	250	49 - 61 °Bé	15	0,2 °Bé	1	7.980 963
Sugar	300	0 - 35 %mas./Brix	20	0,5 %mas.	1	9.236 848
Sugar	300	0 - 50 %mas./Brix	20	0,5 %mas.	1	9.236 849

3. Analytical measurement and testing Density determination/Density meter-Pycnometer

1 Hydrometer jars, glass

With spout and base.

Diam. mm	Height mm	PK	Cat. No.
38	150	1	9.950 034
38	200	1	9.950 035
50	200	1	9.950 036
50	250	1	9.950 037
50	300	1	9.950 038
63	350	1	9.950 039



2 Pycnometers, BLAUBRAND®, Borosilicate glass 3.3.

DIN ISO 3507, gay-lussac type. Including individual certificate. Adjusted. BRAND
Reference temperature 20°C. With NS10/19 capillary stopper. Stopper top ground and polished. Inscription in highly contrasting blue enamel. The volume in cm³ is specified to a precision of 3 decimal places. Calibrated to contain. Every pycnometer is calibrated with its own stopper; hence, stoppers are not interchangeable. Each bottle and its stopper is marked with a unique matching identification number.

Nom. capacity cm ³	PK	Cat. No.
5	1	9.277 305
10	1	9.277 310
25	1	9.277 325
50	1	9.277 350
100	1	9.277 400



3 Pycnometers, Borosilicate glass 3.3., incl. DAkkS calibration certificate

BLAUBRAND®. The volume in cm³ is specified to a precision of 3 decimal places. Every pycnometer is calibrated with its own stopper, hence, stoppers are not interchangeable. Each bottle and its stopper is marked with a unique matching identification number. All BLAUBRAND® density bottles are supplied with one accompanying individual certificate in the original packaging. BRAND

- DIN ISO 3507
- Gay-lussac pattern calibrated
- Calibrated to contain (TC, In)
- Reference temperature 20°C
- With NS10/19 capillary stopper
- Top of stopper ground and polished
- Inscriptions in high contrast blue enamel

Nom. capacity cm ³	PK	Cat. No.
5	1	6.238 790
10	1	6.258 623
25	1	6.801 879
50	1	6.073 163
100	1	4.667 799



4 Pycnometers, calibrated, Borosilicate glass 3.3.

ISO 3507. Individually calibrated to contain (In) to 0.001ml. Net volume capacity is engraved on the body. Each bottle is calibrated together with its stopper. In order to differentiate easily, both the body and the stopper have the same code numbers printed on themselves. ISOLAB

Capacity ml	PK	Cat. No.
5	1	4.008 327
10	1	6.241 602
25	1	4.008 328
50	1	6.241 603
100	1	4.008 329

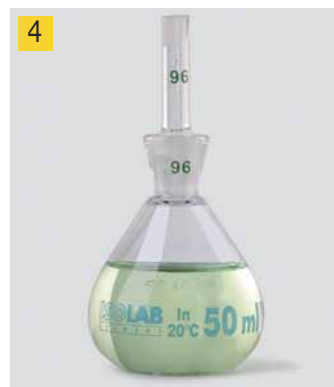

Density determination/Pycnometer-Density meters

1

1 Pycnometers

According to ISO 2811, DIN 53 217, ASTM D1475.

Capacity ml	Material	PK	Cat. No.
100	Stainless steel	1	6.223 204
50	Stainless steel	1	6.205 559

2

2 Pycnometer heads with/without wide-neck bottle

For density determinations (raw density) of bitumen-like materials and mineral materials. Consists of 1000ml wide-neck bottle with conical shoulder and NS joint neck, and pycnometer head. Material: head made of DURAN® tubing, bottle: DURAN®

Lenz

Type	NS	Capacity ml	PK	Cat. No.
Pycnometer head with conical shoulder bottle	45/27	500	1	6.235 849
Pycnometer head with conical shoulder bottle	60/37	1000	1	6.070 510
Pycnometer head without conical shoulder bottle	45/27		1	6.401 224
Pycnometer head without conical shoulder bottle	60/37		1	6.079 436

3
4

6.291 652

6.291 653

Density meters Densito/DensitoPro

Robust density meters for mobile use with easy handling and user guidance. Ideal for rapid and accurate routine measurements in quality assurance, incoming and outgoing goods inspection.

Mettler-Toledo Online

DensitoPro equipped with RFID and barcode reader for rapid and reliable tracing of samples.

- Automatic sampling pump
- Available measurement scales: API, °Baumé, Brix, density, Ethanol, H₂SO₄, proof (US and IP), °Plato, specific gravity, user-defined concentration
- Automatic temperature compensation
- Memory for up to 1100 results
- Backlit measuring cell
- Adjustable limits with customisable colours in the display
- Bright display with good readability

Specifications

Density range:	0 ... 3 g/cm ³
Resolution:	0.0001 g/cm ³
Accuracy:	±0.001 g/cm ³
Sample temperature range:	0 ... 50 °C
Resolution:	0.1 °C
Accuracy:	±0.2 °C
Sample volume:	2 ml
Memory:	1100 samples
Display:	2.4" colour display, backlit
Interfaces:	USB-A, USB-C
Power supply:	Removable and rechargeable Li-Ion batteries

Type	PK	Cat. No.
Densito	1	6.291 652 3
DensitoPro with RFID and barcode reader	1	6.291 653 4

1 Density meters DMA 35

NEW
Anton Paar

1



Portable, digital measuring device for the determination of density, relative density and concentration. DMA 35 EX and DMA 35 EX Petrol are certified according to ATEX for applications in hazardous environments.

- On-site measurements for fast reactions
- Oscillator principle (borosilicate glass oscillator)
- Sample filling via manual filling pump or syringe
- Complete data control through traceability
- Viscosity correction for measurements also on highly viscous samples
- Gesture control for one-handed measurement
- Recognition of results outside the tolerance limit
- Measuring of density, relative density, alcohol concentration, sugar/extraction concentration, API functions, H₂SO₄ concentration, ten programmable custom-specific measuring units
- Robust case with exchangeable cell
- 3 years warranty



Scope of supply: Density meter, filling tube, adapter for syringe filling, syringes, transportation case, rubber protection for measuring cell, 3 x batteries, allen key, instructions.

Specification

Density range:	0 ... 3 g/cm ³
Resolution:	0.0001 g/cm ³
Accuracy:	±0.001 g/cm ³
Sample temperature range:	0 ... 100 °C
Temperature measurement range:	0 ... 40 °C
Resolution:	0.1 °C
Accuracy:	±0.2 °C
Reproducibility standard deviation (acc. to ISO 5725):	0.0007 g/cm ³
Sample volume:	2 ml
Data memory:	1024 measurement results, 250 sample IDs, 30 measuring methods
Display:	coloured LCD, self-rotating
Interfaces:	Bluetooth®, RFID
Dimensions (W x D x H):	103 x 245 x 126 mm
Weight:	660 g
Power supply:	3 x Mignon alkaline batteries, 1.5 V LR06 AA
IP code:	IP 54

Type	PK	Cat. No.
DMA 35 Standard	1	6.313 803
DMA 35 EX	1	6.313 804
DMA 35 EX Petrol	1	6.313 805

2 Standards for density, kinematic and dynamic viscosity

NEW
Reagecon

2

To calibrate, control or validate all types of viscometers including capillary, flow cup, rotational, falling ball, falling/rising object, stabinger and vibrational viscometers. Tested and certified according to ASTM method D 2162, ASTM method D4052 and ISO 17025 (INAB Ref. 264T).

- Usable for fluids up to 100 °C
- In 500 ml glass bottle



Warning

H phrases: H413



Type	Density at 20 °C	Kinematic viscosity at 20 °C	Dynamic viscosity at 20 °C	PK	Cat. No.
N10	0.84	22.00	18.00	1	4.675 405
N100	0.87	320.00	280.00	1	4.675 406
N250	0.84	790.00	660.00	1	4.675 407
N35	0.87	88.00	76.00	1	4.675 408
N75	0.83	210.00	170.00	1	4.675 409
S20	0.84	43.00	36.00	1	4.675 410
S200	0.84	540.00	460.00	1	4.675 411
S60	0.86	160.00	140.00	1	4.675 414

Further products can be found in our online shop.

Density determination/Density meters

1

1 Density meter DMA 501

NEW

Anton Paar

Density meter for measuring of chemicals, pharmaceuticals, cosmetics and food. Suitable for samples with difficult properties like paste, inhomogeneous, sedimenting and particulate samples or aerosol sprays.

The DMA 501 contains all relevant concentration tables and formulas for calculating product specific parameters and the results are displayed in the appropriate unit. Automatic filling and measuring with the optional available industrial peristaltic pump possible.

- Camera image of the measuring cell (U-view™) for viewing the correct sample filling, whereby potential filling errors due to inhomogeneous samples, gas bubbles or particles are automatically detected with the FillingCheck™ function
- Splash-proof front
- Fanless temperature control of the sample
- User-defined layouts of the measurement display with result outputs for individual requirements
- Documentation and traceability of data
- Elimination of external influences through the implementation of a standardised sample handling
- Integrated temperature and humidity sensor
- Integrated pressure sensor for adjustment
- Automatic full-range viscosity correction of results
- 3 years warranty

Specifications

Density measuring range/Accuracy:	0 ... 3 g/cm ³ /0.001 g/cm ³
Reproducibility standard deviation (acc. to ISO 5725):	0.0004 g/cm ³
Minimal sample volume:	approx. 1 ml
Temperature range/Accuracy:	15 ... 40 °C/0.3 °C
Display:	7 inches, TFT WVGA (800 x 480 Px), PCAP touchscreen
Interfaces:	1 x Ethernet, 3 x USB, 1 x RS-232
Dimensions (W x D x H):	265 x 375 x 180 mm
Weight:	13.5 kg
Power supply:	100 .. 240 V, 47/63 Hz, 24 V, 3 A

Type	PK	Cat. No.
DMA 501	1	6.313 796

2

6.313 797

Accessories for Density meters DMA 501

NEW

Anton Paar

Description	PK	Cat. No.
Peristaltic pump	1	6.313 797 2
Peristaltic pump highly resistant	1	6.313 798
Calibration according to ISO 17025	1	6.313 799



1 Density meter DS7700/DS7800 sets

Each set contains all necessary accessories from tube sets to nozzles and adapters to a splash guard for the manual sample supply. The devices are suitable for almost all liquids, emulsions, pastes, etc. thanks to the chemical-resistant sample-contacting parts made of borosilicate glass and PTFE. Depending on the set, samples are fed manually via syringe, semi-automatically via peristaltic pump or fully automatically via autosampler.

A.KRÜSS Optronic



Set 1: Low sample volume, samples of any degree of viscosity, semi-automatic drying, small Tygon tube set

Set 2: Low sample volume, samples of any degree of viscosity, aggressive samples, splash protection for addition of aggressive samples, tube sets suitable for every type of samples, semi-automatic drying, small Tygon and PTFE tube set

Set 3: Moderate to high sample volume, low to slightly viscous samples, semi-automatic sample feeding and cleaning, semi-automatic drying, large Tygon tube set

Set 4: High sample volume, low-viscous to slightly viscous samples, fully automatic sample supply and cleaning, fully automatic drying (no interchange of tubes required), large Tygon tube set

Set 5: High sample volume, low-viscous to slightly viscous samples, tube sets suitable for any kind of sample, fully automatic sample supply and cleaning, fully automatic drying (no interchange of tubes required), large PTFE tube set

Scope of supply: Density meter with drying unit, waste container, operating instructions, test report, set-dependent tube set, set-dependent peripheral devices

Specifications

Measuring range:	0 ... 3 g/cm ³
Sample volume by manual injection:	0.9 ml
Temperature range/Accuracy:	10 ... 40 °C/±0.02 °C
Measurement time approx:	1 s
Ambient temperature:	10 ... 40 °C
Housing:	aluminium, powder-coated
Display:	5.7"-TFT-Touchscreen, 640 x 480 Pixel
Interfaces:	1x USB, 1x RS-232, 1x Ethernet
Power supply:	100 ... 240 V, 47/63 Hz
Power consumption (measuring mode):	25 W
Power consumption (max.):	120 W
Methods:	practically unlimited number of methods adjustable
Dimensions (W x D x H):	220 x 220 x 430 mm
Weight:	5.3 kg

Type	PK	Cat. No.
DS7700-1	1	6.285 221
DS7700-2	1	6.285 222
DS7700-3	1	6.285 223
DS7700-4	1	6.311 902
DS7700-5	1	6.313 081
DS7800-1	1	6.285 224
DS7800-2	1	6.285 225
DS7800-3	1	6.285 226
DS7800-4	1	7.911 133
DS7800-5	1	6.311 903

2 Combined density and refractometry index standards

For density and refractometer calibration in one step. Bottles can directly be used in SC1 and SC30 automation units. Coded with barcodes for fully automatic verification procedure in METTLER-TOLEDO LiQC systems.

Mettler-Toledo Online

**Danger**

H phrases: H304|EUH066



Type	Refractive Index at 20 °C	Density at 20 °C g/cm ³	PK	Cat. No.
Water	1.333	0.998	1	6.241 945
Dodecane	1.422	0.749	1	6.256 339

Further products can be found in our online shop.

Viscosity determination/Viscosimeter



1

1 Dipping flow cups Frikmar

Aluminium. DIN 53211 viscometer. With brass nozzle or stainless steel (V2A) as indicated. For all types of liquid chemicals, varnishes, fluid enamels, gravure printing inks and leather dyes, oils, fats, foodstuffs etc. Cup volume 100ml.

Flow nozzle mm	Material	PK	Cat. No.
3	brass	1	6.056 477
4	brass	1	9.149 898
5	brass	1	6.058 370
6	brass	1	6.056 922
8	brass	1	6.084 496
2	brass	1	6.055 115
4	stainless steel	1	6.205 982
6	stainless steel	1	6.800 186
5	stainless steel	1	7.653 197
3	stainless steel	1	7.673 361



2

2 Flow cups with fixed nozzle

With fixed nozzle made of stainless steel. Housing made of titanium anodised aluminium.

Flow nozzle mm	Description	Material	PK	Cat. No.
2	similar to DIN 53 211	Aluminium	1	6.057 808
3	similar to DIN 53 211	Aluminium	1	6.091 529
4	DIN 53 211	Aluminium	1	9.149 862
4	DIN 53 211	Stainless Steel	1	6.226 824
6	similar to DIN 53 211	Aluminium	1	6.301 841
8	similar to DIN 53 211	Aluminium	1	6.302 759
3	ISO 2431	Aluminium	1	6.223 165
4	ISO 2431	Aluminium	1	6.088 604
5	ISO 2431	Aluminium	1	6.901 466
6	ISO 2431	Aluminium	1	6.088 605



3

3 Immersion flow cup with fixed nozzle

With fixed nozzle from stainless steel or aluminium.

Flow nozzle mm	Acc. to	Material	PK	Cat. No.
4	DIN 53 211	Aluminium	1	9.149 894
6	similar to DIN 53 211	Aluminium	1	6.080 098
3	ISO 2431	Aluminium	1	6.705 831
4	ISO 2431	Aluminium	1	6.302 328
6	ISO 2431	Aluminium	1	6.314 566
5	ISO 2431	Aluminium	1	6.705 832
4	DIN 53 211	Stainless Steel	1	6.264 682
6	similar to DIN 53 211	Stainless Steel	1	6.225 937



4

4 Flow cups, without nozzles

For 2, 3, 4, 5, 6, 7 and 8mm outlet detachable nozzles, please order separately. Flow cups and nozzles similar to DIN 53211.

Type	Flow nozzle mm	Material	PK	Cat. No.
Flow cups	-	Aluminium	1	9.149 860
Nozzle	2	Stainless Steel	1	9.149 872
Nozzle	3	Stainless Steel	1	9.149 873
Nozzle	4	Stainless Steel	1	9.149 874
Nozzle	5	Stainless Steel	1	9.149 875
Nozzle	6	Stainless Steel	1	9.149 876
Nozzle	7	Stainless Steel	1	9.149 877
Nozzle	8	Stainless Steel	1	9.149 878



5

6

Flow cup stands

Stainless steel.

Type	PK	Cat. No.
Flow cup stand, ring stand	1	9.149 881 5
Flow cup stand, tripod stand	1	9.149 884 6

9.149 881

9.149 884

1 Viscometers Ubbelohde, glass, kinematic

ISO 3105, DIN 51562.

SI Analytics

For manual (type 501 ..) or automatic (type 532 ..) measurements.

Constants documented in manufacturer's certificate.

Type	Capillary I.d.	Measuring range	Capillary	Constant	PK	Cat. No.
	mm	mm ² / sec		K		
501 00	0,36	0,2 - 1	0	0,001	1	9.268 100
501 03	0,47	0 - 3	0c	0,003	1	9.268 103
501 01	0,53	0,8 - 5	0a	0,005	1	9.268 101
501 10	0,63	1,2 - 10	I	0,01	1	9.268 110
501 13	0,84	3 - 30	Ic	0,03	1	9.268 113
501 11	0,95	5 - 50	Ia	0,05	1	9.268 111
501 20	1,13	10 - 100	II	0,1	1	9.268 120
501 23	1,50	30 - 300	IIc	0,3	1	9.268 123
501 21	1,69	50 - 500	IIa	0,5	1	9.268 121
501 30	2,01	100 - 1000	III	1	1	9.268 130
501 33	2,65	300 - 3000	IIIc	3	1	9.268 133
501 31	3,00	500 - 5000	IIIa	5	1	9.268 131
501 40	3,60	1000 - 10000	IV	10	1	9.268 140
532 00	0,36	0,3 - 1	0	0,001	1	7.023 176
532 03	0,47	0,5 - 3	0c	0,003	1	9.268 203
532 01	0,53	0,8 - 5	0a	0,005	1	9.268 201
532 10	0,63	1,2 - 10	I	0,01	1	9.268 210
532 13	0,84	3 - 30	Ic	0,03	1	9.268 213
532 11	0,95	5 - 50	Ia	0,05	1	7.023 177
532 20	1,13	10 - 100	II	0,1	1	9.268 220
532 23	1,50	30 - 300	IIc	0,3	1	9.268 223
532 21	1,69	50 - 500	IIa	0,5	1	7.023 178
532 30	2,01	100 - 1000	III	1	1	9.268 230
532 31	3,00	500 - 5000	IIIa	5	1	7.023 179
532 33	2,65	300 - 3000	IIIc	3	1	9.268 233
532 40	3,60	1000 - 10000	IV	10	1	9.268 240

1



2 Viscometer holders

Type 05392. VA steel.

SI Analytics

Suitable for all Ubbelohde viscometers without TC sensors. For manual and automatic measurements. Holds the viscometer perpendicularly. Accuracy <1°. Protects the viscometer from damage.

Type	PK	Cat. No.
05392	1	9.268 790

2



3 Digital viscometer VISCO/VISCO-895

Compact and easily carried with one hand. Fully digital display allows for anyone to easily read results. Capable to measure with only a small amount of sample. Easy set-up and simple, one-button operation. Capable of taking measurements with containers other than the included beakers.

ATAGO

VISCO-895: Aluminium model with reduced weight (895 g).

Scope of supply:

VISCO/VISCO-895 Package A: Viscometer with adapter for cups, 50 paper cups and 50 plastic cups

VISCO/VISCO-895 Package B: Viscometer with Ultra Low Adapter for low viscosity samples (1 to 2000 mPas)

Specifications

Measuring range Viscosity	A1: 50 to 200.000 mPas/50 to 200.000 cP A2: 100 to 600.000 mPas/100 to 600.000 cP A3: 500 to 2000.000 mPas/500 to 2000.000 cP
Measuring range Torque:	0.0 to 100.0% (recommended: 10.0 to 100.0 %)
Speed:	0.5 to 250 rpm
Working temperature:	10 to 40 °C
Dimensions (W x D x H):	120 x 120 x 200 mm
Netweight:	1200 g
Power supply:	100-240 V, 50/60 Hz, 4 x LR6/AA batteries

3



Type	PK	Cat. No.
VISCO	1	6.286 453
VISCO Package A	1	6.286 454
VISCO Package B	1	6.286 455
VISCO-895	1	6.286 456
VISCO-895 Package A	1	6.286 457
VISCO-895 Package B	1	6.286 458

Viscosity determination/Viscosimeter

1



B-ONE PLUS

1 2 Viscometers B-ONE PLUS/FIRST PLUS

The rotational viscometer determines the viscosity of liquids by the torque with different measuring spindles. With the B-ONE PLUS, you can determine measurement times for thixotropic products. When entering the density of the product, the kinematic viscosity can also be determined. The viscometer is used mainly in the areas of cosmetics, pharmacy, colour production and chemistry.

Lamy Rheology SARL

Delivery as a single unit or with the spindle sets L1-L4 or R2-R7.

- Measurement at different speeds
- Viscosity range up to 240 000 000 mPas
- 7" touch screen
- Different spindle sets
- Easy to use
- Wide range of applications
- Stable stand
- Display settings: viscosity, speed, torque, measuring time, measurement geometry
- Viscosity unit cp or mPas
- Language French, English, Russian, Spain

FIRST PLUS additionally with:

- PT100 for accurate temperature measurement
- Connections for RS232, USB, LAN
- Software optional

2



FIRST PLUS

Specifications

Rotation speed:	0.3 ... 250 rpm
Torque range:	0.05 ... 13 mNm
Torque range LR versions:	0.005 ... 0.8 mNm
Temperature range FIRST PLUS:	-50 ... 300 °C
Accuracy:	±1 % of full scale
Repeatability:	±0.2 %
Viscosity range B-ONE PLUS with spindles L1 - L4/R2- R7:	15 ... 2 000 000 mPas/100 ... 240 00 000 mPas
Dimensions head (L x W x H):	180 x 135 x 250 mm
Dimensions stand (L x W x H):	280 x 200 x 30 mm
Rod length:	500 mm
Weight:	6.7 kg
Power supply	90-240 VAC, 50/60 Hz

Type	Viscosity range mPas	PK	Cat. No.
B-ONE PLUS LR with L-1 to L-4 spindle set	15 - 22 000 000	1	4.659 126
B-ONE PLUS with R-2 to R-7 spindle set	100 - 240 000 000	1	4.659 127
FIRST PLUS with L-1 to L-4 spindle set	15 - 22 000 000	1	4.659 129
FIRST PLUS with R-2 to R-7 spindle set	200 - 240 000 000	1	4.659 130

Viscometers ViscoQC

These viscometers cover the entire viscosity range with three models: L for low viscosity, R for medium viscosity and H for highly viscous samples.

Anton Paar

- Digital levelling function for verification of the alignment
- Magnetic spindle coupling for a quick exchange of spindles
- Automatic spindle recognition Toolmaster™ prevents errors in spindle selection
- T-Ready™ automatically displays the adjustment of the sample temperature
- Automatic speed search TruMode™ finds the right speed for unknown samples
- Automatic spindle protection detection TruGuard™ for automatic detection of the guard
- Predefined modes/methods: manual mode TruMode™, stop at specific torque/specific temperature
- Data transfer via V-Collect PC software Dymo® LabelWriter™

Scope of supply: Viscometer, Toolmaster™, magnetic coupling, 4 spindles (R and H) or 6 spindles (L) out of AISI 316L, tripod, power supply unit, USB-cable, data collection software V-Collect, printed SOP, instructions

Specifications

Temperature range:	15 ... 80 °C
Accuracy:	±1 %
Repeatability:	±0.2 %
Dimensions (L x W x H):	361 x 281 x 444 mm
Weight:	6.2 kg
Power supply:	100 ... 240 V, 47/63 Hz, 24 V, 3 A

3. Analytical measurement and testing Viscosity determination/Viscosimeter

Viscometers ViscoQC 100

NEW
Anton Paar

- 3.5" colour LC display
- Direct print/export

Type	Viscosity range mPas	Max. torque Ncm	PK	Cat. No.
ViscoQC 100 - L	15 ... 6000000	0.00673	1	6.313 808 1
ViscoQC 100 - R	100 ... 40000000	0.07187	1	6.313 809
ViscoQC 100 - H	800 ... 320000000	0.57496	1	6.313 810



6.313 808

Viscometers ViscoQC 300

NEW
Anton Paar

- 7" colour LC display
- Data memory (up to 999 measurements)
- Print/export from data memory, PDF-export, CSV-table, LIMS page printer (USB or network)
- Predefined modes/methods: stop at specific viscosity, speed/temperature scan
- All methods with QS-Limit-function, instructions
- User, user groups
- Upgradeable software packages (V-Curve and/or V-Comply)

Type	Viscosity range mPas	Max. torque Ncm	PK	Cat. No.
ViscoQC 300 - L	15 ... 6000000	0.00673	1	6.313 811 2
ViscoQC 300 - R	100 ... 40000000	0.07187	1	6.313 812
ViscoQC 300 - H	800 ... 320000000	0.57496	1	6.313 813



6.313 811

3 Viscosimeters ROTAVISC

Viscosimeters with a large range of functions to determine the viscosity of liquids in all areas of application, ranging from laboratory to quality control. The devices are suited for different viscosity ranges and are available with or without controlling software.

IKA

- Highest measurement accuracy
- Stepless speed adjustment
- 4.3" TFT display
- Digital level
- Simple ramp function
- With connection for ext. PT100 sensor

Scope of supply: Viscosimeter incl. standard spindle set, protective bracket, temperature sensor and ROTASTAND stand. ADVANCED models include labworldsoft 6 Visc software for controlling different devices, eg. temperature control systems and other measuring devices

Specifications

Rotation speed:	0.01 ... 200 rpm
Temperature range:	-30 ... +300 °C
Accuracy:	1 %
Repeatability:	0.2 %
Stroke max.:	200 mm
Dimensions stand (L x W x H):	351 x 372 x 629 mm
Weight:	7.1 kg
Power supply:	100 ... 240 V, 50/60 Hz
Protection class acc. to DIN EN 60529:	IP 40

Type	Viscosity range mPas	Torque mNm	PK	Cat. No.
ROTAVISC lo-vi Complete	1 ... 6,000,000	0.0673	1	4.662 322
ROTAVISC me-vi Complete	100 ... 40,000,000	0.7187	1	4.662 323
ROTAVISC hi-vi I Complete	200 ... 80,000,000	1.4374	1	4.662 324
ROTAVISC hi-vi II Complete	800 ... 320,000,000	5.7496	1	4.662 325
ROTAVISC lo-vi Advanced	1 ... 6,000,000	0.0673	1	4.664 317



Viscosity determination/Viscosimeter

1



1 Measuring instrument for viscosity analysis ViscoClock plus

SI Analytics

The ViscoClock plus is an electronic timing unit for glass capillary viscometers used to determine kinematic and relative viscosity. Succeeding the well-proven ViscoClock, the new instrument features data storage and simpler handling. The ViscoClock plus is designed for SI Analytics Ubbelohde (DIN; ASTM; Micro) and Micro Ostwald viscometers. To determine absolute kinematic viscosities, viscometers have to be used which are calibrated for automatic measurements. The ViscoClock plus automatically measures the flow time of temperature-stabilized liquids in capillary viscometers by means of infrared light barriers. The viscometer including a sample is inserted into the ViscoClock plus and immersed into a thermostatic bath for temperature stabilization. After thermostating, the sample is pumped into the measuring bulb, and the flow time is detected automatically. The large display enables easy read-off of flow times and additional information: date, time, sample ID and viscometer ID. The ViscoClock plus can be used in all SI Analytics bath types.

ViscoClock plus: Electronic timing unit for glass capillary viscometers, power supply 100-230 V and manual pump.

ViscoClock plus M1: Device incl. thermostatic bath for temperatures from +10 to +60 °C

ViscoClock plus M2: Device incl. thermostatic bath for temperatures from -40 to +150 °C

Specifications

Measuring range:	Up to 999.99 secs./resolution 0.01 sec.
Timing accuracy:	±0.01 sec. ±1 digit
Measuring range viscosity:	0.35 to 10000 mm ² /sec. (cSt)
USB interface:	For connecting an USB stick or a printer (TZ 3863)
Operating temperature:	Stand: -40 to +150 °C Electronic measuring unit: +10 to +40 °C
Dimensions (W x D x H):	approx. 90 x 30 x 515 mm
Weight:	approx. 450 g (without viscometer) Power pack approx. 220 g

Type	PK	Cat. No.
ViscoClock plus	1	6.285 151
ViscoClock plus M1, 230 V	1	6.272 199
ViscoClock plus M2, 230 V	1	6.272 224

2

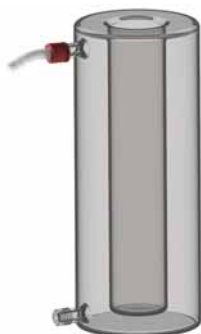

2 Thermostat vessel for ViscoClock plus, DURAN®

NEW

SI Analytics

For tempering of samples in a viscometer, as an alternative to a special glass-panelled bath thermostat. ViscoClock plus has to be connected via hoses to a suitable thermostat bath circulator. For safety reasons, the range of measuring temperatures is restricted to ±15 °C compared to room temperature. The use of an additional magnetic stirrer is recommended.

Specifications

Temperature range:	10 ... 40 °C
Accuracy:	±0.05 K
Tubing olive (diam.):	10.5 mm
Magnetic stirring bar:	approx. 40 mm

Type	PK	Cat. No.
ViscoClock plus VZ 6574	1	6.314 326

We can **supply** this
manufacturer's
whole
product range !



SI Analytics

1 Digital force gauge FK

SAUTER



1

- Robust Push/Pull force gauge for simple measurement.
- Turnable display: automatic direction identification
 - Secure operability due to ergonomic design
 - Peak-hold function to capture peaks (value is "frozen" for approx. 10 seconds) or Track function mode for a continuous measurement indication
 - Selectable measuring units: N, lb, kg, oz
 - Auto-Power-Off
 - Can be mounted on all SAUTER test stands

Specifications

Precision:	0.5 % of Max
Internal measuring frequency:	1000 Hz
Overload protection:	200 % of Max
Thread:	M8
Dimensions (W x D x H):	195 x 82 x 35 mm
Net weight:	approx. 0.72 kg
Power supply:	230 V, 50/60 Hz

Type	Measuring range (max.) N	Readability N	PK	Cat. No.
FK 25.	25	0.01	1	6.270 956
FK 50.	50	0.02	1	6.270 957
FK 100.	100	0.05	1	6.270 958
FK 250.	250	0.1	1	6.270 023
FK 500.	500	0.2	1	6.255 717
FK 1K.	1000	0.5	1	6.270 959

2 Digital force gauge FL-S

NEW
SAUTER



2

Universal digital force gauges with integrated measuring cell.

- Turnable display with backlight
- Can be mounted on all SAUTER test stands
- Metal housing
- Selectable measuring units: N, kN, kg, oz, lb
- Real time or Peak Hold Mode to observe transients or capture peaks
- Capacity display: A bar lights up to show how much of the measuring range is still available
- Measuring with tolerance range (limit-setting function): Upper and lower limiting can be programmed, in pull and push direction. The process is supported by an acoustic and visual signal
- Internal memory for up to 500 measurements
- Continuous analogue output: Linear voltage signal in relation to the load (-2 up to +2 V)

Scope of supply: Digital force gauge, hard carrying case, 3 standard attachments (FL 2K: with external measuring cell, tension loops and pressure plates, without standard attachments)

Type	Measuring range (max.) N	Readability N	PK	Cat. No.
FL 5	5	0.002	1	4.676 244
FL 10	10	0.005	1	4.676 245
FL 20	25	0.01	1	4.676 246
FL 50	50	0.02	1	6.275 873
FL 100	100	0.05	1	4.676 247
FL 200	250	0.1	1	4.676 248
FL 500	500	0.2	1	4.676 249
FL 1K	1000	0.5	1	4.676 250

3 Test stand TVL-XS, manual

NEW
SAUTER



3

The redesigned, superfine spindle enables exact testing in a force-measurement range up to 100 N in particularly fine steps and, in conjunction with the fine-dosing crank, ensures safe, reliable operation. For testing of low levels of force with short distances, such as, testing keyboard overlays, biological samples, blister packs.

- For vertical and horizontal use
- High level of security with repeated measurements
- Large base plate with various holes for fixture mountings
- Suitable for all SAUTER force measuring device up to 100 N (not included with the delivery)

Specifications

Travel distance per knob rotation (one turn):	2 mm
Dimensions (W x D x H):	300 x 250 x 160 mm
Net weight:	4.5 kg

Type	Measuring range (max.) N	PK	Cat. No.
TVL-XS	100	1	4.676 251

Material testing/Hardness measurement

1



Shore D Shore A0 Shore A

1 Shore hardness testers HB/HD

Shore hardness testers for hardness determination of plastics through penetration measurement SAUTER

- Typical application: Measurement of penetration depth (Shore).
- Material thickness of the sample, min. 4 mm
- Particularly recommended for internal comparison measurement. Standard calibrations e. g. to DIN 53505 are not possible because of very narrow standard tolerances
- Can be attached to the test stands TI-AC (for Shore A and Shore A0) and TI-D (for Shore D)

Shore A for rubber, elastomers, neoprene, silicone, vinyl, soft plastics, felt, leather and similar materials

Shore A0 for foams, sponges

Shore D for plastics, formica, epoxides, plexiglass etc.

2



2 Shore hardness testers, analogue, HB

Compact handheld durometer for plastics with drag indicator. SAUTER

- Max mode: Holds the maximum value in the display
- Point mode: Shows one instant value
- Screws to screw on to the TI: M7 fine thread
- Delivered in a plastic carrying case

Specifications

Precision: 3 % of max. measured value
 Dimensions (W x D x H): 60 x 25 x 115 mm
 Net weight: approx. 160 g

Type	Measuring range HS	Readability HS	PK	Cat. No.
HBA 100-0.	100 HA	1,0 HA	1	6.284 083
HBD 100-0.	100 HD	1,0 HD	1	6.270 975

3



3 Shore Hardness Testers, Digital, HD

Compact handheld durometer for plastics with digital display. SAUTER

- Large display with backlight
- Selectable: AUTO-OFF function or continuous operation, charge indicator
- Delivered in a hard carrying case

Specifications

Precision: 1 % of max. measuring value
 Dimensions (W x D x H): 162 x 65 x 38 mm
 Net weight: 173 g

Type	Measuring range HS	Readability HS	PK	Cat. No.
HDA 100-1.	100 HA	1,0 HA	1	4.665 533
HDO 100-1.	100 HAO	1,0 HAO	1	4.665 590
HDD 100-1.	100 HD	1,0 HD	1	4.665 591

4



4.664 627

Hardness comparison plates for Shore hardness testers, HB/HD

SAUTER

Description	PK	Cat. No.
7 plates for Shore A, tolerance up to ±2 HA	1	4.664 627 4
3 plates for Shore D, tolerance up to ±2 HD	1	6.290 428

Leeb hardness tester, mobile

NEW
SAUTER

1

The Leeb hardness tester measures metallic samples and offers mobility and flexibility compared to stationary tabletop devices and testing devices with internal sensor.

- External impact sensor
- All measurement directions possible (360°) thanks to an automatic compensation function
- Internal memory for up to 600 data groups
- Mini statistics function: displays the measured result, the average value, the impact direction, date and time
- Measurement value display: Rockwell (Type A, B, C), Vickers (HV), Shore (HS), Leeb (HL), Brinell (HB)
- Automatic unit conversion: The measuring result is automatically converted into all specified hardness units
- Measuring with tolerance range (limit-setting function): Upper and lower limiting can be programmed
- Acoustic and visual signal
- Matrix display: Backlit multi-function display
- Robust metal housing



4.676 255

Scope of supply:

HK-D: Mobile Leeb hardness tester, hard carrying case

HK-DB: Mobile Leeb hardness tester, hard carrying case, standard block for calibration, hardness approx. 800 HLD

Specifications

Measuring range: 170 ... 960 HL
Readability: 1 HL

Type	PK	Cat. No.
HK-D	1	4.676 255 1
HK-DB	1	4.676 256

2 Digital torque measurement

NEW
SAUTER

2

For torque testing of bottles and other packaging with screw tops. Quick pin system: The four bottle mounts are pushed in, instead of being screwed in, to save time. This allows you to reconfigure quickly for other bottle sizes.

- Can be used in both directions of rotation
- Metal housing
- Capacity display: A bar lights up to show how much of the measuring range is still available
- Peak hold mode to capture peaks
- Function to set limits: Input of an upper/lower limit value
- Visual and acoustic signal
- AUTO-OFF function
- Back-lit LCD graphic display
- Internal data memory saves up to 500 measurements
- Memory contents can be transferred to the PC using optional software
- USB and RS 232 data interfaces
- Rubber feet with anti-slip feature



Scope of supply: Digital torque measurement, four bottle mounts with rubber coat, sturdy carry case

Type	Measuring range	Readability	PK	Cat. No.
DA 1-4	1 Nm	0,0002	1	4.676 253
DA 5-3	5 Nm	0,001	1	4.676 254
DA 10-3	10 Nm	0,002	1	6.285 947

We can supply this
manufacturer's
whole
product range !



Material testing/Surface analysis



6.285 921

USB Hand held microscopes for industry

Dino-Lite

Dino-Lite digital USB microscopes are powerful, portable and easy to use for many different applications in the Industry and for Material Sciences. Most models have a polarizer for working with reflective objects. In addition to the standard white light LEDs, ultraviolet or infrared LED models are available for specific samples and applications.



6.285 934

- USB 2.0, maximum 30 fps
- 1.3 or 5 MP image resolution
- Edge sensor for very low image errors or vignetting
- Extended Depth of Field (EDOF)
- Extended Dynamic Range (EDR)
- Automatic Magnification Reading (AMR)
- Adjustable Polariser
- Flexible-LED-Control (FLC)



4.668 456

Scope of supply: Carrying pouch, Software CD for Windows and Mac OS (not for EDOF, EDR models), calibration slide, manual

Type	Resolution	Magnification	Lighting	PK	Cat. No.
AM4113ZT	1,3 MP	10x ... 70x, 200x	LED, white	1	6.285 921 1
AM4113ZTL	1,3 MP	10x ... 90x	LED, white	1	6.285 926
AM4113T-FV2W	1,3 MP	10x ... 70x, 200x	LED, UV 375 nm, white	1	6.286 111
AM4113T-FVW	*	10x ... 70x, 200x	LED, UV 390/400 nm, white	1	6.285 933
AD4113T-I2V	*	20x ... 220x	LED, 390/400 nm UV + 940 nm IR	1	6.285 934 2
AM4115ZTL	***	10x ... 140x	LED, white	1	6.272 603
AM4515ZT (AMR)	***	20x ... 220x	LED, white	1	6.285 922
AM4515ZT4 (AMR)	***	400x ... 470x	LED, white	1	6.285 931
AM4515T8 (AMR)	*/***	700x ... 900x	LED, white	1	6.285 932
AM4515ZTL (AMR)	***	10x ... 140x	LED, white	1	6.285 927
WF4515ZT (AMR)	**/**	20x ... 220x	LED, white	1	4.668 455
AM4815ZT (EDOF, EDR)	***	20x ... 220x	LED, white	1	6.285 923
AM4815ZTL (EDOF, EDR)	***	10x ... 140x	LED, white	1	6.285 928
WF4915ZT (AMR, EDOF, EDR, FLC)	**/**	20x ... 220x	LED, white	1	4.668 456 3
AM7515MZT (AMR, FLC)	***	20x ... 220x	LED, white	1	6.285 924
AM7515MZTL (AMR, FLC)	***	10x ... 140x	LED, white	1	6.285 929
AM7515MT8A (AMR, FLC)	***	800x ... 900x	LED, white, coaxial	1	4.668 454
AM7915MZT (AMR, EDOF, EDR, FLC)	***	20x ... 220x	LED, white	1	6.285 925
AM7915MZTL (AMR, EDOF, EDR, FLC)	***	10x ... 140x	LED, white	1	6.285 930

*without polarizer
**with WIFI streamer
***Edge



6.285 944

6.275 263

Accessories for USB Hand held microscopes

Dino-Lite

Description	PK	Cat. No.
Table top stand with quick-release incl. extension arm	1	6.285 944 4
Metal stand, vertical and horizontal positioning	1	6.275 263 5



1 Zoom Stereo Microscope SMZ-Series

Convincing optical performance combined with compact footprint and robust mechanics for various industrial applications.

- Greenough Type
- Trinocular head, 45° inclined, 360° rotating
- Fixed optical split 50:50
- Widefield eyepieces WF10X/23 mm, incl. eyecups (SMZ-171), widefield eyepieces WF10X/20 mm, incl. eyecups (SMZ-161)
- Coarse focus, adjustable
- Black/White stage plate (SMZ-171) and dust cover
- Plain stand
- Head holder without light

SMZ-161-TP: 6.1 Zoom ratio, working distance 110 mm
SMZ-171-TP: 6.7:1 Zoom ratio, working distance 110 mm

Accessories and options available on request.

Motic



Type	Description	PK	Cat. No.
SMZ-161-TP	Trinocular	1	6.287 151
SMZ-171-TP	Trinocular	1	7.659 855
60T	LED ring illumination	1	7.655 592

Incident and transmitted light microscopes Panthera TEC MAT

NEW

Motic

Incident and transmitted light microscopes for science materials, inspection of semiconductor components, LCD displays and wafers, equipped with an intelligent brightfield/darkfield illumination concept. The microscope models with additionally integrated LED transmitted light expand the application options in the direction of complex composite materials.

- Tube type Siedentopf, swiveling
- Widefield oculars for spectacle wearers with diopter adjustment on both oculars
- CCIS® Plan Achromat & S-APO (PB free), DIN objectives
- Reversed coded nosepiece
- LED incident light illuminator with field and aperture diaphragm, with slots for polariser/analyser sliders
- With interchangeable illumination
- Motic LightTracer: Light memory, sleep mode (auto on-off), nosepiece LED light intensity and mode indicator
- Coaxial coarse and fine focusing system with tension adjustment
- Integrated power supply with sleep mode
- USB 2.0 for external camera power

Additional equipment depending on the model with bright field (transmitted light), segmentable dark field (reflected light), polarization (reflected light)

Scope of supply: Dust cover, power cord, allen key, screws for metal extension support



4.672 116

Specifications

Inclination Tube:	25°
Angle of rotation Tube:	360°
Eyepieces:	Widefield UC-WF10X/22 mm
Nosepiece:	Quintuple
Objectives:	5X/0.13 (AA 20.3 mm), 10X/0.25 (AA 17.5 mm), 20X/0.40 (AA 8.1 mm), S-Apo 50X/0.80 (AA 1 mm)
Interpupillary distance:	48 ... 75 mm
Condenser:	LED condenser
Illumination:	3 W LEDs
Fine focus increment:	2 µm
Focusing stroke:	25 mm
Dimensions Stage (W x D):	300 x 180 mm
Dimensions (W x D x H):	410 x 300 x 450 mm
Net weight:	10.4 kg
Power supply:	110 ... 240 V, 50/60 Hz

Type	Description	PK	Cat. No.
TEC MAT BF	Trinocular, incident light	1	4.672 116 2
TEC MAT BF-T	Trinocular, incident / transmitted light	1	6.311 821

1



1 Polarisation microscope Panthera TEC POL

NEW

Motic

Powerful polarisation microscope for all material sciences. Maximum flexibility for all applications in polarisation microscopy, suitable for transparent as well as opaque samples from the education sector and industrial quality assurance.

- Tube type Siedentopf, swiveling
- Widefield oculars for spectacle wearers with diopter adjustment on both oculars
- CCIS® Plan achromatic objectives UC PL (strain-free)
- Reversed coded nosepiece with single centering holes
- Bertrand lens and slot for compensators
- Focusable and centerable Achromat Swing-out Abbe condenser N.A. 0.90/0.13 (strain-free) and rotatable polariser
- Illumination acc. to Köhler, with interchangeable illuminator
- Motic LightTracer: Light memory, sleep mode (auto on-off), nosepiece LED light intensity and mode indicator
- Coaxial coarse and fine focusing system with tension adjustment
- Compact, built-in mechanical stage
- Integrated power supply with sleep mode
- Visual camera output
- USB 2.0 for external camera power

Scope of supply: Microscope, dust cover, power cord, Allen key, blue filter, halogen bulb, LED module, adjustable key for nosepiece, interference color chart, screws for metal extension support

Specifications

Inclination Tube:	25°
Angle of rotation Tube:	360°
Eyepieces:	Widefield UC-WF10X/22 mm
Nosepiece:	Quintuple
Objectives:	4X/0.1 (AA 30.5 mm), 10X/0.25 (AA 17.4 mm), 40X/0.65/S (AA 0.6 mm), 60X/0.8/S (AA 0.35 mm)
Interpupillary distance:	48 ... 75 mm
Trinocular light split:	Fixed 50:50
Condenser:	N.A. 0.90/0.13 Abbe-Condenser
Illumination:	3 W LEDs/30 W Halogen
Fine focus increment:	2 µm
Focusing stroke:	25 mm
Dimensions Stage (W x D):	1 increment, 0.1 skale
Stage size (Ø):	160 mm
Dimensions (W x D x H):	410 x 300 x 395 mm
Net weight:	9.8 kg
Power supply:	110 ... 240 V, 50/60 Hz

Type	Description	PK	Cat. No.
TEC POL	Trinocular	1	4.672 117

2



2 Drying pads Grade 556Z

For retaining specimen visibility (50 sheets).

Whatman

Width mm	Length mm	PK	Cat. No.
37	100	1	9.069 003

3



3 Microscope Cleaning Kit

Content: 1 power blower, cotton swabs, cleaning liquid, cleaning cloth, lens cleaning paper, retractable brush

Motic

Type	PK	Cat. No.
Mikroskope Cleaning Kit	1	6.280 087

3. Analytical measurement and testing Analytical instruments and systems/Melting point determination

Melting point meters LLG-uniMELT 2 und 3

Ideal for determination of the melting point of powders up to 360 °C and substances that do not have a clear transparent melting point.

Both devices have a USB interface that permits printing a measuring protocol or generating a PDF file that corresponds to the demands of a contemporary QMS documentation.

Properties for both models:

- Digital temperature control on large display
- Selectable user language German or English
- Sample can be monitored through a magnifying glass with integrated light
- For capillaries with 1.4mm outer diameter
- Text display of error messages
- Keyboard covered with foil for easy cleaning
- USB port
- Height adjustable table stand
- Operating instructions in German, English, Spanish, French and Russian.
- Brief instructions right at the device
- Up to 3 measurements could be stored and printed as protocol at the same time
- The protocol contains all the relevant data of the probe, the measurement and the device

LLG-uniMELT 2: For visual, semi-automatic measurement with magnifying glass. In this model, the melting point is determined visually (max. and then saved by pushing the "Save" key. The value can be printed or stored by pushing the memory button and read on the display until the device is switched off or a new measurement is performed.

LLG-uniMELT 3: For visual measurement with magnifying glass or automatic measurement. Either fully automatic or visual measurements, 1 sample each. If you chose automatic measurement, additionally a transparency progression is printed. For visual measurement, only the melting point determined by you will be printed. The value can be stored by pushing the memory button and read on the display until the device is switched off or a new measurement is performed.

Scope of supply: Melting point meter, table stand, 100 melting point tubes, protection hood, USB-cable, Software. Refill pack melting point tubes for LLG-uniMELT please order Cat. No. 9.208 131.

Specifications

Measuring range:	25.0 °C ... 360.0 °C
Resolution:	0.1 °C
Accuracy:	±0.4 °C
Reproducibility:	±0.3 °C
Heating rate at fast heating:	to 200 °C approx. 4 min; to 350 °C approx. 8 min
Heating rate when measuring:	1 °C/min
Magnifying glass:	20 dpt/3 x
Lighting:	2 x LED
Dimensions housing (W x D x H):	230 x 65 x 260 mm
Dimension table stand (W x H):	85 x 55 mm
Dimensions capillaries:	1.45 x 80 mm
Weight:	4.0 kg
Power supply:	88 ... 264 V, 50 Hz
IP code:	IP 20
Warranty:	3 years



6.263 685



6.263 686

Type	Description	PK	Cat. No.
LLG-uniMELT 2	Visual measuring / magnifier	1	6.263 685 1
LLG-uniMELT 3	Visual or automatical measuring	1	6.263 686 2
Melting point tubes	Sealed one end, length 80 mm, OD 1.45 mm	100	9.208 131

Further products can be found in our online shop.

3 Melting point Standards

High Purity range compatible with all Melting Point Instruments. Tested on a high specification melting point apparatus. Available as Single Melting Point Standard or as a Set of 3 different Standards. Glass bottles of 1 g. Sets include 3 bottles of 1 g.

Reagecon



Warning

H phrases: H302

Type	Description	PK	Cat. No.
RMP048	Benzophenone +47 to +49 °C	1	6.260 428
RMP082	Vanillin +81 to +83 °C	1	6.286 189
RMP236	Caffeine +235 to +237 °C	1	6.261 675
RMPSET1	Sulphanilamide, Caffeine, Vanillin	3	6.259 500



1 2 Melting point apparatus, Electrothermal IA 9100/9200/9300



The updated and improved IA9000 Series Digital Melting Point Apparatus offers an easy way to measure the melting points of up to 3 samples simultaneously without sacrificing accuracy; the temperature resolution is within 0.1 °C. The starting temperature of the approximate melting range can easily be input via the membrane keypad using the simple intuitive menus. The unit quickly heats up to this temperature and gives an optical and acoustic signal once it has been reached. When the operator then presses another key, the device begins to heat up at a constant rate (IA 9100 fixed at 1 °C/min., IA 9200 and IA 9300 adjustable between 0.2 to 10 °C/min. in increments of 0.1 °C).

Electrothermal

Up to 4 melting points (IA 9300 up to 6 melting points) can be recorded and transferred to the memory as discreet temperatures for later recall on the display. Model IA 9200/9300 provides the opportunity for computer-supported data analysis. An accessory printer enables documentation of the results, date, time (real time) and sample number.

- Ergonomic design ideal for multiple users.
- Height-adjustable extension arm and a viewing head that may be rotated to suit each user.
- The viewing head holds a viewing magnifier that offers 8X magnification.
- The extension arm is completely collapsible and can be neatly folded away into the unit, so that the unit can be stored flat to save space.
- Each IA9000 series model comes supplied with a pack of 50 capillary tubes.

2



Dimensions (W x D x H):	200 x 350 x 85 mm
Weight:	2.5 kg
Input:	220 -240 V
Output:	15 V
Power:	45 W
Oven chamber illumination:	3 x white Super Flux LED's
Illuminous Intensity (per LED):	3500 Lux
Oven temperature range:	5 to 400°C
Digital thermometer sensor:	Platinum resistance thermometer (PT100)
Measuring range:	Amb. to 400 °C
Resolution:	0.1 °C
Accuracy:	±0.5°C at 20°C linearly to ±1.0°C at 350°C
Display:	12 x 2 backlit matrix LCD

Type	PK	Cat. No.
IA 9100	1	9.830 441
IA 9200	1	9.830 442
IA 9300	1	9.830 443
Capillary tubes, 1.5 mm Ø	100	9.830 463
Cold finger	1	9.830 445
Capillary tubes, 2.0 mm Ø	100	9.830 447
Printer with connection cable	1	9.830 448

3 Melting point apparatus, model SMP10/SMP20



Supplied with 100 melting point tubes, open one end.
With BioCote, silver-based, antimicrobial protection.

Stuart

Specification	SMP10/SMP20
Number of samples:	2
Temperature range:	Ambient to 300°C
Temperature accuracy:	±1.0°C at 20°C, ±2.5°C at 300°C
Display:	Three digit LED/Four digit LED
Display resolution:	1°C/0.1°C
Display hold facility:	No/ Yes
Ramp rates:	20°C per minute to plateau, 2°C per minute to melt/20°C per minute to plateau, variable between 1 and 10°C per minute to melt
Dimensions (w x d x h):	160 x 220 x 170mm
Net weight:	1.8kg
Electrical supply:	230V, 50Hz, 75W

Type	PK	Cat. No.
SMP10	1	9.950 177
SMP20	1	9.830 430

1 Melting Point Meter M5000

For powdery substances with a melting point up to 400 °C. A fan cooling allows fast measurements in every range of temperature. The display provides a clearly-arranged readout of all important measuring data.

- Fully automatic measurement by means of transmission optics
- 1 capillary intake
- LCD display
- Alarm signal when reaching the melting point
- Fast cooling through integrated fan
- Digital display of all important data
- Display in German or English
- With RS-232 interface for printer CBM910
- Easy-to-clean membrane keypad

Scope of supply: Melting Point Meter, protective cover, 100 capillaries

Specifications

Temperature range:	25 ... 400 °C
Resolution:	0.1 °C
Accuracy:	±0.3 °C (25 ... 200 °C) ±0.5 °C (200 ... 400 °C)
Preheating rate:	up to 300 °C approx. 4.0 min up to 400 °C approx. 7.5 min
Heating rate:	1 °C min ⁻¹
Capillary-Ø:	1.4 mm
Capillary intake:	1
Dimensions (W x D x H):	220 x 340 x 150 mm
Weight:	4.1 kg
Power supply:	90 ... 264 V
IP code:	IP20

Type	PK	Cat. No.
M5000	1	6.264 452

A.KRÜSS Optronic



1

2 Melting Point Meter M3000

The M3000 provides fast and easy examination of powdery substances with a melting point up to 360 °C. Due to the triple capillary intake, it is possible to analyse three samples within one measurement run. Thanks to the preheating rate and the integrated fan cooling, fast measurements are possible in any temperature range.

- Semi-automatic measurement by means of 10x magnification optics
- 3 capillary intakes
- LCD display
- Monitoring of the illuminated sample via lens
- Fast cooling through integrated fan
- Digital display of all important data
- Display in German or English
- With RS-232 interface for printer CBM910
- Easy-to-clean membrane keypad

Scope of supply: Melting Point Meter, protective cover, 100 capillaries

Specifications

Temperature range:	30 ... 360 °C
Resolution:	0.1 °C
Accuracy:	±0.3 °C (30 ... 200 °C) ±0.5 °C (200 ... 360 °C)
Preheating rate:	up to 300 °C approx. 4.0 min up to 360 °C approx. 7.5 min
Heating rate:	1 °C min ⁻¹
Capillary-Ø:	1.4 mm
Capillary intake:	3
Dimensions (W x D x H):	210 x 230 x 360 mm
Weight:	4.3 kg
Power supply:	90 ... 264 V
IP code:	IP20

Type	PK	Cat. No.
M3000	1	4.661 671

A.KRÜSS Optronic

NEW

2





1 Automatic Melting Point Apparatus, SMP50

Accurately and reliably determining the melting point of up to three samples simultaneously. *Stuart*

The SMP50 has a custom designed user interface based on an established Android platform for intuitive setup and navigation. All operation is via the 7" colour touchscreen. Once programmed, users can leave the SMP50 to complete the melt analysis independently, alternatively the melt can also be observed on the screen live or post melt. During post melt review additional measurement tags can be added if required, such as meniscus point or the automatically obtained result can be overwritten.

A generous 8 GB on board storage is included, which should comfortably hold approximately 300 melts files including videos. Results can also be transferred via USB stick on to PC or can be printed directly from the unit via the accessory printer.

The SMP50 features a useful storage drawer to house all standard capillary tubes.

All units are factory supplied with a calibration certificate showing individual serial number for traceability. The SMP50 also conforms to Pharmacopeia and GLP.

Specifications

No of samples:	3 simultaneously
Temperature range:	Ambient to 400 °C
Temperature resolution:	0.1 °C
Display:	7" HD Colour
Ramp rates:	0.1 to 20 °C in 0.1 °C increments
Temperature sensor:	PT1000 Platinum resistance
Memory:	8 GB (approx. 300 results with video)
Cool down time:	350 to 50 °C (approx. 12 min)
Heat up time:	50 to 350 °C (approx. 6 min)
Data transfer:	USB Flash drive
Sample level:	2 to 3 mm in 50 mm or 100 mm length capillaries
Weight:	4.6 kg
Power supply:	120-230 V, 50/60 Hz



Type	PK	Cat. No.
SMP50	1	6.270 572
Melting point tubes, closed at one end	100	6.803 067
Glass melting point tubes, closed at both ends	100	9.950 400
Printer SMP50	1	6.283 461

2 Melting point tubes

Capillary tubes for melting point analysis. Clear glass, different diameters and lengths. Special remarks are available. Other sizes on request.

Type	Ext. diam. mm	Int. diam. mm	Length mm	Material	PK	Cat. No.
Sealed one end	1.00	0.80	80	Duran®	100	9.208 081
Open both ends	1.00	0.80	80	Duran®	100	9.208 080
Sealed one end	1.00	0.80	100	Duran®	100	9.208 101
Open both ends	1.00	0.80	100	Duran®	100	9.208 100
Sealed one end	1.45	1.00	80	Soda glass	100	9.208 131
Closed both ends	1.50	0.90	100	Soda glass	100	9.830 463
Sealed one end	1.55	1.15	75	Soda glass	100	9.208 076
Closed both ends	2.00	1.50	100	Soda glass	100	9.830 447
Sealed one end	1.55	1.15	80	Soda glass	100	6.055 754
Sealed one end	1.35	0.95	80	Soda glass	100	6.059 475
Open both ends	1.35	0.95	60	Soda glass	100	6.074 178
Sealed one end	1.35	0.95	100	Soda glass	100	6.078 107
Open both ends	1.35	0.95	80	Soda glass	100	6.207 066
Open both ends	1.35	0.95	75	Soda glass	100	6.207 196
Open both ends	1.00	0.80	120	Soda glass	250	6.264 147
Open both ends	1.55	1.15	100	Soda glass	100	7.602 577
Melting point tubes	1.78	1.15	80	Soda glass	100	9.830 053
Melting point tubes	1.78	1.15	80	Soda glass	1000	9.830 054



3 Hot bench, Kofler system

Very easy to use. Various characteristics can be observed simultaneously. Linear temperature scale adjustment. Enables quick identification of organic substances. Supplied with test and standard material sets. CE marked. *Wagner & Munz*

Dimensions (W x D x H):	430 x 100 x 140mm
Supply requirements:	230 V/50 Hz, 100 W
Temperature range:	+50 to +260 °C

Type	PK	Cat. No.
Hot bench	1	9.830 160

Magnetic stirrers / Hotplates	448
Without heating, with motor.....	448
Without heating, cable free	460
With heating and motor.....	461
Accessories, Magnetic stirring bars.....	475
Overhead stirrers	478
Instruments.....	478
Stirrer Heads	489
Stirrers	491
Shakers and mixers	497
Vortexer	497
Orbital shakers.....	505
Reciprocating shakers	515
Rocking shakers	518
Tumbling shakers	522
Thermoshakers	527
Overhead shakers.....	533
Roller mixers.....	537
Microtitre plate shakers	539

4. Stirring, Shaking, Mixing

Magnetic stirrers / Hotplates/Without heating, with motor

IP Protection classes

IP	Characteristic 1 for special protection	IP	Characteristic 2 for waterproofing
0	No special protection	0	No waterproofing
1	Protection from solid objects greater than 50 mm in diameter	1	Protection from dripping water
2	Protection from object greater than 12 mm in diameter	2	Protection from vertically dripping water (tilted up to 15°)
3	Protection from object greater than 2.5 mm in diameter	3	Protection from sprayed water (tilted up to 60°)
4	Protection from object greater than 1 mm in diameter	4	Protection from splashed water
5	Complete protection against contact, Protection against dust deposit	5	Protection from water projected from a nozzle
6	Complete protection against contact, Protection from infiltration of dust	6	Protection against heavy seas or powerful jets of water.
		7	Protection against immersion
		8	Protection against complete, continuous submersion in water.
		9	Protection against the ingress of water from all directions even under greatly high pressure on the housing. (High-pressure/steam cleaner, 80-100 bar)

IP 64

IP 64 { 6: Complete protection against contact, Protection from infiltration of dust
4: Protection from splashed water

1



1 Magnetic stirrer LLG-uniSTIRRER 2

Compact and cost-efficient magnetic stirrer without heating for volumes up to 1000 ml. Adjustable speed from 0 to 2000 rpm. Plate diameter 120 mm. Body made of ABS.

Support rod, aluminium (Cat. No. 6.263 435) available as an optional accessory.

Scope of supply: magnetic stirrer, mains adapter, 2 stirring rods 27 x 8mm and 34 x 8mm

Specifications

Stirring quantity (H ₂ O):	1000 ml
Speed range:	0 ... 2000 min ⁻¹
Permissible ambient temperature:	0 ... 50 °C
Magnetic bar:	25 x 8 mm
Display:	Analog
Heating plate:	120 x 120 mm
Dimensions (W x D x H):	150 x 135 x 53mm
Weight:	0.5 kg
Power supply:	100 ... 230 V, 50/60 Hz
IP code:	IP 21
Warranty:	3 years

Type	Plug type	PK	Cat. No.
LLG-uniSTIRRER 2	EU	1	6.263 430
LLG-uniSTIRRER 2	UK	1	6.263 431

2



2 Magnetic mini-stirrers topolino

Without heating. Extremely convenient magnetic mini-stirrer for mixing volumes up to 250ml.

- Durable, brushless motor
- Infinitely variable speed range
- Strong magnetic coupling

Specifications

Stirring quantity max. (H ₂ O):	250 ml
Speed range:	300 ... 1800 rpm
Permissible ambient temperature:	5 ... 40 °C
Permissible relative humidity:	80 %
Material:	PP
Dimensions Top plate (Ø):	80 mm
Dimensions (W x H x D):	95 x 37 x 115 mm
Weight:	0.32 kg
Power supply:	100 ... 240 V, 50/60 Hz
IP code:	IP 21

Type	Plug type	PK	Cat. No.
Topolino	EU/CH	1	9.720 220

4. Stirring, Shaking, Mixing

Magnetic stirrers / Hotplates/Without heating, with motor

1 Magnetic stirrer MST Digital

Small, lightweight magnetic stirrer for volumes up to 5 l. Ideal for titrations, BOD determination, microbiological and biochemical applications.

Velp Scientifica

- Bright LED display
- The device remains cold even in continuous use
- Timer
- Very good chemical resistance
- Torque compensation to keep the speed constant in case of viscosity changes
- Auto reverse function

Specifications

Volume (H ₂ O):	5 l
Speed (max.):	1500 min ⁻¹
Display:	Digital
Timer:	1 ... 900 min
Auto reverse:	5 ... 900 s
Dimensions (W x D x H):	120 x 145 x 50 mm
Weight:	0.6 kg
Power supply:	100 ... 240 V, 50/60 Hz
Warranty:	3 years

Type	PK	Cat. No.
MST Digital	1	4.666 683



2 Magnetic stirrer Mini MR standard

Without heating.

- For stirring quantities up to 1L (H₂O).
- Infinitely variable speed from 0 to 2500rpm
- White top plate suitable for observing colour reactions
- Power supply with adapter for EU/CH/UK/USA

Specifications

Max. stirring volume, (H ₂ O):	1 l
Speed range:	0 ... 2500 rpm
Permissible ambient temperature:	5 ... 40 °C
Permissible relative moisture:	80 %
Plate material:	Polyester film
Top plate dimensions (W x D):	115 x 115 mm
Overall dimensions (W x D x H):	115 x 129 x 37 mm
Weight:	0.25 kg
Supply requirements:	100 ... 240 V, 50/60 Hz
Protection to DIN EN 60529:	IP42
Tested to DIN EN IEC 61010-1.	

Type	Plug type	PK	Cat. No.
Mini MR standard	EU/CH/UK/USA	1	9.720 211

3 Magnetic stirrer Hei-Mix

Without heating. Suitable for titration.

Heidolph

- Stir quickly and efficiently with an extended speed range up to 2200rpm
- Long-lasting polyamide housing and PVDF top plate material
- Ideal for titrations due to white-colored top plate
- Space saving unit for efficiently mixing sample sizes up to 5l. Small footprint of 126 x 80 x 140mm (W x H x D) only, and the top plate comes with a diameter of 104mm
- Powerful stirring magnet for safe rotation of the stirring bar even with more viscous solutions

Specifications

Stirring quantity (H ₂ O):	5 l
Speed range:	0 ... 2.200 rpm
Permissible ambient temperature:	5 ... 31 °C
Permissible relative moisture:	80 %
Plate Material:	PVDF
Plate Dimensions (Ø):	104 mm
Dimensions (W x D x H):	126 x 140 x 80 mm
Weight:	1.1 kg
Power supply:	230 V
Protection class:	IP 21

Type	Plug type	PK	Cat. No.
Hei-Mix S	EU	1	9.720 167
Hei-Mix S	UK	1	6.201 570



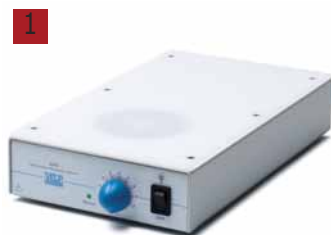

1 Magnetic stirrer AMI, illuminated

Magnetic stirrer with illuminated stirring position for stirring volumes up to 5 l. With epoxy-coated metal housing for protection against liquid spills.

Velp Scientifica

- Gentle start-up
- Illuminated stirring position
- Electronic speed control up to 1100 min⁻¹
- Low height

Specifications

Max. volume (H ₂ O):	5 l
Motor rating:	1.2 W
Max. speed:	1100 min ⁻¹
Weight:	1.2 kg
Dimensions (W x D x H):	150 x 270 x 55 mm
Power supply:	100 ... 240 V, 50/60 Hz
Warranty:	3 years

Type	Plug type	PK	Cat. No.
AMI	EU	1	4.666 684



2 Magnetic stirrer myPlate

The magnetic stirrer myPlate combines the excellent technical features of the magnetic stirrers colour squid and big squid with the option of creative individualisation. Thanks to the interchangeable frame the image template provided can be exchanged easily through a personal image.

IKA

Specifications

Stirring volume (H ₂ O):	1.5 l
Speed range:	0 ... 2000 rpm
Permissible ambient temperature:	5 ... 40 °C
Permissible relative humidity:	80 %
Material:	Glass
Dimensions Top plate (Ø):	135 mm
Dimensions (W x D x H):	150 x 160 x 30 mm
Weight:	500 g
Supply requirements:	100 ... 240 V
Protection class acc. to DIN EN 60529:	IP 54

Type	PK	Cat. No.
myPlate	1	4.665 612



Magnetic stirrer SS151/CS151

Without heating. Stirrers with powerful magnets and motor for mixing large volumes. With LED display indicating the set and actual speed of the unit.

NEW

Stuart

- Spill-resistant front control panel with a chemically toughened glass for extra resilience
- With an integral fixing point for a retort rod
- With BioCote, silver-based, antimicrobial protection

Scope of supply: Stirrer, 2 x 25 mm PTFE coated stirring bars

Specifications

Max. stirring capacity (H ₂ O):	15 l
Speed:	50 ... 1400 rpm // 50 ... 1250 rpm
Permissible ambient temperature:	5 ... 40 °C
Permissible relative humidity:	<80 %
Top plate dimensions (W x D):	150 x 150 mm // 120 x 120 mm
Overall dimensions (W x D x H):	180 x 300 x 93 mm
Weight:	2.3 kg
Power supply:	230 V, 50/60 Hz

Type	Material stirring surface	Colour housing	PK	Cat. No.
SS151B	Aluminium, ceramic coated	Blue	1	4.672 493
SS151K	Aluminium, ceramic coated	Black	1	4.672 494
SS151W	Aluminium, ceramic coated	White	1	4.672 495
CS151B	Glass ceramic	Blue	1	4.672 496
CS151K	Glass ceramic	Black	1	4.672 497
CS151W	Glass ceramic	White	1	4.672 498

4.672 495



4.672 497

4. Stirring, Shaking, Mixing

Magnetic stirrers / Hotplates/Without heating, with motor

1 Magnetic stirrer for cell cultures with external control, bioMIXdrive 1/2/3/4

Maintenance free motor drive. Magnetic stirrer with 1/2/3/4 stirring positions, for careful, protective and warming-free mixing of cell cultures and culture broths, also for viscous cultures, maintenance-free, large surface. 100 % jerk-free, speed range 5rpm to 250 rpm, encapsulated stainless steel housing, water-, dust-, germproof, IP 68, submersible, easy to clean, robust construction, flat design, suitable for propeller and spinning ball culture flasks, individual measurement on request. 3 years warranty. Made in Germany. Suitable for underwater use.
Please order control unit separately.

2mag



Specifications

Max. stirring quantity (H₂O): 5 l
 Speed: 5 ... 250 min⁻¹
 Permissible ambient temperature: -10 up to +50 °C at 100 % H.R. max.
 +50 °C submerged in water
 Housing: Stainless steel
 Protection class: IP 68

Type	Stirring positions	Dimensions (W x D x H)	Weight	PK	Cat. No.
		mm	kg		
bioMIXdrive 1	1	180 x 180 x 38	2.5	1	9.645 950
bioMIXdrive 2	2	130 x 270 x 38	2.5	1	9.645 978
bioMIXdrive 3	3	130 x 410 x 38	3.5	1	9.645 979
bioMIXdrive 4	4	270 x 270 x 38	4.7	1	9.645 980

Control units for stirring drives bioMIXdrive

bioMIXcontrol
 Control unit for 1x bioMIXdrive 1/2/3/4, speed range 5 rpm to 250 rpm.

2mag

bioMIXcontrol S
 Identical to bioMIXcontrol, but with stackable housing and vertical control panel.

bioMIXcontrol MS4
 Identical to bioMIXcontrol, but for 4x bioMIXdrive 1, individual and independent speed setting for each stirring drive, synchronous speed mode for all drives with one touch.



9.645 981

Specifications

Operation conditions: 0 ... 40 °C at 80 % H.R. max.
 Operating voltage: 100-240 V 50/60 Hz, 1.5 A
 Housing: Stainless steel
 Protection category: IP 20

Type	PK	Cat. No.
bioMIXcontrol	1	9.645 951
bioMIXcontrol S	1	9.645 981
bioMIXcontrol MS4*	1	9.645 982

* only for bioMIXdrive 1



9.645 982

4 Magnetic stirrer MIX 1 XL

Wear-free 2mag motor drive, powerful, up to 40 liters, 70-2000 rpm, internal controller with 20 watts, incl. mixWATCH stirring bar monitoring with fully automatic trim of the max. Reachable speed for reliable and unattended operation, digital display, 4-step power setting for high power with regard to large and viscous media and reduced power for warming-free continuous operation, adjustable SoftStart for different volumes/viscosity, QuickStop against after-run and breakage, reliable sealed stainless-steel housing, 3 years warranty. Made in Germany.

2mag



Specifications

Operating conditions: -10°C to +50 °C at 95 % R.H. max.
 Housing: Stainless steel
 IP code: IP 64

Type	PK	Cat. No.
MIX 1 XL	1	6.236 109

4. Stirring, Shaking, Mixing

Magnetic stirrers / Hotplates/Without heating, with motor

Magnetic stirrers C-MAG MS 4/C-MAG MS 7/C-MAG MS 10

Without heating. With glass ceramic top plate which offers excellent chemical resistance.

IKA

- powerful motor for stirring quantities of up to 5l, 10l, or 15l (H₂O)
- raised control panel for protection against leaking liquids

Specifications

Magnetic stirrer

Stirring volume max. (H₂O)

C-Mag MS 4/MS 7/MS 10: 5l/10l/15l

Motor rating input/output: 15/1.5W

Speed range: 100 to 1500rpm

Speed display: scale

Max. magnetic bar (L x dia.)

C-MAG MS 4: 30 x 8mm

C-MAG MS 7/MS 10: 80 x 10mm

Set-up plate

Material: glass ceramic

Dimensions (W x D)

C-MAG MS 4: 100 x 100mm

C-MAG MS 7: 180 x 180mm

C-MAG MS 10: 260 x 260mm

Dimensions (W x D x H)

C-Mag MS 4: 150 x 260 x 105 mm

C-Mag MS 7: 220 x 330 x 105 mm

C-Mag MS 10: 300 x 415 x 105 mm

Weight

C-Mag MS 4/MS 7/MS 10: 3kg/5kg/6kg

Protection class acc. to DIN EN 60529: IP 21

Tested to DIN EN IEC 61010-1.

Type	Plug type	PK	Cat. No.
C-MAG MS 4	EU	1	9.720 493 1
C-MAG MS 7	EU	1	9.720 494 2
C-MAG MS 10	EU	1	9.720 495 3



9.720 493



9.720 494



9.720 495



4 Magnetic stirrer Hei-Mix L

Without heating. For heat-sensitive samples, because the top plate is insulated from the motor.

Heidolph

- Gentle and protective treatment of samples due to smooth start function
- Hermetically-sealed housing prevents corrosion and increases the service life of the unit
- When working with dry ice a robust thermal insulation prevents corrosion inside the housing which prohibits dripping of condensate on the electronic components
- Due to the Kera-Disk® ceramic coating, the top plate is chemical-resistant and scratch-proof

Specifications

Stirring quantity (H₂O): 20 l
 Speed range: 100 ... 1.400 rpm
 Permissible ambient temperature: 5 ... 31 °C
 Permissible relative moisture: 80 %
 Plate Material: Kera-Disk®
 Plate Dimensions (Ø): 145 mm
 Dimensions (W x D x H): 173 x 277 x 94 mm
 Weight: 2.9 kg
 Power supply: 230 V
 IP code: IP 32

Type	PK	Cat. No.
Hei-Mix L	1	9.720 137

1 Multi-position Magnetic stirrer AMI 4, illuminated

Multi-position magnetic stirrer with illuminated stirring positions for stirring volumes up to 5 l per position. With epoxy-coated metal housing for protection against liquid spills.

Velp Scientifica

- 4 stirring positions
- Gentle start-up
- Illuminated stirring positions
- Electronic speed control up to 1100 min⁻¹
- Low height

Specifications

Stirring volume each (H ₂ O):	5 l
Motor rating:	4.8 W
Speed (max.):	1100 min ⁻¹
Number of stirring positions:	4
Distance between stirring positions:	150 mm
Display:	Analog
Dimensions (W x D x H):	600 x 270 x 55 mm
Weight:	4.0 kg
Power supply:	100 ... 240 V, 50/60 Hz
Warranty:	3 years

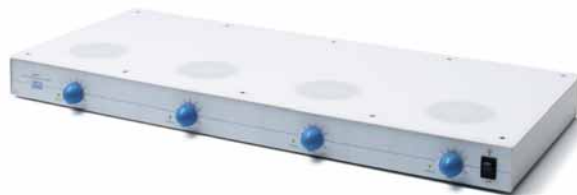

Type	Plug type	PK	Cat. No.
AMI 4	EU	1	4.666 685

2 Multi-position magnetic stirrers RO 5/10/15 series

Without heating. 5, 10 or 15-position digital magnetic stirrers, designed for synchronous stirring. The magnetic coil technology provides noiseless and consistent stirring on all positions. Speed remains constant, even when load changes. The closed and compact design allows easy cleaning and protects the equipment against the penetration of liquids. Additionally, a removable transparent anti-slip mat is included.

IKA

- Adjustable reverse operation
- Eco-mode for a low self-warming of the surface
- Wear free magnetic coils
- Error Code Display
- Easy operation with touch keypad
- Suitable for continuous operation
- Adjustable speed in increments of 10rpm

Specifications

Max. stirring quantity per stirring position (H ₂ O):	0.4l
Distance between stirring places:	90mm
Deviation for individual stirring positions:	0%
Speed range:	0 to 1200rpm
Speed display:	LED line
Set-up plate material:	stainless steel 1.4301
Protection class acc. to DIN EN 60529:	IP 40
Power supply:	100-240V, 50/60Hz



9.720 208



9.720 226

Type	Stirring positions	Dimensions (W x D x H)	Weight	PK	Cat. No.
		mm	kg		
RO 5	5	120 x 570 x 60	3	1	9.720 208
RO 10	10	190 x 570 x 60	5	1	9.720 222
RO 15	15	280 x 570 x 60	7	1	9.720 226

4 Bath tanks for multi-position magnetic stirrers RO 15

NEW

Type	Description	PK	Cat. No.
IB R RO 15 pro	Stainless steel bath vessel	1	4.672 783
IB R RO 15 eco	Plastic bath vessel, max. 100 °C	1	6.283 206



6.283 206



1 Magnetic stirrer LLG-uniSTIRRER 1

An **ultra-flat** inductive magnetic stirrer without heating with timer. The modern magnet coil technology consists only of non-moving parts and therefore guarantees a wear-free drive.

For a better mixing of samples it is possible to change the direction of rotation every 30 seconds.

- **Timer** (1 min to 99 min, infinitely)
- 100 % wear- and maintenance-free inductive drive
- LED-display for an exact adjustment of the rotation speed
- Digital regulated rotation speed
- Alteration of the stirring direction
- Protection class IP 65
- Stainless steel surface

Delivery includes: magnetic stirrer, power cable, adapters for UK and universal plug.

Specifications

Stirring positions:	1
Stirring quantity (H:O):	0.8 l
Speed range:	15 ... 1500 min ⁻¹
Permissible ambient temperature:	5 ... 40 °C
Magnetic bar:	max. 25 mm
Display:	LED
Heating plate:	Ø 94 mm
Dimensions (W x D x H):	110 x 155 x 12 mm
Weight:	0.5 kg
Power supply:	100 ... 230 V, 50/60 Hz
IP code:	IP 65
Warranty:	3 years

Type	Plug type	PK	Cat. No.
LLG-uniSTIRRER 1	Universal	1	6.263 420



Magnetic stirrers, lab disc

Without heating. Lab disc is an innovative, very flat, magnetic stirrer. It's modern, toroidal coil technology with no moving parts guarantees a maintenance-free drive. Lab disc can automatically change it's rotational direction every 30secs. and therefore enhances mixing of the medium.

IKA

- High IP protection class (IP 65)
- Set-up plate and casing made from chemically resistant materials
- Slip-proof, safe stand
- lab disc white with white surface, lab disc stream and lab disc pattern with decorative surface

Specifications

Max. volume stirred (H ₂ O):	0.8 l
Motor rating input/output:	5W/3W
Speed range:	15rpm to 1500rpm
Stirring bar length max.:	25mm
Set-up plate material:	polyester
Set-up plate dimensions:	Ø 100mm
Dimensions (W x H x D):	117mm x 12mm x 180mm
Weight:	0.3 kg
Permissible ambient temperature:	5°C to 40°C
Permissible relative humidity:	80%
IP code	IP 65
Voltage/Frequency	100V - 240V/50/60Hz

Type	Plug type	PK	Cat. No.
lab disc white	EU/CH	1	9.720 480
lab disc white	UK	1	4.008 137

Optional accessories: Ikaflon®- stirring bars, Trika®- stirring bars, RSE Stirring bar retriever

4. Stirring, Shaking, Mixing

Magnetic stirrers / Hotplates/Without heating, with induction

Magnetic stirrer MIX 1 and MIX 1 eco 2mag

Wear-free inductive drive, powerful, up to 10liters, 100-2000 rpm, internal controller with 20 watts, digital display, 4-step power setting for high power with regard to large and viscous media and reduced power for warming-free continuous operation, adjustable SoftStart for different volumes/viscosity. 3 years warranty. Made in Germany.

MIX 1 eco

Identical to MIX 1, but price optimized, up to 3 liters, speed range 120 -1400 rpm, extremely robust, simple operation by speed knob and scale.

Specifications

<p>Max. volume stirred (H₂O): Motor rating input: Stirring positions: Speed range: Permissible ambient temperature: Permissible humidity: Display: Dimensions (W x D x H): Weight: IP code: Power supply:</p>	<p>MIX 1 // MIX 1 eco 10 l // 3 l 10 W // 20 W 1 100 ... 2000 // 120 ... 1400 min⁻¹ -10 ... 50 °C 80 % digital // analogue 188 x 238 x 38 mm // 120 x 120 x 35 mm 3.4 kg // 1.4 kg IP 65 115/230 V, 50/60 Hz</p>
--	---



9.645 954



9.645 955

Type	PK	Cat. No.
MIX 1	1	9.645 954
MIX 1 eco	1	9.645 955

3 Magnetic stirrer atexMIXdrive 1 with external control 2mag



Explosion protected. 1 stirring position with maintenance-free and wear-free inductive drive for powerful mixing of liquids. Jerk-free stirring even at low speed.

- Very robust construction, easy to clean, with maximum resistance
- Completely sealed housing made from stainless steel
- Magnetic stirrer is water- dust- and germproof
- Control unit atexMIXcontrol or atexMIXcontrol cleanroom with protection class IP65
- Magnetic stirrer submersible in water- or oil baths
- Suitable for use in CO₂ incubators and ovens
- Certified acc. to ATEX II 2G Ex mb IIC T4 Gb

The magnetic stirrer can only be used together with control unit atexMIXcontrol or atexMIXcontrol cleanroom, which have to be ordered separately. Magnetic stirrer, control unit and power supply are firmly connected to each other to ensure Ex protection.

Specifications

<p>Max. volume stirred (H₂O) atexMIXdrive 1: Motor rating input: Stirring positions: Speed range: Permissible ambient temperature: Permissible humidity: Display: IP code:</p>	<p>10 l 20 W 1 100... 2000 min⁻¹ -10... 40 °C 100 % digital IP 68</p>
--	---



Type	PK	Cat. No.
atexMIXdrive 1	1	6.238 005
atexMIXcontrol	1	6.238 006
atexMIXcontrol cleanroom	1	9.646 000

* Control unit explosion protection zone 2.

4. Stirring, Shaking, Mixing

Magnetic stirrers / Hotplates/Without heating, with induction

1 4-Position-Magnetic Stirrer LLG-uniSTIRRER 1/M4

An **Ultra-flat** inductive magnetic stirrer without heating with timer. The modern magnet coil technology consists only of non-moving parts and therefore guarantees a wear-free drive.

For a better mixing of samples it is possible to change the direction of rotation every 30 seconds.

- Max. stirring quantity per stirring position 400 ml
- **Timer** (1 to 99 min, infinitely)
- 100 % wear- and maintenance-free inductive drive
- LED-display for an exact adjustment of the rotation speed
- Digital regulated rotation speed
- Alteration of the stirring direction
- High Protection class IP 65
- Stainless steel surface

Scope of supply: magnetic stirrer, 1 mains adapter each US, AUS, UK, 1 stirring rod 25 x 8 mm

Specifications

Stirring positions:	4
Distance between Stirring positions:	95 mm
Max. Stirring quantity (H:O):	4 x 0.4 l = 1.6 l
Speed range:	15 ... 1200 min ⁻¹
Permissible ambient temperature:	5 ... 40 °C
Magnetic bar:	max. 25 mm
Display:	LED
Heating plate (W x D):	122 x 385 mm
Dimensions (W x D x H):	126 x 457 x 13.5 mm
Weight:	1.9 kg
Power supply:	100 ... 240 V, 50/60 Hz
IP code:	IP 65
Warranty:	3 years

Type	Plug type	PK	Cat. No.
LLG-uniSTIRRER 1/M4	EU	1	6.263 425
LLG-uniSTIRRER 1/M4	UK	1	6.263 426



2 Multi-position magnetic stirrers, Cimarec i Poly 15

Without heating. With non-mechanical, electronic induction drive. With 15 stirring spaces, for e.g. 6 x 1L erlenmeyer flasks or 15 x 250ml beakers. For mass screening and biological applications, even in humidity incubators. With built-in controller, digital speed indicator and soft-start drive. With mains adaptor.

Thermo Scientific

Specifications

Max. stirring volume (H:O):	3 l
Motor rating input:	10 W
Stirring positions:	15
Speed range:	130 ... 990 min ⁻¹
Permissible ambient temperature:	-10 ... 40 °C
Permissible humidity:	95 %
Display:	digital
Dimensions (W x D x H):	240 x 420 x 35 mm
Weight:	6 kg
IP code:	IP 32
Power supply:	115/230 V, 50/60 Hz

Type	PK	Cat. No.
Cimarec i Poly 15	1	9.720 650

4. Stirring, Shaking, Mixing

Magnetic stirrers / Hotplates/Without heating, with induction

1 Multi-position magnetic stirrers MIX 15 eco

Without heating. Non-mechanical, electronic induction drive, 100 % wear-free and maintenance-free. With 15 stirring positions, e.g. for 6 L x 1 L erlenmeyer flasks or 15 ml x 250 ml beakers (high form). Suitable for mass screening and biological applications, even in humidity incubators. With built-in controller, digital speed indicator and SoftStart drive. Supplied with mains adapter. 3 years warranty. Made in Germany.

2mag



Specifications

Max. stirring volume (H ₂ O):	3 l
Motor rating input:	10 W
Stirring positions:	15
Speed range:	120 ... 1200 min ⁻¹
Permissible ambient temperature:	-10 ... 50 °C
Permissible humidity:	80 %
Display:	digital
Dimensions (W x D x H):	245 x 425 x 38 mm
Weight:	7.7 kg
IP code:	IP 65
Power supply:	115/230 V, 50/60 Hz

Type	PK	Cat. No.
MIX 15 eco	1	9.645 958

Multi-position magnetic stirrers MIX 6/15/8 XL/12 XL

Without heating. With non-mechanical, electronic induction drive, 100 % wear-free and maintenance-free. Ideal for batch series stirring. Choice of 6-place, stirring position models which can stir up to 6 x 1000 ml. Erlenmeyer flasks or 15-place models for up to 15 x 250 ml (high form) or 8/12 x 600 ml beakers (high form). Digital stirring speed display and soft-start function. With 4 adjustable power level stirring speeds (5 W to 20 W). Easy to clean, hermetically sealed casing which can be washed under running water, ultra flat, space-saving profile and 100 % synchronous speed control in all stirring positions. SoftStart. 3 years warranty, Made in Germany.

2mag

Specifications

Max. volume stirred (H ₂ O):	3 l
Motor rating input:	20 W
Speed range Mix 6/15:	100 ... 2000 min ⁻¹
Speed range Mix 8 XL/Mix 12 XL	100 ... 1600 min ⁻¹
Permissible ambient temperature:	-10 ... 50 °C
Permissible humidity:	80 %
Display:	digital
IP code:	IP 65
Power supply:	115/230 V, 50/60 Hz

Type	Stirring positions	Stirring centre distances	Dimensions (W x D x H)	Weight	PK	Cat. No.
		mm	mm	kg		
MIX 6	6	130	245 x 425 x 38	7.6	1	9.645 956
MIX 15	15	65	245 x 425 x 38	7.7	1	9.645 957
MIX 8 XL	8	90	185 x 420 x 38	6.4	1	9.646 026
MIX 12 XL	12	90	275 x 420 x 38	8.9	1	9.646 027



9.645 957



9.645 956

Magnetic stirrers and reaction blocks



- 🌀 100% wear- and maintenance-free
- 🌀 Submersible and heat resistant
- 🌀 Durable and sustainable

- 🌀 Individual configurations
- 🌀 3 years warranty
- 🌀 Made in Germany

www.2mag.de

4. Stirring, Shaking, Mixing

Magnetic stirrers / Hotplates/Without heating, with induction

1 Multi-position magnetic stirrers MIXdrive with external control use in waterbath and oven

Without heating. With non-mechanical, electronic inductive drive and dust/water tight housing, 100 % wear-free and maintenance-free. Ideal for batch series stirring and for use in water baths. Choice of 6-place stirring position models which can stir up to 6 x 1 L erlenmeyer flasks, 15-place models for up to 15 x 250 ml beakers (high form) and 60-place models for small sample containers and using appropriate test tube stands, up to 60 test tubes or centrifuge tubes. Control units available as price-optimized eco 10 W, high-power 20 W or ultra high-power 40W version. Preselectable mixing power. SoftStart. 3 years warranty. Made in Germany. **Please order control unit separately.**

2mag

Specifications

Operating conditions: -10 °C to +50 °C at 100 % R.H. max.
 Operating temp. range: in air and water +50 °C
 Standard: in air (ovens) +200 °C, in water +95 °C
 HT-Version: Stainless steel
 Stirrer unit housing: IP 68
 IP code:

Type	Stirring capacity	Stirring positions	Stirring centre distances	Dimensions (W x D x H)	Weight	PK	Cat. No.
	l		mm	mm	kg		
MIXdrive 1 XS	1.0	1		48 x 48 x 18	0.23	1	9.645 985
MIXdrive 1 XS HT	1.0	1		48 x 48 x 18	0.22	1	9.645 986
MIXdrive 1 eco	3.0	1		120 x 120 x 35	1.40	1	9.645 961
MIXdrive 1 eco HT	3.0	1		120 x 120 x 35	1.40	1	9.645 962
MIXdrive 1	10.0	1		180 x 180 x 38	3.20	1	9.645 959
MIXdrive 1 HT	10.0	1		180 x 180 x 38	3.00	1	9.645 960
MIXdrive 6	3.0	6	130	245 x 375 x 38	8.50	1	9.645 963
MIXdrive 6 HT	3.0	6	130	245 x 375 x 38	8.10	1	9.645 964
MIXdrive 15	3.0	15	65	245 x 375 x 38	8.60	1	9.645 965
MIXdrive 15 HT	3.0	15	65	245 x 375 x 38	8.30	1	9.645 966
MIXdrive 60	0.5	60	32	245 x 375 x 38	8.00	1	9.645 967
MIXdrive 60 HT	0.5	60	32	245 x 375 x 38	7.50	1	9.645 968

Please order control unit **MIXcontrol** separately.

Control units for mixers MIXdrive

MIXcontrol eco: Prize-optimized control unit, speed setting and ON/OFF by turning 2 units.
MIXcontrol 20: Stainless steel housing, digital speed display, 4-step power setting, 20 watts.
MIXcontrol 40: Identical to MIXcontrol 20, but 10-step power setting, 40 watts, 2 sockets for MIXdrive stirres.

2mag

Specifications

Display: digital

Type	Min. speed rpm	Max. speed rpm	Dimensions (W x D x H) mm	Weight kg	PK	Cat. No.
MIXcontrol eco, with EU-plug	120	1200	65 x 50 x 45	0.08	1	9.645 969
MIXcontrol 20, with EU-plug	100	1600	200 x 155 x 38	1.30	1	9.645 970
MIXcontrol 40, with EU-plug	100	2000	200 x 155 x 38	1.30	1	9.645 971

1



2



9.645 971

1

1 Magnetic mini-stirrers topolino mobil

Mobile magnetic mini-stirrer for mixing quantities up to 250 ml for battery and mains operation.

IKA

- Durable, brushless motor
- Continuously adjustable speed range
- Portable operation with long operating time (8-12 h)
- Short charging time (2-3 h)
- Operation with standard replaceable AA rechargeable batteries and with supplied mains adapter

Specifications

Stirring quantity max. (H:O):	250 ml
Speed range:	300 ... 1800 rpm
Permissible ambient temperature:	5 ... 40 °C
Permissible relative moisture:	80 %
Material:	PP
Dimensions Top plate (Ø):	80 mm
Dimensions (Ø x H):	140 x 42 mm
Weight:	0.6 kg
Power supply:	100 ... 240 V, 50/60 Hz
IP code:	IP 21

Type	PK	Cat. No.
Topolino mobil	1	9.720 219

2

2 Magnetic stirrer SM27, with battery operation.

For use in the field or inside incubators or glove boxes where external power supply is impractical. With BioCote, silver-based, antimicrobial protection. Maximum speed 1300rpm. Maximum volume stirred 1.5L (H:O). Top plate 150 mm x 160 mm. Variable speed control with battery status indicator. ABS casing 70 mm high. Accessory adapters are available for use on 230V 50Hz mains or 12V vehicle supply using the cigar lighter socket.

Stuart

Specifications

Max. volume stirred (H:O):	1.5 l
Stirring positions:	1
Speed range:	0.. 1300 min ⁻¹
Permissible ambient temperature:	5.. 60 °C
Permissible humidity:	80 %
Display:	analog
Dimensions (W x D x H):	150 x 160 x 70 mm
Weight:	1.3 kg
Power supply:	Battery

Type	PK	Cat. No.
SM27	1	9.950 408

3

3 Magnetic stirrer accuMIX, with battery operation

Mobile magnetic stirrer, 100 % maintenance-free and wear-free by inductive 2mag-Magnetic-Drive concept for mixing of solutions, speed range from 100 rpm up to 1600 rpm, jerk-free stirring also at low speeds, two-step power setting for high power with regard to large and viscous stirring amounts and reduced power for battery-saving long-term operation. Constructed for the independent battery- and stationary mains operation, equipped with 8 commercially available high performance rechargeable batteries (Mignon/AA), universal charging/power supply device, intelligent battery charging station with single controlled charging slots as well as battery service function and 12 V adapter cable for the operation at cigarette lighter car sockets.

2mag

Specifications

Max. volume stirred (H:O):	3 l
Motor rating input:	10 W
Stirring positions:	1
Speed range:	100 ... 1600 min ⁻¹
Permissible ambient temperature:	-10 ... 50 °C
Permissible humidity:	80 %
Display:	analog
Dimensions (W x D x H):	215 x 130 x 40 mm
Weight:	1.5 kg
IP code:	IP 30
Power supply:	8 x AA

Type	PK	Cat. No.
accuMIX	1	9.646 011

4. Stirring, Shaking, Mixing Magnetic stirrers / Hotplates/With heating and motor

1 2 Magnetic stirrer with heating LLG-uniSTIRRER 3, complete set

Universal magnetic stirrer with all essential functions and equipment features. A LED display to control all parameters, an integrated temperature control as well as an enclosed design (IP 42) are integrated features. The included PT1000 sensor ensures an exact temperature control. A stand rod with a sensor holder is supplied with this instrument. The integrated **HOT-sign** warns the user of a hot plate even if the device is switched off.

- LED display to set the exact rotation speed and the temperature
- Digital controlled rotation speed and temperature
- 'HOT' warning sign, even if the device is switched off
- Stainless steel surface
- **Delivered as complete set:** magnetic stirrer, sensor Pt1000, stand rod and sensor holder
- Integrated temperature control

Delivery includes: Magnetic stirrer with PT1000 probe, rod and holder

1



Specifications

Stirring quantity (H ₂ O):	3 l
Speed range:	200 ... 1500 min ⁻¹
Display accuracy:	±10 min ⁻¹
Magnetic bar:	max. 50 mm
Display:	LED
Heating plate:	Ø 135 mm
Permissible ambient temperature:	5 ... 40 °C
Temperature range:	RT ... 280 °C
Setting accuracy:	±1 °C
Control accuracy:	±2 °C
Heat output:	500 W
Safety temperature:	320 °C
Dimensions (W x D x H):	155 x 215 x 100 mm
Weight:	1.5 kg
Power supply:	200 ... 240 V, 50/60 Hz
IP code:	IP 42
Warranty:	3 years

Type	Plug type	PK	Cat. No.
LLG-uniSTIRRER 3	EU	1	6.263 410
LLG-uniSTIRRER 3	UK	1	6.263 411

Accessories for LLG-uniSTIRRER 3/LLG-uniSTIRRER 5/LLG-uniSTIRRER 7

Description	For	PK	Cat. No.
Stand and sensor holder	LLG-uniSTIRRER 3	1	6.263 416
Adjustment knob	LLG-uniSTIRRER 3	1	6.263 414
Heating plate, stainless steel	LLG-uniSTIRRER 3	1	6.263 613
Silicone Protective cover	LLG-uniSTIRRER 5	1	6.263 445
PT1000 temperature sensor	LLG-uniSTIRRER 3/5/7	1	6.263 415
PT1000-B temperature sensor, glass coated	LLG-uniSTIRRER 3/5/7	1	6.263 417

2





1 2 Magnetic stirrer with heating LLG-uniSTIRRER 5, complete package

Universal magnetic stirrer with an outstanding price-performance ratio. Safety features include a **"hot" warning display** and a stirring function that continues to run until the plate temperature is below 50 °C, even when the device is switched off. A digital timer enables unattended operation and can be set from 1 min to 99 h 59 min. When the set time has elapsed, the unit stops automatically. An integrated control function offers precise control of the heated fluid temperature via a remote PT1000 temperature probe. The device is equipped with a Ø 135 mm stainless steel plate with glass ceramic, suitable for the LLG-Universal reaction block systems.

- **Timer** (1 min to 99 h 59 min)
- Maintenance-free, brushless DC motor
- Stainless steel plate with glass ceramics coating
- Digital control and **backlit display**
- Stirrer and display can be controlled remotely via an RS232 interface
- Hot surface indicator
- Sturdy metal housing
- Powerful stirring
- Connection for PT1000, integrated control function

Scope of delivery: Magnetic stirrer with PT1000 probe, rod and holder



Specifications

Max. stirring quantity (H ₂ O):	20 l
Speed:	100 ... 1500 min ⁻¹
Accuracy:	±1 min ⁻¹
Magnetic bar:	max. 80 mm
Display:	LCD
Heating plate:	Ø 135 mm
Permissible ambient temperature:	5 ... 40 °C
Temperature range:	RT ... 340 °C
Setting accuracy:	±0.1 °C
Control accuracy:	±0.2 °C
Heat output:	550 W
Safety temperature:	360 °C
Dimensions (W x D x H):	160 x 285 x 85 mm
Weight:	2.8 kg
Power supply:	200 ... 240 V, 50/60 Hz
IP code:	IP 42
Warranty:	3 years

Type	Plug type	PK	Cat. No.
LLG-uniSTIRRER 5	EU	1	6.263 440
LLG-uniSTIRRER 5	UK	1	6.263 441



3 LLG-Magnetic stirring bars, cylindrical, PTFE, *eco pack*

Circular, smooth and PTFE-coated. Packaging size: 10 pieces

Diam. mm	Length mm	PK	Cat. No.
6	10	10	9.198 910
3	12	10	9.198 766
6	15	10	9.198 919
6	20	10	9.198 920
6	25	10	9.198 925
8	25	10	9.198 767
6	30	10	9.198 930
6	35	10	9.198 935
8	40	10	9.198 940
8	45	10	9.198 945
8	50	10	9.198 950
9	60	10	9.198 960
9	70	10	9.198 970
9	80	10	9.198 980

1 2 Magnetic stirrer with heating LLG-uniSTIRRER 7, complete package

Universal magnetic stirrer with an outstanding price-performance ratio. Safety features include a **"hot" warning display** and a stirring function that continues to run until the plate temperature is below 50 °C, even when the device is switched off. An integrated control function offers precise control of the heated fluid temperature via a remote PT1000 temperature probe. The device is equipped with a stainless steel plate with glass ceramic (184 x 184 mm).

- Maintenance-free, brushless DC motor
- Digital control and **backlit display**
- Stirrer and display can be controlled remotely via an RS232 interface
- Hot surface indicator
- Stainless steel plate with glass ceramic
- Sturdy metal housing
- Powerful stirring
- Connection for PT1000, integrated control function
- Mountable rod on the left and on the right side of the stirrer

Scope of delivery: Magnetic stirrer with PT1000 probe, rod and holder

Specifications

Max. stirring quantity (H ₂ O):	20 l
Speed range:	100 ... 1500 min ⁻¹
Accuracy:	±1 min ⁻¹
Magnetic bar:	80 mm
Display:	LCD
Heating plate:	184 x 184 mm
Permissible ambient temperature:	5 ... 40 °C
Temperature range:	ambient ... 550 °C
Setting accuracy:	±0.1 °C
Control accuracy:	±0.2 °C
Heat output:	1000 W
Safety temperature:	580 °C
Dimensions (W x D x H):	215 x 360 x 112 mm
Weight:	5.3 kg
Power supply:	200 ... 240 V, 50/60 Hz
IP code:	IP 42
Warranty:	3 years

Type	Plug type	PK	Cat. No.
LLG-uniSTIRRER 7	EU	1	6.263 450
LLG-uniSTIRRER 7	UK	1	6.263 451



Accessories for LLG-uniSTIRRER 3/LLG-uniSTIRRER 5/LLG-uniSTIRRER 7

Description	For	PK	Cat. No.
Stand and sensor holder	LLG-uniSTIRRER 3	1	6.263 416
Adjustment knob	LLG-uniSTIRRER 3	1	6.263 414
Heating plate, stainless steel	LLG-uniSTIRRER 3	1	6.263 613
Silicone Protective cover	LLG-uniSTIRRER 5	1	6.263 445
PT1000 temperature sensor	LLG-uniSTIRRER 3/5/7	1	6.263 415
PT1000-B temperature sensor, glass coated	LLG-uniSTIRRER 3/5/7	1	6.263 417

3 LLG-Magnetic Stirring Bar Retrievers, PTFE

PTFE-encapsulated stirring bar retriever with strong permanent magnet (Alnico 5), universal chemical resistance. For the removal of stirring bars from aggressive liquids, prevents loss of stirring bars. Lower end diameter 10mm.

Diam. mm	Length mm	PK	Cat. No.
8	150	1	9.197 717
8	250	1	9.197 725
8	300	1	4.008 501
8	350	1	9.197 735



Universal reaction block system for magnetic stirrers please see page 475.



1 2 LLG-RCT standard *safety control*

Magnetic stirrer with new technology and new functions:

- integrated temperature control
- incl. PT 1000 temperature sensor (PT 1000.60)
- exact temperature and speed setting via digital display, even when switched off
- digital display of set safety temperature limit
- hot top indicator, hot surface warning to prevent burns
- digital error code display
- with adjustable safety circuit of heating plate temperature (50 to 360 °C)
- safety magnetic stirrer with heating, suitable for unsupervised operation
- DIN 12878 connector for attaching a contact thermometer, e.g. ETS-D5; enables precise temperature control directly in the heated medium
- enhanced safety due to improved heat control technology
- enclosed assembly (IP42) guarantees long service life
- highly polished, aluminium hotplate for optimal heat transfer
- improved magnetic coupling
- supplied with housing protection cover H 98
- Tested acc. to DIN EN IEC 61010-1

Scope of supply: magnetic stirrer, temperature sensor PT1000 , screwdriver, protective cover, C16 mains cable (H11)

Specifications

Max. stirring quantity (H ₂ O):	20 l
Speed range:	50 ... 1500 min ⁻¹
Accuracy:	±1 min ⁻¹
Magnetic bar:	80 mm
Display:	LED
Heating plate:	Ø 135 mm
Permissible ambient temperature:	5 ... 40 °C
Temperature range:	ambient ... 310 °C
Setting accuracy:	±1 K
Control accuracy:	±2 K
Heat output:	600 W
Safety temperature:	50 ... 360 °C
Dimensions (W x D x H):	160 x 270 x 85 mm
Weight:	2.5 kg
Power supply:	220 ... 230 V, 50/60 Hz
IP code:	IP 42
Warranty:	3 years

Type	Plug type	PK	Cat. No.
RCT Standard safety control incl. PT 1000	EU	1	9.720 250
RCT Standard safety control incl. PT 1000	UK	1	6.242 087
RCT Standard safety control incl. PT 1000	CH	1	4.008 142



3 Magnetic stirrer/hotplate RH basic 2

Low-priced, magnetic stirrer/hotplate, with heating, with stainless steel top plate.

IKA

Specifications

Stirring volume:	10L
Motor rating input/output:	15/2W
Speed indication:	Scale (0 to 6)
Speed range	100 to 2000rpm
Heating power:	400W
Heating rate (1 litre water):	3K/min
Temperature range:	Amb. to +320°C
Hotplate surface:	Stainless steel (AISI 304), 125mm dia.
Dimensions W x D x H:	168 x 220 x 105mm
Weight:	2.4kg
Protection class acc. to DIN EN 60529:	IP21
Supply requirement:	230V 50/60 Hz
Tested to DIN EN IEC 61010-1.	

Type	Plug type	PK	Cat. No.
RH basic 2	EU	1	9.720 402

1 Magnetic stirrer ARE

Magnetic stirrer with aluminium heating plate for stirring speeds up to 1500 min⁻¹.

Velp Scientifica

- Suitable for stirring volumes of up to 20 l
- Operating temperature up to 370 °C
- Chemical- and scratch-resistant heating plate
- Electronic speed control for stable stirring speeds
- Torque compensation to keep the speed constant even on viscosity changes

Specifications

Volume (H ₂ O):	20 l
Power rating:	630 W
Speed (max.):	1500 min ⁻¹
Number of stirring positions:	1
Display:	Analog
Temperature range:	RT ... 370 °C
Stirring position material:	Aluminium
Stirring position:	Ø 155 mm
Dimensions (W x D x H):	165 x 280 x 115 mm
Weight:	2.6 kg
IP code:	IP 42
Power supply:	230 V, 50/60 Hz
Warranty:	3 years



Type	Plug type	PK	Cat. No.
ARE	EU	1	4.661 100

Magnetic stirrers RH basic/digital

Economic magnetic stirrer with heating. High heat output of 600 watts and the steel-copper compound hot plate ensures rapid heating. Adjustable safety temperature from 50 to 370 °C. Soft-start stirring motor. Includes M 10 thread for a support rod. Strong magnetic field and wide speed range for volumes up to 15 litres. RH basic white/RH digital white with chemically resistant hot plate.

RH digital only: Bushing according to DIN 12878 for connecting an electronic contact thermometer, such as the ETS-D5. Highly accurate temperature control is possible with the sensor placed directly in the medium.

- Digital display of temperature and speed
- Error code display
- Easy operation with touch keypad

Specifications

Max. stirring quantity (H ₂ O):	15l
Motor rating input/output:	15/2 W
Speed range:	50... 2000 min ⁻¹
Speed display RH basic/RH digital:	scale/LED
Heat output:	600 W
Heating rate (1l H ₂ O):	6K/min
Temperature range min./max.	50 to 320 °C
Setting accuracy RH digital:	±5K
Adjustable safety circuit min./max.:	50 to 370 °C
Connection for ext. temp. sensor:	DIN 12878
Control accuracy with sensor:	±1K
ETS-D5/ETS-D6:	±0.5K/±0.2 K
Set-up plate:	Stainless steel 1.4301, diam. 135 mm
Dimensions (W x D x H):	160 x 246 x 90 mm
Weight:	2.8 kg
Protection class acc. to DIN EN 60529:	IP 21
Power supply:	220-240 V, 50/60 Hz

Type	Plug type	PK	Cat. No.
RH basic	EU	1	9.720 411
RH basic	UK	1	9.720 412
RH basic white	EU	1	9.720 417
RH digital	EU	1	9.720 414
RH digital white	EU	1	9.720 418

2

IKA



9.720 411

3



9.720 414

4



9.720 418

Magnetic stirrers SS/SD/SP/CS/CD/CP 152

With heating. Magnetic stirrers with strong magnets and powerful motor for mixing large volumes. The analog models have a LED display for the set and actual temperature of the device. With the digital models, the set and actual temperature is shown on the display, while the speed is indicated on the LED display. Stuart

- Spill-resistant front control panel with a chemically toughened glass for extra resilience
- Hot surface warning light flashes when plate temperature is above 50 °C
- With an integral fixing point for a retort rod
- With BioCote, silver-based, antimicrobial protection

SP152/CP152 additionally with:

- Full-colour 10-cm TFT screen which simultaneously displays target settings and the actual temperature
- Individual profiles can be created and saved
- User calibration for adjusting the temperature output ($\pm 5\%$ at 50 and 450 °C)
- Incl. Pt100 Temperature sensor

Specifications

Maximum Stirring Capacity:	15 l
Display resolution:	1 °C
Accuracy:	± 1 °C
Plate Dimensions:	150 x 150 mm
Dimensions (W x D x H):	180 x 300 x 93 mm
Weight:	2.9 kg
Power supply:	230 V, 50/60 Hz
Warranty:	3 years



4.672 505



4.672 580



4.672 522



4.672 585

Magnetic stirrer SS152/SD152 /SP152

NEW

Durable chip-resistant aluminum top plate offers excellent heat transmission, rapid heating, and oven temperature distribution Stuart

Specifications

Plate Material:	Aluminium, ceramic coated
Heated Area:	150 x 150 mm
Heater Power:	700 W
Max plate temp:	325 °C
Stirrer Speed:	50 ... 1400 rpm

Type	Colour housing	Display type	PK	Cat. No.
SS152B	Blue	Analogue	1	4.672 505 1
SS152K	Black	Analogue	1	4.672 506
SS152W	White	Analogue	1	4.672 507
SD152B	Blue	Digital	1	4.672 517
SD152K	Black	Digital	1	4.672 518
SD152W	White	Digital	1	4.672 519
SP152B	Blue	Digital	1	4.672 579
SP152W	Black	Digital	1	4.672 580 2
SP152K	White	Digital	1	4.672 581
SP152P	Pink	Digital	1	4.672 582

Magnetic stirrers CS152/CD152 /CP152

NEW

Ceramic top plate is chemical resistant and easy to clean, plus the white surface ensures good visibility of colour changes. Stuart

Specification

Plate Material:	Glass ceramic
Heated Area:	120 x 120 mm
Heater Power:	500 W
Max plate temp:	450 °C
Stirrer Speed:	50 ... 1250 rpm

Type	Colour housing	Display type	PK	Cat. No.
CS152B	Blue	Analogue	1	4.672 508
CS152K	Black	Analogue	1	4.672 509
CS152W	White	Analogue	1	4.672 510
CD152B	Blue	Digital	1	4.672 520
CD152K	Black	Digital	1	4.672 521
CD152W	White	Digital	1	4.672 522 3
CP152B	Blue	Digital	1	4.672 583
CP152W	Black	Digital	1	4.672 584
CP152K	White	Digital	1	4.672 585 4
CP152P	Pink	Digital	1	4.672 586

4. Stirring, Shaking, Mixing

Magnetic stirrers / Hotplates/With heating and motor

Magnetic stirrer C-MAG HS 4/C-MAG HS 7/C-MAG HS 10

With heating. Ceramic hotplate which offers excellent chemical resistance.
 - powerful motor for stirring quantities of up to 5L, 10L or 15L (H₂O).

IKA

- fixed safety circuit of 550°C
- Hot Top indicator - hot surface warning to prevent burns
- exact temperature setting via digital display (LED)
- digital error code display
- elevated control panel for protection against spilled liquids

C-MAG HS 7 and C-MAG HS 10:

Connection acc. to DIN 12878 for attaching a contact thermometer, e.g. ETS-D5; enables precise temperature control.

Specifications

Magnetic stirrer

Stirring quantity (H₂O): 5 l // 10 l // 15 l
 Motor rating input/output: 15/1.5W
 Speed range: 100 ... 1500rpm
 Speed display: scale

Heating function

Temperature display: digital
 Heat output: 250W // 1000W // 1500W
 Heating rate (1 l H₂O): 2.5 K/min // 5 K/min // 5 K/min
 Heating temperature range: 50 ... 500°C
 Heat control accuracy: ±10K
 Fixed safety circuit: 550°C

Control accuracy with sensor

C-MAG HS 4:

C-MAG HS 7/HS 10:

HS4 // HS7 // HS10

5 l // 10 l // 15 l

15/1.5W

100 ... 1500rpm

scale

digital

250W // 1000W // 1500W

2.5 K/min // 5 K/min // 5 K/min

50 ... 500°C

±10K

550°C

-

ETS-D5/±0.5K

Top plate

Material:

glass ceramic

Dimensions:

100 x 100mm // 180 x 180mm // 260 x 260mm

Protection class according to DIN EN 60529:

IP21

1



9.720 490

2



9.720 491

3



9.720 492

Type	Plug type	PK	Cat. No.
C-MAG HS 4	EU	1	9.720 490
C-MAG HS 4	UK	1	4.008 087
C-MAG HS 7	EU	1	9.720 491
C-MAG HS 7	UK	1	4.008 090
C-MAG HS 10	EU	1	9.720 492
C-MAG HS 10	UK	1	4.008 093

4 Magnetic stirrer C-MAG HS 7 Package

C-MAG HS 7 Package includes: Magnetic stirrer/hotplate C-MAG HS 7, ETS-D5 Electronic contact thermometer, H 38 Holding rod, H 16 V Support rod and H 44 Bosshead.

IKA

Specifications

Max. volume stirred (H₂O): 10 l
 Motor rating input: 15 W
 Motor rating output: 2 W
 Stirring positions: 1
 Speed range: 100... 1500 min⁻¹
 Permissible ambient temperature: 5... 40 °C
 Permissible humidity: 80 %
 Display: digital
 Plate (W x D): 180 x 180 mm
 Dimensions (W x D x H): 220 x 330 x 105 mm
 Weight: 5 kg
 IP code: IP 21
 Power supply: 230/120/100 V, 50/60 Hz

4



Type	PK	Cat. No.
C-MAG HS 7 Package	1	6.235 183

4. Stirring, Shaking, Mixing

Magnetic stirrers / Hotplates/With heating and motor

Magnetic stirrer AREX-6 Connect PRO

Magnetic stirrer with ceramic-coated aluminium heating plate, stirring speeds up to 1700 min⁻¹, timer and PT100 temperature sensor. **With WiFi connection to the VELP Ermes Cloud Platform for uploading, managing, monitoring and exchanging results and parameters.** Access to the device is possible via PC, Smartphone and Tablet.

Velp Scientifica

Equipped with extensive safety functions: independent safety circuits protect the device in case of overtemperature, adjustable temperature limitation, warning in case of hot surface, protection against unattended heating as well as alarm and switch-off function if the temperature sensor is not immersed in the medium.

- Suitable for stirring volumes up to 20 l
- Powerful, brushless motor
- Torque compensation to keep the speed constant even on viscosity changes
- Reverse of stirring direction
- Resistant housing made of die-cast
- Chemical- and scratch-resistant heating plate
- Gentle start of the stirrer
- Temperature control via software up to 370 °C
- All settings configurable on menu
- Clear display of all parameters
- Software updates by WiFi

Scope of delivery AREX-6 Connect PRO: Magnetic stirrer AREX-6 Connect PRO, PT100 temperature sensor

Scope of delivery AREX-6 Connect PRO Set: Magnetic stirrer AREX-6 Connect PRO, PT100 temperature sensor, support rod, clamp for the temperature sensor

Specifications

Volume (H ₂ O):	20 l
Motor rating:	630 W
Speed range:	30 ... 1700 min ⁻¹
Speed accuracy:	5 min ⁻¹
Number of stirring positions:	1
Display:	Digital
Temperature range:	RT ... 370 °C
Temperature accuracy:	±1 °C
Stirring position material:	Aluminium, ceramic coated
Stirring position:	Ø 135 mm
Permissible ambient temperature:	5 ... 40 °C
Dimensions (W x D x H):	160 x 280 x 105 mm
Weight:	2.6 kg
IP code:	IP 42
Power supply:	230 V, 50/60 Hz
Warranty:	3 years

Type	Plug type	PK	Cat. No.
AREX-6 Connect PRO	EU	1	4.666 720
AREX-6 Connect PRO Set	EU	1	4.666 733



4.666 720

Magnetic Stirrers MR Hei-PLATE

The Hei-PLATE series with heating consists of models Hei-Standard, Hei-Tec and Hei-Connect.

Heidolph

- The chemically resistant KeraDisk® hot plate allows for immediate heat transfer resulting in quick heat-up times
- In case the heating function fails, stirring will not be discontinued to prevent bumping
- A separate on/off button for heating prevents unintentional heat-up
- With fire-resistant aluminum die-cast housing, which prevents the stirrer from damage, even if exposed to highest temperatures
- In case of a short-circuit, damage to the temperature sensor or disorder of the process, the unit powers off completely
- The temperature sensor consists of two independent safety circuits which switches off heating in case of any overtemperature situation
- Hermetically-sealed housing protects all mechanical and electronic components from aggressive environments
- With connection for optional temperature sensor Pt 1000

Hei-Tec and Hei-Connect additionally with:

- Digital display enables full process monitoring and precise setting of all parameters.
- This unit features a digital display and allows for easy setting and monitoring of values in the illuminated readout
- An illuminated button indicates clearly if the stirring mode is activated
- Precise adjustment of the desired hotplate temperature by turn-push-button
- Overheating protection by a safety circuit that switches off heating if the temperature sensor is not immersed in the media vessel

Specifications

Stirring quantity (H ₂ O):	20 l
Speed range:	100 ... 1400 rpm
Heating power:	800 W
Temperature range:	20 ... 300 °C
Permissible ambient temperature:	5 ... 31 °C
Permissible relative moisture:	80 %
Plate Material:	Kera-Disk®
Plate Dimensions (Ø):	145 mm
Dimensions (W x D x H):	173 x 277 x 94 mm
Weight:	2.9 kg
Power supply:	230 V
IP code:	IP 32
Warranty:	3 years

1



9.720 201

2



6.256 440

3



1 Magnetic stirring hotplates MR Hei-Standard

Model for standard applications without temperature sensor.

Heidolph

Type	Plug type	PK	Cat. No.
MR Hei-Standard EU	EU	1	9.720 201
MR Hei-Standard UK	UK	1	6.263 289

Magnetic stirring hotplates MR Hei-Tec

Precise adjustment and monitoring of device parameters via digital display.

Heidolph

Type	Plug type	PK	Cat. No.
MR Hei-Tec with Pt 1000	EU	1	6.256 440
MR Hei-Tec, stirrer only	EU	1	9.720 145
MR Hei-Tec, stirrer only	UK	1	6.240 766

3 Packages Magnetic stirrers MR Hei-PLATE

Package Hei-PLATE Silver 1

Heidolph

- Magnetic Stirrer MR Hei-Tec
- Temperature sensor Pt 1000
- Support rod for Pt 1000
- Clamp for Pt 1000

Type	PK	Cat. No.
Package MR Hei-PLATE Silver 1	1	6.256 441



6.312 903

Magnetic stirrers Guardian 7000

The durable Hotplate Stirrers are designed with outstanding safety features and superior heating and mixing performance.

- SmartRate™ enables to select fast or slow temperature and speed ramp rates
- SmartHousing™ stays cool to the touch and is chemical-resistant
- SmartHeat™ safely controls and monitors the maximum temperature
- SafetyHeat™ assures safety in heating applications with dual monitoring of system health
- SmartLink™ turns off heating function if Bluetooth® link is broken
- SmartPresence™ turns off heating function if users are not recognised nearby

Scope of supply: Magnetic stirrer, temperature sensor, in use cover



6.312 905

Specifications

Speed:	60 ... 1600 rpm
Timer:	1 min ... 99 h 59 min
Permissible ambient conditions:	5 ... 40 °C
Power supply:	230 V, 50/60 Hz

Type	Stirring capacity	Temp. range	Material stirring surface	Plate dimensions	Dimensions (W x D x H)	PK	Cat. No.
	l	°C		mm	mm		
e-G71HS07C	15	ambient +5 ... 500	Ceramic	178 x 178	223 x 309 x 122	1	6.312 903
e-G71HS10C	18	ambient +5 ... 500	Ceramic	254 x 254	286 x 415 x 122	1	6.312 904
e-G71HSRDM	20	ambient +5 ... 380	Aluminium	Ø 135	173 x 267 x 126	1	6.312 905



Magnetic stirrer IKA Plate (RCT digital)

IKA

With glass surface. The control can be optimized by regular firmware updates. The integrated timer and counter function supports the control of kinetics and sensitive reactions. The IKA SmartTemp® function protects users intelligently and predictably.

- Alteration of the stirring direction possible
- Heating plate made of aluminium alloy for optimum heat transmission
- Clearly arranged LCD display
- Housing made of glass for optimum cleaning and chemical resistance
- Temperature control directly in the medium with PT 1000 temperature sensor
- Adjustable safety circuit up to 360 °C
- IKA SmartTemp® function prevents users from burn injuries
- Timer
- USB-/RS232 interface
- 10 years warranty

Scope of supply: Magnetic stirrer incl. Temperature sensor PT1000

Specifications

Max. stirring quantity (H ₂ O):	20 l
Motor rating input/output:	50 W/9 W
Speed range:	50 to 1500 rpm
Max. stirring bar length:	80 mm
Heating power:	600 W
Heating rate (1 l H ₂ O):	7 K/min
Temperature range:	ambient +10 to 310 °C
Heat control accuracy at 100 °C:	±5 K
Safety circuit:	50 to 360 °C
Connection for ext. temp. sensor:	PT1000, ETS-D5, ETS-D6
Control accuracy with sensor PT1000, ETS-D5/ETS-D6:	±0.5 K/±0.2 K
Set-up plate Material:	Aluminium alloy
Set-up plate Dimensions:	diam. 135 mm
Protection class acc. to DIN EN 60529:	IP 42
Overall dimensions (W x D x H):	160 x 270 x 85 mm
Weight:	2.4 kg
Power supply:	220-230/115/100 V, 50/60 Hz

Type	PK	Cat. No.
RCT digital	1	6.286 692

1 Magnetic stirrer RCT 5 digital



1

Powerful Magnetic stirrer with glass surface for demanding stirring tasks. The stirring process can be programmed individually from beginning to end and so the reaction runs reliably and safely even without monitoring.

- Alteration of the stirring direction is possible
- Timer functions or sequence programming is adjustable
- Set-up plate made of white, scratch-resistant ceramic coating
- Warning in case of a hot surface
- Adjustable safety circuit up to 370 °C
- USB-/RS232 interface

Specifications

Max. stirring quantity (H ₂ O):	20 l
Motor rating input/output:	50 W/9 W
Speed range:	50 ... 1500 rpm
Max. stirring bar length:	80 mm
Heating power:	850 W
Heating rate (1 l H ₂ O):	7.5 K/min
Temperature range:	ambient +13 to 310 °C
Heat control accuracy at 100 °C:	±5 K
Safety circuit:	50 ... 370 °C
Connection for ext. temp. sensor:	PT1000, ETS-D5, ETS-D6
Control accuracy with sensor PT1000, ETS-D5/ETS-D6:	±0.5 K/±0.2 K
Set-up plate Material:	Aluminium, ceramic coating
Set-up plate Dimensions:	137 x 137 mm
Overall dimensions (W x D x H):	160 x 270 x 85 mm
Weight:	2.6 kg
IP code acc. to DIN EN 60529:	IP 42
Power supply:	220-230/115/100 V, 50/60 Hz



Type	Plug type	PK	Cat. No.
RCT 5 digital	EU	1	4.669 085

2 Magnetic stirrer C-MAG HS 7 control

IKA

2

The magnetic stirrer C-Mag HS 7 control has a square top made of ceramic which offers excellent chemical resistance. The C-Mag HS 7 control improves over time with regular firmware updates. Control of kinetics and sensitive reactions are supported by the integrated timer and counter function.

- Alteration of the stirring direction possible
- Clearly arranged LCD display
- Temperature control directly in the media with PT1000 temperature sensor
- Adjustable safety circuit up to 650 °C
- IKA SmartTemp® hot surface warning to prevent burns
- Elevated control panel for protection against leaking liquids
- Timer
- USB/RS232 interface
- 10 years warranty

Scope of supply: Magnetic stirrer incl. Temperature sensor PT1000

Specifications

Max. stirring quantity (H ₂ O):	20 l
Motor rating input/output:	20 W/9 W
Speed range:	50 to 1500 rpm
Max. stirring bar length:	80 mm
Heat output:	1000 W
Heating rate (1l H ₂ O):	5 K/min
Temperature range:	ambient + 5 to 500 °C
Heat control accuracy at 100 °C:	±5 K
Safety circuit:	100 to 650 °C
Connection for ext. temp. sensor:	PT1000, ETS-D5, ETS-D6
Control accuracy with sensor PT1000, ETS-D5/ETS-D6:	±0.5 K/±0.2 K
Set-up plate Material:	ceramic
Set-up plate Dimensions (W x D):	180 x 180 mm
Protection class acc. to DIN EN 60529:	IP 21
Overall dimensions (W x D x H):	220 x 354 x 88 mm
Weight:	4 kg
Power supply:	220-230/115/100 V, 50/60 Hz



Type	PK	Cat. No.
C-MAG HS 7 control	1	6.288 285

4. Stirring, Shaking, Mixing

Magnetic stirrers / Hotplates/With heating and motor



1

1 2 Magnetic stirrer/hotplates, RET basic

Wide speed range from 0/50 to 1700rpm. Integrated temperature control. Incl. PT 1000 temperature sensor (PT 1000.60). Exact temperature and speed setting via digital display, even when switched off. Set safety temperature limit displayed digitally. Hot Top indicator: hot surface warning to prevent burns. Digital error code display.

IKA

- With adjustable safety circuit of heating plate temperature (50 to 380°C)
- Safety magnetic stirrer with heating, suitable for unsupervised operation
- Bushing according to DIN 12878 for connecting a contact thermometer, e.g. ETS-D5, enables precise temperature control
- High level of safety thanks to improved heat control technology
- Enclosed assembly (IP 42) guarantees long service life
- Very broad temperature range (RT to 340°C)
- Extremely fast heating times
- Electronic speed control
- High magnetic adhesion
- Incl. protection cover H 100



2

Specifications

Magnetic stirring:

Volume stirred (water):	20L
Motor rating input/output:	16/9W
Speed adjustment:	Dial
Speed range:	50 to 1700 rpm
Maximum magnetic stirrer bar (L x dia.):	80 x 10 mm

Heating

Heat output:	600W
Heating rate (1 l H ₂ O in H15):	7 K/min
Temperature range:	Amb. to 340 °C
Accuracy:	±1 K
Speed control:	stepless
Adjustable safety circuit:	min 50 °C max 360 °C
Connection for ext. temperature sensor:	DIN 12 878
Control accuracy with temp. probe:	PT 1000/ ±1 K ETS-D 5/ ±0.5 K
Hotplate material:	Stainless steel
Dimensions:	dia. 135 mm
Dimensions (W x D x H):	160 x 270 x 95 mm
Weight:	2.5 kg
Protection system to DIN EN 60529:	IP 42
Tested to DIN EN IEC 61010-1.	
Supply requirements:	230 V 50/60 Hz

Type	Plug type	PK	Cat. No.
RET® basic control-visc	EU	1	9.720 248
RET® basic control-visc	UK	1	4.008 113

Optional Accessories: Electronic contact thermometer: ETS-D5, IKAFLON®- Stirring bars, TRIKA®-Stirring bars, RS 1 Set of stirring bars, RSE Stirring bar remover, Protection cover H 100, Temperatur sensors: PT 1000.60, PT 1000.70

Overall accessories for IKA magnetic stirrers

IKA

Type	For model	Description	PK	Cat. No.
PT 1000.60	RCT basic, RET basic, C-MAG HS digital	Temperature sensor, 230 mm	1	6.229 702
PT 1000.70	RCT basic, RET basic, C-MAG HS digital	Temperature sensor, glass-coated	1	6.231 283
PT 1000.80	RCT basic, RET basic, C-MAG HS digital	Temperature sensor, 150 mm	1	9.720 352
H 104	RET control	Protective cover	1	9.910 338
H 29	RET, RCT	Oil bath attachment, i. d. : 136 - 180 mm, H: 81 mm, Vol. : 1 l	1	7.017 796
H 30	RET, RCT	Oil bath attachment, i. d. : 136 - 190 mm, H: 110 mm, Vol. : 1.5 l	1	7.017 797

Accessories for ETS-D5/ETS-D6 contact thermometer

IKA

Type	Description	PK	Cat. No.
H 44	Bosshead	1	9.232 994
H 16 V	Stainless steel support rod	1	9.720 257
H 62.51	Replacement sensor, stainless steel	1	9.232 998
H 66.51	Stainless steel sensor, glass sleeved	1	9.232 999
H 70	Extension cable, 1 metre	1	9.233 000
H 11	Replacement power cable	1	9.720 276
H 38	Holding rod	1	9.232 996

4. Stirring, Shaking, Mixing Magnetic stirrers / Hotplates/With heating and motor

Electronic Contact thermometer ETS-D5/ETS-D6

3 possible operation modes guarantee optimum adjustment to your application:

Operating mode A: Suitable for work with varying parameters (from -50°C to 450°C).

Adjustable safety temperature

Operating mode B: Suitable for repeated operation under uniform conditions and parameters

Operating mode C: Suitable for unsupervised operation

- with optimised PID control
- reset function
- includes stainless steel sensor probe H 62.51
- for all magnetic stirrers with a DIN 12878 class 2 contact thermometer connection, e.g. IKA®, Heidolph and Corning with adapter AD-C1.

ETS-D6 additionally with integrated pH measuring instrument (without pH electrode) and large, graphic LCD display with multilingual user guide.

Specifications

Temperature

Measuring range:	-50 to 450°C
Resolution:	±0.1K
Accuracy*:	±0.2K
Control accuracy:	0.1K
Control accuracy (with sensor)	±0.5K
Voltage:	8 to 16V d.c.
Current (at 9V)	15 mA
Connection:	DIN 12878 Class 2
Operating range:	0 to 60°C
Max. R.H.:	80%
Protection class:	IP54
Connector:	6-pole, DIN 45322
Weight:	0.2kg
Tested to DIN EN IEC 61010-1.	

Type	Dimensions (W x D x H) mm	PK	Cat. No.
ETS-D5	82 x 22 x 83	1	9.720 241
ETS-D6	96 x 45 x 98	1	9.720 242



9.720 241



9.720 242

3 Multiposition magnetic stirrer with heating Multi-HS digital



For synchronous stirring and heating at homogeneous temperatures up to 120°C.

Velp Scientifica

- CerAlTop™ plate - easy cleaning and maximum resistance
- Brushless motor guarantees constant speed
- SpeedServo™ technology maintains speed constant when viscosity changes
- Digital interface with icons
- Integral timer
- Programmable auto-reverse of the stirring direction
- Safe hot plate warnings when the plate temperature is above 50°C
- The Lock feature prevents unintentional changes

Specifications

Max. stirring quantity per stirring position (H ₂ O):	Multi-HS 6 // Multi-HS 15 400 ml // 250 ml
Number of stirring positions:	6 // 15
Temperature range:	0 ... 120 °C
Speed range:	100 ... 1000 min ⁻¹
Timer:	1 min ... 99 h : 59 min
Plate dimension:	223 x 432 mm
Distance between stirring positions:	100 mm // 74 mm
Dimensions (W x D x H):	240 x 550 x 65 mm
Weight:	4.7 kg // 4.8 kg
Power rating:	620 W
Heating output:	600 W
Power supply:	230 V/50 ... 60 Hz



Type	PK	Cat. No.
Multi-HS 6	1	4.678 195
Multi-HS 15	1	4.678 196

4. Stirring, Shaking, Mixing

Magnetic stirrers / Hotplates/With heating and motor

1 Magnetic stirrer with heating, 3-Position, SB162-3

With 3 independently adjustable aluminium hotplates, Overheat protection mechanism and warning light which switches on when the plate temperature exceeds 50°C. With facility for mounting a 12.5mm retort rod at the rear of each plate and 3mm x 25mm PTFE coated followers. With BioCote, silver-based, antimicrobial protection.

Stuart

Specifications

Max. stirring quantity (H ₂ O):	15l
Speed range:	100 - 1500rpm
Heat output:	3 x 700W
Max. plate temperature:	325 °C
Set-up plate (W x D):	3 x 160 x 160 mm
Dimensions (W x D x H):	600 x 270 x 110mm
Weight:	11kg
Power supply:	230V, 50Hz
IP code:	IP 32

Type	PK	Cat. No.
SB162-3	1	9.950 424



2 Magnetic stirrers/hotplates, multi-position, RT 5/10/15

Digital magnetic hotplate stirrers with 5, 10 or 15 positions, designed for synchronous heating and stirring. The magnetic coil technology provides noiseless and consistent stirring on all positions. The surface temperature is infinitely adjustable up to 120°C, producing a maximum medium temperature of 70°C (depending on type of vessel). Speed remains constant, even when load changes.

IKA



9.720 603

- Homogeneous temperature distribution across heating plate
- Adjustable reverse operation
- Eco-mode for a low self-warming of the surface
- Wear free magnetic coils
- Error code display
- Easy operation with touch keypad
- Suitable for continuous operation
- Adjustable speed in increments of 10rpm



9.720 609

Specifications

Max. stirring quantity per stirring position (H ₂ O):	0.4 l
Distance between stirring places:	90 mm
Speed range:	0 to 1000 rpm
Heating rate (1l H ₂ O in H15):	3 K/min
Temperature range heating plate:	RT to 120 °C
Max. temperature medium (dep. on vessel):	70 °C
Temperature display:	LED
Heat control accuracy:	±1 K
Speed display:	LED line
Set-up plate material:	aluminium alloy
Protection class acc. to DIN EN 60529:	IP 40
Power supply:	100-240 V, 50/60 Hz

Type	Stirring positions	Dimensions (W x D x H)	Plug type	Weight	PK	Cat. No.
		mm		kg		
RT 5	5	120 x 610 x 60	EU	4.0	1	9.720 603
RT 5	5	120 x 610 x 60	UK	4.0	1	9.720 604
RT 5	5	120 x 610 x 60	CH	4.0	1	9.720 605
RT 10	10	190 x 610 x 60	EU	7.5	1	9.720 606
RT 10	10	190 x 610 x 60	UK	7.5	1	9.720 607
RT 10	10	190 x 610 x 60	CH	7.5	1	9.720 608
RT 15	15	280 x 610 x 60	EU	10.5	1	9.720 609
RT 15	15	280 x 610 x 60	UK	10.5	1	9.720 610
RT 15	15	280 x 610 x 60	CH	10.5	1	9.720 611

4. Stirring, Shaking, Mixing

Magnetic stirrers / Hotplates/Accessories, Magnetic stirring bars

1 2 3 LLG-Universal reaction block system for magnetic stirrers

Universal alternative to oil bath

The reaction block allows syntheses to be carried out in round flasks at temperatures of up to 250 °C. As a result, with this system, oil as a heat transfer media is made redundant and your lab is a safer place. The reaction block ensures safety at work and prevents oil baths and heating mantles from overheating in your lab. The messy oil clean-ups that results from changing oil or removing flasks from an oil bath will be eliminated. Injuries and burns from hot oil will never happen again. Uniform mixing is also guaranteed because there is no interference to the magnetic field from the aluminium blocks. This system ensures optimal heat transfer from the heating plate directly into the medium.

- **Universal model**
- **For round plates of 135 to 145mm diameter**
- **With adapter plate for all square plates of min. 145mm length side**

- Reaction blocks are available in six standard sizes.
- Delivered adapter allows the use with either IKA or Heidolph magnetic stirrers.
- Syntheses in round flasks without oil bath up to 250 °C.
- Uniform and constant mixing
- High-precision thermal conduction directly into the reaction block
- Safe and clean working
- Made in Germany

Description	PK	Cat. No.
LLG-Universal reaction block system 50ml	1	9.728 890
LLG-Universal reaction block system 100ml	1	9.728 891
LLG-Universal reaction block system 250ml	1	9.728 892
LLG-Universal reaction block system 500ml	1	9.728 893
LLG-Universal reaction block system 1000ml	1	9.728 897
LLG-Universal reaction block system 2000ml	1	9.728 898
Adapter plate for rectangular hotplates, for attachment 1000 and 2000ml	1	9.728 900
2 spare screws (countersunk), for attachment 1000 and 2000ml	1	9.728 901



4 LLG-Magnetic stirring bars, cylindrical, PTFE, *eco pack*

Circular, smooth and PTFE-coated. Packaging size: 10 pieces

Diam. mm	Length mm	PK	Cat. No.
6	10	10	9.198 910
3	12	10	9.198 766
6	15	10	9.198 919
6	20	10	9.198 920
6	25	10	9.198 925
8	25	10	9.198 767
6	30	10	9.198 930
6	35	10	9.198 935
8	40	10	9.198 940
8	45	10	9.198 945
8	50	10	9.198 950
9	60	10	9.198 960
9	70	10	9.198 970
9	80	10	9.198 980

4



4. Stirring, Shaking, Mixing

Magnetic stirrers / Hotplates/Accessories, Magnetic stirring bars



1 Magnetic stirring bars, PTFE, cylindrical

BRAND



PTFE-coated. Cylindrical. Round, smooth surface. Versatile. Autoclavable. Further sizes available on request.

Diam. mm	Length mm	PK	Cat. No.
2.5	2.5	1	9.197 502
3.5	3.5	1	9.197 505
2.0	5.0	1	9.197 503
3.0	6.0	1	9.197 506
2.0	7.0	1	9.197 504
3.0	8.0	1	9.197 509
3.0	10.0	1	9.197 507
6.0	10.0	1	9.197 510
4.5	12.0	1	9.197 512
3.0	13.0	1	9.197 508
6.0	15.0	1	9.197 515
4.5	15.0	1	9.197 514
6.0	20.0	1	9.197 520
6.0	25.0	1	9.197 525
6.0	30.0	1	9.197 530
6.0	35.0	1	9.197 535
8.0	40.0	1	9.197 540
8.0	45.0	1	9.197 545
8.0	50.0	1	9.197 550
9.0	60.0	1	9.197 560
9.0	70.0	1	9.197 570
9.0	80.0	1	9.197 580
27.0	108.0 *	1	7.019 622
27.0	159.0 *	1	7.019 623

* flattened sides



6.267 317

2 Magnetic stirring bar behrotest, set 1 + 2

Magnetic stirring bars behrotest®, Set 1 in a transparent box with hinged lid

behr

Consisting of:

2x 20 x 6 mm, 2x 25 x 6mm, 2x 30 x 6 mm, 2x 40 x 8 mm, 1x 50 x 8 mm, 1x 60 x 9 mm

Magnetic stirring bars behrotest®, Set 2 in a transparent box with hinged lid including magnetic stirring bar retriever, length 245 mm

Consisting of:

1x 15 x 6 mm, 2x 20 x 6 mm, 2x 25 x 6mm, 1x 30 x 6 mm, 2x 40 x 8 mm, 1x 50 x 8 mm, 1x 60 x 9 mm

Both sets with a deep insert for easier removal and sorting of the stirring bars.



6.267 318

Description	PK	Cat. No.
MS-Set 1	1	6.267 317
MS-Set 2	1	6.267 318



4 Magnetic stirring bars, triangular, PTFE

BRAND

Triangular. PTFE-coated. Wedge-shaped, ideal for dissolving solids and re-suspending sediments due to scraping action. Angular surface produces high turbulence, even at low stirring speeds.

Diam. mm	Length mm	PK	Cat. No.
8	25	1	9.197 652
14	25	1	7.019 672
10	35	1	7.019 673
14	40	1	9.197 654
12	50	1	7.019 675
14	55	1	9.197 655
16	80	1	9.197 658

4. Stirring, Shaking, Mixing

Magnetic stirrers / Hotplates/Accessories, Magnetic stirring bars

1 Magnetic stirring bars ASTEROID, triangular, PTFE



2mag



More than 4x higher torque transmissible. Unbeatably enhanced mixing effect in comparison to conventional stirring bars. Strong, stable, long-lasting magnetic field, with no demagnetization effect. Concave design for minimal surface contact and reliable rotation, triangular shape for powerful shear force and enhanced mixing at lower rotational speeds. Significantly higher rotation speeds achievable, high quality, even and sealed PTFE encapsulation. Conform to FDA requirements, steam sterilisable at 121 °C. Multiple enhancements against all types of magnetic stirrers.

Diam. mm	Length mm	PK	Cat. No.
12	25	1	9.646 057
32	40	1	9.646 040
39	70	1	9.646 058

2 Magnetic stirring bars, oval, PTFE

Encapsulated in PTFE. Oval. Ideal for round bottom flasks.

BOLA



Diam. mm	Length mm	PK	Cat. No.
10	20	1	9.197 590
12	25	1	9.197 591
15	30	1	9.197 592
15	35	1	9.197 593
20	40	1	9.197 594
20	50	1	9.197 595

3 Magnetic stirring bars, PTFE, oval

For vessels with round bottom.

BRAND



Diam. mm	Length mm	PK	Cat. No.
5	10	1	7.019 637
6	15	1	7.019 638
10	20	1	6.072 442
12	25	1	6.073 271
15	32	1	6.072 441
15	34	1	4.667 792
20	40	1	4.667 793
20	50	1	4.667 794
20	65	1	9.197 596
20	70	1	9.197 597

4 Magnetic Stirring Beakerliner, PTFE

PTFE-encapsulated magnetic core (Alnico 5) axially mounted in a guide cage made of PTFE, universal chemical resistance. No shear action on the bottom of the beaker, smooth running in glass beakers also on an uneven bottom. The cage acts like a baffel and thus provides optimum mixing results.

BOLA



For beaker ml	Ext. diam. mm	Height mm	Length mm	Diam. mm	PK	Cat. No.
400	67	21	50	8	1	9.197 585
600	74	28	60	9	1	9.197 586
2000	103	32	80	10	1	9.197 587
3000, 5000	125	48	106	25	1	9.197 588

5 LLG-Magnetic Stirring Bar Retrievers, PTFE

PTFE-encapsulated stirring bar retriever with strong permanent magnet (Alnico 5), universal chemical resistance. For the removal of stirring bars from aggressive liquids, prevents loss of stirring bars. Lower end diameter 10mm.



Diam. mm	Length mm	PK	Cat. No.
8	150	1	9.197 717
8	250	1	9.197 725
8	300	1	4.008 501
8	350	1	9.197 735

1 2 Overhead stirrer LLG-uniSTIRRER OH2, digital

Cost-effective laboratory stirrer designed for simple stirring tasks for quantities up to 20 l (H₂O). Automatic speed adjustment in the range between 50 and 2200 min⁻¹ via microprocessor-controlled technology. Safety circuits ensure automatic cut-off in an anti-stall or overload situation. Actual and set speed are constantly monitored ensuring no undesired speed variations, even if the sample viscosity changes.

- Brushless, maintenance-free motor
- Digital speed display
- **Display for speed or torque changeable**
- Infinitely adjustable speed
- **Overload protection**
- Non-slippery mat
- Slim casing
- Quiet operation
- Error code display
- RS232 port

Stand:

Stainless steel stand incl. boss head, dimension (W x D x H): 200 x 310 x 780 mm, non-slippery mat

Stirrer:

4-blade propeller stirrer, stainless steel, shaft length 400 mm, stirrer diameter 50 mm

Scope of supply: Overhead stirrer LLG-uniSTIRRER OH2, stand, non-slippery mat and 4-blade-propeller stirrer

Specifications

Max. stirring quantity (H ₂ O):	20 l
Speed range:	50 ... 2.200 min ⁻¹
Max. viscosity:	10.000 mPas
Motor rating input/output:	60/50 W
Speed display accuracy:	±3 min ⁻¹
Max. torque at stirring shaft:	40 Ncm
Display:	LCD
Chuck range:	0.5 ... 10 mm
Dimensions (W x D x H):	83 x 186 x 220 mm
Power supply:	110 ... 240 V, 50/60 Hz
IP code:	IP 21
Warranty:	3 years

Type	Plug type	PK	Cat. No.
LLG-uniSTIRRER OH2	EU	1	6.263 455
LLG-uniSTIRRER OH2	UK	1	6.263 456

Accessories for Overhead stirrer LLG-uniSTIRRER OH2

Description	PK	Cat. No.
4-blade propeller stirrer, diam. 50, shaft diam. 8, 400 mm	1	6.263 454
2-blade propeller stirrer, diam. 60, shaft diam. 8, 400 mm	1	6.263 457
3-hole paddle stirrer, diam. 67, shaft diam. 8, 400 mm	1	6.263 458
2-blade centrifugal stirrer, diam. 80, shaft diam. 8, 400 mm	1	6.263 459
Spare boss head	1	6.263 453
Replacement power adapter	1	6.263 452



1 Overhead Stirrer Nanostar 7.5 digital



1

This powerful overhead stirrer convinces with perfect basic functionalities. It has a compact, space-saving design and is easy-to-use.

- Operation via a stable rotary knob
- Hardened glass display for maximum visibility and chemical resistance
- Display clearly shows the rotational speed
- Regular software updates can be made rapidly and simply via the USB interface
- Chemical resistant housing
- Microprocessor-controlled speed governor for constant rotational speed, even with changes in viscosity
- 10 years warranty



Specifications

Stirring quantity max. (H ₂ O):	5 l
Max. viscosity:	4000 mPas
Motor rating input/output:	32 W/22 W
Speed range:	0/50 ... 2000 rpm
Max. torque:	7.5 Ncm
Display:	LED
Chuck range:	0.5 ... 8 mm
Dimensions (W x D x H):	53 x 130 x 147 mm
Weight:	0.8 kg
Protection class DIN EN 60529:	IP 54
Power supply:	100 ... 240 V, 50/60 Hz

Type	PK	Cat. No.
Nanostar 7.5 digital	1	6.311 510

Overhead Stirrers MICROSTAR Digital

2

These powerful overhead stirrers convince with perfect basic functionalities. They have a compact, space-saving design and are easy-to-use.

- Operation via a stable rotary knob
- Hardened glass display for maximum visibility and chemical resistance
- Display clearly shows the rotational speed
- Regular software updates can be made rapidly and simply via the USB interface
- Chemical resistant housing
- Microprocessor-controlled speed governor for constant rotational speed, even with changes in viscosity
- 10 years warranty



6.274 940

Specifications

	7.5 digital // 15 digital // 30 digital
Stirring quantity max. (H ₂ O):	5 l // 10 l // 20 l
Max. viscosity:	4000 mPas // 8000 mPas // 20000 mPas
Motor rating input/output:	32 W/22 W
Speed range:	0/50 ... 2000 rpm // 0/50 ... 1000 rpm // 0/50 ... 500 rpm
Max. torque:	7.5 Ncm // 15 Ncm // 30 Ncm
Display:	LED
Chuck range:	0.5 ... 8 mm
Dimensions (W x D x H):	60 x 126 x 173 mm
Weight:	1.18 kg // 1.26 kg // 1.26 kg
Protection class DIN EN 60529:	IP 54
Power supply:	100 ... 240 V, 50/60 Hz

Type	PK	Cat. No.
MICROSTAR digital 7.5	1	4.665 208
MICROSTAR digital 15	1	6.313 057
MICROSTAR digital 30	1	6.274 940

1

4.665 663

Overhead Stirrers MINISTAR Digital

These powerful overhead stirrers convince with perfect basic functionalities. They have a compact, space-saving design and are easy-to-use.

IKA

- Operation via a stable rotary knob
- Hardened glass display for maximum visibility and chemical resistance
- Display clearly shows the rotational speed
- Regular software updates can be made rapidly and simply via the USB interface
- Chemical resistant housing
- Microprocessor-controlled speed governor for constant rotational speed, even with changes in viscosity
- 10 years warranty

Specifications

Stirring quantity max. (H ₂ O):	20 digital // 40 digital // 80 digital 15 l // 25 l // 50 l
Max. viscosity:	10000 mPas // 30000 mPas // 60000 mPas
Motor rating input/output:	60 W/46 W
Speed range:	0/50 ... 2000 rpm // 0/50 ... 1000 rpm // 0/50 ... 500 rpm
Max. torque:	20 Ncm // 40 Ncm // 80 Ncm
Display:	LED
Chuck range:	0.5 ... 8 mm
Dimensions (W x D x H):	70 x 147 x 193 mm
Weight:	1.56 kg // 1.72 kg // 1.72 kg
Protection class DIN EN 60529:	IP 54
Power supply:	100 ... 240 V, 50/60 Hz

Type	PK	Cat. No.
MINISTAR 20 digital	1	7.983 353
MINISTAR 40 digital	1	4.665 663
MINISTAR 80 digital	1	7.983 354

2

2 Overhead stirrer EUROSTAR 20 digital

Overhead stirrer designed for simple stirring tasks for quantities up to 15 l (H₂O). It automatically adjusts the speed through microprocessor controlled technology within the speed range of 0/30 to 2000 rpm. Safety circuits installed ensures automatic cut-off in an anti-stall or overload conditions. Continuous comparison of shaft speed to desired speed is maintained and variations are adjusted automatically. This guarantees a constant speed even with changes in viscosities of the sample.

IKA

- Digital speed display
- Infinitely adjustable speed
- Push-through agitator shafts
- Overload protection
- Short-term overload operation

Specifications

Stirring quantity max. (H ₂ O):	15 l
Max. viscosity:	10000 mPas
Motor rating input/output:	70/42 W
Speed range:	0/30 to 2000 rpm
Max. torque at stirring shaft:	20 Ncm
Display:	LED
Chuck range:	0.5 to 10 mm
Dimensions (W x D x H):	86 x 208 x 248 mm
Weight:	4.4 kg
Protection class DIN EN 60529:	IP 42
Power supply:	230 V, 50/60 Hz

Type	Connector	PK	Cat. No.
EUROSTAR 20 digital	EU	1	9.816 691
EUROSTAR 20 digital	UK	1	9.816 692
EUROSTAR 20 digital	CH	1	9.816 693

1 Overhead stirrer EUROSTAR 40 digital

Universal laboratory stirrer designed for simple stirring tasks for quantities up to 25l (H₂O). It automatically adjusts the speed through microprocessor controlled technology within the speed range of 0/30 to 2000rpm. Safety circuits installed ensures automatic cut-off in an anti-stall or overload conditions. Continuous comparison of shaft speed to desired speed is maintained and variations are adjusted automatically. This guarantees a constant speed even with changes in viscosities of the sample.

IKA

- Digital speed display
- Infinitely adjustable speed
- Push-through agitator shafts
- Overload protection
- Short-term overload operation

Specifications

Stirring quantity max. (H ₂ O):	25l
Max. viscosity:	30000mPas
Motor rating input/output:	118/84W
Speed range:	0/30 to 2000rpm
Max. torque at stirring shaft:	40Ncm
Display:	LED
Chuck range:	0.5 to 10mm
Dimensions (W x D x H):	86 x 208 x 248mm
Weight:	4.4 kg
Protection class DIN EN 60529:	IP 42
Power supply:	230V, 50/60Hz

Type	Plug type	PK	Cat. No.
EUROSTAR 40 digital	EU	1	9.816 697
EUROSTAR 40 digital S 2	UK	1	9.816 698
EUROSTAR 40 digital S 3	CH	1	9.816 699

1



2 Overhead stirrer EUROSTAR 60 digital

Universally used strong overhead stirrer for quantities up to 40l (H₂O). It automatically adjusts the speed through microprocessor controlled technology within the speed range of 0/30 to 2000rpm. Safety circuits installed ensures automatic cut-off in an anti-stall or overload conditions. Continuous comparison of shaft speed to desired speed is maintained and variations are adjusted automatically. This guarantees a constant speed even with changes in viscosities of the sample.

IKA

- Digital speed display
- Infinitely adjustable speed
- Push-through agitator shafts
- Overload protection
- Short-term overload operation
- Slim casing
- Quiet operation
- Error code display

Specifications

Stirring quantity max. (H ₂ O):	40l
Max. viscosity:	50000mPas
Motor rating input/output:	176/126 W
Speed range:	0/30 to 2000rpm
Max. torque at stirring shaft:	60Ncm
Display:	LED
Chuck range:	0.5 to 10mm
Dimensions (W x D x H):	86 x 208 x 248mm
Protection class DIN EN 60529:	IP 42
Power supply:	230V, 50/60Hz

Type	Plug type	PK	Cat. No.
EUROSTAR 60 digital	EU	1	9.816 700
EUROSTAR 60 digital S 2	UK	1	9.816 701
EUROSTAR 60 digital S 3	CH	1	9.816 702

2



Accessories for the IKA overhead stirrers please see page 490

1

1 Overhead stirrer EUROSTAR 100 digital

NEW

IKA

Powerful laboratory stirrer for highly viscous applications and intensive mixing for quantities up to 100 l (H₂O). It automatically adjusts the speed through microprocessor controlled technology. Safety circuits installed ensures automatic cut-off in an anti-stall or overload conditions. Continuous comparison of shaft speed to desired speed is maintained and variations are adjusted automatically. This guarantees a constant speed even with changes in viscosities of the sample.

- Digital speed display
- Infinitely adjustable speed
- Push-through agitator shafts
- Overload protection
- Short-term overload operation
- Slim casing
- Quiet operation
- Error code display

Specifications

Stirring quantity max. (H ₂ O):	100 l
Max. viscosity:	70000 mPas
Motor rating input/output:	186/136 W
Speed range:	0/30 ... 1300 rpm
Max. torque at stirring shaft:	100 Ncm
Display:	LED
Chuck range:	0.5 ... 10 mm
Protection class DIN EN 60529:	IP 42
Power supply:	230 V, 50/60 Hz

Type	Dimensions (W x D x H) mm	Plug type	PK	Cat. No.
EUROSTAR 100 digital	86 x 208 x 248	EU	1	9.816 706
EUROSTAR 100 digital S 2	86 x 208 x 248	UK	1	9.816 707
EUROSTAR 100 digital S 3	86 x 208 x 248	CH	1	9.816 708

2

2 Overhead stirrer OHS 200 Digital

Velp Scientifica

Powerful, robust overhead stirrers with display and electronic speed control. With integrated timer and overload, overtemperature and overcurrent protection.

- For high viscosities up to 100000 mPas or large volumes up to 100 l
- With 2 speed gears
- Stable torque over the entire speed range with automatic compensation
- Torque indication in the display
- LED display
- Timer
- Key lock
- Brushless, quiet motor
- Rotor change without tools
- USB interface for installing software updates

Specifications

Number of speed gears:	2
Speed range:	6 ... 400 min ⁻¹ /30 ... 2000 min ⁻¹
Power rating:	190 W
Chuck range:	Ø 1 ... 13 mm
Display:	Digital
Dimensions (W x D x H):	90 x 235 x 315 mm
Weight:	4.6 kg
IP code:	IP 54
Power supply:	230 V, 50/60 Hz
Warranty:	3 years

Type	Stirring capacity	max. Viscosity	Torque	PK	Cat. No.
	l	mPa.	Ncm		
OHS 200 Digital	100	100000	200	1	4.666 656

Overhead stirrer EUROSTAR 400 digital/400 control



1

Powerful laboratory stirrer for highly viscous applications and intensive mixing for quantities up to 150 l (H₂O). It automatically adjusts the speed through microprocessor controlled technology. Safety circuits installed ensures automatic cut-off in an anti-stall or overload conditions. Continuous comparison of shaft speed to desired speed is maintained and variations are adjusted automatically. This guarantees a constant speed even with changes in viscosities of the sample.

EUROSTAR 400 digital:

- Digital speed display
- Infinitely adjustable speed
- Push-through agitator shafts
- Overload protection
- Short-term overload operation
- Slim casing
- Quiet operation
- Error code display

EUROSTAR 400 control additionally:

- Multilingual TFT display
- Programmable functions
- Integrated temperature measurement
- Interval operation
- Timer function
- Adjustable safety circuit
- Locked function
- Connection for external temperature sensor

Scope of supply EUROSTAR 400 control: Overhead stirrer, temperature sensor H 67.60, WiCo holder WH 11

IKA



6.291 143

Specifications

Stirring quantity max. (H₂O):

Max. viscosity:

Motor rating input/output:

Speed range:

Max. torque at stirring shaft:

Display:

Chuck range:

Dimensions (W x D x H):

Protection class DIN EN 60529:

Power supply:

EUROSTAR 400 control only:

Temperature sensor:

Temperature measuring range:

400 digital // 400 control

150 l

100000 mPas

220/176 W

0/6 ... 2000 rpm

400 Ncm

LED // TFT

3 ... 16 mm

114 x 245 x 325 mm // 114 x 268 x 345 mm

IP 42 // IP 40

230 V, 50/60 Hz

PT1000

-10 ... +350 °C

2



6.310 512

Type	Plug type	PK	Cat. No.
EUROSTAR 400 digital	EU	1	6.291 143
EUROSTAR 400 control	EU	1	6.310 512





**VELP LAB EQUIPMENT
IS DESIGNED AND
MANUFACTURED IN
ITALY TO PROVIDE
INNOVATIVE SOLUTIONS
AND RELIABILITY TO
SCIENTISTS.**

Heating Magnetic Stirrers

ARE/AREX-6 Series



More than hot plate stirrers! Superior Safety and state-of-the-art thermoregulation delivering you an Organic synthesis solution with all relevant accessories

Overhead Stirrers

OHS Series



Whatever your application, we've got you covered. Safe and powerful Overhead stirrers guaranteeing constant torque at any speed, ease-of-use, unique connectivity and reliability.

Vortex Mixers

IR Vortex



Unmatched experience! The truly ergonomic vortex mixer with patented IR sensor reducing arm stress.

Biochemical Oxygen Demand

BOD EVO



Perform your Biochemical Oxygen Demand analysis without altering the incubation condition. Manage up to 80 BOD sensors directly from your PC thanks to the unique connectivity of VELP BOD EVO.

www.velp.com

Via Stazione, 16 | 20865 Usmate (MB) - Italy | Tel. + 39 039 628811

Overhead stirrers OHS Advance

Powerful, robust overhead stirrers with digital display, electronic speed control and integrated PT100 temperature probe. With vibration sensor, timer and overload, overtemperature and overcurrent protection. **The connection via WLAN to the VELP Ermes Cloud Platform is used for uploading, managing, monitoring and exchanging results and parameters.** Access to the devices is possible via PC, Smartphone and Tablet.

Velp Scientifica

- Direct measurement of temperature in the medium via PT100 sensor
- Stable torque over the entire speed range with automatic compensation
- Torque indicated in display
- 3.5" TFT display
- Timer
- Key lock
- Brushless, quiet motor
- Easy rotor change without tools
- Various methods programmable
- USB interface for installing software updates and process documentation

Specifications	OHS 60 Advance // OHS 100 Advance
Number of speed gears:	1
Speed range:	30 ... 2000 min ⁻¹ // 30 ... 1300 min ⁻¹
Motor rating:	190 W
Chuck range:	Ø 1 ... 13 mm
Display:	Digital
Temperature measuring range:	-10 ... 350 °C
Temperature measuring accuracy:	0.1 °C
Dimensions (W x D x H):	90 x 235 x 285 mm
Weight:	4.1 kg
IP code:	IP 54
Power supply:	230 V, 50/60 Hz
Warranty:	3 years

Type	Stirring capacity	max. Viscosity	Torque	PK	Cat. No.
	l	mPa.	Ncm		
OHS 60 Advance	40	50000	60	1	4.666 655
OHS 100 Advance	100	70000	100	1	4.666 654

1



4.666 655

Overhead stirrer OHS 200 Advance

Powerful, robust overhead stirrers with digital display, electronic speed control and integrated PT100 temperature probe. With vibration sensor, timer and overload, overtemperature and overcurrent protection. **The connection via WLAN to the VELP Ermes Cloud Platform is used for uploading, managing, monitoring and exchanging results and parameters.** Access to the devices is possible via PC, Smartphone and Tablet.

Velp Scientifica

- With 2 speed gears
- For high viscosities up to 100000 mPas or large volumes
- Direct measurement of temperature in the medium via PT100 sensor
- Stable torque over the entire speed range with automatic compensation
- Torque indicated in display
- 3.5" TFT display
- Timer
- Key lock
- Brushless, quiet motor
- Easy rotor change without tools
- Various methods programmable
- USB interface for installing software updates and process documentation

Specifications	OHS 200 Advance
Number of speed gears:	2
Speed range:	6 ... 400 min ⁻¹ /30 ... 2000 min ⁻¹
Power rating:	190 W
Chuck range:	Ø 1 ... 13 mm
Display:	Digital
Temperature measuring range:	-10 ... 350 °C
Temperature measuring accuracy:	0.1 °C
Dimensions (W x D x H):	90 x 235 x 315 mm
Weight:	4.6 kg
IP code:	IP 54
Power supply:	230 V, 50/60 Hz
Warranty:	3 years

Type	Stirring capacity	max. Viscosity	Torque	PK	Cat. No.
	l	mPa.	Ncm		
OHS 200 Advance	100	100000	200	1	4.666 653

2





1 Overhead stirrer RW 20 digital

- Technical improvements on the trusted RW20 series design, mechanically controlled
- with digital display
- robust, ergonomic design
- constant power-drive
- two speed ranges for universal use from 60rpm to 2000rpm
- hollow-shafted chuck for rotor shaft height adjustment (only when stationary)

IKA

Specifications

Stirring volume max. (H ₂ O):	20L
Viscosity range:	up to 10000mPas
Motor rating input/output:	70/35W
Output max. at stirring shaft:	26W
Max. stirring shaft torque (at 100rpm.):	150Ncm
Speed range I (at 50Hz):	60 to 500rpm.
Speed range II (at 50Hz):	240 to 2000rpm.
Chuck range:	0.5 to 10mm
Diameter/length of extension arm:	13mm/160mm
Dimensions (W x D x H)	88 x 212 x 294mm
Weight:	3.1kg
Protection class acc. to DIN EN 60529:	IP20
Supply requirements:	230V 50/60Hz
Tested to DIN EN IEC 61010-1.	

Type	Plug type	PK	Cat. No.
RW 20 digital	EU	1	9.816 622
RW 20 digital	UK	1	6.227 717

Optional accessories: Stands: R 1825, R 1826, R 1827, R 182 Boss head, FK 1 Flexible coupling, RH 3 Strap clamp, R 301 Stirring shaft protection, Stirring elements: e.g. R 1342, R 1381



2 Overhead stirrer RW 28 digital

Powerful, mechanically controlled laboratory stirrer designed for highly viscous applications for quantities up to 80l (H₂O). It is suitable for intensive mixing for use in laboratories and pilot plants. The stirrer comes equipped with a protection for overheating of the motor by means of self-locking temperature limiter. Additionally, to secure bowls, a stirring shaft protection and clamping fixture are optionally available.

IKA

- Digital speed display
- Infinitely adjustable speed in two speed ranges
- Push-through agitator shafts
- Overload protection
- Error code display
- Robust, ergonomic design
- Quiet operation
- With constant power-drive

Specifications

Stirring quantity max. (H ₂ O):	80l
Max. viscosity:	50000mPas
Motor rating input/output:	220/90W
Speed range (at 50/60 Hz):	60 to 1400rpm/72 to 1680rpm
Speed range I (at 50/60 Hz):	60 to 400rpm/72 to 480rpm
Speed range II (at 50/60 Hz):	240 to 1400rpm/288 to 1680rpm
Max. torque at stirring shaft:	900Ncm
Display:	LED
Chuck range:	1 to 10mm
Dimensions (W x D x H):	123 x 252 x 364mm
Protection class DIN EN 60529:	IP 40
Power supply:	220-240V, /50/60Hz

Type	Plug type	PK	Cat. No.
RW 28 digital	EU	1	9.816 630
RW 28 digital S 2	UK	1	9.816 631
RW 28 digital S 3	CH	1	9.816 632

1 Stand with Laboratory balance IKA [scale] for overhead stirrers

NEW

The stand with integrated scale and data interface is ideally suited for the direct and controlled addition of sample material while stirring. The quantities of samples to be added are weighed immediately and continuously documented during the stirring process.

IKA

- Clear LCD display
- Stable die cast zinc housing
- Overload protection
- USB interface
- Bluetooth connection

Specifications

Weighing range:	5 ... 6000 g
Readability:	1 g
Accuracy:	±6 g
Load capacity weighing function:	max. 10 kg
Dimensions - Weighing plate:	200 x 200 mm
Dimensions (W x D x H):	213 x 391 x 570 mm
Weight:	5.2 kg
Power supply:	100 ... 240 V, 50/60 Hz
IP code:	IP 21

Type	PK	Cat. No.
IKA [scale]	1	4.672 719

2 Overhead stirrer STARVISC 200-2.5 control

NEW

High precision torque-measuring stirrer with direct display of the measured values for a wide range of applications. Especially suitable for product development, because precise measuring is taking place during the manufacturing process and the viscosity can be calculated via the user friendly display. Samples no longer have to be taken separately.

IKA

- Viscosity calculation
- Stepless adjustable speed
- With detachable remote control - Wireless Controller (WiCo)
- Powerful stirrer for highly viscous substances

Specifications

Stirring quantity max. (H ₂ O):	100 l
Max. viscosity:	100000 mPas
Motor rating input/output:	130 W/84 W
Speed range:	0/6 ... 2000 rpm
Speed range I (at 50Hz):	6 ... 400 rpm
Speed range II (at 50Hz):	30 ... 2000 rpm
Max. torque at stirring shaft:	200 Ncm
Display:	TFT
Chuck range:	0.6 ... 10 cm
Dimensions (W x D x H):	91 x 231 x 395 mm
IP code acc. to DIN EN 60529:	IP 40
Power supply:	230/100, 115/100 V, 50/60 Hz

Type	PK	Cat. No.
STARVISC 200-2.5 control	1	4.672 715



1

1 Overhead stirrers Hei-TORQUE Value

Ideal for all standard stirring tasks. They are designed to mix and disperse media that require non-reproducible results in high-viscosity applications.

Heidolph

- Indication of torque tendencies to monitor viscosity changes
- Digital 2.4" display for ease of operation
- Constant speed even under changing loads
- Safe start and stop of operation via slide touch panel
- Minimum noise level at maximum power (<50 dB)

2

2 Overhead stirrers Hei-TORQUE Value 100

Heidolph
Specifications

Max. stirring quantity (H ₂ O):	50 l
Speed range:	10 ... 2000 rpm
Max. viscosity:	60000 mPas
Motor rating input/output:	90/50 W
Max. torque at stirring shaft:	100 Ncm
Display:	digital
Chuck range:	8 ... 10.5 mm
Dimensions (W x D x H):	86 x 247 x 350 mm
Weight:	4.4 kg
Power supply:	230 V, 50/60 Hz
Protection class:	IP 54

Type	Plug type	PK	Cat. No.
Hei-TORQUE Value 100	EU	1	7.981 688
Hei-TORQUE Value 100	UK	1	6.283 476

3

3 Overhead Stirrers Hei-TORQUE Core

Heidolph

Compact, electronic overhead stirrer for easy operation.

- Can be integrated in closed systems such as fume hoods, reactors or production systems
- Suitable for low to medium viscosity media
- Quick-action chuck for stirring tools up to 10 mm diameter
- "Max" button for short-term operation at maximum speed
- Timer function
- Digital rotation speed display
- Automatic switch-off with overheating protection

Specifications

Stirring quantity max. (H ₂ O):	25 l
Speed range:	20... 2000 rpm
Max. viscosity:	10000 mPas
Motor rating input/output:	105/75 W
Max. torque at stirring shaft:	40 Ncm
Display:	digital
Chuck range:	8 ... 10.5 mm
Dimensions (W x D x H):	70 x 195 x 281.5 mm
Weight:	2.3 kg
Power supply:	230 V, 50/60 Hz
Protection class:	IP 42

Type	PK	Cat. No.
Hei-TORQUE Core	1	4.662 304

Accessories for Overhead Stirrers Hei-TORQUE

Heidolph

Type	For	PK	Cat. No.
Stand clamp for holder rod 13 to 32mm	Hei-TORQUE	1	9.816 562
Stand S 2, 425 x 420 x 700mm, 5.8kg	Hei-TORQUE	1	9.816 564
Stirrer shaft guard, PMMA, height-adjustable	Hei-TORQUE Core	1	9.816 566
Stirrer shaft guard, PMMA, height-adjustable	Hei-TORQUE	1	6.284 078
Flexible shaft including chuck, 8mm	Hei-TORQUE	1	7.047 043
Base Stand S2 XXL	Hei-TORQUE	1	6.228 500
Stirrer shaft gland NS 29/32 - PTFE	Hei-TORQUE	1	7.076 415
Telescopic stand	Hei-TORQUE	1	7.621 811



3 Flexible clutch

Required for stirring tasks using glass stirring rods. The flexible coupling compensates for any structural variances.

Clamping range: 6 to 10mm
Torque max. 10 Ncm

Type	PK	Cat. No.
FK 1	1	9.197 060



Globe Stirrer Couplings, POM

Made of POM, a plastic material with a good mechanical strength, powerful transmission of up to 300 Ncm, suitable for a speed of up to 1.200 rounds per minute, maximum misalignment of axes 10 mm. Ideal for balancing misalignment of axes between agitator and stirrer shaft, suitable for glass, metal or PTFE stirrer shafts.

BOLA

- very low centrifugal forces due to low weight
- suitable for both left and right-handed rotation
- no resonance
- simple assembly by means of screw joints with clamp rings
- pivot (length 90 mm) can be shortened by the user

Opening for stirrer shaft	Chuck adaptor Ø bottom	Overall length	PK	Cat. No.
mm	mm	mm		
Diam. 6.5 + 10	10	190	1	6.240 637
Diam. 8 + 10	10	190	1	7.632 676
Inner square SW6	SW8	180	1	6.231 539



7.632 676

5 Keyless chuck for overhead stirrers

Only for use with EUROSTAR 20/40/60/100/200/RW 20, excluding EUROSTAR 20 high speed digital and control.

Clamping range: 0.5 to 10 mm.

NEW

IKA



Type	PK	Cat. No.
R 60	1	6.258 335

1

9.779 201

Magnetic stirrer bearing with ground joint

Stirrer head with a permanent magnetic coupling for mixing applications under vacuum. No straight-through shaft, no shaft sealing rings required as the torque is provided contactless by magnetic force.

Buddeberg

Rotational speed: 2500rpm
 Material: 1.4435 (AISI 316L)
 Seal: Viton
 Bearings: Ball bearing steel

Type	Joint size	Capacity	Temp. range		For fluid viscosity	Torque	PK	Cat. No.
			NS	ml				
BUK K20 S1	29/32	500	240		500	20	1	9.779 201
BUK K40 S1	29/32	1000	240		1500	40	1	9.779 202
BUK K60 S1	29/32	3000	240		6000	60	1	9.779 203
BUK K90 S1	29/32	5000	240		10000	90	1	9.779 204

2

2 Connection couplings

Fixed-diameter connection between motor and stirring shaft. Suitable for use in potentially explosive atmospheres (ATEX). Material no. 1.4404

Buddeberg

Type	For	PK	Cat. No.
VK 14 x 10	BSR 64 with stand	1	6.287 716
VK 14 x 14	BSR 64 with stand	1	6.287 718
VK 7 x 8	BUK/MRK	1	9.779 342

3

9.224 292

4

9.224 293

Bossheads for overhead stirrers

IKA

Type	Jaw opening mm	PK	Cat. No.
R 182	Stand / extension arm: 6 to 16	1	9.224 292
R 270	Stand / extension arm: 25 to 36 / 5 to 21	1	9.224 293
R 271	Stand / extension arm: 34 / 16	1	9.224 266

6

9.224 762

5

9.224 761

Strap clamps for overhead stirrers

IKA

Type	Rod diam.	Vessel diam.	PK	Cat. No.
	mm	mm		
RH 3	8 to 16	40 to 300	1	9.224 761
RH 5*	25 to 36	40 to 300	1	9.224 762

*with R 270 bosshead

8

9.816 735

7

9.224 026

Stands for overhead stirrers

IKA

Type	Description	Rod diam.	Height	Max. load	PK	Cat. No.
		mm	mm	kg		
R 1825	Stand with baseplate	16	560	5	1	9.224 031
R 1826	Stand with baseplate	16	800	5	1	9.224 032
R 1827	Stand with baseplate	16	1000	5	1	9.224 033
R 2722	H-stand	34	1010	10	1	9.224 026
R 2723	Telescopic stand	34	620 - 1010	10	1	9.224 028
R 474	Telescopic stand	48	500 - 1000	30	1	9.816 735
R 472	Floor stand	80x80	980 - 1860	30	1	9.816 736

Further stands available on request.

4. Stirring, Shaking, Mixing Overhead stirrers/Stirrer Heads-Stirrers

3 PLR compressed air laboratory stirrers up to 30 L for use in potentially explosive atmospheres, without/with tachometer

PLR compressed air laboratory stirrers are designed for all kinds of standard mixing tasks. The vane type, air-driven motor offers a high power density and is significantly lighter and smaller than an equivalent electric motor.

Buddeberg

General specifications:

- operating pressure max. 6 bar
- air consumption 260 L/min. at 6 bar
- power output 200W at 6 bar
- clockwise rotation
- ATEX certification

Basic models include:

- all-stainless steel housing
- continuously adjustable speed control valve
- support arm diam. 14 mm
- snap connection for NW 5
- output shaft L x diam. 26 x 10 mm



Type	Capacity max.	Off-load speed	Torque	For fluid viscosity	Rating	ATEX certification	PK	Cat. No.
	litres	rpm.	Nm	mPa.	W			
PLR 10	3	15000	0.3	1000	200	Ex II 2G Ex h IIC T4 Gb	1	9.778 950
PLR 11	30	1900	3.5	50000	200	Ex II 2G Ex h IIC T5 Gb	1	9.778 951
PLR 12	30	870	5.3	70000	200	Ex II 2G Ex h IIC T5 Gb	1	9.778 952
PLR 28	30	580	10.4	100000	200	Ex II 2G Ex h IIC T5 Gb	1	9.778 954
PLR 13	30	80	19.8	150000	200	Ex II 2G Ex h IIC T5 Gb	1	9.778 953
PLR 10T*	3	15000	0.3	1000	200	Ex II 2G Ex h IIC T4 Gb	1	9.778 960
PLR 11T*	30	1800	3.5	50000	200	Ex II 2G Ex h IIC T5 Gb	1	9.778 961
PLR 12T*	30	950	5.3	70000	200	Ex II 2G Ex h IIC T5 Gb	1	9.778 962
PLR 28T*	30	550	10.4	100000	200	Ex II 2G Ex h IIC T5 Gb	1	9.778 964
PLR 13T*	30	80	19.8	150000	200	Ex II 2G Ex h IIC T5 Gb	1	9.778 963

* analogue tachometer

The viscosity data are intended as a guideline.

4 Compressed air industrial stirrers BSR 64 with floor stand

BSR series stirrers perform routine mixing tasks up to 200 l.

Buddeberg

General specifications:

- operating pressure max. 6 bar
- air consumption 800 l/min. at 6 bar
- power output 640 W at 6 bar
- clockwise rotation
- ATEX rating to Ex II 2G Ex h IIC T5 Gb

Basic models include:

- all-stainless steel housing
- continuously adjustable speed control valve
- spherical clamping device with support arm diam. 16 mm, length 200 mm
- floor stand with rod (height 1000 mm, width 600 mm) and bosshead
- plug-in connector DN 7.8
- silencer
- output shaft L 32 mm x diam. 14 mm



Type	Capacity max.	Off-load speed	For fluid viscosity	Rating	PK	Cat. No.
	litres	rpm.	mPa.	W		
BSR 64/160-A-V	200	1600	20000	640	1	9.779 163
BSR 64/65-A-V	200	650	50000	640	1	9.779 164
BSR 64/30-A-V	200	300	100000	640	1	9.779 165

Stands

Floor stand BS

with angled foot, side length 600 mm, rod diam. 34 mm.

Buddeberg

Wall bracket WS

Rod diam. 34 mm, clearance from wall: 200 mm.

Type	Description	Length mm	PK	Cat. No.
BS 1	Floor stand	1000	1	9.224 000
BS 2	Floor stand	1500	1	6.206 348
BS 3	Floor stand	1000	1	6.314 306
WS	Wall bracket	1000	1	6.225 791





9.198 010



9.779 013



9.779 065

Compressed air powered stirrers, PLR, accessories

Buddeberg

Connection couplings VK:

Fixed-diameter connection for motor/magnetic coupling drive shaft and stirring rod. Suitable for use in potentially explosive atmospheres. Material No. 1.4404.

Flexible glass stirring shaft couplings PK:

For stirring tasks using glass stirring rods. Elastic connector between motor and stirring shaft. Provides exact alignment of motor and shaft, and evens out axial and height differences. Accepts 6mm to 10mm diameter shafts.

Flexible glass stirring shaft couplings K:

For stirring tasks using glass stirring rods. Elastic connector between motor and stirring shaft. Provides exact alignment of motor and shaft, and evens out axial and height differences. Accepts 6mm to 10mm diameter shafts

Double-Cardan-Coupling DCK I:

With 8mm dia. hexagonal input drive receiver and 6mm square socket drive output.

Type	Description	PK	Cat. No.
VK 10x8	Connection couplings 10 x 8 mm	1	6.286 426
VK 10x10	Connection couplings 10 x 10 mm	1	6.285 834
PK 10	Flex coupling receiver i. d. 10mm	1	9.779 013
PK 10/13	Flex coupling receiver i. d. 10/13mm	1	9.779 014
K 10	Flex coupling receiver i. d. 10mm	1	9.198 010
K 10/13	Flex coupling receiver i. d. 10/13mm	1	9.197 400
DCK I	Stainless steel, L = 110mm	1	9.779 065



How to select the correct stirring rotor size

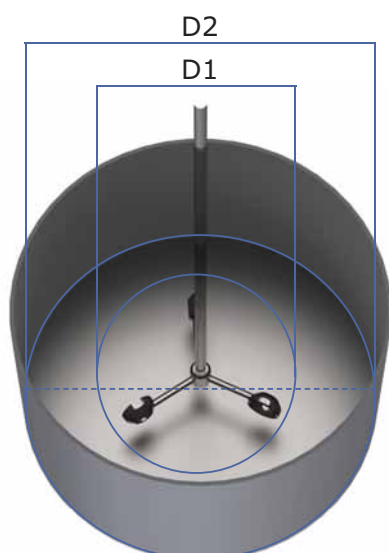

Propeller stirrer

 $D1 = D2 \times \text{min. } 0.1 \text{ to max. } 0.5$

Diagonal blade stirrer

 $D1 = D2 \times \text{min. } 0.25 \text{ to max. } 0.5$

Anchor stirrer

 $D1 = D2 \times \text{min. } 0.9 \text{ to max. } 0.98$

Dissolver stirrer

 $D1 = D2 \times \text{min. } 0.2 \text{ to max. } 0.5$

BuddeMix

 $D1 = D2 \times \text{min. } 0.3 \text{ to max. } 0.75$

Buddeberg Laboratory Technology GmbH develops and manufactures explosion-protected compressed air laboratory stirrers and industrial stirrers as well as magnetic stirrer couplings and drives for the chemical, pharmaceutical, coating and food industry.

Furthermore, we offer **individual solutions** tailored to suit your special requirements. Please feel free to contact us.

Your Contact

Marcel Schreiber

☎ +49 621 87690-52

📠 +49 621 87690-39

✉ schreiber@buddeberg.de

4. Stirring, Shaking, Mixing Overhead stirrers/Stirrers

1 2 Propeller stirring rotors, 3-blade, stainless steel 1.4305

The 3-blade propellers produce axial flow, and reduce shear forces to a minimum, even at high stirring speeds, thanks to their optimised blade design. Recommended for medium to high speed operations. Other sizes available on request.

Type	∅ agitator mm	∅ agitator shaft mm	Length mm	PK	Cat. No.
R 1381	45	8	350	1	9.197 021
R 1382	55	8	350	1	9.197 022
R 1385	140	10	550	1	9.197 023
R 1388	140	10	800	1	9.197 024

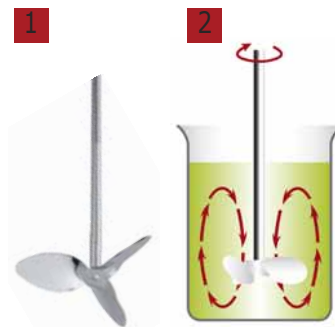

3 4 Diagonal blade stirring rotors, 4-blade, stainless steel 1.4305

The 4-blade diagonal blade stirring rotor provides axial flow and creates increasing shear forces at higher stirring speeds. Recommended for medium to high speed operations. Other sizes available on request.

∅ agitator mm	∅ agitator shaft mm	Length mm	PK	Cat. No.
50	8	350	1	9.197 006
100	8	540	1	9.197 009
100	10	550	1	4.662 011

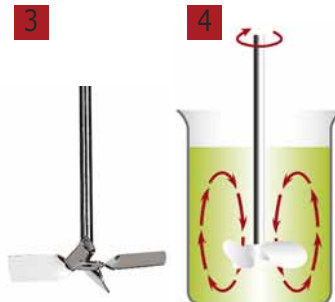

5 6 Turbine stirring rotors, 3-blade with guide ring, stainless steel 1.4305

The 3-blade turbine stirring rotor produces axial flow; the guide ring surrounding the blades reduces shear forces, and offers protection when contacting the wall or bottom of the vessel. Recommended for medium to high speed operations.

∅ agitator mm	∅ agitator shaft mm	Length mm	PK	Cat. No.
30	8	350	1	9.197 030
50	8	350	1	9.197 031
70	10	400	1	9.197 032

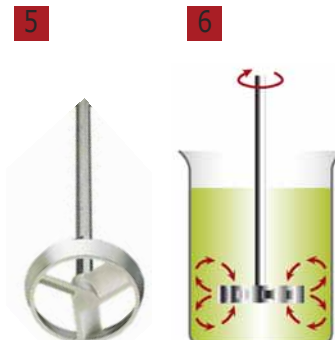

7 8 Dissolver stirring rotors, stainless steel 1.4404

The dissolver stirring rotor creates a radial flow with high turbulence. The mixture is drawn from top to bottom. High shear forces are created at the dissolver disk, which provides effective particle reduction. Recommended for medium to high speed operations.

∅ agitator mm	∅ agitator shaft mm	Length mm	PK	Cat. No.
30	8	350	1	9.779 322
40	8	350	1	9.197 007
50	10	550	1	9.779 336
60	10	550	1	9.779 337
70	10	550	1	9.779 338
80	8	350	1	9.197 001
80	10	550	1	9.779 339
100	10	350	1	9.197 003

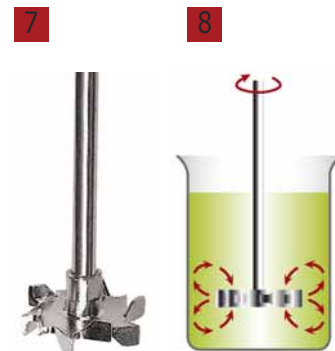

9 10 Centrifugal stirring rotors, 2-blade, stainless steel 1.4305

The folding blades of this 2-blade centrifugal stirring rotor open with increasing speed, allowing use with narrow-neck vessels. The stirring effect it provides is similar to a standard diagonal blade stirring rotor. Recommended for medium to high speed operations.

∅ agitator open / closed mm	∅ agitator shaft mm	Length mm	PK	Cat. No.
60/15	8	350	1	9.197 011
100/24	8	550	1	9.197 013

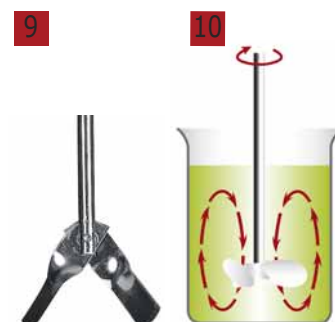

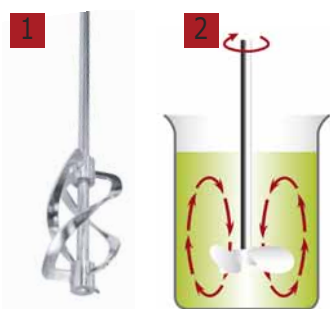

1 2 Spiral stirrer, stainless steel 1.4571

Generates axial flow. Medium is conveyed from the bottom upwards. For homogeneous mixing and heat exchange of medium to high viscosity media. Recommended for medium speed operations.

IKA

Type	Ø agitator mm	Ø agitator shaft mm	Length mm	PK	Cat. No.
R 3003	50	8	350	1	6.265 595
R 3003.1	100	10	550	1	6.265 596
R 3003.2	150	10	800	1	6.265 597

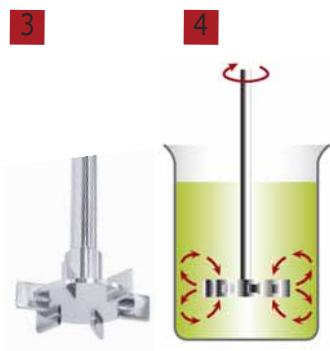

3 4 Blade stirrer, stainless steel 1.4571

Generates a radial flow. For drawing the material to be mixed from the top and bottom. For aerating of low viscosity media and for homogenizing solids in liquids. Used at medium to high speeds.

IKA

Type	Ø agitator mm	Ø agitator shaft mm	Length mm	PK	Cat. No.
R 3004	30	8	359	1	6.265 598
R 3004.1	50	10	565	1	6.265 599
R 3004.2	70	10	819	1	6.265 700



5 6 Paddle stirring rotors, 6 holes, stainless steel 1.4305

The paddle stirring rotor creates a tangential flow with minimum turbulence. Its design ensures a gentle action on sensitive products and good heat exchange. Recommended for low to medium speed operations. Other sizes available on request.

Ø agitator mm	Ø agitator shaft mm	Length mm	PK	Cat. No.
70	8	550	1	9.197 019
150	10	550	1	9.197 020

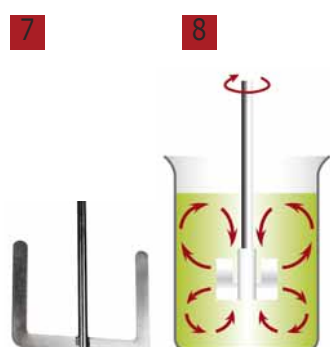

7 8 Anchor stirring rotors, stainless steel

The anchor-shape rotor creates a tangential flow and high shear forces between the vessel wall and stirring blades. This stirrer is especially suitable for medium to high viscosity fluids. Recommended for low speed operations.

Ø agitator mm	Ø agitator shaft mm	Length mm	PK	Cat. No.
45	8	350	1	9.197 033
80	10	500	1	9.779 346
90	8	350	1	9.197 034
100	10	500	1	9.779 347
150	10	550	1	9.197 036



1 2 BuddeMix Stirring System 1 - 4

This novel stirring system has been conceived to mix low viscosity fluids as well as highly viscous media at slow speeds. Its special design creates inherent dynamic currents to produce perfectly homogeneous mixing results in very little time. Additional components like baffles, bottom bearings, etc. are not needed.

Advantages at a glance:

- suitable for low to highly viscous fluids
- stirs media containing solids and fibres without any difficulty
- gentle, low-shear stirring, due to slow stirring speed
- constant product temperature, with no heating effect
- short mixing times as the entire contents of the container are agitated
- no air addition, no foaming
- no baffles required
- low gear wear due to balanced forces
- minimal power consumption thanks to low speeds and short operation times
- easy cleaning
- material no. 1.4404

Particularly for potentially explosive atmospheres:

- a single stirring zone, near to the container base, ensures easy mixing of settled residues, e.g. in flow-through mixing containers
- no baffles required, thus no additional sources of ignition

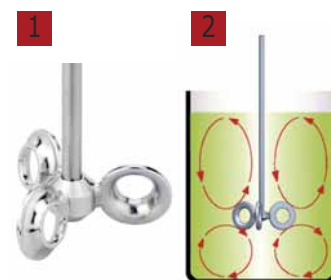

Type	Ø agitator mm	Ø agitator shaft mm	Length mm	Material No.	PK	Cat. No.
BuddeMix 1	60	10	350	1.4404	1	9.779 352
BuddeMix 2	80	10	350	1.4404	1	9.779 332
BuddeMix 3	120	10	550	1.4404	1	9.779 333
BuddeMix 4	150	10	850	1.4404	1	9.779 334
BuddeMix Mini 30	35	8	350	1.4404	1	6.314 307
BuddeMix Mini 40	46	8	350	1.4404	1	6.314 308

Customised shaft length possible. Fine polishing Ra 0.6 to 0.8 µm and/or material certificate available on request.

Impellers VISCO JET®

The worldwide patented VISCO JET® Mixing System is the result of the so-called cone-principle. Turbulent flows are created at the taper end by acceleration, displacement and retardation. These flows advance through the stirred medium and result in the new dynamic mixing motion.

Heidolph

- One system for literally all mixing tasks for low to high viscosity media
- Patented cone-principle creates even at low speeds a turbulent flow which is unique to the VISCO JET®
- Even with high-viscosity media and gels which naturally do not mix by using common impellers you will observe an immediate flow through the entire beaker
- This technology allows for de-gassing of gels while preventing air intake and foaming
- Reduce process times significantly while performing the best mixing result ever

The stirring systems are made of stainless steel (V4A or AISI 316 Ti) or polyoxymethylene (POM).



9.816 595



6.290 570

Material	For Vessels mm	Ø agitator shaft mm	Length mm	PK	Cat. No.
V4A	80-150	10	500	1	9.816 595
V4A	115-200	10	500	1	9.816 596
POM	115-200	10	500	1	9.816 597
V4A	170-300	10	500	1	9.816 598
POM	170-300	10	500	1	9.816 599
AISI 316Ti	115-200	10	500	1	6.290 570
AISI 316Ti	170-300	10	500	1	7.646 872

Other versions available.

Stirring rotors made of PTFE

The stirrer shafts consist of a PTFE-jacketed, stainless steel shaft and a stirrer paddle made of solid PTFE. The stainless steel core assures stability of the stirrer shaft and allows safe attachment of the stirrer chuck. Thanks to the thick PTFE coat and the paddle made of solid PTFE, the medium will only come into contact with PTFE. High chemical resistance makes it almost universally suitable. PTFE is extremely nonstick so that residues are repelled from shaft and paddle. The stirrer shafts are similar in size to (KPG) glass stirring rods and are therefore interchangeable easily.

BOLA

Operating temperature: -200 °C to +250 °C

Additional sizes and accessories are available on request.

Information on the mixing effects of the different stirring geometries can be found in the descriptions of the stainless steel stirring rotors.

1

1 Propeller, 3 blades, PTFE

The blades are inclined at 45°. Recommended for medium to high speed operations.

BOLA

Ø agitator mm	Ø agitator shaft mm	To fit chuck diam. mm	Length mm	Blades	PK	Cat. No.
50	6	4.0	450	round	1	9.197 138
75	8	6.5	350	angular	1	9.197 130
75	10	8.0	450	angular	1	9.197 140
75	10	8.0	800	angular	1	9.197 149
140	10	8.0	600	round	1	9.197 194
140	10	8.0	800	round	1	9.197 195
14	16	14.0	1000	round	1	6.244 067

2

2 Crescent-shaped stirring rotors, PTFE

The semi-circular shape of the paddle is ideal for mixing in round-bottom flasks. The pivoting blade allows insertion into vessels with narrow necks and/or ground joints.

BOLA

Ø agitator mm	Ø agitator shaft mm	To fit chuck diam. mm	Length mm	PK	Cat. No.
65	8	6.5	350	1	9.197 121
90	8	6.5	450	1	9.197 122
90	10	8.0	350	1	9.197 127
90	10	8.0	450	1	9.197 124
90	10	8.0	510	1	9.197 128
90	10	8.0	600	1	9.197 125
125	16	14.0	800	1	9.197 126

3

3 Anchor stirrer, PTFE

Recommended for low speed operations.

BOLA

Ø agitator mm	Ø agitator shaft mm	To fit chuck diam. mm	Length mm	PK	Cat. No.
60	8	6.5	350	1	9.197 144
60	8	6.5	450	1	6.076 374
80	8	6.5	450	1	6.076 375
100	10	8.0	450	1	6.286 974
100	8	6.5	600	1	9.197 145
80	10	8.0	350	1	9.197 146
100	10	8.0	600	1	9.197 147
130	10	8.0	800	1	7.659 979
150	16	14.0	1000	1	6.210 121

Additional wings available on request

4

4 Overhead stirrer rotors, centrifugal paddle, PTFE

With PTFE-coated, stainless steel shaft.

BOLA

Shaft diam. mm	To fit chuck diam. mm	Ø Paddle mm	Length mm	PK	Cat. No.
6	4.0	50	350	1	9.197 176
8	6.5	90	350	1	7.510 300
8	6.5	90	450	1	9.197 177
10	8.0	90	350	1	9.197 178
10	8.0	90	450	1	9.197 179

1 Test tube shaker LLG-uniTEXER 1

Compact and cost-efficient test tube shaker with brushless motor drive and touch function for short-term operation. Adjustable speed control up to 4500 rpm for excellent mixing results in a very short time. Especially for small volumes.

Scope of supply: vortexer, 1 mains adapter each US, AUS, UK

1



Specifications

Type of movement:	orbital
Orbit:	4.5 mm
Speed:	0 ... 4500 min ⁻¹
Permissible ambient temperature:	5 ... 40 °C
Permissible relative moisture:	< 80 %
Dimensions (W x D x H):	100 x 100 x 70 mm
Weight:	0.55 kg
Power supply:	100 ... 240 V, 50/60 Hz
IP code:	IP 43
Warranty:	3 years

Type	Plug type	PK	Cat. No.
LLG-uniTEXER 1	EU	1	6.263 490
LLG-uniTEXER 1	UK	1	6.263 491

2 3 4 Vortexer LLG-uniTEXER with universal attachment

One head - multiple uses

Vortexer with single carrier head, accommodating the most popular consumables and tubes: for 1 x assay plate, 2 x 50 ml conical tubes, 2 x 15 ml conical tubes, 2 x 5 ml conical tubes, 4 x 1.5/2 ml microcentrifuge tubes, 6 x 0.5 ml and 24 x 0.2 ml microcentrifuge tubes.

- Touch function for short-term operation
- Very easy to clean
- Elastomeric feet ensure excellent stability on the bench
- Modern design
- Robust housing made of ABS

Scope of supply: vortexer, 1 x universal attachment

2

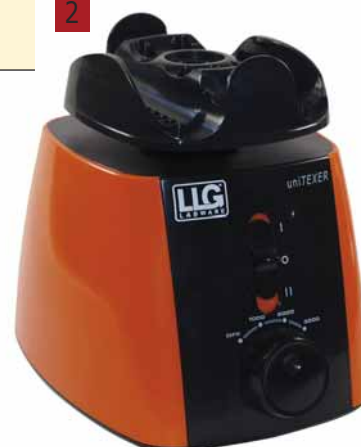

Specifications

Type of movement:	orbital/vortex
Orbital diameter:	3.7 mm
Speed:	1000, 2000 und 3000 min ⁻¹
Dimensions (W x D x H):	173 x 198 x 198 mm
Weight:	3.8 kg
Power supply:	220 V, 50/60 Hz
IP code:	IP 20
Warranty:	3 years

3



4



Type	Plug type	PK	Cat. No.
LLG-uniTEXER	EU	1	6.261 826
LLG-uniTEXER	UK	1	4.655 191



7.971 461

Vortex mixers ZX4/WIZARD/TX4 with IR sensor

Vortexers with patented IR sensor for sample recognition: the shaking process starts automatically when the sample tube approaches the mixing cup head. This enables fatigue-free working, as the sample doesn't have to be pressed on the device.

Velp Scientifica

- For IR sensor and continuous operation
- Electronic speed control
- Adjustable shaking speeds up to 3000 min⁻¹
- Very good chemical resistance
- Broad range of accessories available

ZX4: Analog vortex mixer

WIZARD: Compact, analog vortex mixer

TX4: Digital vortex mixer with timer and LCD display

Scope of delivery: Vortex mixer with mixing head

Specifications

Type of movement:	orbital
Orbital diameter:	4.5 mm
Speed range:	0 ... 3000 min ⁻¹
Input power	15 W
IP code:	IP 42
Power supply:	100 ... 240 V, 50 ... 60 Hz
Warranty:	3 years



4.666 537



4.666 537

Type	Net weight	Plug type	PK	Cat. No.
	kg			
ZX4	2.7	EU	1	7.971 461 1
ZX4 with foam stands	2.7	EU	1	4.666 714
WIZARD	2.2	EU	1	4.666 536 2
TX4	2.7	EU	1	4.666 537 3



4.659 498

Mini Vortex Mixer VXMN series

Four Mini Vortex Mixer models for gentle to high-speed mixing are available. Analog model offers variable speed control, and digital model allows input of the exact speed and time to achieve reproducible results. Pulsing model features a unique pulse action that reduces heat generation, while providing more effective mixing and cell disruption. Fixed speed model offers one-touch, high-speed mixing.

OHAUS
VXMNFS: Fixed high speed mixing, TOUCH mode operation

VXMNAL: Auto/Off/On Rocker switch, Speed Knob: Variable 1 to 10 Dial Marks, continuous or TOUCH mode operation

VXMNDG: Auto/Standby/On Rocker Switch, LED Displays for Speed/Time, Up/Down Buttons for Set-Point Control, continuous or TOUCH mode operation

VXMNPS: Auto/Standby/On Rocker Switch, LED Displays for Speed/Time, Up/Down Buttons for Set-Point Control Pulse Button

Scope of supply:

VXMNFS/AL/DG: Vortexer incl. Cup head and 76 mm head with cover

VXMNPS: Vortexer incl. Cup head and 76 mm head with cover and stainless steel tube holder

4.659 499

Specifications

Type of movement:	orbital
Type of movement PS:	pulsing
Orbit:	4.9 mm
Orbit PS:	2.5 mm
Timer (DG and PS only):	1 s to 160 h
Permissible ambient conditions:	4 to 40 °C
Dimensions (L x W x H):	211 x 122 x 165 mm
Weight:	4.5 kg
Power supply:	230 V, 50/60 Hz



4.659 501

Type	Min. speed rpm	Max. speed rpm	PK	Cat. No.
VXMNFS	2500	2500	1	4.659 498 4
VXMNAL	500	2500	1	4.659 499 5
VXMNDG	300	2500	1	4.659 500
VXMNPS	500	2500	1	4.659 501 6

4. Stirring, Shaking, Mixing Shakers and mixers/Vortexer

1 Vortex mixer PV-1

With low profile and small footprint for gentle mixing to vigorous re-suspension of cell or chemical pellets.

Grant

- variable speed: 750rpm to 3000rpm
- continuous or touch operation
- for tubes up to 28.5 mm (50 ml) diameter

Specifications

Type of movement:	orbital
Orbit:	4mm
Speed range:	750 to 3000rpm
Dimensions (WxDxH):	90 x 150 x 80mm
Temperature range:	4 to 40°C

Type	Plug type	PK	Cat. No.
PV-1	EU/UK	1	9.721 000



2

Shaker VORTEX 2

Vortex shaker especially for short time operation (Touch function) or continuous operation.

IKA

Specifications

Type of movement:	orbital
Orbital diameter:	4 mm
Max. shaken quantity:	400 g
Motor rating input/output:	39/9 W
Speed range:	500 to 2500 rpm
Dimensions (W x H x D):	120 x 138 x 140 mm
Weight:	3.9 kg
Enclosure according to DIN EN 60529:	IP 21

Type	PK	Cat. No.
VORTEX 2	1	7.971 443



3

Test Tube Shakers Reax top/control

Ideal for mixing samples in Eppendorf tubes, vials and similar vessels of different diameters at extremely high speed rates. The strong 5 mm vibration orbit yields the best results even with high viscosity media or solids out of solution and quickly gives a smooth and even dispersion. Short time and continuous mode.

Heidolph

Standard model Reax top:

- Features an analog dial speed control, no settings of specified rpm numbers

Precise model Reax control additionally with:

- Features analog dial speed control with accurate rpm numbers setting
- Electronic speed control provides constant rpm output even at very low speed and under changing loads
- Precise speed control with settings of specified rpm numbers

Scope of delivery: Test tube shaker incl. attachment diam. 20 mm. Optional attachment for vessels up to 50 mm available.

Specifications

Type of movement:	orbital
Orbit:	5 mm
Speed range:	0 ... 2500 rpm
Power consumption:	51 W
Permissible ambient temperature:	5 ... 31 °C
Permissible relative moisture:	80 %
Dimensions (W x D x H):	134 x 172 x 105 mm
Weight:	2.8 kg
Power supply:	230 V, 50 Hz
IP code:	IP 22

Type	Plug type	PK	Cat. No.
Reax top	EU	1	9.730 040
Reax top	UK	1	9.730 041
Reax control	EU	1	9.730 042



9.730 040

4



9.730 042

1

1 Test tube shaker, lab dancer

Inexpensive, compact test tube vortex shaker. Designed for mixing small test samples by touch function.

IKA

- Small, compact and reliable
- For small containers up to 30mm in diameter, e.g. test tubes, centrifuge tubes, Eppendorf tubes
- Fixed speed (2800rpm)
- Excellent mixing
- Top of housing and the test tube accessories are made from chemically inert plastic. The bottom section is a coated, zinc die-casting.
- Includes lightweight 12V mains adapter

Specifications

Mixing:	orbital
Orbit:	4.5mm
Capacity, volume:	1 tube, max. 50ml
Motor rating input/output:	1.2/0.8W
Speed:	2800rpm (fixed)
Dimensions (Diam. x H):	100 x 70mm
Weight:	550g
Material housing:	PP
Material attachment:	TPU
Material base:	Zinc, coated
Enclosure according to DIN EN 60529:	IP40
Supply requirements:	100-240V 50/60 Hz
Tested to DIN EN IEC 61010-1.	

Type	Plug type	PK	Cat. No.
lab dancer	EU/CH	1	9.729 936
lab dancer	UK	1	4.008 065

2

2 Shaker Vortex 3

Vortex shaker suitable for intermittent operation (touch function), activated by pressing shaker attachment, or for continuous operation.

IKA

- Wide speed range, infinitely adjustable
- Versatile, due to 3 accessory interchangeable attachments and 7 inserts (e.g. Eppendorf tubes, microtitre plates, 250ml Erlenmeyer flasks etc.), please order separately
- Attachments securely click onto shaker in any position
- Strap clamp (VG3.36) ensures easy holding of round/Erlenmeyer flasks
- Sturdy, die cast zinc casing
- Stable at high speeds due to special feet (silicone base with ultra-high vibration damping)
- Eccentric drive with ball bearings
- Self-ventilated motor allows continuous operation with minimal warm-up of the housing

Supplied with standard attachment.

Specifications

Type of movement:	orbital
Orbital diameter:	4mm
Motor rating input/output:	58/10W
Speed range:	500rpm to 2500rpm
Speed indication:	scale 0 to 6
Dimensions (W x D x H):	127 x 149 x 136mm
Weight:	4.5kg
Protection class acc. to DIN EN 60529:	IP 21
Supply requirements:	230V 50/60 Hz
Tested to DIN EN IEC 61010-1.	

Type	Plug type	PK	Cat. No.
VORTEX 3	EU	1	9.729 950
VORTEX 3	CH	1	4.008 062
VORTEX 3	UK	1	4.008 061

Orbital Shaker Hula Dancer Basic/Digital

The Hula Dancer is a powerful orbital shaker with robust housing for high stability. It is suitable for a maximum load of 100 g. Hula Dancer basic with fixed speed of 2800 rpm.

IKA

1



4.665 611

Specifications

Mixing:	orbital
Orbit:	4.5 mm
Capacity, volume:	100 g
Motor rating input/output:	9.5/5 W
Permissible ambient temperature:	5 ... 40 °C
Permissible relative moisture:	80 %
Dimensions (Diam. x H):	123 x 123 x 42 mm
Weight:	700 g
Power supply:	100 ... 240 V, 50 ... 60 Hz
Enclosure according to DIN EN 60529:	IP 40

Type	Speed range	PK	Cat. No.
	rpm		
Hula Dancer basic	2800	1	6.274 875
Hula Dancer digital	1200 ... 2800	1	4.665 611

2 Vortex-Genie®-series

Robust and reliable shakers for speedy mixing and shaking of samples. Multiple accessories: e.g. adapter tops for test tubes, beakers, centrifuge tubes etc. Adapter tops can be changed easily with the snap fit system.

Scientific Industries

2



Vortex-Genie® 2: Variable speed for precise mixing from gentle to vigorous. Broad range of attachments for most tubes, plates and other containers. Hands-Free or Touch On control.

Vortex-Genie® 2T with an integrated timer: Timer function: (Touch On) 1-60 seconds, (Hands-Free) 1-60 minutes or continuous. Unit automatically stops at the end of user programmed time.

Digital Vortex-Genie® 2 with digital control and display of speed and time: Digital display provides accuracy, reproducibility and repeatability. Timer function: (Touch On) 1-99 seconds, (Hands-Free) 1-99 minutes or continuous. Specially configured unit for Applied Biosystems protocol available.

Vortex Genie® Pulse: Fully programmable vortex mixer with ON/OFF feature. Pulse 0.1 sec to 99 min.

Scope of supply: Vortexer, 3-inch Platform with rubber cover, Pop-off cup

Specifications

Shaking movement:	orbital
Speed display/Timer:	Scale/No/Scale/Scale/Digital/Digital
Speed range:	600-2700rpm/600-2700rpm/500-2850rpm/500-2850rpm
Timer	
Interval operation:	-/ 1 to 60s/1 to 99s/0.1 s to 99 min
Hands-free mode:	-/ 1 to 60min/1 to 99min/1 to 99 min
Dimensions (L x W x H):	165 x 122 x 165mm
Permissible ambient conditions:	0 to 38°C at 95% rh
Weight:	4kg
Power supply:	230V, 50/60Hz

Vortex-Genie® 2/Vortex-Genie® 2T/Digital Vortex-Genie®2/ Vortex Genie® Pulse

Type	Min. speed rpm	Max. speed rpm	Plug type	PK	Cat. No.
Vortex Genie® 2	600	2700	EU	1	9.730 060
Vortex Genie® 2	600	2700	UK	1	6.251 939
Vortex Genie® 2	600	2700	CH	1	6.235 684
Vortex-Genie® 2T	600	2700	EU	1	6.252 823
Vortex-Genie® 2T	600	2700	UK	1	6.252 946
Vortex-Genie® 2T	600	2700	CH	1	9.730 121
Digital Vortex-Genie® 2	500	2850	EU	1	6.242 793
Digital Vortex-Genie® 2	500	2850	UK	1	9.730 120
Digital Vortex-Genie® 2	500	2850	CH	1	6.240 599
Vortex Genie® Pulse	500	2850	EU	1	6.287 671
Vortex Genie® Pulse	500	2850	UK	1	6.287 674
Vortex Genie® Pulse	500	2850	CH	1	6.287 675

1

9.729 938

Shaker MS3 basic/digital

Compact, universal small shaker suitable for shaking tasks with all small vessels and microtitre plates.

IKA

- Continuous or touch operation (with standard attachment)
- Two operating modes available:

Mode A (safe mode with attachment detection)

the maximum speed of 3000rpm is only attained with the standard attachment in touch mode. When using other attachments the speed is limited to 1300rpm.

Mode B (without attachment detection)

a speed of 3000rpm is possible with all attachments.

- Stable in all speed ranges
- Sturdy, zinc, die-cast casing

MS 3 digital additionally with countdown function timer (1sec to 999min).

Items supplied with MS3 basic + digital: Standard attachment, universal attachment, one-hand insert
Additional items supplied with MS3 digital: Microtitre plate attachment, test tube insert with 6 holes for 12mm diameter tubes

Specifications:

Type of movement:	orbital
Orbit:	4.5mm
Max. permitted shaking weight (incl. attachment):	0.5kg
Motor rating input/output:	10/8W
Speed display:	Scale
Speed range:	0 to 3000rpm
Dimensions (W x D x H):	148 x 205 x 63mm
Weight:	2.9kg
Protection class acc. to DIN EN 60529	IP21
Supply requirements:	100-240V 50/60Hz
Tested to DIN EN IEC 61010-1.	

Type	Plug type	PK	Cat. No.
MS 3 basic	EU/UK/CH/US	1	9.729 938
MS 3 digital	EU/UK/CH/US	1	9.729 939

2

2 Mini shaker Matrix Orbital

NEW

IKA

Powerful thermoshaker available for samples with small volumes, e.g. blood samples, pharmaceutical agents, DNA/RNA samples, DNA/RNA samples or Elisa assays. Without cross-contamination and with an optimal mixing result.

- Large and clear display with a simple menu structure allows for intuitive operation
- Two different speed modes for optimal mixing
- Speed adjustment according to insert, attachment and filling volume
- Robust aluminum die cast housing

Scope of supply: Shaker, 3 inserts (1 x 0.5 ml tubes, 1 x 1.5/2.0 ml tubes and 1 x 0.2 ml PCR tubes)

Specifications

Type of movement:	orbital
Orbit:	3 mm
Speed range:	300 ... 3000 rpm
Power consumption:	80 W
Max. permitted shaking weight (incl. attachment):	0.3 kg
Timer:	1 s ... 6000 min
Permissible ambient temperature:	5 ... 40 °C
Permissible relative moisture:	80 %
Dimensions (W x D x H):	198 x 318 x 124 mm
Weight:	7.2 kg
Power supply:	100 ... 240 V, 50/60 Hz
IP code:	IP 21

Type	PK	Cat. No.
Matrix Orbital	1	4.664 739

➔ Microplate shakers, see page 539.

1 Vortex Mixer VX-200



Economical vortex mixer for mixing all kinds of samples. The continuously variable speed makes the Vortex Mixer useful for a variety of applications.

- "Touch" or continuous mode
- Pressure on vibrating plate starts device and enables effective working with one hand
- Continuously variable mixing speed

Specifications

Speed range 230 V:	0 ... 2850 rpm
Operating modes:	Touch or continuous
Dimensions (W x D x H):	140 x 160 x 130 mm
Weight:	2.2 kg

Type	PK	Cat. No.
Vortex Mixer	1	6.292 017

1



2 Test tube shakers Multi Reax

Heidolph

Versatile Test tube shaker with 3 mm vibration orbit, accomplishes excellent results especially in large vessels. The Multi Reax allows for rigid to smooth dispersion of viscous media and solids.

- Short term and continuous run
- Stepless speed adjustment
- Digital display
- Timer function allows for unattended operation and can be set from 1 to 999 minutes. With acoustic alarm when the operation stops.

Scope of delivery: Test tube shaker incl. 2 attachments.

- Attachment for 26 vessels with diameters from 10 mm to 16 mm
- Attachment for 12 vessels with diameters from 16 mm to 32 mm

Specifications

Type of movement:	orbital
Orbit:	3 mm
Speed range:	150 ... 2000 rpm
Power consumption:	50 W
Permissible ambient temperature:	5 ... 31 °C
Permissible relative moisture:	80 %
Dimensions (W x D x H):	270 x 410 x 172 mm
Weight:	9.8 kg
Power supply:	230 ... 240 V/50/60 Hz
IP code:	IP 30

Type	PK	Cat. No.
Multi Reax	1	9.839 810

2



Vortex Mixers for multi tubes

OHAUS

Multi-Tube Vortexers are ideal for high throughput sample processing. Holds up to 50 samples simultaneously. Interchangeable foam racks for vortexing tubes from 10 to 29 mm in diameter available. Vortexing action is created by securing the top of the sample in place while allowing the bottom to rotate freely in a 3.6 mm orbit. Suction cup feet reduce motion and prevent sliding on work surface. Analogue and digital models, both microprocessor-controlled and run in continuous or timed mode.

- Digital Model is ideal for Applications that Require Accuracy and Repeatability
- Pulsing Mode on Digital Model to Enhance Vortexing Action
- Analogue Model Offers an Economical Alternative When Exact Speed/Time is not required

Scope of supply: Vortex Mixer incl. Tray Pad Set for support and one 12 mm Test Tube Foam Rack.

Specifications

Orbit:	3.6 mm
Max. load:	4.5 kg
Timer VXMTAL/VXMTDG:	0 to 60 s/1 s to 160 h
Permissible ambient conditions:	4 to 40 °C
Dimensions (L x W x H):	241 x 384 x 406 mm
Weight:	19.1 kg
Power supply:	230 V, 50/60 Hz

Type	Min. speed rpm	Max. speed rpm	Display type	PK	Cat. No.
VXMTAL	1200	2400	analogue	1	4.659 506
VXMTDG	500	2500	digital	1	4.659 507

3



4.659 506

4



4.659 507

1

1 Shaker MixMate®

NEW

Eppendorf AG

The 3-in-1 mixer for plates, tubes and vortex mixing. High speed instrument for the complete resuspending of pellets, mixing PCR setups, mixing viscous liquids and suspensions (incl. beads), mixing restriction digestions, immunoassays, colorimetric assays, reporter gene assays, vortexing numerous tube formats (e.g. 15 and 50 ml conical tubes). Fully mixing in plates (96 or 384-wells) or reaction tubes in seconds.

- High-speed mixer for fast and efficient mixing of small volumes in all common vessel formats up to 50 ml
- 5 soft keys with pre-defined standard mixing parameters for easy usage
- Integrated vortex function for individual sample mixing
- 2DMix-Control (planar mixing orbit) and anti-spill technology for controlled mixing in seconds, without lid wetting and cross-contamination
- Minimal hand/arm vibration transfer during vortexing (PhysioCare Concept®)
- Very stable, remains stationary even at maximum mixing speed
- Whisper quiet operation

Specifications

Type of movement:	orbital
Orbit:	3 mm
Speed range:	300 ... 3000 rpm
Touch vortex frequency	3500 rpm
Timer:	15 s ... 99.5 h, continuous
Noise level	<50 dB(A)
Dimensions (W x D x H):	170 x 230 x 130 mm
Weight:	4.2 kg
Max. power consumption	40 W
Power supply:	230 V, 50/60 Hz

Type	PK	Cat. No.
MixMate®	1	4.671 525

2

9.730 090

2 Shaker Multi Vortex Genie®/Vortex-Genie® Max

Scientific Industries

Robust and reliable shaking device for mixing and shaking of samples in Erlenmeyer flasks, vials, tubes, beakers or microplates.

- Digital display for speed and time
- Speed increase in steps of 10 rpm
- Robust metal case
- Secure stand at high speed thanks to supports with high vibration damping
- Can be loaded with e. g. max. 6 Erlenmeyer flasks 250 ml or 2 multi racks each for 12 test tubes (max. tube diameter 29 mm, length min. 85 mm)

Vortex-Genie® Max additionally:

- Unique ratcheting clamping system, ideal for repetitive protocols and use with open containers
- Fully programmable
- Revers and interval mixing
- Pulse function

Scope of supply:

Multi Vortex-Genie®: Shaker, Platform with clamp/tension roller (for securely attaching standing vessels), 2 multi-racks

Vortex-Genie® Max: Shaker, Platform with 2 ratcheting clamps

Specifications

Type of movement:	orbital
Orbit:	4 mm
Speed range:	200 ... 950 rpm // 500 ... 2000 rpm
Overall dimensions (W x D x H):	310 x 270 x 195 mm
Weight:	11.3 kg // 10.4 kg
Supply requirements:	230 V, 50 Hz

Multi Vortex-Genie® // Vortex-Genie® Max

Type	Plug type	PK	Cat. No.
Multi Vortex-Genie®	EU	1	9.730 090 2
Multi Vortex-Genie®	UK	1	6.265 221
Multi Vortex-Genie®	CH	1	6.265 222
Vortex-Genie® Max	EU	1	4.670 816 3
Vortex-Genie® Max	UK	1	4.670 817
Vortex-Genie® Max	CH	1	4.670 818

Suitable accessories can be found in our online shop.

3

4.670 816

4. Stirring, Shaking, Mixing Shakers and mixers/Orbital shakers

1 Orbital Shaker PSU-10i

Microprocessor controlled shaking platform providing smooth and quiet horizontal orbital motion for mixing in bottles, flasks and beakers.

Grant

- Continuous or timed operation with automatic switch-off
- Reliable direct drive system
- Automatic load balancing system
- The five interchangeable accessory platforms enable a wide choice of vessels to be used, including bottles, flasks and beakers, dishes, boxes and petri-dishes.

Specifications

Type of movement:	orbital
Orbit:	10mm
Max. Load:	3kg
Speed range:	50 to 450rpm/10rpm increments
Timer range:	1min to 96 hours or continuous
Overall dimensions (W x D x H):	220 x 205 x 90mm
Power supply:	100 - 240V, 50/60Hz

Type	PK	Cat. No.
PSU-10i	1	9.721 019



Accessories for Orbital shaking platform PSU-10i

Grant

Type	Description	PK	Cat. No.
Bio PP-4	Flat platform, working area 230 x 230mm	1	9.721 018
PUP-12	Universal platform, working area 270 x 195mm	1	9.721 021
P12-100	Platform with clamps for 12 x 100ml flasks / 150ml beakers	1	9.721 023
P6-250	Platform with clamps for 6 x 250ml flasks / 300ml beakers	1	9.721 024
P16-88	Platform with spring holders for 88 tubes up to 30mm	1	9.721 049



9.721 021

Orbital shakers SHLD series

These light Duty Shakers are designed for applications with loads up to 3.6 kg. Choose from two orbits and speed ranges to optimize your sample mix.

OHAUS

Microprocessor-controlled and available as an analog model with basic speed control, 3 digital models which include a non-slip mat. The mat can be removed to mount flask clamps and tube racks directly onto the tray. The digital Microplate Shaker model can hold up to 4 microplates or 2 microtube racks.

- Microprocessor Control
- Triple Eccentric Drive
- Speed Ramping Feature
- Spill-Resistant Design
- Suitable for CO₂ environments

Digital models additionally with:

- Overload protection
- LED display for speed and time
- Audible Alarm

Scope of supply:

0415AL/0415DG/0403DG: Shaker incl. built-in tray and non-slip rubber mat

MP03DG: Microplate shaker incl. built-in tray with holder for 4 microplates or 2 microtube racks

Specifications

Type of movement:	orbital
Max. Load:	3.6 kg
Max. Load MP03DG:	4 microplates or 2 microtube racks
Motor:	brushless DC motor
Timer:	1 s to 160 h (0415AL without Timer)
Dimensions (L x W x H):	413 x 254 x 102 mm
Weight:	11.3 kg
Power supply:	230 V, 50/60 Hz

Type	Min. speed rpm	Max. speed rpm	PK	Cat. No.
0415AL	40	300	1	4.659 467
0415DG	40	300	1	4.659 470
0403DG	100	1200	1	4.659 468
MP03DG	100	1200	1	4.659 469



4.659 467



4.659 470



4.659 469

1

1 Orbital shaker RS-OS series

A compact, orbital shaker with ideal swivel motion. The shakers can be set up individually by using the comprehensive range of accessories.

Phoenix Instrument

Features at a glance RS-OS 10/20:

- compact shaker for a maximum shaking weight of 2.5 and 7.5 kg
- Backlight LCD display for speed and timer adjustment.
- Speed, time and operating mode can be viewed simultaneously
- Comprehensive accessories
- Adjustable safety speed
- PC control via RS232 interface, the special Shaker PC software can realise the setting of instrument parameters on the PC and the display of working curves real-time.
- 2 years warranty

Please order attachments and further accessories separately.

Specifications	RS-OS10 // RS-OS 20
Type of movement:	orbital
Orbit:	4 mm
Speed range:	100 ... 800 rpm // 100 ... 500 rpm
Max. Load:	2.5 kg // 7.5 kg
Power consumption:	30 W
Speed display:	digital
Interface:	RS-232
Platform dimensions (W x D):	240 x 240 mm
Overall dimensions (W x D x H):	340 x 300 x 100 mm // 420 x 370 x 100 mm
Weight:	8.1 kg // 13.5 kg
Voltage:	100 ... 240 V
IP code:	IP 21

Type	PK	Cat. No.
RS-OS 10	1	9.852 120
RS-OS 20	1	9.852 121

2

2 Accessories for shakers RS-OS/RS-LS/RS-RS 5/RS-DS 5 series

Phoenix Instrument

Type	Description	For Type	PK	Cat. No.
RSS-E 100	Universal attachment with clamping rolls	OS/LS 10, RS/DS 5	1	9.852 125
RSS-E 110	Universal attachment with vertical adjustable clamping rolls	OS/LS 10, RS/DS 5	1	9.852 127
RSS-E 200	Universal attachment with clamping rolls	OS/LS 20	1	9.852 129
RSS-E 220	Dish attachment with tensioning belt	OS/LS 20	1	9.852 146
RSS-E 160	Dish attachment, 200 x 300 mm	OS/LS 10, RS/DS 5	1	4.660 779
RSS-E 165	Dish attachment, 280 x 280 mm	OS/LS 10, RS/DS 5	1	4.660 780
RSS-E 168	Connectors for 2 dish attachments	RSS-E 160, RSS-E 165	4	4.660 781

3

3 Platform shaker Mini-100 Orbital-Genie®

Benchtop orbital shaker with non-slip, rubber-coated platform and spill-proof edges for gentle shaking.

Scientific Industries

- Variable shaking speed up to 100 min⁻¹
- Also suitable for use in cold rooms and incubators (not CO₂ incubators)
- Further platform optionally available

Scope of delivery: Shaker incl. platform

Specifications	
Type of movement:	orbital
Orbit:	19 mm
Speed range:	20 ... 100 rpm
Max. Load:	3 kg
Working temperature:	0 ... 38 °C
Platform dimensions (W x D):	290 x 290 mm
Overall dimensions (W x D x H):	350 x 350 x 85 mm
Net weight:	3.5 kg

Type	Plug type	PK	Cat. No.
Mini-100 Orbital-Genie	EU	1	4.667 502
Mini-100 Orbital-Genie	UK	1	4.667 503
Mini-100 Orbital-Genie	CH	1	4.667 504

1 2 Digital Orbital Shaker

- Electronically controlled and programmable shakers
- Slow, soft-start greatly decreases the risk of spills
- Erlenmeyer flasks, beakers, culture flasks and micro plates can easily be fixed using 8 rubber strips
- Digital LCD display for speed and run time control
- Integrated overload shutdown
- Permanent motor feedback, which automatically adjusts the speed even if the load is changed during operation
- Continuous mode or timer for up to 49 hours
- Soft rubber feet minimise system movement
- Platform with non-slip surface

Platform capacity:

Erlenmeyer Flasks e.g.: 25 x 50 ml, 16 x 125 ml, 9 x 250 ml, 4 x 500 ml, 4 x 1000 ml, 1 x 2000 ml

Beakers e.g.: 36 x 50 ml, 25 x 100 ml, 16 x 250 ml, 9 x 400 ml, 4 x 1000 ml

Deep well assay plates e.g.: 6 x standard (more if stacking is an option)

Supplied with: Orbital Shaker incl. universal attachment, universal power supply, non-slip rubber mat and 8 elastic ties

Specifications

Type of movement:	orbital
Orbit:	19.0 mm
Speed range:	20 to 300rpm
Max. Load:	4.5kg
Timer range:	1min to 49 hours or continuous
Speed display:	digital
Ambient conditions:	4 to 40°C; 20% to 40% RH, non-condensing
Platform interior dimensions:	279 x 279mm
Overall dimensions (W x D x H):	314 x 310 x 197 mm
Weight:	8.2kg
Power supply:	100 to 240 V, 50/60 Hz
Warranty:	5 years

Type	PK	Cat. No.
Orbital shaker	1	6.270 566

Heathrow Scientific



2



3 Orbital shaker SSM1

- Smooth orbital shaking action
- Built-in digital timer
- Variable speed control 30 to 300rpm
- Supplied with non-slip mat for microplates etc.
- Optional accessory cradle system for flasks and bottles

The compact SSM1 provides a smooth uniform circular motion with an orbit of 16mm. It is supplied with a non-slip mat that can hold up to four microplates or diagnostic cards. Alternatively, an accessory cradle system is available that can accommodate a variety of vessels including flasks, bottles or beakers via four rubber securing bars. It will hold up to: 4 x 250ml or 2 x 500ml or 1 x 1000ml Erlenmeyer Flasks or bottles.

Speed is variable from 30rpm to 300rpm. Once set on the digital display, the shaking speed is effectively maintained even over long periods of time. Shaking times can be set to run for 1 second to 9 hours on the built-in digital timer, or the unit can also be set for continuous operation.

With BioCote, silver-based, antimicrobial protection.

Specifications

Type of movement:	orbital
Orbit:	16mm
Speed range:	30 to 300rpm
Max. Load:	3kg
Platform dimensions (W x D):	220 x 220mm
Overall dimensions (W x D x H):	240 x 300 x 140mm
Net weight:	5kg
Supply requirement:	230V, 50Hz, 50W

Type	PK	Cat. No.
SSM1	1	9.728 830

Attachments are not included. - Please order separately.

Stuart



1

1 Orbital Shaker PSU-20i

 Powerful and efficient microprocessor controlled, multi-functional orbital shaker Grant

providing all that is required to mix your samples: rotation, reciprocation and vibration. This enables optimisation of the mixing whether in flasks, beakers, Petri dishes or other laboratory vessels.

- Orbital motion, orbital reciprocation and vibration functions all in one product
- Reciprocal rotation: 0 to 360° turning angle, in 30 degree steps
- Vibration: 0 to 5° turning angle, 1 degree steps
- Loading capacity: 8 kg
- Fully programmable sequence that can use one or all the functions
- 6 interchangeable platforms for vessels up to 1000ml including a multi-level platform to hold a large number of various microplates, Petri dishes and culture bags.

Scope of supply: Orbital Shaker PSU-20i, external power adapter, manual and certificate.

Optional Platform attachments please order separately.

Specifications

Type of movement:	orbital/reciprocal/vortex
Orbit:	20mm/0 to 360°/0 to 5°
Speed range:	20 to 250rpm
Max. Load:	8kg
Timer:	1min to 96h
Permissible ambient temperature:	4 to 40°C
Dimensions (W x D x H):	410 x 410 x 130mm
Weight:	11.7kg
Power supply:	240V, 50/60Hz

Type	Plug type	PK	Cat. No.
PSU-20i	EU/UK	1	6.256 816

2

9.721 063

Accessories for Orbital shaker PSU-20i

Grant

Type	Description	PK	Cat. No.
PUP-330	Universal platform with adjustable bars	1	9.721 081
PP-20	Platform flat with non-slip mat, 480 x 380 mm	1	6.256 809
PP-20-3	Platform flat 3-level tower with non-slip mat, 480 x 380 x 460 mm	1	6.267 727
PP-20-4	Platform flat 4-level tower with non-slip mat, 480 x 380 x 600 mm	1	6.282 418
P30-100	Platform with clamps for 30 x 100 ml flasks	1	9.721 061
P16-250	Platform with clamps for 16 x 250 ml flasks	1	9.721 062
P9-500	Platform with clamps for 9 x 500 ml flasks	1	9.721 063
P6-1000	Platform with clamps for 6 x 1000 ml flasks	1	9.721 064

3

4.670 829

Platform shaker Mini-300 Orbital-Genie®

NEW

 Compact and powerful high-speed benchtop shakers with a choice of 3 models for various applications. Scientific Industries

- Model with ratcheting clamps provides the flexibility for using a mix of different size and shape vessels on one single platform
- Model with flask clamps for accommodating various flask or beaker sizes
- Model with adhering mat is perfectly suitable for open containers
- Suitable for use in cold rooms and incubators (Not for CO₂ incubators)

Scope of supply: Shaker, platform

Please order clamps for Mini-300 Orbital-Genie with flask separately.

Specifications

Type of movement:	orbital
Orbit:	19 mm
Speed range:	35 ... 300 rpm
Max. Load:	3 kg
Working temperature:	0 ... 38 °C
Platform dimensions (W x D):	305 x 305 mm
Overall dimensions (W x D x H):	350 x 350 x 85 mm
Net weight:	10.3 kg

Type	Description	Plug type	PK	Cat. No.
Mini-300 Orbital-Genie®	Ratcheting Clamps	EU	1	4.670 823
Mini-300 Orbital-Genie®	Ratcheting Clamps	UK	1	4.670 824
Mini-300 Orbital-Genie®	Flask Clamps	EU	1	4.670 826
Mini-300 Orbital-Genie®	Flask Clamps	UK	1	4.670 827
Mini-300 Orbital-Genie®	Adhering Mat	EU	1	4.670 829
Mini-300 Orbital-Genie®	Adhering Mat	UK	1	4.670 830

4. Stirring, Shaking, Mixing Shakers and mixers/Orbital shakers

Orbital shaker SHHD series

With load capacities from 16 to 68 kg and over 70 accessory options, the Heavy Duty Shakers are designed to handle a range of applications. Available as analog or digital models with microprocessor control to provide variable speed and consistent shaking, while ramping to the set speed. Microprocessor displays the last set-point and will restart if power is interrupted. Built-in tray and non-slip rubber mat included with all models.

- Microprocessor Control
- Triple Eccentric Drive
- Speed Ramping Feature
- Spill-Resistant Design
- Suitable for CO₂ environments

Digital models additionally with:

- Patented Accu-Drive Shaking System
- Touchpad Control with Independent LED Displays for speed and time
- Speed Calibration Mode
- RS232 Interface
- Load Sensor and Overload Protection
- Audible Alarm

Scope of supply: Shaker incl. built-in tray and non-slip rubber mat

Specifications

Type of movement:	orbital
Motor:	brushless DC motor
Timer Models analogue/digital:	1 s to 120 min/1 s to 160 h
Environment Models analogue/digital:	0 to +40 °C/-10 to +60 °C
Power supply:	230 V, 50/60 Hz

Type	Permissible shaking quantity / maximum load kg	Min. speed rpm	Max. speed rpm	Shaking stroke / Shaking orbit mm	Dimensions (W x D x H) mm	PK	Cat. No.
1619AL	16.0	25	500	19	355 x 413 x 149	1	4.659 457
1619DG	16.0	15	500	19	355 x 413 x 149	1	4.659 458
2325AL	22.7	25	500	25	678 x 610 x 149	1	4.659 461
2325DG	22.7	20	500	25	678 x 610 x 149	1	4.659 462
4525DG	45.4	15	500	25	678 x 729 x 170	1	4.659 463
4550DG	45.4	15	300	51	678 x 729 x 170	1	4.659 464
6825DG	68.0	15	300	25	914 x 744 x 170	1	4.659 465
6850DG	68.0	15	300	51	914 x 744 x 170	1	4.659 466

1

2

3

4



4.659 457



4.659 465

Orbital shaker KM CO₂/KM 2

KM CO₂/KM CO₂-FL: Stainless Steel Shaker especially for incubators with CO₂ concentration.

Scope of supply: Shaker incl. basic platform with rubber mat and external control unit.

KM 2: Highly reliable shaker which requires little space.

Scope of supply: Basic device incl. basic platform and rubber mat.

Specifications

Type of movement:	orbital
Orbit:	20 mm
Speed range:	5 ... 220 rpm, in steps of 5
Max. Load:	2 kg
CO ₂ concentration (KM CO ₂):	20 %
Timer:	0 ... 99 h 59 min/continuous
Power consumption:	4 W
Permissible ambient temperature:	4 ... 45 °C
Length standard cable (KM CO ₂):	2000 mm
Length ribbon cable (KM CO ₂ -FL):	1200 mm
Dimensions platform (B x T):	200 x 295 mm
Power supply:	100 ... 240 V, 50/60 Hz
Protection class:	IP 21

Type	Dimensions (W x D x H) mm	Net weight kg	PK	Cat. No.
KM CO ₂	230 x 340 x 145	7.6	1	6.285 189
KM CO ₂ -FL	230 x 340 x 145	7.6	1	6.275 858
KM 2	250 x 415 x 145	8.1	1	9.838 140

Bühler



6.285 189



9.838 140

1

6.900 348

Accessories for Orbital shaker KM CO₂/KM 2

Bühler

Description	PK	Cat. No.
Universal tray KM Mini for KM (without spring clamps)	1	6.070 276
Universal tray KM (without spring clamps)	1	6.900 348
Clamping strips KM	1	6.070 277

2

2 Orbital shaker MaxQ 2000 CO₂ Plus, CO₂ resistant

NEW

Thermo Scientific

CO₂-resistant orbital shaker with variable speed and external digital control unit. Suitable for use in CO₂ incubators.

- Speed adjustment from 30 to 300 min⁻¹
- Brushless magnetic shaker motor
- External control unit with LED display for easy setting and display of device parameters without opening the incubator door
- Minimum heat output
- With timer
- Stainless steel construction for protection against atmospheres up to 20 % CO₂ content

Platforms are not included - Please order separately.

Scope of supply: shaker, control unit, mains adapter

Specifications

Type of movement:	orbital
Speed range:	30 ... 300 min ⁻¹
Accuracy:	±1 min ⁻¹
Orbit:	19 mm
Max. load:	6 kg
Timer:	59 min ... 99 h
Environment:	4 ... 60 °C, r.F. 90 %
Dimensions (W x D x H):	360 x 300 x 96 mm
Weight:	13 kg
Warranty:	2 years
Power supply:	100 ... 240 V, 50/60 Hz

Type	PK	Cat. No.
MaxQ 2000 CO2 Plus	1	6.311 871

Accessories for orbital shaker MaxQ 2000 CO₂ Plus, CO₂-resistant

NEW

Thermo Scientific

Type	PK	Cat. No.
Clamp for 50 ml flasks	1	4.671 320
Clamp for 100 ml flasks	1	4.671 321
Clamp for 150 ml flasks	1	4.671 322
Clamp for 200 ml flasks	1	4.671 323
Clamp for 250 ml flasks	1	4.671 324
Clamp for 500 ml flasks	1	4.671 325
Clamp for 1000 ml flasks	1	4.671 326
Clamp for 2000 ml flasks	1	4.671 327
Clamp for 3000 ml flasks	1	4.671 328
Clamp for 5000 ml flasks	1	4.671 329
500 ml Infusion bottle clamp	1	4.671 330
1000 ml Infusion bottle clamp	1	4.671 331
Separating funnel clamp	1	4.671 332
Tube rack 40 x 14 mm	1	4.671 333
Tube rack 40 x 16 mm	1	4.671 334
Adjustable tube rack 40 x 14 mm	1	4.671 335
Adjustable tube rack 40 x 16 mm	1	4.671 336
Aluminium universal platform	1	4.671 337
Platform with rubber mat	1	4.671 338
96-well microplate holder	1	4.671 339
Spring wire frame	1	4.671 340
Adhesive mat 140 x 140 mm	1	4.671 341

1 Orbital shakers SSL1

- digital speed selection up to 300rpm with soft start
- built-in digital timer
- reliable, quiet running mechanism
- fully adjustable cradle system

This lab scale platform shaker has powerful yet quiet shaking mechanisms and has been designed for trouble-free, continuous use. The cradle type platforms have four rubber cushioned horizontal securing bars which can be easily adjusted both vertically and horizontally to hold most sizes and types of vessel, including flasks, bottles and beakers. For example, they will accommodate the following Erlenmeyer flasks or bottles: 12 x 250ml or 9 x 500ml or 6 x 1000ml or 2 x 2000ml. Speed is continuously adjustable and is set digitally. The speed is accurately maintained, even over long runs. A built-in digital timer allows shaking times from 1 to 999 minutes to be set. Alternatively the unit can be set for continuous operation.

With BioCote silver based antimicrobial protection.

Specifications

Type of movement:	orbital
Orbit:	16 mm
Speed range:	30 ... 300 rpm
Max. Load:	10 kg
Timer:	1 ... 999 min
Power consumption:	50 W
Working temperature:	4 ... 40 °C
Platform dimensions (W x D):	335 x 335 mm
Overall dimensions (W x D x H):	360 x 420 x 270 mm
Net weight:	11 kg
Supply requirements:	230 V, 50 Hz
Protection class:	IP 31

Type	PK	Cat. No.
SSL1	1	9.728 840

Stuart



Orbital shaker, KS 260 basic/Package/KS 260 control/Package

Compact, low-level, platform shaker with highly effective, orbital motion, maximum capacity 7.5 kg. Large selection of attachments enable use with a wide variety of vessel shapes and sizes. Electronic speed control and timer adjustment.

Only Orbital shaker KS 260 control/ Package:

- Separate digital speed and timer displays with operating mode indication
- Timer: 0 to 9 h 59 min or continuous operation
- Controlled stop-point positioning function (enables use in automated robotic sampling routines)
- All functions can be controlled and documented using labworldsoft® software
- Interface: RS 232/analogue
- Special variant with reverse rotation function available on request

Attachments are not included - Please order separately.

Specifications

Type of movement:	orbital
Orbit:	10mm
Max. Load (incl. attachment):	7.5kg
Motor rating input/output:	45/10W
Speed range KS 260 basic/KS 260 control:	20 to 500rpm/10 to 500rpm
Speed indication KS 260 basic/KS 260 control:	LED/digital
Timer KS 260 basic/KS 260 control:	5 to 50min/continuous/1 to 599min/continuous
Dimensions (W x D x H):	360 x 420 x 98mm
Weight KS 260 basic/KS 260 control:	8.5kg/8.8kg
Housing IP rating to DIN EN 60529:	IP21
Interface:	RS232/analogue
Supply requirements:	230V 50/60Hz
Tested to DIN EN IEC 61010-1.	

Type	Plug type	PK	Cat. No.
KS 260 basic	EU	1	9.838 074
KS 260 control	EU	1	9.838 175

2

IKA



9.838 074

3



9.838 175

➔ Accessories for KS260, see page 517.

1

1 Orbital shaker SHEX1619DG

Ideal for applications that require CO₂ and humidity for optimal cell growth, the Extreme Environment Shaker is designed for use in extreme environments such as CO₂ incubators. A remote controller allows for external control of settings without disturbing the incubator atmosphere, and the shaker base is placed inside of the incubator. OHAUS

- Designed for use in CO₂ Incubators
- Can withstand extreme environments up to 100 % humidity
- Remote controller magnetically attaches to most incubators
- Patented Accu-Drive Shaking System
- Microprocessor Control
- Triple Eccentric Drive
- Speed Ramping Feature
- Spill-Resistant Design
- Touchpad Control with Independent LED Displays for Speed/Time
- Speed Calibration Mode
- RS232 Interface
- Overload Protection
- Audible Alarm

Scope of supply: Shaker incl. built-in tray and non-slip rubber mat

Specifications

Type of movement:	orbital
Orbit:	19 mm
Speed range:	15 to 500 rpm
Max. Load:	16 kg
Motor:	brushless DC Motor
Permissible ambient conditions:	-10 to +60 °C
Dimensions (W x D x H)	
Instrument:	294 x 355 x 149 mm
Remote control:	150 x 356 x 112 mm
Weight:	22.2 kg
Power supply:	230 V, 50/60 Hz

Type	PK	Cat. No.
SHEX1619DG	1	4.659 459

2

2 Orbital shaker KS501 digital

Low-profile laboratory shaker with large platform and 15kg load capacity. With continuously adjustable speed range: 0 to 300rpm, digital display and timer. Continuous operation is guaranteed even under extreme loads. Requires accessory attachments for operation (these are not supplied) IKA

Ideally suited for vessel sizes over 250ml, e.g. round bottom flasks, erlenmeyer flasks, culture flasks, bottles etc. Developed for biological and microbiological growth tests and for production of stock solutions.

Specifications

Type of movement:	orbital
Orbit:	30mm
Max. Load (incl. attachment):	15kg
Motor rating input/output:	70/19W
Speed range:	0 to 300rpm
Timer:	0 to 56 min./continuous
Interface:	RS 232
Dimensions (W x D x H):	505 x 585 x 120mm
Weight (without attachment):	26kg
Protection class acc. to DIN EN 60529:	IP21
Supply requirements:	230V 50/60Hz
Tested to DIN EN IEC 61010-1.	

Type	PK	Cat. No.
KS 501 digital	1	6.285 448

Optional accessories: Shaking attachments: AS 501.1, AS 501.4, AS 501.5, Non-slip mat STICKMAX

Shakers, KS/HS501 digital, accessories

For orbital shaker Ika KS501 digital and reciprocating shaker Ika HS501 digital.

IKA

AS 501.1 Universal attachment

For a variety of vessels (flasks, beakers etc.) with volumes of at least 50 ml (ideally greater than 250 ml). With tension rollers that can be mounted on 2 levels.
Usable area: 420 mm x 420 mm.
Dimensions (W x D x H) 480 mm x 500 mm x 120 mm. Weight: 4000 g.



9.838 046

AS 501.4 Gridded clip attachment

(Without spring clips). For shaking round bottom, flat-bottom, pear-shaped, volumetric and erlenmeyer flasks etc. Minimum volume 25 ml. Dimensions (W x D x H) 475 mm x 460 mm x 95 mm, weight 2640 g.
Capacity: Number of fixing clips (volume held) 110 x AS 2.1 (25ml), 55 x AS 2.2 (50 ml), 35 x AS 2.3 (100 ml), 16 x AS 2.4 (250 ml), 12 x AS 2.5 (500 ml), 8 x AS 2.6 (1000 ml)

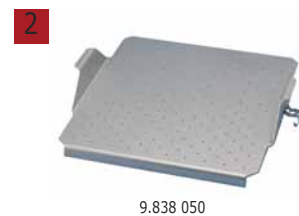

9.838 050

AS 501.5 Dish attachment

For the gentle movement of petri dishes, but also suitable for gentle mixing in vessels with large, flat bottoms (wide mouth erlenmeyers, beakers). Fitted with a non-slip, plastic mat.
Dimensions (W x D x H) 450 mm x 450 mm x 45 mm.
Usable area: 420 mm x 420 mm, weight 1120 g



9.838 049

Further accessories on request.

Type	Description	PK	Cat. No.
AS 501.1	Universal attachment	1	9.838 046
AS 501.4	Gridded clip attachment*	1	9.838 050
AS 501.5	Dish attachment	1	9.838 049

* Clips AS 2.1 (9.838 091), AS 2.2 (9.838 092), AS 2.3 (9.838 093), AS 2.4 (9.838 094), AS 2.5 (9.838 095) please order separately.

Orbital shakers Solaris™ 2000 and 4000



Thermo Scientific

Robust, high-capacity orbital shakers for advanced research, production and routine tasks. Can be used in incubators, climatic cabinets and refrigerators. With variable speed adjustment from 15 to 525 min⁻¹.

- For timer and continuous operation
- 99 individual programs can be stored
- Gentle starting and stopping of the device
- Automatic Imbalance detection with optical/acoustic alarm: the device stops until the incorrect loading has been corrected
- Automatic restart after disconnection of the power supply while maintaining all parameters
- Large, easy-to-read touchscreen display with speed and run time indication
- With maintenance-free, brushless motor
- Logging of warnings, alarms and operating steps
- USB and Ethernet connection for data output and device monitoring
- Low noise level
- Easily removable platforms and rounded corners for rapid cleaning



6.311 880

Scope of supply: shaker, mains cable, universal platform, platform screws and screw locking lacquer

Specifications

Type of movement:	orbital
Speed range:	15 ... 525 min ⁻¹
Accuracy:	±1 min ⁻¹
Orbit:	25 mm
Timer:	59 min ... 99 h
Environment:	-5 ... 40 °C, 80 % r.H.
IP code:	IP 20
Warranty:	2 years
Power supply:	100 ... 240 V, 50/60 Hz

Type	Permissible shaking quantity / maximum load kg	Width of the moving table mm	Depth of the moving table mm	Dimensions (W x D x H) mm	Net weight kg	PK	Cat. No.
Solaris™ 2000	19	305	356	370 x 470 x 150	20.9	1	6.311 880
Solaris™ 4000	38	762	457	580 x 650 x 180	75.1	1	6.311 881

1

1 2 Orbital shaker LLG-uniSHAKER 25

Powerful and smooth running orbital shaker. The maintenance-free brushless motor and the shaking mechanism with counterweight ensure smooth and stable running at all times. Digital display for speed and time.

Two different platforms (610 x 460 mm or 760 x 460 mm) and 7 clamps for vessels from 25 ml to 2000 ml available.

Please order platforms and clamps separately.

- Maximum load 25 kg

- Sturdy and robust steel housing
- Digital display with speed and time settings
- Variable speed from 50 to 500 min⁻¹
- Orbital Diameter of 25 mm for thorough mixing
- Timer setting from 1 to 99 min and continuous mode
- Various platforms and brackets available

Scope of supply: shaker, mains cable

2

Specifications

Type of movement:	orbital
Orbital diameter:	25 mm
Speed range:	50 ... 500 min ⁻¹
Max. load:	25 kg
Motor:	brushless DC motor
Timer:	1 ... 99 min, continuous
Power consumption:	250 W
Permissible ambient temperature:	4 ... 75 °C
Dimensions (W x D x H):	600 x 550 x 150 mm
Weight:	48 kg
Power supply:	230 V, 50 Hz
Warranty:	3 years

Type	Plug type	PK	Cat. No.
LLG-uniSHAKER 25	EU	1	6.263 590
LLG-uniSHAKER 25	UK	1	6.263 599

3

6.263 589

Accessories for Orbital shaker LLG-uniSHAKER 25

Description	PK	Cat. No.
Universal attachment, 610 x 460 mm	1	6.263 591
Universal attachment, 610 x 460 mm, with securing bars	1	6.263 589
Universal attachment, 760 x 460 mm	1	6.263 592
Clamp, 25 ml	1	6.263 699
Clamp, 50 ml	1	6.263 700
Clamp, 100 ml	1	6.263 593
Clamp, 250 ml	1	6.263 594
Clamp, 500 ml	1	6.263 595
Clamp, 1000 ml	1	6.263 596
Clamp, 2000 ml	1	6.263 597
Adhesive rubber mat, blue, 150 x 150 x 3 mm	2	6.263 598

4

9.838 400

Multi-Flask Shaker VKS 75 control

Big heavy-duty shaker for high loads also during continuous operation (floor installation only). Further accessories on request.

Bühler

Scope of supply: Basic device without shaking plate, without rack system. With digital display and programmable control with Touch-Display.

Specifications

Speed range:	30 ... 200 rpm in steps of 5
Orbit or stroke:	26 mm (model A) 50, 36, 60 or 80 mm (model B)
Max. loading:	max. 75 kg
Platform (W x D):	760 x 600 mm
Overall (W x D x H):	1050 x 835 x 250 mm
Weight:	110 kg
Supply requirements:	100 ... 240 V, 50/60 Hz

Type	PK	Cat. No.
VKS 75 A control	1	9.838 400
VKS 75 B control	1	9.838 403

1 Combi shaker KL 2

Mini shaker which can be switched between orbital and reciprocating motions. Includes flask attachment system with 3 clamping rollers. Versatile, for use in medical diagnostics, haematology, for cell cultivation or analysis. Max. load 4 x 500 ml or 2 x 1000 ml Erlenmeyer flasks.

Bühler

Scope of supply: Shaker and accessory platform with 3 clamping rollers and anti-slip mat.

Speed range:	30 ... 420 rpm with stepless electronic adjustment
Orbit or stroke:	8 mm
Max. loading:	2 kg
Platform (W x D):	300 x 300 mm
Timer:	0 ... 120 min/continuous
Overall (W x D x H):	355 x 455 x 195 mm
Weight:	13.5 kg
Supply requirements:	230 V, 50/60 Hz
Protection class:	IP 21



Type	PK	Cat. No.
KL 2	1	9.838 320

2 Flask shaker SF1

Creates a vigorous reciprocal shaking action. With clamps to accept 8 flasks up to 500ml capacity. With stepless variable speed control from 80 to 800 oscillations/min. and 10 to 60 minute timer with off and continuous run settings. Electronic feedback control ensures a constant speed irrespective of the load. For 230V 50Hz single phase supplies. With BioCote, silver-based, antimicrobial protection.

Stuart

Scope of delivery: Flask shaker incl. 2 arms, 8 clamps and allen key..

Please order extension kit for shaking of 12 bottles or flasks separately.

Specifications

Type of movement:	reciprocal
Orbit:	1.5 mm
Speed range:	8 ... 800 rpm
Max. Load:	3 kg
Timer:	10 ... 60 min/continuous
Power consumption:	50 W
Permissible ambient temperature:	5 ... 40 °C
Dimensions (W x D x H):	780 x 270 x 240 mm
Weight:	8.3 kg
Power supply:	230 V, 50 Hz



Type	PK	Cat. No.
SF1	1	9.950 372

3 Reciprocating shaker HS 501 digital

Low-profile laboratory shaker with large platform and 15kg load capacity. With continuously adjustable speed range: 0 to 300rpm, digital display and timer. Continuous operation is guaranteed even under extreme loads. Requires accessory attachments for operation (these are not supplied). Ideally suited for flasks, measuring cylinders and particularly separating funnels. Developed for universal applications.

IKA

Specifications

Type of movement:	reciprocal
Shaking diameter:	30 mm
Max. Load (with attachment):	15 kg
Motor rating input/output:	70/19 W
Speed range:	0 to 300rpm
Timer:	0 to 56 mins./continuous
Dimensions (W x D x H):	505 x 585 x 120 mm
Weight (without attachment):	26 kg
Protection class acc. to DIN EN 60529:	IP 21
Supply requirements:	230 V, 50/60 Hz
Tested to DIN EN IEC 61010-1.	

Type	PK	Cat. No.
HS 501 digital	1	6.270 850



➔ Accessories for Model HS 501 - please see page 513.

1

9.838 305

Compact shakers, KS 15 series / KS 15 control

Robust shakers for medium loads. Cost-effective. Suitable for continuous operation. From gentle orbital movement for cell or tissue cultures to powerful reciprocating movement of shallow vessels or separating funnels in food or environmental analysis. Programmable controller with Touch-Display and advanced features for control devices.

Bühler

Comprises: shaker without platform. Requires, but is not supplied with, platform attachments for operation.

Accessories:

- Attachment Combifix KS with 3 clamping strips and rubber mat
- Universal tray KS with holes for spring clips

Shaking speed:	30 ... 420 rpm continuously electronically adjustable, control devices in steps of 5
Orbit/travel:	17 mm
Max. loading:	15 kg
Timer:	0 ... 120 min/continuous, control devices programmable/continuous
Usable platform area (W x D):	400 x 300 mm
Overall (W x D x H):	510 x 490 x 150 mm
Weight:	19 kg
Supply requirements:	230 V, 50/60 Hz

Type	Type of movement	PK	Cat. No.
KS 15 A control	orbital	1	9.838 305
KS 15 B control	reciprocal	1	9.838 306
KS 15 A	orbital	1	9.838 307
KS 15 B	reciprocal	1	9.838 308

2

9.838 063

Reciprocating shaker, HS 260 basic / HS 260 control

Compact, low-level, platform shaker with highly effective, reciprocating motion, maximum capacity 7.5 kg. Electronic speed control and timer adjustment. Large selection of attachments enable use with a wide variety of vessel shapes and sizes. Attachments are not included - Please order separately.

IKA

Only Reciprocating shaker HS 260 control:

- Separate digital speed and timer displays with operating mode indication
- Timer: 0 to 9 h 59 min or continuous operation
- Controlled stop-point positioning function (enables use in automated robotic sampling routines)
- All functions can be controlled and documented using labworldsoft® software

Specifications

Type of movement:	reciprocal
Shaking diameter:	20 mm
Max. Load (incl. attachment):	7.5 kg
Motor rating input/output:	45W/10 W
Speed range HS 260 basic/ HS 260 control:	20 to 300 rpm/10 to 300 rpm
Speed indication HS 260 basic/ HS 260 control:	LED/digital
Time switch clock HS 260 basic/ HS 260 control:	5 to 50min/continuous/1 to 599min/continuous
Dimensions (W x D x H):	360 x 420 x 100 mm
Weight HS 260 basic/ HS 260 control:	8.5 kg/8.8 kg
Housing IP rating to DIN EN 60529:	IP 21
Interface:	RS 232/analogue
Power supply:	230V, 50/60Hz
Tested to DIN EN IEC 61010-1.	

3

9.838 185

Type	Plug type	PK	Cat. No.
HS 260 basic	EU	1	9.838 063
HS 260 control	EU	1	9.838 185

4. Stirring, Shaking, Mixing Shakers and mixers/Reciprocating shakers

Accessories for shakers HS/KS 260

AS 260.1 Universal attachment

Able to hold most types of container using adjustable tension rollers. Surface: 320 x 320mm

AS 260.2 Fixing clip platform

For shaking round bottom vessels, volumetric and Erlenmeyer flasks. Supplied without clips.

Max. number of clips (capacity held): 56 x AS 2.1 (25ml), 23 x AS 2.2 (50ml), 23 x AS 2.3 (100ml), 11 x AS 2.4 (250ml), 9 x AS 2.5 (500ml), 5 x AS 2.6 (1000ml)

AS 260.3 Petri dish attachment

For gentle mixing and suspension of cell cultures or growth media in petri dishes, culture bottles and containers. With integral anti-slide mat (PP).

AS 260.5 Separating funnel attachment

For HS 260 basic and control

For shaking, elution, extraction, gassing out, dissolving, enriching. The 3 tension rollers supplied are height-adjustable to accommodate different separating funnel sizes. The separating funnels are secured by means of O-rings (6 O-rings supplied).

Capacity: Number of funnels (pear shaped) x volume 6 x 50ml, 5 x 100ml, 3 x 250ml, 3 x 500ml

Type	Description	Dimensions (W x D x H) mm	PK	Cat. No.
AS 260.1	Universal attachment	425 x 335 x 135	1	9.838 080
AS 260.2	Gridded clip platform attachment*	330 x 330 x 24	1	9.838 191
AS 260.3	Petri dish attachment	410 x 370 x 32	1	9.838 192
AS 260.5	Separating funnel attachment	334 x 425 x 145	1	9.838 193

* Clips AS 2.1 (9.838 091), AS 2.2 (9.838 092), AS 2.3 (9.838 093), AS 2.4 (9.838 094), AS 2.5 (9.838 095) please order separately.



Universal shakers, SM 30 series /SM 30 control

Powerful shakers for large loads. Choice of orbital or reciprocating action models.

Suitable for continuous operation. For analytical or diagnostic processes in biology, chemistry or pharmacy, plant culture or in the food industry, e.g. for transport simulations.

Various attachments for different requirements are available as accessories. Programmable controller with Touch-Display and advanced features for control devices.

Scope of supply: supplied with shaking rack and rubber mat. Attachments required, please order separately.

Speed range:	15 ... 300 rpm stepless, electronic adjustment, control devices in steps of 5
Orbit or travel:	26 mm (A + C models) 30, 46 or 50 mm (B models)
Max. loading:	30 kg
Timer:	0 ... 120 min/continuous, control devices programmable/continuous
Platform (W x D):	560 x 400 mm
Overall (W x D x H):	680 x 610 x 160 mm
Weight:	33 kg
Supply requirements:	230 V, 50/60 Hz

Type	Type of movement	PK	Cat. No.
SM 30 A	orbital	1	9.838 101
SM 30 B	reciprocating	1	9.838 111
SM 30 C	orbital, reciprocating	1	9.838 115
SM 30 A control	orbital	1	9.838 121
SM 30 B control	reciprocating	1	9.838 131
SM 30 C control	orbital, reciprocating	1	9.838 135

6 7 Accessories for universal shaker SM 30

Type	PK	Cat. No.
Rack system Combifix SM, Set A	1	9.838 201
Rack system Combifix SM, Set B	1	9.838 205
Rack system Combifix SM, Set C	1	9.838 208
Universal tray SM (without spring clamps)	1	9.838 210
Sliding plate for top frame with Combifix SM, Set A	1	6.231 576
Sliding plate for top frame with Combifix SM, Set B	1	6.285 190
Sliding plate for top frame with Combifix SM, Set C	1	6.285 191
Mounting set for universal trays or sliding plates	1	6.255 238
2-storey top frame SM (without platforms)	1	9.838 211
2-storey top fram SM/TH (for using SM with TH)	1	6.510 572

Bühler



9.838 121

Bühler



1

1 Rocking shaker RS-RS 5

Analogue laboratory shaker with a maximum load of 3 kg for gentle and effective mixing of samples.

Phoenix Instrument

- Safe stand
- Adjustable screw feet
- D.c. motor
- Wide range of accessories

Scope of supply: Shaker incl. tray attachment

Specifications

Type of movement:	rocking
Rocking angle:	7°
Max. Load:	3 kg
Rating:	16 W
Speed range:	0 to 80 rpm
Dimensions (W x D x H):	270 x 330 x 130 mm
Dimensions platform (W x D):	240 x 240 mm
Weight:	2.7 kg
Protection class acc. to DIN EN 60529:	IP 21
Power supply:	100-240 V, 50/60 Hz

Type	PK	Cat. No.
RS-RS 5	1	4.660 777

Rocking shaker 35 EZ

The Rocker 35 EZ is the next generation large capacity rocker from Labnet.

Labnet

This upgraded Rocker 35 is designed for durability in laboratories requiring a larger platform area and precise control over rocking parameters. It is backed by a 5 year warranty. Both speed and time are easily selectable and the analog control has been upgraded to display discreet values. The tilt is now easily adjustable with knob on side. This system can easily handle up to 5 kg of load so a double platform can be fully loaded without any variation to speed. This unit comes in both single and dual platform models and includes a ribbed non-slip rubber mat to keep containers in place.

2

6.283 296

Specifications

Type of movement:	rocking
Rocking angle:	adjustable, ±20°
Max. Load (incl. attachment):	5 kg
Timer:	10 to 120 min or continuous
Speed range:	10 to 120 rpm
Power:	6 W
Dimensions (W x D x H)single/double platform:	360 x 360 x 170 mm/360 x 360 x 260 mm
Weight single/double platform:	6.5 kg/7.8 kg
Power supply:	230 V, 50/60 Hz

Type	Description	Plug type	PK	Cat. No.
35 EZ	Single platform	EU/UK	1	6.283 296
35 EZ	Double platform	EU/UK	1	6.283 298

Rocking shaker Rocker 2D basic/2D digital

Rocking shaker with fixed speed for smooth mixing tasks. For homogeneous mixing in flasks, culture flasks, Petri dishes and tubes. Even with load and voltage fluctuations the shaking speed remains constant. A fixed tilt angle ensures reproducible test results.

- Different attachments allow a variety of applications
- Usable at 4 to 50 °C in incubators
- Anti-slip rubber mat included
- Easy operation by foil keypad
- Suitable for continuous operation

Rocker 2D digital only:

- Timer: Countdown, adjustable from 1s to 99h 59min
- Counter: Display of shaking time
- Error code display

Specifications

Type of movement:	rocking
Rocking angle Rocker 2D basic/2D digital:	8°/0 - 15°
Max. Load (incl. attachment):	2kg
Motor rating input/output:	16/9W
Speed range:	5 to 80rpm
Speed display:	7 segment LED
Dimensions (W x D x H):	280 x 330 x 150mm
Weight:	2.2kg
Protection class acc. to DIN EN 60529:	IP 21
Power supply:	100-240V, 50/60Hz

Type	PK	Cat. No.
Rocker 2D basic	1	9.729 984
Rocker 2D digital	1	9.729 985

1

IKA



9.729 984

Rocking Shakers SHRK series

The Rocking Shakers are ideal for cell culture and blotting applications and are designed to be used in a variety of environmental conditions.

- Variable control for speed, tilt and time
- Two-tier model 07AL2 doubles workable capacity
- Low Profile Design
- Microprocessor Control
- Independent Control Knobs (analogue)
- Overload Protection
- Speed Ramping Feature
- Spill-Resistant Design
- Clock timer
- Suitable for CO₂ environments

Scope of supply:

- 07AL1/04DG:** Shaker incl. built-in tray with non-slip rubber mat
- 07AL2:** as 07AL1/04DG, additionally incl. second tray with screws and mat

Specifications

Type of movement:	rocking
Rocking angle:	0 to 15°
Timer models analogue/digital:	1 to 120 min/1 s to 160 h
Motor:	Stepper Motor
Permissible ambient conditions:	-10 to +60 °C
Weight:	7 kg
Power supply:	230 V, 50/60 Hz

Type	Permissible shaking quantity / maximum load kg	Min. speed rpm	Max. speed rpm	Display type	Dimensions (l x w x h) mm	PK	Cat. No.
07AL1	7	1	75	analogue	425 x 279 x 140	1	4.659 476
07AL2	7	1	75	analogue	425 x 279 x 241	1	4.659 477
04DG	4	1	50	digital	425 x 254 x 140	1	4.659 481

2

OHAUS



4.659 476

3



4.659 481

4. Stirring, Shaking, Mixing Shakers and mixers/Rocking shakers

1 Rocking Shaker, Mini, SSM4

This compact rocker is ideal where gentle mixing is required. It has a see-saw rocking action that creates a wave motion within vessels such as culture flasks, Petri dishes etc.

Stuart

- Small space saving design, ideal for personal use
- Gentle rocking action
- Digital speed control and built-in timer
- Optional tier system available to increase capacity
- supplied with a non-slip mat
- digital selection of both speed and time

An accessory tier system is available. Fitted in seconds, without the need for tools, it triples the available space for samples. With BioCote, silver-based, antimicrobial protection.

Specifications

Type of movement:	rocking
Rocking angle:	7°
Angle adjustable:	No
Speed range:	5 to 70rpm
Max. Load:	3kg
Platform dimensions (W x D):	235 x 235mm
Overall dimensions (W x D x H):	240 x 300 x 150mm
Net weight:	5kg
Power supply:	230V 50Hz, 50W

Type	PK	Cat. No.
SSM4	1	9.728 821

1



2



2 Rocking shaker SSL4, large platform

- Large platform rockers - ideal for multiple users
- Gentle rocking action
- Digital speed control and built-in timer
- Optional tier system available to increase capacity
- Incl. non-slip mat

Stuart

This rocker has large platform able to accommodate a number of samples, ideal for a busy lab. It is very quiet in operation and designed to be run continuously.

The see-saw rocking action creates a wave motion within vessels such as culture flasks, petri dishes etc.

An accessory tier system is available. Fitted in seconds, without the need for tools, it triples the available space for samples. With BioCote, silver-based, antimicrobial protection.

Specifications

Type of movement:	rocking
Rocking angle:	7°
Angle adjustable:	No
Speed range:	5 to 70rpm
Max. Load:	10kg
Platform dimensions (W x D):	355 x 355mm
Overall dimensions (W x D x H):	360 x 420 x 160mm
Net weight:	10kg
Supply requirements:	230V, 50Hz, 50W

Type	PK	Cat. No.
SSL4	1	9.728 801

Attachments are not included - Please order separately

4. Stirring, Shaking, Mixing

Shakers and mixers/Rocking shakers-Tumbling shakers

1 Rocking shaker PMR-100

Large capacity, adjustable angle and speed platform rocker, providing soft or intensive side to side rocking for optimal mixing of samples. For use in cold rooms or incubators with ambient operating temperature range +4°C to +40°C. Continuous or timed operation, with automatic switch-off. Integral timer: 1min to 99h 59min.

Grant



Specifications

Type of movement:	rocking
Rocking angle (adjustable):	0 to 10° (fixed at 10° over 50 rpm)
Max. Load (incl. attachment):	5 kg
Power consumption:	13 W
Speed range:	1 to 99 rpm
Speed display:	LCD
Dimensions platform (W x D):	480 x 380 mm
Dimensions (W x D x H):	430 x 480 x 210 mm
Weight:	12 kg
Protection class acc. to DIN EN 60529:	IP20
Power supply:	12 V

Type	PK	Cat. No.
PMR-100	1	9.721 015

2 Rocking shakers Duomax 1030

The Rocking shakers Duomax are suitable for the modular Incubator 1000 and are recommended for applications which require variable temperatures. With 2-dimensional tilting movement, suitable for petri dishes, culture bottles, erlenmeyer flasks and all standard vessels.

Heidolph

- 2 models available: Tilt angle to 5° for soft and gentle movements or tilt angle to 10° for a much stronger motion
- An overtemperature sensor preventatively shuts off the unit in a dangerous heat-up situation, particularly valuable for you in case of continuous operation
- Insulated drive system prevents any heat-up coming from the motor and consequently thermal damage to your sample
- Designed with a low center of gravity which prevents gliding at high speed, even on a damp surface
- Set and continuously adjust the variable speed on the analog control knob, suitable for all standard vessels
- An analog process timer allows for unattended operation. When the set time has elapsed, an acoustic alarm will sound and the operation stops



Specifications

Type of movement:	rocking
Tumbling angle:	5° or 10°
Speed range:	2 ... 50 rpm
Max. Load:	5 kg
Timer:	1 ... 120 min
Power consumption:	115 W
Permissible ambient temperature:	5 ... 31 °C
Permissible relative moisture:	80 %
Platform dimensions (W x D):	290 x 258 mm
Overall dimensions (W x D x H):	320 x 375 x 185 mm
Weight:	8 kg
Power supply:	230 V, 50/60 Hz
Protection class acc. to DIN EN 60529:	IP 40

Type	Inclination angle °	PK	Cat. No.
Duomax 1030	5	1	9.839 855
Duomax 1030	10	1	9.839 856



1 Tumbling Shaker LLG-uniSHAKER 2

Multi-functional shaker with dimpled mat, perfect for foam-free mixing of blood and other biological samples in centrifuge tubes. Suitable for a variety of tubes and dishes.

Scope of supply: shaker, non-slip mat

Specifications

Type of movement:	tumbling
Tumbling angle:	20°
Speed:	fixed, 20 min ⁻¹
Max. Load:	1.6 kg
Ambient Temperature:	4 ... 45 °C
Platform Dimensions (W x D):	202.5 x 152.5 mm
Dimensions (W x D x H):	202.5 x 152.5 x 202.5 mm
Weight:	2 kg
Power supply:	230 V, 50 Hz
Warranty:	3 years

Type	Plug type	PK	Cat. No.
LLG-uniSHAKER 2	EU	1	6.263 640
LLG-uniSHAKER 2	UK	1	6.263 641



2 Platform tumbling shaker PS-3D

Platform shaker with smooth, 3-dimensional tumbling movement. Ideal for mixing tubes, culture bottles, culture dishes and microtiter plates. Space-saving, robust and quiet.

Grant

- Simple speed adjustment
- Robust drive
- Suitable for continuous operation up to 7 days
- Low energy consumption
- With anti-slip mat
- Fixed angle of 7°

Specifications

Type of movement:	tumbling
Tumbling angle:	7°
Speed range:	5 to 60 rpm
Max. Load:	1.0 kg
Ambient Temperature:	+4 to 40 °C
Dimensions Plattform (W x D):	215 x 215 mm
Dimensions (W x D x H):	235 x 235 x 140 mm
Weight:	1.2 kg
Power supply:	12 V

Type	Plug type	PK	Cat. No.
PS-3D	EU/UK	1	9.721 014



3 Platform tumbling shaker PMR-30

Smooth rocking motion for gentle sample agitation in tubes, culture flasks, dishes and boxes. Continuous or timed operation with automatic switch-off.

Grant

Specifications

Type of movement:	tumbling
Tumbling angle:	7°
Speed range:	5 to 30rpm
Max. Load:	1.0kg
Timer:	1min to 23h 59min
Ambient Temperature:	+4 to 40°C
Dimensions Plattform (W x D):	215 x 215 mm
Dimensions (W x D x H):	220 x 205 x 120mm
Weight:	2kg
Power supply:	12V

Type	Plug type	PK	Cat. No.
PMR-30	EU/UK	1	9.721 011

4. Stirring, Shaking, Mixing Shakers and mixers/Tumbling shakers

1 Tumbling shakers Mini Twist and Mini Mixer

Both shakers may be used in temperature controlled environments.

- Gyrotory action provides gentle, thorough mixing
- Mini Twist: Perfect for centrifuge and blood tubes
- Mini Mixer: Designed for processing blots and staining gels

Labnet



Supplied with:

Mini Twist incl. positioning mat

Mini Mixer incl. anti-slip mat and 2 large blot boxes

Specifications

Speed range	20rpm
Motion/Pitch	Mini Twist: 3-D/fixed 20° Mini Mixer: 3-D/fixed 5°
Maximum load	0.8 kg
Ambient operating range	+4°C to 65°C
Dimensions (W x D x H):	Mini Twist: 24.1cm x 17.15cm x 15.24 cm Mini Mixer: 24cm x 17.5cm x 15cm
Weight	0.88kg
Electrical supply	230V, 50 Hz

Type	PK	Cat. No.
Mini Twist	1	9.595 330
Mini Mixer	1	9.595 331

2 Multi-function tumbling shaker PS-M3D

With consistent and reproducible agitation throughout the speed range, multi segment program.

Grant



Specifications

Type of movement:	orbital (diam. 22mm) reciprocal (0 to 360°, 30° steps) vibrating (0 to 5°, 1° steps)
Tumbling angle:	7°
Speed range:	1 to 100rpm
Max. Load:	1.0kg
Timer Type of movement orbital and reciprocal/vibrating:	0 to 250 sec/0 to 5 sec
Ambient Temperature:	+4 to 40°C
Dimensions Plattform (W x D):	215 x 215 mm
Dimensions (W x D x H):	235 x 235 x 140 mm
Weight:	2kg
Power supply:	12V

Type	Plug type	PK	Cat. No.
PS-M3D	EU/UK	1	9.721 017



1

9.729 986

Tumbling shakers Rocker 3D basic/3D digital

Shaker with three-dimensional tumbling motion and a fixed speed for smooth mixing tasks. A fixed angle ensures reproducible test results.

IKA

- Different attachments allow a variety of applications
- Usable at 4 to 50°C in incubators
- Anti-slip rubber mat included
- Easy operation by foil keypad
- Suitable for continuous operation

Rocker 3D digital only:

- Timer: Countdown, adjustable from 1s to 99h 59min
- Counter: Display of shaking time
- Error code display

Specifications

Type of movement:	tumbling
Tumbling angle Rocker 3D basic/3D digital:	8°/0 - 15°
Max. Load (incl. attachment):	2kg
Motor rating input/output:	16/9W
Speed range Rocker 3D basic/3D digital:	30rpm (fixed)/5 to 80rpm
Speed display (Rocker 3D digital only):	7 segment LED
Dimensions (W x D x H) Rocker 3D basic/3D digital:	280 x 330 x 165mm/280 x 330 x 185mm
Weight:	2.2kg
Protection class acc. to DIN EN 60529:	IP 21
Power supply:	100-240V, 50/60Hz

Type	Min. speed rpm	Max. speed rpm	PK	Cat. No.
Rocker 3D basic	30	30	1	9.729 986 1
Rocker 3D digital	5	80	1	9.729 987

2

4.664 342

Orbital Platform Shaker Belly Button®

IBI Scientific

This shaker is designed with available space in mind. The easily adjustable speed and platform pitch angle controls provide a wide range of agitation conditions, from extremely gentle to vigorous. The Belly Button® shaker is an exceptionally simple liquid agitation system consisting of an orbiting platform flexibly anchored at four corners so that the platform motion, when adjusted by the platform pitch control collar, is an extremely effective combination of rocking platform and orbital shaker.

- Compact version with low space requirement
- Ideal for cell and tissue culture applications, gel or blot processing
- Suitable for cold store and incubator
- Made of chemically resistant materials such as stainless steel and anodised aluminium
- Solid, robust and long-lasting design

BBUAAUV1S: With round 220 V power cord, white silicone mat and operation manual.

BBULS0001: With tube mat and round 220 V European power cord.

3

4.664 343

Specifications

Type of movement:	tumbling
Tumbling angle:	0° ... 8°
Speed range:	0 ... 100 rpm
Max. load:	2.2 kg
Overall dimensions (W x D x H):	203 x 203 x 133 mm
Platform dimensions (W x D):	178 x 178 mm
Rel. humidity:	97 %
Operation temperature:	0 ... 60 °C
Supply requirements:	230 V
Power:	11 W

Type	PK	Cat. No.
BBUAAUV1S	1	4.664 342 2
BBULS0001	1	4.664 343 3

Tumbling Shakers SHWV series

- The Tumbling Shakers are ideal for cell culture and blotting applications and are designed to be used in a variety of environmental conditions.
- Variable control (analogue model) or display (digital model) for speed, tilt and time
 - Low Profile Design
 - Microprocessor Control
 - Independent Control Knobs (analogue)
 - Overload Protection
 - Speed Ramping Feature
 - Spill-Resistant Design
 - Clock timer
 - Suitable for CO₂ environments

Scope of supply: 02DG/02AL Shaker incl. built-in tray with non-slip rubber mat

Specifications

Type of movement:	tumbling
Tilt angle Model analogue/digital:	0 to 16°/0 to 20°
Max load:	2.3 kg
Timer Model analogue/digital:	1 to 120 min/1 s to 160 h
Motor:	Stepper Motor
Permissible ambient conditions:	-10 to +60 °C
Weight:	approx. 7 kg
Power supply:	230 V, 50/60 Hz

Type	Min. speed rpm	Max. speed rpm	Display type	Dimensions (l x w x h) mm	PK	Cat. No.
02AL	1	75	analogue	425 x 279 x 165	1	4.659 478 2
02DG	1	30	digital	413 x 254 x 165	1	4.659 475 1



4.659 475



4.659 478

3 Tumbling shaker SSL3, large platform

- Large platform rocker - ideal for multiple users
- Gentle rocking action
- Digital speed control and built-in timer
- Optional tier system available to increase capacity
- incl. non-slip mat

This rocker has a large platform able to accommodate a number of samples, ideal for a busy lab. Designed to be run continuously, they are very quiet in operation. The tumbling gyratory motion is ideal for low foaming agitation, DNA extractions, staining and de-staining procedures etc. The tilt angle can be adjusted to any position by hand to optimise mixing of vessels.

An accessory tier system is available. Fitted in seconds, without the need for tools, it triples the available space for samples.

With BioCote, silver-based, antimicrobial protection.

Specifications

Type of movement:	tumbling
Tumbling angle:	3° to 12°
Angle adjustable:	Yes by hand
Speed range:	5 to 70rpm
Max. Load:	10kg
Platform dimensions (W x D):	355 x 355mm
Overall dimensions (W x D x H):	360 x 420 x 170mm
Net weight:	10kg
Supply requirements:	230V, 50Hz, 50W

Type	PK	Cat. No.
SSL3	1	9.728 800

Attachments are not included - Please order separately

Stuart



Tumbling Shakers Polymax 1040/2040

The Tumbling Shakers Polymax are suitable for the Modular Incubator 1000 and are recommended for applications which require variable temperatures. With 3-dimensional tilting movement, suitable for Petri dishes, culture bottles, Erlenmeyer flasks and all standard vessels.

Heidolph

- An overtemperature sensor preventatively shuts off the unit in a dangerous heat-up situation, particularly valuable for you in case of continuous operation
- Designed with a low center of gravity which prevents gliding at high speed, even on a damp surface
- Set and continuously adjust the variable speed on the analog control knob, suitable for all standard vessels
- An analog process timer allows for unattended operation.

Specifications

Type of movement:	tumbling
Tumbling angle:	5° or 10°
Timer:	1 ... 120 min
Power consumption:	115 W
Permissible ambient temperature:	5 ... 31 °C
Permissible relative moisture:	80 %
Power supply:	100 ... 240 V, 50/60 Hz



1 Tumbling Shakers Polymax 1040

Suitable for a medium sample throughput.

Heidolph

Specifications

Speed range:	2 ... 50 rpm
Max. Load:	5 kg
Platform dimensions (W x D):	290 x 258 mm
Overall dimensions (W x D x H):	320 x 375 x 195 mm
Weight:	8 kg
Protection class acc. to DIN EN 60529:	IP 40

Type	Inclination angle °	PK	Cat. No.
Polymax 1040	5	1	9.839 857
Polymax 1040	10	1	9.839 859



4.663 380

2 Orbital platform shaker Belly Dancer®

The undulating, three-dimensional motion of this lab shaker has been designed to provide optimal movement for tissue culture, staining and destaining gels, Northern, Southern or Western blotting and immunoprecipitation. The simple liquid agitation system, consisting of an orbiting platform, which is flexibly anchored at four corners, so that the platform movement, with an appropriately set inclination, is an effective combination of orbital and tumble shaker.

IBI Scientific

- Ideal for gel or blot processing
- Suitable for cold store and incubator
- Made of chemically resistant materials such as stainless steel and anodised aluminium
- Solid, robust and long-lasting design
- Low-noise

BDRLS0004: With additional 2nd story platform (approx. 300 x 300 mm), aluminium spacer legs (approx. 114 mm) and a non-skid removable mat.

BDRLS0005: With extension platform (approx. 450 x 450 mm) and a non-skid removable mat.

BDRLS0006: With non-skid mat for tubes.

BDRAA220S: With white silicone mat.

Specifications

Type of movement:	tumbling
Orbit size:	25.4 mm
Tumbling angle:	0° ... 8°
Speed range:	0 ... 100 rpm
Max. load:	9.1 kg
Overall dimensions (W x D x H):	381 x 381 x 229 mm
Platform dimensions (W x D):	305 x 305 mm
Rel. humidity:	97 %
Operation temperature:	0 ... 40 °C
Supply requirements:	230 V/50/60 Hz
Power:	70 W

Type	PK	Cat. No.
BDRLS0004	1	4.663 380
BDRLS0005	1	4.664 345
BDRLS0006	1	4.664 346
BDRAA220S	1	4.664 344

Suitable accessories can be found in our online shop.

E & OE.



4.664 345

Thermo shaker LLG-uniTHERMIX 1 pro and 2 pro

The LLG-uniTHERMIX pro is ideal for shaking and temperature control of a variety of tubes or plates (depending on the block used). With its high temperature uniformity, fast heating rate and excellent mixing results the LLG-uniTHERMIX pro is perfect for the incubation of samples of any kind, in particular for Life Science applications, e.g. Enzyme reactions, transformations, denaturation of DNA and RNA. The heating blocks are magnetically attached to the LLG-uniTHERMIX pro and do not have to be screwed down.

- Easy and quick change of heating blocks due to magnetic fastening
- Precise temperature control system
- Temperatures up to 100 °C
- Temperature accuracy of ±0.5 °C (20 ... 45 °C)
- Efficient mixing up to 1500 rpm (depending on the heating block)
- Up to 9 storable programs
- Many block options available
- Automatic block recognition

LLG-uniTHERMIX 1 pro:
with shaking and heating function, Temperature range: RT + 5 °C ... approx. 100 °C

LLG-uniTHERMIX 2 pro:
with shaking, cooling and heating function, Temperature range: 15 °C below RT ... approx. 100 °C

Blocks must be ordered separately.

Scope of supply: thermal shaker, 4 suction feet

Specifications

Temperature range	
LLG-uniTHERMIX 1 pro:	RT + 5 °C ... approx. 100 °C
LLG-uniTHERMIX 2 pro:	15 °C below RT ... approx. 100 °C
Temperature control:	±0.5 °C (at 20 ... 45 °C)
Uniformity:	±0.5 °C (at 20 ... 45 °C)
Max. heating rate:	5.5 °C/min
Max. cooling rate (LLG-uniTHERMIX 2 pro only):	5 °C/min (100 °C ... RT) 0.5 °C/min (below RT)
Electrical heating/cooling power:	200 W
Speed range:	300 ... 1500 min ⁻¹
Orbit:	3 mm
Display:	LCD
Programs:	6 stages, 9 programs
Timer:	1 ... 99 hours or continuous
Capacity:	1 exchangeable block*
Dimensions (W x D x H):	200 x 235 x 120 mm
Weight:	7.3 kg
Power supply:	220 ... 240 V, 50/60 Hz
Warranty:	3 years

1



6.263 482

2



6.263 484

Type	Plug type	PK	Cat. No.
LLG-uniTHERMIX 1 pro	EU	1	6.263 482
LLG-uniTHERMIX 1 pro	UK	1	6.263 483
LLG-uniTHERMIX 2 pro	EU	1	6.263 484
LLG-uniTHERMIX 2 pro	UK	1	6.263 485

Heating blocks for Thermo shaker LLG-uniTHERMIX 1 and 2 pro

For	PK	Cat. No.
24 tubes, 0.5 ml	1	6.263 486
24 tubes, 1.5 ml	1	6.263 487
24 tubes, 2 ml	1	6.263 494
8 tubes, 5 ml	1	6.263 495
8 tubes, 15 ml	1	6.263 496
4 tubes, 50 ml	1	6.263 497
96 well PCR plates, 0.2 ml tubes	1	6.263 498
96/384 microplate	1	6.263 499

3



6.263 487



1 Thermoshaker PCMT for microtubes and PCR plates

Variable speed, variable temperature heating and cooling thermoshaker with a choice of blocks for microtubes and microplates. The PCMT can cool down to 15°C below ambient temperature.

Grant

- Fast heat-up and cooling times
- Temperature setting range +4°C to +100°C
- Temperature control range 15°C below ambient to +100°C
- Shaking speed: 250 to 1400 rpm
- Temperature uniformity at 37°C: ±0.1°C
- Choice of 5 interchangeable blocks
- orbit 2mm

Block is required and not included in delivery. Please order separately.

Applications:

- Genetic analyses, extraction of DNA, RNA and further sample preparation
- Biochemical studies of enzymatic reactions and processes
- Extraction of metabolites from cellular material

Type	PK	Cat. No.
PCMT	1	9.721 050

Accessory blocks for Thermoshaker PCMT

Grant

Type	For	PK	Cat. No.
HC24N	24 x 1.5 ml microtubes	1	9.721 073
HC18	20 x 0.5 + 12 x 1.5 ml microtubes	1	9.721 052
HC24	24 x 2.0 ml microtubes	1	9.721 053
HC32	20 x 0.2 + 12 x 1.5 ml microtubes	1	9.721 054
HC96	96-well microplates (0.2 ml)	1	9.721 055



9.721 052

3 Thermo shaker AccuTherm

The AccuTherm is a temperature controlled mixer that uses peltier technology to rapidly heat and cool precious samples. The combination of heating/cooling with mixing makes the AccuTherm ideal for many life science research applications in the fields of molecular biology, biochemistry and clinical chemistry. It's compact footprint incorporates an intuitive control panel with a large multicolor display, which allows users to easily program and view temperature, time and speed settings. Eight interchangeable aluminum blocks accommodate PCR plates and tubes ranging in size from 0.2ml to 15ml.

Labnet

Specifications

Temperature operation range:	Amb. -14°C to +100°C
Temperature adjustable range:	0°C to +105°C
Accuracy/resolution:	±0.5°C/0.5°C
Max. heating time:	6.5°C/min
Max. cooling time:	1.5°C/min
Shaking frequency:	300 to 1500rpm
Orbit:	3mm
Dimensions (W x D x H):	330 x 166 x 240mm
Capacity:	1 exchangeable block*
Weight:	8.5kg
Electrical heating/cooling power:	150W
Power supply:	230V, 50/60Hz

Type	PK	Cat. No.
AccuTherm	1	6.261 411

*Exchangeable blocks are not included in delivery.

Accessories for Thermo shaker AccuTherm

Labnet

Description	PK	Cat. No.
Block A for 40 x 1.5 ml reaction tubes	1	6.261 695
Block B for 54 x 0.5 ml reaction tubes	1	6.261 696
Block C for 96 x 0.2 ml reaction tubes	1	6.261 697
Block D for 24 x 15 mm reaction tubes	1	6.261 698
Block E, water bath (115 x 73 x 38mm)	1	6.261 699
Block G for 26 x 0.5 ml and 24 x 1.5 ml reaction tubes	1	6.261 706
Block H for 40 x 2.0 ml reaction tubes	1	6.261 707
Block J for 96 well Elisa plates	1	6.261 708

Microtube thermoshaker PHMT

By combining the mixing operation with the incubation phase, reaction process times and operator workload are reduced and efficiency of many procedures is increased, resulting in a higher throughput.

- temperature range: +5 to 100 °C
- uniformity at 37 °C: ±0.1°C
- shaking speed: 250rpm to 1400 rpm
- timed shaking operation: 1 min to 96 hours
- rapid heat-up
- continuous or timed operation, with alarm buzzer and automatic switch-off facility
- incl. interchangeable block
- mixing and incubation phases are combined reducing reaction processing times

Grant



6.234 725

Scope of supply: Thermoshaker with one block as indicated. Further blocks on request.

Type	For	PK	Cat. No.
PHMT-PSC18	20 x 0.5 ml + 12 x 1.5 ml	1	6.234 725
PHMT-PSC32	20 x 0.2 ml + 12 x 1.5 ml	1	9.721 079
PHMT-PSC24	24 x 2.0 ml	1	9.721 041
PHMT-PSC24N	24 x 1.5 ml	1	9.721 072
PHMT-PSC96	1 x 96 well	1	9.721 080

Thermal Shaker ISTHB

The Thermal Shakers and Cooling Thermal Shakers are designed for applications that require consistent and precise results. With heating, cooling and shaking capabilities. These shakers use interchangeable blocks to accommodate a wide variety of tubes and microplates. The easy-to-use, 4.3", colour, LCD touch screen allows the user to save and visibly track progress through the live status bar for five user defined programs, each with five individual steps. The unit's enhanced electronics and dual temperature sensors provide accurate, dependable temperature settings across the operating range.

OHAUS

- 4.3" colour LCD touch screen display provides an intuitive interface
- Rapid heating, cooling and high speed shaking ability
- Internal memory stores five separate 5-step programs, unlimited with USB
- Temperature ramp rate, 0.5 °C steps
- Single Point Calibration Mode
- Pulse Mode Feature
- Maximum Temperature Limiting Function
- Hot Top Indicator
- Audible Alarm

Scope of supply: Thermal Shaker incl. 1.5 ml block, clear rack and cover

Specifications

Temperature range	
Thermal Shaker:	4 °C above ambient up to 100 °C
Cooling Thermal Shaker:	17 °C below ambient up to 100 °C
Temperature Accuracy	
Thermal Shaker:	±1 °C from 20 °C to 45 °C ±2 °C above 45 °C
Cooling Thermal Shaker:	±0.5 °C from 20 °C to 45 °C ±2 °C below 20 °C and above 45 °C
Speed/Accuracy:	300 to 3000 rpm/±2 %
Timer:	1 min to 99 h, 59 min
Orbit:	3 mm
Cooling rate	
above ambient:	2 to 3 °C/min
below ambient:	0.5 to 1.0 °C/min
Heating rate:	5 °C/min
Permissible ambient conditions:	5 to 35 °C
Dimensions (L X W X H):	260 x 248 x 132 mm
Weight:	5.4 kg
Power supply:	230 V, 50/60 Hz



4.659 483



4.659 482

Type	PK	Cat. No.
LHTS Thermal Shaker	1	4.659 483
LCTS Cooling Thermal Shaker	1	4.659 482



IKA

Thermo shaker Matrix Orbital Δ/Orbital Δ +

Powerful thermoshakers available for samples with smallest volumes, e.g. blood samples, pharmaceutical agents, DNA/RNA samples, DNA/RNA samples or Elisa assays. Without cross-contamination and with an optimal mixing result. Thermo shaker Orbital Δ + with heating/cooling function (cooling rate 2.5 K/min).

- Large and clear display with a convenient menu structure allows for intuitive operation
- Two different speed modes for optimal mixing
- Speed adjustment according to insert, attachment and filling volume
- Robust aluminum die cast housing

Specifications

	Orbital Δ // Orbital Δ +
Temperature range:	ambient +5 ... 100 °C // ambient -15 ... 100 °C
Temperature control:	1 ±K
Uniformity:	0.5 °C
Orbit:	1.5 mm
Display:	TFT
Programs:	2
Timer:	1 s ... 6000 min
Capacity:	0.3 kg
Dimensions (W x D x H):	220 x 350 x 150 mm // 220 x 350 x 125 mm
Weight:	9.5 kg // 8.8 kg
Power consumption:	100 W
Power supply:	100 ... 240 V, 50/60 Hz
IP code:	IP 21

Type	Description	Min. speed	Max. speed	max. heating rate	PK	Cat. No.
		rpm	rpm	K/min		
Matrix Orbital Δ F0.5	fix attachment, 24 x 0.5 ml	300	2000	15	1	4.664 742
Matrix Orbital Δ F1.5	fix attachment, 24 x 1.5 ml	300	1500	11	1	4.664 740
Matrix Orbital Δ F2.0	fix attachment, 24 x 2.0 ml	300	1500	13	1	4.664 743
Matrix Orbital Δ FP	fix attachment, 1 x microplate	300	2000	18	1	4.664 741
Matrix Orbital Δ+	variable attachments	300	3000	7	1	4.664 744

Suitable accessories can be found in our online shop.

1



4.664 743

2



4.664 741

3



3 Shaking Incubators VorTemp™ 56/1550

Labnet

VorTemp™ 56 is supplied with interchangeable platforms for microtubes (56 x 1.5ml tubes, or small tubes with adapters) or microplates (accepts standard and deepwell plates, up to 2.0ml). VorTemp™ 1550 includes platforms for 8 x 50ml and 18 x 15ml tubes. The shaker in the VorTemp™ 56 may be turned off, allowing the unit to be used as a static incubator.

- shake and incubate samples simultaneously
- interchangeable platforms
- broad temperature and speed range
- intelligent control with digital LED display

Specifications

	VorTemp™ 56 // VorTemp™ 1550
Temperature range:	5...100 °C
Temperature accuracy:	±1 °C
Speed range:	200 ... 1300 min ⁻¹ // 200 ... 900 min ⁻¹
Motion/orbit:	3 mm, circular
Timer:	1 ... 999 minutes or continuous
Capacity:	56 x 1.5/2.0ml tubes, 4 standard or 2 deep well microplates // 18 x 15ml, 8 x 50ml tubes
Dimensions (W x D x H):	230 x 310 x 230 mm // 260 x 310 x 310 mm
Weight:	11 kg // 12 kg
Power supply:	230 V/50 Hz or 120 V/60 Hz

Type	PK	Cat. No.
VorTemp 56	1	9.945 760
VorTemp 1550	1	9.945 761

1 Eppendorf ThermoMixer C

The Eppendorf ThermoMixer C combines unique mixing performance with excellent temperature control to consistently guarantee complete, dependable and reproducible test results. Improve your assay results by mixing and incubating samples at the same time.

Eppendorf AG

- Excellent mixing performance due to unique 2DMix-Control technology
- Prevent condensation and improve temperature homogeneity with the new ThermoTop
- Ergonomic design
- Eppendorf QuickRelease™ Technology for fast and simple block exchange of Eppendorf SmartBlocks™
- Highest flexibility thanks to broad choice of exchangeable SmartBlocks™
- Heating, mixing and cooling of all common tubes and microplates with a volume range of 5µl to 50ml

Now you can control the temperature of your samples with ease: The ThermoTop, with unique condensation protection technology, reliably prevents condensation formation on the tube lid and wall. It also improves temperature homogeneity. The Eppendorf ThermoTop does not have a cable connection. It is detected by the device as soon as it is positioned, via inductive signal transmission, and thermo-regulation starts automatically. The sample temperature is not affected: optimal sample protection with optimal reaction conditions produce optimal results.



Specifications

Temperature operation range:	min: 15°C below RT, max: +100°C
Temperature adjustable range:	+1 to +100°C
Accuracy/Resolution:	±0.5°C at +20 to +45 °C
Max. heating time:	6°C/min
Max. cooling time:	2.5°C/min between +100°C and RT
Shaking frequency:	300 to 3000rpm
Orbit:	3mm
Dimensions (W x D x H):	206 x 304 x 131mm
Capacity:	dependent on Eppendorf SmartBlock™
Weight:	6.2kg
Electrical heating power:	200W (max.)
Power supply:	220 - 240V ±10%, 50/60Hz

Type	PK	Cat. No.
ThermoMixer™ C	1	9.776 902

2 Eppendorf ThermoMixer™ F0.5/F1.5/F2.0/FP

To simplify lab routines. Whether work with regularly 0.5, 1.5 or 2.0 ml reaction vessels or plates (MTP and DWP) - the customized systems from Eppendorf offer the perfect solution for special applications. The devices combine precise heating and mixing with the highest stability, even at maximum mixing frequency. Mixing and incubation steps can be performed independently.

Eppendorf AG

- For 24 reaction vessels or one microplate/deepwell plate
- Efficient mixing thanks to 2DMix-Control and anti-spill technology
- Simple and intuitive operation using predefined temperature keys (37 °C, 42 °C, 56 °C and 95 °C)
- Improved temperature homogeneity with the new ThermoTop

Specifications

Temperature operation range:	Min. 4 °C above RT, max. 100 °C
Temperature adjustable range:	1 °C/100 °C
Accuracy/Resolution:	±0.5°C at 20 ... 45 °C
Max. heating time:	18 °C/min//15 °C/min //11 °C/min//13 °C/min
Shaking frequency ThermoMixer™ F1.5/F2.0:	300 to 1500 rpm
Shaking frequency ThermoMixer™ FP/F0.5:	300 to 2000 rpm
Orbit:	3 mm
Weight:	6.1 kg//6.2 kg//6.3 kg//6.3 kg
Electrical heating power:	200 W
Power supply:	220-240 V, 50/60 Hz



Type	Dimensions (W x D x H) mm	PK	Cat. No.
ThermoMixer™ FP	206 x 304 x 164	1	9.776 905
ThermoMixer™ F0.5	206 x 304 x 163	1	9.776 936
ThermoMixer™ F1.5	206 x 304 x 170	1	9.776 904
ThermoMixer™ F2.0	206 x 304 x 170	1	9.776 937

1 Exchangeable blocks Eppendorf SmartBlocks™ and accessories for Eppendorf ThermoMixer™ C and ThermoStat C

Exchangeable blocks:

Flexibility has never been this easy. Eppendorf offers a variety of SmartBlocks™ for tubes from 0.5ml to 50ml.

- Fast and simple block exchange due to Eppendorf Quick Release
- Optimized block design guarantees maximum temperature transfer to the sample

Transfer Racks:

- Autoclavable transport aid for tubes from 0.5 to 2.0 ml
- For transferring up to 24 tubes in/from the heating block at the same time
- Offers protection against burns when transferring hot samples

SmartExtender:

A heatable frame/attachment for mixer, with separate temperature control (3 °C above RT to 110 °C), for simultaneous operation at two different temperatures.

- Enables 2 incubations at the same time

Eppendorf AG

Type	Description	PK	Cat. No.
Eppendorf SmartBlock™ 0.5 mL	24 tubes, 0.5ml	1	9.776 906
Eppendorf SmartBlock™ 1.5 mL	24 tubes, 1.5ml	1	9.776 907
Eppendorf SmartBlock™ 2.0 mL	24 tubes, 2.0ml	1	9.776 908
Eppendorf SmartBlock™ 5.0 mL	8 Eppendorf Tubes®, 5.0ml	1	9.776 909
Eppendorf SmartBlock™ 15 mL	8 conical tubes, 15ml	1	9.776 910
Eppendorf SmartBlock™ 50 mL	4 conical tubes, 50ml	1	9.776 911
Eppendorf SmartBlock™ 12 mm	24 tubes, diam. 11 to 11.9mm	1	9.776 912
Eppendorf SmartBlock™ cryo	24 cryogenic tubes, 1.5 to 2.0ml, all bottom forms	1	9.776 913
Eppendorf SmartBlock™ plates	For micro plates and Deepwell plates, incl. lid	1	9.776 914
Eppendorf SmartBlock™ PCR 96	PCR plates 96, incl. lid	1	9.776 915
Eppendorf SmartBlock™ PCR 384	PCR plates 384, incl. lid	1	9.776 916
Eppendorf SmartExtender™	12 tubes 1.5 - 2.0 ml	1	4.664 579
Transfer Rack	For 24 tubes, 0.5ml	1	6.280 936
Transfer Rack	For 24 tubes, 1.5 to 2.0ml	1	6.280 935

2 Accessories for Eppendorf Thermomixer™

Eppendorf ThermoTop® with condens.protect® technology avoids condensation and improves temperature uniformity.

Lid for Eppendorf Thermomixer™ F1.5 and FP, for Eppendorf Smart Blocks™ 0.5-2.0 mL, plates, PCR 96 and PCR 384

Eppendorf AG

Type	PK	Cat. No.
Eppendorf ThermoTop®	1	9.776 918
Lid	1	9.776 917



4. Stirring, Shaking, Mixing Shakers and mixers/Overhead shakers

1 Overhead mixer LLG-uniROTATOR 2

Analogue overhead mixer with vertical rotary motion for gentle but effective mixing. Ideal for biological samples. Suitable for cutting and mixing processes of powdered and liquid samples in tubes up to 50 ml. With easily interchangeable clamps that allow a quick cleaning of the mixer.

- Compact design
- Housing easy to clean
- Non-slip, adjustable screw feet

Scope of delivery: Overhead mixer incl. 12 clamps each for 2 ml, 15 ml and 50 ml tubes

Specifications

Type of movement:	overhead
Speed:	0 ... 80 min ⁻¹
Rotation angle:	360°
Permissible shaking weight (incl. attachment):	2 kg
Permissible relative moisture:	80 %
Permissible ambient temperature:	5 ... 40 °C
Motor rating input:	20 W
Dimensions (W x D x H):	530 x 150 x 190 mm
Power supply:	100 ... 240 V, 50/60 Hz
IP code:	IP 21
Warranty:	3 years



Type	Plug type	PK	Cat. No.
LLG-uniROTATOR 2	EU	1	6.263 660
LLG-uniROTATOR 2	UK	1	6.263 661

2 Vertical mini rotator PTR-25

Compact, economy solution with simple to use controls, providing thorough mixing of samples in tubes up to 50ml. Suitable for preventing blood coagulation in tubes and for fulfilment of procedures of extraction of biological components. For use in cold rooms and incubators.

- 360° vertical rotation
- Vertical rotation speed range: 5rpm to 30 rpm
- Timer: 1 min to 24 hours, with audible alarm and automatic switch-off
- Simple to use controls
- Platform accommodating 22 tubes (up to 16mm diameter) is included as standard

Grant



Type	Plug type	PK	Cat. No.
PTR-25	EU/UK	1	9.721 016

3 Vertical mini rotator RotoFlex™ Plus

This simple benchtop rotator is ideal for a number of laboratory applications including DNA purification, hybridization or sample mixing. It is digitally controlled and can also be set in an oscillating mode to increase mixing efficiency. This tube rotator accepts tubes from 0.5 to 50 ml. The rotisseries to hold each of the tubes are included in the set.

Argos Technologies

Features:

- 360° revolution, adjustable angle from 0 to 90°
- Speed: 10 to 40 rpm, adjustable
- For tubes of 0.5 to 50 ml, interchangeable tube racks
- Can be used in a cold room or incubator (4 °C to 60 °C)

Type	PK	Cat. No.
RotoFlex™ Plus	1	6.281 561



1



1 Multi-function rotator PTR-35/PTR-60

360° vertical multi-function rotator for thorough mixing in tubes, with multi-segment programme.

Grant

- Multi-function: vertical rotation, reciprocation, vibration
- Continuous or timed operation for each phase
- Choice of two models with different microtube capacities
- Speed: 1 rpm to 100 rpm with 1 rpm increment
- Reciprocal rotation: 1° to 90° turning angle
- Vibration: programmable in a burst of 1 to 5 seconds
- Fully programmable sequence of functions, including pause
- Alternative platforms for larger tubes

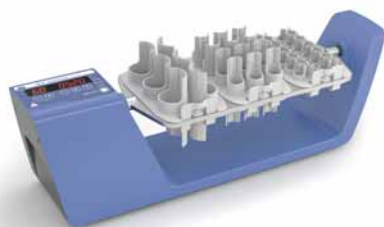
Type	Permissible shaking quantity / maximum load kg	Plug type	PK	Cat. No.
PTR-35	0.5	EU/UK	1	9.721 028
PTR-60	0.8	EU/UK	1	9.721 030

2

9.837 871

Overhead shaker Trayster basic/digital

Overhead shaker with vertical rotation for smooth but effective mixing with a fixed speed. Ideal for biological samples, particularly blood samples. Suitable for separating and mixing processes of powdered and liquid samples in Eppendorf tubes and Greiner tubes up to 50 ml. The easy removable attachments allow simple and quick cleaning of the unit of spilled samples.

IKA

- Different attachments allow a variety of applications
- Usable at 4 to 50°C in incubators
- Suitable for continuous operation
- Easy operation by foil keypad
- Trayster digital only:**
- Timer: Countdown, adjustable from 1s to 99h 59min
- Counter: Display of shaking time
- Error code display

Attachments are not included. Please order separately.

Specifications

Type of movement:	overhead
Shaking diameter:	vertical or horizontal
Permissible shaking weight (incl. attachment):	2kg
Motor rating input/output:	16/9 W
Dimensions (W x D x H):	460 x 140 x 180 mm
Protection class acc. to DIN EN 60529:	IP 21
Power supply:	100-240V, 50/60Hz

Type	PK	Cat. No.
Trayster basic, EU	1	9.837 870
Trayster digital, EU	1	9.837 871

3

3 Overhead Shaker Reax 2

- Incl. Universal adapter with clamps for 2 closed vessels of 50 to 160 mm height
- Especially suitable for hematology, medical diagnostics and biochemistry
- Speed continuously adjustable
- Additionally an optional adaptor is available for the use of 20 test tubes

Heidolph

Specifications

Type of movement:	overhead
Speed:	20 ... 100 rpm
Rotation angle:	360°
Permissible shaking weight:	1 kg
Motor rating input:	27 W
Dimensions (W x D x H):	510 x 235 x 180 mm
Weight:	5.2 kg
Power supply:	230 V/50 Hz
Protection class:	IP 21

Type	Plug type	PK	Cat. No.
Reax 2	EU	1	6.270 264
Reax 2	UK	1	6.290 978

4. Stirring, Shaking, Mixing Shakers and mixers/Overhead shakers

Overhead shaker Reax 20

- Overhead Shaker for 4, 8 or 12 bottles or mixing cylinders with 160 to 270 mm height and max. 136 mm diameter
- Ideal for waste water analysis acc. to DIN 38414 Part 4
- Bottles can be easily inserted and removed by quick-release technology
- Set and continuously adjust the variable speed on the analog control knob
- Other rotation speeds available upon request, for example 0.5 to 8 rpm or 2 to 32 rpm

Heidolph



9.839 805

Specifications

Type of movement:	overhead
Speed:	1 ... 16 rpm
Rotation angle:	360°
Permissible shaking weight:	30 kg
Motor rating input:	280 W
Power supply:	230 V/50 Hz
Protection class:	IP 21

Type	Dimensions (W x D x H) mm	Net weight kg	PK	Cat. No.
Reax 20 / 4	490 x 520 x 465	23	1	9.839 805
Reax 20 / 8	770 x 520 x 465	28	1	9.839 806
Reax 20 / 12	1050 x 520 x 465	33	1	9.839 807

2 Disc rotator LLG-uniLOOPMIX 2

- Analogue Disc rotator for gentle and effective sample mixing. Suitable for all biological samples. With easily interchangeable clamps that allow a **quick cleaning** of the rotator.
- For a maximum of 48 x 1.5 ml, 16 x 5 or 15 ml, 8 x 50 ml tubes. Also for parallel use of different sizes, can be equipped individually.
- Compact design
 - Housing easy to clean
 - Non-slip, adjustable screw feet
 - Additional clamps on request

Scope of delivery: Disc rotator incl. 12 clamps each for 2 ml, 15 ml and 50 ml tubes

Specifications

Type of movement:	rotating
Speed:	0 ... 80 min ⁻¹
Rotation angle:	360°
Permissible shaking weight (incl. attachment):	2 kg
Permissible relative moisture:	80 %
Permissible ambient temperature:	5 ... 40 °C
Motor rating input/output:	20 W
Dimensions (W x D x H):	220 x 300 x 310 mm
Power supply:	100 ... 240 V, 50/60 Hz
IP code:	IP 21
Warranty:	3 years

Type	Plug type	PK	Cat. No.
LLG-uniLOOPMIX 2	EU	1	6.263 665
LLG-uniLOOPMIX 2	UK	1	6.263 666



Rotators SB2/SB3

The Stuart rotators give gentle but effective mixing, ideal for life sciences applications such as keeping blood samples in suspension. The angle of tilt is fully adjustable. The Rotators can be used in incubators up to 60°C and in cold rooms down to 4°C.

Stuart

SB2: Fixed speed of 20rpm.

SB3: Variable speed of 2rpm to 40rpm. Additional digital timer of 1 to 999 minutes. Digital speed control.

There are six types of tube holder available. Please order separately.

Specifications:

Dimensions (W x D x H):	200 x 270 x 230mm
Supply:	230 V/50 Hz, 50W
Weight:	3.2kg

Type	PK	Cat. No.
SB2	1	9.645 322
SB3	1	9.645 323



9.645 323

1 Tube holders for rotators SB2/SB3

Stuart

Type	For	No. of vessels	PK	Cat. No.
SB3/1	Micro tubes, 10 to 11.5mm dia.	46	1	9.645 324
SB3/2	Test/blood tubes, 9 to 20mm dia.	20	1	9.645 325
SB3/3	50ml centrifuge tubes, 25 to 35mm dia.	12	1	9.645 326
SB3/4	Culture tubes, 12mm dia.	63	1	9.645 327
SB3/5	Culture tubes, 16mm dia.	63	1	9.645 328
SB3/6	Culture tubes, 26mm dia.	30	1	9.645 329
SB3/1/PC	Spare Clips for SB3/1	-	1	6.258 527

Additional accessories on request.

Rotators Loopster basic/digital

Rotators for smooth but effective mixing with a fixed speed. Ideal for biological samples, particularly blood samples. Suitable for separating and mixing processes of powdered and liquid samples in Eppendorf tubes and Greiner tubes up to 50ml. The easy removable attachments allow simple and quick cleaning of the unit of spilled samples.

IKA

- Freely adjustable rotary angle
- Different attachments allow a variety of applications
- Usable at 4 to 50°C in incubators
- Easy operation by foil keypad
- Suitable for continuous operation

Loopster digital only:

- Timer: Countdown, adjustable from 1s to 99h 59min
- Counter: Display of shaking time
- Error code display

Specifications

Type of movement:

rotating

Shaking diameter:

adjustable from horizontal to vertical

Permissible shaking weight (incl. attachment):

2kg

Motor rating input/output:

16/9W

Dimensions (W x D x H):

300 x 300 x 360mm

Protection class acc. to DIN EN 60529:

IP 21

Power supply:

100-240V, 50/60Hz

Type	Min. speed rpm	Max. speed rpm	PK	Cat. No.
Loopster basic	20	20	1	9.729 982
Loopster digital	5	80	1	9.729 983

1

2

9.729 983

Roller Mixers LLG-uniROLLER 6 easy and pro



1

Analog or digital tube rollers with 6 rolls for the efficient mixing of biological samples, viscous substances and liquid-solid suspensions. Used in a variety of applications, such as the prevention of blood coagulation, immune precipitation.

- Max speed 70 rpm
- For gentle rolling of samples
- Easy to clean

LLG-uniROLLER 6 easy:

- Analog control
- Easy to use

LLG-uniROLLER 6 pro:

- LCD display
- Continuous or timer operation



6.263 645

2



6.263 647

Specifications

Type of movement:	rocking and rolling
Amplitude:	24 mm
Speed:	0 ... 70 rpm
Timer:	- // 1 ... 1199 min
Load max.:	4 kg
Ambient temperature:	5 ... 40 °C
Max. humidity:	80 % RH
Dimensions (W x D x H):	260 x 450 x 120 mm
Weight:	4.5 kg // 5.1 kg
Power consumption:	25 W // 30 W
Power supply:	100 ... 240 V, 50/60 Hz
IP code:	IP 21

LLG-uniROLLER 6 easy // LLG-uniROLLER 6 pro

Type	Plug type	PK	Cat. No.
LLG-uniROLLER 6 easy	EU	1	6.263 645
LLG-uniROLLER 6 easy	UK	1	6.263 646
LLG-uniROLLER 6 pro	EU	1	6.263 647
LLG-uniROLLER 6 pro	UK	1	6.263 648

Tube Roller Mixer, SRT6, SRT6D, SRT9, SRT9D

3 Stuart

There are four models available, two analogue models with either 6 or 9 rollers, with a fixed speed of 33 rpm. Or two more advanced digital models with either 6 or 9 rollers, with digitally controlled speed between 5 and 60 rpm and programmable timer. The rollers conveniently detach to accommodate larger vessels. Recommended for mixing blood samples, viscous substances and liquid-solid suspensions where minimum aeration is required. Units can be used in incubators up to 60 °C and humidity up to 80 %, or in cold rooms down to 4 °C.

- Rocking and rolling action for complete mixing
- 6 or 9 roller design with footprint
- With antimicrobial BioCote protection

Specifications

Type of movement:	rocking and rolling
Amplitude:	16 mm
Speed:	33 rpm // 5 ... 60 rpm
Number of rollers:	6 // 9
Load max.:	3 kg
Timer:	continuous // 1 s ... 9 h, continuous
Ambient temperature:	up to 60 °C
Max. humidity:	up to 80 %
Dimensions (W x D x H):	565 x 240 x 110 mm // 565 x 360 x 110 mm
Roller size (l x Ø):	340 x 30 mm
Weight:	5.1 kg // 6.9 kg
Power supply:	230 V, 50/60 Hz
IP code:	IP 20

SRT6/SRT6D // SRT9/SRT9D



9.728 811

Type	Display type	PK	Cat. No.
SRT6	analogue	1	9.728 810
SRT6D	digital	1	9.728 811
SRT9	analogue	1	9.728 812
SRT9D	digital	1	9.728 813

1

9.729 970

Tube roller Roller 6 basic/6 digital/10 basic/10 digital

Roller shaker with 6 or 10 rolls, with smooth rocking and rolling action and a fixed speed. Particularly for mixing blood samples, solid and liquid suspensions and viscous samples. The unit can be used for all conventional tubes and cylindrical bottles. The easy removable rolls allow simple and quick cleaning of the unit from spilled samples.

IKA

- Usable from 4 to 50°C in incubators
- Suitable for continuous operation
- Removable rolls make it suitable for larger tubes
- Easy operation by foil keypad
- Easy removable rolls

Roller 6 digital/10 digital only:

- Timer: Countdown, adjustable from 1s to 99h 59min
- Counter: Display of shaking time
- Error code display

2

9.729 973

Specifications

Type of movement:	rocking and rolling
Amplitude:	24.5 (height)
Speed:	30 rpm // 5 ... 80 rpm
Number of rollers:	6 // 10
Load max.:	2 kg
Timer:	- // 1 s ... 99 h 59 min
Ambient temperature:	+4°C to +50°C
Max. humidity:	80%
Dimensions (W x D x H):	240 x 545 x 115 mm // 380 x 545 x 115 mm
Roller size (l x Ø):	310 x 32 mm
Weight:	4 kg // 6 kg
Power supply:	100-240V, 50/60Hz
IP code:	IP 21

Roller 6 /10 basic // Roller 6 /10 digital

Type	PK	Cat. No.
Roller 6 basic	1	9.729 970
Roller 6 digital	1	9.729 971
Roller 10 basic	1	9.729 972
Roller 10 digital	1	9.729 973

3

3 Tube roller RM 2

Robust tube roller with gentle tilting and rolling movement. Small space requirement. Suitable for all common tube sizes, bottles and other cylindrical vessels with a diameter of up to 80 mm.

Bühler

- Gentle start-up for optimum development of cell cultures.
- Minimal heat emission, thus no influence on the ambient conditions
- Can be used at CO₂ concentrations up to 5%.
- Easy setting of speed and time via LED display
- Drip tray and plastic rollers can be removed for easy cleaning
- Overhead attachment available as accessory

Scope of delivery: basic unit including 6 removable plastic rollers and drip tray

Specifications

Type of movement:	rocking and rolling
Amplitude/angle:	15 mm, 3° fixed
Speed:	5 ... 80 rpm
Max. load:	2 kg
Number of rollers:	6
Timer:	0 ... 99 h 59 min/continuous
Temperature range:	5 ... 45 °C
Max. CO ₂ range:	5 %
Max. humidity:	85 %, not condensing
Dimensions (W x D x H):	244 x 465 x 115 mm
Roller size (l x Ø):	300 x 32 mm
Weight:	7.3 kg
Power supply:	100 ... 240 V, 50/60 Hz
Protection class:	IP 21

Type	PK	Cat. No.
RM 2	1	4.663 359

4. Stirring, Shaking, Mixing

Shakers and mixers/Roller mixers-Microtitre plate shakers

1 Overhead attachment RM 2, PVC

For tube rollers RM 2. With 12 holes at 29.5 mm Ø. Other borings available on request. Bühler

Type	PK	Cat. No.
Overhead rack RM 2	1	4.663 360



2 3 Microtitre shaker LLG-uniPLATESHAKER 1

The LLG-uniPLATESHAKER 1 has been designed for accommodating and mixing a single micro plate. Due to its **small footprint** it can be used in working areas with limited space such as fume hoods and bio safety cabinets. It can also be used inside a cold-room.

- Digital display with speed and time settings
- **Variable speed** from 300 to 1800 min⁻¹
- Maintenance-free brushless DC motor
- Orbital Diameter of 2 mm for thorough mixing
- Timer setting from 1 to 99 min and continuous mode
- **Universal fit**; comes with interchangeable clamps for different micro plate sizes
- Comes with foam attachment for 20 x 1.5/2 ml microtubes

Scope of supply: shaker, mains adapter, 2 attachments (foam attachment and attachment for microtitre plates), 6 clamps

Specifications

Type of movement:	orbital
Orbital diameter:	2 mm
Speed range:	300 ... 1800 min ⁻¹
Max. load:	1 kg
Motor:	brushless DC motor
Timer:	1 ... 99 min, continuous
Power consumption:	15 W
Permissible ambient temperature:	4 ... 40 °C
Dimensions (W x D x H):	127 x 85 x 86 mm
Weight:	1.4 kg
Power supply:	100 ... 230 V, 50/60 Hz
Warranty:	3 years

Type	Plug type	PK	Cat. No.
LLG-uniPLATESHAKER 1	EU	1	6.263 488
LLG-uniPLATESHAKER 1	UK	1	6.263 489



4 Microtitre shaker PMS-1000i

Reliable, regulated shaking for two or four microplates. Simple screw attachments allow quick and easy fitting of any standard depth 96 or 384 well plates, holding the plate securely in place. Grant

- direct drive
- brushless motor
- RPM set and display
- variable speed: 150rpm to 1200rpm
- orbit: 2mm
- continuous or timed operation
- integral timer: 1 min to 24 hours
- standard option for two microplates
- optional platform MPP-4 for four microplates
- ambient 4°C to 40°C

Type	PK	Cat. No.
PMS-1000i	1	9.721 074



Accessories for Microtitre shaker PMS-1000i

Description	PK	Cat. No.
Platform for 4 micro plates	1	9.721 026

Grant

Microtitre Plate Shakers Titramax 100/101/1000

- Set and continuously adjust the variable speed on the analog control knob for gentle to powerful mixing
- An analog process timer allows for unattended operation.

Heidolph

Specifications

Type of movement:	orbital, vibrating
Speed range:	150 ... 1350 rpm
Timer:	120 min, continuous
Power consumption:	31 W
Permissible ambient temperature:	5 ... 31 °C
Permissible relative moisture:	80 %
Weight:	5.5 kg
Power supply:	100 ... 240 V, 50/60 Hz
Protection class:	IP 30

1



9.839 831

Microtitre Plate Shakers Titramax 100/101

Compact and space-saving models for 4 microtiter plates. Titramax 100 with 1.5 mm shaking orbit is ideal for gentle mixing. Titramax 101 with a 3 mm shaking orbit is especially suitable for mixing of viscous media and solids.

Heidolph

Specifications

Max. Load:	2 kg
Platform dimensions (W x D):	220 x 220 mm
Overall dimensions (W x D x H):	245 x 310 x 125 mm

Type	Shaking stroke / Shaking orbit mm	PK	Cat. No.
Titramax 100	1.5	1	9.839 831
Titramax 101	3.0	1	9.839 832

2



Microtitre Plate Shakers Titramax 1000

Compact model for 6 microtiter plates for gentle mixing. The Titramax 1000 is suitable for the modular Incubator 1000 and is recommended for applications which require variable temperatures.

Heidolph

Specifications

Orbit:	1.5 mm
Max. Load:	5 kg
Platform dimensions (W x D):	290 x 258 mm
Overall dimensions (W x D x H):	320 x 375 x 125 mm

Type	PK	Cat. No.
Titramax 1000	1	9.839 830

3



9.721 033

Microplate thermoshaker PHMP/PHMP-100/PHMP-4

For 96- and 384-well plates. The PHMP is a variable speed, variable temperature microplate shaker incubator with excellent temperature uniformity across the microplate. The patented heated lid and base which completely cover the plate produce a controlled micro-environment. This is combined with powerful orbital shaking to produce the maximum yield from your incubations.

Grant

- Stability ± 0.1 °C, uniformity ± 0.25 °C, rapid heat-up
- For standard 96 or 384-well plates (max. 14mm height)
- Variable speed: 250 rpm to 1200 rpm
- 2mm shaking orbit for effective mixing
- Temperature setting range: +25 to 60°C, PHMP-100: +25 to 100°C
- Temperature control range: RT +5 to 60°C, PHMP-100: RT +5 to 100°C
- Timed operation: 1 min to 96 hours

4



6.227 761

Type	Min. operating temperature RT + °C	Max. operating temperature °C	For	PK	Cat. No.
PHMP	5	60	2 microplates	1	9.721 033
PHMP-4	5	60	4 microplates	1	6.227 761
PHMP-100	5	100	2 microplates	1	6.280 073

Sampling	542
Samplers, gas	542
Samplers, Solids.....	543
Samplers, Liquids	553
Sample containers	559
Sample transport, storage	562
Grinding	565
Mortars	565
Blenders.....	566
Mills.....	568
Jaw breaker	590
Sieving	591
Sieve shakers	591
Test sieves.....	594
Sample dividers.....	598
Laboratory presses	599
Presses	599
Mixing, Homogenisation	599
Dispersers	599
Ultrasonic homogenisers.....	610
Homogenisers	614



1 Sampling bags, FEP

Made from 5 mil (125 µm) FEP fluoropolymer film, these flexible, sturdy bags are heat sealed on all four sides for complete chemical resistance and leak-proof operation.

Saint Gobain

They are inert to most chemicals and have low permeability which limits sample loss. Available with either a nickel-plated, brass on/off valve that accepts 6.4 mm I.D. flexible tubing or with PTFE/silicone septum in polypropylene housing for use with a hypodermic needle. These FEP bags are easy to use. They can be stored for an unlimited period prior to use. Applications include gas sample analysis, extracting air samples from smokestack exhaust systems, monitoring air quality or calibrating instruments in the field. The bags are individually packaged.

- Chemically resistant
- Flexible
- Will not contaminate sample

Capacity L	Size mm	Connection	PK	Cat. No.
1.2	150 x 250	on/off	1	6.267 484
0.5	150 x 150	on/off	1	6.267 485
4.7	300 x 300	on/off	1	6.267 486
50.0	600 x 900	on/off	1	6.267 487
0.5	150 x 150	Septum	1	6.267 488
1.2	150 x 250	Septum	1	6.267 489
4.7	300 x 300	Septum	1	6.267 490
50.0	600 x 900	Septum	1	6.267 491



2 Sampling bags, PVDF

Reusable bags made of 2 mil (50 µm) PVDF fluoropolymer film, Chemware® Gas Bags offer an economical alternative for analysis of noncorrosive gases. Durable, heat-sealed seams ensure leak-proof operation.

Saint Gobain

Available with either a nickel-plated, brass on/off valve that accepts 6.4 mm I.D. flexible tubing or with a PTFE/silicone septum in a polypropylene housing for use with a hypodermic needle.

Applications include sampling carbon monoxide, sulfur dioxide, hydrogen sulfide, radon and mercaptan.

The bags are individually packaged. When used for liquid samples, bags should be supported with a tray.

Custom sizes and configurations available on request.

- Flexible
- Will not contaminate sample
- Choice of fitting style: on/off or septum
- For use in gas sampling trains
- Use for gas or liquid sample containment

Capacity L	Size mm	Connection	PK	Cat. No.
0.3	150 x 150	on/off	1	6.267 492
1.6	230 x 230	on/off	1	6.267 493
3.8	300 x 300	on/off	1	6.267 494
8.1	380 x 380	on/off	1	6.267 495
20.3	460 x 460	on/off	1	6.267 496
37.7	600 x 600	on/off	1	6.267 497
0.3	150 x 150	septum	1	6.267 498
3.8	300 x 300	septum	1	6.267 499
1.6	230 x 230	septum	1	6.267 600
8.1	380 x 380	septum	1	6.267 601
20.3	460 x 460	septum	1	6.267 602
37.7	600 x 600	septum	1	6.267 603

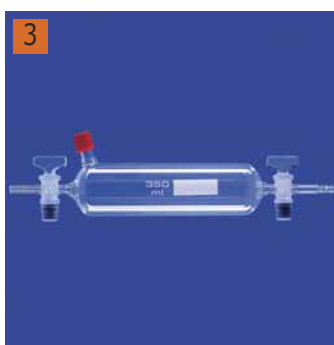

9.110 236

Gas sampling tubes, DURAN® tubing

Made of DURAN® tubing. Available with or without nozzle (with thread GL and septa), with two one-way stopcocks NS14 (with retaining device), connections: capillary tube (outer dia. 8 mm, inner dia. 2.7 mm), glass olive (outer dia. 8 mm), with inscription label. Also available with PUR coating.

Lenz

Type	Capacity ml	External body diam. mm	Length* mm	PK	Cat. No.
Without sampling connections	150	42	155	1	9.110 215
Without sampling connections	350	54	200	1	9.110 220
Without sampling connections	500	65	220	1	9.110 225
Without sampling connections	1000	85	260	1	9.110 230
With sampling connections, GL 14	150	42	155	1	6.243 069
With sampling connections, GL 14	350	54	200	1	9.110 236
With sampling connections, GL 14	500	65	220	1	9.110 237
With sampling connections, GL 14	1000	85	260	1	7.623 930

* Body length (mm)

1 Core Sampler Quick Picker, Stainless steel V4A or PP



Suitable for removing bulk materials from sacks or large bags and depositing them directly into sample bottles. Simple to use and clean. Crevice-free to prevent sample residues causing cross-contamination which could affect subsequent sample results. Complete with cleaning brush and two 250 ml sample bottles.

Lock seal close-it and close-it food & pharma please order separately.

Capacity	Length	Imm. depth	Material	PK	Cat. No.
ml	cm	mm			
75	50	300	PP clear	1	6.205 458
75	50	300	V4A	1	9.303 850

Bürkle



2 LLG Sample bottles for QuickPicker Sampler

Type A: round, natural colored, with screw cap

Type B: easy to fill and clean, transparent, compact form, unbreakable

Type	Capacity	Material	PK	Cat. No.
	ml			
A	250	LDPE	10	9.073 512
B	250	LDPE	1	9.303 854
B	250	PP	1	9.001 062



3 4 Sampler Silo Drill, aluminium or stainless steel V2A



If bulk goods are transported over long distances (e.g. in trucks, railway goods wagons), separation may occur. Taking the sample just from the surface therefore leads to the wrong result. Representative samples from all layers of the silo can be taken with the SiloDrill. The SiloDrill fits through all standard openings with its diameter of 90 mm.

- Of stainless steel AISI 304 (1.4301) or aluminium
- Standard length 150 cm, extendable in increments of 100 cm, max. 350 cm
- Scraper edge for cohesive substances
- Drill tip with drilling blades for easy boring

Type	Length	PK	Cat. No.
	cm		
Silo drill, aluminium	150	1	9.303 858
Silo drill, V2A	150	1	9.303 868
Extension rods, V2A	100	1	9.303 859

Bürkle



➔ For wide neck bottles with screw cap see page 70.

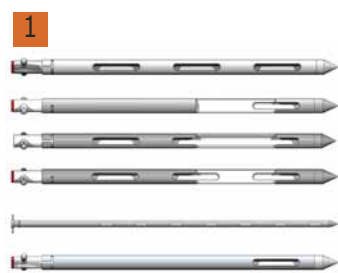

1 2 Zone samplers, Multi/All-layer/Jumbo/Uno, steel V4A or aluminium

Bürkle



For sampling bulk goods of all types. Available in various different lengths and materials:

Multi-sampler: With several closed chambers for multi-point sampling from several predetermined sampling depths. Available in stainless steel V4A/PTFE, stainless steel V4A/V4A or aluminium. Tube diameter: 25 mm.

All-layer-sampler: with open inner tubes for cross-sectional sampling through all layers of the sample. Emptied via the open tube end of the sampler. Available in stainless steel V4A or aluminium. Tube diameter: 25 mm.

Jumbo-sampler: generally as the All-layer-sampler with open tube end. With a tube diameter of 50 mm, ideal for coarse grains and larger quantities. For multi point sampling the chambers can be separated by PTFE separators.

Uno-sampler: With a closed chamber, for target samples from a pre-determined sample depth.

Easy emptying with the emptying device.

Lock seal close-it and close-it food & pharma please order separately.



Type	Chamber Capacity ml	Length cm	Imm. depth mm	Number openings	Material	PK	Cat. No.
Multi-Sampler	14	55	430	3	Stainless steel (V4A)/PTFE	1	9.303 860
Multi-Sampler	17	85	710	3	Stainless steel (V4A)/PTFE	1	9.303 862
Multi-Sampler	17	150	1355	5	Stainless steel (V4A)/PTFE	1	9.303 864
Multi-Sampler	14	55	430	3	V4A/V4A	1	7.631 201
Multi-Sampler	17	85	710	3	V4A/V4A	1	7.653 124
Multi-Sampler	17	150	1355	5	V4A/V4A	1	9.303 866
Multi-Sampler	14	55	430	3	Aluminium	1	9.303 870
Multi-Sampler	17	85	710	3	Aluminium	1	9.303 872
Multi-Sampler	17	150	1355	5	Aluminium	1	9.303 874
Cross-section sampler	70	55	430	3	Aluminium	1	9.303 875
Cross-section sampler	130	85	710	3	Aluminium	1	9.303 876
Cross-section sampler	260	150	1355	5	V4A/V4A	1	9.303 865
Cross-section sampler	260	150	1355	5	Aluminium	1	9.303 877
Cross-section sampler	70	55	430	3	V4A/V4A	1	6.232 190
Cross-section sampler	130	85	710	3	V4A/V4A	1	6.234 598
Jumbo sampler	880	85	710	3	Aluminium	1	9.303 878
Jumbo sampler	1700	150	1355	5	Aluminium	1	9.303 879
Jumbo sampler	2900	250	2355	7	Aluminium	1	9.303 883
Jumbo sampler	390	85	710	3	Aluminium/PTFE	1	6.240 956
Jumbo sampler	650	150	1355	5	Aluminium/PTFE	1	7.625 884
Jumbo sampler	910	250	2355	7	Aluminium/PTFE	1	6.236 850
Uno-Sampler	17	55	430	1	Stainless steel (V4A)/PTFE	1	9.303 886
Uno-Sampler	17	85	710	1	Stainless steel (V4A)/PTFE	1	9.303 887
Uno-Sampler	17	150	1355	1	Stainless steel (V4A)/PTFE	1	9.303 888



3 Emptying device, stainless steel

Bürkle



Emptying zone samplers were often a matter of patience and a steady hand.

Now it's easier and faster with Bürkle's emptying device. Just lay the zone sampler onto the stainless steel stand, adjust the funnels along the sample chambers, and, after turning the sampler, the media will directly flow into the containers below. Quality materials ensure that the emptying device is autoclavable.

Description	PK	Cat. No.
Emptying device	1	6.236 050



4 Zone sampler, accessory cleaning brush, PVC/stainless steel

For thoroughly cleaning of Zone samplers.

Bürkle

Diam. mm	Length cm	PK	Cat. No.
25	40	1	6.223 345
25	60	1	9.303 880
25	80	1	9.303 882
25	100	1	9.303 884
50	100	1	9.303 885
50	300	1	6.284 633

1 Sampler Tubes, V4A stainless steel, according to ISTA



Bürkle



Sampler for free flowing, bulk goods up to approx. 1cm diameter. This makes it possible, for example, to remove hazel nuts, blends of tea, grain or similar items from large sacks.
Operation: Insert Tubes into a sack to the desired sampling depth, while keeping the collection tube closed using your hand. When you take away your hand, the sample flows directly through the open tube into the container or sampling bag beneath it.

- choice of 2 lengths, 40 cm and 80 cm
- also for coarse-grained bulk goods
- AISI 316 stainless steel
- corresponds to ISTA standard for seed lengths of 10 mm and 5 mm

Lock seal close-it and close-it food & pharma please order separately.

Diam. mm	Length cm	PK	Cat. No.
40	40	1	6.200 394
40	80	1	6.204 492

2 Sampling lance milky, stainless steel V4A, acc. to EN ISO 707



Bürkle



Universal powder and granules sampler collector made of AISI 316 stainless steel. Developed especially for milk powder samples, conforms to standards of DIN and IDF (Int. Dairy Federation). The collector is inserted into bags or casks and the sample is removed using a semi-circular profile lance. Autoclavable.

Lock seal close-it and close-it food & pharma please order separately.

Capacity ml	Length cm	Imm. depth mm	Ext. diam. mm	PK	Cat. No.
150	48	385	28	1	6.051 629

3 Sampler ice borer, stainless steel



Bürkle



The sampler is suitable for deep-frozen products in the food industry and semi-solid substances. With the robust hollow borer, with sharp sawing crown, a cross-sectional sample of up to 20 cm length can be cut out.

- Stainless steel V4A (1.4404/1.4571)
- Sterilisable
- Food-safe

Scope of supply: Borer, borer head for use in conventional drills and rod for pressing the cylindrical sample out of the borer head

Int. diam. mm	Ext. diam. mm	PK	Cat. No.
8	10 *	1	4.670 758
16	21	1	6.236 498
50	54	1	7.626 965

* Drilling depth 100 mm



6.282 439



6.282 452



6.282 458

Disposable samplers for solids, HDPE

Bürkle



In numerous situations, rapid and contamination-free samples have to be taken. DispoSamplers are perfect for this application. They are cleanroom manufactured, individually packed and always ready to use. Avoid expensive decontamination or cleaning of soiled samplers. Gamma sterilised versions are also available.

MultiDispo: For free-flowing powders and small-grain granulates. Easy emptying through opening in the handle.

ZoneDispo: For free-flowing powders and small-grain granulates. Collected sample can be transported in closed sampler.

TargetDispo: For taking target-point samples from powders and granulates.

PowderDispo: For taking cross-section samples of powdery or slightly cohesive substances.

DispoPicker: For taking cross-section samples from powders and small-grain granulates. With closed tip.

DispoLance: For direct removal and filling of free-flowing powders and small-grain granulates.

MicroDispo: For free-flowing powders and small-grain bulk materials. For small sample quantities (10 ml).

Type	Description	Capacity ml	Length mm	PK	Cat. No.
MultiDispo	sterile	100	500	20	6.282 440
MultiDispo	non-sterile	100	500	20	6.282 439 1
MultiDispo	sterile	200	1000	20	6.282 442
MultiDispo	non-sterile	200	1000	20	6.282 441
ZoneDispo	sterile	100	500	20	6.269 015
ZoneDispo	non-sterile	100	500	20	7.655 427
ZoneDispo	sterile	200	1000	20	6.282 438
ZoneDispo	non-sterile	200	1000	20	6.257 764
TargetDispo	sterile	100	500	20	6.282 444
TargetDispo	non-sterile	100	500	20	6.282 443
TargetDispo	sterile	200	1000	20	6.282 446
TargetDispo	non-sterile	200	1000	20	6.282 445
PowderDispo	sterile	60	300	20	6.282 453
PowderDispo	non-sterile	60	300	20	6.282 452 2
PowderDispo	sterile	100	500	20	6.259 428
PowderDispo	non-sterile	100	500	20	9.303 736
DispoPicker	sterile	60	300	20	6.282 455
DispoPicker	non-sterile	60	300	20	6.282 454
DispoPicker	sterile	100	500	20	6.282 457
DispoPicker	non-sterile	100	500	20	6.282 456
DispoLance	sterile		300	20	6.282 459
DispoLance	non-sterile		300	20	6.282 458 3
DispoLance	sterile		500	20	6.282 461
DispoLance	non-sterile		500	20	6.282 460
MicroDispo	sterile	10	500	20	9.303 729
MicroDispo	non-sterile	10	500	20	9.303 728
MicroDispo	sterile	10	1000	20	9.303 731
MicroDispo	non-sterile	10	1000	20	9.303 730



4 Disposable spatulas LaboPlast®/SteriPlast®, PS

Bürkle



White. Due to their long, ergonomic and solid handles and pointed blades they can be easily pierced into paper and plastic bags. The spatulas are ideal for sampling of powder, granules and pastes. The spatulas are also available with a transparent sheath to close them immediately after the sampling procedure to secure a sterile and contamination-free sample.

- Individually packed
- SteriPlast® additionally gamma-sterilized
- Production, assembling and packaging acc. to Cleanroom class 7 (10000)
- According to EU food and FDA guidelines

Type	Sterile	Length mm	Imm. depth mm	Version	Material	PK	Cat. No.
LaboPlast®	-	263	150	without sheath	PS	10	6.265 035
LaboPlast®	-	268	150	with sheath	PS	10	6.265 036
SteriPlast®	+	263	150	without sheath	PS	10	6.265 047
SteriPlast®	+	268	150	with sheath	PS	10	6.265 048

1 Disposable spatulas LaboPlast® Bio/SteriPlast® Bio, Green PE



Bürkle



White. Due to their long, ergonomic and solid handles and pointed blades they can be easily pierced into paper and plastic bags. The spatulas are ideal for sampling of powder, granules and pastes. The LaboPlast® Bio/SteriPlast® Bio products are entirely made of renewable resources.

Not only with regard to quality but also with regard to its characteristics for high-quality sampling, it is perfectly comparable with conventional polyethylene.

- Individually packed in organic PE foil
- SteriPlast® Bio additionally gamma-sterilized
- Production, assembling and packaging acc. to Cleanroom class 7 (10000)
- According to EU food and FDA guidelines

Type	Sterile	Length mm	Imm. depth mm	Material	PK	Cat. No.
LaboPlast® Bio	-	263	150	Green PE	10	6.265 062
SteriPlast® Bio	+	263	150	Green PE	10	6.265 061

2 Disposable spatulas for foodstuffs SteriPlast®, PS



Bürkle



Blue. As a result of the long, ergonomically-shaped, stable handle and a sharp blade, it is possible to even penetrate directly into containers such as paper or plastic sacks. The spatula for foodstuffs is ideal for sampling powders, granulates and pastes.

The shade of blue that is used does not occur in a natural form in foodstuffs. Because of this, the spatulas or parts of them can be quickly found and easily identified in a visual check if they are ever mixed into production. The detectable spatulas have a special additive in the material that makes them visible to metal detectors or X rays. They can therefore be rejected with standard systems for checking for foreign objects, even though they are made of plastic.

- Individually packed, gamma-sterilized
- Production, assembling and packaging acc. to Cleanroom class 7 (10000)
- According to EU food and FDA guideline

Description	Length mm	Imm. depth mm	PK	Cat. No.
visual identification	263	150	10	6.284 559
detectable	263	150	10	6.284 570

3 Anti-tamper seal-it, self-adhesive roll

Bürkle



If a container opening is closed with Seal-it, then the container cannot be opened without destroying the seal-it label. Seal-it is additionally provided with several cross-perforations which immediately tear when manipulated like a motorcar tax disc. Seal-it can be used to securely seal bottles, sample bags, sacks, specimen bags, envelopes, etc. The white labelling field on the seal-it can be written on with all conventional writing tools with, for example contents information, sampling date, name of operator, etc.

- Clear identification via numbers in sequence
- Integrated control label with the same number, for accompanying documents
- 500 consecutively numbered labels in each roll
- Format 178 mm long, 30 mm wide
- Tear-off perforation for each label

Type	PK	Cat. No.
Seal-it	500	7.622 477

1

1 | 2 Control seals for sampling close-it

White/plain or coloured with labelling field. close-it has a sandwich-type structure (aluminium/ paper) and seals the container hermetically (vapour barrier).

Bürkle

The rear of the label is coated with a powerful adhesive. This means that close-it sticks firmly to most commercial containers, even to surfaces coated with fine powder, slightly moist or even frozen surfaces where conventional labels or adhesive tape will not stick.

close-it food & pharma ensures aswell the necessary success when resealing sample openings, as it reliably prevents products from escaping after sampling. The adhesive complies with the European guidelines for foodstuffs and FDA guidelines. Just like the original, close-it food & pharma has a barrier layer of aluminium foil, which makes the close-it food & pharma perfectly suited to sampling foodstuffs, pharmaceuticals, cosmetics, food additives, even frozen goods - any applications in which the product must not be contaminated by contact with the adhesive.

2

Type	Description	Colour	PK	Cat. No.
close-it	Printed, 95 x 95 mm	Red	500	9.303 910
close-it	Printed, 95 x 95 mm	Green	500	9.303 911
close-it	Printed, 95 x 95 mm	Yellow	500	9.303 912
close-it	Printed, 95 x 95 mm	Blue	500	9.303 913
close-it	Printed, 95 x 95 mm	Black	500	9.303 914
close-it	Plain, 95 x 95 mm	White	500	9.303 915
Roller for close-it	-	-	1	9.303 919
close-it Maxi	Printed, 150 x 150 mm	Red	250	9.303 980
close-it Maxi	Printed, 150 x 150 mm	Green	250	9.303 981
close-it Maxi	Printed, 150 x 150 mm	Yellow	250	9.303 982
close-it Maxi	Printed, 150 x 150 mm	Blue	250	9.303 983
close-it Maxi	Printed, 150 x 150 mm	Black	250	9.303 984
close-it Maxi	Plain, 150 x 150 mm	White	250	9.303 985
Roller for close-it Maxi	-	-	1	9.303 989
close-it food & pharma	Printed, 95 x 95 mm	Red	500	6.228 255
close-it food & pharma	Printed, 95 x 95 mm	Green	500	9.303 998
close-it food & pharma	Printed, 95 x 95 mm	Yellow	500	9.303 996
close-it food & pharma	Printed, 95 x 95 mm	Blue	500	9.303 997
close-it food & pharma	Printed, 95 x 95 mm	Black	500	9.303 999
close-it food & pharma	Plain, 95 x 95 mm	White	500	9.303 986
close-it food & pharma Maxi	Printed, 150 x 150 mm	Red	250	9.303 990
close-it food & pharma Maxi	Plain, 150 x 150 mm	White	250	9.303 991
close-it food & pharma Maxi	Printed, Roll, 150 mm x 150 mm	yellow	250	9.304 000
close-it food & pharma Maxi	Printed, Roll, 150 mm x 150 mm	blue	250	9.304 001
close-it food & pharma Maxi	Printed, Roll, 150 mm x 150 mm	green	250	9.304 002
close-it food & pharma Maxi	Printed, Roll, 150 mm x 150 mm	black	250	9.304 003
close-it tape	Roll, 95 mm x 50 m	White	50	9.303 992
close-it tape Maxi	Roll, 150 mm x 50 m	White	50	9.303 993
close-it tape food & pharma	Roll, 95 mm x 50 m	White	50	9.303 994
close-it tape food & pharma Maxi	Roll, 150 mm x 50 m	White	50	9.303 995

3

3 Dispensing scoops, Aluminium

Capacity ml	Length Scoop mm	Overall length mm	PK	Cat. No.
42	80	135	1	9.201 113
105	113	185	1	9.201 118
140	120	210	1	9.201 121
260	145	250	1	9.201 125
340	155	265	1	9.201 126
555	185	310	1	9.201 131
675	220	350	1	9.201 135
1510	270	400	1	9.201 140
3000	300	430	1	9.201 143

➔ For sample containers - please see page 563

1 Scoops FoodScoop, Stainless steel



Very stable hand scoop for various applications, particularly suited for the food industry. Seamless connection of scoop and hollow handle, therefore without crevices and edges. Especially smooth, highly polished surface.

- Especially sturdy model
- Stainless steel V2A (1.4301)
- With handy suspension eyelet

Capacity ml	Width Scoop mm	Length Scoop mm	Overall length mm	PK	Cat. No.
100	60	120	215	1	6.254 785
200	75	140	230	1	6.252 363
250	85	155	245	1	6.254 786
350	100	180	290	1	6.242 476
500	130	220	350	1	6.072 181

1

Bürkle



2 Dispensing scoops, stainless steel

Made from stainless steel Remanit® 4301.

Capacity ml	Diam. mm	Length Scoop mm	Overall length mm	PK	Cat. No.
120	50	100	190	1	9.201 219
450	75	145	250	1	9.201 222
1000	105	190	320	1	9.201 232
1500	120	240	350	1	9.201 235
2000	150	250	370	1	6.080 286

2



3 Sampling scoops and spoons, PS, sterile

White or red high-impact polystyrene plastic. Red colored scoops reduces the chance of residual sample staying in the scoop or the scoop being accidentally left behind in a sample. The spatula has a sturdy point for taking sterile samples and for piercing paper bags or similar packages.

Bel-Art Products

- Individually sealed and sterilised in a polyethylene bag
- Long handle increases the distance between the hand and the sample
- Scoop is suitable for use as weighing boat
- Food-safe
- Lot stamped for accurate lot tracing
- Shipped with a Certificate of Processing for Sterilization
- Made from FDA grade materials

Type	Capacity ml	Colour	PK	Cat. No.
Spatula, v-shaped	15	white	100	6.201 657
Scoop	60	white	100	4.675 626
Scoop	125	white	100	4.675 627
Scoop	250	white	100	4.675 628
Scoop	60	red	100	4.675 629
Scoop	125	red	100	4.675 625
Scoop	250	red	100	4.675 630
Spoon	1.25	white	200	4.675 631
Spoon	2.46	white	200	4.675 632
Spoon	4.93	white	200	4.675 633
Spoon	14.79	white	200	4.675 634

3



Other sampling devices are available on request.

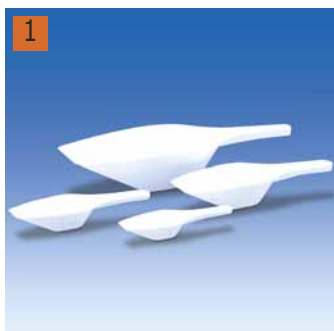

1 Measuring scoops, PP

VITLAB



White measuring scoops which are also suitable as weighing scoops. With precision formed filling edge and comfortable, stable handle. Easily readable volume quantities on the upper side of the handle. Food-safe product according to regulation (EU) No. 10/2011.

Capacity ml	Length mm	PK	Cat. No.
2	60	12	9.201 042
5	82	12	9.201 043
10	100	12	9.201 045
25	135	12	9.201 047
50	160	12	9.201 048
100	200	12	9.201 049
250	260	6	4.678 198
250	315	6	4.678 197
1000	385	6	9.201 050



2 Measuring scoops, HDPE

VITLAB



Natural colouring. Conical in shape with tapered filling edge. Food-safe product according to regulation (EU) No. 10/2011.

Capacity ml	Length mm	Colour	PK	Cat. No.
15	115	Natural	1	7.008 959
25	135	Natural	1	7.008 960
65	185	Natural	1	7.008 961
110	215	Natural	1	7.008 962
150	250	Natural	1	9.201 025
350	310	Natural	1	9.201 030
750	350	Natural	1	9.201 035
750	350	Ultramarin	1	6.310 292
750	350	Black	1	4.671 820
1250	400	Natural	1	9.201 040
1250	400	Ultramarin	1	6.310 293
1250	400	Black	1	4.671 821



1 Disposable scoops LaboPlast®/SteriPlast®, PS

White. They are ideal for sampling of powder, granules and pastes. The scoops are also available with transparent cover to close them immediately after the sampling procedure to secure a sterile and contamination-free sample.

Bürkle



- Individually packed
- SteriPlast® additionally gamma-sterilized
- Production, assembling and packaging acc. to Cleanroom class 7 (10000)
- According to EU food and FDA guidelines

Type	Sterile	Capacity ml	Length mm	Version	Material	PK	Cat. No.
LaboPlast®	-	25	141	without lid	PS	10	6.265 025
LaboPlast®	-	25	142	with lid	PS	10	6.265 026
LaboPlast®	-	50	160	without lid	PS	10	6.265 027
LaboPlast®	-	50	161	with lid	PS	10	6.265 028
LaboPlast®	-	100	205	without lid	PS	10	6.265 029
LaboPlast®	-	100	206	with lid	PS	10	6.265 030
LaboPlast®	-	150	216	without lid	PS	10	6.265 031
LaboPlast®	-	150	218	with lid	PS	10	6.265 032
LaboPlast®	-	250	232	without lid	PS	10	6.269 508
LaboPlast®	-	250	235	with lid	PS	10	6.269 509
LaboPlast®	-	500	280	without lid	PS	10	6.269 510
LaboPlast®	-	500	283	with lid	PS	10	6.269 511
LaboPlast®	-	1000	332	without lid	PS	10	6.284 541
SteriPlast®	+	25	141	without lid	PS	10	6.265 037
SteriPlast®	+	25	142	with lid	PS	10	6.265 038
SteriPlast®	+	50	160	without lid	PS	10	6.265 039
SteriPlast®	+	50	161	with lid	PS	10	6.265 040
SteriPlast®	+	100	205	without lid	PS	10	6.265 041
SteriPlast®	+	100	206	with lid	PS	10	6.265 042
SteriPlast®	+	150	216	without lid	PS	10	6.265 043
SteriPlast®	+	150	218	with lid	PS	10	6.265 044
SteriPlast®	+	250	232	without lid	PS	10	6.269 512
SteriPlast®	+	250	235	with lid	PS	10	6.269 513
SteriPlast®	+	500	280	without lid	PS	10	6.269 514
SteriPlast®	+	500	283	with lid	PS	10	6.269 515
SteriPlast®	+	1000	332	without lid	PS	10	6.284 542

2 Disposable scoops LaboPlast® Bio/SteriPlast® Bio, Green PE



Bürkle



White. They are ideal for sampling of powder, granules and pastes. The LaboPlast® Bio/SteriPlast® Bio products are entirely made of renewable resources. Not only with regard to quality but also with regard to its characteristics for high-quality sampling, it is perfectly comparable with conventional polyethylene.

- Individually packed in organic PE foil
- SteriPlast® Bio additionally gamma-sterilized
- Production, assembling and packaging acc. to Cleanroom class 7 (10000)
- According to EU food and FDA guidelines

Type	Sterile	Capacity ml	Length mm	Material	PK	Cat. No.
LaboPlast® Bio	-	25	141	Green PE	10	6.265 055
LaboPlast® Bio	-	50	160	Green PE	10	6.265 056
LaboPlast® Bio	-	100	205	Green PE	10	6.265 057
LaboPlast® Bio	-	150	216	Green PE	10	6.265 058
SteriPlast® Bio	+	25	141	Green PE	10	6.265 049
SteriPlast® Bio	+	50	160	Green PE	10	6.265 050
SteriPlast® Bio	+	100	205	Green PE	10	6.265 051
SteriPlast® Bio	+	150	216	Green PE	10	6.265 052

We can supply this
manufacturer's whole
product range !





1

1 Disposable scoops for foodstuffs SteriPlast®, PS

Bürkle



Blue. The food scoop is ideal for powders, granulates and pastes. The shade of blue that is used does not occur in a natural form in foodstuffs. Because of this, the scoops or parts of them can be quickly found and easily identified in a visual check if they are ever mixed into production. The detectable scoops have a special additive in the material that makes them visible to metal detectors or X rays. They can therefore be rejected with standard systems for checking for foreign objects, even though they are made of plastic.

- Individually packed, gamma-sterilized
- Production, assembly and packaging according to clean room class 7 (10000)
- According to EU food and FDA guideline

Description	Capacity	Overall length	PK	Cat. No.
	ml	mm		
visual identification	25	141	10	6.284 552
visual identification	50	160	10	6.284 553
visual identification	100	205	10	6.284 554
visual identification	150	216	10	6.284 555
visual identification	250	232	10	6.284 556
visual identification	500	280	10	6.284 557
visual identification	1000	332	10	6.284 558
detectable	25	141	10	6.284 563
detectable	50	160	10	6.284 564
detectable	100	205	10	6.284 565
detectable	150	216	10	6.284 566
detectable	250	232	10	6.284 567
detectable	500	280	10	6.284 568
detectable	1000	332	10	6.284 569

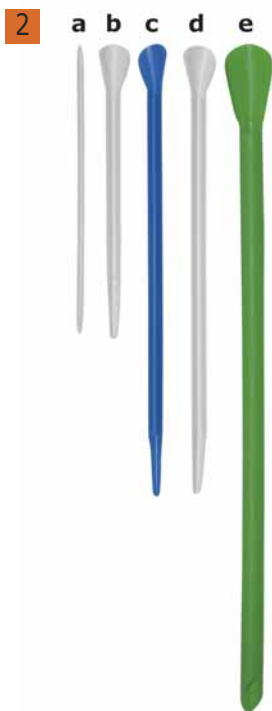

2

2 Powder spatula smartSPATULAS®, PP

Heathrow Scientific



Single use polypropylene lab tools reduce costly contamination errors.

- Size related designs to fit perfectly with standard 0.2, 1.5/2.0, 15 and 50 mL tubes
- Ideal for dispensing or sample collection of powders or soft solids
- Shatter-resistant in liquid nitrogen, resistant to diluted acids and bases, and can be used with hot liquids
- Anti-static, sterile and Eco-friendly versions available
- Autoclavable and complies with FDA standards for food contact

For tubes ml	Description	Colour	Diam.	Length	Figure	PK	Cat. No.
			mm	mm			
0.2	Micro Antistatic	Natural	3.5	140	a	300	6.256 896
15/1.5/2.0	Eco	Natural	7.0	140	b	300	6.256 894
15/1.5/2.0	Standard	Blue	7.0	210	c	300	6.256 893
15/1.5/2.0	Standard	Natural	7.0	210	d	300	6.256 895
15/1.5/2.0	Standard sterile	Natural	7.0	210	d	100	6.256 898
50	Macro	Green	1.0	310	e	150	6.256 897



1 2 Sampling Dippers DispoDipper LaboPlast®/SteriPlast®, PP, blue transparent



Bürkle

Scaled sampling tube manufactured in a clean room specially designed for disposable use. Due to the blue colour, it is also perfect for use in the food, animal feed and pharmaceutical industries. After sampling, the container can be closed and is leakproof. DispoDipper is completely manufactured in one piece and can be used for sampling and subsequent transport of the sample in one device. In this way, cross-contamination or sample impurities are almost impossible. For sampling, first remove the cover at the predetermined breaking point. Then take the sample with the sample container and close it securely. After sampling, the handle at the predetermined breaking point can be detached from the sample container. This allows for easy and space-saving transport of the sample.

- Individually packaged and optionally sterilised by gamma rays (SteriPlast®)
- Production and packaging according to clean room class 7
- Complies with EU food requirements and FDA regulations

Description	Capacity	Diam.	Height	Overall length	PK	Cat. No.
	ml	mm	mm	mm		
LaboPlast®	50	40	98	417	20	6.290 524
SteriPlast®	50	40	98	417	20	6.290 525
LaboPlast®	100	53	98	415	20	4.662 230
SteriPlast®	100	53	98	415	20	4.662 231
LaboPlast®	250	72	116	429	20	4.662 232
SteriPlast®	250	72	116	429	20	4.662 233



3 Sampling Dippers DispoLadle, HDPE



Bürkle

The DispoLadle is a sampling scoop specially designed for disposable use. The scaled scoop with embossing can be used for measuring. It shows contents in increments of 10 ml, up to 200 ml. An ergonomic handle and a spout on both sides for right or lefthand operation make handling simple and easy.

- Cleanroom manufactured
- Individually packaged
- Optionally sterilised by gamma rays

Description	Capacity	Length	PK	Cat. No.
	ml	mm		
standard	200	500	20	6.284 537
sterile	200	500	20	6.284 538
standard	200	1000	20	6.284 539
sterile	200	1000	20	6.284 540



4 Chemistry scoop, PP, with rod handle

For aggressive liquids, complete with strong handle made of polypropylene.

Bürkle

Capacity	Stem diam.	Stem	PK	Cat. No.
ml	mm	mm		
250	20	1000	1	9.303 840
600	20	1000	1	9.303 842
1000	20	1000	1	9.303 844



Liquid-Sampler, single hand operation, stainless steel

Sampler for thin to viscous liquids. Easy use with one-handed operation. With discharge funnel for safe filling of sample bottles. Material V4A (1.4404).

Bürkle

Description	Capacity	Length	Diam.	PK	Cat. No.
	ml	mm	mm		
open with thumb	50	460	32	1	6.072 639
open with thumb	100	540	32	1	6.092 997 5
place onto bottle	50	455	32	1	6.253 634
place onto bottle	100	535	32	1	7.622 377 6



6.092 997

7.622 377

Sample Taking System INGENIOUS

A new, easy-to-handle sample taking system for manual sampling.

Windaus-Labortechnik

General purpose thanks to

- quick and easy exchange of the sample taking equipment
- simple change by pressing the spring mechanism
- extremely strong fiber glass telescopic poles, non-corrosive
- for up to 20 different sample taking devices
- four different fiber glass telescopic poles extensible from 1.5 m up to 6.00 m in length

Please order telescopic poles separately.



1 Fiber glass telescopic pole INGENIOUS

Very robust telescopic pole, ideal for sample taking. Fiber glass makes it almost indestructible and non-corrosive. Comfortable to carry even at low temperatures.

Windaus-Labortechnik

Simple extension and adjustment mechanism. You can change the length easily by a quarter rotation. (Pic. 3).

At telescope poles of 3.85 to 6 meter the length could be easily changed by using the clamp. (Pic. 2).

Comfortable use of spring mechanism. This type can take all samplers and catchers with universal connecting part.

Length m	PK	Cat. No.
1.45 - 2.75	1	6.801 684
1.50 - 3.85	1	6.241 444
1.50 - 5.00	1	6.263 282
1.50 - 6.00	1	6.263 283



2 Waterlanding net

Very robust, with nylon net, for catching flees, bugs, floating particles and water insects.

Windaus-Labortechnik

Mesh width 0.8 mm. With robust aluminium ring of 200 mm diameter.

Double-stitched version. With universal connecting part.

Type	Aperture size mm	Material	PK	Cat. No.
Waterlanding net	0.8	nylon	1	6.263 284



3 Pendulum beaker, stainless steel

Nothing can be spilt because beaker automatically swings into a vertical position.

Windaus-Labortechnik

Dimension of the beaker: 100 mm diameter, 130 mm height, 1 liter volume.

With universal connecting part.

Type	Capacity Litres	Material	PK	Cat. No.
Pendulum beaker	1	stainless steel	1	6.263 290



7.621 456

4 Angled sample beaker, PP

With exchangeable beaker made of PP. The construction of the beaker holder

Windaus-Labortechnik

(stainless steel tension band) makes it possible to turn the beaker around in order to change the pouring direction as well as the adjustment of the click-in angle construction (0 to 180°).

Type	Capacity Litres	Material	PK	Cat. No.
Angled sample beaker	1	PP	1	7.621 456 4



5 Angled sample beaker, stainless steel

Especially suitable for mud-sampling. Stainless steel beaker with reinforced rim.

Windaus-Labortechnik

With adjustable click-in angle from 0 to 180°.

Type	Material	Capacity Litres	Dimensions (dia. x H) mm	PK	Cat. No.
Angled sample beaker	stainless steel	1	100 x 130	1	7.658 408



6 Angled sample beaker, stainless steel

Completely made of stainless steel. Holder and the beaker can be sterilised.

Windaus-Labortechnik

With adjustable click-in angle from 0 to 180°.

Type	Material	Capacity Litres	Dimensions (dia. x H) mm	PK	Cat. No.
Angled sample beaker	stainless steel	1	100 x 130	1	6.313 766

1 All purpose clamp for sample bottles, stainless steel **NEW**

For various bottles with neck diameters from 10 to 80 mm and volumes of max. 1000 ml. With adjustable click-in angle from 0 to 180°. *Windaus-Labortechnik*

Type	Material	PK	Cat. No.
All purpose clamp for sample bottles	stainless steel	1	6.228 232



2 All purpose clamp, stainless steel with silicon coating **NEW**

For bottles or containers with a diameter of up to 110 mm. With 3 holder elements coated with a silicone tube for a very safe grip. With adjustable click-in angle from 0 to 180°. *Windaus-Labortechnik*

Type	Material	PK	Cat. No.
All purpose clamp	stainless steel/silicone	1	6.313 765



Sampling system TeleScoop

TeleScoop is a versatile sampling system with exchangeable tools for a wide range of applications. The tools (angular beaker, pendulum beaker, bottle holder, stainless steel beaker and dip net e.g. for taking solid and organic samples from water courses) are attached to the rod by a practical snap-in joint. Ideal for sampling from baths, tanks, shafts, open water courses etc. Sampling depths down to 6 M can be reached with the adjustable telescopic aluminum rod. *Bürkle*

3 TeleScoop Telescopic Rods, aluminium *Bürkle*

The individual rods have been provided with an end stop. This means that one rod cannot accidentally slip out of another rod. The telescopic rods cannot be rotated radially.

- Increased rigidity by using cold-rolled profile rod
- Springs made of stainless steel

Description	Length m	PK	Cat. No.
Telescopic rod	0,65 - 1,20	1	9.303 800
Telescopic rod	0,70 - 1,80	1	6.266 590
Telescopic rod	0,95 - 2,80	1	9.303 801
Telescopic rod	1,25 - 2,50	1	9.303 802
Telescopic rod	1,15 - 3,00	1	9.303 804
Telescopic rod	1,65 - 4,50	1	9.303 806
Telescopic rod	1,75 - 6,00	1	9.303 807



4 Angular, sample beakers, angled for TeleScoop, PP *Bürkle*

With individually variable angle adjustment.

Capacity ml	Material	PK	Cat. No.
600	PP	1	9.303 810
1000	PP	1	9.303 812
2000	PP	1	9.303 814



5 Pendulum beaker for TeleScoop, PP *Bürkle*

Automatically swings into a vertical position. Nothing can be spilled. Ideal for deep and narrow shafts.

Capacity ml	Material	PK	Cat. No.
600	PP	1	9.303 820
1000	PP	1	9.303 822
2000	PP	1	9.303 824



1



1 Bottle holder for TeleScoop, PP/PA

Holds bottles up to max. 88 mm diameter incl. 750 ml bottle (Spare bottle Cat. No. 9.072 987). Suitable for plastic and glass bottles. With universal quick-action clamping strap.

Bürkle

Type	PK	Cat. No.
Bottle holder	1	9.303 830

2



2 Beaker for TeleScoop, stainless steel V2A

Beaker with scraper for pasty or powdery materials

Bürkle

- With lip for scraping
- Sterilisable

Capacity ml	PK	Cat. No.
1000	1	9.303 846

3



9.303 828

Catch nets for TeleScoop, PVC/PA - PP/PA

Ideal for sampling from basins, tanks, shafts, open waters etc. The telescopic aluminium rods TeleScoop allow sampling up to 6 m depth.

Bürkle

- For industries and water treatment
- Mesh width: 2 mm up to 5 mm
- Depth cath net, net depth: 250 mm

Type	Dimensions (W x D) mm	Material	PK	Cat. No.
Surface catch net	310 x 280	PVC / PA	1	9.303 828 3
Depth catch net	190 x 430	PP / PA	1	9.303 829 4

4



9.303 829

5



5 Scoop, stainless steel V2A, sterilisable

Without openings, undercuts or crevices in which residues could collect. Pore-free finishing produced by high-quality laser welding seams. The dip sampler is sterilisable by flame sterilisation or steam sterilisation and can therefore be made completely germ-free. Complete with rod.

Bürkle

Capacity ml	Overall length mm	PK	Cat. No.
1000	1150	1	6.233 131

6



6 Liquid sampler MiniSampler, PE



Bürkle

Taking samples is quick, easy, clean and practical.

With the MiniSampler, the sample liquid only comes into contact with the suction hose and the sample bottle. Cross contamination is largely prevented. Bottles can be tightly sealed immediately after the sample is taken with a tamper-evident cap.

The single use, PE suction hose can be quickly replaced, ensuring that samples are never contaminated. A new hose can be used for each sample if required. Because of its small diameter (8 mm) and flexibility the hose can reach sampling areas that are otherwise inaccessible. Also suitable for viscous oils.

Included:

Supplied with ten 100 ml PE bottles, 10 m of PE suction hose (6 x 8 mm), 1 hose cutter, 1 hose weight (V2A/nickel-plated brass) and 20 seal-it safety seal labels in a carrying case.

Type	PK	Cat. No.
MiniSampler	1	9.303 970

1 2 Vampire Sampler

The self-priming peristaltic pump is also suitable for dirty or particle-containing substances with a viscosity of max. 500 mPas. Ideal for sampling from barrels, tanks, wells, water separators, waste water and sewage treatment plants. The samples are fed directly into the sample container via the closed hose system.

Bürkle



- Battery-powered hose pump
- Easy cleaning and exchangeable hoses prevent impurities
- Suction depth up to 5 metres

Scope of supply: Drive unit, pump head, pump hose (30 cm, Marprene), suction hose (5 m, PE), hose connector (PP), sample bottle (250 ml, LDPE), bottle basket, two rechargeable batteries, battery charger

Type	PK	Cat. No.
Vampire sampler, complete	1	9.303 851

Suitable accessories can be found in our online shop.



3 Disposable liquid samplers, HDPE



Bürkle

In numerous situations, rapid and contamination-free samples have to be taken. DispoSamplers are perfect for this application. They are cleanroom-manufactured, individually-packed and always ready-to-use. Avoid expensive decontamination or cleaning of soiled samplers. Gamma-sterilised versions are also available.

ViscoDispo: For high viscosity-media up to 100000 mPas.

LiquiDispo: For liquids and slightly viscous media.

DispoPipette: For taking all-layer and target-point samples from low viscosity-media.

DispoTube: For taking all-layer and target-point samples from liquids.

Type	Description	Capacity ml	Length mm	PK	Cat. No.
ViscoDispo	non-sterile	100	500	20	9.303 732
ViscoDispo	sterile	100	500	20	9.303 733
ViscoDispo	non-sterile	200	1000	20	9.303 734
ViscoDispo	sterile	200	1000	20	9.303 735
LiquiDispo	non-sterile	100	500	20	9.303 720
LiquiDispo	sterile	100	500	20	9.303 721
LiquiDispo	non-sterile	200	1000	20	9.303 722
LiquiDispo	sterile	200	1000	20	9.303 723
DispoPipette	non-sterile	100	500	20	6.282 451
DispoPipette	sterile	100	500	20	7.971 434
DispoPipette	non-sterile	200	1000	20	6.281 402
DispoPipette	sterile	200	1000	20	6.281 401
DispoTube	non-sterile	100	500	20	6.282 447
DispoTube	sterile	100	500	20	6.282 448
DispoTube	non-sterile	200	1000	20	6.282 449
DispoTube	sterile	200	1000	20	6.282 450



4 Sampler LiquiSampler, PTFE/FEP or PP



Bürkle

DIN EN ISO 15528. For liquids. Made of ultra pure and chemically inert PTFE/FEP or PP for contamination-free sampling. Practical push button, single-handed operation. Suitable for point, cross-sectional, and bottom sampling. Ideal for sampling from open and closed drums, kegs, tanks, silos, water sources (ponds, lakes, streams, rivers). Suitable for all commercial kegs and drums with openings of at least 32 mm diameter. All surfaces are non-porous and crevice-free preventing accumulation of dirt. Only round-profile screwthreads, suitable for food hygiene applications, are used. Simple to dismantle and clean.

Nominal capacity ml	Length mm	Diam. mm	Colour	Material	PK	Cat. No.
150	600	32	highly transparent	PTFE/FEP	1	6.255 307
250	1000	32	highly transparent	PTFE/FEP	1	9.303 950
500	2000	32	highly transparent	PTFE/FEP	1	9.303 951
150	600	32	transparent	PP	1	6.901 807
250	1000	32	transparent	PP	1	9.303 955
500	2000	32	transparent	PP	1	9.303 956





1 Sampler ViscoSampler, PTFE/FEP or PP

Bürkle



Ultra-pure sampler with powerful suction for viscous media. Specially developed for viscous substances, such as slurries, silt, wet clay and soil samples, sediments, oils, emulsions and creams.

The suction flask sucks up and discharges the material. All surfaces are non-porous and crevice-free, preventing dirt accumulation. Only round-profile threads, suitable for food hygiene applications, are used. Allow easy dismantling and cleaning.

Nominal capacity ml	Length mm	Diam. mm	Colour	Material	PK	Cat. No.
160	600	32	highly transparent	PTFE/FEP	1	6.803 102
300	1000	32	highly transparent	PTFE/FEP	1	9.303 960
650	2000	32	highly transparent	PTFE/FEP	1	9.303 961
160	600	32	transparent	PP	1	6.253 163
300	1000	32	transparent	PP	1	9.303 965
650	2000	32	transparent	PP	1	9.303 966

2 Manually-operated reels and lowering cables

Manually-operated reels

Bürkle

- High winding capacity of up to 150 m for cable 2 mm dia.
- Reel width: inner 44 mm, outer 55 mm, reel diameter: inner 100 mm, outer 180 mm
- Please order the required lowering cable separately

Lowering cables

- For dipping bottles and immersion cylinders, matching manually-operated drum reels made of various materials
- Tensile load max. up to 10 kg

Description	Length m	Diam. mm	PK	Cat. No.
Manually-operated reel, PP green	-	-	1	6.200 263
Manually-operated reel, black PA, electrically conductive	-	-	1	9.303 941
Manually-operated reel EX with grounding cable, black	-	-	1	6.234 815
Stainless steel lowering cable, PTFE-coated	10	2.00	1	6.087 044
Stainless steel lowering cable, PTFE-coated	25	2.00	1	7.602 596
Stainless steel lowering cable, PTFE-coated	50	2.00	1	7.602 110
Stainless steel lowering cable	10	1.25	1	9.303 943
Stainless steel lowering cable	25	1.25	1	6.801 844
Stainless steel lowering cable	50	1.25	1	6.233 996
Lowering cable made of PP cord	10	2.00	1	7.620 817
Lowering cable made of PP cord	25	2.00	1	6.222 677
Lowering cable made of PP cord	50	2.00	1	6.223 438
Copper lowering cable EX with loops	10	4.50	1	6.235 904
Copper lowering cable EX with loops	25	4.50	1	6.253 137
Copper lowering cable EX with loops	50	4.50	1	6.286 530
Stainless steel chains	10	2.30	1	7.615 523
Stainless steel chains	25	2.30	1	6.902 362
Snap hooks V4A	-	5.00	1	7.637 496
Shackle	-	4.50	1	7.637 495

2

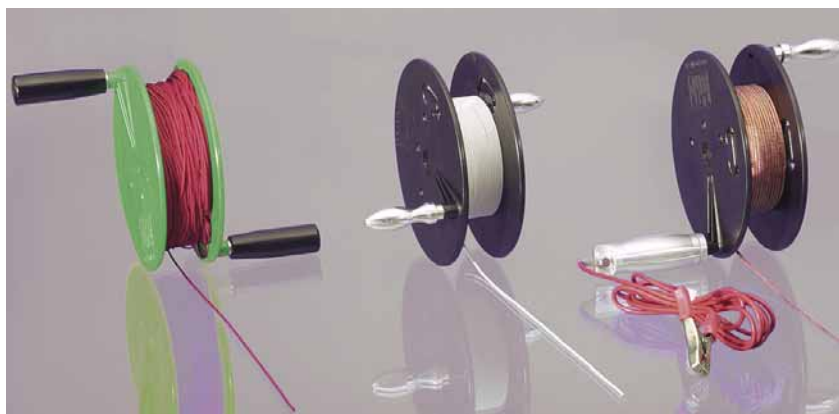

1 Sample bags SteriBag, PE, sterile



Transparent. For samples from chemistry, pharmaceutical, food technology applications etc.

- Sterile, RNase, DNase and pyrogen-free
- Leakproof

Type A: Without write-on panel

Type B: With write-on panel.

Nominal capacity ml	Width mm	Length mm	Description	PK	Cat. No.
60	76	127	A	500	9.404 114
60	76	127	B	500	9.404 119
150	76	178	A	500	9.404 115
150	76	178	B	500	9.404 120
450	114	229	A	500	9.404 116
450	114	229	B	500	9.404 121
650	140	229	A	500	9.404 117
650	140	229	B	500	9.404 122
800	114	305	A	500	9.404 118
800	114	305	B	500	9.404 123
1650	178	305	A	250	6.223 094
1650	178	305	B	250	6.223 093

1

Bürkle



2 Sample bags SteriBag StandUp, PE, sterile, with write-on panel



Transparent. For samples from chemistry, pharmaceutical, food technology applications etc. SteriBag StandUp stable and able to stand on its own without a separate stand or support, leaving both your hands free to take the sample and fill the bag.

- Sterile, RNase, DNase and pyrogen-free
- Leakproof

Nominal capacity ml	Width mm	Length mm	PK	Cat. No.
400	114	229	500	9.404 124
600	152	229	500	9.404 125

2

Bürkle



3 Sample bags SteriBag Premium, tamper-proof



The SteriBag Premium sample bags uniquely combine a high degree of security, sterility, tamper evident closure and traceability, they are used to securely transport and for the storage of samples. After sampling, the sample can be filled directly into the sterile sample bag. The tamper-evident closure seals the bag liquid-tight and secure. When trying to open the closure again, the word "STOP" appears clearly visible. Both the sample bag and the tear-off field are labeled with a unique tracking number, this allows complete documentation and traceability.

SteriBag Premium is suitable for many demanding applications in the food, pharmaceutical, medical area as well as in cleanroom or biotechnology sectors.

- Sterilised by gamma rays (10^{-6})
- With integrated tamper-proof closure for manipulation evidence
- Unique identification via tracking number
- Food-safe

Nominal capacity ml	Width mm	Length mm	PK	Cat. No.
300	145	200	100	9.404 126

3

Bürkle



➔ Adhesive Labels - please see page 168

1

1 Sample bags Whirl-Pak®, PE, sterile

Whirl-Pak® bags are sterile polyethylene laboratory sample bags used to transport samples for biological testing and other applications. Available with or without write-on label. With integrated wire closing system. Temperature range: -210 to 82 °C.

Nasco

Nominal capacity ml	Dimensions (D x W) mm	Thickness mm	Description	PK	Cat. No.
29	65 x 125	0,057	with write-on label	500	7.080 208
58	75 x 125	0,057	with write-on label	500	7.058 005
118	75 x 185	0,057	with write-on label	500	7.077 212
207	95 x 180	0,064	with write-on label	500	6.286 123
532	115 x 230	0,064	with write-on label	500	7.058 120
710	150 x 230	0,076	with write-on label	500	6.242 083
5441	380 x 508	0,102	with write-on label	100	6.257 989
2721	254 x 380	0,102	with write-on label	250	6.266 304
3637	254 x 508	0,102	with write-on label	250	6.266 305
58	75 x 125	0,057	with write-on label	500	6.091 055
118	75 x 185	0,057	without write-on label	500	9.404 234
207	95 x 180	0,076	without write-on label	500	7.981 345
1242	150 x 380	0,076	without write-on label	500	6.266 302
532	115 x 230	0,064	without write-on label	500	9.404 235
710	150 x 230	0,076	without write-on label	500	6.228 639
1065	125 x 380	0,076	without write-on label	500	9.404 236
2041	190 x 380	0,076	without write-on label	500	6.305 117
798	127 x 305	0,076	without write-on label	500	6.280 246

2

2 Sample bags Whirl-Pak® Stand-Up, PE, sterile, free standing

Easy sample handling due to the specially gusseted bottom which flattens out when the sample is placed inside, allowing the bag to stand up on its own. It works just like a bottle or beaker, however it cost less, is shatterproof and uses a fraction of the storage space. The integrated wire closing system ensures the tightness of the sample bag. With write-on label for clean and easy identification. Temperature range: -210 to 82 °C.

Nasco

Nominal capacity ml	Dimensions (D x W) mm	Thickness mm	PK	Cat. No.
118	75 x 185	0,064	500	9.404 231
532	115 x 230	0,076	500	9.404 232
710	150 x 230	0,076	500	6.266 303
1242	150 x 380	0,102	250	7.970 886
1065	125 x 380	0,102	250	6.260 542
2041	190 x 380	0,102	250	6.260 543

3

3 Sample bags/Homogenising bags Whirl-Pak®, PE, sterile

- Sterile, solid bags for the homogenisation of liquids and solids
- With and without labelling strips

Nasco

Nominal capacity ml	Dimensions (D x W) mm	Thickness mm	Description	PK	Cat. No.
384	130 x 190	0,076	without label	500	6.052 018
710	150 x 230	0,102	without label	500	9.404 233
710	150 x 230	0,102	with label	500	7.059 854
1627	190 x 300	0,102	with label	500	7.059 855

4

4 Filter bags Whirl-Pak®, PE, sterile

All the bags use the same filter material. These special bags contain a third layer of finely perforated polyethylene, which filters out the solids in the sample when used in a homogeniser blender. This allows for easy pipetting of the sample. The hole diameter in the filter layer measures 0.33 mm and there are 285 holes per square cm. The filter is sealed into the perimeter of the bag on the sides and bottom, allowing the sample to be placed in the bag on either side. The liquid will transfer through the filter, but the solids stay on one side. With write-on label. Temperature range: -210 to 82 °C.

Nasco

Nominal capacity ml	Dimensions (D x W) mm	Thickness mm	PK	Cat. No.
710	150 x 230	0,102	250	7.970 783
1627	190 x 300	0,102	250	6.263 368

Pressure-seal bags please see page 193.

Special sample bags Whirl-Pak®, PE, sterile

Whirl-Pak® bags are sterile polyethylene laboratory sample bags used to transport samples for biological testing and other applications.
Temperature range -210 to 82 °C.

Available versions:

- With outside pocket for paperwork. Keeps important paperwork dry, clean, and separate from the sample
- Made of black pigmented PE-film providing maximum protection for samples that are sensitive to light
- With white or blue sterile scoop or sterile teaspoon

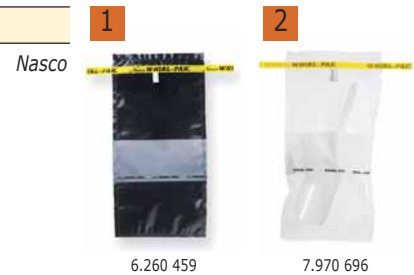

Nasco

6.260 459

7.970 696

Nominal capacity ml	Dimensions (D x W) mm	Thickness mm	Description	PK	Cat. No.
710	150 x 230	0.064	with document bag	500	6.260 544
532	115 x 230	0.064	with light protection, black, write-on lable, white	500	6.260 459 1
532	115 x 230	0.064	with scoop (60 ml), sterile, white	50	7.970 696 2
532	115 x 230	0.064	with scoop (60 ml), sterile, blue	50	6.276 054
532	115 x 230	0.064	with tea spoon, sterile, white	100	6.269 250

Sample bags Whirl-Pak® Thio-Bags®

These bags are specially designed for sampling chlorinated water for example for Legionella testing. Each sterile bag contains a nontoxic, nonnutritive tablet containing active sodium thiosulfate to neutralise chlorine at the time of collection.

The bag is EPA approved and has the additional benefits of saving time, utility costs, storage space, disposal costs, and replacing sample containers. With Write-On strip for clean and easy identification. Temperature range: -210 to 82 °C.

Nasco

Sample bags Whirl-Pak® Stand-Up Thio-Bags®, sterile, free-standing



Nasco

Nominal capacity ml	Dimensions (D x W) mm	Thickness mm	PK	Cat. No.
100	75 x 185	0.064	100	6.290 643
300	115 x 230	0.076	100	6.263 139
500	115 x 230	0.102	100	6.276 042
1000	150 x 380	0.102	100	4.668 520 3
2000	190 x 380	0.102	100	6.276 044

3



4.668 520

Sample bags Whirl-Pak®, PE with sponge, dry, Cellulose



For environmental surface sampling of work areas and equipment. The natural cellulose dry sponge is free of bactericides and has been tested to be non-inhibitory.

Nasco

Nominal capacity ml	Dimensions (D x W) mm	Thickness mm	Description	PK	Cat. No.
532	115 x 230	0.064	Speci-Sponge® with glove, sterile	100	7.970 688
532	115 x 230	0.064	Speci-Sponge®	100	7.970 873 4
1627	190 x 300	0.102	Speci-Sponge®	100	6.281 268
710	150 x 230	0.076	Sponge with detachable handle	50	6.281 269

4



7.970 873

5 Sponge-Stick

Sponges and swabs designed specifically for microbial surface sampling. 3M™ Sponge-Sticks are available in wet or dry formats, to fit many applications. The 1.5" x 3" 3M Sponge-Stick allows sampling without directly handling the sponge.

3M Deutschland

5



Type	Package contents	PK	Cat. No.
Sponge stick, 1.5 x 3 sponge with 10 ml buffered peptone water broth	4 bags of 25	100	6.238 511
Sponge stick moistened with 10 ml neutralization buffer	1 bag of 100	100	6.266 542
Sponge stick	5 bags of 20	100	7.970 470

Sampling/Sample containers-Sample transport, storage

1

1 Aluminium Zipper bags, sealable

- Stand-up pouches
- 5 layers of film of PET, SPE, AL, SPE, and PE
- High barrier properties against oxygen and water vapour
- Protection against the effects of UV radiation
- Temperature range: -40 °C ... 90 °C

AS ONE

Thickness mm	Dimensions (D x W) mm	PK	Cat. No.
0,11	90 x 115	50	4.665 050
0,11	100 x 160	50	4.665 051
0,11	120 x 180	50	4.665 052
0,11	140 x 200	50	4.665 053
0,15	300 x 420	25	4.665 054
0,15	340 x 480	25	4.665 055
0,11	160 x 230	50	4.665 056
0,11	180 x 260	50	4.665 057
0,11	200 x 280	50	4.665 058
0,15	220 x 300	50	4.665 059
0,11	110 x 170	50	4.665 060
0,11	130 x 190	50	4.665 061
0,11	150 x 210	50	4.665 062
0,15	240 x 340	50	4.665 063

2

2 Aluminium Zipper bags

- 5 layers of film of PET, SPE, AL, SPE, and PE
- Excellent light resistance and sealing properties
- 2 bags with 50 pieces per bag

AS ONE

Dimensions (D x W) mm	PK	Cat. No.
85 x 120	100	4.665 064
100 x 140	100	4.665 065
120 x 170	100	4.665 066
140 x 200	100	4.665 067
170 x 240	100	4.665 068
200 x 280	100	4.665 069
240 x 340	100	4.665 070
280 x 400	100	4.665 071

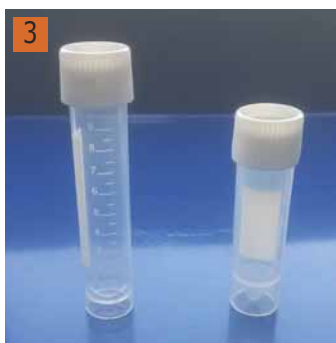
3

3 LLG-Transport tubes, PP, with screw cap

- For convenient storage and dispatch of samples.
- Conical bottom
 - Free standing
 - Printed graduation
 - 1 1/4 turn thread design for super fast screwing

Capacity ml	Outer diam. mm	Height with cap mm	PK	Cat. No.
5	16	60	100	6.265 667
10	16	80	100	6.265 668

4

4 Transport tubes, PS with cap

- Outer case available in transparent or opaque material
- Made of polystyrene with polyethylene caps
- Available sterile or nonsterile, and with or without a spoon for handling of solid and semi-solid samples
- Some available with writing area
- Max. RCF tested: 4000

Thermo Scientific

Capacity ml	Description	PK	Cat. No.
25	with spoon, sterile, PS, with writing area	300	4.008 669
25	without spoon, sterile, PS, without writing area	50	6.086 178
25	without spoon, sterile, PS, with writing area	300	6.091 843
25	without spoon, not sterile, PS, with writing area	300	6.201 453

1 LLG-Sample containers, PP, Heavy Duty, with screw cap, HDPE

Ideal for liquid specimen collection, transportation and storage.

- Ideally suited for liquid histological samples
- Container made of non-cytotoxic polypropylene
- Very solid quality
- Top and bottom gripping assures easy opening and closing when wearing gloves
- Half-transparency containers
- With graduation
- With label
- Leak proof

Nominal capacity ml	Grad. up to ml	Ø with Cover mm	Height mm	PK	Cat. No.
20	15	37	42	1000	6.265 649
40	30	50	40	500	6.265 650
60	50	50	58	500	6.265 651
80	70	50	77	300	6.265 652
120	120	58	77	300	6.265 653
160	160	57	100	200	6.282 108
250	150	97	52	154	6.265 654
450	350	97	110	132	6.265 655
900	700	120	138	64	6.265 656
250		63	121	70	6.267 972
900*	700	120	138	64	6.270 049

* without label.

1



2 LLG-Sample containers, PS/PP, with tamper-evident cap, LDPE/PP



White with tamper-evident cap. Multi-purpose containers e.g. for storage or transport of samples.

Nominal capacity ml	Ø with Cover mm	Height mm	Material	Material Lid	PK	Cat. No.
40	36	52	PS	LDPE	10	9.402 350
100	58	58	PP	PP	10	9.402 353
250	64	95	PS	LDPE	10	9.402 356
1000	116	116	PP	PP	5	9.402 359

2



3 LLG-Sample containers, PP, with screw cap, PP



White, with screwed-on lid.

Nominal capacity ml	Ø with Cover mm	Height mm	PK	Cat. No.
30	58	19	10	9.402 310
75	58	47	10	9.402 313
310	81	81	10	9.402 318
600	119	67	10	9.402 321
1250	119	130	5	9.402 324

3





1 Sample bottles, PP, for water sampling, sterile

ISOLAB

These gamma sterilised bottles are specially designed for taking, handling, transporting and storing water samples. Manufactured either as clear or amber colour from polypropylene. Clear bottles are manufactured from glass-like transparent special grade polypropylene. Amber bottles are manufactured from an amber coloured clear polypropylene which is highly translucent but still preventing the UV light penetrating inside the bottle. Square body form offers easy handling, and optimum space saving solutions during storage period. Wide bottle neck (GL 50) provides easy filling and pouring. Cap is made from PE with self sealing lock with integral security ring. Unique cap inner design ensures hermetical closure and guarantees an excellent leak and contamination proof bottle. Embossed graduation (precision of $\pm 2\%$) on side wall enables volume verifications. Each bottle is labelled specifying e.g. sample and source descriptions, code and lot numbers and expiry date. Bottles with liquid sodium thiosulfate (20 mg/lit - acc to ISO/FIS 19458:2006) are ideal to analyse water meant for human consumption, swimming pools, and any other water where chlorine may modify the composition of the sample. Empty bottles, without sodium thiosulfate ; ideal to sample water for physical and chemical analysis, as well as for other sample requirements that demands sterile bottles. Single packed bottles available on request.

Description	Capacity ml	PK	Cat. No.
clear, sterile, without sodium thiosulfate	125	180	4.678 042
clear, sterile, without sodium thiosulfate	250	108	9.001 075
clear, sterile, without sodium thiosulfate	500	84	9.001 076
clear, sterile, without sodium thiosulfate	1000	30	9.001 077
amber, sterile, without sodium thiosulfate	125	180	4.678 043
amber, sterile, without sodium thiosulfate	250	108	9.001 078
amber, sterile, without sodium thiosulfate	500	84	9.001 079
amber, sterile, without sodium thiosulfate	1000	30	9.001 080
clear, sterile, with sodium thiosulfate	125	180	4.666 052
clear, sterile, with sodium thiosulfate	250	108	9.001 081
clear, sterile, with sodium thiosulfate	500	84	9.001 082
clear, sterile, with sodium thiosulfate	1000	30	9.001 083
amber, sterile, with sodium thiosulfate	125	180	4.678 044
amber, sterile, with sodium thiosulfate	250	108	9.001 084
amber, sterile, with sodium thiosulfate	500	84	9.001 085
amber, sterile, with sodium thiosulfate	1000	30	9.001 086



1 LLG-Mortars only, porcelain

Capacity ml	Ext. diam. mm	Height mm	DIN	Description	PK	Cat. No.
25	51	32		rough inside	1	9.164 410
70	63	41	12906	rough inside	1	6.227 149
75	76	45		rough inside	1	9.164 411
110	83	50		rough inside	1	6.232 577
160	90	56	12906	rough inside	1	6.243 865
220	105	64		rough inside	1	9.164 412
400	125	71	12906	rough inside	1	9.164 413
2250	224	127		rough inside	1	6.252 383
110	83	50		glazed inside	1	6.227 289
220	105	64		glazed inside	1	6.234 591



2 LLG-Pestle only, porcelain

Head diam. mm	Length mm	DIN	Description	PK	Cat. No.
14	54		rough	1	6.227 150
24	115	12906	rough	1	9.164 420
30	135	12906	rough	1	6.232 574
36	150	12906	rough	1	9.164 421
42	175	12906	rough	1	9.164 422
74	250	12906	rough	1	6.252 384
42	175	12906	glazed	1	6.227 292
36	150	12906	glazed	1	6.234 592



3 Mortars only, porcelain

To DIN 12906. With spout, pestle not supplied. Glazed externally. Inside rough.

Haldenwanger

Capacity ml	Int. diam. mm	Height mm	Acc. to	PK	Cat. No.
70	65	40	DIN 12906	1	9.164 206
170	90	55	DIN 12906	1	9.164 209
400	130	65	DIN 12906	1	9.164 212
700	150	70	DIN 12906	1	9.164 215
1000	180	80	DIN 12906	1	9.164 218
2600	240	100	DIN 12906	1	9.164 225



4 Pestles only, porcelain

To DIN 12906. With glazed handle. Unglazed grinding surface.

Haldenwanger

Head diam. mm	Length mm	Acc. to	Nominal diam. mm	PK	Cat. No.
24	115	DIN 12906	50 / 63	1	9.164 306
30	135	DIN 12906	90	1	9.164 309
36	150	DIN 12906	125	1	9.164 312
42	175	DIN 12906	150	1	9.164 315
55	210	DIN 12906	180	1	9.164 318

Nominal size = mortar internal diameter



5 Mortars and pestles, MF



BRAND

White. Melamine formaldehyde (MF). With spouted mortar. Resistant to boiling. Autoclavable at 121 °C.

Diam. mm	Height mm	PK	Cat. No.
125	80	1	9.164 355
150	90	1	9.164 357





1

1 Mortars and pestles, Agate

Agate. Polished. Standard quality. Other sizes available on request.

Capacity ml	Ext. diam. mm	Int. diam. mm	PK	Cat. No.
10	50	40	1	9.164 050
25	75	60	1	9.164 075
50	100	85	1	9.164 100
100	125	100	1	9.164 125



2

2 Mortar, stainless steel

Mortar and pestle head are both made from stainless steel.

Bochem

Description	Capacity ml	PK	Cat. No.
Mortar	250	1	6.900 119
Mortar	500	1	6.802 078
Mortar	750	1	6.087 581
Mortar	1000	1	6.076 504
Mortar	1500	1	6.237 850
Mortar	2000	1	6.802 079
Pestle, 140 mm		1	6.079 568



3

Laboratory Blender Waring® 8010/8011

Versatile laboratory mixer ideally suited for general laboratory work. Supplied either with a 1 L stainless steel container or a 1.2 L glass container. Models 8010 EG/ES with mechanical timer (3 minutes).

WARING®

- Two velocity settings (18000 or 22000 rpm)
- Epoxy coated motor housing
- Two-piece lid vinyl/styrene

Scope of supply: Mixer, container (stainless steel or glass) with handle and lid.

Type	With	Min. speed rpm	Max. speed rpm	Max. Feed quantity/ Flow rate ml	PK	Cat. No.
8010EG	Glass container, 1.2 l	18000	22000	1200	1	9.571 436
8010ES	Stainless steel container, 1 l	18000	22000	1000	1	9.571 437
8011EG	Glass container, 1.2 l	18000	22000	1200	1	6.284 693 3
8011ES	Stainless steel container, 1 l	18000	22000	1000	1	6.284 694

6.284 693



4

Laboratory Blender Waring® LB20 EG/ES

Versatile laboratory mixer ideally suited for general laboratory work. Supplied either with a 1 L stainless steel container or a 1.2 L glass container.

WARING®

- Variable velocity settings (500 or 22000 rpm)
- Epoxy coated motor housing
- Two-piece lid vinyl/styrene

Scope of supply: Mixer, container (stainless steel or glass) with handle and lid.

Type	With	Min. speed rpm	Max. speed rpm	Max. Feed quantity/ Flow rate ml	PK	Cat. No.
20EG	Glass container, 1.2 l	500	22000	1200	1	6.229 881
20ES	Stainless steel container, 1 l	500	22000	1000	1	6.240 222 4

6.240 222

Accessories for Laboratory Blender Waring®

WARING®

Description	PK	Cat. No.
1 L stainless steel container complete with two-piece lid	1	9.571 453
1.2 L glass container complete with two-piece lid	1	9.571 450
Spare blending assembly for 1 L blender	1	9.571 461
Spare blade	1	6.284 695

Mixers MICROTRON® MB 550/MB 800

The systems MICROTRON® MB 550 and MB 800 are specially designed for mixing, dispersing, homogenizing, emulsifying and size reduction of cuttable materials. Four different attachments made from glass with volumes of 125 ml, 250 ml, 500 ml and 1000 ml are available for the MICROTRON® MB 550. Attachments made from stainless steel with volumes of 2000 ml and 4000 ml are available for the MICROTRON® MB 800. Both systems are safety laboratory devices: grounded, double safety isolated, radio screened. A safety system prevents uncontrolled starting and therewith personal injuries: the mixer can only be started with well attached safety hood or lid. In case the hood or lid will be removed during operation the device will be stopped automatically. Both systems are designed to withstand high loads; they are space saving and always ready to use. KINEMATICA

Mixing jars and protective hoods - please order separately. Mixer MICROTRON® MB 550 can only be started with attached safety hood.

Specifications

Motor input power	
MB 550:	550W
MB 800:	800W
Speed range	
MB 550:	Stepless, 1000 to 15.000 rpm
MB 800:	Stepless, 1000 to 17.000 rpm
Dimensions (Ø x H):	190 x 245 mm

Type	Min. speed rpm	Max. speed rpm	Max. Feed quantity/ Flow rate ml	PK	Cat. No.
MB 550	1000	15000	1000	1	6.241 879 ¹
MB 800	1000	17000	4000	1	6.259 416

Accessories for Mixer MICROTRON® MB 550/MB 800

The mixing attachments MBA 125 to 1000 ml made of glass can be dismantled completely and easily. The mixing attachments MBA 2000 and MBA 4000 are made of stainless steel. Their robust safety lids have an integrated feed opening for dosing. Knife unit with 4 blades made of stainless steel, easy to dismantle for easy cleaning. For the operation of the mixer 550 MB MICROTRON a safety hood is mandatory, please order separately. KINEMATICA

Type	For	Description	Volume ml	Material	PK	Cat. No.
MBA 125	MB 550	Mixing attachment	125	Glass	1	6.257 342
MBA 250	MB 550	Mixing attachment	250	Glass	1	6.260 922
MBA 500	MB 550	Mixing attachment	500	Glass	1	6.241 880
MBA 1000	MB 550	Mixing attachment	1000	Glass	1	6.260 923 ²
MBA 2000	MB 800	Mixing attachment with safety lid	2000	Stainless steel	1	6.260 924 ³
MBA 4000	MB 800	Mixing attachment with safety lid	4000	Stainless steel	1	6.259 417
MBH 125	MB 550	Safety hood for MBA 125	-	Acrylic glass	1	6.257 343
MBH 250	MB 550	Safety hood for MBA 250	-	Acrylic glass	1	6.260 925
MBH 500	MB 550	Safety hood for MBA 500	-	Acrylic glass	1	6.241 881
MBH 1000	MB 550	Safety hood for MBA 1000	-	Acrylic glass	1	6.260 926 ⁴

1



6.241 879

2



6.260 923

3



6.260 924

4



6.260 926

Dry Mill POLYMIX® PX-MFC 90 D

The PX-MFC 90 D is suitable for dry sample grinding in the laboratory. It's possible to change the hammer and cutting mill sets. KINEMATICA

- The blade grinding attachment is used for processing of dried, stringy and fibrous and grease-free materials.

Application: Wood, straw, dried grease-free meat, leather, paper, carbon, synthetics etc.

- The hammer grinding attachment is used for processing of dried, brittle and grease-free materials.

Application: Dried grain, dried beans, bones, rock, ceramics etc.

- Sieves 0.2 mm up to 6 mm diameter

- Safety system prevents start when lid is open

- Powerful three-phase motor

- Milling chamber with interchangeable inserts

- LED display

- Working volume of 300 ml (Funnel volume)

- 1000 Watt, 3-phase motor provides a low noise level during operation, with 230 Volt connection

- Sieves from 0.2 to 6 mm mesh size

- Integrated speed control with LED display for speed and status messages

- Speeds from 50 to 6.000 rpm for maximum grinding efficiency

- The motor cannot be operated when the chamber door is open

- Integrated overheating, overload and rotor blocking protection

- Safety stopper for certain grinding materials

Scope of supply: Mill with Hammer or Cutting Mill sets, 2 mm sieve, tool set and wooden stand with 12 collection tubes.

Specifications

Application volume:	Hopper 300 ml
Sieves:	0.2, 0.5, 0.8, 1.0, 1.5, 2.0, 3.0, 4.0, 5.0, 6.0 mm
Motor input power:	1000W
Speed range:	speeds up to 6000 min ⁻¹
Drive Dimensions (L x W x H):	251 x 325 x 480 mm
Tested to:	IEC/EN 61000-6-2/EN 61000-6-3 IEC/EN 61010-2-51

Type	With	Min. speed rpm	Max. speed rpm	Max. Feed quantity/ Flow rate ml	Plug type	PK	Cat. No.
POLYMIX® PX-MFC 90 D	Hammer grinding attachment	50	6000	300	EU	1	6.241 371 1
POLYMIX® PX-MFC 90 D	Hammer grinding attachment	50	6000	300	CH	1	6.258 266
POLYMIX® PX-MFC 90 D	Hammer grinding attachment	50	6000	300	UK	1	6.312 152
POLYMIX® PX-MFC 90 D	Blade grinding attachment	50	6000	300	EU	1	6.252 048
POLYMIX® PX-MFC 90 D	Blade grinding attachment	50	6000	300	CH	1	6.258 267
POLYMIX® PX-MFC 90 D	Blade grinding attachment	50	6000	300	UK	1	6.312 153

Sieves 0.2 to 6.0 mm also available.

Suitable accessories can be found in our online shop.

1



6.241 371

E & OE.

1 Planetary Ball Mill BM40



1

For rapid grinding of soft, hard, brittle and fibrous materials down to a final fineness of less than 1 µm in laboratories and pilot plants. Also suitable for colloid grinding. Suitable for use in geology, mineralogy, metallurgy, ceramics, materials research, mechanical alloying, pharmacy, chemistry, biology and analysis preparation.

- Grinding platform with 4 stations for up to 8 grinding bowls
- Suitable for continuous operation
- Grinding time digitally adjustable from 0 to 999 minutes
- Variable speed of the sun wheel from 30 to 400 min⁻¹
- For dry and wet grinding
- Programmable grinding parameters
- Automatic reversal of direction to avoid agglomerations
- Ventilated grinding chamber for cooling the grinding bowl
- Control via 7" LCD display with one-button operation
- Safety interlock
- Grinding bowls made of different materials and with different capacities available as accessories



Grinding bowls and balls are not included in the scope of supply and must be ordered separately.

Specifications

Feed size:	<10 mm
Final fineness:	<1 µm, <0.1 µm (colloidal grinding)
Speed range:	30 ... 400 min ⁻¹ (sun wheel)
Effective sun wheel diameter:	360 mm
Performance:	1500 W
Dimensions (W x D x H):	645 x 768 x 621 mm
Weight:	170 kg
Power supply:	220 V, 50 Hz

Type	PK	Cat. No.
Planetary Ball Mill BM40	1	4.669 543

2 Grinding jars and accessories for Planetary Ball Mill BM40



Grinding jars made of agate, sintered aluminium oxide, zirconium oxide and tungsten carbide have a stainless steel casing for safety reasons.

Type	PK	Cat. No.
Grinding jar 50 ml, stainless steel	1	4.669 544
Grinding jar 125 ml, stainless steel	1	4.669 545
Grinding jar 250 ml, stainless steel	1	4.669 546
Grinding jar 500 ml, stainless steel	1	4.669 547
Grinding jar 50 ml, agate	1	4.669 548
Grinding jar 80 ml, agate	1	4.669 549
Grinding jar 125 ml, agate	1	4.669 550
Grinding jar 250 ml, agate	1	4.669 551
Grinding jar 500 ml, agate	1	4.669 552
Grinding jar 50 ml, zirconium oxide	1	4.669 553
Grinding jar 125 ml, zirconium oxide	1	4.669 554
Grinding jar 250 ml, zirconium oxide	1	4.669 555
Grinding jar 500 ml, zirconium oxide	1	4.669 556
Grinding jar 50 ml, sintered aluminium oxide	1	4.669 557
Grinding jar 125 ml, sintered aluminium oxide	1	4.669 558
Grinding jar 250 ml, sintered aluminium oxide	1	4.669 559
Grinding jar 500 ml, sintered aluminium oxide	1	4.669 560
Safety closure device for 80 ml jars made of stainless steel	1	4.669 567
Safety closure device for 125 ml jars made of stainless steel	1	4.669 565
Safety closure device for 250 ml jars made of stainless steel	1	4.669 563
Safety closure device for 500 ml jars made of stainless steel	1	4.669 561
Safety closure device for 125 ml jars made of stainless steel, zirconium oxide, agate, tungsten carbide and aluminium oxide	1	4.669 566
Safety closure device for 250 ml jars made of stainless steel, zirconium oxide, agate and aluminium oxide	1	4.669 564
Safety closure device for 500 ml jars made of zirconium oxide	1	4.669 562
O-ring for 500 ml jars made of agate, aluminium oxide and zirconium oxide (big)	1	4.669 586

2



1 Centrifugal Mill FM200

NEW

For fine grinding, homogenising and mixing of soft, brittle, fibrous and hard samples in the laboratory and pilot plant. The high grinding efficiency is ensured by the high speed rotor and the ring sieve used. A final fineness of less than 100 µm can be achieved. The mill guarantees a high sample throughput and low-noise operation.

- Exchangeable ring sieves
- Variable speed control from 6000 to 18000 min⁻¹
- Simple operation via touch control panel
- Efficient sample cooling
- Ground samples are collected in a pan
- Feed hopper with anti-blocking device
- Motor with overload protection
- Easy cleaning
- No tools required to dismantle the parts in contact with the sample
- Electronic and mechanical safety interlocks
- Comprehensive range of ring sieves and rotors available

Ring sieves and rotors are not included in the scope of supply and must be ordered separately.

Specifications

Feed size:	<10 mm
Final fineness:	<100 µm
Speed range:	6000 ... 18000 min ⁻¹
Rotor diameter:	95 mm
Performance:	760 W
Dimensions (W x D x H):	400 x 456 x 490 mm
Weight:	33 kg
Power supply:	220 V, 50 Hz

Type	PK	Cat. No.
Centrifugal Mill FM200	1	4.669 533

2 Accessories for centrifugal mill FM200

NEW

Type	PK	Cat. No.
Rotor with 6 teeth, stainless steel	1	4.669 534
Rotor with 12 teeth, stainless steel	1	4.669 535
Rotor with 24 teeth, stainless steel	1	4.669 536
Collecting pan, stainless steel	1	4.669 537
Ring sieve with trapezoid holes 0.12 mm, stainless steel	1	4.669 538
Ring sieve with trapezoid holes 0.2 mm, stainless steel	1	4.669 539
Ring sieve with trapezoid holes 0.5 mm, stainless steel	1	4.669 540
Ring sieve with trapezoid holes 1.0 mm, stainless steel	1	4.669 541
Ring sieve with trapezoid holes 2.0 mm, stainless steel	1	4.669 542

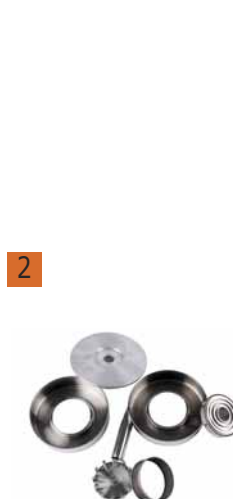

1 Ultra Centrifugal Mill ZM 200

Application:

Extremely rapid and gentle size reduction of soft to medium-hard and fibrous materials. Ideal for grinding, e.g., chemicals, foods and feeds, washing powder, plastics, fertilizers, pharmaceutical raw materials and finished products. Also suitable for cryogenic grinding.

Retsch

Features:

- gentle on the material thanks to 2-step rotor/screen system
- wide speed range, adjustable from 6 000 to 18 000 min⁻¹
- patented cassette system for maximum sample recovery and easy cleaning
- defined final fineness due to ring sieves with aperture sizes from 0.08 to 10 mm
- comfortable safety housing with automatic cover closure
- motor compartment and electronics protected against dust and material penetration
- wide range of accessories with different rotors, ring sieves and cassettes

Specifications:

- Feed size: up to 10 mm
- Final fineness: down to 40 µm
- Batch: up to 300/4500 ml (with cyclone)
- Size (W x D x H): 410 x 365 x 515 mm
- Weight: approx. 38 kg
- Mains connection: 230 V, 50/60 Hz

Supplied with:

ZM 200 with cassette 900 ml.
Rotors and ring sieves have to be ordered separately.

Further rotors and ring sieves on request (e.g. for grinding without heavy metal contamination).

Type	Min. speed rpm	Max. speed rpm	Max. Feed quantity/ Flow rate ml	PK	Cat. No.
ZM 200	6000	18000	5000	1	9.738 970

2 Accessories for Ultra Centrifugal Mill ZM 200

Retsch

Description	PK	Cat. No.
Rotor, stainless steel, 6 teeth	1	9.739 064
Rotor, stainless steel, 12 teeth	1	9.739 065
Rotor, stainless steel, 24 teeth	1	9.739 066
Ring sieve, trapezoid holes 0.20 mm	1	9.738 974
Ring sieve, trapezoid holes 0.50 mm	1	9.738 976
Ring sieve, trapezoid holes 0.75 mm	1	9.738 977
Ring sieve, trapezoid holes 1.00 mm	1	9.738 978
Ring sieve, trapezoid holes 2.00 mm	1	9.738 980
Feeder kit, DR 100, drive unit for 220-240 V, 50 Hz, with feed attachment, with 40 mm push-fit feed chute, funnel and stand	1	9.738 971

Further Ring sieves and rotors available on request.





1 Cross beater mill SK 300

The cross beater mill SK 300 is used for batch-wise or continuous preliminary and fine size reduction. This robust mill is suited for laboratories as well as for the rough conditions of a production environment. Thanks to the powerful drive and rotor speed up to 4000 rpm it is often possible to achieve a final fineness <100 microns in one process. Retsch

Features:

- High throughput for batch-wise size reduction of large sample volumes
- Suitable for feed sizes up to 25 mm
- Adjustable speed from 2000 to 4000 rpm
- Defined final fineness due to bottom sieves with aperture sizes from 0.12 to 10 mm
- Rapid cleaning thanks to easily removable cassette, hopper and push fit rotor
- Ring filter and collecting vessel with convenient, dust-tight bayonet catch
- Quick-action door lock safety lock and electric brake

Function principle:

Size reduction in the SK 300 takes place by impact and shearing effects. The air drawn in through the hopper by the cross beater accelerates the discharge of the ground material. The airborne fine fraction is separated off by a downstream filter system.

Supplied with: Cross Beater Mill with grinding insert, cross beater, baffle plates, filter hose and 5 l collecting vessel.

Bottom sieves and base frame, please order separately.

Feeders and bottom sieves in further sizes are available on request.

Specifications

Feed size:	up to 25 mm
Final fineness:	approx. 0.1 mm
Speed range:	2000 to 4000 rpm
Dimensions (W x D x H) with base frame:	600 x 700 x 1200 mm
Weight:	approx. 57 kg
Power supply:	220-240 V, 50/60 HZ

Type	Material	Min. speed rpm	Max. speed rpm	Max. Feed quantity/ Flow rate ml	PK	Cat. No.
SK 300	hardened steel	2000	4000	5000	1	6.268 112
SK 300	cast iron	2000	4000	5000	1	6.268 113
SK 300	stainless steel	2000	4000	5000	1	6.268 114

Accessories for Cross Beater Mill SK 300

Retsch

Description	PK	Cat. No.
Bottom sieve trapezoid holes 0.12 mm	1	6.268 116
Bottom sieve trapezoid holes 0.20 mm	1	6.268 117
Bottom sieve trapezoid holes 0.25 mm	1	6.268 118
Bottom sieve trapezoid holes 0.50 mm	1	6.268 119
Bottom sieve trapezoid holes 0.75 mm	1	6.268 120
Bottom sieve trapezoid holes 1.00 mm	1	6.268 121
Bottom sieve trapezoid holes 1.50 mm	1	6.268 122
Bottom sieve trapezoid holes 2.00 mm	1	6.268 123
Bottom sieve round holes 3.00 mm	1	6.268 124
Bottom sieve round holes 4.00 mm	1	6.268 125
Bottom sieve round holes 5.00 mm	1	6.268 126
Bottom sieve round holes 6.00 mm	1	6.268 127
Bottom sieve round holes 8.00 mm	1	6.268 128
Bottom sieve round holes 10.00 mm	1	6.268 129
Ring filter for 5 l collecting vessel	1	6.268 130

We can **supply** this
manufacturer's
whole product
range !



1 Mortar Grinder RM 200

Suitable for dry and wet grinding of soft, brittle, hard and paste-like samples. Depending on the sample, amounts from approx. 10 ml up to 190 ml can be reduced in size, triturated and homogenised. With beech wood scraper (special accessory) for pharmaceutical and homeopathic applications. The RM 200 is exceptionally easy to operate and clean. With digital time control and performance display, scale for reproducible pestle setting, built-in automatic switch-off and rapid motor-stop.

Retsch

Please order mortar and pestle separately.

Specifications

Feed size*:	max. 8 mm
Batch size/Feed volume:	10 to 190 ml
Final fineness*:	approx. 10µm
Dimensions (W x D x H):	400 x 370 x 480 mm
Weight: approx:	approx. 24 kg (without grinding set)
Supply requirements:	220 - 240 V 50 HZ



Type	Max. speed rpm	Max. Feed quantity/ Flow rate ml	PK	Cat. No.
RM 200	100	190	1	9.738 170

*depending on feed material

Accessories for Mortar Grinder RM 200

Retsch

Description	PK	Cat. No.
Mortar, hard porcelain	1	9.738 151
Mortar, agate	1	9.738 172
Pestle, hard porcelain	1	9.738 173
Pestle, agate	1	9.738 174

Mortars and pestles made from zirconium oxide, sintered corundum, steel and tungsten carbide are available on request.

2 Cutting Mill CM100M1

NEW

2

For crushing soft, tough, fibrous and hard grinding materials. The mill guarantees a high sample throughput of more than 30 kg/h and can be operated batchwise or continuously. The samples are crushed by the strong cutting and shearing forces. The crushed sample passes through a bottom sieve into the collection bucket.

- Variable speed control from 500 to 3000 min⁻¹
- Simple operation
- Rotor chamber can be quickly locked and easily cleaned
- Low sample heating due to rapid grinding process
- Various bottom sieves and rotors available as accessories
- High work safety due to motor protection switch and motor brake
- Electric safety switch to prevent the mill from starting when rotor chamber is open
- Extensive range of rotors, bottom sieves and further accessories available

Bottom sieves and rotors are not included in the scope of supply and must be ordered separately.

Specifications

Feed size:	<25 mm
Final fineness:	<100 µm
Speed range:	500 ... 3000 min ⁻¹
Throughput:	>30 kg/h
Performance:	1500 W
Dimensions (W x D x H):	590 x 705 x 1400 mm
Weight:	120 kg
Power supply:	220 V, 50/60 Hz



Type	PK	Cat. No.
Cutting Mill CM100M1	1	4.669 630

Suitable accessories can be found in our online shop.

1 Cutting Mill SM 100/200/300

Rapid and gentle size reduction of bulky, soft, medium-hard, fibrous, elastic and thermally sensitive materials. The most powerful model, the SM 300, is especially suitable for cutting heterogeneous mixtures such as household waste, plastic materials, computer and electronic scrap. The mills are also used for organic materials like wood, roots, bones, plants and feed pellets. They can be equipped with various rotors and hoppers. The SM 300 features a variable speed which makes it perfectly adaptable to the particular application requirements.

Retsch

Features:

- powerful size reduction thanks to 3kW drive with high torque and RES technology (SM 300)
- perfect adaptation to application requirements by variable speed from 100 rpm to 3000 rpm (SM 300)
- optimum cutting effects thanks to double acting cutting bars (SM 200, SM 300)
- quick and easy cleaning without tools due to fold-back housing with smooth surfaces and push-fit rotor and sieves (SM 200, SM 300)
- defined final fineness due to bottom sieves with aperture sizes from 0.25 mm to 20 mm
- wide range of accessories including various hoppers, collection systems, rotors and sieves

Supplied with:

SM 100 with 5 L collecting receptacle (Please order rotor, hopper, bottom sieve and base frame separately)

SM 200/SM 300 with 5 L collecting receptacle, base frame (Please order rotor, hopper and bottom sieve separately)

Accessories available on request.

Specifications

Feed size:

Final fineness:

Retractable hopper:

Push-fit rotor:

Speed at 50 Hz:

Drive power:

Mains connection:

SM 100/200/300

up to 60 x 80 mm

0.25 to 20 mm

-/ yes/yes

yes/ yes/yes

1500 rpm

(SM 300) variable 100 to 3000 rpm

1.5/2.2/3kW

3/N~ 400 V, 50 HZ

(SM 300) 220-230 V, 50/60 HZ

Type	Min. speed	Max. speed	Max. Feed quantity/ Flow rate	PK	Cat. No.
	rpm	rpm	ml		
SM 100	1500	1500	30000	1	9.739 069
SM 200	1500	1500	30000	1	9.739 067
SM 300	100	3000	30000	1	9.739 083

Further voltages and versions for heavy-metal free grinding on request.

Suitable accessories can be found in our online shop.

1



Batch mills Tube Mill control/Tube Mill 100 control

1

Suitable for disposable and reusable grinding chambers. By using the disposable grinding chambers the possibility of cross-contamination and the effort of cleaning is eliminated. The mills can be used for hard (Mohs hardness up to 5), dry and brittle materials. They are especially suitable for grinding seeds, such as corn and wheat. Increased safety, the operation of the mill is only possible with properly closed grinding chamber and closed lid.

- Clearly arranged, multilingual OLED-display
- USB interface for control and documentation of all the parameters
- Interval operation available
- Stepless adjustable speed
- Adjustable safety speed and time
- Programmable and storable test conditions
- Reproducible test results
- Timer
- Easy operation with touch keypad
- Dust proof sealed housing
- Quiet operation

IKA



9.737 790

Scope of supply:

Tube Mill control: incl. 1 x grinding chamber MT 40 and MMT 40.1 each

Tube Mill 100 control: incl. 1 x grinding chamber MT 40, MT 100 and MMT 40.1 each

Specifications

Operating principle:	cutting/impact
Motor rating input/output:	100/80 W
Speed:	5000 to 25000 rpm
Chamber volume:	40 ml // 100 ml
Timer:	5 s to 3 min
Interval timer:	5 s to 60 s
Overload protection:	yes
Circumferential speed:	65 m/s
Max. feed hardness:	5 Mohs
Dimensions (W x D x H):	180 x 300 x 170 mm // 180 x 300 x 212 mm
Weight:	2.7 kg // 2.8 kg
IP code:	IP 30
Power supply:	220-240 V, 50/60 Hz

Type	Min. speed rpm	Max. speed rpm	Max. Feed quantity/ Flow rate ml	PK	Cat. No.
Tube Mill control	5000	25000	40	1	9.737 790 1
Tube Mill 100 control	5000	25000	100	1	7.644 727

Accessories for batch mill Tube Mill control/Tube Mill 100 control

IKA

Description	For	PK	Cat. No.
Disposable grinding chamber, 40 ml	Tube Mill control, Tube Mill 100 control	10	9.737 791
Disposable grinding chamber, 40 ml, sterile	Tube Mill control, Tube Mill 100 control	10	4.652 716
Disposable grinding chamber, 40 ml, big pack	Tube Mill control, Tube Mill 100 control	100	6.260 495
Disposable grinding chamber, 100 ml	Tube Mill 100 control	10	6.285 802
Disposable grinding chamber, 100 ml, sterile	Tube Mill 100 control	10	6.310 247
Disposable grinding chamber, 100 ml, big pack	Tube Mill 100 control	50	7.644 728
Grinding chamber, multi use, 40 ml	Tube Mill control, Tube Mill 100 control	1	7.639 994
Grinding chamber, multi use, 100 ml	Tube Mill 100 control	1	6.273 032
Spare parts set for grinding chambers, multi use*	Tube Mill control, Tube Mill 100 control	1	4.653 944
Disposable grinding chamber, 40 ml, 45° bended beater	Tube Mill control, Tube Mill 100 control	10	4.668 552
Disposable grinding chamber, 40 ml, 45° bended beater, big pack	Tube Mill control, Tube Mill 100 control	100	6.274 501

*Supplied with: 100 x sealing, 10 x beater, 10 x coupling

1 Grinding mill, A 10 basic

Newly designed batch mill for grinding of hard, brittle, soft and fibrous materials for volumes up to 50 ml. Because samples may be embrittled directly in the grinding chamber; tough, oily and aqueous samples can also be grinded. During development of the mill, particular emphasis was placed on safety. The mill will only start when the lid is closed and it can only be opened at standstill. A quick stop feature further increases the safety of user.

IKA

- Digital timer
- Counter: Display of grinding time
- Interval operation
- Brushless motor for long life and low noise
- Integrated cooling connections
- Error Code Display
- Easy handling with keypads
- Easy exchangeable beater/cutter for a variety of applications
- Grinding chamber reduction for small sample amounts (included with delivery)
- Easy opening and closing of the lid with a bayonet lock

Specifications

Motor rating input/output:	300/240 W
Speed:	25 000 rpm
Chamber vol.:	50 ml
Power-on time ON/OFF:	5/10 min
Auto power off:	yes
Tangential speed:	73m/s
Max. sample granule size:	6 mm
Dimensions (W x D x H):	130 x 145 x 250 mm
Weight:	2.9 kg
IP code:	IP 41
Supply requirements:	220 - 240 V 50/60 Hz

Type	Max. speed rpm	Max. Feed quantity/ Flow rate ml	Plug type	PK	Cat. No.
A 10 basic	25000	50	EU	1	4.653 943
A 10 basic S2	25000	50	UK	1	6.265 902
A 10 basic S3	25000	50	CH	1	6.265 903

2 Accessories for Grinding mill, A10 basic

A 10.1 Cutter, stainless steel: For most brittle materials with a Mohs hardness up to 5.

IKA

A 10.3 Cutter, hard metal: Made from tungsten carbide for hard materials with a Mohs hardness up to 9.

A 10.2 Star-shaped Cutter, stainless steel: For specific lightweight materials like paper, dried plant parts, plastics and for smooth-elastic materials.

A 10.4 Grinding chamber reduction: For small grinding volumes.

Type	Description	PK	Cat. No.
A 10.1	Cutter, stainless steel	1	6.265 588
A 10.3	Cutter, hard metal	1	6.265 589
A 10.2	Star-shaped cutter, stainless steel	1	6.265 590
A 10.4	Grinding chamber reduction	1	6.265 591

1



2



1 Grinding mill, A11 basic

Batch mill for 2 different grinding procedures:

IKA

- Impact grinding of hard, brittle or non-elastic grinding materials with high-grade stainless steel beater. This beater can be used for a Mohs hardness up to 6 (incl. with delivery). Cutting grinding for pulverizing soft, fibrous materials with a cutting blade (not incl. with delivery).
- Moist and gluey materials can be pulverized by adding water
- Grinding chamber made of Tefcel (PTFE, glass fibre-reinforced) with stainless steel inlet (1.4571), useful volume 80 ml (incl. with delivery).
For embrittlement of grinding materials with liquid nitrogen in the grinding chamber
- Optionally, a 250 ml grinding chamber is available

Specifications

Motor rating input/output:	160/100 W
Speed:	28000 rpm (off load)
Chamber vol.:	80 ml
Power-on time ON/OFF:	1/10 min
Auto power off:	yes
Tangential speed:	53 m/sec.
Max. sample granule size:	10 mm
Dimensions (W x D x H):	85 x 85 x 240 mm
Weight:	1.5 kg
IP code:	IP 43
Supply requirements:	230 V 50/60 HZ
Tested to DIN EN IEC 61010-1.	

Type	Max. speed rpm	Max. Feed quantity/ Flow rate ml	Plug type	PK	Cat. No.
A 11 basic	28000	80	EU	1	9.737 801
A 11 basic	28000	80	UK	1	6.202 305

Accessories please order separately.

Accessories for Grinding mill, A11 basic

A 11.1 Spare beater: For pulverising substances with a Mohs hardness up to 6.

IKA

A 11.2 Cutter: For pulverising soft, fibrous grinding materials.

A 11.3 Beater, hard metal: For pulverising substances with a Mohs hardness up to 9, chrome-carbide coated

A 11.4 Grinding container, 250 ml: Made of polycarbonate with stainless steel inlet. Not suitable for cooling with N₂, only applicable with double beater A 11.6.

A 11.5 Spare grinding container, 80 ml: Made of Tefcel (PTFE, glass fiber-reinforced) with stainless steel inlet. Excellent resistance to chemicals and low temperatures (- 200 °C).

A 11.6 Double beater: For use up to Mohs hardness 3. Only applicable with grinding chamber A 11.4.

A 11.7 Funnel: Prevents splashing by pouring in liquid nitrogen in the grinding chamber A 11.5.

Type	Description	PK	Cat. No.
A 11.1	Spare beater	1	9.737 815 ²
A 11.2	Cutter	1	9.737 806
A 11.3	Beater	1	9.737 807
A 11.4	Grinding container, 250 ml	1	9.737 805
A 11.5	Spare grinding container, 80 ml	1	9.737 816 ³
A 11.6	Double beater	1	9.737 817
A 11.7	Funnel	1	9.737 818

1



2



9.737 815

3



9.737 816

1



1 Universal mill M20

Batch mill suitable for dry grinding of hard and brittle substances.

IKA

- Double-walled grinding chamber can be cooled with water through two hose adapters
- Removable grinding chamber, easy to clean
- Two grinding chambers can be alternately operated using one drive
- M 21 blade incl. with delivery

Specifications

Motor rating input/output:	440/225W
Speed:	max. 20000 rpm. off load
Overload protection:	current limiter
Throughput/Charge max:	250 ml
Material:	stainless steel (AISI 304)
Feed size:	max. 5 to 7 mm
Dimensions (W x D x H):	170 x 170 x 350 mm
Weight:	6.6 kg
Supply requirements:	230 V 50/60 HZ
IP code:	IP 21
Tested to DIN EN IEC 61010-1.	

Type	Max. speed rpm	Max. Feed quantity/ Flow rate ml	Plug type	PK	Cat. No.
M 20	20000	250	EU	1	9.737 828
M 20	20000	250	UK	1	4.007 942

2



4.664 746

Universal mill MultiDrive basic/control

Universal mill for the pre- and fine comminution of hard, soft or fibrous samples.

IKA

- Adjustable interval operation
- Integrated cooling in the grinding bowl
- Ground product and coolant remain disconnected
- USB interface

MultiDrive control additionally with:

- Temperature measurement and vessel recognition using RFID
- Temperature limit can be set for temperature-sensitive materials, or for specific planned reactions
- Integrated weighing function for weighing without transferring the material
- Dispersion vessel and a disposable tube are available as accessories

Please order vessels separately.

Specifications

Motor rating input/output:	1.000/800 W
Speed:	3.000 ... 20.000 rpm
Throughput/Charge max:	250 ... 2000 ml
Feed size:	7 mm
Feed material hardness:	5 Mohs
Feed material hardness with hard metal beater:	9 Mohs
Dimensions (W x D x H):	300 x 250 x 450 mm
Weight:	10 kg
Power supply:	220 ... 240 V
IP code:	IP 31

3



4.664 747

Type	Min. speed rpm	Max. speed rpm	Max. Feed quantity/ Flow rate ml	PK	Cat. No.
MultiDrive basic	3000	20000	2000	1	4.664 746 2
MultiDrive control	3000	20000	2000	1	4.664 747 3

Vessels for Universal mill MultiDrive basic/control

1

2

IKA



4.664 751



4.664 754

Type	Description	Nominal capacity	Material feed size	Material	For	PK	Cat. No.
		ml	mm				
BL 2000	Blender vessel with knife	2000	50.0	PCTG	basic/control	1	4.664 748
BL 2000 T	Blender vessel with knife*	2000	10.0	PCTG	control	1	4.664 749
MI 250	Milling chamber with beater	250	7.0	stainless steel	basic/control	1	4.664 750
MI 400	Milling chamber with beater	400	7.0	stainless steel	basic/control	1	4.664 751 1
MI 250 T	Milling chamber with beater*	250	10.0	PCTG	control	1	4.664 752
MI 400 T	Milling chamber with beater*	400	10.0	PCTG	control	1	4.664 753
DI 2000 T	Dispersing vessel*	2000		PCTG	control	1	4.664 754 2

*temperature sensor

3 Knife mill HM100

NEW

3

The HM100 knife mill is used for grinding soft, medium-hard, brittle and fibrous materials. Especially suitable for samples with a high water, oil or fat content. The 2 knives are driven by a 900 W motor to achieve a reliable grinding result. Suitable for applications in agriculture, biology, medicine and food technology.

- For soft, elastic, fibrous, aqueous, oily or fatty samples
- Electronically controlled speed
- Samples are grinded in only 10 to 30 seconds
- Up to 700 ml sample volume
- Autoclavable grinding vessels
- Grinding vessels available in various materials
- Cutting knives with 2 stainless steel and titanium blades available
- Easy operation
- Quick start
- Coarse and fine grinding in one step
- Interval, reverse and manual mode available

Scope of supply: Knife mill, 1 l grinding vessel made of plastic (autoclavable), lid, stainless steel knife



Specifications

Feed size:	40 mm
Feed quantity:	50 ... 700 ml
Ult. fineness:	<300 µm
Timer:	1 s ... 10 min
Motor speed:	2000 ... 10000 min ⁻¹
Power consumption:	900 W
Dimensions (W x D x H):	260 x 343 x 454 mm
Weight:	16 kg
Power supply:	220 V, 50 Hz

Type	PK	Cat. No.
HM100	1	4.669 516

Accessories for knife mill HM100

NEW

Grinding vessels, lids, blades and scrapers for use with knife mill HM100.

Description	PK	Cat. No.
Grinding vessel 1 l, transparent plastic, autoclavable	1	4.669 517
Grinding vessel 1 l, stainless steel	1	4.669 518
Grinding vessel 1 l, PP	1	4.669 519
Grinding vessel 1 l, PP	10	4.669 520
Grinding vessel 1 l, glass	1	4.669 521
Standard lid for all grinding vessels 1 l, PP	1	4.669 522
Gravity lid for PP/plastic grinding vessel 1 l, PP	1	4.669 523
Gravity lid for PP/plastic grinding vessel 1 l, with overflow channels, PP	1	4.669 524
Reduction lid for chamber reduction of PP/plastic vessels to 0.3 l, polycarbonate	1	4.669 525
Reduction lid for chamber reduction of PP/plastic vessels to 0.5 l, polycarbonate	1	4.669 526
Gravity lid for stainless steel grinding vessels, PP	1	4.669 527
Gravity lid for stainless steel grinding vessels, with overflow channels, PP	1	4.669 528
Stainless steel knife	1	4.669 529
Titanium knife	1	4.669 530
Stainless steel knife with serrated blades	1	4.669 531
Scraper	1	4.669 532

1 Knife mill PULVERISETTE 11

NEW

Fritsch

For reproducible homogenisation of all common samples in food or feed testing, pharmaceuticals, chemicals and many other applications. The quietly operating knife mill is ideal for gentle grinding and homogenisation of moisty, oily and greasy as well as dry, soft, medium-hard and fibrous samples within seconds.

- Motor power up to 1250 Watt
- Variable speed setting with turbo function
- Standard, reverse and interval operation
- Knife blades with 4 cutting edges, up to 56000 cuts per minute
- Feed quantity up to 1400 ml (depending on material)
- Average grinding time only 30 seconds (depending on material)
- Fast cryogenic grinding
- 20 SOPs can be stored, USB interface for SOP management and generation of grinding reports
- Easy cleaning
- Sample-contacting parts such as grinding containers, lids and knives can be autoclaved

Scope of supply: Knife mill, grinding container 1.4 l made of polycarbonate, standard lid, standard knife made of stainless steel

Specifications

Max. feed size:	40 mm
Final fineness:	<300 µm
Speed range:	2000 ... 10000 min ⁻¹ , turbo function up to 14000 min ⁻¹ for 6 s
Performance:	1250 W
Dimensions (W x D x H):	320 x 430 x 480 mm
Weight:	17.6 kg
Power supply:	200 ... 240 V, 50/60 Hz

Type	PK	Cat. No.
PULVERISETTE 11	1	6.275 093

2 Accessories for knife mill PULVERISETTE 11

NEW

Fritsch

Type	PK	Cat. No.
Standard grinding vessel, polycarbonate, 1.4 l, autoclavable	1	4.671 954
Grinding vessel, stainless steel, 1.4 l, autoclavable	1	4.671 955
Standard lid for grinding vessel, silicone, autoclavable	1	4.671 956
Vario-Lid system for moist, liquid and viscous samples, incl. plunger and reduction sample pusher, autoclavable	1	4.671 957
Reduction sample pusher for dry, solid samples for Vario-Lid system, incl. plunger, autoclavable	1	4.671 958
Special lid, for cryogenic comminution with single-use sieve insert for grinding vessel made of stainless steel, autoclavable	1	4.671 959
Single use sieve inserts for special lid, set of 10	1	4.671 960
Standard knife, stainless steel, autoclavable	1	4.671 961
Sickle knife with serrated blades, stainless steel, autoclavable	1	4.671 962

Grinding vessels in further materials, sickle knives with different cutting edges and various materials, single-use grinding vessel as well as further accessories are available.



1 Knife Mills GRINDOMIX GM 200/GM 300



Retsch

The Knife Mills Grindomix GM 200 and GM 300 are suitable for the rapid and reproducible size reduction and homogenisation of food and feed materials. They can process substances with a high water, oil or fat content just as quickly and reliably as dry, soft and medium-hard products.

Features:

- Very fast and reproducible grinding and homogenisation of foodstuffs, final fineness < 300 µm
- Speed-controlled industrial motor
- Autoclavable grinding tools
- Boost function allows short-term increase of speed up to 14.000 rpm (GM 200)
- For sample volumes up to 700 ml (GM 200) or 4500 ml (GM 300)
- Digital display of grinding time and speed
- Interval operation possible
- Optional gravity lid for automatic adjustment of grinding chamber volume
- Storage of 4 program sequences possible (GM 200)
- 8 or 10 parameter combinations can be stored (GM 200/GM 300)
- Drive power: ~ 1000 W (GM 200); continuous 1.1 kW, short term peak 3 kW (GM 300)
- Electrical supply data: 220-240 V, 50-60 Hz

Supplied with:

- GM 200** complete with 1 L plastic container, standard lid and stainless steel knife.
- GM 300** complete with 5 L plastic container, standard lid, stainless steel knife and scraper.

1



Type	Min. speed rpm	Max. speed rpm	Max. Feed quantity/ Flow rate ml	PK	Cat. No.
GM 300	500	4000	5000	1	9.738 500
GM 200	2000	14000	700	1	6.310 086

2 Disc Mill DM 200

Retsch

For preliminary and fine grinding of medium-hard and hard-brittle substances in batches. Grinding discs are available in 4 different materials. **Please order grinding discs separately.**

- Accurate gap width setting
- Connector for dust extraction

Specifications

Feed size:	up to 20 mm
Ultimate fineness:	up to 0.1 mm
Capacity:	2.5 l
Dimensions (W x D x H):	440 x 400 x 870 mm
Weight:	140 kg
Power supply:	3/N~ 400 V, 50/60 Hz

2



Type	Min. speed rpm	Max. speed rpm	Max. Feed quantity/ Flow rate ml	PK	Cat. No.
DM 200	440	528	2500	1	9.739 030

Accessories for Disc Mill DM 200

Retsch

Type	PK	Cat. No.
Grinding discs - hardened steel	1	9.739 031
Grinding discs - manganese steel	1	9.739 032
Grinding discs - tungsten carbide	1	9.739 033
Grinding discs - zirconium oxide	1	9.739 034

1 Micro Ball Mill GT300

NEW

For grinding and mixing of hard, medium-hard, soft, elastic and fibrous samples. Also suitable for cell disruption and DNA/RNA extraction. The mill is designed for very short processing times and high sample throughput. The grinding containers carry out horizontal, circular-arc-shaped oscillations and the grinding balls ensure effective grinding and mixing of the sample.

- Only 30 seconds average processing time
- 2 grinding stations for bowls with a volume of 5 to 50 ml
- Multifunctional clamping device, which also holds adapters for reaction vessels
- Grinding time digitally adjustable from 1 second to 100 minutes
- Variable speed from 180 to 1800 min⁻¹
- Control via LCD display
- Programmable grinding parameters, up to 10 programs can be stored
- Transparent cover
- Safety interlock
- Grinding chamber, clamping system and swivel arm made of stainless steel
- Maintenance-free direct drive
- Grinding bowls made of different materials with volumes up to 50 ml available as accessories

Grinding bowls and balls are not included in the scope of supply and must be ordered separately.

Specifications

Feed size:	<10 mm
Sample volume:	0.2 ... 50 ml
Final fineness:	<5 µm
Timer:	1 s ... 99:59 min
Grinding programs:	10
Vibration frequency:	180 ... 1800 min ⁻¹
Number of grinding stations:	2
Performance:	200 W
Dimensions (W x D x H):	380 x 480 x 281 mm
Weight:	34 kg
Power supply:	220 V, 50 Hz

Type	PK	Cat. No.
Micro Ball Mill GT300	1	4.669 587

2 Accessories for Micro Ball Mill GT300

NEW

Type	PK	Cat. No.
Grinding jar 25 ml, hardened steel	1	4.669 588
Grinding jar 5 ml, stainless steel	1	4.669 589
Grinding jar 10 ml, stainless steel	1	4.669 590
Grinding jar 25 ml, stainless steel	1	4.669 591
Grinding jar 35 ml, stainless steel	1	4.669 592
Grinding jar 50 ml, stainless steel	1	4.669 593
Grinding jar 10 ml, agate	1	4.669 594
Grinding jar 10 ml, zirconium oxide	1	4.669 595
Grinding jar 25 ml, zirconium oxide	1	4.669 596
Grinding jar 35 ml, zirconium oxide	1	4.669 597
Jar wrench	1	4.669 598
Gasket for 25 ml grindig jars made of stainless steel	1	4.669 599
Gasket for 35 ml grindig jars made of stainless steel	1	4.669 600
Gasket for 50 ml grindig jars made of stainless steel	1	4.669 601
Gasket for 25 ml grindig jars made of zirconium oxide	1	4.669 602
Gasket for 35 ml grindig jars made of zirconium oxide	1	4.669 603

1

2

Mixer Mills MM 400/500

The mixer mills are true laboratory "all-rounders". They have been developed specially for grinding, homogenising and mixing of small amounts of sample in only a few seconds. They are also perfectly suitable for the disruption of biological cells as well as for DNA/RNA recovery.

Retsch

1 Mixer Mills MM 400



The MM 400 can also be used for cryogenic and wet grinding.

- Grinding by impact and friction, for up to 20 samples per run
- 3 different grinding modes: dry, wet or cryogenic (MM 400)
- Screw-top grinding jars for leak-proof grinding (MM 400)
- 9 Standard Operating Procedures can be stored

Specifications

Feed size: ≤ 8 mm
 Ultimate fineness: approx. 5 µm
 Charge: max. 2 x 20 ml
 Digital preselection of vibrational frequency: 3 ... 30 Hz (180 ... 1800 rpm.)
 Power supply: 100 ... 240 V, 50/60 Hz



Type	Min. speed	Max. speed	Max. Feed quantity/ Flow rate	No. of grinding stations	PK	Cat. No.
	rpm	rpm	ml			
MM 400	180	1500	40	2	1	9.739 091

2 Grinding Jars for Mixer Mill MM 400

With screw cap.

Retsch

Advantages:

- simple and safe handling
- dust and air-tight
- Suitable for wet and cryogenic grinding

Material	Capacity ml	PK	Cat. No.
Stainless steel	1.5	1	9.738 848
Stainless steel	5.0	1	9.738 849
Stainless steel	10.0	1	9.738 960
Stainless steel	35.0	1	9.738 875
Stainless steel	50.0	1	9.738 885
Agate	5.0	1	9.738 852
Agate	10.0	1	9.738 961
Zirconium oxide	10.0	1	9.738 962
Zirconium oxide	25.0	1	9.738 965
Zirconium oxide	35.0	1	9.738 880
Tungsten carbide	10.0	1	9.738 963
Tungsten carbide	25.0	1	9.738 864
Hardened steel	25.0	1	9.738 869
PTFE	25.0	1	9.738 874
PTFE	35.0	1	9.738 966



3 Mixer Mills MM 500



The MM 500 is suitable for efficiently wet-mill samples to nanosized particles with only minor warming effects.

Retsch

- Suitable for long-term grinding processes up to 99 h
- Memory for 12 SOPs
- 4 program cycles with up to 99 repetitions
- 4.3" touch display

Specifications

Feed size: ≤ 10 mm
 Ultimate fineness: approx. 0.1 µm
 Charge: max. 2 x 45 ml
 Digital preselection of vibrational frequency: 3 ... 35 Hz (180 ... 2100 min⁻¹)
 Power supply: 100 ... 230 V, 50/60 Hz



Type	Min. speed	Max. speed	Max. Feed quantity/ Flow rate	No. of grinding stations	PK	Cat. No.
	rpm	rpm	ml			
MM 500	180	2100	90	2	1	6.313 123

Grinding Jars for Mixer Mill MM 500

NEW

Retsch

- With screw cap
- Screw-Lock jars in sizes up to 125 ml, pressure-tight up to 5 bar

Material	Capacity ml	PK	Cat. No.
Hardened steel	50	1	6.313 125
Hardened steel	80	1	6.313 126
Hardened steel	125	1	6.313 127
Stainless steel	50	1	6.313 128
Stainless steel	80	1	6.313 129
Stainless steel	125	1	6.313 130
Tungsten carbide	50	1	6.313 131
Tungsten carbide	80	1	6.313 132
Zirconium oxide	50	1	4.669 258
Zirconium oxide	80	1	6.313 133
Zirconium oxide	125	1	6.313 134



1 Mixer Mill CryoMill

Retsch

The CryoMill is designed for the cryogenic size reduction of materials which cannot be ground at room temperature or whose composition would be changed by it. The grinding jar is cooled before and during the grinding process with liquid nitrogen through an integrated cooling system. Thus the sample is embrittled and its volatile components are preserved. The size reduction principle is the same as that of the well-proven Mixer Mill MM 400. The CryoMill can also be operated without the cooling system which makes it suitable for a wide range of applications.

- Powerful cryogenic grinding by impact and friction, up to 30 Hz
- Closed LN₂-system (autofill) for enhanced safety, avoids any contact of the user with LN₂
- Screw-top grinding jars for convenient, leak-proof operation
- Clearly structured user interface, memory for 9 SOPs
- Wide range of accessories including LN₂-feeding systems, various jar and ball sizes, adapter racks, materials

Specifications

Feed size	up to 8 mm
Ultimate fineness	< 5µm
Charge	max. 1 x 20 ml
Adjustable frequency range	5 to 30 HZ (300 to 1800 rpm.)
Dimensions (W x D x H)	385 x 675 x 370 mm
Weight	40 kg
Power supply:	100 - 240 V, 50/60 HZ

Type	Min. speed rpm	Max. speed rpm	Max. Feed quantity/ Flow rate ml	PK	Cat. No.
CryoMill	300	1800	20	1	9.739 299

Please order Autofill, grinding jars and grinding balls separately.



2 Grinding Jars for CryoMill

Retsch

Material	Capacity ml	PK	Cat. No.
Stainless steel (to be used with adapter)	5	1	9.739 281
Stainless steel	10	1	9.739 609
Stainless steel	25	1	9.739 611
Stainless steel	35	1	9.739 612
Stainless steel	50	1	9.739 613
Hardened steel (to be used with adapter)	5	1	9.739 287
Hardened steel	25	1	9.739 614
Hardened steel	35	1	9.739 615
Hardened steel	50	1	9.739 616
Zirconium oxide	25	1	9.739 610
PTFE	25	1	9.739 617

1 Planetary Ball Mills PM 100/100 CM/200/400

Planetary Ball Mills are suitable for mixing and grinding soft, medium-hard, extremely hard, brittle and fibrous materials. They are used whenever high degrees of fineness down to the submicron range are to be achieved in a very short time. In addition to dry and wet grinding, they are also suitable for colloidal grinding and mechanical alloying. Typical materials are minerals, ores, chemicals, ceramics, soils, household and industrial waste etc.

Retsch

Features:

- extremely high ultimate fineness down to submicron range
- 1, 2 or 4 grinding stations
- grinding jar volumes from 12 ml to 500 ml
- suitable for long-term trials and continuous use
- programmable starting time
- power failure back-up ensures storage of remaining grinding time
- reproducible results due to digital parameter setting
- 10 parameter combinations can be stored
- single button operation with graphic display
- automatic grinding chamber ventilation for cooling the grinding jars
- grinding jars in 7 sizes and 8 different materials available

Supplied with: Planetary Ball Mill only. Grinding jars and grinding balls have to be ordered separately.

The PM 100 CM is a Planetary Ball Mill with a speed ratio of 1:-1.

Size reduction is not so much achieved by impact but by pressure and friction which is more gentle on the material.

Specifications

Ultimate fineness:	< 1µm
Dimensions (WxDxH):	630 x 415 x 468 mm
PM 400	836 x 780 x 1220 mm
Supply requirements:	230 V, 50-60 HZ

Type	Min. speed	Max. speed	Max. Feed quantity/ Flow rate	No. of grinding stations	PK	Cat. No.
	rpm	rpm	ml			
PM 100	100	650	220	1	1	9.739 270
PM 100 CM	100	650	220	1	1	9.739 275
PM 200	100	650	100	2	1	9.739 271
PM 400	30	400	880	4	1	9.739 274

Please order grinding jars and grinding balls separately.

2 Grinding Jars for Planetary Ball Mills PM 100/100 CM/200/400

Retsch

Material	Capacity ml	PK	Cat. No.
Hardened steel*	500	1	9.738 222
Stainless steel	125	1	9.738 340
Stainless steel*	500	1	9.738 223
Tungsten carbide	50	1	9.738 311
Tungsten carbide*	250	1	9.738 218
Agate	125	1	9.738 345
Sintered aluminium oxide	50	1	9.738 327
Sintered aluminium oxide*	500	1	9.738 226
Zirconium oxide	50	1	9.738 325
Zirconium oxide*	250	1	9.738 221
Zirconium oxide*	500	1	9.738 227
Silicon nitride	125	1	9.738 343
Silicon nitride	250	1	9.738 354
Silicon nitride	500	1	6.267 315

*not suitable for PM 200.

Further grinding jars on request





1

1 Mortar grinder PULVERISETTE 2

For wet and dry grinding of hard, medium-hard, soft, brittle and temperature-sensitive samples for analysis, quality control and materials testing. It even grinds difficult samples with a moist, fibrous or elastic structures using liquid nitrogen. And it's also excellently suited for mixing or homogenisation of organic and inorganic solids or liquids.

Fritsch

- Reproducible and accurate grinding results
- Precise adjustment and readout of the pestle pressure
- Short grinding and mixing times
- Loss and dust free

Max. feed size:	8 mm
Max. sample quantity:	up to 190 ml
Final fineness:	10 ... 20 µm
Supply requirements:	100-120/200-240 V/1~, 50/60 Hz, 300 W
Dimensions (W x D x H):	310 x 460 x 410 mm
Net weight:	24 kg

Type	Min. speed rpm	Max. speed rpm	Max. Feed quantity/ Flow rate ml	PK	Cat. No.
PULVERISETTE 2	70	80	190	1	9.738 200

Mortars and pestles must be ordered additionally.



2

2 Accessories for mortar grinder PULVERISETTE 2

Fritsch

Material	PK	Cat. No.
Grinding set agate	1	9.738 211
Grinding set stainless steel	1	9.738 235
Grinding set hard porcelain	1	9.738 240

Mortars and pestles are also available in sintered corundum, hardmetal tungsten carbide and zirconium oxide.

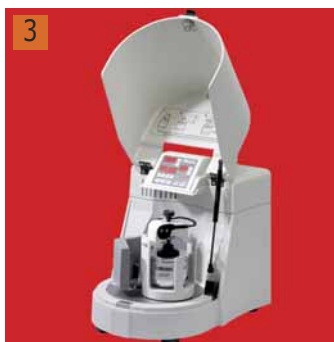

3

Planetary ball mills PULVERISETTE 5/6 classic line

Fritsch

Ideal for fast, loss-free fine grinding of hard, medium-hard, brittle and fibrous materials - dry or in suspension in the areas of geology, mineralogy, metallurgy, ceramics, materials research, mechanical alloying, pharmaceuticals, chemistry, biology, sample preparation for analysis. Sample can be processed from a few mg to several kg at a wide range of fineness levels down to less than 1 µm. They are especially easy to operate and fast and easy to clean. Suitable for continuous, heavy duty usage and guarantee safe clamping of the grinding bowls.

Matching grinding parts of 7 different materials are available to provide max. protection against undesired contamination. In addition to size-reduction, planetary ball mills can also be used for mixing and homogenising of emulsions and pastes or for mechanical alloying and activation.

FRITSCHE also offers a Planetary Mill Generation *premium line*, for fast high-tech grinding down to the nano range, worldwide unique in operation, performance and safety, a new reference class. Information on the Planetary Mill PULVERISETTE 5 *premium line* and Planetary Micro Mill PULVERISETTE 7 *premium line* can be found in the LLG Online Shop.

9.738 300



4

Max. feed size:	10 mm
Final fineness:	< 1 µm
Grinding bowl sizes:	80, 250, 500 ml
Supply requirements:	100-120/200-240 V/1~, 50-60 Hz
Dimensions (W x D x H):	370 x 530 x 500 mm PULVERISETTE 6 classic line 580 x 670 x 570 mm PULVERISETTE 5 classic line

9.738 255

Type	Min. speed rpm	Max. speed rpm	Max. Feed quantity/ Flow rate ml	No. of grinding stations	PK	Cat. No.
Planetary Mill PULVERISETTE 5 classic line - Model I	50	400	900	4	1	9.738 255 4
Planetary Mill PULVERISETTE 5 classic line - Model II	50	400	450	2	1	9.738 257
Planetary Mono Mill PULVERISETTE 6 classic line	100	650	225	1	1	9.738 300 3

Grinding bowls and grinding balls must be ordered additionally.
Further models of planetary mills on request.

1 Grinding bowls for planetary ball mills PULVERISETTE 5/6 classic line

Fritsch

Material	Volume ml	PK	Cat. No.
Hardened, stainless steel	80*	1	9.738 515
Hardened, stainless steel	250	1	9.738 525
Hardened, stainless steel	500	1	9.738 535
Sintered corundum	80*	1	9.738 512
Sintered corundum	250	1	9.738 522
Sintered corundum	500	1	9.738 532
Zirconium oxide	80*	1	9.738 518
Zirconium oxide	250	1	9.738 528
Zirconium oxide	500	1	9.738 538
Hardmetal tungsten carbide**	80*	1	9.738 514
Hardmetal tungsten carbide**	250	1	9.738 524
Adapter for grinding bowls	80	1	9.738 315

* One grinding bowl holder can hold either 2 x 80 ml bowls or 1 x 80 ml bowl together with a grinding bowl adapter mounted one on top of the other.

** Grinding bowl in a steel casing.

Grinding bowls are also available in agate and silicon nitride. Special gassing lids for grinding in an inert atmosphere and for mechanical alloying as well as the GTM-system (Gas pressure and temperature measuring system) for continuous measurement of gas pressure and temperature are available.



2 Grinding balls for grinding bowls PULVERISETTE 5/6 classic line

Fritsch

Material	Ball diam. mm	PK	Cat. No.
Hardened, stainless steel	10	1	9.738 555
Hardened, stainless steel	20	1	9.738 565
Hardened, stainless steel	30	1	9.738 575
Hardened, stainless steel	40	1	9.738 585
Sintered corundum	10	1	9.738 552
Sintered corundum	20	1	9.738 562
Sintered corundum	30	1	9.738 572
Sintered corundum	40	1	9.738 582
Zirconium oxide	10	1	9.738 558
Zirconium oxide	20	1	9.738 568
Zirconium oxide	30	1	9.738 578
Zirconium oxide	40	1	9.738 588
Hardmetal tungsten carbide	10	1	9.738 554
Hardmetal tungsten carbide	20	1	9.738 564
Hardmetal tungsten carbide	30	1	9.738 574
Hardmetal tungsten carbide	40	1	9.738 584

Grinding bowls are also available in agate and silicon nitride.

Grinding balls are also offered in the diameters 0.1 mm to 3 mm (to achieve a fineness down to the nanometer-range) as well as in 5 mm and 15 mm.



3 Disk mill PULVERISETTE 13 classic line

Fritsch

Ideal for intermittent and continuous fine grinding within the medium particle size range of soft to hard, tough and temperature-sensitive solids in the areas of mining and metallurgy, glass industry, ceramics industry, soil research, rocks and soils.

Max. feed size:	20 mm
Throughput:	up to 150 kg/h
Final fineness:	0.1 to 12 mm
Supply requirements:	400 V/3~, 50 Hz, 1790 W
Dimensions (W x D x H):	440 x 870 x 400 mm
Net weight:	140 kg

Type	Min. speed rpm	Max. speed rpm	Max. throughput kg/h	PK	Cat. No.
PULVERISETTE 13 classic line	440	440	150	1	9.739 001

Instrument also available in other voltages.

Fixed and movable grinding disks must be ordered additionally.

The Disk Mill is also available as *premium line* model: even more powerful, safer and easier to operate due to easy reproducible gap width setting via display.



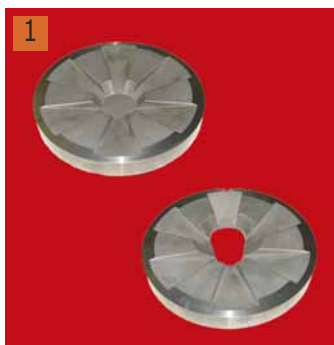

1 Accessories for disk mill PULVERISETTE 13 classic line

Fritsch

Type	Description	PK	Cat. No.
Fixed grinding disk	hardened steel cast	1	9.739 002
Mobile grinding disk	hardened steel cast	1	9.739 003
Fixed grinding disk	zirconium oxide	1	9.739 006
Mobile grinding disk	zirconium oxide	1	9.739 007

Grinding disks are also in manganese steel and hardmetal tungsten carbide available.



2 Variable Speed Rotor Mill PULVERISETTE 14 classic line

Fritsch

Ideal for fast, effective comminution of soft to medium-hard, brittle, fibrous materials, as well as difficult-to-mill and temperature-sensitive samples. Cryogenic grinding, dispersion and homogenisation are also one of the areas of operation. The variable speed rotor mill is an ultra-centrifugal mill with variable speed settings between 6.000 rpm and 20.000 rpm and automatic speed regulation for constant milling in the areas of analytic, biology, chemistry, agriculture and forestry, foodstuffs, plastics and textiles, pharmaceuticals, environment, RoHS. For optimal material feeding the Vibratory Feeder LABORETTE 24 (optional) is recommended.

Max. feed size:	10 mm
Throughput:	up to 5 L/h
Sieve inserts:	0.08 to 6 mm
Final fineness (d ₅₀):	40 µm
Rotor speed:	6.000 to 20.000 rpm
Dimensions (W x D x H):	310 x 480 x 470 mm
Net weight:	23 kg

Type	Min. speed rpm	Max. speed rpm	Max. throughput l/h	Rated capacity kW	Type of auxiliary energy	PK	Cat. No.
PULVERISETTE 14 classic line	6000	20000	5	1.1	200 ... 240 V, 50-60 Hz	1	9.738 277
PULVERISETTE 14 classic line	6000	20000	5	1.1	100 ... 120 V, 50-60 Hz	1	9.738 276

Impact rotor and sieve ring must be ordered additionally.

FRITSCH also offers a Variable Speed Rotor Mill PULVERISETTE 14 premium line with impact, shearing and cutting comminution in one instrument. The premium line version is especially powerful with up to 22.000 rpm, a max. feed size of up to 15 mm and a sample throughput of up to 15 l/h and more. This mill offers significantly better cooling, absolutely safe operation and fast, residue-free cleaning.



3 Accessories for variable speed rotor mill PULVERISETTE 14 classic line

Fritsch

Type	Material	PK	Cat. No.
Impact rotor with 8 ribs	Stainless steel	1	9.738 282
Impact rotor with 12 ribs	Stainless steel	1	9.738 283
Impact rotor with 24 ribs	Stainless steel	1	9.738 284
Sieve ring, trapezoidal perforation 0.08 mm	Stainless steel 316 L	1	9.738 286
Sieve ring, trapezoidal perforation 0.12 mm	Stainless steel 316 L	1	9.738 287
Sieve ring, trapezoidal perforation 0.2 mm	Stainless steel 316 L	1	9.738 288
Sieve ring, trapezoidal perforation 0.5 mm	Stainless steel 316 L	1	9.738 289
Sieve ring, trapezoidal perforation 0.75 mm	Stainless steel 316 L	1	9.738 285
Sieve ring, trapezoidal perforation 1 mm	Stainless steel 316 L	1	9.738 290
Sieve ring, trapezoidal perforation 1.5 mm	Stainless steel 316 L	1	9.738 278
Sieve ring, trapezoidal perforation 2 mm	Stainless steel 316 L	1	9.738 279
Sieve ring, square perforation 2 mm	Stainless steel 316 L	1	4.671 963
Sieve ring, square perforation 4 mm	Stainless steel 316 L	1	4.671 964
Sieve ring, square perforation 6 mm	Stainless steel 316 L	1	4.671 965
Conversion kit for large quantities	-	1	9.738 329
Vibratory feeder LABORETTE 24 for continuous feeding	-	1	9.738 299
Stand for vibratory feeder LABORETTE 24	-	1	9.738 298

Rotors and sieve rings are also available in others designs and materials. An extensive accessory programme with impact bar, pin insert, sample exhauster with Cyclone separators and much more is available for your specific application.

Cutting mills PULVERISETTE 15 and Universal Cutting mills PULVERISETTE 19

Ideal for pre and fine comminution of soft to medium-hard as well as fibrous or brittle, tough materials. They are essential for the areas of plastics, textiles, agriculture and forestry, environmental, construction materials, chemistry and foodstuffs. All cutting parts can be removed for cleaning in just a few seconds without tools, unbeatable fast, simple and efficient. Variable rotational speeds, different rotors, various knife geometries and replaceable blades ensure maximum flexibility and durability. For controlling the abrasion properties, the cutting tools are offered in different materials. The optimum airflow ensures fast comminution and secure protection against clogging. The FRITSCH Cyclone separators (optional) for sample exhaustion enable simple feeding due to the strong airflow, increase throughput, and reduce the thermal load of the samples.

Fritsch



9.738 421

Instruments also available in other voltages.

Funnels, rotors, sieve inserts/sieve cassettes and collecting vessels must be ordered separately.

FRITSCH also offers a Cutting Mill Combination which consists of the Universal Cutting Mill PULVERISETTE 19 and Power Cutting Mill PULVERISETTE 25.

The important effect is that samples with feed particle size of 120 mm max. can be ground to a few 100 µm within a short time and in a single operation. Ordering data on request.

The Universal Cutting Mills PULVERISETTE 19 are also available completely in stainless steel.



4.671 967

NEW: Universal Cutting Mill PULVERISETTE 19 now with variable rotational speed for optimal adjustment of the cutting speed to your sample material

Variable 300-3000 rpm is ideal for fine comminution of dry soft to medium-hard sample materials as well as fibrous materials and plastics.

Variable 50-700 rpm for powerful comminution of hard, tough-elastic and temperature-sensitive samples or an excessively high fine share need to be avoided.

Specifications

Max. feed size:	70 x 80 mm*
Rotation speed:	50 ... 3400 min ⁻¹
Sieve inserts:	0.2 ... 20 mm*

Type	Min. speed	Max. speed	Max. throughput	Feed size	Type of auxiliary energy	Dimensions (W x D x H)	PK	Cat. No.
	rpm	rpm	l/h	mm		mm		
PULVERISETTE 15	2800	3400	50	70	400 V, 50 Hz	420 x 480 x 690	1	9.738 421 1
PULVERISETTE 19	50	700	60	80	380 ... 460 V, 50/60 Hz	440 x 790 x 560	1	4.671 967 2
PULVERISETTE 19	300	3000	60	80	380 ... 460 V, 50/60 Hz	440 x 790 x 560	1	6.314 060

* depending on the instrument type

3 Accessories for cutting mill PULVERISETTE 15

Fritsch

Type	PK	Cat. No.
Rotor with straight cutting edges and fixed knives made of tool steel	1	9.738 424
Protected funnel with sample pusher	1	7.900 140
Collecting vessel, 3.5 L	1	6.231 269
Collecting vessel, 60 L with filter hose	1	9.738 449
Universal support stand for the free mounting of the cutting mills	1	9.738 429
Sieve insert*, trapezoidal perforation 0.25 mm	1	9.738 432
Sieve insert*, trapezoidal perforation 0.5 mm	1	9.738 433
Sieve insert*, trapezoidal perforation 1 mm	1	9.738 435
Sieve insert*, trapezoidal perforation 2 mm	1	9.738 437
Sieve insert*, square perforation 4 mm	1	9.738 441
Sieve insert*, square perforation 6 mm	1	9.738 442

*made of stainless steel

Alternative funnels as well as sieve inserts are also available in other perforations. Rotors as well as the sieve inserts are also offered in chromium-free steel.



4 Accessories for Universal Cutting mills PULVERISETTE 19

Fritsch

Type	PK	Cat. No.
Standard cutting tool with V-cutting edges and fixed knives made of hardened stainless steel	1	9.739 321
Standard funnel for long and bulk solids	1	6.510 319
Collecting vessel, 3 L	1	9.739 350
Large collecting vessel, 10 L	1	9.739 351
Universal support stand for the free mounting of the cutting mills	1	9.738 429
Sieve cassette*, trapezoidal perforation 0.5 mm	1	9.739 331
Sieve cassette*, trapezoidal perforation 1 mm	1	9.739 333
Sieve cassette*, trapezoidal perforation 2 mm	1	9.739 335
Sieve cassette*, square perforation 4 mm	1	9.739 340
Sieve cassette*, square perforation 6 mm	1	9.739 341

*made of stainless steel

Alternative funnels, cutting tools in other materials and designs, sieve cassettes in other perforations and materials as well as further stands and Cyclone separators in various configurations for sample exhaustion are available.





1 Jaw Crusher, BB 50

Benchtop Jaw Crusher for the rapid and gentle, coarse and preliminary size reduction of hard, brittle and ductile materials. Continuous digital gap width adjustment with scale, enhanced ultimate fineness up to 0.5 mm.

Retsch

- Large fold-back hopper
- Removable crusher arm for easy cleaning
- Adjustable speed allows adaptation to sample characteristics
- Convenient operating keypad with digital display
- Memory for gap width setting
- Wear compensation with zero-point adjustment

Features:

- Throughput/charge: single items, charges to 3000 ml
- Supply requirements: 220-240 V, 50 HZ

Type	Max. Feed quantity/ Flow rate ml	Material breaking jaws	PK	Cat. No.
BB 50	3000	Manganese steel	1	9.738 770
BB 50	3000	Stainless steel	1	9.738 771
BB 50	3000	Tungsten carbide	1	9.738 772
BB 50	3000	Zirconia	1	9.738 773
BB 50*	3000	Steel 1.1750	1	9.738 774

* for heavy metal free grinding.

Other power supply variants are available on request at the same price.



2 Jaw Crushers, BB 100, BB 200, BB 300

For rapid and gentle coarse grinding and crushing of hard, brittle and tough materials.

Retsch

Continuous gap adjustment with scale and zero-point adjustment for wear compensation.

Excellent performance with enhanced final fineness, robust construction, fitted with quick-release hopper, receiver with safety switch and casing. Standard model is supplied with manganese steel breaking jaws.

Features:

- High throughput
- Continuous gap width adjustment
- Braking motor with safety switch
- Final fineness approx. 2 to 5 mm
- Easy cleaning of grinding chamber
- Supply requirements 400 V 3-ph, 50 Hz

Type	Max. Feed quantity/ Flow rate ml	PK	Cat. No.
BB 100	2000	1	9.739 098
BB 200	5000	1	9.519 120
BB 300	35400	1	9.739 093



3 Jaw crushers PULVERISETTE 1 classic line (2 Models)

Ideal for fast batchwise or continuous pre-crushing of very hard to medium-hard, brittle

Fritsch

and tough materials in the areas of mining and metallurgy, chemistry, geology and

mineralogy, glass industry, ceramics industry, rocks and soils. The final fineness can be easily set from the outside (10 different stages are possible).

Scope of supply:

With crushing jaws and lateral support walls made of tempered steel. Crushers are also available in other voltages and with crushing jaws and lateral support walls made of stainless steel, chromium-free steel, hardmetal tungsten carbide, zirconium oxide and manganese steel

Max. feed size:	Model I // Model II approx. 60 mm // approx. 95 mm
Throughput:	up to 140 kg/h // up to 200 kg/h
Gap widths (final fineness):	1 to 15 mm // 1 to 15 mm
Supply requirements:	400 V/3~, 50 Hz // 400 V/3~, 50 Hz
Dimensions (W x D x H):	400 x 800 x 800 mm // 400 x 800 x 800 mm
Net weight:	177 kg // 205 kg

Type	Rating W	PK	Cat. No.
PULVERISETTE 1 classic line, Modell I	1340	1	9.519 213
PULVERISETTE 1 classic line, Modell II	2600	1	9.519 223

The Jaw Crushers PULVERISETTE 1 are also available as *premium line* models with increased performance, even easier to operate and fast cleaning.

1 Analytical Sieve Shakers AS 200 basic/digit/control, AS 300 control, AS 450 basic, AS 450 control

Sieve shakers are used in research & development, quality control of raw materials, interim and finished products as well as in production monitoring.

Retsch

Features:

- Sieving with 3D effect
- For wet and dry sieving
- Short sieving times
- Low-noise, maintenance-free

Please order clamping device, test sieves and collecting pan separately.

AS 200 basic: favourably priced basic model.

AS 200 digit cA: powerful comfort model with touch-sensitive keypad, digital display, interval sieving.

AS 200 control: like AS 200 digit, but microprocessor-controlled, with freely selectable intervals and digital vibration amplitude setting. It can be calibrated and, for the first time, allows 100 % reproducible sieving results worldwide, even if different instruments are used. The AS 200 control has an integrated interface for the evaluation software EasySieve®. At the same time it also offers all the requirements for test materials monitoring according to ISO 9000.

AS 300 control: like AS 200 control; also suitable for sieves up to 315 mm diameter and for higher loads.

AS 450 basic: budget-priced basic model for sieving up to 15 kg of material.

AS 450 control: with CET technology, It is the first Sieve shaker which operates with a three-dimensional sieving motion

Specifications

Max. number of fractions (depending on sieve size):

AS 200, AS 300:	9/17
AS 450 basic:	11/7
Movement of sample:	orbital with vibration
Height of sievetower	
AS 200, AS 300:	up to approx. 510 mm
AS 450 basic:	up to approx. 830 mm
Max. charge/quantity of sample:	
AS 200:	3 kg
AS 300:	6 kg
AS 450 basic:	15 kg
Timer:	
AS 200, AS 300, AS 450:	digital

Type	max. sample amount	min. measuring range	max. measuring range	Dimensions (W x D x H)	PK	Cat. No.
	g	mm	mm	mm		
AS 200 basic	3000	0.02	25	417 x 384 x 212	1	6.282 597
AS 200 digit cA	3000	0.02	25	417 x 384 x 212	1	6.282 666
AS 200 control	3000	0.02	25	417 x 384 x 212	1	6.282 965
AS 300 control	6000	0.02	40	417 x 384 x 212	1	6.283 846
AS 450 basic	15000	0.03	125	680 x 680 x 280	1	6.272 964
AS 450 control	25000	0.03	125	714 x 658 x 435	1	9.739 277





9.739 242

Analytical Sieve Shakers AS 400 control, AS 200 tap/ jet

Retsch

AS 400 control:

- The AS 400 control is used for the sieving of dry goods with test sieves of a diameter up to 400 mm. The uniform, horizontal circular motion ensures exact separation of the product to be sieved.
- Sieving with circular sieving motion according to DIN 53477
 - Free digital adjustment of all process parameters (time, speed, interval)
 - Memory for up to 9 SOPs
 - Integrated interface for evaluation software EasySieve®
 - Electrical supply data: 100-240 V, 50/60 Hz

Please order clamping device, test sieves and collecting pan separately.

The clamping devices of AS 200 and AS 300 are also suitable for the AS 400.

AS 200 tap:

For sieve analysis of certain products such as activated carbon, abrasives, coal, spices and diamonds, as specified in the corresponding standards.

- Horizontal, circular sieving motion with vertical taps
- Suitable for dry sieving
- Robust and maintenance-free
- Electrical supply data: 230 V, 50 Hz

Please order test sieves and collecting pan separately.

AS 200 jet:

The air jet sieving machine AS 200 jet is particularly suitable for light materials with particle sizes in the lower micron range which tend to agglomerate.

- Open Mesh Function to reduce the number of near-mesh particles
- Operation with standard Retsch sieves, 203 mm (8") diameter, 1" or 2" high
- Adapter for 200 mm sieves optional
- Free manual (standard) or automatic (accessory) pressure regulation
- High flexibility through adjustable nozzle speed
- Memory for up to 9 SOPs, additional Quick Start mode
- Electrical supply data: 230 V, 50/60 Hz

Please order test sieve and vacuum cleaner separately.



6.238 239

Specifications

Max. number of fractions (depending on sieve size):

AS 400 control:	7/9/17
AS 200 tap:	7/13
AS 200 jet:	1 (2 with cyclone)

Movement of sample:

AS 400 control:	circular
AS 200 tap:	circular with taps
AS 200 jet:	dispersion by air jet

Height of sievetower

AS 400 control:	up to approx. 450 mm
AS 200 tap:	up to approx. 350 mm
AS 200 jet:	up to approx. 50 mm

Max. charge/quantity of sample:

AS 400 control:	5 kg
AS 200 tap:	3 kg
AS 200 jet:	0.3 to 100 g
Timer:	digital

Type	max. sample amount g	min. measuring range mm	max. measuring range mm	PK	Cat. No.
AS 400 control	5000	0.04	63	1	9.739 242 1
AS 200 tap	3000	0.02	25	1	9.739 276
AS 200 tap*	3000	0.02	25	1	6.238 947
AS 200 jet	100	0.01	10	1	6.238 239 2

*with sound protection cabinet

1 Vibratory sieve shaker ANALYSETTE 3 PRO and SPARTAN

For quantitative particle size analysis of dry samples and suspensions of all kind by dry and wet sieving with woven test sieves. FRITSCH Sieve Shakers satisfy all requirements for accurate and reproducible sieving analysis and perform automatic sieve analysis with the control and evaluation software AUTOSIEVE, which is delivered as trial version for 90 days. The top model ANALYSETTE 3 PRO guarantees absolutely reproducible sieving results due to automatic amplitude control, programme selection, can be integrated as testing device into any quality management systems, has an RS232-interface, to mention only some of its innovative and practical features.

Fritsch

Sieving: dry or wet
 Sieve diameters: 100 mm, 200 mm or 8"
 Maximum number of sieves: 10 x 50 mm (full) or 16 x 25 mm (half) height
 Sieves: woven mesh metal sieves
 Measuring range: Dry sieving: 20 µm to 63 mm
 Wet sieving: 20 µm to 10 mm
 Sample quantity: Dry sieving: up to 2 kg (depending on the sample material and sieve used)
 Wet sieving: 20 to 100 g
 Sieving time: Dry sieving: 3 to 20 min
 Wet sieving: 3 to 10 min
 Power supply: 100-240 V/1~, 50-60 Hz, 50 W
 Dimensions (W x D x H): 370 x 400 x 200 mm
 Net weight: 21 kg



Type	max. mass of sieve stack	min. measuring range	max. measuring range	PK	Cat. No.
	g	mm	mm		
ANALYSETTE 3 PRO	3000	0.02	63	1	9.826 402
ANALYSETTE 3 SPARTAN	3000	0.02	63	1	9.826 403

Clamping lid, sieve pan and sieves must be ordered separately.
 Further sieve shakers available on request.

Suitable accessories can be found in our online shop.

2 Grindometer

For sieving. Acc. to ISO 1524. Further measuring ranges available on request.

TQC

Measuring range	Increments	Width	PK	Cat. No.
µm	µl	mm		
0-15	1,5	2 groove: 2 x 12 mm	1	6.229 382
0-25	2,5	2 groove: 2 x 12 mm	1	9.149 842
0-50	5	2 groove: 2 x 12 mm	1	9.149 843
0-100	10	2 groove: 2 x 12 mm	1	9.149 844



Test Sieves

Features:

- Previously unattained product quality owing to advanced manufacturing processes and continuous optical inspection.
- High quality joining technology guarantees permanently taut wire mesh.
- High level of corrosion resistance and easy to clean owing to the use of high-alloy stainless steel.
- "one-piece cast" sieve frame and seamless mesh joint prevent cross contamination.
- Maximum stability and optimum density of the sieve stack.
- 15 % lighter than traditional sieves whilst at the same time having larger sieving area.
- Clear sieve marking and traceability by individual laser engraving on each sieve.

Retsch

1 Test Sieves, 200 x 50 mm

Retsch

Mesh size μm	PK	Cat. No.
20	1	9.226 650
25	1	9.226 651
32	1	9.226 652
36	1	9.226 653
38	1	9.226 654
40	1	9.226 655
45	1	9.226 656
50	1	9.226 657
53	1	9.226 658
56	1	9.226 659
63	1	9.226 660
71	1	9.226 661
75	1	9.226 662
80	1	9.226 663
90	1	9.226 664
100	1	9.226 665
106	1	9.226 666
112	1	9.226 667
125	1	9.226 668
140	1	9.226 669
150	1	9.226 670
160	1	9.226 671
180	1	9.226 672
200	1	9.226 673
212	1	9.226 674
224	1	9.226 675
250	1	9.226 676
280	1	9.226 677
300	1	9.226 678
315	1	9.226 679
355	1	9.226 680
400	1	9.226 681
425	1	9.226 682
450	1	9.226 683
500	1	9.226 684
560	1	9.226 685
600	1	9.226 686
630	1	9.226 687
710	1	9.226 688
800	1	9.226 689
850	1	9.226 690
900	1	9.226 691



2 Sieving aids

For difficult to separate materials which require dry sieving. Different aids are used according to mesh size.

Retsch

Type	PK	Cat. No.
Steatite ball, 6 mm dia., 150g	1	9.739 238
Nylon brushes (pack of 3)	1	9.826 131
Vulkollan cube 12 x 12 x 12 mm	10	9.826 132
Rubber ball, 20 mm dia.	5	9.826 133
Agate ball, dia. 10 mm	10	9.826 134
Test sieve rack for max. 10 sieves up to 203 mm dia., 50 mm height	1	9.739 243

1 Test Sieves, 200 x 50 mm

DIN ISO 3310-1. Dimensions (dia. x h): 200 mm x 50 mm.
Test sieves with height 25 mm available on request.

Retsch

Aperture size mm	PK	Cat. No.
1.00	1	9.226 692
1.12	1	9.226 693
1.18	1	9.226 694
1.25	1	9.226 695
1.40	1	9.226 696
1.60	1	9.226 697
1.70	1	9.226 698
1.80	1	9.226 699
2.00	1	9.226 700
2.24	1	9.226 701
2.36	1	9.226 702
2.50	1	9.226 703
2.80	1	9.226 704
3.15	1	9.226 705
3.35	1	9.226 706
3.55	1	9.226 707
4.00	1	9.226 708
4.50	1	9.226 709
4.75	1	9.226 710
5.00	1	9.226 711
5.60	1	9.226 712
6.30	1	9.226 713
6.70	1	9.226 714
7.10	1	9.226 715
8.00	1	9.226 716
9.00	1	9.226 717
9.50	1	9.226 718
10.00	1	9.226 719
11.20	1	9.226 720
12.50	1	9.226 721
13.20	1	9.226 722
14.00	1	9.226 723
16.00	1	9.226 724
18.00	1	9.226 725
19.00	1	9.226 726
20.00	1	9.226 727
22.40	1	9.226 728
25.00	1	9.226 729
26.50	1	9.226 730
28.00	1	9.226 731
31.50	1	9.226 732
35.50	1	9.226 733
37.50	1	9.226 734
40.00	1	9.226 735
45.00	1	9.226 736
50.00	1	9.226 737
53.00	1	9.226 738
56.00	1	9.226 739
63.00	1	9.226 740
71.00	1	9.226 741
75.00	1	9.226 742
80.00	1	9.226 743
90.00	1	9.226 744
100.00	1	9.226 745
106.00	1	9.226 746
112.00	1	9.226 747
125.00	1	9.226 748



2 Analytical Sieve Test Sand

Test materials can be used to check analytical sieves between the scheduled calibration dates and to demonstrate the presence of the required properties, as well as the suitability of analytical sieves. A test material for analytical sieves with frequent mesh widths (2.0 mm - 1.0 mm - 0.5 mm - 0.25 mm - 0.125 mm).

- Pack of 3 bottles, 202 g each
 - Grain size : from 0.125 mm to 2.00 mm
 - Data sheet for the use of traceability for analytical sieves
- Each bottle contains a mixture of different sizes.

Normensand

Description	PK	Cat. No.
Analytical Sieve Test Sand	3	9.739 500



Ultrasonic Baths, SONOREX SUPER

Heavy duty ultrasonic baths for cleaning or sample treatment in aqueous liquids. Bandelin
 Suitable for laboratory and respiratory protection area, industry, workshop and service area.
 - Stainless steel tank and housing
 - Drip water protected
 - With integral tank drain tap (G 1/2) for easy emptying (RK 106 with G 1/4)
 - Radio shielded

Models with Type addition H with adjustable temperature range.

Specifications

HF-Frequency: 35 kHz, SweepTec®
 Temperature range: 30 ... 80 °C
 Timer: 1 ... 15 min or continuous
 Power supply: 230 V~, 50/60 Hz
 IP code: IP 32

1

1 Ultrasonic sieve-bath SONOREX SUPER RK 106

Ultrasonic bath for cleaning of 1 test sieve with 200 mm diameter. Bandelin
Please order sieve holder SH 7 separately.

Type	Capacity of the bath litres	Width of the interior mm	Depth of the interior mm	Height of the interior mm	Plug type	PK	Cat. No.
RK 106	5.6	240	240	130	EU	1	9.877 106
RK 106	5.6	240	240	130	UK	1	9.877 105
RK 106	5.6	240	240	130	CH	1	9.877 107

2

2 Ultrasonic sieve-bath SONOREX SUPER RK 1040

Ultrasonic bath for cleaning of 1 test sieve with 500 mm diameter. Bandelin
Please order sieve holder GH 28 separately.

Type	Capacity of the bath litres	Width of the interior mm	Depth of the interior mm	Height of the interior mm	Plug type	PK	Cat. No.
RK 1040	39.5	500	500	195	EU	1	9.877 108

3

3 Ultrasonic sieve-bath Sonorex Super ultrasonic bath RK 1028 C

For 5 test sieves with 200 mm diameter. With handles on both sides. Bandelin
Please order sieve holder SH 28 C separately.

Type	Capacity of the bath litres	Width of the interior mm	Depth of the interior mm	Height of the interior mm	Plug type	PK	Cat. No.
RK 1028 C	45	500	300	300	EU	1	9.877 528
RK 1028 C	45	500	300	300	UK	1	9.877 538
RK 1028 C	45	500	300	300	CH	1	9.877 539
RK 1028 CH	45	500	300	300	EU	1	9.877 530

➔ Accessories please see page 1189.

1 2 Mesh, polyester

Thermo-fixed PE mesh with temperature resistance from -75 °C to +150 °C (short).
For long term heating max. 125 °C. Resistant to acids but not alkalis.
Dimensions: Minimum width 102 cm, Length 100 cm.

Other sizes available on request.

Mesh size µm	PK	Cat. No.
1	1	9.068 210
5	1	9.068 211
6	1	9.068 212
10	1	9.068 213
15	1	9.068 214
20	1	9.068 215
30	1	9.068 216
50	1	9.068 218
60	1	9.068 220
100	1	9.068 224
105	1	9.068 225
150	1	9.068 226
200	1	9.068 227
250	1	9.068 228
300	1	9.068 229

**3 4 Mesh, Polyamide**

Thermo-fixed Polyamide (Nylon) mesh is temperature stable from -40 °C to +115 °C. In water from 95 °C to 100 °C. Stability in acids is limited and dependant on concentration and temperature. Nylon exhibits outstanding stability in alkalis, including sodium and potassium solutions. Its chemical behaviour with respect to organic solvents is moderate to good. Minimum mesh width: 102 cm, Length: 1 m

Other sizes available on request.

Mesh size µm	PK	Cat. No.
1	1	9.068 276
5	1	9.068 277
10	1	9.068 279
20	1	9.068 281
30	1	9.068 282
40	1	9.068 283
50	1	9.068 284
60	1	9.068 285
80	1	9.068 287
90	1	9.068 288
100	1	9.068 289
125	1	9.068 290
150	1	9.068 291
200	1	9.068 292
250	1	9.068 293
300	1	9.068 294
400	1	9.068 295
500	1	9.068 296





1 Sample Splitters, RT series

To provide separation of pourable powders and bulk materials on site and in the laboratory. Operates independently of mains supply. Available in 6 sizes. Number of samples: 2.

Retsch

Type	max. sample size	max. Material feed size	Dimensions (W x D x H)	Net weight	PK	Cat. No.
	ml	mm	mm	kg		
RT 6.5	3000	4	300 x 270 x 250	3.5	1	9.739 200
RT 12.5	3000	8	300 x 270 x 250	3.5	1	9.739 201
RT 25	16000	16	620 x 420 x 260	21.5	1	9.739 202
RT 37.5	16000	25	620 x 420 x 260	21.5	1	9.739 203
RT 50	16000	33	620 x 420 x 260	21.5	1	9.739 204
RT 75	16000	50	620 x 420 x 260	21.5	1	9.739 205



2 Sample Divider PT 100 with vibratory feeder DR 100

Rotary tube divider for the representative sample division with an extremely high division accuracy. Rapid and easy handling of sample vessels thanks to quick-release clamps.

Retsch

Scope of delivery: PT 100 incl. dividing head with 8 quick-release sample outlets, vibratory feeder DR 100/40 and 10 sample bottles (250 ml).

Specifications PT 100

Feed size:	up to 10 mm
Number of samples:	8 (6 or 10 heads also available on request)
Throughput/charge:	up to 5000 ml
Dimensions (W x D x H):	580 x 420 x 910 mm
Weight: approx.:	34 kg
Supply requirements:	230 V, 50 Hz

Type	max. sample size	max. Material feed size	PK	Cat. No.
	ml	mm		
PT 100	5000	10	1	9.739 147



3 Rotary cone sample divider LABORETTE 27

For reliable, representative sample division of solids and suspensions without conversion. Divides the samples at up to 3000 graduations per minute into up to 30 partial streams via a rotating cone head. Dividing accuracy up to 99.9 %. Can be combined with 6 different dividing heads.

Fritsch

- Compact basic unit with robust cast aluminium housing
- Easy cleaning due to removable dividing head
- variable partition ratios
- Maintenance-free drive motor with slipping clutch
- Quick clamping device for sample tubes 250 and 500 ml
- For optimum sample allocation, the vibratory feeder LABORETTE 24 (optional) is recommended.

Specifications

Division ratio:	1:8, 1:10, 1:30
Number of subsamples:	8, 10, 3
Max. feed particle size:	10 mm, 2.5 mm
Max. sample quantity:	4000 ml, 2500 ml, 300 ml
Sample bottle capacities:	15, 20, 30, 32, 250, 500 ml
Power supply:	230 V/1~, 50-60 Hz, 90 W
Dimensions (W x D x H):	270 x 450 x 460 mm
Net weight:	7.7 kg

Type	max. sample size	max. Material feed size	PK	Cat. No.
	ml	mm		
LABORETTE 27	4000	10	1	9.738 310

Instrument also available in other voltages. Dividing heads must be ordered separately.

Suitable accessories can be found in our online shop.

Laboratory presses MP150

With pressure gauge (MP150) or digital pressure display (MP150D).
Press for up to 15 tons pressure. Recommended for press dies up to 18 mm.

Maassen GmbH

Please order press dies separately.

Specifications

Pressure gauge Ø:	80 mm
Pressure:	15 t
Resolution:	0.5 t/0.01 t
Width between pistons:	150 mm
Clear width min./max.:	52 mm/142 mm
Spindle diam.:	36 mm
Spindle path:	90 mm
Piston diameter/Stroke:	107 mm/22 mm
Dimensions (H min./max. x W x D):	436/526 x 370 x 300 mm
Weight:	approx. 43 kg
Power supply MP150D:	ext. power adapter, 12 V



6.290 214

Type	PK	Cat. No.
MP150	1	6.290 214 1
MP150D	1	6.290 215

2 Accessories for Laboratory Presses

- The 13 mm press die is supplied in a wooden box (for 32 and 40 mm: optional)
- The 32 and 40 mm press die can be combined to save costs, since the same parts can be used
- All press dies from 10 mm have a vacuum connection with a special self-locking tubing adapter, which makes it easier to connect and disconnect

Maassen GmbH

Further diameters available on request.



Description	Pressure max. t	PK	Cat. No.
Press die set for Alucups, 40 mm	40	1	4.672 207
Press die set for rings, 40/32 mm (OD/ID)	40	1	4.672 208
Press die set for rings, 40/35 mm (OD/ID)	40	1	4.672 209
Press die set for rings, 51.5/35 mm (OD/ID)	40	1	4.672 210
Press die set, 13 mm in wooden box	10	1	6.290 219
Press die set, 13 mm with hard metal pellets (KXF) in wooden box	14	1	6.290 220
Press die set, 32 mm	30	1	6.290 221

Dispersing unit OV5

For dispersing, homogenising and stirring of biological samples, pharmaceutical products, cosmetics and food.

Velp Scientifica

- Fast assembly of the appropriate rotor/stator combination
- With overload protection, soft start and safety switch
- Large selection of rotors and stators
- Distance between feet: 200 mm

Also available as set:

- Dispersing unit OV5
- Stand with mounting for disperser and sample vessel
- Dispersing tool VSS2CSR2 for dispersing solid/liquid systems. Suitable for the ceramic, pharmaceutical and petrochemical industry as well as for waste water treatment

Specifications

Motor rating:	500 W
Working volume (homogenisation):	8 l
Working volume (high speed stirring):	40 l
Viscosity max.:	10000 mPas
Speed display:	Scale
Speed range:	10000 ... 30000 min ⁻¹
Dimensions:	70 x 70 x 255 mm
Weight:	1.3 kg
Power supply:	230 V, 50 Hz
Warranty:	3 years



4.666 710

Type	PK	Cat. No.
OV5	1	4.666 710 3
OV5 set	1	4.666 728 4



4.666 728

1

1 Homogeniser, handheld, POLYTRON® PT 1200 E (Eco Line)

KINEMATICA

This ergonomic handheld homogeniser is ideal for quick processing of small sample quantities and volumes. The ergonomic design and low weight of the PT 1200 E makes it easy for repeated usages. There are many different styles of aggregates available from 3 mm in diameter for volumes down to 0.01 ml to 12 mm for volumes up to 250 ml. If cross contamination from sample to sample is a concern, we offer single use synthetic aggregates in 7 and 12 mm diameters. One of the more recent additions to our line is the PT-DA 20/2 X EC aggregate which was specifically designed for tablets.

- 24Volt, 100 Watt low-voltage motor with safety transformer
- Analogue motor speed control up to 25.000 rpm
- Aggregate tips speeds up to 12 m/s to produce the finest particles possible
- Soft start prevents splashing of homogenate from sample vessel
- Thermal fuse for overload protection
- Ergonomic, user-friendly design
- Aggregate replacement using one-handed quick-release coupling (type E)
- Various models of EasyClean dispersing aggregates
- Height-adjustable stand (optionally available)

Applications: General homogenisation applications, 5. Sample preparation for subsequent extraction of pharmaceutical agents (API), Cell disruption, RNA/DNA isolation from tissue, Dispersion of small quantities from plants, animals or human tissue

Dispersing heads must be ordered separately.

Specifications

Application volume:	0.05 to 250 ml
Motor input power:	100 W
Dispersing heads:	diam. 3, 5, 7 and 12 mm and diam. 20 mm X EC-E116
Speed range:	Stepless up to 25.000 rpm
Drive Dimensions (L x W x H):	220 x 44 x 55 mm
Weight drive:	440 g
Power supply:	90-250 V ±10 %, 50/60 Hz
IP code:	IP 20
Tested to:	EN/IEC 61010, 61326-1

Type	Plug type	PK	Cat. No.
POLYTRON® PT 1200 E	EU	1	9.571 492
POLYTRON® PT 1200 E	CH	1	6.258 268

2

2 Homogeniser, stand, POLYTRON® PT 2500 E (Ecoline)

KINEMATICA

The PT 2500 E is the ideal solution for cost-conscious laboratories. It is able to perform homogenisations with volumes from 0.05 to 2500 ml. The electronic control system continuously monitors the speed and automatically adjusts it, keeping it constant with changing viscosity. The speed is easily seen on the large digital display. Dispersing heads with a variety of styles and diameters are available to provide optimum particle size reduction when using this drive. There are many different styles of aggregates available from 3 mm up to 25 mm

- Aggregate tip speeds up to 32 m/s
- Soft start prevents splashing of homogenate from sample vessel
- Thermal fuse for overload protection
- Speed remains constant even when viscosity changes
- Aggregate replacement using one-handed quick-release coupling
- Insulated motor housing keeps motor noise to a safe, approved level
- Various models of EasyClean dispersing aggregates
- Digital display

Stand and dispersing heads must be ordered separately.

Specifications

Application volume:	0.05 ... 2500 ml
Motor input power:	500 W
Dispersing heads:	diam. 3, 5, 7 and 12 mm and diam. 20 mm and 25 mm
Speed range:	Stepless 500 to 30.000 rpm
Dimensions Drive (W x D x H):	76 x 157 x 236 mm
Weight Drive:	1.8 kg
Power supply:	90 ... 230 V ±10 %, 50/60 Hz
Protection class acc. to DIN:	IP 20
Tested to:	IEC/EN61326-1/IEC/EN 61000-6-2/EN 61000-6-4 IEC/EN 61010-2-51

Type	Plug type	PK	Cat. No.
POLYTRON® PT 2500 E	EU	1	7.981 185
POLYTRON® PT 2500 E	CH	1	6.263 341

➔ Suitable tools please see page 602

1 Stand Homogenisers POLYTRON® PT 10-35 GT (Ecoline)

KINEMATICA

Cost effective dispersing unit for applications with operating volumes up to 10 liters. The powerful motor is useful for sample preparation and also for formulation in scale-up matters. More than 30 dispersion aggregates with different geometries, designs, sizes, materials and coatings are available for selection. The electronic control system continuously compares the pre-selected rpm speed with the actual speed and adjusts it so that the speed remains constant even as the viscosity increases.

- Aggregate tip speeding up to 34 m/s
- Soft start to prevent splashing of homogenate from sample vessel
- Integrated overheating, overload and blocking protection
- Speed remaining constant even when viscosity changes
- Aggregate replacement using one-handed quick-release coupling (type F)
- Insulated motor housing keeps motor noise to a safe, approved level during operation
- Various models of EasyClean dispersing aggregates

Applications: General homogenisation applications (dispersion and emulsification), Formulation of lotions, creams and food, Production of oil-water emulsions, Dispersion of small quantities from plants, animals or human tissue

Stand and Dispersing heads must be ordered separately.

Specifications

Application volume (water):	0.1 ... 10000 ml
Motor input power:	1200 W
Speed range (stepless):	500 ... 30000 rpm
Dimensions Drive (W x D x H):	95 x 210 x 247 mm
Weight Drive:	3.2 kg
Power supply:	90 ... 230 V ±10 %, 50/60 Hz
IP code acc. to DIN:	IP 20
Tested to:	IEC/EN 61000-6-2/EN 61000-6-3/IEC/EN 61010-2-51



Type	Plug type	PK	Cat. No.
POLYTRON® PT 10-35 GT	EU	1	4.012 988
POLYTRON® PT 10-35 GT	CH	1	6.286 773

2 Stand Homogenisers POLYTRON® PT 45-80 GT (Ecoline)

NEW
KINEMATICA

High performance dispersing unit with powerful drive, stepless speed control, high tip speed and a variety of interchangeable dispersion aggregates for a wide range of dispersing and mixing applications.

- Aggregate tip speeding up to 32 m/s
- Easy operation with an on-off switch, speed control and membrane keypad
- Intelligent variable speed control for long equipment life
- Integrated overheating, overload and blocking protection
- Speed remaining constant even when viscosity changes
- Aggregate replacement using one-handed quick-release coupling (type F)
- Easy cleaning of the unit thanks to EasyClean design

Applications: General homogenisation applications (dispersion and emulsification), Formulation of lotions, creams and food, Production of oil-water emulsions, Dispersion of small quantities from plants, animals or human tissue

Dispersing heads must be ordered separately.

Specifications

Application volume (water):	0.1 ... 30000 ml
Motor input power:	1700 W
Speed range (stepless):	500 ... 21000 min ⁻¹
Dimensions Drive (W x D x H):	140 x 240 x 305 mm
Weight Drive:	6.8 kg
Power supply:	110 ... 230 V ±10 %, 50/60 Hz
IP code acc. to DIN:	IP 20
Tested to:	IEC/EN 61000-6-2/EN 61000-6-3/IEC/EN 61010-2-51



Type	Plug type	PK	Cat. No.
POLYTRON® PT 45-80 GT	EU	1	6.312 147
POLYTRON® PT 45-80 GT	CH	1	6.312 148
POLYTRON® PT 45-80 GT	UK	1	6.312 149



4.013 062



6.312 151

Stands for Homogenisers POLYTRON®

HS 1200 E: Holder for the support of drive, transformer, four dispersing aggregates and two tools. KINEMATICA

ST-P 13/320: Stainless steel plate stand with anti-slip mat made of silicone, with height-adjustable holder for the drive and for fastening the base station.

ST-P 01/200: Stainless steel joint stand (gas spring) with two rivet plugs for safe fixing of the basic station. The drive holder can be rotated in any direction, raised and lowered.

ST-P 15/320: Stainless steel plate stand with height-adjustable holder for drive support and for safe fixing of the basic station.

ST-P 20/600: Plate stand with two rod design. Height adjustable.

ST-P 10/600: Plate stand with one rod design. Allows easy and safe height adjustment of the drive unit.

Material: Aluminum

ST-F 10/600: H-foot stand made of anodized aluminum and the height adjustable, swiveling PTFE-coated work table with vessel holder. Material: Aluminum

ST-P 14/590+500: Electric plate stand with lifting telescopic bar for more ease of use. Incl. up/down button and mat to prevent slipping. Stroke 500 mm. The electronics are designed for ambient temperatures of +5 °C to +40 °C and were tested per EN 60335-1 and UL 962.

ST-P 21/700: Stainless steel plate stand with two rod design. Height adjustable. For more safety, the drive unit cannot be twisted sidewise or rotated.

Type	For	Weight g	PK	Cat. No.
HS 1200 E	PT 1200 E	680	1	6.260 509
ST-P13/320	PT 1200 E	1000	1	4.013 055
ST-P01/200	PT 1300 D	360	1	4.013 056
ST-P15/320	PT 1300 D	1000	1	4.013 057
ST-P20/600	PT 2500 E	370	1	4.013 060
Vessel holder ST-P20	PT 2500 E / ST-P20/600		1	7.981 189
Positioning ring ST-P20	PT 2500 E / ST-P20/600		1	7.981 188
ST-P10/600	PT 10-35 GT	290	1	4.013 061
Vessel holder ST-P10	PT 10-35 GT / ST-P10/600		1	4.013 069
Positioning ring ST-P10	PT 10-35 GT / ST-P10/600		1	4.013 072
ST-F10/600	PT 3100 D	550	1	4.013 062 1
ST-P14/590+500, with EU cable	PT 2500 E / PT 10-35 GT / PT 3100 D* / PT 6100 D	1100	1	4.013 065
ST-P14/590+500, with CH cable	PT 2500 E / PT 10-35 GT / PT 3100 D* / PT 6100 D	1100	1	4.013 064
Vessel holder ST-P14	PT 2500 E / PT 10-35 GT / PT 3100 D* / ST-P14/590+500		1	4.013 070
ST-P21/700	PT 3100 D / PT 6100 D / PT 45-80 GT	8000	1	6.312 151 2

*with optional adapter



6.258 273

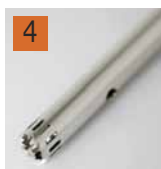

9.570 225

Dispersing heads for Homogeniser POLYTRON®

Type addition EC (STANDARD DISPERSING HEADS): The universal geometry uses two rows of teeth, is suitable for a large spectrum of laboratory applications, and it is reliable and efficient. KINEMATICA

Type addition BEC: High-turbulence mixing head, suitable for suspension of solid particles and for high viscosity applications.

Type addition W: Dispersing head for fibrous and tough materials.

Type addition SYN (SYNTHETICS): Disposable dispersing heads for the processing of multiple samples per day, where the required sterilization of stainless steel dispersing heads represents a significant time limitation.

Available in PES/Special POM. Sterile packed.

Type addition E: Coupling type E

Type addition F: Coupling type F

Type	For model	Length	Diam.	Working volume	PK	Cat. No.
PT-DA 03 / 2EC-E050	PT 1200 E / PT 1300 D / PT 2500 E	50	3	0.05 ... 2	1	6.258 269
PT-DA 05 / 2EC-E085	PT 1200 E / PT 1300 D / PT 2500 E	85	5	0.1 ... 5	1	9.570 223
PT-DA 07 / 2EC-E107	PT 1200 E / PT 1300 D / PT 2500 E	107	7	0.3 ... 10	1	6.258 271
PT-DA 07 / 2SYN-E082*	PT 1200 E / PT 1300 D / PT 2500 E	82	7	0.3 ... 10	25	6.258 273 3
PT-DA 07 / 2SYN-E082	PT 1200 E / PT 1300 D / PT 2500 E	82	7	0.3 ... 10	25	4.012 995
PT-DA 12 / 2EC-E157	PT 2500 E	157	12	2 ... 250	1	9.570 225 4
PT-DA 12 / 2SYN-E126*	PT 1200 E	126	12	2 ... 250	10	6.261 033
PT-DA 12 / 2SYN-E126	PT 1200 E / PT 1300 D / PT 2500 E	126	12	2 ... 250	10	4.012 999
PT-DA 20 / 2EC-E192	PT 2500 E	192	20	100 ... 2500	1	6.258 234
PT-DA 20 / 2WEC-E192	PT 2500 E	192	20	100 ... 2500	1	4.013 004
PT-DA 20 / 2EC-F193	PT 10-35 GT / PT 3100 D / PT 6100 D	193	20	100 ... 2000	1	4.013 016
PT-DA 20 / 2XEC-E116	PT 1200 E / PT 1300 D / PT 2500 E	116	20	10 ... 250	1	9.570 226
PT-DA 25 / 2EC-E192	PT 2500 E	192	25	100 ... 2500	1	9.570 227
PT-DA 30 / 2EC-F250	PT 10-35 GT / PT 3100 D / PT 6100 D	250	30	100 ... 4000	1	9.570 228

*sterile

Disperser System Ultra-Turrax® Tube Drive IKA

Disperse, stir and grind using a single drive unit. Patented disposable disperser system for volumes from 2 to 50 ml with hermetically sealable, disposable sample tubes. Provides protection and safety from: Infectious samples, toxic substances, strong-smelling materials.

- no possibility of cross-contamination
- suitable for individual or serial operations
- increased safety due to low voltage (24V) power
- chemically resistant plastic containers
- anti-locking function

Dispersing tubes (20 and 50 ml) with pierceable membrane and γ -sterilised are available on request.

Specifications

Viscosity max.: 5000 mPas
 Noise without element: 50 dB(A)
 Power supply: 100 ... 240 V, 50/60 Hz
 Protection class according to DIN EN 60529: IP 20
 Tested to DIN EN IEC 61010-1.

Disperser System Ultra-Turrax® Tube Drive IKA

Scope of delivery:
ULTRA-TURRAX® Tube Drive: Device incl. removal hook for removing the rotor-stator unit
ULTRA-TURRAX® Tube Drive Workstation: Device incl. 2 x DT-20 dispersing tubes incl. hook for removing the rotor-stator unit, 2 x ST-20 stirring tubes, 2 x BMT-20 G/S Ball-mill-tubes with glass balls/stainless steel balls, removal hook for removal of the rotor-stator unit and power supply.

Specifications

Motor rating input/output: 20/17 W
 Volume: 2 ... 50 ml
 Speed range: 300 ... 6000 rpm
 Timer: 1 ... 59 s (300 ... 6000 rpm)
 1 ... 29 min (300 ... 4000 rpm)
 Dimensions (W x D x H): 100 x 160 x 40 mm
 Weight: 0.75 kg



9.570 500

Type	Plug type	PK	Cat. No.
ULTRA-TURRAX® Tube Drive	EU	1	9.570 500 1
ULTRA-TURRAX® Tube Drive Workstation	EU	1	9.570 506

Dispergiersystem ULTRA-TURRAX® Tube Drive P control IKA

- USB interface for experiment control and documentation
- Collecting tray for protection against leaking liquids
- Simple, precise and multilingual menu navigation with OLED display
- Programmable sample conditions (library)
- Turbo button for short-term, intensive mixing, dispersing and grinding
- Adjustable reverse operation

Scope of delivery:
ULTRA-TURRAX® Tube Drive P control: Device incl. removal hook for removing the rotor-stator unit
ULTRA-TURRAX® Tube Drive P control Workstation: Device incl. 1 x ST-20, 1 x DT-20 incl. 1 removal hook for removal the rotor-stator unit, 2 x BMT-20 G/S, power supply.

Specifications

Motor rating input/output: 36/28 W
 Volume: 2 ... 300 ml
 Speed range: 400 ... 8000 rpm
 Timer: 10 s ... 30 min. (continuously adjustable)
 Dimensions (W x D x H): 122 x 178 x 54 mm
 Weight: 0.9 kg



9.729 919

Type	PK	Cat. No.
Tube Drive P control	1	9.729 919 2
Tube Drive P control Workstation	1	9.729 917

1

1

Dispersing tube for Dispersing system ULTRA-TURRAX® Tube Drive

IKA

Type	Description	PK	Cat. No.
DT-20	with dispersing unit, 20 ml	25	9.570 507
DT-20 eco	with dispersing unit, 20 ml	25	6.265 701
DT-50-M-gamma	with dispersing unit, 50 ml, sterile	10	6.236 446
ST-20	with stirring unit, 20 ml	25	9.570 508
ST-20-M-gamma	with stirring unit, 20 ml, sterile	20	6.237 479
ST-50	with stirring unit, 50 ml	10	6.237 478
ST-50-M-gamma	with stirring unit, 50 ml, sterile	10	6.237 482
BMT-20 G	with glass balls, 20 ml	25	9.570 509
BMT-20-G-M-gamma	with glass balls, 20 ml, sterile	20	7.911 101
BMT-20 S	with stainless steel balls, 20 ml	25	9.570 510
BMT-20-S-M-gamma	with stainless steel balls, 20 ml, sterile	20	6.274 088

2

2

Homogeniser T 10 basic ULTRA-TURRAX®

Small dispersing instrument for volumes from 0.5 ml to 100 ml (H₂O).

IKA

It offers a wide speed range from 8000 rpm to 30000 rpm that enables users to work at high circumferential speeds even with small rotor diameters. A broad choice of dispersing elements guarantees a wide range of applications.

- Quick-connect coupling for changing dispersing elements easily
- Ideal for manual operation due to its light weight and ergonomic design
- Extremely mobile due to direct line power (no transformer required)
- Stainless steel dispersing elements can be cleaned quickly and easily as they can be dismantled without tools
- Plastic disposable dispersing elements are available in two sizes, particularly suitable for PCR analysis
- High performance drive ensures immense speed stability
- Quiet operation

Dispersing heads must be ordered separately.

Specifications

Motor rating input/output:	125 W/75 W
Working volume range (H ₂ O):	0.5 ml to 100 ml
Viscosity max.:	5000 mPas
Speed range:	8000 rpm to 30000 rpm
Speed display:	scale
Speed control:	stepless
Noise without element:	65 db(A)
Extension arm diam./length:	8 mm/130 mm
Dimensions (W x D x H):	56 x 66 x 178 mm
Weight:	0.5 kg
Power supply:	230 V, 50/60 HZ
Protection class DIN EN 60529:	IP 30

Type	Plug type	PK	Cat. No.
T 10 basic ULTRA-TURRAX®	EU	1	9.570 940
T 10 basic S2 ULTRA-TURRAX®	UK	1	9.570 941
T 10 basic S3 ULTRA-TURRAX®	CH	1	9.570 942

3

6.225 477

Dispersing heads Ultra Turrax® for T 10 basic



IKA

Dispersing heads, plastic: Autoclavable. Dispersing heads, stainless steel: Ultimate fineness: emulsions 1 to 10µm and suspensions 5 to 25µm, sterilisable by all methods. ST tools are recommended for use with tissue and other fibrous materials.

Type	Working volume	Diam. rotor / stator	Max. immersion depth	Material	PK	Cat. No.
	ml					
S 10 D-7 G-KS - 65	1 - 20	4.8 / 7	65	PC, PSU	24	6.262 140
S 10 D-7 G-KS - 110	1 - 40	4.8 / 7	110	PC, PSU	24	9.570 878
S 10 N - 5 G	0.5 - 10	3.8 / 5	75	PTFE, AISI 316 L	1	7.631 964
S 10 N - 8 G	1 - 50	6.1 / 8	95	PTFE, AISI 316 L	1	6.225 614
S 10 N - 8 G ST	1 - 50	6.1 / 8	95	PTFE, AISI 316 L	1	4.656 091
S 10 N - 10 G	1 - 100	7.6 / 10	100	PTFE, AISI 316 L	1	6.225 477
S 10 N - 10 G ST	1 - 100	7.6 / 10	100	PTFE, AISI 316 L	1	7.670 460

1 Homogeniser T 18 digital ULTRA-TURRAX®

1

Competitively priced dispersing instrument for volumes from 1 ml to 1500 ml (H₂O) with digital speed display. It offers a wide speed range from 500 rpm to 25000 rpm that enables users to work at high circumferential speeds even with small rotor diameters. A broad choice of dispersing elements guarantees a wide range of applications.

IKA

- Digital speed display
- Electronic speed control
- Electronic overload protection
- Stainless steel dispersing elements can be cleaned quickly and easily
- Plastic disposable dispersing elements are available in two sizes
- Error code display
- Quiet operation

Dispersing heads must be ordered separately.

Specifications

Motor rating input/output:	500 W/300 W
Working volume range (H ₂ O):	1ml to 1500 ml
Viscosity max.:	5000 mPas
Speed range:	500 rpm to 25000 rpm
Speed display:	LED
Speed control:	stepless
Noise without element:	75 db(A)
Extension arm diam./length:	13 mm/160 mm
Dimensions (W x D x H):	87 x 106 x 271 mm
Weight:	2.5 kg
Power supply:	200-240 V, 50/60 HZ
Protection class DIN EN 60529:	IP 20



Type	Plug type	PK	Cat. No.
T 18 digital ULTRA-TURRAX®	EU	1	9.570 943
T 18 digital S2 ULTRA-TURRAX®	UK	1	9.570 944
T 18 digital S3 ULTRA-TURRAX®	CH	1	9.570 945
T 18 digital ULTRA-TURRAX® Package	EU	1	9.570 946
T 18 digital S2 ULTRA-TURRAX® Package	UK	1	9.570 947
T 18 digital S3 ULTRA-TURRAX® Package	CH	1	9.570 948

2 Dispersing heads for Ultra Turrax® T18 digital

2



Plastic dispersing heads: Autoclavable
 Stainless steel dispersing heads: Ultimate fineness emulsions 1 to 10 µm and suspensions 10 to 50 µm, sterilisable by all methods.

IKA



Type	Working volume	Diam. rotor / stator	Max. immersion depth	Material	PK	Cat. No.
	ml	mm	mm			
S 18 D-10 G-KS	10 to 100	6.75 / 10	85	PC, PEEK	12	9.570 855
S 18 D-14 G-KS	10 to 500	9.5 / 14	85	PC, PEEK	12	9.570 857
S 18 N - 10 G	1 to 100	7.5 / 10	70	PTFE, AISI 316 L	1	9.570 841
S 18 N - 19 G	10 to 1500	12.7 / 19	170	PTFE, AISI 316 L	1	9.570 842

➔ Stands and fittings please see page 610

We can supply this
 manufacturer's
 whole
 product range !



IKA

designed for scientists

Discover the fascinating world of laboratory equipment



www.ika.com



IKA-Werke GmbH & Co. KG
Janke & Kunkel-Straße 10
79219 Staufen, Germany
Phone: +49 7633 831-0
Fax: +49 7633 831-98
eMail: sales@ika.de

1 Homogeniser T 25 digital ULTRA-TURRAX®

High-performance dispersing instrument for volumes from 1 to 2000 ml (H₂O) with digital speed display. It offers a wide speed range from 3000 to 25000 rpm that enables users to work at high circumferential speeds even with small rotor diameters. A broad choice of dispersing elements adds versatility. Applications ranges from homogenizing waste water samples, use in laboratory reactors, dispersion tasks under vacuum/pressure and sample preparation in medical diagnostics.

IKA

- Digital speed display
- Electronic speed control
- Electronic overload protection
- Stainless steel dispersing elements can be cleaned quickly and easily
- Plastic disposable dispersing elements are available in two sizes
- Error code display
- Quiet operation

Dispersing heads must be ordered separately.

Specifications

Motor rating input/output:	800/500 W
Working volume range (H ₂ O):	1... 2000 ml
Viscosity max.:	5000 mPas
Speed range:	3000... 25000 rpm
Speed display:	LED
Speed control:	stepless
Noise without element:	75 db(A)
Extension arm diam./length:	13 mm/160 mm
Dimensions (W x D x H):	87 x 106 x 271 mm
Weight:	2.5 kg
Power supply:	200-400 V, 50/60 HZ
Protection class DIN EN 60529:	IP 20

Type	Plug type	PK	Cat. No.
T 25 digital ULTRA-TURRAX®	EU	1	9.570 949
T 25 digital S2 ULTRA-TURRAX®	UK	1	9.570 950
T 25 digital S3 ULTRA-TURRAX®	CH	1	9.570 951

1



Dispersing heads for T25 basic Ultra-Turrax®



Plastic dispersing heads: Autoclavable. Stainless steel dispersing heads: Ultimate fineness: emulsions 1 µm to 10 µm and suspensions 5 µm to 50 µm, sterilisable by all methods. ST tools are recommended for use with tissue and other fibrous materials.

Type	Diam. rotor / stator	Max. immersion depth	Working volume	Material	PK	Cat. No.
	mm	mm	ml			
S 25 D-10 G-KS	6,75 / 10	85	10 - 100	PC, PEEK	12	9.570 859
S 25 D-14 G-KS	9,5 / 14	85	10 - 500	PC, PEEK	12	9.570 861
S 25 N - 8 G	6,1 / 8	85	1 - 50	PTFE, AISI 316 L	1	9.571 098
S 25 N - 8 G - ST	6,1 / 8	85	1 - 50	PTFE, AISI 316 L	1	7.981 562
S 25 N - 10 G	7,5 / 10	85	1 - 100	PTFE, AISI 316 L	1	9.571 207
S 25 N - 10 G - ST	7,5 / 10	85	1 - 100	PTFE, AISI 316 L	1	7.970 905
S 25 N - 18 G	12,7 / 18	165	10 - 1500	PTFE, AISI 316 L	1	9.571 119
S 25 N - 18 G - ST	12,7 / 18	165	10 - 1500	PTFE, AISI 316 L	1	7.970 906
S 25 N - 25 G	17,0 / 25	165	50 - 2000	PTFE, AISI 316 L	1	9.571 200
S 25 N - 25 G - ST	17,0 / 25	165	50 - 2000	PTFE, AISI 316 L	1	6.257 274
S 25 N - 25 F	18,0 / 25	165	100 - 2000	PTFE, AISI 316 L	1	9.571 201
S 25-KD-25 F	18,0 / 25	185	100 - 2000	FKM, PTFE, AISI 316 L	1	4.653 935
S 25 KV-18 G	12,7 / 18	225	10 - 1500	FFPM / SIC, AISI 316 L	1	9.571 117
S 25 KV - 25 F	18,0 / 25	225	100 - 2000	FFPM / SIC, AISI 316L	1	9.571 199
S 25 KV 2802	39 / 30	225	100 - 2000	FFPM / SIC, AISI 316L	1	4.672 743

Further dispersing heads are available on request.

2



9.570 861

3



9.571 200

1

4.665 087

Homogenisers T 25 easy clean digital/T 25 easy clean control

High-performance homogeniser with electronic speed control and a large variety of dispersing heads for many fields of applications. In combination with an IKA laboratory reactor it is also possible to conduct dispersion tasks under vacuum or pressure.

IKA

- Quick and easy cleaning of the dispersing tools, no disassembling required
- Brushless motor guarantees dust-free and silent operation
- USB interface for control and documentation via labworldsoft®
- Timer/counter function
- Increased safety through tool recognition and IP-Code

T 25 easy clean control, additionally:

- Integrated temperature measurement for permanent monitoring of the medium temperature
- Remote control with WiCo

Dispersing heads must be ordered separately.

All existing S 25 dispersing elements are compatible with T 25 easy clean digital.

Specifications

Motor rating input/output:	500/400 W
Working volume range (H:O):	1 ... 2000 ml
Viscosity max.:	5000 mPas
Speed range:	3.000 ... 25.000 rpm
Speed display:	LED
Speed control:	stepless
Noise without element:	70 dB(A)
Extension arm diam.:	13 mm
Dimensions (W x D x H):	89 x 161 x 270 mm
Weight:	3.0 kg
Power supply:	220 ... 240 V, 50 ... 60 Hz
Protection class DIN EN 60529:	IP 30

Type	PK	Cat. No.
T 25 easy clean digital	1	6.291 622
T 25 easy clean control	1	4.665 087 1

Dispersing heads for T 25 easy clean digital/T 25 easy clean control

Easy to clean dispersing head made of stainless steel (AISI 316) and ceramic.

IKA

Ultimate fineness: emulsions 1µm to 10 µm and suspensions 10 µm to 50 µm, sterilisable by all methods.

S 25 EC-T-C-18G-ST, S 25 EC-T-C-25G-ST, S 25 EC-T-C-25F with integrated temperature sensor.

Type	Diam. rotor / stator mm	Min. Immersion depth mm	max. Workspace volume ml	Material	PK	Cat. No.
S 25 EC-C-18 G-ST	13,4 / 18	35	1500	AISI 316L, ceramic	1	6.291 623 2
S 25 EC-T-C-18 G-ST	13,4 / 18	50	1500	AISI 316L, ceramic	1	4.665 610 3
S 25 EC-C-25 F	18 / 25	35	2000	AISI 316L, ceramic	1	4.672 775
S 25 EC-T-C-25 F	20 / 25	35	2000	AISI 316L, ceramic	1	4.672 777
S 25 EC-C-25 G-ST	20 / 25	35	2000	AISI 316L, ceramic	1	4.672 774
S 25 EC-T-C-25 G-ST	20 / 25	45	2000	AISI 316L, ceramic	1	4.672 776

2

6.291 623

3

4.665 610

1 High-power homogeniser T 50 digital ULTRA-TURRAX®

Powerful dispersing instrument for volumes from 0.25 to 30 l (H₂O) with digital speed display. IKA
It offers a wide speed range from 500 to 10000 rpm that enables users to work at high circumferential speeds even with small rotor diameters. A broad choice of dispersing elements guarantees a wide range of applications. Reproducible operations due to constant speed even with changes in viscosities.

- Digital speed display
- Electronic speed control
- Electronic overload protection
- Stainless steel dispersing elements can be cleaned quickly and easily
- Smooth start
- Error code display

Dispersing heads must be ordered separately.

Specifications

Motor rating input/output:	1100W/700W
Working volume range (H ₂ O):	0.25 to 30 l
Viscosity max.:	5000 mPas
Speed range:	500 to 10000 rpm
Speed display:	LED
Speed control:	stepless
Noise without element:	72 db(A)
Extension arm diam./length:	16 mm/220 mm
Dimensions (W x D x H):	115 x 139 x 355 mm
Weight:	5.76 kg
Power supply:	200-240 V, 50/60 HZ
Protection class DIN EN 60529:	IP 20



Type	Plug type	PK	Cat. No.
T 50 digital ULTRA-TURRAX®	EU	1	9.570 952
T 50 digital S2 ULTRA-TURRAX®	UK	1	9.570 953
T 50 digital S3 ULTRA-TURRAX®	CH	1	9.570 954

Dispersing heads for T50 digital ULTRA-TURRAX®

Stainless steel dispersing heads

IKA

Type	Diam. rotor / stator	Max. immersion depth	Working volume	Ult. fineness suspensions / emulsions	Material	PK	Cat. No.
	mm	mm	l	µm			
S 50 KG - HH - G 45 F	40.0 / 45	250	0.25 - 10	10 - 30 / 1 - 10	FFPM/SIC, AISI 316L	1	9.570 898
S 50 N - G 45 G*	36.0 / 45	250	0.5 - 20	40 - 100 / 10 - 30	PTFE, AISI 316L	1	9.570 882 2
S 50 N - G 45 M*	40.5 / 45	250	0.5 - 15	25 - 50 / 5 - 20	PTFE, AISI 316L	1	9.570 886 3
S 50 N - G 45 F*	40.0 / 45	250	0.25 - 10	10 - 30 / 1 - 10	PTFE, AISI 316L	1	9.570 896 4
S 50 KD - G 45 G	36.0 / 45	260	0.5 - 20	40 - 100 / 10 - 30	FFKM, PTFE, AISI 316L	1	4.656 096
S 50 KD - G 45 G - ST	38.0 / 45	300	0.5 - 20	40 - 100 / 10 - 30	FFKM, PTFE, AISI 316L	1	4.656 097
S 50 KD - G 45 M	40.0 / 45	300	0.5 - 15	25 - 50 / 5 - 20	FFKM, PTFE, AISI 316L	1	4.656 098
S 50 KD - G 45 F	40.0 / 45	300	0.25 - 10	10 - 30 / 1 - 10	FFPM, PTFE, AISI 316L	1	4.656 099
S 50 KG - HH - G 45 G - ST	38.0 / 45	260	0.5 - 20	40 - 100 / 10 - 30	FFPM, WC, AISI 316L	1	4.656 100
S 50 N - G 45 G - ST	38.0 / 45	300	0.5 - 20	40 - 100 / 10 - 30	PTFE, AISI 316L	1	6.262 646
S 50 KG-HH-G 45 G	36.0 / 45	260	0.5 - 20	40 - 100 / 10 - 30	FFPM/SIC, AISI 316L	1	9.570 884
S 50 KG-HH-G 45 M	40.5 / 45	250	0.5 - 15	25 - 50 / 5 - 20	FFPM/SIC, AISI 316L	1	9.570 888

* sterilisable by all methods

Further dispersing heads are available on request.



9.570 882



9.570 886



9.570 896

Stands and fittings for Dispersers T 10/T 18/T 25/T 50

IKA

Type	For model	Description	Rod diam.	Height	PK	Cat. No.
			mm	mm		
R 104	T 10	Stand	10	370	1	7.631 971 1
H 44	T 10	Boshead			1	9.232 994 2
R 200	T 10	Clamp			1	6.225 158 3
R 1825	T 18 / T 25	Stand with baseplate	16	560	1	9.224 031 4
RH 5	T 50	Strap clamp			1	9.224 762
R 1826	T 18 / T 25	Stand with baseplate	16	800	1	9.224 032
R 1827	T 18 / T 25	Stand with baseplate	16	1000	1	9.224 033
R 182	T 18 / T 25	Boshead			1	9.224 292 5
RH 3	T 18 / T 25	Strap clamp			1	9.224 761 6
R 2722	T 50	H-stand	34	1010	1	9.224 026
R 2723	T 50	Telescopic stand	34	620 - 1010	1	9.224 028
R 271	T 50	Boshead			1	9.224 266



7 Ultrasonic Homogeniser SONOPULS mini20

Bandelin



For volumes from 0.1 to 25 ml. With LC display for amplitude, pulse level, time and energy input, RS 232 interface. Time setting up to 59 min : 59 s. Ready-to-operate set for volumes from 0.5 to 25 ml consisting of:

- Generator GM mini20
- Ultrasonic converter UW mini20
- Microtip MS 2.5, diam. 2.5 mm

Further Titanium probes with diam. 1.5 mm and 2.0 mm available on request.

HF generator

Dimensions (W x D x H):

Converter

Dimensions (diam. x L):

Ultrasonic nominal power:

GM mini20

256 x 154 x 250 mm

UW mini20

50 x 160 mm

max. 20 W

Type	min. sample volume ml	max. sample volume ml	Pulsation	PK	Cat. No.
SONOPULS mini20	0.50	25	ON cycles 0.1 ...60 s OFF cycles 0.2 ...60 s	1	9.650 160

8 Probes for Sonopuls Ultrasonic homogenisers, titanium

Titanium probes.

For connection to stepped horns/booster horns.



Type	For	For volume ml	For	Diam. mm	Tip	PK	Cat. No.
MS 1.5	UW mini20	0,1 - 10	Sonpuls mini20	1.5	microtip	1	9.650 165
MS 2.0	UW mini 20	0,25 - 20	Sonpuls mini20	2.0	microtip	1	6.251 521
MS 2.5	UW mini20	0,5 - 25	Sonpuls mini20	2.5	microtip	1	9.650 166

Suitable accessories can be found in our online shop.

Ultrasonic homogenisers SONOPLUS HD 2000

Suitable for homogenising, deagglomerating, emulsifying, suspending, accelerating chemical reactions or disruption of cells, bacteria, fungi or spores. The devices of the SONOPLUS HD 2000 series are characterised by optimised process times and quickly available reproducible results. Bandelin

- LC display for amplitude, pulse level and time
- Pulse mode, AMPLICHRON®-circuit
- Batch mode/sequencing
- Interference suppression

Also available for medicine products according to the guideline for in-vitro-diagnostics 98/79/EG.

1 Ultrasonic homogeniser, SONOPULS HD 2070.2

For volumes 1 to 200 ml. Ready-to-operate set for volumes from 2 to 50 ml consisting of: Bandelin

- HF generator GM 2070.2
- Ultrasonic converter UW 2070
- Standard horn SH 70 G
- Microtip MS 73, diam. 3 mm

Further Titanium probes with diam. 2 mm, 6 mm and 13 mm available on request.

HF generator	GM 2070.2
Dimensions (W x D x H):	240 x 210 x 140 mm
Converter	UW 2070
Dimensions (diam. x L):	70 x 150 mm
Ultrasonic nominal power:	max. 70 W



Type	min. sample volume ml	max. sample volume ml	Pulsation	PK	Cat. No.
SONOPULS HD 2070.2	2.00	50	ON cycles: 1 ...60 s OFF cycles: 1 ...60 s	1	6.274 342

Stand and vessel are not included.

2 Ultrasonic homogeniser, SONOPULS HD 2200.2

For volumes 2 to 1000 ml. Ready-to-operate set for volumes from 20 to 900 ml consisting of: Bandelin

- HF generator GM 2200.2
- Ultrasonic converter UW 2200
- Standard horn SH 213 G
- Titanium flat tip TT 13, diam. 13 mm

Further Titanium probes with diam. 2 mm, 3 mm, 6 mm, 19 mm and 25 mm available on request.

HF generator	GM 2200.2
Dimensions (W x D x H):	240 x 210 x 140 mm
Converter	UW 2200
Dimensions (diam. x L):	70 x 150 mm
Titanium probes (diam.):	2/3/6/13/19/25 mm (not supplied)
Ultrasonic nominal power:	max. 200 W



Type	min. sample volume ml	max. sample volume ml	Pulsation	PK	Cat. No.
SONOPULS HD 2200.2	20.00	900	ON cycles: 1 ...60 s OFF cycles: 1 ...60 s	1	6.273 768

Stand and vessel are not included.

Probes for Sonopuls Ultrasonic homogenisers, titanium

Titanium probes.
For connection to stepped horns/booster horns.

Bandelin

Type	For	For volume ml	For	Diam. Tip mm	PK	Cat. No.
MS 72	SH 70 G SH 213 G	1 - 25 2 - 30	HD 2070.2 / 2200.2	2 microtip	1	9.650 244
MS 73	SH 70 G SH 213 G	2 - 50 5 - 90	HD 2070.2 / 2200.2	3 microtip	1	9.650 245
KE 76	SH 70 G SH 213 G	5 - 100 10 - 350	HD 2070.2 / 2200.2	6 tapered tip	1	9.650 246
TT 13	SH 70 G SH 213 G	10 - 200 20 - 900	HD 2070.2 / 2200.2	13 titanium flat tip	1	9.650 250
TT 13 FZ	FZ 5 G FZ 7 G	-	HD 2070.2 / 2200.2	13 titanium flat tip with hole	1	9.650 247
TT 25	SH 225 G	30 - 1000	HD 2200.2	25 titanium flat tip	1	9.650 249
VS 70 T	SH 70 G SH 213 G	10 - 200 20 - 900	HD 2070.2 / 2200.2	13 probe long	1	9.650 239
VS 190 T	SH 219 G	25 - 900 500 - 1500	HD 2200.2	19 probe long	1	9.650 243
VS 200 T	SH 225 G	30 - 1000 500 - 2500	HD 2200.2	25 probe long	1	9.650 240

Ultrasonic homogeniser SONOPLUS HD 4000

Suitable for homogenising, desagglomerating, emulsifying, suspending, accelerating chemical reactions or disruption of cells, bacteria, fungi or spores. The devices of the SONOPLUS 4000 series are characterised by optimised process times and quickly available reproductive results.

Bandelin

- LC display for amplitude, pulse level, time and power
- Pulse mode, AMPLICHRON®-circuit
- Data memory
- Batch mode/sequencing
- Temperature display and measurement
- Remote control via PC RS 232
- Interference suppression

Also available as medicine product according to the guideline for in-vitro-diagnostics 98/79/EG.

1



1 Ultrasonic homogeniser, SONOPULS HD 4050

For volumes from 0.5 to 100 ml. Ready-to-operate set for volumes from 0.5 to 20 ml consisting of:

Bandelin

- HF generator GM 4200
- Ultrasonic converter UW 50
- Titanium probe TS 102, diam. 2 mm

Further Titanium probes with diam. 3 mm, 4.5 mm and 6 mm available on request.

HF generator	GM 4200
Dimensions (W x D x H):	150 x 335 x 220 mm
Converter	UW 50
Dimensions (diam. x L):	45 x 175 mm
Ultrasonic nominal power:	max. 50 W

Type	min. sample volume ml	max. sample volume ml	Pulsation	PK	Cat. No.
SONOPULS HD 4050	0.50	20	ON cycles: 0.2 ...600 s OFF cycles: 0.3 ...600 s	1	9.650 151

Stand and vessel are not included.

We can **supply** this
manufacturer's whole
product range !



BANDELIN

1 Ultrasonic homogeniser, SONOPULS HD 4100

For volumes 2 to 200 ml. Ready-to-operate set for volumes from 3 to 50 ml consisting of:

- HF generator GM 4200
- Ultrasonic converter UW 100
- Standard horn SH 100 G
- Titanium probe TS 103, diam. 3 mm

Bandelin

Further Titanium probes with diam. 2 mm, 4.5 mm, 6 mm, 9 mm and 13 mm available on request.

HF generator **GM 4200**
 Dimensions (W x D x H): 150 x 335 x 220 mm
Converter **UW 100**
 Dimensions (diam. x L): 70 x 150 mm
 Ultrasonic nominal power: max. 100 W

Type	min. sample volume ml	max. sample volume ml	Pulsation	PK	Cat. No.
SONOPULS HD 4100	3.00	50	ON cycles: 0.2 ...600 s OFF cycles: 0.3 ...600 s	1	9.650 152

Stand and vessel are not included.



2 Ultrasonic homogeniser, SONOPULS HD 4200

For volumes 5 to 1000 ml. Ready-to-operate set for volumes from 20 to 900 ml consisting of:

- HF generator GM 4200
- Ultrasonic converter UW 200
- Standard horn SH 200 G
- Titanium probe TT 213, diam. 13 mm

Bandelin

Further Titanium probes with diam. 4.5 mm, 6 mm, 9 mm, 16 mm and 25 mm available on request.

HF generator **GM 4200**
 Dimensions (W x D x H): 150 x 335 x 220 mm
Converter **UW 200**
 Dimensions (diam. x L): 70 x 150 mm
 Ultrasonic nominal power: max. 200 W

Type	min. sample volume ml	max. sample volume ml	Pulsation	PK	Cat. No.
SONOPULS HD 4200	20.00	900	ON cycles: 0.2 ...600 s OFF cycles: 0.3 ...600 s	1	7.971 467

Stand and vessel are not included.



3 Ultrasonic homogeniser, SONOPULS HD 4400

For volumes 100 to 3000 ml. Ready-to-operate set for volumes from 500 to 2000 ml consisting of:

- HF generator GM 4400
- Ultrasonic converter UW 400
- Standard horn SH 400 G
- Titanium probe TS 425, diam. 25 mm

Bandelin

Further Titanium probes with diam. 13 mm, 16 mm, 19 mm, 32 mm and 38 mm available on request.

HF generator **GM 4400**
 Dimensions (W x D x H): 150 x 335 x 220 mm
Converter **UW 400**
 Dimensions (diam. x L): 86 x 180 mm
 Ultrasonic nominal power: max. 400 W

Type	min. sample volume ml	max. sample volume ml	Pulsation	PK	Cat. No.
SONOPULS HD 4400	500.00	2000	ON cycles: 0.2 ...600 s OFF cycles: 0.3 ...600 s	1	6.274 619

Stand and vessel are not included.



4 Ultrasonic homogenisers, SONOPULS, accessories

The stand is used for the correct and variable positioning of the ultrasonic transducers.

NEW
Bandelin

Type	For	PK	Cat. No.
HG 40	HD 2000 / HD 2000.2 / HD 3000 / HD 4000	1	4.672 126



Mixing, Homogenisation/Ultrasonic homogenisers-Homogenisers



9.650 235



9.650 236



9.650 261

Glass sample vessels, Borosilicate glass 3.3 for Ultrasonic homogenisers SONOPULS

For direct ultrasonic irradiation.

Bandelin

Type	For probes up to Ø mm	Volume ml	PK	Cat. No.
KG 3 cooling vessel	2 ... 13	15	1	9.650 235 1
KG 5 cooling vessel	13 ... 25	70	1	9.650 223
DG 3 flow-through vessel with cooling jacket	2 ... 13	max. 5,6 l/h	1	9.650 236 2
DG 5 flow-through vessel with cooling jacket	13 ... 25	max. 30 l/h	1	9.650 224
DG 6 flow-through vessel with cooling jacket	25 ... 38	max. 30 l/h	1	6.284 689
RZ 1 rosett cell	2 ... 3	25	1	9.650 267
RZ 2 rosett cell	2 ... 6	40	1	9.650 268
RZ 3 rosett cell	3 ... 13	110	1	9.650 261 3
RZ 4 rosett cell	13 ... 25	390	1	9.650 260
RZ 5 rosett cell	19 ... 25	660	1	9.650 264



4 Sound proof box LS 40

NEW

Bandelin

To reduce the noise level when sonicating samples with an ultrasonic homogeniser. The lower part of the interior and the removable bottom tray are made of stainless steel and are therefore chemically resistant and easy to clean.

- Noise reduction of up to 30 dB-AU
- LED interior lighting
- Acrylic glass window
- With effective ventilation system
- With opening (40 x 70 mm) for cooling tubing, sample circulation or the SONOPULS temperature sensor on the back
- Removable bottom tray
- Easy retrofitting for use with sonotrodes or cup booster possible

The stand HG 40 is required to attach the ultrasonic converter. Please order separately.

Type	For	PK	Cat. No.
LS 40	HD 2000.2 / HD 3000 / HD 4000	1	4.672 127



5 Gravimetric dilutor DiluFlow®, 1 or 2 pumps

All stainless steel with a new design, ultra-low profile for easy use under laminar flow. USB port.

interscience

- Available in 1 or 2 pumps.
- Quick and accurate
 - Compact and user-friendly
 - RS232 output for LIMS and printer, USB

Supplied with

1 BagOpen® 400 DiluFlow®, 1 fixed arm, 1 power cord, 1 ø 6.4 mm tubings set per pump for GL45 bottle, 1 drip tray, 1 user's manual, guarantee

Specifications

Range: from 0.1 g to 3000 g
 Dilution Precision: > 98 %
 Dimensions (W x L x H): 310 x 415 x 400 mm
 Weight: 10.5 kg

Type	PK	Cat. No.
DiluFlow® with single pump	1	9.569 991
DiluFlow® with double pump	1	9.569 992

Laboratory mixer, BagMixer® 400

For sample preparation with easily adjustable paddle system. The BagMixer® is available in 3 sizes and blends all sample types prior to their microbial analysis. Thanks to their unique adjustable paddle system the blending chamber can be adjusted to the sample volume. Combined with the variable speed, a higher bacterial recovery rate is achieved. All BagMixer® units are fitted with a timer. Constructed in stainless steel. The fully opening door enables easy cleaning.

BagMixer® 400 P with stainless steel door.
 BagMixer® 400 W and 400 CC with see through glass door.

Click & clean® System (only BagMixer® 400 CC): removable and autoclavable paddles.

All units have a 3-year warranty and life guarantee for shock absorbers and window door.

Type	Volume ml	Width mm	Depth mm	Height mm	PK	Cat. No.
BagMixer® 400 P	50 to 400	260	390	290	1	6.204 551
BagMixer® 400 W	50 to 400	260	390	290	1	6.224 287
BagMixer® 400 CC	50 to 400	260	420	265	1	9.570 098 ¹

interscience



9.570 098

Laboratory mixer, BagMixer® 400Series S

BagMixer® 400 S/400 SW are a new generation of lab blenders, silent, easy-to-use and with sturdy design.

With a significantly lower noise level during mixing, it is suitable for all types of laboratory applications. For high bacterial extraction. No cross contamination with sterile homogenizer filter bags.

BagMixer® 400 S without viewing window, **BagMixer® 400 SW** with viewing window.

- Silent mixing with less than 48 db
- Homogenization of the samples in 60 sec.
- LiquidSensor detects leaking bags
- 4 adjustable speeds
- Digital operating display
- LightCode system indicates the mixed state by coloured light
- White LED light illuminates the mixing chamber

All units have a 3-year warranty and life guarantee for shock absorbers and window door.

Starter Pack: 1 BagMixer® 400 S/SW, 500 BagFilter® filter bags, 500 BagLight® plain bags, 50 BagClip® closing clips, 1 BagOpen® bag opener/holder and 1 BagRack® storage rack.

Classic Pack: 1 BagMixer® 400 S/SW, 500 BagFilter® filter bags, 500 BagPage® filter bags, 500 BagLight® plain bags, 50 BagClip® closing clips, 1 BagOpen® bag opener/holder, 1 BagRack® storage rack, 1 PetriPile® Petri dish storage rack, 1 BagPipet® pipette and tips and 1000 BagTips® Regular tips for BagPipet®.

Premium Pack: 1 BagMixer® 400 S/SW, 1 DiluFlow® gravimetric dilutor, 1000 BagFilter® filter bags, 1000 BagPage® filter bags, 2000 BagLight® plain bags, 50 BagClip® closing clips, 1 BagOpen® bag opener/holder, 2 BagRack® storage rack, 2 PetriPile® Petri dish storage rack, 1 BagPipet® pipet and tips and 1000 BagTips® Regular tips for BagPipet®.

Type	Volume ml	Width mm	Depth mm	Height mm	PK	Cat. No.
BagMixer® 400 S	50 ... 400	450	290	370	1	6.261 704 ²
BagMixer® 400 SW	50 ... 400	450	290	370	1	6.261 705 ³
BagMixer® 400 S + Starter Pack	50 ... 400	450	290	370	1	4.668 229
BagMixer® 400 S + Classic Pack	50 ... 400	450	290	370	1	4.669 399
BagMixer® 400 S + Premium Pack	50 ... 400	450	290	370	1	4.669 400
BagMixer® 400 SW + Starter Pack	50 ... 400	450	290	370	1	4.669 401
BagMixer® 400 SW + Classic Pack	50 ... 400	450	290	370	1	4.669 402
BagMixer® 400 SW + Premium Pack	50 ... 400	450	290	370	1	4.669 403

interscience



6.261 704



6.261 705

Laboratory paddle blender MiniMix® 100

MiniMix® 100 paddle blenders, from the BagMixer® range, guarantees a quick and accurate blending of small samples. Thanks to the adjustable paddle system, blending is at its best. MiniMix® 100 is ideal for medical, veterinary and microbiological analysis.

Type	Volume ml	PK	Cat. No.
MiniMix® 100 P CC®	80-100	1	6.240 509
MiniMix® 100 W CC®, with window door	80-100	1	6.241 090 ⁴

interscience



6.241 090

Blender bags, BagSystem®

These gamma-ray sterilized bags have a high mechanical stability and ensure safety for the samples. The filters inserted in the bags filter the liquid during sample preparation (washing process) and retain sample particles.

interscience

BagLight®: Bag without filter, for all microbiological laboratory applications.

BagLight® Multilayer: Like BagLight® with strong multilayer film.

BagLight® Multilayer U: Like BagLight® with strong multilayer film and U-bottom.

BagPage® and BagPage®+: Homogenizer bag with a micro-perforated filter that extends over the entire width of the sample bag (full-size filter).

BagPage® R: Like BagPage® with non-woven filter.

BagPage® F: Like BagPage® for flow cytometry.

BagPage® XR: Like BagPage® extra resistant.

BagFilter® P: Bag with non-woven filter (side filter). Removal of the filtered solvent with BagPipet®. With pre-cut for pipetting.

BagFilter® Roll: Bag with non-woven filter (side filter). With waterproof quick-closure by resealable sticker.

BagFilter® Pipett: Bag with non-woven filter (side filter). With resealable pipette access for micropipettes.

BagFilter® Pipet & Roll: Bag with non-woven filter (side filter). Combines the resealable Pipette access with waterproof quick-closure.

Type	Description	Pore size µm	Width mm	Height mm	PK	Cat. No.
BagLight® PolySilk 100	plain bag, sleeve 25		110	185	500	9.570 075 1
BagLight® PolySilk 400	plain bag, sleeve 25		175	300	500	4.662 244
BagLight® PolySilk 400	plain bag, sleeve 50		175	300	500	4.662 937
BagLight® PolySilk 3500	plain bag, sleeve 25		380	510	500	9.570 077
BagLight® Multilayer® 400	plain bag, sleeve 25		190	300	500	6.231 427
BagLight® Multilayer® U 400	plain bag, sleeve 25		190	300	500	6.264 470
BagPage® 100	full-size filter bag, sleeve 25	280	180	95	500	9.570 080
BagPage® + 400	full-size filter bag, sleeve 25	280	190	300	500	9.570 081
BagPage® + 3500	full-size filter bag, sleeve 10	280	380	510	100	9.570 082
BagPage® R 400	full-size filter bag, sleeve 25	250	190	300	500	6.230 760
BagPage® F 400	full-size filter bag, sleeve 25	63	190	300	500	6.257 162
BagPage® XR 400	full-size filter bag, sleeve 25	280	190	300	400	6.239 230
BagFilter® P 400	side filter bag, sleeve 25	250	190	300	500	9.570 078 2
BagFilter® P 3500	side filter bag, sleeve 10	250	380	510	100	9.570 079
BagFilter® Roll	side filter bag, sleeve 25	250	190	300	500	6.292 087
BagFilter® Pipet	side filter bag, sleeve 25	250	190	300	500	6.292 088
BagFilter® Pipet & Roll	side filter bag, sleeve 25	250	190	300	500	4.666 496 3

1



9.570 075

2



9.570 078

3



4.666 496

4 5 6 7 Accessories for blender BagSystem®

interscience

Type	Description	PK	Cat. No.
BagOpen® 80/100	bag opener	1	9.570 083
BagOpen® 400	bag opener	1	9.570 084
BagOpen® 3500	bag opener	1	9.570 085
BagRack® 80/100	bag storage for 11 bags	1	9.570 086
BagRack® 400	bag storage for 10 bags	1	9.570 087
BagRack® Slide	bag storage for 12 bags	1	4.665 797
BagClip® 80/100	bag closure clip	50	9.570 088
BagClip® 400	bag closure clip	50	9.570 089
BagClip® 3500	bag closure clip	50	9.570 090
BagPipet®	pipette with 3 fixed graduations: 0.1, 0.9, 1.0 ml	1	9.570 091
BagTips® Regular	straws for BagPipet®, 19 cm, sterile	1000	9.570 092
BagTips® Jumbo	straws for BagPipet®, 24 cm, sterile	1000	9.570 093

4



5



6



7



➔ Adhesive Labels - please see page 168

Distillation, synthesis	618
Flasks with NS joint neck	618
Components for reaction and distillation	625
Flat ground flange reaction vessels	630
KPG stirrer and bearings.....	632
Dropping Funnels	634
Reflux condenser	635
Distillation-Accessories	637
Components for Extraction.....	639
Gas wash bottles	643
Tubing adapters.....	645
Standard ground stoppers	649
NS joints accessories	650
Ground joints, attachable.....	654
Stopcocks and Valves.....	655
Rotary evaporators	656
Instruments.....	656
Accessories.....	662
Separating, centrifuging	664
Minicentrifuges.....	664
Benchtop centrifuges	669
Centrifuge tubes.....	688
Filtration	699
Filter paper, qualitative.....	699
Filter paper, quantitative.....	710
Glass-fibre filters	716
Membrane filters	721
Syringe filters	729
In-Line filter	741
Filtration apparatus.....	742

6. Distillation, separation, filtration

Distillation, synthesis/Flasks with NS joint neck



1 Round bottom flasks, borosilicate glass 3.3

Resistant to heat and almost all chemicals. According to DIN EN ISO 4797.
Reinforced rims are used to prevent breaking during washing and transportation.

ISOLAB

Capacity	Flask diam.	Neck diam. approx.	Height	Socket	PK	Cat. No.
ml	mm	mm	mm	NS		
50	51	22	105	14/23	1	6.236 508
50	51	22	105	19/26	1	4.008 379
50	51	30	105	24/29	1	4.008 380
50	51	34	105	29/32	1	6.238 345
100	64	22	115	14/23	1	6.236 346
100	64	22	115	19/26	1	4.008 381
100	64	30	115	24/29	1	4.008 382
100	64	34	115	29/32	1	6.236 774
250	85	22	145	19/26	1	4.008 383
250	85	30	145	24/29	1	4.008 384
250	85	34	145	29/32	1	6.236 303
500	105	30	175	24/29	1	4.008 385
500	105	34	175	29/32	1	6.240 426
1000	131	42	210	24/29	1	6.237 702
1000	131	42	210	29/32	1	6.242 240
2000	165	34	260	29/32	1	6.238 472
4000	207	50	315	29/32	1	7.940 038



2 Round bottom flasks with conical ground joint, DURAN®

According to DIN EN ISO 4797 and in addition to DIN standard (*), with inscription label, material: DURAN®.

Lenz

Capacity	Flask diam.	Socket	PK	Cat. No.
ml	mm	NS		
5	30	14/23*	1	6.201 199
10	35	14/23	1	9.011 801
25	41	14/23	1	9.011 802
25	41	19/26	1	7.021 797
50	51	14/23	1	9.011 805
50	51	19/26	1	6.302 116
50	51	24/29	1	7.019 181
50	51	29/32	1	9.011 835
100	64	14/23	1	9.011 810
100	64	19/26	1	6.200 675
100	64	24/29	1	7.019 182
100	64	29/32	1	9.011 840
250	85	14/23*	1	9.011 815
250	85	19/26	1	6.800 202
250	85	24/29	1	6.800 214
250	85	29/32	1	9.011 845
250	85	45/40*	1	9.011 867
500	105	24/29	1	6.800 215
500	105	29/32	1	9.011 850
500	105	45/40	1	9.011 868
1000	131	24/29	1	6.800 235
1000	131	29/32	1	9.011 855
1000	131	45/40	1	9.011 869
2000	166	29/32	1	9.011 860
2000	166	45/40	1	9.011 870
3000	185	29/32*	1	6.077 738
3000	185	45/40*	1	6.901 617
4000	207	29/32	1	9.011 865
4000	207	45/40	1	9.011 875
5000	223	29/32*	1	9.011 864
5000	223	45/40	1	9.011 877
6000	236	29/32*	1	9.011 866
6000	236	45/40	1	9.011 880
10000	279	45/40	1	9.011 885

1 Round bottom flasks, borosilicate glass 3.3, amber

Resistant to heat and almost all chemicals. According to DIN EN ISO 4797.
Reinforced rims are used to prevent breaking during washing and transportation.

ISOLAB

Capacity	Flask diam.	Height	Socket	PK	Cat. No.
ml	mm	mm	NS		
50	51	105	29/32	1	9.141 091
100	64	115	29/32	1	7.980 357
250	85	145	29/32	1	7.980 358
500	105	175	29/32	1	9.141 092
1000	131	210	29/32	1	9.141 093



2 Round bottom flasks with conical ground joint, amber, DURAN®

According to DIN EN ISO 4797, with inscription label, material: DURAN®.

Lenz

Capacity	Flask diam.	Socket	PK	Cat. No.
ml	mm	NS		
50	51	29/32	1	6.242 163
100	64	29/32	1	9.011 827
250	85	29/32	1	9.011 828
500	105	29/32	1	9.011 829
2000	166	29/32	1	6.253 256



3 Kjeldahl flasks with ground neck

Manufactured from borosilicate glass 3.3. according to DIN 12360 standard.
NS necks are in compliance with DIN 12242 standards.

ISOLAB

Capacity	Socket	PK	Cat. No.
ml	NS		
100	19/26	1	9.140 385
250	29/32	1	9.140 386
500	29/32	1	9.140 387
750	29/32	1	9.140 388
1000	29/32	1	9.140 389



4 Kjeldahl flasks, DURAN®

Material: DURAN®. For the determination of nitrogen in organic compounds.
With centre neck and conical joint.

Lenz

Capacity	Flask diam.	NS	PK	Cat. No.
ml	mm			
50	51	19/26	1	9.141 860
100	60	19/26	1	9.141 861
250	81	29/32	1	6.073 310
500	101	29/32	1	6.057 941
750	115	29/32	1	6.233 275
1000	126	29/32	1	7.608 178



6. Distillation, separation, filtration

Distillation, synthesis/Flasks with NS joint neck



1 Pear shape flasks, borosilicate glass 3.3

Manufactured from borosilicate glass 3.3. Conformed to DIN 12383 standards. ISOLAB
 NS neck is in compliance with DIN 12242 standards.

Capacity	Socket	PK	Cat. No.
ml	NS		
10	14/23	1	6.236 347
25	14/23	1	6.237 164
50	14/23	1	6.237 165
100	14/23	1	6.237 166
250	14/23	1	9.140 302
50	29/32	1	9.140 310
100	29/32	1	6.257 941
250	29/32	1	9.140 311



2 Pear shape flasks with conical ground joints, DURAN®

According to DIN 12383* and in addition to DIN standard, with inscription label, material: DURAN® Lenz

Capacity	Socket	Flask diam.	PK	Cat. No.
ml	NS	mm		
10	14/23	33	1	9.012 021
25	14/23	42	1	9.012 022
50	14/23	51	1	9.012 023
100	14/23	64	1	9.012 024
100	19/26 *	64	1	6.224 886



3 Round bottom flasks with two necks, angled arm, borosilicate glass 3.3

Conformed to DIN 12394. The side arms are 20 degree angled with each other. ISOLAB
 NS necks are in compliance with DIN 12242 standards. Two-necked round-bottomed flask available with parallel side arm on request.

Capacity	Centre neck	Angled side necks	PK	Cat. No.
ml	NS	NS		
50	14/23	14/23	1	9.140 320
100	14/23	14/23	1	9.140 321
250	14/23	14/23	1	9.140 322
100	24/29	14/23	1	9.140 323
250	24/29	14/23	1	9.140 324
500	24/29	14/23	1	9.140 325
1000	24/29	14/23	1	9.140 326
100	24/29	19/26	1	9.140 327
250	24/29	19/26	1	9.140 328
500	24/29	19/26	1	9.140 329
1000	24/29	19/26	1	9.140 330
100	29/32	14/23	1	6.243 616
250	29/32	14/23	1	4.008 386
500	29/32	14/23	1	4.008 387
1000	29/32	14/23	1	4.008 388
2000	29/32	14/23	1	9.140 331
100	29/32	19/26	1	9.140 332
250	29/32	19/26	1	9.140 333
500	29/32	19/26	1	9.140 334
1000	29/32	19/26	1	9.140 335
2000	29/32	19/26	1	9.140 336
100	29/32	29/32	1	9.140 337
250	29/32	29/32	1	6.243 617
500	29/32	29/32	1	6.243 618
1000	29/32	29/32	1	6.243 619
2000	29/32	29/32	1	6.243 620

1 Round bottom flasks with two necks, side neck angled, DURAN®

DIN 12394 and in addition to DIN standard (*). With one central and one 20° side angled ground joint necks as outlined below. Material: DURAN®

Lenz

Capacity ml	Centre neck NS	Side necks NS	Flask diam. mm	PK	Cat. No.
25	14/23	14/23*	41	1	9.011 901
50	14/23	14/23*	51	1	9.011 902
100	14/23	14/23*	64	1	9.011 903
100	29/32	14/23*	64	1	9.011 904
100	29/32	19/26*	64	1	6.233 114
100	29/32	29/32*	64	1	6.204 819
250	14/23	14/23*	85	1	9.011 905
250	24/29	19/26*	85	1	6.206 139
250	29/32	14/23	85	1	9.011 906
250	29/32	19/26	85	1	6.225 989
250	29/32	29/32*	85	1	9.011 907
500	29/32	14/23	105	1	9.011 908
500	29/32	19/26	105	1	6.233 091
500	29/32	29/32*	105	1	9.011 910
1000	29/32	14/23	131	1	9.011 915
1000	29/32	19/26	131	1	6.231 953
1000	29/32	29/32*	131	1	9.011 920
2000	29/32	14/23	166	1	6.072 288
2000	29/32	29/32*	166	1	6.056 856
4000	29/32	29/32*	207	1	6.201 298

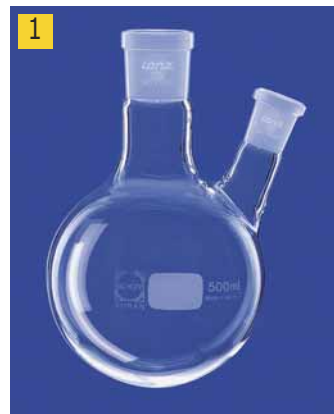

➔ Round bottom flasks with two necks, with parallel side neck available on request

2 Three neck round bottom flasks, side necks parallel, DURAN®

DIN 12392 and in addition to DIN standard (*). All necks are parallel.

Lenz

Capacity ml	Centre neck NS	Side necks NS	Flask diam. mm	PK	Cat. No.
100	24/29	19/26*	64	1	6.205 694
100	29/32	14/23*	64	1	9.011 933
100	29/32	19/26*	64	1	6.306 275
100	29/32	29/32	64	1	6.235 645
250	24/29	19/26*	85	1	7.021 838
250	29/32	14/23*	85	1	9.011 935
250	29/32	29/32*	85	1	9.011 936
500	24/29	19/26*	105	1	7.021 840
500	29/32	14/23*	105	1	9.011 938
500	29/32	19/26*	105	1	7.019 244
500	29/32	29/32*	105	1	9.011 939
1000	29/32	14/23*	131	1	9.011 941
1000	29/32	19/26*	131	1	6.203 572
1000	29/32	29/32	131	1	9.011 942
1000	45/40	29/32*	131	1	9.011 943
2000	29/32	14/23*	166	1	9.011 945
2000	29/32	19/26*	166	1	6.203 571
2000	29/32	29/32	166	1	9.011 946
2000	45/40	29/32	166	1	9.011 947
3000	29/32	29/32*	185	1	6.203 569
4000	29/32	14/23*	207	1	6.238 532
4000	29/32	29/32*	207	1	7.200 347
4000	45/40	29/32	207	1	9.011 950
5000	29/32	29/32*	223	1	6.306 286
5000	45/40	29/32*	223	1	9.011 949
6000	29/32	14/23*	236	1	6.803 543
6000	29/32	29/32	236	1	6.072 558
6000	45/40	29/32	236	1	9.011 951
10000	45/40	29/32*	279	1	9.011 952



6. Distillation, separation, filtration

Distillation, synthesis/Flasks with NS joint neck



1 Round bottom flasks with three necks, NS joints, angled side arms, borosilicate glass 3.3

Conformed to DIN 12394. The side arms are at 20 degree angles with the centre neck. The NS necks are in compliance with DIN 12242 standards.

ISOLAB

Capacity	Flask diam.	Centre neck	Angled side necks	PK	Cat. No.
ml	mm	NS	NS		
250	85	29/32	14/23	1	4.008 390
250	85	29/32	19/26	1	4.008 393
250	85	29/32	29/32	1	6.240 976
500	105	29/32	14/23	1	4.008 391
500	105	29/32	19/26	1	4.008 394
500	105	29/32	29/32	1	6.240 977
1000	131	29/32	14/23	1	4.008 392
1000	131	29/32	19/26	1	4.008 395
1000	131	29/32	29/32	1	6.240 978
2000	166	29/32	29/32	1	4.008 396



2 Three-neck round-bottom flasks, side necks angled, DURAN®

DIN 12394 and in addition to DIN standard (*). Central neck with 2 x 20° angled side necks.

Lenz

Capacity	Centre neck	Side necks	Flask diam.	PK	Cat. No.
ml	NS	NS	mm		
50	19/26	14/23*	51	1	6.202 804
100	24/29	19/26*	64	1	6.204 321
100	29/32	14/23*	64	1	9.011 953
100	29/32	19/26*	64	1	6.204 852
100	29/32	29/32*	64	1	7.019 272
250	24/29	19/26*	85	1	6.204 322
250	29/32	14/23	85	1	9.011 955
250	29/32	19/26	85	1	9.011 957
250	29/32	29/32	85	1	9.011 956
500	29/32	14/23*	105	1	9.011 958
500	29/32	19/26	105	1	9.011 960
500	29/32	29/32	105	1	9.011 959
1000	29/23	14/23	131	1	9.011 961
1000	29/32	19/26	131	1	9.011 964
1000	29/32	29/32*	131	1	9.011 962
1000	45/40	29/32*	131	1	9.011 963
2000	29/32	14/23	166	1	9.011 965
2000	29/32	29/32*	166	1	9.011 966
2000	45/40	29/32*	166	1	9.011 967
3000	29/32	29/32*	185	1	6.203 014
4000	29/32	29/32*	207	1	7.615 379
4000	45/40	29/32*	207	1	9.011 968
5000	45/40	29/32*	223	1	9.011 971
6000	45/40	29/32*	236	1	9.011 969
10000	45/40	29/32*	279	1	9.011 970



3 Four-neck round-bottom flask, with parallel side necks, DURAN®

Reaction flasks acc. to DIN 12392 and in addition to DIN standard (*), with 3 parallel side necks, with conical ground joints, with inscription label, material: DURAN®

Lenz

Capacity	Centre neck	Side necks	Flask diam.	PK	Cat. No.
ml	NS	NS	mm		
500	29/32	29/32*	105	1	7.019 293
1000	29/32	29/32	131	1	6.079 458
2000	29/32	29/32	166	1	6.203 263
3000	29/32	29/32*	185	1	6.902 383
4000	29/32	29/32	207	1	6.202 988
6000	29/32	29/32	236	1	6.280 242
1000	45/40	29/32	131	1	6.229 949
2000	45/40	29/32	166	1	6.307 818
4000	45/40	29/32*	207	1	6.307 819
5000	45/40	29/32	223	1	6.288 715
6000	45/40	29/32	236	1	6.307 817

1 Nitrogen round-bottom flasks (Schlenk-flasks), DURAN®

With an angled side arm with 2.5 mm glass stopcock. Material: DURAN®

Lenz

Capacity	Socket	Bore	PK	Cat. No.
ml	NS	mm		
25	14/23	2.5	1	6.800 337
50	14/23	2.5	1	6.307 820
50	29/32	2.5	1	6.802 978
100	14/23	2.5	1	6.307 327
100	29/32	2.5	1	6.307 821
250	14/23	2.5	1	6.206 524
250	29/32	2.5	1	6.073 481
500	29/32	2.5	1	6.307 822
1000	29/32	2.5	1	6.307 823



2 Nitrogen tubes (Schlenk-tubes), DURAN® tubing

Made of DURAN® tubing. With conical joint and NS glass stopcock.

Lenz

Capacity	Centre neck	Bore	PK	Cat. No.
ml	NS	mm		
10	14/23 Socket	2.5	1	7.610 673
25	14/23 Socket	2.5	1	7.610 674
50	14/23 Socket	2.5	1	6.901 799
100	14/23 Socket	2.5	1	6.401 203
250	14/23 Socket	2.5	1	7.200 160



3 Flat bottom flasks, NS joint neck, borosilicate glass 3.3

Borosilicate glass 3.3. Resistant to heat and almost all chemicals. According to DIN EN ISO 4797.

ISOLAB

Capacity	Socket	Height	PK	Cat. No.
ml	NS	mm		
50	14/23	100	1	6.243 606
50	19/26	100	1	6.243 607
50	24/29	100	1	6.243 608
50	29/32	100	1	4.008 377
100	14/23	110	1	6.243 609
100	19/26	110	1	6.243 610
100	24/29	110	1	6.243 611
100	29/32	110	1	6.236 773
250	19/26	140	1	6.243 612
250	24/29	140	1	6.243 613
250	29/32	140	1	6.238 346
500	24/29	170	1	6.243 614
500	29/32	170	1	6.240 425
1000	24/29	200	1	6.243 615
1000	29/32	200	1	4.008 378
2000	29/32	250	1	6.237 704
4000	29/32	320	1	6.311 691



4 Flat bottom flasks with conical ground joint, DURAN®

According to DIN EN ISO 4797 and in addition to DIN standard (*), with inscription label.

Lenz

Volume	Socket	Flask external diam.	PK	Cat. No.
ml	NS	mm		
50	29/32	51	1	9.011 982
100	29/32	64	1	9.011 983
250	29/32	85	1	9.011 984
500	19/26*	105	1	6.227 431
500	29/32	105	1	9.011 985
1000	29/32	131	1	9.011 986



6. Distillation, separation, filtration

Distillation, synthesis/Flasks with NS joint neck



1 Erlenmeyer flasks, NS neck, borosilicate glass 3.3

Borosilicate glass 3.3. Conformed to DIN EN ISO 4797. NS necks are in compliance with DIN 12242 standards. Inscriptions are in white enamel which is specially designed for glass use.

ISOLAB

Capacity	Height	Socket	PK	Cat. No.
ml	mm	NS		
50	85	14/23	1	9.141 105
50	85	19/26	1	9.141 106
50	85	29/32	1	9.141 107
100	100	14/23	1	9.141 108
100	100	19/26	1	6.238 553
100	100	29/32	1	9.141 109
250	140	29/32	1	9.141 110
300	156	29/32	1	9.141 111
500	175	29/32	1	9.141 112
1000	220	29/32	1	9.141 113



2 Erlenmeyer flasks with ground joint, DURAN®

Acc. to DIN EN ISO 4797 and in addition to DIN standard (*), with scale (approx. volume/ml), with inscription label, material: DURAN®.

Lenz

Capacity	Socket	Flask diam.	PK	Cat. No.
ml	NS	mm		
10	14/23	42	1	6.200 447
25	14/23	42	1	9.012 001
25	19/26	42	1	7.019 150
50	14/23	51	1	9.012 002
50	24/29	51	1	7.019 155
50	29/32	51	1	9.012 012
100	14/23	64	1	9.012 003
100	24/29	64	1	7.019 156
100	29/32	64	1	9.012 013
200	29/32*	79	1	9.012 017
250	24/29	85	1	6.200 677
250	29/32	85	1	9.012 014
250	45/40*	85	1	9.012 006
300	29/32*	87	1	9.012 018
500	29/32	105	1	9.012 015
500	45/40*	105	1	9.012 008
1000	29/32	131	1	9.012 016
1000	45/40*	131	1	9.012 009
2000	29/32	166	1	9.012 019
2000	45/40*	166	1	9.012 010
3000	45/40	185	1	6.900 828
5000	45/40	223	1	7.607 913



3 Erlenmeyer flasks, NS neck, borosilicate glass 3.3, amber

Borosilicate glass 3.3, amber. Conformed to DIN EN ISO 4797. NS necks are in compliance with DIN 12242 standards.

ISOLAB

Capacity	Height	Socket	PK	Cat. No.
ml	mm	NS		
100	100	29/32	1	6.258 244
250	140	29/32	1	6.258 150
500	175	29/32	1	6.255 806
1000	220	29/32	1	9.140 401



7.614 642



6.230 826

Iodine determination flasks, with and without collar, DURAN®

- With overflow collar and NS29/32 iodine stopper.
- Without overflow collar, with NS29/32 hollow hexagonal stopper.

Lenz

Description	Capacity	Flask external diam.	Version	PK	Cat. No.
	ml	mm			
without collar	100	64	hollow	1	6.072 077
without collar	250	85	hollow	1	6.401 428
without collar	300	87	hollow	1	7.614 642 4
without collar	500	105	hollow	1	6.226 757
without collar	1000	131	hollow	1	6.230 605
with collar	100	64	iodine stopper	1	6.258 682
with collar	250	85	iodine stopper	1	6.230 826 5
with collar	500	105	iodine stopper	1	7.980 791

6. Distillation, separation, filtration

Distillation, synthesis/Components for reaction and distillation

1 Distilling Adapters, borosilicate glass 3.3

Manufactured from borosilicate glass 3.3. Suitable to be used in distillation assemblies for connecting flasks to condenser. Upper socket designed to accept thermometer either by screw thread adapter or by thermometer socket.
With side cone at 75° angled to the center socket.

ISOLAB

Cone vertical NS	Cone obliquely NS	Socket NS	PK	Cat. No.
14/23	14/23	14/23	1	9.043 301
19/26	19/26	14/23	1	9.043 302
29/32	29/32	14/23	1	9.043 305

1



Distilling heads acc. to Claisen, sloping, DURAN® tubing

Made of DURAN® tubing. Acc. to DIN 12594 and in addition to DIN standard (*), with two parallel NS 14/23 sockets and two NS cones (descending angle: 75°), for distillation thermometers of 55 mm built-in length.

Lenz

Cone vertical NS	Cone obliquely NS	Socket NS	PK	Cat. No.
29/32	14/23	14/23*	1	9.012 182
29/32	29/32	14/23	1	9.012 183

2



9.012 183

3 Stillheads, ground glass joint, with integral Liebig condenser

Manufactured from borosilicate glass 3.3 which is resistant to heat and almost all chemicals. With liebig condenser and socket NS 14/23 for distillation thermometers. Available with or without vacuum receiver adapter.

ISOLAB

Description	Effective length mm	Cone NS	Socket NS	PK	Cat. No.
without vacuum receiver adapter	160	14/23	14/23	1	9.012 291
without vacuum receiver adapter	250	14/23	14/23	1	9.012 292
without vacuum receiver adapter	250	29/32	14/23	1	9.012 293
without vacuum receiver adapter	400	29/32	14/23	1	9.012 294
with vacuum receiver adapter	160	14/23	14/23	1	9.012 295
with vacuum receiver adapter	250	14/23	14/23	1	9.012 296
with vacuum receiver adapter	250	29/32	14/23	1	4.008 375
with vacuum receiver adapter	400	29/32	14/23	1	9.012 297

3



Distilling links with Liebig condenser and vacuum receiver adapter, DURAN® tubing

Made of DURAN® tubing. DIN 12596. With Liebig condenser at 75° and vertical outlet with NS cone and vacuum connection with glass olives or thread GL14. With socket NS 14/23 for distillation thermometers of 55mm built-in length.

Lenz

Effective length mm	Cone NS	Socket NS	Connection	PK	Cat. No.
160	14/23	14/23	GL	1	6.203 415
250	29/32	14/23	GL	1	6.203 416
250	14/23	14/23	GL	1	9.012 264
250	29/32	14/23	olive	1	9.012 266
400	29/32	14/23	olive	1	9.012 268

4

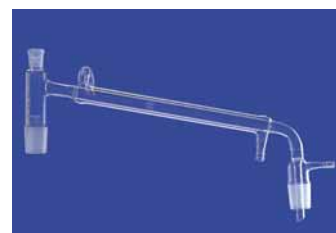

9.012 266

5 Distilling links with Liebig condenser and Claisen head

With Liebig condenser and Claisen head and socket NS 14/23 for distillation thermometers. Available with or without vacuum receiver adapter.

ISOLAB

Description	Effective length mm	Cone NS	Socket NS	PK	Cat. No.
distilling link standard	160	14/23	14/23	1	9.012 247
distilling link standard	250	14/23	14/23	1	9.012 248
distilling link standard	250	29/32	14/23	1	9.012 249
distilling link standard	400	29/32	14/23	1	9.012 250
distilling link with vakuum adapter	160	14/23	14/23	1	9.012 216
distilling link with vakuum adapter	250	14/23	14/23	1	9.012 217
distilling link with vakuum adapter	250	29/32	14/23	1	9.012 218
distilling link with vakuum adapter	400	29/32	14/23	1	9.012 219

5

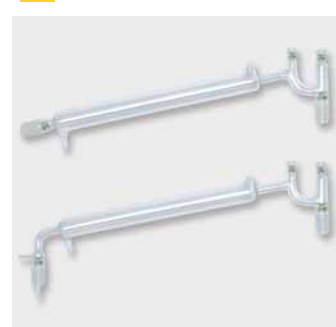

Distillation, synthesis/Components for reaction and distillation

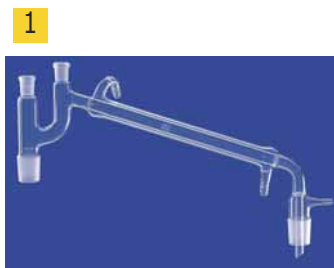

1 Distilling links acc. to Claisen with vacuum receiver adapter, DURAN® tubing

Made of DURAN® tubing. According to DIN 12594. With Liebig condenser (angled 75°) and vertical Claisen head, water and vacuum connection with olives. With two sockets NS 14/23 for distillation thermometers of 55mm built-in length.

Lenz

Effective length mm	Cone NS	Socket NS	PK	Cat. No.
160	14/23	14/23	1	9.012 271
250	29/32	14/23	1	9.012 276



2 Distillation adapters

Manufactured from borosilicate glass 3.3. Suitable for feeding distillate from condensers into receiving flasks. Stem length is either 65 mm or 200 mm. Socket inclined 105° with outer tube of 12 mm diameter.

ISOLAB

Length outlet pipe mm	Socket NS	PK	Cat. No.
65	14/23	1	6.244 591
65	29/32	1	6.244 592
200	14/23	1	6.244 593
200	29/32	1	6.244 594



3 Bends, DURAN® tubing

Made of DURAN® - tubing. Bent 75° or 90°. With two NS cones.

Lenz

NS	Angle	PK	Cat. No.
14/23	75	1	9.012 141
29/32	75	1	9.012 143
14/23	90	1	6.306 285
19/26	90	1	7.018 680
24/29	90	1	7.018 681
29/32	90	1	9.012 153



4 Adapters bent or straight, borosilicate glass 3.3

Manufactured from borosilicate glass 3.3. Bent adapters are available as plain bend or bend with vent with 105° angled body shape.

ISOLAB

Description	Cone		Socket	PK	Cat. No.
	NS	NS			
Adapter, bent	14/23	14/23	14/23	1	6.243 602
Adapter, bent	29/32	29/32	29/32	1	6.243 603
Adapter, bent, with ventilation	14/23	14/23	14/23	1	9.012 657
Adapter, bent, with ventilation	29/32	29/32	29/32	1	9.012 658
Adapter, straight, with vacuum connector	14/23	14/23	14/23	1	9.012 659
Adapter, straight, with vacuum connector	29/32	29/32	29/32	1	9.012 660



5 Distillation adapters, borosilicate glass 3.3

Manufactured from borosilicate glass 3.3. Suitable for the usage of assembling with vacuum connections. Available in two shapes: straight or angled 105°.

ISOLAB

Description	Cone		Socket	PK	Cat. No.
	NS	NS			
adapters straight	14/23	14/23	14/23	1	6.243 604
adapters straight	29/32	29/32	29/32	1	4.008 370
adapters bend	14/23	14/23	14/23	1	4.008 371
adapters bend	29/32	29/32	29/32	1	4.008 372

6. Distillation, separation, filtration

Distillation, synthesis/Components for reaction and distillation

Receiver adapters, with olives, DURAN® tubing

Made of DURAN® tubing. Acc. to DIN 12594, straight or bent (105°), with NS socket and cone, with drain tip, vacuum connection: glass olive.

Lenz

Description	Cone		Socket		PK	Cat. No.
	NS	NS	NS	NS		
straight	14/23	14/23	14/23	14/23	1	9.012 611
bend	14/23	14/23	14/23	14/23	1	9.012 613
straight	29/32	29/32	29/32	29/32	1	9.012 621 1
bend	29/32	29/32	29/32	29/32	1	9.012 623 2

1

2



9.012 621



9.012 623

3 Distributors for distilling receivers to Bredt, DURAN® tubing

Made of DURAN® tubing. With four cones NS 14/23, for round bottom flasks up to 250 ml volume.

Lenz

Description	PK	Cat. No.
Upper core 19/26	1	9.012 695
Upper core 29/32	1	9.012 696

3



4 Distilling receivers acc. to Bernauer, DURAN® tubing

Made of DURAN® tubing. With 3 cones NS 14/23, vacuum connection with glass olive.

Lenz

Type	Cone		Socket		PK	Cat. No.
	NS	NS	NS	NS		
Distilling Receivers, without flask	14/23	14/23	14/23	14/23	1	6.210 168
Distilling Receivers, without flask	14/23	14/23	29/32	29/32	1	6.236 954

4



5 Columns acc. to Hempel, DURAN® tubing

Made of DURAN® tubing. With packing material support, ground glass cone and socket

Lenz

Fill height mm	Cone		Socket		PK	Cat. No.
	NS	NS	NS	NS		
300	14/23	14/23	14/23	14/23	1	9.012 321
300	29/32	29/32	29/32	29/32	1	9.012 322
800	29/32	29/32	29/32	29/32	1	9.012 326

5

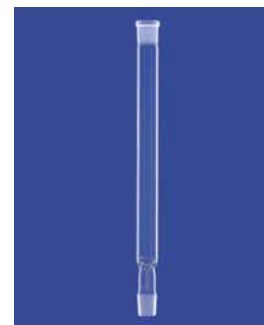

6 Columns acc. to Hempel with fixed vacuum jacket, DURAN® tubing

Made of DURAN® tubing. For packings like Raschig rings or glass beads, with NS socket and NS cone, with fixed vacuum jacket.

Lenz

Fill height mm	Cone		Socket		PK	Cat. No.
	NS	NS	NS	NS		
200	14/23	14/23	14/23	14/23	1	6.241 715
300	29/32	29/32	29/32	29/32	1	9.012 327
500	29/32	29/32	29/32	29/32	1	9.012 328
800	29/32	29/32	29/32	29/32	1	9.012 329

6



1

1 Glass beads type M

Type AR soda lime glass. Supplied in packs of approx. 1 kg.

Ø mm	PK	Cat. No.
1,5 - 2	1000	9.012 402
3	1000	9.012 403
4	1000	9.012 404
4,5	1000	6.254 325
5	1000	9.012 405
6	1000	9.012 406
7	1000	6.254 523
8	1000	9.012 407
10	1000	9.012 408
14	1000	9.012 410

Further products can be found in our online shop.

2

2 Raschig rings, glass

Pack of 1 kg.

Type	PK	Cat. No.
3x3	1	9.012 413
4x4	1	9.012 414
5x5	1	9.012 415
6x6	1	9.012 416
8x8	1	9.012 417
10x10	1	6.244 044

Glass wool please see page 1475.



9.012 336

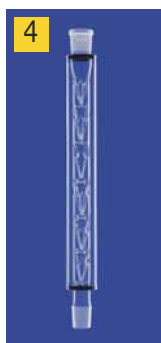

9.012 330

Columns acc. to Vigreux, with or without removable glass jacket, DURAN® tubing

Made of DURAN® tubing.

Lenz

Fill height mm	NS	Type	PK	Cat. No.
200	14/23	without jacket	1	6.304 939
300	14/23	without jacket	1	6.900 157
300	29/32	without jacket	1	9.012 336 3
600	29/32	without jacket	1	9.012 337
200	14/23	with jacket	1	6.070 046
300	14/23	with jacket	1	6.079 073
300	29/32	with jacket	1	9.012 330 4
600	29/32	with jacket	1	7.628 209

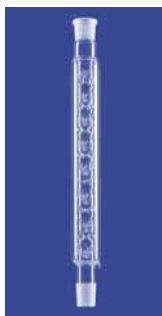
5

5 Columns acc. to Vigreux with fixed vacuum jacket, DURAN® tubing.

Made of DURAN® tubing. With NS socket and NS cone, with fixed vacuum jacket.

Lenz

Fill height mm	NS	PK	Cat. No.
200	14/23	1	7.613 796
300	14/23	1	9.012 333
300	29/32	1	6.073 183
600	29/32	1	6.226 643

6

6 Drying tubes, HDPE

Removable stoppers at both tube ends. With tubing nozzles, Ø 8 - 10 mm.

Kartell

External dimensions (Ø x L) mm	Overall length mm	PK	Cat. No.
20 x 100	170	1	9.253 131
20 x 150	220	1	9.253 135
20 x 200	270	1	9.253 140

1 Drying tubes, U-pattern

Made of borosilicate glass 3.3. DIN 12616.
Drying tubes with NS incl. interchangeable ground joint stopcocks.
U-shape. Hose connectors 6 mm in diameter.

ISOLAB

Description	Diam. mm	Length mm	NS	PK	Cat. No.
without stopcock	13	100	-	1	9.140 515
without stopcock	13	130	-	1	9.140 516
without stopcock	18	180	-	1	9.140 517
with stopcock	13	100	14/23	1	9.140 518
with stopcock	13	130	14/23	1	9.140 519
with stopcock	18	180	19/26	1	9.140 520



2 Drying tubes, DURAN® tubing

Made of DURAN® tubing. Angled to 75°.

Lenz

Cone	PK	Cat. No.
NS		
14/23	1	9.012 701
29/32	1	9.012 703



3 Multiple adapters, 2-necks, DURAN® tubing

Made of DURAN® tubing. With two sockets and one cone.
One neck 105° upwards.

Lenz

Cone	Socket	Socket lateral	PK	Cat. No.
NS	NS	NS		
14/23	14/23	14/23	1	9.012 101
19/26	19/26	19/26	1	6.232 027
29/32	29/32	14/23	1	7.610 631
29/32	29/32	29/32	1	9.012 103



4 Multiple adapter, 2-neck, DURAN® tubing

Made of DURAN® tubing. Acc. to DIN 12594 and in addition to DIN standard (*),
with two parallel necks, with two NS sockets and one NS cone.

Lenz

Cone	Socket	Socket lateral	PK	Cat. No.
NS	NS	NS		
29/32	14/23	14/23*	1	6.232 074
14/23	14/23	14/23	1	9.012 121
29/32	29/32	29/32	1	9.012 123



Splash heads acc. to Stutzer, straight or bent, DURAN® tubing

Made of DURAN® tubing.

Lenz

Two versions available:

- straight, with cone and socket
- bent with two cones at 75°.

Splash heads are directly placed onto distillation flasks for separation of drops.

Description	Cone	Socket / cone bent	PK	Cat. No.
	NS	NS		
straight	14/23	29/32	1	6.202 459
straight	29/32	29/32	1	9.012 193 5
bent	29/32	29/32	1	9.012 138 6

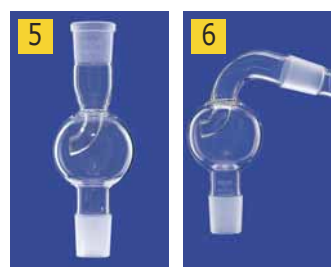

9.012 193

9.012 138

6. Distillation, separation, filtration

Distillation, synthesis/Flat ground flange reaction vessels



1 Reaction flasks, flat flange, DURAN®

Flanged neck with groove for vacuum use. 500 ml and 1000 ml vessels are completely cylindrical. *DWK Life Sciences*
Capacities indicated are brim-full volumes. Glass Type I/neutral glass as per USP, EP and JP.
Autoclavable.

Capacity ml	Capacity ml	Flange diam. mm	Body diam. mm	Height mm	Pressure bar	DN	PK	Cat. No.
100	195	100	70	85	2,5*	60	1	9.142 024
250	315	100	70	125	2,5*	60	1	9.142 036
500	740	138	106	120	1,5*	100	1	9.142 044
1000	1395	138	106	205	1,5*	100	1	9.142 054
2000	2620	138	140	270	1,5*	100	1	9.142 063
4000	5765	184	200	290	1,0*	150	1	9.142 071
6000	7320	184	215	320	1,0*	150	1	9.142 076

* Maximum permissible operating pressure measured at 250 °C.



2 Flat ground flange lids, DURAN®

With four ground joint necks as outlined below. Centre neck NS 29/32. 1bar max. *DWK Life Sciences*
operating pressure at 250 °C. Glass Type I/neutral glass as per USP, EP and JP.
Autoclavable.

Flange diam. mm	Height mm	Side necks NS	DN	PK	Cat. No.
138	125	3 x 29/32 angled	100	1	9.142 246
138	105	2 x 29/32 angled, 1 x 14/23 parallel	100	1	9.142 476
158	130	2 x 29/32 angled, 1 x 14/23 parallel	120	1	9.142 251
184	130	3 x 29/32 parallel	150	1	9.142 257
184	130	2 x 29/32 angled, 1 x 14/23 parallel	150	1	9.142 259



3 Reaction vessels, cylindrical, with thermostatic jacket

- With graduation
- Laboratory flange LF
- Groove
- Flat bottom
- Two connectors with threads GL 14 or GL 18
- Made of DURAN® tubing

Lenz

Other sizes on request.

Nominal capacity ml	Flange (LF)	Outer/ inner diam. mm	Height mm	Int. height mm	Connection	PK	Cat. No.
100	60	90/60	135	115	GL 14	1	9.142 726
250	60	90/60	190	170	GL 14	1	9.142 727
500	60	90/60	275	255	GL 14	1	9.142 728
1000	60	90/60	245	220	GL 18	1	6.243 104
250	100	130/93	160	140	GL 18	1	6.243 105
500	100	130/93	180	155	GL 18	1	9.142 741
1000	100	130/93	245	220	GL 18	1	9.142 742
2000	100	130/93	375	350	GL 18	1	9.142 744
3000	100	190/150	325	285	GL 18	1	6.243 106
4000	100	190/150	380	340	GL 18	1	9.142 747
2000	150	190/150	265	225	GL 18	1	9.142 754
3000	150	190/150	320	280	GL 18	1	6.089 893
4000	150	190/150	375	335	GL 18	1	9.142 757
5000	150	190/150	430	390	GL 18	1	6.243 107
6000	150	190/150	485	445	GL 18	1	9.142 759



4 Clamps with stand rod

For fixing lids onto reaction vessels and mounting on a stand,
Material: polyester-glass compound (clamp), steel (rod)

Lenz

For flange DN	PK	Cat. No.
60	1	9.142 697
100	1	9.142 699
150	1	9.142 698

1 Reaction vessels, cylindrical, with thermostatic jacket and withdrawal valve



- With graduation
- Laboratory flange LF
- With groove
- Two connectors with threads GL 14 or GL 18
- Made of DURAN® tubing

Lenz

Other sizes on request.

Nominal capacity	Flange (LF)	Outer/inner diam.	Height	Int. height	Connection	Bore	PK	Cat. No.
ml		mm	mm	mm		mm		
100	60	90/60	245	115	GL 14	10	1	9.142 766
250	60	90/60	300	170	GL 14	10	1	9.142 767
500	60	90/60	385	255	GL 14	10	1	9.142 768
1000	60	90/60	360	220	GL 14	10	1	6.233 770
250	100	130/99	275	140	GL 18	10	1	6.230 277
500	100	130/99	295	155	GL 18	10	1	9.142 781
1000	100	130/99	360	220	GL 18	10	1	9.142 782
2000	100	130/99	490	350	GL 18	10	1	9.142 784
3000	100	190/150	440	285	GL 18	10	1	6.243 114
4000	100	190/150	495	340	GL 18	10	1	9.142 787
2000	150	190/150	375	225	GL 18	10	1	6.233 793
3000	150	190/150	430	280	GL 18	10	1	6.243 115
4000	150	190/150	485	335	GL 18	10	1	7.635 340
5000	150	190/150	540	390	GL 18	10	1	6.224 194
6000	150	190/150	595	445	GL 18	10	1	6.243 116
10000	150	315/240	640	480	GL 18	20	1	6.240 516



2 Flat flange lids

Flange in accordance with DIN 12214.

Height	Flange DN	Centre neck	Parallel side necks	Angled side necks	PK	Cat. No.
mm	mm	NS	NS	NS		
125	100	29/32	-	2 x 29/32	1	9.142 120
125	100	29/32	2 x 29/32	-	1	9.142 121
125	100	29/32	1 x 14/23	2 x 29/32	1	9.142 122
125	100	29/32	2 x 29/32	2 x 29/32	1	9.142 123
150	100	45/40	-	2 x 29/32	1	9.142 124
150	100	45/40	1 x 14/23	2 x 29/32	1	9.142 126
150	100	45/40	2 x 29/32	2 x 29/32	1	9.142 127
125	120	29/32	-	2 x 29/32	1	9.142 128
125	120	29/32	2 x 29/32	-	1	9.142 129
125	120	29/32	1 x 14/23	2 x 29/32	1	9.142 130
125	120	29/32	2 x 29/32	2 x 29/32	1	9.142 131
150	120	45/40	-	2 x 29/32	1	9.142 132
150	120	45/40	2 x 29/32	-	1	9.142 133
150	120	45/40	1 x 14/23	2 x 29/32	1	9.142 134
150	120	45/40	2 x 29/32	2 x 29/32	1	9.142 135
125	150	29/32	-	2 x 29/32	1	9.142 136
125	150	29/32	2 x 29/32	-	1	9.142 137
125	150	29/32	1 x 14/23	2 x 29/32	1	9.142 138
125	150	29/32	2 x 29/32	2 x 29/32	1	9.142 139
150	150	45/40	-	2 x 29/32	1	9.142 140
150	150	45/40	2 x 29/32	-	1	9.142 141
150	150	45/40	1 x 14/23	2 x 29/32	1	9.142 142
150	150	45/40	2 x 29/32	2 x 29/32	1	9.142 143

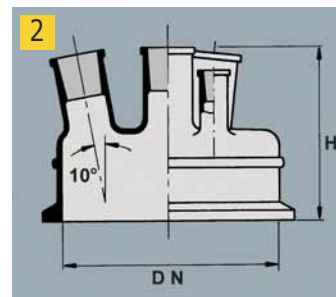

3 Quick-acting closures

Stainless steel. With three-part caliper clamps.

For flange DN	PK	Cat. No.
60	1	6.901 260
100	1	9.142 946
120	1	9.142 951
150	1	9.142 957
200	1	9.142 964



6. Distillation, separation, filtration

Distillation, synthesis/KPG stirrer and bearings

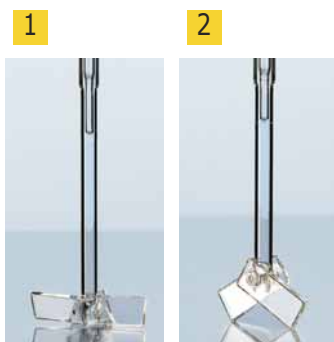

1 2 KPG stirrer shafts, DURAN®

DURAN®. Interchangeable. Bearing surface ground and polished.

DWK Life Sciences

WG: 4 fixed blades
 WS: 2 movable blade
 KPG diameter: 10 mm
 KPG length: 160 mm.

Type	For neck diam. mm	Length mm	PK	Cat. No.
WG 10	60	320	1	9.197 321
WG 10	60	370	1	9.197 322
WS 10	25	320	1	9.197 311
WS 10	25	370	1	9.197 312
WS 10	25	410	1	9.197 313
WS 10	25	440	1	9.197 314



3 KPG stirrer bearings, DURAN®

Interchangeable. Bearing surface ground, polished. With or without standard ground cone NS 29/32.

DWK Life Sciences

Type	Diam. mm	Height mm	Cone NS	PK	Cat. No.
HA 10	10	65	no	1	9.197 251
HB 10	10	75	no	1	9.197 252
HB 16	16	90	no	1	9.197 257
HQ 10	10	75	yes	1	9.197 253
HT 10	10	65	yes	1	9.197 256
HT 16	16	85	yes	1	9.197 258



4 Stirrer with stirrer bearings, DURAN® tubing

Made of DURAN® tubing. For round bottom flasks 250 to 2000ml. Stirrer shaft, with PTFE stirrer blade and fixing screw. Seals vacuum stirring apparatus gas-tight to 10⁻³ mbar up to a permanent load of 800 rpm.

Lenz

Type	PK	Cat. No.
Stirrer with stirrer bearing, complete	1	9.198 050 4
Shaft, Dia. 10 x L 400 mm	1	6.802 957
Blade, PTFE, 70x24x3 mm	1	6.204 794
Screw, PTFE	1	6.204 795
Sealing, PTFE	1	7.616 277
Closure, thread GL 25, cone NS 29/32	1	6.258 683
Pressure spring, stainless steel	1	6.258 684
Screw cap GL 25, PP	1	6.258 685

9.198 050



1 Stirrer bearings with GL male thread, DURAN® tubing

Made of DURAN® tubing. Other materials used: PTFE (bearing), silicone (gasket) and stirrer guides, GL male thread. Cone size 29/32. Guide bore 10 mm i.d.

Lenz

Ø agitator shaft mm	Length mm	Neck thread		PK	Cat. No.
		GL	NS		
10	70	25	29/32	1	9.197 355
10	85 ± 3	25	45/40	1	6.223 283
16	85 ± 3	32	45/40	1	9.197 356



2 Glass Stirrer Bearings, PTFE

Combination of a borosilicate glass piece with ground joint, an interior PTFE shaft guide with integrated special gasket and a GL screw cap made of PPS. The special gasket made of PTFE and an FPM o-ring which is compressed by a GL screw cap provide a good sealing of the stirrer shaft. This gasket can be exchanged after wearing. Suitable for vacuum, perfect bearing for stirrer shafts made of stainless steel, glass and for BOLA Stirrer Shafts.

BOLA

Cone	For diam. stirring rod	Overall length	Neck thread	PK	Cat. No.
NS	mm	mm	GL		
29/32	10	90	25	1	6.088 059



3 Stirrer Bearings, PTFE

The sealing rings on these bearings ensure a perfect sealing. The ground joint no longer sticks, the danger of breaking is reduced and the cone can be removed easily from the socket. A special gasket made of PTFE and an FPM o-ring which is compressed by a GL screw cap provide a good sealing of the stirrer shaft. This gasket can be exchanged after wearing. Suitable for vacuum, perfect bearing for stainless steel, glass and BOLA Stirrer Shafts.

BOLA

For diam. stirring rod	Overall length	Neck thread	Cone	PK	Cat. No.
mm	mm	GL	NS		
6	63	18	19/26	1	6.900 411
8	65	25	19/26	1	6.233 200
8	69	25	24/29	1	6.251 738
10	70	25	24/29	1	6.253 704
6	72	18	29/32	1	6.087 538
8	74	25	29/32	1	6.076 532
10	72	25	29/32	1	6.088 058
10	80	25	45/40	1	6.800 985
16	86	32	45/40	1	6.232 941



4 Stirrer bearings with dynamic double seal

Stirrer bearings for applications under vacuum or under slight overpressure. With extended guidance for reduced vibrations and a longer lifetime. Material: borosilicate glass 3.3 (closure), PTFE (sealings)

Lenz

For diam. stirring rod	NS	PK	Cat. No.
mm			
10	29/32	1	7.629 417
10	45/40	1	9.197 359
16	29/32	1	9.197 363
16	45/40	1	9.197 364





4.008 428

Dropping funnels, cylindrical, with or without pressure equalizing tube, Borosilicate glass 3.3

Borosilicate glass 3.3. PTFE stopcock, PE stoppers. cylindrical shape, with or without pressure equalising tube. ISO 4800 and DIN 12242.

ISOLAB

Type	Capacity ml	Cone NS	Socket NS	PK	Cat. No.
with relief tube	50	29/32	19/26	1	9.140 415
with relief tube	100	29/32	19/26	1	4.008 428 1
with relief tube	250	29/32	29/32	1	6.240 982
with relief tube	500	29/32	29/32	1	6.240 983
with relief tube	1000	29/32	29/32	1	9.140 416
without relief tube	50	29/32	19/26	1	9.140 410
without relief tube	100	29/32	19/26	1	9.140 411
without relief tube	250	29/32	29/32	1	9.140 412
without relief tube	500	29/32	29/32	1	9.140 413
without relief tube	1000	29/32	29/32	1	9.140 414

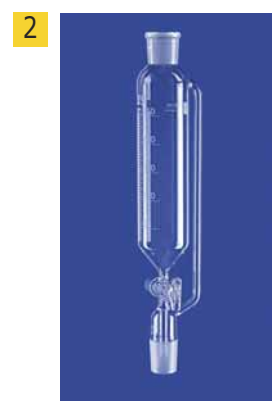

9.012 769

Dropping funnels, cylindrical, with pressure equalizing tube, borosilicate glass 3.3

Borosilicate glass 3.3. Cylindrical shape, with pressure equalizing tube. With NS socket and interchangeable PE stopper, plug with retaining device. With solid glass key or PTFE key.

Lenz

Capacity ml	NS	Bore mm	Grad. ml	Keys	PK	Cat. No.
25	14/23	2.5	0,5	glass	1	6.072 172
50	14/23	2.5	1	glass	1	9.012 755
50	29/32	2.5	1	glass	1	9.012 767
100	14/23	2.5	2	glass	1	9.012 756
100	29/32	2.5	2	glass	1	9.012 768
250	14/23	4.0	5	glass	1	9.012 757
250	29/32	4.0	5	glass	1	9.012 769 2
500	29/32	4.0	10	glass	1	9.012 770
1000	29/32	6.0	20	glass	1	7.601 147
25	14/23	2.5	0,5	PTFE	1	9.012 751
50	14/23	2.5	1	PTFE	1	9.012 752
50	29/32	2.5	1	PTFE	1	6.223 427
100	14/23	2.5	2	PTFE	1	9.012 753
100	29/32	2.5	2	PTFE	1	6.900 312
250	29/32	4.0	5	PTFE	1	9.012 764
500	29/32	4.0	10	PTFE	1	9.012 765
1000	29/32	6.0	20	PTFE	1	9.012 766



9.012 744

Dropping Funnels, cylindrical, borosilicate glass 3.3

Cylindrical shape. With interchangeable PE stopper and stopcock with key as indicated, incl. retaining device.

Lenz

Graduated for reading the approx. volume.

Two types are available:

- With solid glass key stopcock
- With PTFE key stopcock



9.012 750

Capacity ml	NS	Bore mm	Grad. ml	Keys	PK	Cat. No.
25	14/23	2.5	0,5	glass	1	9.012 731
50	14/23	2.5	1	glass	1	6.252 455
50	29/32	2.5	1	glass	1	9.012 742
100	14/23	2.5	2	glass	1	6.401 645
100	29/32	2.5	2	glass	1	7.604 340
250	29/32	4.0	5	glass	1	9.012 744 3
500	29/32	4.0	10	glass	1	9.012 745
1000	29/32	6.0	20	glass	1	9.012 746
25	14/23	2.5	0,5	PTFE	1	9.012 735
50	14/23	2.5	1	PTFE	1	9.012 732
50	29/32	2.5	1	PTFE	1	9.012 748
100	14/23	2.5	2	PTFE	1	9.012 733
100	29/32	2.5	2	PTFE	1	9.012 743
250	29/32	4.0	5	PTFE	1	9.012 750 4
500	29/32	4.0	10	PTFE	1	9.012 707
1000	29/32	6.0	20	PTFE	1	9.012 708

1 Condensers, ground glass joint, Dimroth, borosilicate glass 3.3, PP-olive

Made of borosilicate glass 3.3. Resistant to heat and almost all chemicals. According to DIN 12591. Supplied with polypropylene side arm, which has a screw thread connector for easy and safe fitting of the tubing. The side arms accept tubing with 8/9 mm bore size.

ISOLAB

Description	Effective length mm	NS	PK	Cat. No.
with PP side arm	250	29/32	1	9.012 547
with PP side arm	400	29/32	1	9.012 545



2 Condensers, ground glass joint, Dimroth, borosilicate glass 3.3.

Made of borosilicate glass 3.3. Resistant to heat and almost all chemicals. According to DIN 12591. Supplied with glass side arms. The side arms accept tubing with 8/9 mm bore size.

ISOLAB

Effective length mm	Cone		Socket	PK	Cat. No.
	NS	NS			
160	14/23	14/23	1	9.012 525	
160	29/32	29/32	1	9.012 526	
250	14/23	14/23	1	9.012 527	
250	29/32	29/32	1	6.258 228	
400	14/23	14/23	1	9.012 528	
400	29/32	29/32	1	6.243 670	



3 Dimroth condensers, DURAN® tubing

Made of DURAN® tubing. Dimroth condensers acc. to DIN 12591 and in addition to DIN standard, for condensing vapours, with NS socket and cone, water connection: glass olives or GL 14 threads with two threaded plastic olives.

Lenz

Effective length mm	Cone		Socket	DIN	Cooling surface cm²	PK	Cat. No.
	NS	NS					
160	14/23	14/23			140	1	6.222 534
250	14/23	14/23			240	1	6.071 792
250	19/26	19/26			440	1	6.230 126
250	29/32	29/32		12591	440	1	6.236 577
400	29/32	29/32		12591	740	1	6.225 990
400	45/40	45/40			1380	1	6.204 362



4 Condensers acc. to Dimroth, with GL threads, DURAN® tubing

Made of DURAN® tubing. Acc. to DIN 12591 and in addition to DIN standard. With NS cone and socket. Water connection GL14 threads with two threaded plastic olives.

Lenz

Effective length mm	Cone		Socket	DIN	Cooling surface cm²	PK	Cat. No.
	NS	NS					
160	14/23	14/23			140	1	9.012 530
250	29/32	29/32		12591	440	1	9.012 533
400	29/32	29/32		12591	740	1	9.012 534



5 Condensers, ground glass joint, Allihn

Manufactured from borosilicate glass 3.3 according to DIN 12581 standard. Supplied with glass side arm. The side arms accept tubings with 8/9 mm bore size.

ISOLAB

Effective length mm	Cone		Socket	PK	Cat. No.
	NS	NS			
160	14/23	14/23	1	9.012 507	
250	14/23	14/23	1	9.012 509	
250	29/32	29/32	1	6.253 331	
400	14/23	14/23	1	9.012 510	
400	29/32	29/32	1	6.243 669	



➔ Extraction apparatus - please see page 1267.

Distillation, synthesis/Reflux condenser



1 Condensers, ground glass joint, Allihn, borosilicate glass 3.3

Borosilicate glass 3.3 which is resistant to heat and almost all chemicals. They meet the highest quality standards according to DIN 12581. Polypropylene side arm has a screw thread connector for easy and safe fitting of the tubing. The side arms accept tubings with 8/9 mm bore size.

ISOLAB

Description	Effective length mm	NS	PK	Cat. No.
with PP side arm	160	14/23	1	4.008 406
with PP side arm	400	29/32	1	4.008 408

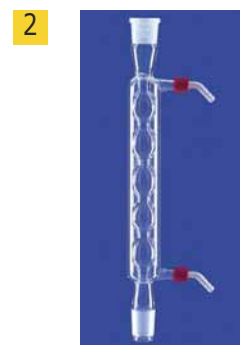

2 Condensers acc. to Allihn with GL threads, DURAN® tubing

Made of DURAN® tubing. Acc. to DIN 12581 and in addition to DIN standard. For condensing vapours. With NS cone and socket water connection GL14 threads with two threaded plastic olives.

Lenz

Effective length mm	Cone NS	Socket NS	DIN	Cooling surface cm ²	PK	Cat. No.
250	14/23	14/23		200	1	6.251 366
250	19/26	19/26		200	1	6.236 022
250	29/32	29/32	12581	200	1	9.012 517



3 Spiral condensers, borosilicate glass 3.3

Made of borosilicate glass 3.3 which is resistant to heat and almost all chemicals. They meet the highest quality standards according to DIN 12592. Supplied with either glass side arm or polypropylene side arm. Polypropylene side arm has a screw thread connector for easy and safe fitting of the tubing. The side arms accept tubings with 8/9 mm bore size.

ISOLAB

Description	Effective length mm	NS	PK	Cat. No.
with glass side arm	160	14/23	1	9.012 548
with glass side arm	250	29/32	1	6.257 821
with glass side arm	400	29/32	1	4.008 411
with PP side arm	160	14/23	1	4.008 412
with PP side arm	250	29/32	1	6.257 820
with PP side arm	400	29/32	1	4.008 414

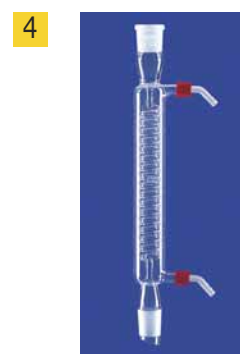

4 Spiral condensers, with GL threads, DURAN® tubing

Made of DURAN® tubing. For cooling condensates. Water connections with glass olives or GL14 threads with two threaded plastic olives.

Lenz

Effective length mm	Cone NS	Socket NS	Connection	Cooling surface cm ²	PK	Cat. No.
160	14/23	14/23	GL14	230	1	9.012 522
250	29/32	29/32	GL14	500	1	9.012 523
400	29/32	29/32	GL14	820	1	6.225 557
500	29/32	29/32	GL14	1040	1	9.012 524



Coil condensers, DURAN® tubing

Made of DURAN® tubing. Acc. to DIN 12593 and in addition to DIN standard. With jacketed cooling coil. Water connection with glass olives or GL 14 thread with two threaded plastic olives.

Lenz

Effective length mm	Cone NS	Socket NS	Connection	DIN	Cooling surface cm ²	PK	Cat. No.
160	29/32	29/32	olives	12593	240	1	7.635 816
250	29/32	29/32	olives	12593	400	1	6.227 832
400	29/32	29/32	olives	12593	650	1	6.240 342
500	29/32	29/32	olives		840	1	7.970 241
160	14/23	14/23	GL14		240	1	6.900 522
160	29/32	29/32	GL14	12593	240	1	9.012 542
250	29/32	29/32	GL14	12593	400	1	9.012 543
400	29/32	29/32	GL14	12593	650	1	9.012 544

9.012 543

6. Distillation, separation, filtration

Distillation, synthesis/Reflux condenser-Distillation-Accessories

1 Condensers, ground glass joint, Liebig, borosilicate glass 3.3

Made of borosilicate glass 3.3 which is resistant to heat and almost all chemicals. They meet the highest quality standards according to DIN 12576. Polypropylene side arm has a screw thread connector for easy and safe fitting of the tubing. The side arms accept tubings with 8/9 mm bore size.

ISOLAB



Description	Effective length mm	NS	PK	Cat. No.
with PP side arm	250	29/32	1	9.012 546
with PP side arm	400	29/32	1	4.008 405
with glass side arm	160	14/23	1	9.012 535
with glass side arm	250	14/23	1	9.012 536
with glass side arm	250	29/32	1	7.970 278
with glass side arm	400	14/23	1	9.012 537
with glass side arm	400	29/32	1	6.236 239

2 Condensers acc. to Liebig, DURAN® tubing

Made of DURAN® tubing, DIN 12576 and in addition to DIN standard. With NS cone and socket. Water connection: glass olives or GL14 threads with two threaded plastic olives.

Lenz



Effective length mm	Cone NS	Socket NS	Connection	Cooling surface cm ²	PK	Cat. No.
160	14/23	14/23	GL	60	1	9.012 502
160	19/26	19/26	GL	90	1	9.012 501
250	29/32	29/32	GL	130	1	9.012 505
400	29/32	29/32	GL	210	1	9.012 506

3 Air leak rod, DURAN®

With bulb (Diameter: 6 mm, Wall thickness: 1.5 mm).

Diam. mm	Length mm	PK	Cat. No.
4	180	1	9.012 302



4 Gas inlet tubes, straight, ground glass joint, DURAN® tubing

Made of DURAN® tubing. Straight air leak tubes, built-in length: 200 mm, with NS cone and thin capillary (easily to draw by burner).

Lenz



Diam. mm	Length mm	Cone NS	PK	Cat. No.
6	200	14/23	1	9.012 301
8	200	29/32	1	6.239 812

5 Gas inlet tubes, bent, DURAN® tubing

Made of DURAN® tubing. Bent air leak tubes (angle: 90°), built-in length: 250 mm, with NS cone and thin capillary (easily to draw by burner).

Lenz



Diam. mm	Length mm	Cone NS	PK	Cat. No.
6	250	14/23	1	9.012 303
8	250	29/32	1	9.012 305



1 Air regulator Type HM-2

For tubes: 8 mm to 15 mm diameter, 6mm to 12.5 mm diameter
 For air-leak capillary tubes. Acts as a fine regulation valve (needle valve). Plastic body. Brass needle with fine thread.

Type	PK	Cat. No.
HM-2	1	9.194 011



2 Boiling stones, Type A

Developed for use in preparatory work. For distillation and reflux in aqueous, neutral and alkaline solvents, even under a vacuum. Effective in even the smallest volumes of liquid and after multiple interruptions. Prevents any bumping. Natural product.

Capacity g	PK	Cat. No.
250	1	9.012 306



3 Boiling stones, Type B

Specifically for analytical work. Can be used for distillation in a clean, neutral and basic environment. Not suitable for vacuum distillation. Effective in the smallest amounts of liquid, also after multiple distillations. Prevents "bumping". Ceramic product with relatively high level of purity and abrasion resistance.

Capacity g	PK	Cat. No.
200	1	9.012 307



4 Boiling stones behrotest®

behrotest® boiling stones are made from a ceramic material. Compared to conventional boiling stones made of glass, they provide optimum protection against defervescence due to their porosity and their shape, even with badly blended samples. behrotest® boiling stones are chemically pure and guarantee unadulterated results when determining the COD, the Kjeldahl nitrogen etc. *behr*

Capacity g	PK	Cat. No.
100	1	9.920 710



5 Boiling chips, type Resistent

Developed for preparatory and analytical purposes. Suitable for biochemistry, biotechnology, microbiology, microanalysis. Can even be used in strong acids and alkalis, and in all solvents and oxidants. Suitable for vacuum and high-vacuum distillation. Reduces distillation times in rotary evaporators. No abrasion, absorption of substances or solvents. Softening (evaporation) occurs at 2500 °C. Can be sterilised by dry heating. Effective in even the smallest volumes of liquid, even after multiple interruptions. Prevents any bumping. Highly resistant.

Capacity g	PK	Cat. No.
50	1	9.012 308

1 Separating funnels, Squibb-pattern, borosilicate glass 3.3

Supplied with PTFE stopcock. With PE conical stopper.

ISOLAB

- ISO 4800
- NS necks according to DIN 12242 standard

Description	Capacity	Bore	NS	PK	Cat. No.
	ml	mm			
graduated	50	2.5	19/26	1	6.236 317
graduated	100	2.5	19/26	1	6.236 318
graduated	250	4.0	29/32	1	6.236 319
graduated	500	4.0	29/32	1	6.236 320
graduated	1000	6.0	29/32	1	6.236 321
graduated	2000	6.0	29/32	1	6.240 412

1



Separating funnels acc. to Squibb, borosilicate glass 3.3

With PTFE plug. Available with or without scale to read the approximate volume. With PP-stopper.

Lenz

Description	Capacity	Bore	Socket	PK	Cat. No.
	ml	mm	NS		
without scale	50	2.5	19/26	1	9.203 322
without scale	100	2.5	19/26	1	9.203 323
without scale	250	4.0	29/32	1	9.203 325
without scale	500	4.0	29/32	1	9.203 328
without scale	1000	6.0	29/32	1	9.203 330
without scale	2000	6.0	29/32	1	9.203 332
with scale	50	2.5	19/26	1	9.203 372
with scale	100	2.5	19/26	1	9.203 373
with scale	250	4.0	29/32	1	9.203 375 2
with scale	500	4.0	29/32	1	9.203 376
with scale	1000	6.0	29/32	1	9.203 377
with scale	2000	6.0	29/32	1	9.203 378

2

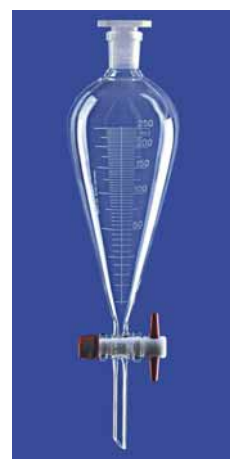

9.203 375

3 Separating funnels, conical, borosilicate glass 3.3

Supplied with PTFE stopcock. With PE conical stopper.

ISOLAB

- ISO 4800
- NS necks according to DIN 12242 standard

Description	Capacity	Bore	NS	PK	Cat. No.
	ml	mm			
graduated	100	2.5	19/26	1	6.241 980
graduated	250	4.0	29/32	1	6.241 671
graduated	500	4.0	29/32	1	6.241 981
graduated	1000	6.0	29/32	1	6.244 011
graduated	2000	6.0	29/32	1	6.242 394

3



Separating funnels, conical, borosilicate glass 3.3

Conical pattern. With PTFE stopcock and retaining device. Available with or without, scale to read the approximate volume. With PP conical stopper.

Lenz

Description	Capacity	Bore	NS	PK	Cat. No.
	ml	mm			
without scale	50	2.5	19/26	1	9.203 462
without scale	100	2.5	19/26	1	9.203 463
without scale	250	4.0	29/32	1	9.203 465
without scale	500	4.0	29/32	1	9.203 466
without scale	1000	6.0	29/32	1	9.203 467
without scale	2000	6.0	29/32	1	9.203 468
scale	50	2.5	19/26	1	9.203 482
scale	100	2.5	19/26	1	9.203 483
scale	250	4.0	29/32	1	9.203 485
scale	500	4.0	29/32	1	9.203 486 4
scale	1000	6.0	29/32	1	9.203 487
scale	2000	6.0	29/32	1	9.203 488

4



9.203 486

1

7.654 081

2

6.073 260

Separating Funnels acc. to Gilson, borosilicate glass 3.3

Borosilicate glass 3.3. With NS-socket and interchangeable PE stopper, stopcock and key with retaining device. Ungraduated.

Two types available:
 - With solid glass key
 - With PTFE key

Lenz

Type	Capacity ml	NS	Bore mm	PK	Cat. No.
solid glass key	50	19/26	2.5	1	7.654 081 1
solid glass key	100	19/26	2.5	1	6.204 303
solid glass key	250	29/32	4.0	1	6.257 218
solid glass key	500	29/32	4.0	1	6.232 732
solid glass key	1000	29/32	6.0	1	6.253 678
solid glass key	2000	29/32	6.0	1	6.253 679
PTFE key	50	19/26	2.5	1	6.073 260 2
PTFE key	100	19/26	2.5	1	6.073 113
PTFE key	250	29/32	4.0	1	6.072 965
PTFE key	500	29/32	4.0	1	6.072 997
PTFE key	1000	29/32	6.0	1	7.019 722
PTFE key	2000	29/32	6.0	1	6.242 852

3

3 Separating funnels Nalgene™ with screw cap, FEP



Thermo Scientific

Transparent. Teflon® FEP, Tefzel® ETFE stopcock and ETFE screw cap. Impact resistant. Non-wetting surfaces ensure no liquid residue adhesion. Chemically stable. Length of stem under stopcock 65 mm. Autoclavable.

Capacity ml	Screw cap diam. mm	PK	Cat. No.
125	28	1	9.203 531
250	33	1	9.203 532
500	43	1	9.203 533
1000	53	1	9.203 534
2000	53	1	9.203 535

Teflon® and Tefzel® are registered trademark of DuPont.

4

7.615 430

Water estimators acc. to Dean Stark, DURAN® tubing

Acc. to DIN 12420 (xylol method), capacity: 10:0.1 ml, with round bottom flask 500 ml, measuring tube and condenser made of DURAN® - tubing, flask: DURAN®.

Lenz

Description	PK	Cat. No.
Water estimator, zero point at the stopcock	1	7.615 430 4
Water estimator, zero point at the top	1	6.300 151
Measuring tube with stopcock, zero point at the stopcock	1	6.072 332
Measuring tube with stopcock, zero point above the stopcock	1	6.205 866
Round bottom flask, 500 ml, NS 29/32	1	9.011 850
Liebig condenser, jacket length 400 mm, cone and socket NS 29/32	1	9.012 506
Measuring tube w/o stopcock 10 ml : 1/10 zero-point in tip	1	7.970 184
Water estimator, zero point at the stopcock, measuring tube with stopcock	1	9.303 009

5

5 Soxhlet extractors, without stopcock

Borosilicate glass 3.3 which is resistant to heat and almost all chemicals. They meet the highest quality standards according to DIN 12602.

ISOLAB

Capacity ml	Cone NS	Socket NS	PK	Cat. No.
30	29/32	29/32	1	4.008 417
70	29/32	34/35	1	4.008 418
100	29/32	45/40	1	4.008 419
150	29/32	45/40	1	4.008 420
250	29/32	45/40	1	4.008 421
500	29/32	45/40	1	6.243 673

➔ Extraction thimbles please see page 1266.

1 Soxhlet extraction stillheads, DURAN® tubing

Soxhlet extraction stillheads, made of DURAN® tubing. Extractor heads acc. to DIN 12602 and in addition to DIN standard (*).

Lenz

For extractor ml	Cone NS	Socket NS	PK	Cat. No.
30	29/32	29/32	1	9.043 011
70*	29/32	34/35	1	9.043 012
100	29/32	45/40	1	9.043 013
150*	29/32	45/40	1	9.043 014
200*	29/32	45/40	1	9.043 018
250	29/32	45/40	1	9.043 015
300*	29/32	60/46	1	9.043 019
500	29/32	60/46	1	9.043 016
1000	29/32	71/51	1	9.043 017



Extractor heads for specific light solvents, DURAN® tubing

Extractor heads for the extraction of liquids with specific light solvents, with insert filter (porosity: 0), made of DURAN® tubing. Distribution tubes with frit (porosity: 0), for specific light solvents, made of DURAN® tubing.

Lenz

Type	Extractor ml	Condenser NS	PK	Cat. No.
Extractor head	100	45/40	1	6.801 962 2
Extractor head	250	45/40	1	6.258 695
Extractor head	500	60/46	1	6.902 445
Distribution tube	100	-	1	6.258 692
Distribution tube	250	-	1	6.258 693
Distribution tube	500	-	1	6.902 444 3

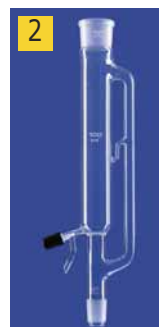

6.801 962

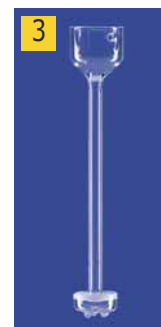

6.902 444

4 Extractor heads for specific heavy solvents, DURAN® tubing

Made of DURAN® tubing. For the extraction of liquids with specific heavy solvents, with insert filter (porosity: 0).

Lenz

Extractor ml	Condenser NS	PK	Cat. No.
100	45/40	1	6.258 697
250	45/40	1	6.258 698
500	60/46	1	6.258 699



5 Condensers acc. to Dimroth for extractors, with glass olives

Manufactured from borosilicate glass 3.3 with glass side arm. The side arms accept tubings with 8/9 mm bore size.

ISOLAB

For volume ml	Cone NS	PK	Cat. No.
30	29/32	1	9.012 538
70	34/35	1	9.012 539
100/250	45/40	1	6.254 108
500	45/40	1	4.678 590



6 Condensers acc. to Dimroth for extractors, with PP olives, DURAN® tubing

Made of DURAN® tubing. For extractors and for condensing vapours. With cone. Water connection with thread GL14, with two threaded PP olives.

Lenz

Volume ml	Cone NS	Cooling surface cm²	PK	Cat. No.
30	29/32	140	1	9.043 021
70	34/35	160	1	9.043 022
100 - 250	45/40	370	1	9.043 023
300 - 500	60/46	680	1	9.043 026
1000	71/51	930	1	9.043 027



1

1 Dimroth condensers for extractors, with glass olives, DURAN® tubing

For condensing vapours, with NS cone, water connection: glass olives, made of DURAN® tubing.

Lenz

Volume ml	Cone NS	Cooling surface cm ²	PK	Cat. No.
30	29/32	140	1	6.204 562
70	34/35	160	1	6.207 176
100 - 250	45/40	370	1	7.085 191
300 - 500	60/46	680	1	7.604 610
1000	71/51	930	1	6.266 984

2

2 Allihn condensers for Soxhlet

 Manufactured from borosilicate glass 3.3 with glass side arm.
The side arms accept tubings with 8/9 mm bore size.

ISOLAB

For volume ml	Cone NS	PK	Cat. No.
30	29/32	1	9.012 540
70	34/35	1	9.012 541
100/250	45/40	1	6.254 106

3

7.200 489

4

6.224 397

Condensers acc. to Allihn for extractors, DURAN® tubing

Made of DURAN® tubing. For condensing vapours. With cone, water connection with glass olives or GL 14 thread and two threaded plastic olives.

Lenz

Extractor ml	Effective length mm	Cone NS	Connection	Cooling surface cm ²	PK	Cat. No.
30	160	29/32	Glass olive	100	1	6.204 890
100-250	250	45/40	Glass olive	200	1	7.200 489 3
30	160	29/32	GL 14	100	1	6.242 774
100-250	250	45/40	GL 14	200	1	6.224 397 4

For all condensers are other sizes available on request.



6. Distillation, separation, filtration

Distillation, synthesis/Gas wash bottles

1 Gas washing bottle, PP

Graduated 250 ml polypropylene cylinder with a stable extended base for use in precipitating elements from gas. *Bel-Art Products*

- Gas is dispersed through a removable fitting that has a coarse grade porosity, polyethylene dispersion disc
- Silicone stopper holds 6.3 mm O.D. tubes for entrance and exit of gas
- 0.5 psi maximum pressure

Description	Capacity ml	Height mm	PK	Cat. No.
Gas washing bottle	250	273	1	9.110 290

1



Gas washing bottle reservoirs, Drechsel, Borosilicate glass 3.3

In accordance with Drechsel. Ground joint 29/32. DIN 12463. Flask height 200 mm, working height 250 mm. *Rettberg*

Description	Capacity ml	NS	PK	Cat. No.
Gas washing bottle reservoirs	100	29/32	1	9.110 473 2
Gas washing bottle reservoirs	250	29/32	1	9.110 474
Gas washing bottle reservoirs	500	29/32	1	6.240 962
Gas washing bottle head, without frit disk		29/32	1	6.240 963
Gas washing bottle head, with frit disk		29/32	1	9.110 472 3

2



9.110 473

3



9.110 472

Gas washing bottles acc. to Drechsel, complete, DURAN® tubing

Bottle, DURAN®. Head made from DURAN® tubing, with screw connections. Head available with or without porosity 1 filter disc, insert height adjustable, capacity: 500 ml, central screw cap: GL 45, lateral screw caps: GL 14. *Lenz*

Description	Capacity ml	Porosity	PK	Cat. No.
Gas Washbottle without filter disc	500	-	1	6.073 489 4
Gas Washbottle with filter disc	500	1	1	7.635 908 5

4



6.073 489

5



7.635 908

Gas washing bottle heads, DURAN® tubing

Acc. to DIN 12596. DURAN® tubing. Cone NS 29/32. With or without filter disc. *Lenz*

Description	NS	Porosity	PK	Cat. No.
With filter disc, thread GL 14	29/32	1	1	6.401 362
Without filter disc, olives	29/32	-	1	9.110 380 6
With filter disc, olives	29/32	0	1	9.110 390 7
With filter disc, olives	29/32	1	1	9.110 391

6



9.110 380

7



9.110 390

8 Bubble counter

DURAN®.

Height mm	PK	Cat. No.
100	1	9.014 100

8



Distillation, synthesis/Gas wash bottles

1

1

Safety/overpressure valves, with spring loaded spherical ground joint seal

When laboratory ground devices are used under vacuum or/and slight overpressure, the use of this combined overpressure safety valve can be recommended. These valves act as immediately closing safety valve under vacuum and they allow under overpressure the visual control of the bubble formation in the blocking liquid. The real sealing is effected by a special designed spherical ground joint (cup and ball) on which an adjustable spring power acts. It is supported by a free to chose blocking liquid which should be higher viscous for vacuum operations. The sealed climbing tube at the spherical ground cup serves as a guide and prevents that the liquid climbs back into the apparatus.

PFAUDLER NORMAG

Height mm	Joint size (NS)	Neck thread GL	PK	Cat. No.
210	14 / 23	18	1	4.672 227
210	29 / 32	18	1	4.672 230
215 *	14 / 23	18	1	4.672 231
215 *	29 / 32	18	1	6.275 026

* With standard stopcock, bore 3 mm

2

Gas washing bottles acc. to Drechsel with filter disc

Acc. to DIN 12596, complete with head (with filter disc), ground joint connection: NS 29/32, material: DURAN® tubing (head), borosilicate glass 3.3 (bottle).

Lenz

Capacity ml	Porosity	Connections	PK	Cat. No.
100	0	olives	1	6.082 990
250	0	olives	1	6.228 160
500	0	olives	1	7.611 600
100	1	olives	1	9.110 353
250	1	olives	1	9.110 354
500	1	olives	1	9.110 355
1000	1	olives	1	9.110 356
100	2	olives	1	7.622 618
250	2	olives	1	7.622 619
500	2	olives	1	7.622 620
250	1	GL 14	1	6.229 444

3

Gas washing bottles acc. to Drechsel, without Filter, DURAN® tubing

- Acc. to DIN 12596, complete with head,
- ground joint connection: NS 29/32,
- material: DURAN® tubing (head), borosilicate glass 3.3 (bottle)

Lenz

Capacity ml	Description	PK	Cat. No.
100	Without filter disc, olives	1	6.230 396
250	Without filter disc, olives	1	6.223 295
500	Without filter disc, olives	1	7.651 874
1000	Without filter disc, olives	1	6.236 247

4

9.110 410

Gas washing bottles

DURAN®. Head fitted with fritted disc and standard ground joint. Porosity 1.

DWK Life Sciences

Capacity ml	Height mm	Description	PK	Cat. No.
100	250	Gas washing bottle	1	9.110 410 4
250	250	Gas washing bottle	1	9.110 420
500		Gas washing bottle "Drechsel"*	1	7.022 224
500		Gas washing bottle "Drechsel"* with fritted disk	1	7.022 420
500		Essay "Drechsel" for 500 ml	1	7.078 351
500		Essay "Drechsel" with filter disc for 500 ml	1	7.022 432

* with screw connection system and attachment.

1 Connectors with stopcock, borosilicate glass 3.3

Supplied with PTFE stopcock with different key bore diameters. DIN 12594.

ISOLAB

Cone	Socket	PK	Cat. No.
NS	NS		
14/23	14/23	1	9.140 536
19/26	19/23	1	9.140 537
24/29	24/29	1	9.140 538
29/32	29/32	1	9.140 539



2 3 Expansion and reduction adapters, borosilicate glass 3.3

Manufactured from borosilicate glass 3.3 which is resistant to heat and almost all chemicals. They meet the highest quality standards according to DIN 12257. They have excellent grinding to prevent airleaks. The bottom part of the ground joints are fire polished.

ISOLAB

Cone	Socket	PK	Cat. No.
NS	NS		
14/23	19/26	1	4.008 341
14/23	29/32	1	6.235 966
19/26	14/23	1	6.243 581
19/26	29/32	1	4.008 344
24/29	14/23	1	6.243 582
24/29	19/26	1	4.008 342
24/29	29/32	1	4.008 345
29/32	14/23	1	9.011 740
29/32	19/26	1	4.008 343
29/32	24/29	1	6.241 533
34/35	19/26	1	6.243 583
34/35	24/29	1	6.243 584
34/35	29/32	1	6.243 586
45/40	24/29	1	6.243 585



4 5 Expansion and reduction adapters, DURAN® tubing

Made of DURAN® tubing. DIN 12257 and in addition to DIN standard (*). Reduction and expansion adapters with ground joint.

Lenz

Cone	Socket	DIN	PK	Cat. No.
NS	NS			
14/23	19/26	12257	1	9.011 766
14/23	29/32	12257	1	9.011 750
19/26	29/32	12257	1	9.011 767
24/29*	29/32		1	6.073 246
29/32	14/23	12257	1	9.011 755
29/32*	34/35		1	6.079 832
29/32*	45/40		1	9.011 760
45/40	29/32	12257	1	9.011 765
45/40	71/51		1	4.671 378



6 Adapter for thermometer, borosilicate glass 3.3

Manufactured from borosilicate glass 3.3 according to DIN 12257 standard, ideal to use for thermometers with \varnothing 6 - 8 mm. Screw joint provides easy depth adjustment of thermometer. Seal material: NBR

ISOLAB

Adapter bore diam. mm	Cone	Neck thread	PK	Cat. No.
	NS	GL		
6 - 8	14/23	14	1	4.008 360
6 - 8	29/32	14	1	6.244 589



7 Tubing adapters

Manufactured from borosilicate glass 3.3 with two different shapes: straight or 90° angled. Tubing adapter is suitable for up to 10 mm tubings.

ISOLAB

Description	Diam.	Socket	PK	Cat. No.
		NS		
straight	Olive 8 mm	14/23	1	9.012 184
straight	Olive 10 mm	29/32	1	9.012 185
bend	Olive 8 mm	14/23	1	9.012 186
bend	Olive 10 mm	29/32	1	9.012 187
straight with PTFE stopcock	Olive 8 mm	14/23	1	9.012 188
straight with PTFE stopcock	Olive 10 mm	29/32	1	9.012 189
bend with PTFE stopcock	Olive 8 mm	14/23	1	9.012 190
bend with PTFE stopcock	Olive 10 mm	29/32	1	9.012 191



Distillation, synthesis/Tubing adapters

1

9.012 319

2

9.012 313

Adapters with NS stopcock, DURAN® tubing

Made of DURAN® tubing. Adapter, NS cone to 10 mm bore tubing connector. Straight or angled (90°). Available with or without solid glass plug, bore 2.5 mm.

Lenz

Form	Cone	Stopcock	PK	Cat. No.
NS				
straight	14/23	+	1	9.012 316
straight	14/23	-	1	9.012 312
bent	14/23	+	1	9.012 315
bent	14/23	-	1	9.012 311
straight	19/26	+	1	6.202 380
straight	24/29	+	1	6.080 932
straight	29/32	+	1	9.012 319 1
straight	29/32	-	1	9.012 314
bent	29/32	+	1	9.012 317
bent	29/32	-	1	9.012 313 2

3

3 Adapter for tubing, borosilicate glass 3.3

Manufactured from borosilicate glass 3.3 in two different forms, straight or 90° angled. Supplied with PTFE stopcock which has of 2.5 mm diameter bore key. Tubing adapter is suitable for up to 10 mm tubings.

ISOLAB

Form	Cone	Stopcock	PK	Cat. No.
NS				
straight	14/23	with	1	4.008 365
straight	14/23	without	1	6.244 590
bent	14/23	with	1	4.008 367
bent	14/23	without	1	4.008 362
straight	29/32	with	1	4.008 366
straight	29/32	without	1	4.008 361
bent	29/32	with	1	4.008 369
bent form	29/32	without	1	4.008 364

4

4 Screwthread tubes with NS cone, DURAN® tubing, cap and sealing

Screw thread adapters, made of DURAN® tubing, with screw-cap with aperture and silicone sealing ring with PTFE washers.

Lenz

Neck thread	Cone	For diam. mm	PK	Cat. No.
GL	NS			
14	14/23	5,5-6,5	1	6.254 133
14	19/26	5,5-6,5	1	6.242 373
14	24/29	5,5-6,5	1	6.257 399
14	29/32	5,5-6,5	1	6.255 923
18	14/23	7,5-9	1	6.229 590
18	19/26	7,5-9	1	6.286 017
18	29/32	7,5-9	1	7.020 352
25	29/32	9-11	1	7.661 262
32	29/32	13-15	1	6.310 102

5

5 Screw caps for screwthread tubes

Lenz



With DIN thread (GL), temperature resistant up to 180 °C, with PTFE coated silicone sealing (VMQ), material: PBT, colour: red

Neck thread	PK	Cat. No.
GL		
14	1	7.653 217
18	1	6.232 022
25	1	6.243 031
32	1	7.653 216
45	1	6.207 113

6. Distillation, separation, filtration

Distillation, synthesis/Tubing adapters

1 Threaded tube with NS core, DURAN® tubing

Made of DURAN® tubing. DIN 12257 and in addition to DIN standard (*). Double ended. With GL thread and NS core.

Lenz

Neck thread	Cone	DIN	PK	Cat. No.
GL	NS			
14	14/23		1	9.209 514
14	29/32	12257	1	9.209 517
18	14/23	12257	1	9.209 518
18	29/32		1	9.209 529
25	14/23	12257	1	6.300 168
25	29/32		1	9.209 559
32	24/29	12257	1	9.209 581
32	29/32		1	9.209 582



2 Screw caps for screwthread tubes, PBT



With DIN thread (GL) and aperture. temperature resistant up to 180 °C. Colour: red. Material: PBT.

Lenz

Neck thread	Bore	PK	Cat. No.
GL	mm		
14	9.5	1	6.307 040
18	11.0	1	6.201 839
25	15.0	1	6.203 948
32	20.0	1	6.243 032
45	34.0	1	6.231 293



3 Screw connector caps, PBT



Red. PBT. With central hole (diameter outlined below). Temperature resistance to max. 180 °C.

DWK Life Sciences

Bore	Neck thread	PK	Cat. No.
mm	GL		
9.5	14	1	9.209 114
11.0	18	1	9.209 118
15.0	25	1	9.209 125
20.0	32	1	9.209 132
34.0	45	1	9.209 135



4 Screwthread couplings, PBT



DIN screwthread. For flexible connection of two glass screwthreads. With integral PTFE-faced silicone (VMQ) seals. Temperature resistant to max. 180 °C.

DWK Life Sciences

Neck thread	PK	Cat. No.
GL		
14	1	9.209 004
18	1	9.209 005



5 Silicone cap wads/septa, VMQ



For GL-screwthread caps. Overall diameter and wad thickness as outlined below. Thermal resistance: 130 °C (steam)/200 °C (heat). Autoclavable.

DWK Life Sciences

For thread size	Diam.	Thickness	PK	Cat. No.
GL	mm	mm		
14	12	2	1	9.209 414
18	16	2	1	9.209 418
25	22	2	1	9.209 425
32	29	2	1	9.209 432
45	42	3	1	9.209 435





1

1 Silicone sealing rings, VMQ



DWK Life Sciences

With vulcanized PTFE sleeve. For screwthread caps.
Thermal resistance: 130 °C (steam), 200 °C (heat). Autoclavable.

For thread size	For tubes diam.	Ext. diam.	Int. diam.	PK	Cat. No.
GL	mm	mm	mm		
14	5.5 to 6.5	12	6	1	9.209 146
18	5.5 to 6.5	16	6	1	9.209 186
18	7.5 to 9.0	16	8	1	9.209 188
18	9.0 to 11.0	16	10	1	9.209 190
25	7.5 to 9.0	22	8	1	9.209 258
25	9.0 to 11.0	22	10	1	9.209 260
25	11.0 to 13.0	22	12	1	9.209 262
32	9.0 to 11.0	29	10	1	9.209 320
32	11.0 to 13.0	29	12	1	9.209 322
32	13.0 to 15.0	29	14	1	9.209 324
32	15.0 to 17.0	29	16	1	9.209 326
32	17.0 to 19.0	29	18	1	9.209 327
45	25.0 to 27.0	42	26	1	9.209 329
45	31.0 to 33.0	42	32	1	9.209 331



2

2 Plastic ferrule, angled, PP



DWK Life Sciences

PP. For screw connector caps GL 14. With silicone seal (VMQ).
Temperature resistant up to max. +140 °C. Autoclavable.

Diam.	Neck diam.	PK	Cat. No.
mm	mm		
8.6	4	1	9.051 308



3

3 GL screwthread ferrules



BOLA

Fluoroplastics, for tubing connection. Straight and curved models available, screw connector caps made of PPS reinforced with glass fibre (max. +250 °C), ferrules made of PFA, with flexible PFA sealing rim and FPM O-ring. When in use, the contents only comes into contact with PFA (or PTFE - GL25 and GL32).

Type	Ext. diam. mm	Int. diam. mm	Neck thread GL	PK	Cat. No.
Straight 35 mm	8.7	6	14	1	9.051 320
Straight 39 mm	10.5	7	18	1	9.051 321
Angled 40 mm	8.7	6	14	1	9.051 324
Angled 54 mm	10.5	7	18	1	9.051 325



4

4 Assembly set, KECK® and Replacement seal

DWK Life Sciences

For attaching flexible vacuum tubing to filter flasks. Consists of straight PP tubing connection, PP tubulature made of silicone (VMQ) rubber seal. PP components can withstand temperatures up to 140 °C for short periods without mechanical load.

Type	PK	Cat. No.
Assembly set, Keck®	1	9.051 471
Replacement seal	1	9.051 474

6. Distillation, separation, filtration Distillation, synthesis/Standard ground stoppers

1 Conical ground joint stoppers, PP



BRAND

Hollow, with sealing rings and square grip. Autoclavable (121 °C).

1



NS	PK	Cat. No.
7 / 16	10	4.678 532
10 / 19	10	4.678 533
12 / 21	10	4.678 534
14 / 23	10	4.678 535
19 / 26	10	4.678 536
24 / 29	10	4.678 537
29 / 32	10	4.678 538
34 / 35*	10	4.678 539
45 / 40*	10	4.678 540

* LDPE with octagonal grip

2 Stoppers, hollow , HDPE



Fits standard conical joints.

2



NS	PK	Cat. No.
7/16	10	4.678 541
10/19	10	4.678 542
12/21	10	4.678 543
14/23	10	4.678 544
19/26	10	4.678 548
24/29	10	4.678 545
29/32	10	4.678 546
45/40	10	4.678 547
60/46	10	4.678 549

3 Conical stoppers, NS, PE



Kartell

Polyethylene. Stoppers manufactured to DIN standard 12242 ensuring an effective seal, even on non-standard surfaces.

3



Colour	Bottom diam. mm	NS	PK	Cat. No.
violet	5.9	7/16	10	4.678 557
blue	8.1	10/19	10	4.678 550
green	10.4	12/21	10	4.678 551
brown	12.2	14/23	10	4.678 552
yellow	16.4	19/26	10	4.678 553
red	21.1	24/29	10	4.678 554
black	25.8	29/32	10	4.678 555
white	30.9	34/35	10	4.678 556

4 NS-Glass stoppers, hollow borosilicate glass 3.3

Manufactured from borosilicate glass 3.3 which is resistant to heat and almost all chemicals. They meet the highest quality standards according to DIN 12252. Lower closed end of stopper features a "drip-tip" to ensure adhered liquid is returned to the flask. Hexagonal flat head prevents the stopper from rolling and allows stopper to be stood on end preventing contamination of the ground surface.

ISOLAB

4



Description	NS	PK	Cat. No.
clear	10/19	10	4.667 524
clear	12/21	10	4.667 525
clear	14/23	10	4.667 526
clear	19/26	10	4.667 527
clear	24/29	10	4.667 528
clear	29/32	10	4.667 529
clear	34/35	10	4.678 564
amber	10/19	10	4.678 565
amber	12/21	10	4.678 566
amber	14/23	10	4.678 567
amber	19/26	10	4.678 568
amber	24/29	10	4.678 569
amber	29/32	10	4.678 570
amber	34/35	10	4.678 571



1 Hollow stoppers, hexagonal plate, pointed bottom, borosilicate glass 3.3

Acc. to DIN 12252 form C.

Lenz

NS	PK	Cat. No.
7/16	10	4.678 579
10/19	10	4.678 573
12/21	10	4.678 574
14/23	10	4.678 575
19/26	10	4.678 576
24/29	10	4.678 578
29/32	10	4.678 577
34/35	10	4.678 580
45/40	10	4.678 572



2 Conical ground joint stoppers, borosilicate glass 3.3

DIN 12252. Solid or semi-hollow, with octagonal grip.

BRAND

NS	Description	PK	Cat. No.
12/21	solid	10	4.678 581
14/23	solid	10	4.678 582
19/26	solid	10	4.678 583
24/29	solid	10	4.678 584
29/32	semi-hollow	10	4.678 585
34/35	semi-hollow	10	4.678 586



3 LIG-Joint clips, POM, for conical ground joints

For an easy and safe fixing of jointed glassware.

NS	Colour	PK	Cat. No.
14	yellow	10	6.291 859
19	blue	10	6.291 860
24	green	10	6.291 861
29	red	10	6.291 862



4 Joint clips KECK, POM, for conical ground joints

Melting point 175 °C. Excellent chemical resistance. Rigid. Heat resistant up to 150 °C, sizes colour coded.

For	Colour	PK	Cat. No.
NS 10	green	10	4.678 596
NS 12	violet	10	4.678 597
NS 14	yellow	10	4.678 598
NS 19	blue	10	4.678 599
NS 24	green	10	4.678 600
NS 29	red	10	4.678 601
NS 34	orange	10	4.678 602
NS 40	yellow	10	4.678 603
NS 45	brown	10	4.678 604



5 Joint clips KECK, POM, for spherical ground joints

Melting point 175 °C. Excellent chemical resistance. Rigid. Heat resistant up to 150 °C, sizes colour coded.

For	Colour	PK	Cat. No.
S 13	violet	10	4.678 605
S 19	blue	10	4.678 606
S 29	red	10	4.678 607
S 35	orange	10	4.678 608

6. Distillation, separation, filtration

Distillation, synthesis/NS joints accessories

1 Ground joint clips for sleeve connections, wire, Chrome-nickel steel

Chrome-nickel steel.

NS	PK	Cat. No.
10/19	10	4.678 610
12/21	10	4.678 613
14/23	10	4.678 611
19/26	10	4.678 615
24/29	10	4.678 609
29/32	10	4.678 614
45/40	10	4.678 612



Joint clips for conical joint sleeve connections

Stainless steel. For tapered ground joints as outlined below. With or without set screw.

Lenz

Type	NS	PK	Cat. No.
with locking screw	14/23	1	9.011 675
with locking screw	19/26	1	9.011 676
with locking screw	24/29	1	9.011 677
with locking screw	29/32	1	9.011 678
with locking screw	45/40	1	9.011 680
without locking screw	14/23	1	9.011 685
without locking screw	19/26	1	9.011 686
without locking screw	24/29	1	9.011 687
without locking screw	29/32	1	9.011 688
without locking screw	45/40	1	9.011 690



9.011 685

3 KECK™ Clips for conical joints, spring steel

For applications with very high temperatures. Easy to fit, dimensionally stable.

DWK Life Sciences

For	PK	Cat. No.
NS 14	1	9.011 783
NS 19	1	9.011 784
NS 24	1	9.011 785
NS 29	1	9.011 786



4 LLG-Fork clamps for spherical joints

Made of stainless steel 304. For spherical ground joint connections. With set screw.

Size	PK	Cat. No.
S13	1	9.011 797
S19	1	9.011 798
S29	1	9.011 799
S35	1	9.011 800



5 Fork clamps for spherical joints

Material: stainless steel. For spherical ground joint connections. With set screw.

Lenz

Size	PK	Cat. No.
S 13	1	9.011 693
S 19	1	9.011 694
S 29	1	9.011 695
S 35	1	9.011 698
S 40 / 41	1	9.011 696
S 65	1	9.011 697



1

1 PTFE sealing rings for jointed glassware

An effective alternative to common PTFE joint sleeves and PTFE stoppers. *Glindemann*

- Air leakage <math> < 10^{-8}</math> to 10^{-6} mBar l/s (vacuum and pressure).
- Solvent leakage from containers <math> < 0.1</math> to 0.03 mg/day.
- Temperature range: -196 to 300 °C

NS	PK	Cat. No.
10	50	9.011 663
12	50	7.622 596
14	50	9.011 664
19	50	9.011 665
24	50	9.011 666
29	50	9.011 667
34	50	7.700 004
45	50	9.011 668

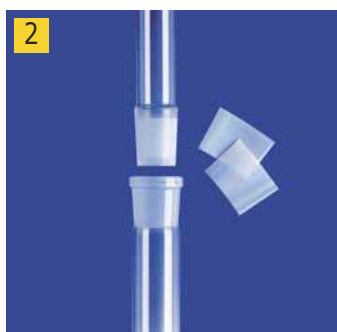
2

2 Disposable ground joint sleeves, PTFE

Outstanding chemical resistance at operating temperatures from -200 to +260 °C, only 50 µm thickness, the sleeves fit like a second skin without adding bulk, without grip collar, simplifying use of joint clips. *Lenz*

For	PK	Cat. No.
NS 14/23	1	6.227 451
NS 19/26	1	6.236 032
NS 24/29	1	6.243 030
NS 29/32	1	6.227 452
NS 45/40	1	6.236 031

3

3 Sleeves with ribs, PTFE

For use with ground glass joints. Suitable for vacuums up to 0.1 mbar. Reusable and long lasting. The sealing ribs grip on the inside wall of the glass socket, sealing without the need for grease and enabling the cone to be freed easily when required. *BOLA*

NS	PK	Cat. No.
14/23	1	9.011 655
19/26	1	9.011 656
24/29	1	9.011 657
29/32	1	9.011 658
45/40	1	9.011 660
60/46	1	9.011 661
71/51	1	9.011 662

4

4 Sleeves, cone joint, PTFE

With knurled gripping ring at the top of the cone for easy removal. For gas, liquid and vacuum-tight cone joint connections with sizes as outlined below. Reusable. With reinforced external ribs for a high-vacuum tight seal (leakage rate: <math> < 1 \times 10^{-4}</math> mbar x l x s⁻¹). No joint sealant or grease required. *BOLA*

NS	PK	Cat. No.
14/23	1	9.011 642
19/26	1	9.011 643
24/29	1	9.011 644
29/32	1	9.011 645
45/40	1	9.011 647

5

5 Bellows, PTFE

Stainless connection of ground joint equipment; for compensating vibrations from vacuum pumps; for length compensation of heated columns; angular misalignment. Made of PTFE, with sharp folds and sealing rings on the outside; maximum deflection: 120°. *BOLA*

Overall length mm	Cone NS	Socket NS	PK	Cat. No.
90	14/23	14/23	1	9.012 161
120	29/32	29/32	1	9.012 163

6. Distillation, separation, filtration Distillation, synthesis/NS joints accessories

1 Sealing tape, PTFE

For covering areas which require protection against chemicals of all types at temperatures of -150 to +260 °C. Non-swelling. Easy loosening of seams even after continuous operation. Supplied in rolls as outlined below.

Width mm	Length cm	Wall thickness mm	PK	Cat. No.
12.8	670	0.1	1	9.404 952
24.0	670	0.1	1	9.404 955

1



2 BUDDE - joint grease

For all glass joints. Transparent, vacuum tight, water washable and water soluble. Maintains practically the consistency between -30 °C and +200 °C, non-solidifying. Compatible with most elastomers. Tube of 80 g.

Buddeberg

Weight g	PK	Cat. No.
80	1	9.116 950

2



Silicone high vacuum grease

Temperature stable and can be used up to 10⁻⁶, from -40 to approx. +150 °C, at temperatures above +200 °C the silicone grease polymerizes and begins to outgas. Tube of 100 g.

Type	PK	Cat. No.
Low viscous	1	9.116 901 3
Medium viscous	1	9.116 911
Highly viscous	1	6.286 771

3



9.116 901

4 Joint grease, K.W.S

Without silicone. Designed as vacuum and high vacuum grease. No silicone derivatives, polymerisation or gumming. Excellent adhesion and viscosity. Acid/alkaline resistant. Locked joints can be loosened by brief, gentle heating. Can be used to make temporary glassware repairs. Biodegradable. Non-toxic in normal use.

Working temperature range: -40 ... 200 °C, to 10⁻⁵ mbar
Vapour pressure: 0.00001 mbar.

Capacity ml	PK	Cat. No.
30	1	9.116 924

4



5 Rotating joint grease, silicone-free, Alsirol

Silicone-free stopcock grease. No silicone derivatives, polymerisation or gumming. Excellent adhesion and viscosity. Stable grease film enables safe, long term use. Low heat-up occurs during rotation even if operation is continuous. When sealing glassware systems with glass and metal stirrers and shafts Alsirol protects rotating, precision-ground sockets and stirring shafts against glass abrasion. Also suitable for lubricating rotating metal and glass components. Acid and alkali resistant. For use under vacuum and high vacuum. Biodegradable. Non-toxic in normal use.

Working temperature range: -40 to +200 °C
Vapour pressure: 0.00001 mbar

Capacity ml	PK	Cat. No.
50	1	9.116 925

5



6. Distillation, separation, filtration

Distillation, synthesis/Ground joints, attachable



1 Screwthread tubes for glassblowers, DURAN®

Acc. to DIN 12216 and in addition to standard (*), with DIN thread (GL), material: DURAN®.

Lenz

Neck thread GL	Length mm	Diam. mm	PK	Cat. No.
14	100	12	1	9.209 714
18	100	16	1	9.209 718
25	100	22	1	9.209 725
32	140	28	1	9.209 732
45	180*	40	1	9.209 735



9.011 613

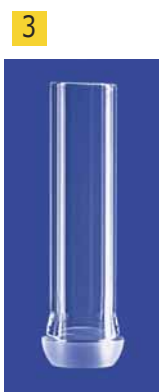

9.011 630

2 Socket and ball members, DURAN® tubing

Made of DURAN® tubing. DIN 12264 and in addition to DIN standard (*). With ground glass ball (male) and socket (female) joints.

Lenz

Type	Tube diam. mm	Overall length mm	socket/ball	PK	Cat. No.
Socket	8	100	S 13/5	1	9.011 603
Socket	13	120	S 19	1	9.011 605
Socket	19	120	S 29	1	9.011 609
Socket	28	120	S 35*	1	9.011 613 2
Socket		120	S 41*	1	4.671 386
Socket		150	S 51	1	4.671 387
Ball	8	100	S 13/5	1	9.011 623
Ball	13	120	S 19	1	9.011 625
Ball	19	120	S 29	1	9.011 629
Ball	28	120	S 35*	1	9.011 630 3
Ball		120	S 41*	1	4.671 388
Ball		150	S 51	1	4.671 389



9.011 508



9.011 548

6 Sockets/Cones with NS joint, DURAN® tubing

Made of DURAN® tubing. DIN 12249 and in addition to DIN standard (*).

Lenz

Description	NS	Ext. diam. mm	Length mm	PK	Cat. No.
Socket	5/13	8	120	1	9.011 521
Socket	14/23	17	130	1	9.011 525
Socket	19/26	22	130	1	9.011 526
Socket	19/38*	22	120	1	7.606 907
Socket	29/32*	33	210	1	6.303 190
Socket	29/32	33	130	1	9.011 528
Socket	40/38*	44	130	1	6.202 446
Socket	45/40*	48	280	1	6.303 189
Socket	45/40	50	145	1	9.011 530
Socket	71/51	75	165	1	9.011 532
Socket	85/55	90	185	1	9.011 533
Cone	5/20*	4	115	1	6.070 542
Cone	10/30*	8	115	1	6.222 104
Cone	12/21	11	130	1	9.011 504
Cone with tip	12/21	11	130	1	6.072 920
Cone	14/35*	13	140	1	6.900 898
Cone	14/23	13	130	1	9.011 505
Cone with drip tip	19/26*	17	120	1	6.072 150
Cone	19/38*	17	140	1	7.606 908
Cone	19/26	17	130	1	9.011 506
Cone	29/32	26	130	1	9.011 508 4
Cone	29/42*	26	140	1	6.203 538
Cone	34/45*	30	140	1	6.401 432
Cone with tip	40/38*	36	145	1	6.202 386
Cone	45/40	40	145	1	9.011 510
Cone	50/42*	46	145	1	7.630 287
Cone	55/44*	50	145	1	7.630 288
Cone with tip	60/46*	54	160	1	6.073 068
Cone with outlet	14/23	13	130	1	9.011 545
Cone with outlet	29/32	26	130	1	9.011 548 5

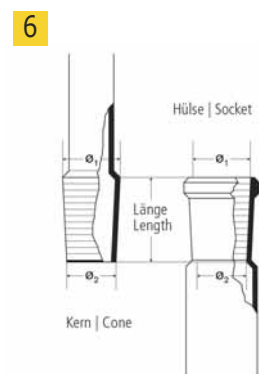

Stopcocks, with glass plug, borosilicate glass 3.3

1

Acc to DIN 12541-1 and in addition to DIN standard. With solid glass plug and retaining device. Straight bore. Leakage rate acc. to DIN 12540-1.

Lenz

Description	NS	Bore	DIN	Material	PK	Cat. No.
		mm				
With solid glass key	12.5	1.5	12541-1		1	9.115 611 1
With solid glass key	12.5	2.5			1	9.115 642
With solid glass key	14.5	2.5	12541-1		1	6.079 648
With solid glass key	14.5	4.0			1	9.115 614
With solid glass key	18.8	4.0	12541-1		1	9.115 644
With solid glass key	18.8	6.0			1	9.115 615
With solid glass key	24*	8.0			1	9.115 618
Spare key, solid glass	12.5	1.5		SBW	1	7.018 947
Spare key, solid glass	12.5	2.5		SBW	1	7.018 936
Spare key, solid glass	14.5	2.5		SBW	1	7.018 948
Spare key, solid glass	14.5	4.0		SBW	1	6.093 232
Spare key, solid glass	24	8.0		DURAN®	1	7.657 852
Spare key, solid glass	29.2	10.0		DURAN®	1	6.266 986

* with rubber retaining device



9.115 611

2 Vacuum stopcocks, glass, Vendura-Nova

Vendura-Nova DURAN®. With PP safety device. Adjustable seal. Comprises of glass stopcock body, PTFE needle with sealing ring and FKM O-rings.

DWK Life Sciences

Fine control gives precise flow metering.

Available in straight or 90° angle patterns.

Leak rate: <math> < 1 \times 10^{-6} \text{ mbar} \times \text{l/s}</math>

Temperature resistant to

with safety device: 140 °C

without safety device: 180 °C

Type	Tube diam.	Flow rate	PK	Cat. No.
		ml / min.		
		mm		
straight	9	0 to 2.5	1	9.117 002
straight	10	0 to 4.0	1	9.117 003
straight	10	0 to 6.0	1	9.117 004
90° angle	9	0 to 2.5	1	9.117 012
90° angle	10	0 to 4.0	1	9.117 013
90° angle	10	0 to 6.0	1	9.117 014

2



3 Stopcocks, with PTFE plug, borosilicate glass 3.3

Acc. to DIN 12541-1 and in addition to DIN standard, with PTFE plug and screwthread retaining device, one straight bore, material: borosilicate glass 3.3, leakage rate acc. to DIN 12540-1.

Lenz

Description	NS	Bore	DIN	Material	PK	Cat. No.
		mm				
With PTFE key	12.5	1.5	DIN 12541-1		1	9.115 631
With PTFE key	12.5	2.5			1	6.070 033
With PTFE key	14.5	2.5	DIN 12541-1		1	9.115 648
With PTFE key	14.5	4.0			1	9.115 634
With PTFE key	18.8	4.0	DIN 12541-1		1	9.115 635
With PTFE key	18.8	6.0			1	6.222 868
With PTFE key	21.5	6.0	DIN 12541-1		1	9.115 637
With PTFE key	24	8.0			1	9.115 638
With PTFE key	29.2	10.0	DIN 12541-1		1	9.115 639
With PTFE key	12.5*	1.5	DIN 12541-1		1	9.115 632
With PTFE key	14.5*	2.5	DIN 12541-1		1	9.115 633
Spare key	12.5	1.5		PTFE	1	7.072 146
Spare key	12.5	2.5		PTFE	1	6.306 550
Spare key	14.5	2.5		PTFE	1	6.801 361
Spare key	14.5	4.0		PTFE	1	6.306 551
Spare key	18.8	4.0		PTFE	1	7.018 955
Spare key	18.8	6.0		PTFE	1	7.630 235
Spare key	21.5	6.0		PTFE	1	7.603 864
Spare key	24	8.0		PTFE	1	7.657 006
Spare key	29.2	10.0		PTFE	1	6.266 985

* with capillary side arms.

3



Rotary Evaporator RV 3

The new RV 3 is the ideal entry-level model of the IKA rotary evaporator portfolio. Thanks to specially designed glass guides, the vertical condenser makes extremely efficient use of the 1500 cm² cooling surface.

IKA

- 4L water heating bath with digital temperature display and carrying handles
- Mechanical lift end-point safety stop
- Locking mechanism: red indicator shows unlocked position of the vapor tube
- Manual lift for precise positioning of the glassware, single-handed, suitable for left and right-handed operators
- Adjustable immersion angle
- Stepless speed setting with dial control and speed display
- Flask clamping mechanism with integrated push-off function for easy exchange of evaporation flasks

1



1 Rotary Evaporator RV 3 V/RV 3 V-C

Scope of supply:

IKA

RV 3 V: Rotary Evaporator RV 3 eco, Heating bath HB eco, vertical glassware RV 10.1

RV 3 V-C: Rotary Evaporator RV 3 eco, Heating bath HB eco, vertical coated glassware RV 10.10

Specifications

Speed range:	20 ... 300 rpm
Stroke displacement:	150 mm
Bath volume:	4 L
Temperature range:	ambient ... 90 °C
Heating power:	1400 W
Permissible ambient temperature:	5 ... 40 °C
Permissible relative humidity:	80 %
Dimensions (W x D x H):	440 x 330 x 530 mm
Weight:	13.5 kg
Protection class according to DIN EN 60529:	IP 20
Power supply:	100 ... 240 V/50/60 Hz

Type	PK	Cat. No.
RV 3 V	1	6.273 133
RV 3 V-C	1	4.661 996

2



2 Rotary Evaporator RV 8

Digital displays for speed and heating bath temperature allow for optimal control of all distilling processes. Thanks to specially designed glass guides, the condenser makes extremely efficient use of the 1500 cm² cooling surface.

IKA

- Clearly visible glass display (black and white)
- Locking mechanism: red display for unlocked state of vapor tube
- Manual lift for precise positioning of glassware
- Water/oil heating bath with integrated ergonomic carrying handles
- Lock function for the heating bath temperature
- Adjustable immersion angle
- Single-hand operation; ambidextrous design
- Easy exchange of evaporation flasks by clamp mechanism with push-out function
- Woulff bottle

Scope of supply:

RV 8 V: Rotary Evaporator RV 8, Heating bath HB digital, vertical glassware RV 10.1

RV 8 V-C: Rotary Evaporator RV 8, Heating bath HB digital, vertical coated glassware RV 10.10

RV 8 FLEX: Rotary Evaporator RV 8, Heating bath HB digital, clamps for glassware

Drive

Speed:	5 to 300 rpm
Speed display:	digital
Stroke displacement:	120 mm, manual

Heating bath

Bath volume:	4 l
Temperature range:	RT to +180 °C
Heating power:	1300W

General data

Dimensions (W x D x H):	510 x 345 x 490 mm
Protection class according to DIN EN 60529:	IP 20
Power supply	100-240 V, 50/60 Hz

Type	PK	Cat. No.
RV 8 V	1	9.813 017
RV 8 V-C	1	9.813 018
RV 8 FLEX	1	9.813 019

Rotary evaporator RV 10 digital

1

The RV 10 digital is a robust and reliable lab companion. Its optimized bath volume allows for fast heat-up times. The vertical condenser unit has special designed glass tubes that utilize the 1500 cm² surface extremely efficient. That's why the RV 10 digital delivers reliable and reproducible process results that are usually reserved for more costly systems. Additional features such as smooth start, left-right interval or timer function capability support the user in their daily lab work. Another important aspect of the RV 10 digital are the sophisticated safety features. The motorized lift has an automated lift-out function in case of power outage to prevent superheating of the solvent. Safety temperature circuits can be set individually. Dry-run protection, adjustable lower end stop and lock function of bath setting, complete the line of safety features. Furthermore, IKA offers a choice of coated glassware for increased safety needs. The RS 232 interface allows for remote control via IKAs "labworldsoft". The Heating bath is controlled via the IR interface from the main unit.

- Universal water/oil heating bath
- Motorized lift with "safety-stop" function
- RS 232 and IR Interface
- Optimized heating bath volume for fast heat-up
- Highly efficient 1500 cm² condenser unit
- Ergonomically placed handles on Heating bath
- Left-right interval
- Timer function
- Dry-run protection
- Safety temperature circuits
- Lower-end stop
- Push-off mechanism to loosen tight fitted glassware
- Easy and safe operation due to ergonomic design of the user interface

Scope of supply:

RV 10 digital V: Rotary evaporator RV 10 digital, heating bath HB digital, vertical glassware RV 10.1, vapor tube RV 10.70

RV 10 digital V-C: Rotary evaporator RV 10 digital, heating bath HB digital, vertical glassware, coated RV 10.10, vapor tube RV 10.70

RV 10 digital V FLEX: Rotary evaporator RV 10 digital, heating bath HB digital, Wouff bottle, spherical joint clip RV 05.10, clamp, NS 29 RV 10.88, vapor tube RV 10.70

Specifications

Drive

Motor rating input:	50 W
Speed range:	20 to 280 rpm
Speed display:	digital
Head angle adjustable:	0 to 45°
Stroke displacement:	140 mm, motorised
Setting of lower end stop:	60 mm, contact-free

Heating bath

Temperature range:	Ambient up to 180 °C
Heating power:	1.300 W

General data

Dimensions (W x D x H):	500 x 430 x 410 mm
Protection class acc. to DIN EN 60529:	IP 20
Power supply:	220-240 V/50/60 Hz

Type	PK	Cat. No.
RV 10 digital V	1	4.664 596
RV 10 digital V-C	1	6.274 521 1
RV 10 digital V FLEX	1	4.664 590

Accessories for Rotary evaporators RV 8/RV 10 digital/RV 10 control

IKA

Type	Description	PK	Cat. No.
VACSTAR digital	Vacuum pump, 22 l/min	1	9.813 026 2
MVP 10 basic	Vacuum pump, 28.3 l/min	1	9.813 010
VCV 1	Vacuum control valve	1	9.813 016
RV 10.70	Vapor tube made of borosilicate glass, NS 29/32	1	6.237 535
RV 10.4002	Magnetic valve laboratory vacuum	1	6.237 538
RV 10.5001	Choke water valve	1	6.237 540
RV 10.5002	Filter	1	6.237 541
RV 10.5003	Pressure regulating valve	1	6.237 542
RV 10.8001	Lip-seal, PTFE with a built-in stainless steel spring	1	4.008 136

2



9.813 026



Suitable Flow coolers please see page 821

Rotary evaporator RV 10 auto/RV 10 auto pro

The rotary evaporator RV 10 auto has a bright, high-contrast, TFT, color-graphic control panel, an integrated vacuum controller and a cooling water monitoring. Additional safety for users is provided by individually adjustable temperature safety circuits, protection against boiling dry, adjustable end-point recognition to prevent glass breakage, and a locking function. The USB port or the RS-232 interface enable remote control with the IKA "labworldsoft" software package and an update option with the firmware update tool. Thanks to specially designed glass guides, the condenser makes extremely efficient use of the 1500 cm² cooling surface.

IKA

The Rotary evaporator RV 10 auto pro rotary evaporator is fitted with the full-automatic vacuum pump VACSTAR digital. This enables better automatic detection of the solvent boiling point. The Vacstar digital is controlled directly from the drive unit of the RV 10 auto via the data cable provided.

- Integrated solvent library with 40 preset solvents and expansion option
- Optimized heating bath volume for rapid achievement of working temperature
- Programming option for up to ten individual procedures
- Smooth start
- Right or left rotation
- Timer function
- Coated flask and condenser as an option
- Automatic vacuum management
- Motorized lift with "safety-stop" function

Scope of supply:

Model RV 10 auto: Rotary Evaporator RV 10 auto with Heating bath HB 10, Magnetic valve RV 10.4002 and Woulff bottle

RV 10 auto V: with vertical glassware RV 10.1

RV 10 auto V-C: with vertical coated glassware RV 10.10

RV 10 auto FLEX: without glassware

Model RV 10 auto pro: Vertical Rotary Evaporator RV 10 auto with Heating bath HB 10, Vacuum pump VACSTAR digital and Woulff bottle

RV 10 auto pro V: with vertical glassware RV 10.1

RV 10 auto pro V-C: with vertical coated glassware RV 10.10

RV 10 auto pro FLEX: without glassware

Specifications

Drive

Speed range: 5 ... 300 rpm

Speed display: digital

Stroke displacement: 140 mm

Heating bath

Bath volume: 4 l

Temperature range: ambient ... +180 °C

Power input: 100 W

Power input standby: 3.3 W

General data

Dimensions (W x D x H): 500 x 410 x 430 mm

Weight: 18.6 kg

Protection class according to DIN EN 60529: IP 20

Power supply: 100 ... 240 V/50/60 Hz

Type	PK	Cat. No.
RV 10 auto V	1	4.664 591 1
RV 10 auto V-C	1	4.664 592
RV 10 auto FLEX	1	4.664 597
RV 10 auto pro V	1	4.664 593 2
RV 10 auto pro V-C	1	4.664 594
RV 10 auto pro FLEX	1	4.664 595

1



4.664 591

2



4.664 593

1 Rotary Evaporator RC 600/RC 900

RC 600

KNF

Fit for purpose

All functions operated centrally via membrane keypad providing exceptional ease of use

Comprehensively robust

Device design and details were especially developed for intensive use

Safe and compact

Cordless heating bath with pour spout, fixed tube guide, easy flask exchange - typical hazards eliminated thanks to well thought out safety features

RC 900

Sleek design, minimum footprint

The RC 900 takes up very little space and offers maximum ease of use

Whisper quiet for a pleasant working environment

The lift and rotation of the RC 900 are virtually silent

Versatile use, simple operation

The system offers central remote control for all functions, and operation via touchscreen and control knob. Stepless adjustable flask inclination.

Specifications

Heating bath: heating bath temperature:	20 to 180 °C
Coolant supply (chilled condenser)	
Permissible pressure:	3 bar
Permissible temperature:	15 °C to +20 °C
Cooled surface area:	1230 cm ²
Parameters of evaporation flask	
Size of evaporation flask:	50 - 3000 ml
Rotational speed:	25 - 250 rpm
Length of stroke:	150 mm
Lifting speed:	approx 38 mm/s
Dimensions (W x D x H)	
Without glassware RC 900/RC 600:	431 x 447 x 464 mm/431 x 453 x 464 mm
With glassware RC 900/RC 600:	487 x 447 x 823 mm/487 x 453 x 823 mm
Weight:	9.1 kg

Type	PK	Cat. No.
RC 600	1	6.269 371
RC 900	1	7.660 052



2 Rotary Evaporator Rotavapor® R-100

The Rotavapor® R-100 is a high-quality rotary evaporator to meet the essential needs in classical laboratory applications. It is capable of a manually adjusting the rotation speed from 20 to 280 rpm and is equipped with an action jack lift for manual lifting of the evaporating flask.

Heating Bath B-100

Temperature range of 20 °C to 95 °C. Max. evaporating flask size: 4000 mL (3 kg). Digital display of set and actual temperature (alternating).

Standard Joint

SJ 29/32

Glass Assembly

Option V: Vertical condenser(V): Vertical condenser used along with a recirculating chiller or tap water.

Option C: Cold trap (C): Cold trap used for low boiling solvents along with e.g. dry ice for cooling.

Protective Coating

Option 1: Without coating

Option 2: Transparent PLASTIC+GLAS (P+G) safety coating. Protect against mechanical damage.

In the event of breakage there is no loss of sample.



2 Rotavapor® R-100 with vertical glass assembly

Heating bath B-100, manual lift.

BÜCHI

Type	Capacitor	Coating	PK	Cat. No.
R-100	vertical	no	1	6.268 002
R-100	vertical	yes	1	6.268 003

Rotary Evaporator Rotavapor® R-300

The rotary evaporator R-300 meets the highest needs in convenience, productivity and versatility. The rotation speed, heating temperature and lift position is shown digitally on the integrated display. Automatic change of the direction of rotation programmable.

Lift System

Option 1: Manual lift

Option 2: Electronic lift

Heating Bath

Option 1: B-301. Temperature range of 20 °C to 95 °C (water). Max. evaporating flask size: 1000 mL (3 kg). Cordless connection.

Digital display of set and actual temperature, rotation speed, lift position. Lock of heating temperature. Fast heat up time.

Option 2: B-305. Temperature range of 20 °C to 220 °C. Max. evaporating flask size: 5000 mL (3 kg). Cordless connection.

Digital display of set and actual temperature, rotation speed, lift position. Lock of heating temperature.

Standard Joint

SJ 29/32

Glass Assembly

Option V: Vertical condenser (V): Vertical condenser used along with a recirculating chiller or tap water.

Option C: Cold trap (C): Cold trap used for low boiling solvents along with e.g. dry ice for cooling.

Other glass assembly configuration on request

Protective Coating

Option: Transparent PLASTIC+GLASS (P+G) safety coating. Protect against mechanical damage.

In the event of breakage there is no loss of sample.



1 Rotavapor® R-300 with heating bath B-301

BÜCHI

Type	Lift	Capacitor	Coating	PK	Cat. No.
R-300	manually	vertical	no	1	6.267 887
R-300	electric	vertical	yes	1	6.267 888
R-300	electric	cold trap	yes	1	6.267 889



2 Rotavapor® R-300 with heating bath B-305

BÜCHI

Type	Lift	Capacitor	Coating	PK	Cat. No.
R-300	manually	vertical	no	1	6.267 890
R-300	electric	vertical	yes	1	6.267 891
R-300	electric	cold trap	yes	1	6.267 892

Rotary Evaporator Hei-VAP Core

Heidolph

- Available as hand or motor lift
- Clear digital display for monitoring the current values and separate button to display the set values
- Two separate operating knobs for adjusting the rotation speed and heating temperature with LED ring light system for activity indication
- Activated lock feature prevents inadvertent adjustments
- Residual heat indicator when >50 °C
- Standby button stops all functions and lifts the evaporator flask out of the heating bath on motor lift models
- Ergonomically optimized heating bath handles sit securely in your hand
- Easily adjust immersion depth up to 155 mm and the tilt angle of the evaporating flask from 20° to 80°
- Grease-free operation thanks to innovative sealing technology
- Ventilation cap with PTFE inlet and free of ground joints. Optionally available with replenishment valve
- Optional cable extension. The operating panel can be detached for use outside closed fume hoods

Scope of supply: Flask clamp Easy-Clip, vapour tube, ventilation cap, heating bath, 1-l receiving flask, 1-l evaporating flask. Supplied condenser as indicated.

Specifications

Drive

Speed range:	10 ... 280 rpm
Speed display:	Digital
Stroke displacement:	155 mm
Protection class:	IP 20

Heating bath

Bath volume:	4.5 L
Temperature range:	Ambient ... 210 °C
Power input:	1300 W
Protection class:	IP 67

General data

Max. size evaporating flask:	5 L
Condensing surface:	1400 cm ²
Condensing surface XL condenser:	2200 cm ²
Power supply:	230 V

Rotary Evaporators Hei-VAP Core, with hand lift

Heidolph

Description	Glassware set	Plug type	PK	Cat. No.
G1 Angled condenser	standard	EU	1	4.666 085
G3 Vertical condenser	standard	EU	1	4.666 086 ¹
G1B Angled condenser	coated	EU	1	4.666 090
G3B Vertical condenser	coated	EU	1	4.666 091
G1 Angled condenser	standard	UK	1	4.666 107
G3 Vertical condenser	standard	UK	1	4.666 108



Rotary Evaporators Hei-VAP Core, with motor lift

Heidolph

Description	Glassware set	Plug type	PK	Cat. No.
G1 Angled condenser	standard	EU	1	4.666 095
G3 Vertical condenser	standard	EU	1	4.666 096 ²
G1B Angled condenser	coated	EU	1	4.666 100
G3B Vertical condenser	coated	EU	1	4.666 101
G1 Angled condenser	standard	UK	1	4.666 117
G3 Vertical condenser	standard	UK	1	4.666 118





1

1 Rubber Balloon with Hose Connection

- Latex (NR)
 - for Rotary Evaporators
 - suitable for mixture or collection and short-term storage of gases
 - for control of air/gas entry or tread out of gas in instruments
- Other sizes on request.

Deutsch & Neumann

Size	Volume	PK	Cat. No.
5	approx. 1.5 - 2 l	1	9.115 515
8	approx. 3.5 - 4 l	1	7.652 667



2

2 Evaporator flask pear shape, borosilicate glass 3.3

Pear shaped Evaporator flask with NS 29/32, suitable for all Rotary evaporators.

ISOLAB

Capacity ml	NS	PK	Cat. No.
100	29/32	1	6.237 167
250	29/32	1	6.237 711
500	29/32	1	6.243 664
1000	29/32	1	6.236 112



3

3 Evaporating flasks with conical ground joint, DURAN®

Especially for rotary evaporators, with center neck and conical joint, pear-shaped, material: DURAN®

Lenz

Capacity ml	Socket NS	Flask diam. mm	PK	Cat. No.
50	29/32	56	1	9.196 020
100	29/32	60	1	9.196 024
250	29/32	81	1	9.196 036
500	29/32	101	1	9.196 044
1000	29/32	126	1	9.196 054
2000	29/32	158	1	9.196 063

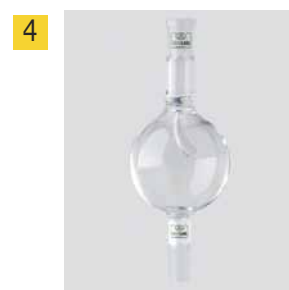

4

Splash head adapter, ground glass joint, borosilicate glass 3.3

Borosilicate glass 3.3. Suitable to be used in distillation assemblies to prevent raw liquid step over from flask to condenser.

ISOLAB

Description	Cone	Socket	PK	Cat. No.
	NS	NS		
straight	14/23	14/23	1	4.008 373 4
straight	29/32	29/32	1	6.255 503
bend	14/23	14/23	1	9.140 508
bend	29/32	29/32	1	9.140 511



5

5 Powder flasks with conical ground joint, DURAN®

Specially for rotary evaporators. For the drying of powder-like substances. With center neck and conical joint, with inscription label.

Lenz

Capacity ml	Socket NS	Flask diam. mm	PK	Cat. No.
100	29/32	60	1	6.205 965
250	29/32	81	1	6.205 966
500	29/32	101	1	6.205 512
1000	29/32	126	1	6.206 195
2000	29/32	158	1	6.205 692



6

6 Receiving flasks, with spherical ground glass joint, borosilicate glass 3.3

Receiving flasks with spherical ground glass joint **KS35** suitable for all Rotary evaporators.

ISOLAB

Capacity ml	Flask diam. mm	Socket KS	PK	Cat. No.
100	64	35	1	6.243 665
250	85	35	1	6.243 666
500	105	35	1	6.243 667
1000	131	35	1	6.243 668

1 LLG-Fork clamps for spherical joints

Made of stainless steel 304. For spherical ground joint connections. With set screw.

Size	PK	Cat. No.
S13	1	9.011 797
S19	1	9.011 798
S29	1	9.011 799
S35	1	9.011 800



2 Receiving flasks, DURAN®

Especially for rotary evaporators, with spherical joint socket S 35, with and without transparent PUR coating, autoclavable, material: DURAN®.

Lenz

Capacity	socket	Flask diam.	Description	PK	Cat. No.
ml	NS	mm			
100	35	64	uncoated	1	9.196 224
100	35	64	PUR coating	1	4.671 390
250	35	85	uncoated	1	9.196 236
250	35	85	PUR coating	1	6.269 414
500	35	105	uncoated	1	9.196 244
500	35	105	PUR coating	1	7.653 714
1000	35	131	uncoated	1	9.196 254
1000	35	131	PUR coating	1	9.812 217
2000	35	166	uncoated	1	9.196 263
2000	35	166	PUR coating	1	6.200 782

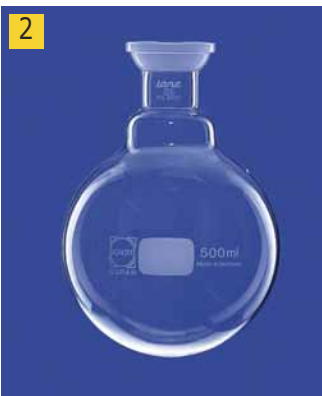

3 Evaporating flasks with conical ground joint, DURAN®, with PUR coating

Lenz



Especially for rotary evaporators, with center neck and conical joint, with highly transparent PUR coating, autoclavable, pear-shaped, material: DURAN®

Capacity	Socket	Flask diam.	PK	Cat. No.
ml	NS	mm		
50	29/32	56	1	6.246 006
100	29/32	60	1	6.246 007
250	29/32	81	1	6.246 008
500	29/32	101	1	6.246 009
1000	29/32	126	1	6.246 010
2000	29/32	158	1	6.242 495
3000	29/32	175	1	6.246 011



Please note that the maximum speed of a centrifuge can be decreased due to the maximum speed value of the rotor. Maximum speed and also the reachable g-value always depends on the rotor's values.

1

6.263 510

2

6.263 515

Mini centrifuges LLG-uniCFUGE 2 and LLG-uniCFUGE 2/5

Compact and reasonably priced mini centrifuges with two rotor types. Speed can be adjusted to 4000 min⁻¹ or 6000 min⁻¹. Powerful motor for fast starting. Quick stop when the lid is opened.

LLG-uniCFUGE 2 with **Universal rotor** for 6 x 1.5/2.0 ml and 6 x 0.5 ml tubes and 2 times 8 x 0.2 ml PCR-strips.

LLG-uniCFUGE 2/5 with **rotor for 4 x 5 ml tubes**.

Scope of supply: centrifuge, mains cable

Specifications

Max. RCF:	1200 x g and 2000 x g
Max. speed:	4000 min ⁻¹ and 6000 min ⁻¹
Motor:	brushless DC motor
Max. load:	6 x 0.5/1.5/2 ml and 2 x 8-tube PCR strips (0.2 ml) or 4 x 5 ml tubes
Dimensions (diam. x H):	140 x 120 mm
Weight:	0.7 kg
Power supply:	100 ... 240 V, 50/60 Hz
Warranty:	3 years

Description	Plug type	PK	Cat. No.
LLG-uniCFUGE 2 with universal rotor	EU	1	6.263 510 1
LLG-uniCFUGE 2 with universal rotor	UK	1	6.263 511
LLG-uniCFUGE 2/5 with rotor for 5 ml tubes	EU	1	6.263 515 2
LLG-uniCFUGE 2/5 with rotor for 5 ml tubes	UK	1	6.263 516

3

3 4 5

Mini centrifuge LLG-uniCFUGE 3 with timer and digital display

A compact and reasonably priced mini centrifuge with brushless and non-wearing high-efficiency motor. Stepless speed adjustment from 0 to 6000 min⁻¹. Microprocessor controlled regulation for load-independent accuracy and integrated imbalance control. Integrated timer (0 - 25 minutes) and high speed constancy for reproducible results. Quick stop when the lid is opened. 2 flow-optimised rotors for 8 x 1.5/2 ml or 16 x 0.2 ml tubes reduce noise level and heat generation. Supplied with suction feet for a stable operation.

The following types of vessel can be used:

- 8 x 1.5 ml micro tubes
- 8 x 2 ml micro tubes
- 16 x 0.2 ml micro tubes

By using the fitting adapter:

- 8 x 0.4 ml micro tubes
- 8 x 0.5 ml micro tubes

Scope of supply: Centrifuge, rotor for 8 x 1.5/2 ml tubes, rotor for 16 x 0.2 ml tubes, adapter for 8 x 0.2/0.4/0.5 ml tubes

4

5

Specifications

Max. RCF:	2000 x g
Max. speed:	variable up to 6000 min ⁻¹
Motor:	brushless DC motor
Max. load:	8 x 1.5/2 ml or 16 x 0.2 ml PCR tubes
Timer:	0 ... 25 min, continuous
Dimensions (diam. x H):	160 x 116 mm
Weight:	1.1 kg
Power supply:	100 ... 240 V, 50/60 Hz
Warranty:	3 years

Description	Plug type	PK	Cat. No.
LLG-uniCFUGE 3	EU	1	6.263 520
LLG-uniCFUGE 3	UK	1	6.263 521

1 2 Mini centrifuge LLG-uniCFUGE 5 with timer and digital display

Fixed angle rotor with lid, made of aluminium for 12 x 1.5/2 ml tubes with optimised aerodynamics which minimize heat and noise during operation. Operation in RPM or RCF mode possible by simple switching. Short-Spin mode with selectable RZB and RPM values. **Large LCD (3.9") display** with intuitive interface. **Integrated imbalance-detection** with automatic shutdown. Wide suction feet provide a stable base. The centrifuge can be controlled via computer by using the included software that can store up to 99 user-defined programmes. Operational record output to Excel.

The following types of vessel can be used:

- 12 x 0.2 ml PCR tubes
- 12 x 0.4 ml centrifuge tubes
- 12 x 0.5 ml centrifuge tubes
- 12 x 1.5 ml centrifuge tubes
- 12 x 2.0 ml centrifuge tubes

Scope of supply: Centrifuge with rotor for 12 x 1.5/2 ml tubes, power supply with USB cable, 12 Adapters for 0.4/0.5 ml tubes, 12 Adapters for 0.2 ml tubes, Allen wrench with T handle, Software CD

Optional:

- Rotor for 16 x 0.2 ml tubes or 2 x 8 PCR-strips (Cat. No. 6.263 535)

Specifications

Max. RCF:	15.595 x g
Max. speed:	variable from 500 ... 15.000 min ⁻¹
Motor:	brushless DC motor
Max. load:	12 x 2 ml PCR tubes
Timer:	0 ... 999 min
Dimensions (W x D x H):	262 x 230 x 131 mm
Weight:	4 kg
Power supply:	100 ... 240 V, 50/60 Hz
Warranty:	3 years



Type	Plug type	PK	Cat. No.
LLG-uniCFUGE 5	EU	1	6.263 530
LLG-uniCFUGE 5	UK	1	6.263 531

Accessories for Mini centrifuge LLG-uniCFUGE 5

Description	PK	Cat. No.
Rotor for 16 x 0,2ml tubes or 2 x 8 PCR-strips	1	6.263 535

3 Mini Centrifuge C1601



Once sample area is loaded and the lid is closed, the rotor rapidly accelerates to 6000 rpm. Ideal for bringing small droplets to the bottom of tubes for micro-filtrations or basic separations.

- Quick release rotor system, no tools needed to exchange rotors
- Electronic braking, for rapid deceleration
- Dual lid switch
- Compact, rugged design

Scope of supply: Mini Centrifuge C1601, Rotor for 8 x 1.5/2.0 ml tubes, Rotor for 4 x 8-strip tubes, individual adapters for 0.2 ml, 0.25 ml and 0.5 ml tubes, fits in rotor 6770-RT, power adapter 24 V

Specifications

Max. RCF:	2000 x g
Max. speed:	6000 rpm
Max. capacity:	8 x 1.5/2.0 ml or 4 x 0.2 ml strips
Dimensions (W x D x H):	172 x 147 x 122 mm
Power supply:	100 ... 240 V, 50/60 Hz



Type	PK	Cat. No.
C1601-B, blue lid	1	4.676 121
C1601-P, purple lid	1	6.274 868

1

1 Mini-centrifuge mini G

Mini-centrifuge for all applications which do not require high speeds, e.g. micro-filtrations and cell separation. Transparent cover allows constant observation of centrifuge. The mini-centrifuge can be used for both PCR-vessels and PCR-strips. As a safety feature, the centrifuge will run only when the lid is closed. Lid opens easily with the press of a button.

IKA

- Fixed speed of 6000 rpm
- Digital timer adjustable from 1 to 99 min
- Integrated quick stop
- Fast start-up of speed
- Compact design and quiet operation
- Rotor exchangeable without tools
- Easy operation with touch keypad

Specifications

Max. RCF:	2000 xg
Max. speed:	6000 rpm
Max. capacity:	8 x 2.0 ml
Timer:	1 to 99 min
Power consumption:	12 W
Dimensions (W x D x H):	155 x 175 x 105 mm
Weight:	1.4 kg
Power supply:	24V DC voltage

Type	Plug type	PK	Cat. No.
IKA mini G	UK/CH	1	9.570 480

2

2 3 4 Mini-Centrifuge Sprout®/Sprout® plus

New SnapSpin™ rotors - a new approach to compact centrifuge use! Introducing the next generation of the Sprout® mini-centrifuge loaded with new features for increased efficiency in the lab. Two new SnapSpin rotors (a six-place standard rotor and an eight-place strip rotor) snap-in and out for fast and easy changes! Plus, two sets of adapters accommodate all major microtube and PCR® tube styles (2.0, 1.5, 0.5, 0.2 mL) for customized use. The Sprout is ideal for microfilter cell separations and HPLC samples. With most spins lasting around 20 seconds, the ergonomically designed lid is specifically designed to fit in the palm of your hand for easy repeat opening and use. Made with UV resistant plastic.

Heathrow Scientific

Operation is now faster and easier: Snap in rotor, load and close. For repeated spins, simply close the lid to reactivate. An internal safety switch ensures the Sprout will not operate without the lid open. Small size offers minimal benchtop space and removable cord for compact storage.

- Low noise and vibration
- Small size
- Quick Spin feature for short spins.
- Numbered tube positions
- Unit will not operate without lid in place
- Power Adapter with power cords for worldwide usage

Sprout® plus additionally with:

- Locking lid for added protection when the unit is in use
- Larger lid to accommodate longer and skirted tubes and taller tube lids

Scope of delivery:

- Two easy change, tool-free rotors. 1. Circular, one-size rotor for six 1.5- and 2.0 ml tubes or use with adapters to spin six 0.5 ml tubes. 2. Strip rotor for two 8 x 0.2 ml PCR tube strips or 16 x individual 0.2 ml PCR tubes. Six 0.2 mL and six 0.5 mL adapters for customized use.
- Storage Case, PP - Keeps rotors and adapters contained and dust-free
- Tube Rack, PP - Convenient for handling samples before and after quick spins. For 16 x 2.0/1.5 ml micro centrifuge tubes (diam. 12 mm).
- 4 replacement lid o-rings

3

4

Specifications

Max. RCF:	2000 xg
Max. speed:	6000 rpm
Max. capacity:	6 x 1.5/2.0 ml tubes or 2 x 8-strips PCR
Power consumption:	7.3 W
Dimensions (W x D x H):	128 x 153 x 104 mm
Weight:	1.45kg
Power supply:	100-240 VAC, 50/60 Hz, 0.6 A
Warranty:	5 years

Type	Colour	Dimensions (W x D x H) mm	PK	Cat. No.
Sprout®	green	128 x 153 x 104	1	6.254 604
Sprout® plus	green	128 x 153 x 109	1	4.666 426
Sprout® plus	blue	128 x 153 x 109	1	4.666 427

6. Distillation, separation, filtration

Separating, centrifuging/Minicentrifuges

1 2 3 Centrifuge/vortexer, Combispin PCV-2400

Combined centrifuge/vortex mixer for microtubes and 0.2 ml strips. For independent centrifuge and vortex mixing, or mixing of an individual tube concurrently with spinning of multiple tubes. The vortex cup, located at the top of the central shaft, emerges through an opening in the closed lid. In spin-mix-spin applications, the Combispin can be used with very low reagent volumes. Grant

- Continuous operation or short spin
- Further rotors on option: 8 x 1.5/2.0 ml + 8 x 0.5 ml microtubes or 6 x 1.5/2.0 ml + 6 x 0.2 ml microtubes or 2 x 8-well 0.2 ml strips

Scope of supply: Centrifuge, rotor for 12 x 1.5 ml tubes, rotor for 12 x 0.5 ml + 12 x 0.2 ml tubes

Specifications

Max. RCF:	700 x g
Max. speed:	fixed at 3500 rpm
Max. capacity:	12 x 1.5 ml or 12 x 0.5 ml + 12 x 0.2 ml or 2 x 8-well strips 0.2 ml
Power consumption:	11 W
Dimensions (W x D x H):	190 x 235 x 125 mm
Weight:	2.1 kg
Power supply:	120 ... 230 VAC, 50/60 Hz, 12 VDC

Type	Description	PK	Cat. No.
PCV-2400	incl. 2 rotors	1	9.721 001

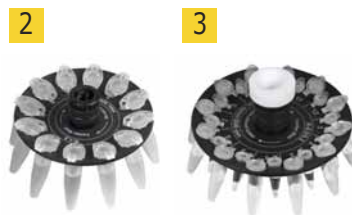

4 Centrifuge Multi-spin PCV-6000

Combined centrifuge/vortex mixer for microtubes and 0.2 ml strips. For independent centrifuge and vortex mixing operations, or a programmable sequence of spin and mix phases of multiple tubes. Grant

- Vortex mixing intensity: three stage adjustment (soft, medium and hard)
- Interchangeable rotors for 2.0 ml, 1.5 ml, 0.5 ml, 0.2 ml microtube combinations and 0.2 ml strips
- Timed vortex mixing: 1 sec to 20 sec
- Supplied with 2 rotors: 12 x 1.5/2.0 ml and 12 x 0.5 ml plus 12 x 0.2 ml

Specifications

Max. RCF(bottom of tubes)	2350 xg
Max. speed	6000 rpm
Max. capacity:	12 x 1.5/2.0 ml or 12 x 0.5 ml plus 12 x 0.2 ml or 2 x 0.2 ml strips of 8
Spin Timer	1 sec to 30 min
Power consumption	24 W
Dimensions (W x D x H):	190 x 235 x 125 mm
Weight:	2.5 kg
Power supply:	100 - 240 V, 50/60 Hz
Input voltage	24 V

Type	Description	PK	Cat. No.
PCV-6000	Centrifuge Multi-spin	1	9.721 004



5 Centrifuge CVP-2

The CVP-2 enables the simultaneous sample preparation of multiple samples at one time. Versatile through being able to hold non-, semi- and fully-skirted PCR plates with no additional accessories required. Grant

- Centrifuge and vortex mixer combined for significant time saving
- Independent vortex and centrifuge timers with up to 999 cycles
- Adjustable rpm or 4 programmable presets
- Consistent preparation of up to 192 samples continuously

Specifications

Max. RCF:	245 xg
Max. speed Centrifuge/Vortexer:	300 to 1500 rpm/300 to 1200 rpm
Max. capacity:	2 PCR plates
Timer Centrifuge/Vortexer:	0 to 30 min/0 to 60 sec
Power consumption:	24 W
Dimensions (W x D x H):	285 x 350 x 190 mm
Weight:	approx. 6 kg
Power supply:	100 - 240 V, 50/60 Hz
Input voltage:	24 V

Type	Description	PK	Cat. No.
CVP-2		1	6.269 768



1

1 Minicentrifuges MiniSpin® and MiniSpin® plus (General Lab Product)

Eppendorf AG

The powerful and user-friendly MiniSpin® and MiniSpin® plus microcentrifuges are extremely compact and have a small footprint. Depending on your needs, you can choose between two models. MiniSpin® plus provides the speed required for molecular biology separations.

- Especially quiet due to its carefully balanced drive
- Maintenance-free motor
- Clear digital display
- Minimal sample heating (after 20 min. at max. speed only 12 °C max.)
- Separate short-spin button
- Automatic lid opening
- Integral power supply unit
- Capacity: 12 x 1.5/2 ml containers
- Autoclavable rotor (121 °C, 20 min.)
- Start-up/slow-down time less than 13 secs. (to/from max. speed).

Additional features of MiniSpin®

- Includes standard anodised aluminium rotor
- Timer can be set for up to 30 minutes

Additional features of MiniSpin® plus

- Includes "Black Line" aluminium rotor
- Speed/rcf display switch
- Timer can be set for up to 99 minutes
- Permanent centrifuging option

This centrifuges are General Lab Products for research purposes.

Specifications

	MiniSpin® // MiniSpin® plus
Max. RCF:	12.100 x g // 14.100 x g
Max. speed:	13.400 rpm // 14.500 rpm
Max. capacity:	12 x 1.5/2 ml tubes
Timer:	15 s to 30 min // 15 s to 90 min, continuous run
Power consumption:	70 W // 85 W
Dimensions (W x D x H):	226 x 239 x 130 mm // 226 x 239 x 120 mm
Weight:	4.3 kg
Power supply:	230 V, 50/60 Hz

Type	Plug type	PK	Cat. No.
MiniSpin®	EU	1	4.660 583
MiniSpin®	UK	1	4.660 584
MiniSpin® plus	EU	1	4.660 585
MiniSpin® plus	UK	1	4.660 586

Online also available as IVD version.

2

2 Mini Plate Spinner MPS 1000

Labnet

Centrifuge designed specifically for quick and easy centrifugation of samples in PCR plates or microplates.

- Capacity for two standard plates
- Accepts skirted, non-skirted and all standard PCR plates
- Use before and after thermal cycling to increase PCR yield
- Top loading design
- Exceptionally small footprint

Specifications

Max. RCF:	500 xg
Max. speed:	2500 rpm
Max. capacity:	2 PCR Plates
Power consumption:	75 W
Dimensions (W x D x H):	160 x 160 x 180 mm
Weight:	1.5 kg
Power supply:	230V 50/60 Hz

Type	PK	Cat. No.
MPS 1000	1	9.945 790

1 General purpose centrifuge LMC-3000



1

Low speed benchtop centrifuge for biomedical applications with changeable rotors for accommodating centrifuge tubes (10 to 15 ml or 50 ml) or standard 96-well microtitre plates. Suitable for a wide range of analytical applications including biomedical, bio-organic and immunoenzyme analysis.

- Easy set-up of spin speed and time via 2-line LCD display and push buttons
- Powerful and quiet motor (59.4 dBA) with soft start-up and run-down function
- Timer with automatic switch-off
- Automatic imbalance switch-off
- Lid lock when centrifuge is running
- Sturdy metal housing and lid
- Compact design with small footprint

Please order rotors separately.

Specifications

Max. RCF tubes/microplates:	1700 x g/560 x g
Max. speed tubes/microplates:	100 ... 3000 rpm/100 ... 2000 rpm
Max. capacity:	12 tubes or 2 microplates
Timer:	1 ... 90 min
Power consumption:	120 W
Dimensions (W x D x H):	495 x 410 x 235 mm
Weight:	11.8 kg
Power supply:	230 V, 50/60 Hz

Type	PK	Cat. No.
LMC-3000	1	4.664 238



2 Centrifuge LMC-4200R



2

Refrigerated Centrifuge for temperature control of biomaterial during cell suspension separation. For use in incubators and closed laboratory rooms. It ensures conditions necessary for reproducibility of sample preparation stage connected with cell destruction and extraction of its heat-labile components (metabolites, enzymes, hormonal factors, cytokines, etc.). With changeable rotors for accommodating centrifuge tubes (10 to 15 ml or 50 ml) or standard 96-well microtitre plates.

- Easy set-up of spin speed and time via 2-line LCD display and push buttons
- Powerful and quiet motor (65 dBA) with soft start-up and run-down function
- Timer with automatic switch-off
- Automatic imbalance switch-off
- Lid lock when centrifuge is running
- Sturdy metal housing and lid
- Compact design with small footprint

Please order rotors separately.

Specifications

Max. RCF tubes/microplates:	3370 x g/560 x g
Max. speed tubes/microplates:	100 ... 4200 rpm/100 ... 2000 rpm
Temperature range:	-10 ... +25 °C
Max. capacity:	12 tubes or 2 microplates
Timer:	1 ... 90 min
Power consumption:	990 W
Dimensions (W x D x H):	635 x 580 x 335 mm
Weight:	62 kg
Power supply:	230 V, 50/60 Hz

Type	PK	Cat. No.
LMC-4200R	1	4.671 981



Rotors for Centrifuges LMC-3000/LMC-4200R



3

Type	Description	PK	Cat. No.
R-2	Rotor for 2 x 96 well microplates	1	6.311 291 3
R-24GC	Rotor for 24 Gel cards	1	4.671 973



6.311 291

1

1 Midi centrifuge G-L

Due to the material separation at medium speeds, this midi centrifuge is ideal for all types of separation processes, such as in molecular biology. It can be used with standard 1.5/2 ml tubes as well as with PCR strips. The cover opens automatically at the press of a button.

IKA

- High-performance motor
- With metal cover
- Starts only when the cover is firmly closed
- Direct and easy setting of speed, rotational speed and programmes via membrane keypad

Scope of delivery: Midi centrifuge inkl. metal rotor and cover for 12 vessels, with a capacity of 1.5/2 ml

Specifications

Max. RCF:	16.500 x g
Max. speed:	15.700 min ⁻¹
Max. capacity:	12 x 1.5/2.0 ml
Power consumption:	65 W
Dimensions (W x D x H):	200 x 280 x 140 mm
Weight:	3.9 kg
Power supply:	220 ... 230 V, 50 ... 60 Hz
Protection class:	IP 20

Type	PK	Cat. No.
G-L	1	4.664 755

2

9.945 795

Microcentrifuge Prism™/Prism™ R

Operation can be timed, continuous or momentary, using the "quick" button. Vibration free operation is ensured by an isolation system. In the event of a significant imbalance, operation of the centrifuge is automatically stopped. Deceleration at the end of a run is very quick, but will not disrupt samples. Supplied with a uniquely designed 24 x 1.5 ml/2.0 ml rotor that allows easy access to the tops of the sample tubes. Individual tube slots in the solid aluminum rotor support tubes along their length and contain the sample in the event of tube failure. The rotor is seated on a tapered shaft which facilitates easy removal for cleaning and autoclaving.

Labnet

Adapters for smaller tubes and PCR strips -please order separately.

Specifications

Max. RCF	
Prism™:	21.200 xg
Prism™ R:	17.135 xg
Max. speed	
Prism™:	500 ... 15.000 rpm
Prism™ R:	500 ... 13.500 rpm
Max. capacity:	24 x 1.5/2.0 ml
Cooling temperature Prism™ R:	-10 ... 40 °C
Timer:	0.5 to 99 minutes or continuous, "Quick" button for momentary operation
Power consumption	
Prism™:	210 W
Prism™ R:	500 W
Dimensions (W x D x H)	
Prism™:	240 x 350 x 190 mm
Prism™ R:	277 x 450 x 247.5 mm
Weight	
Prism™:	9.6 kg
Prism™ R:	20 kg
Power supply:	230 V, 50 Hz or 120 V, 60 Hz

3

9.945 793

Description	PK	Cat. No.
Prism ambient microcentrifuge with 24 place rotor	1	9.945 795 2
Prism R ambient microcentrifuge with 24 place rotor and cooling	1	9.945 793 3
StripSpin adapter for 0.2 ml tubes and strips	1	9.945 794
Individual adapter for 0.5/0.6 ml tubes	6	9.945 796
Individual adapter for 0.4/0.25 ml tubes	6	9.945 797
Individual adapter for 0.2ml thermal cycling tubes	6	9.945 798

1 Microcentrifuge 226R

NEW

1

Labnet

This refrigerated universal microcentrifuge is a tabletop unit for general laboratory use. It is suitable for industrial, biochemical, medical, veterinary and other research laboratories.

- Centrifuge with cooling
- Button for faster cooling (to 4 °C within 6 minutes)
- 99 user programs
- 10 acceleration and deceleration settings
- Large graphic LC-display
- Automatic lid opening
- Unbalance sensor
- Emergency lid lock release
- Motor thermal protection
- Maintenance free induction motor



Please order rotors separately.

Specifications

Max. RCF:	21382 x g
Max. speed:	90 ... 15000 rpm
Max. capacity:	90 ml
Temperature range:	-20 °C ... 40 °C
Timer:	1 sec. ... 99 h 59 min 59 sec.
Dimensions (W x D x H):	299 x 595 x 283 mm
Weight:	31 kg
Power consumption:	500 W
Power supply:	230 V

Type	PK	Cat. No.
226R	1	4.676 139

Accessories for Microcentrifuge 226R

NEW

Labnet

Type	Description	PK	Cat. No.
C0226-125	Fixed angle rotor, 12 x 5 ml	1	4.676 140
C0226-610	Fixed angle rotor, 6 x 10 ml	1	4.676 144
C0226-615	Fixed angle rotor, 6 x 15 ml	1	4.676 145
C0226-4PCR	Fixed angle rotor, 4 x 8 x 0.2 mL PCR strip tubes	1	4.676 143
C0226-242	Fixed angle rotor, 24 x 1.5/2.0 ml, hermetically sealed lid	1	4.676 141
C0226-242SC	Fixed angle rotor, 24 x 2 ml filter tubes/spin columns, hermetically sealed lid	1	4.676 142



Benchtop centrifuge 336/336R

NEW

Labnet

These high performance centrifuges are capable of high speed operation. Suitable for industrial, biochemical, medical, veterinary laboratories and basic research. Available as non-refrigerated (C0336) and refrigerated (C0336R) models.

- 100 user programs
- Password protection
- Programmable density setting for samples > 1.2 g/cm³ (automatic max. speed correction)
- Large graphical LC-display
- Automatic lid opening, start blocking at opened lid
- Emergency lid lock release
- Unbalance sensor
- Maintenance free induction motor

Please order rotors separately.

Specifications

Max. RCF:	24270 x g
Max. speed:	90 ... 18000 rpm
Max. capacity:	400 ml
Temperature range:	-20 °C ... 40 °C (C0336R)
Timer:	1 sec. ... 99 h 59 min 59 sec.
Dimensions (W x D x H):	365 x 495 x 320 (C0336)/365 x 660 x 320 (C0336R)
Weight:	28 kg (C0336)/47 kg (C0336R)
Power consumption:	250 W (C0336)/600W (C0336R)
Power supply:	230 V

Type	PK	Cat. No.
C0336	1	4.676 146 1
C0336R	1	4.676 147 2

1

4.676 146

2

4.676 147

Accessories for Benchtop centrifuge 336/336R

NEW

Labnet

Type	Description	PK	Cat. No.
C0336-3016	Fixed angle rotor with buckets, 30 x 10 ml	1	4.676 153
C0336-3015	Fixed angle rotor with buckets, 30 x 15 ml	1	4.676 152 3
C0336-850F	Fixed angle rotor with buckets, 8 x 50 ml tube	1	4.676 148 4
C0336-850G	Fixed angle rotor with buckets and PC caps, 8 x 50 ml tube	1	4.676 149
C0336-HEM	Fixed angle rotor, hematocrite	1	4.676 156
C0336-125F	Angle rotor, 12 x 5 ml tubes, hermetically sealed lid	1	4.676 150
C0336-362	Angle rotor, 36 x 2/1.5 ml tubes, hermetically sealed lid	1	4.676 154
C0336-2MP	Swinging rotor, for 2 microplates with 2 hangers	1	4.676 151
C0336-4100	Swinging bucket rotor, 4 x 100 ml (buckets not included)	1	4.676 155 5
C0336-100B	100 ml bucket for C0336-4100	1	4.676 157
C0336-100BC	100 ml buckets with cap for C0336-4100	1	4.676 158
C0336-C15	Carrier for standard 15 ml centrifuge tubes for C0336-850F or C0336-850G	1	4.676 159
C0336-C50	Round carriers for 50 ml C0336-100B	1	4.676 160
C0336-133AD	Round carrier 13.3 mm for C0336-3015 or C0336-3016	1	4.676 161
C0336-4VAC	Round carrier 4 x 15/10 ml for Vacutainer® tubes for C0336-4100	4	4.676 162

3

4.676 152

4

4.676 148

E & OE.

5

4.676 155

Microcentrifuge Sigma 1-14/1-14K

Available as uncooled (Sigma 1-14) and cooled (Sigma 1-14K) model.

- Clearly organised display
- Large buttons
- Zero-maintenance motor
- Motorised cover lock, automatic lid unlocking
- Speed/RCF indication
- Two acceleration and braking curves, soft or fast
- Window in lid for independent speed measurement
- Overspeed monitoring
- Manufactured in compliance with EN 61010-2-020

Sigma-Laborzentrifugen

1



6.263 897

Cooled centrifuge Sigma 1-14K

- Stainless steel bowl
- Quick cool program
- 10 programs
- R134a refrigerant (CFC-free)

Please order rotor separately. Further rotors available on request.

Specifications

Max. RCF Sigma 1-14/1-14K:	16.163 x g/16.602 x g
Max. speed Sigma 1-14/1-14K:	14.800 rpm/15.000 rpm
Max. capacity:	24 x 1.5/2 ml
Cooling temperature 1-14K:	-10 to +40 °C
Timer:	10 s to 99 min
Power consumption Sigma 1-14/1-14K:	95 W/230 W
Dimensions (W x D x H) Sigma 1-14/1-14K:	266 x 212 x 176 mm/515 x 273 x 236 mm
Weight Sigma 1-14/1-14K:	6 kg/19 kg
Power supply:	220-240 V, 50/60 Hz

2



6.234 818

Type	PK	Cat. No.
Microcentrifuge Sigma 1-14	1	6.234 817
Microcentrifuge Sigma 1-14K	1	6.263 897 1
Fixed-angle rotor, aluminium, 12 x 1.5/2.0 ml, incl. lid, PS	1	6.234 818 2
Fixed-angle rotor, PP, 24 x 1.5/2.0 ml, incl. lid, PS	1	6.241 448
Fixed-angle rotor, aluminium, 24 x 1.5/2.0 ml, incl. lid, PS	1	6.259 496

3 Benchtop centrifuge Sigma 2-7

Innovative LED running indicator, with blue light

- Clearly organised display
- Large buttons
- Motorised lid lock for easy, effortless operation
- Low noise level, 55 dB(A) at maximum speed
- Corrosion-resistant, easily cleaned stainless steel drum
- Automatic method for serum tubes
- 10 program memory slots
- Low temperature rise in continuous operation
- Zero-maintenance motor
- Two acceleration and braking curves: soft and fast
- Compact device fits on every lab bench
- Imbalance monitoring and shutdown
- Overspeed monitoring
- Window in lid for independent speed measurement
- Manufactured in compliance with EN 61010-2-020

Sigma-Laborzentrifugen

3



Please order rotor separately. Further adapters for beakers on request.

Specifications

Max. RCF:	2540 x g
Max. speed:	4000 rpm
Max. capacity:	30 x 15 ml/4 x 100 ml
Timer:	10 s bis 99 min
Power consumption:	210 W
Dimensions (W x D x H):	378 x 535 x 293 mm
Weight:	23 kg
Power supply:	100-240 V, 50/60 Hz

Type	PK	Cat. No.
Sigma 2-7	1	6.281 131
Fixed-angle rotor, 20 x 15 ml incl. 10 Sets of beakers	1	6.242 155
Swing-out rotor, 2-place	1	6.287 820
Multicarrier, plastic, for 4 vessels 5-15 ml	2	6.701 260

Separating, centrifuging/Benchtop centrifuges

1



6.262 862

Laboratory centrifuge Sigma 2-16P/2-16KL

Available as uncooled (Sigma 2-16P) and cooled (Sigma 2-16KL) model.

Sigma-Laborzentrifugen

- Universal laboratory centrifuge for swing-out and fixed-angle rotors
- Spincontrol Universal
- Backlit Start, Stop, and Lid Open buttons
- Sedimentation in swing-out vials up to 4 x 100 ml or up to 20.000 x g in fixed-angle rotor
- Zero-maintenance brushless drive
- Selectable speed up to 15.000 rpm
- Low-speed operation down to 100 rpm also possible
- Rotor identification prevents overspeed operation
- Stainless-steel centrifuge bowl
- Imbalance switch
- Easy lid opening with gas spring support
- Window in lid for independent speed checking
- Produced in compliance with the latest national and international standards (e.g. EN 61010-2-020)

Cooled centrifuge Sigma 2-16KL

- Spincontrol L
- Universal laboratory centrifuge with speed range up to 15.300 rpm
- Rotor cooling also possible at standstill, CFC-free refrigerant

Please order rotor separately. Further rotors available on request.

Specifications

Max. RCF Sigma 2-16P/2-16KL:	20.627 x g/21.913 x g
Max. speed Sigma 2-16P/2-16KL:	15.000 rpm/15.300 rpm
Max. capacity:	4 x 100 ml
Cooling temperature 2-16KL:	-10 to +40 °C
Power consumption Sigma 2-16P/2-16KL:	340 W/720 W
Dimensions (W x D x H) Sigma 2-16P/2-16KL:	365 x 452 x 300 mm/550 x 570 x 310 mm
Weight Sigma 2-16P/2-16KL:	32 kg/60 kg
Power supply:	220-240 V, 50/60 Hz

Type	PK	Cat. No.
Laboratory centrifuge Sigma 2-16P	1	6.242 154
Laboratory centrifuge Sigma 2-16KL	1	6.262 862 1
Fixed-angle rotor, 20 x 15 ml incl. 10 Sets of beakers	1	6.242 155
Fixed-angle rotor, 30 x 1,5/2,0 ml, incl. lid, aluminium (only for 2-16P)	1	6.287 702
Fixed-angle rotor, 12 x 5 ml, Eppendorf tubes, incl. lid, aluminium	1	6.287 705
Swing-out rotor for micro plates, incl. 1 Set of carriers	1	6.287 709
Micro-haematocrit rotor, for 24 capillary tubes diam 1.5 x 75 mm, 50 µl	1	6.287 713

2



Benchtop centrifuge Sigma 3-18KS

Universal refrigerated benchtop centrifuge for various swing-out and fixed-angle rotors

Sigma-Laborzentrifugen

- User-friendly Spincontrol S controller
- Backlit Start, Stop, and Open Lid buttons
- Zero-maintenance induction motor
- Suitable for low speeds
- Magnetic rotor identification
- Stainless-steel centrifuge bowl
- Unbalance switch
- Motorised lid lock
- Emergency opening of lid without opening of housing
- Window in lid for external speed monitoring
- Complies with the latest national and international standards (EN 61010-2-020)
- Rotor cooling also possible at standstill; CFC-free R134a refrigerant

Please order rotor separately. Further rotors, beakers and adapters available on request.

Specifications

Max. RCF:	30.070 x g
Max. speed:	18.000 rpm
Max. capacity:	4 x 400 ml
Cooling temperature:	-20 to +40 °C
Power consumption:	1010 W
Dimensions (W x D x H):	630 x 600 x 355 mm
Weight Sigma:	78 kg
Power supply:	220-240 V, 50/60 Hz

3



6.203 812

Type	PK	Cat. No.
Sigma 3-18KS	1	6.280 588
Fixed-angle rotor, 24 x 1.5/2.0 ml, incl. lid, aluminium	1	6.900 875
Swing-out rotor for micro plates, incl. 1 Set of carriers	1	6.253 591
Swing-out rotor, 4-place	1	6.203 812 3

1 Microlitre centrifuge Z 167 M

The Z 167 M is ideally suited for the routine centrifugation of reaction tubes. Equipped with a powerful drive, it accelerates the 18 x 1.5/2.0 ml rotor in a very short time to approx. 16.000 xg.

Hermle

Color visual representation of the operating state such as standstill, sleep mode or centrifugation.

- Microprocessor with large LCD display
- Electromagnetic lid lock
- Active imbalance identification and cut-off
- Air Cooling System
- Permanent indication of pre-set and actual values
- Storage of up to 99 runs
- Noise level < 57 dBA, at max. speed
- Splash-proof foil keyboard with touch function
- Manufactured in accordance to International Safety Regulations, i.e. IEC 61010

Scope of supply: Microlitre centrifuge Z 167 M incl. angle rotor for 18 x 1.5/2.0 ml

Specifications

Max. RCF:	15.994 xg
Max. speed:	14.000 rpm
Max. capacity:	18 x 1.5/2.0 ml
Timer:	59 min 50 s/10 s increments 99 h 59 min/1 min increments
Power consumption:	130 W
Dimensions (W x D x H):	280 x 350 x 240 mm
Weight:	12 kg
Power supply:	230 V, 50/60 Hz



Description	PK	Cat. No.
Microlitre centrifuge Z 167 M incl. angle rotor for 18 x 1.5/2.0 ml	1	4.665 708

2 Microlitre centrifuge Z 216 M/Z 216 MK

The Z 216 M and Z 216 MK are setting new standards in this centrifuge class. Capable of centrifuging up to 44 x 1.5/2.0 ml at each run. Due to their compact design and quiet running properties they are fitting perfectly in their working area. The powerful refrigeration system of Z 216 MK keeps samples at temperatures as low as 4 °C during a continuous run at 20000 xg.

Hermle

- Maintenance-free induction drive
- Microprocessor with large LCD Display
- Motor driven lid lock
- Active imbalance-identification and cut off
- Standstill cooling
- Audible signal at the end of each run
- Rapid acceleration and deceleration (see rotor data)
- Lowest sample temperature 4 °C at 20000 xg
- Noise level < 60 dBA at 20000 xg
- Extremely compact with a space saving footprint
- Quick access to samples with a snap on lid
- Aerosol tight rotor option
- Manufactured according to international safety regulations, i.e. IEC 61010
- Distinct control panel

Specifications

Z 216 M/Z 216 MK

Max. RCF:	21379 xg
Max. speed:	15000 rpm
Max. capacity:	44 x 1.5/2.0 ml
Cooling temperature Z 216 MK:	-20 to 40 °C
Timer:	59 min 50 sec/10 sec increments 99 h 59 min/1 min increments
Power consumption:	280 W/560 W
Dimensions (W x D x H):	280 x 390 x 290 mm/280 x 550 x 290 mm
Weight:	17 kg/35 kg
Power supply:	230 V, 50/60 Hz



7.660 217

Description	PK	Cat. No.
Microlitre centrifuge Z 216 M without rotor	1	7.660 217 2
Refrigerated microlitre centrifuge Z 216 MK without rotor	1	6.231 520
Refrigerated microlitre centrifuge Z 216 MK incl. angle rotor 24 x 1.5/2.0 ml	1	6.230 074
Angle rotor 24 x 1.5/2.0 ml	1	6.268 964
Angle rotor for 4 x 8 PCR Stripes	1	6.287 481
Angle rotor for 12 x 5 ml reaction vessels, closable	1	7.660 218
Angle rotor for 24 x 1.5/2.0 ml reaction vessels, closable	1	6.270 209

Separating, centrifuging/Benchtop centrifuges

1



1 Microliter Centrifuge Z 207 M

The Microliter Centrifuge, Z 207 M was designed specifically for small, compact spaces, suitable in any laboratory setting. Option for two different rotor types: a Fixed-angle rotor for 24 x 1.5/2.0 ml (also hermetically sealed available) and a rotor for Spin Column Kits. Distinct control panel "Touch" function for easy operation, also with gloves. Optimum air cooling of the samples even at maximum speed.

Hermle

- Maintenance-free induction drive
- Rapid acceleration and deceleration
- Noise level below 60 dBA at 17.317 x g
- Microprocessor with large LCD Display
- Active imbalance-identification and cut off
- Audible signal at the end of each run
- Quick access to samples with a snap on lid
- Manufactured according to international safety regulations, i.e. IEC 61010
- Quick-key for short runs
- Storage of up to 99 runs

Without rotor. Please order separately.

Specifications

Max. RCF:	17.317 x g
Max. speed:	13.500 rpm
Max. capacity:	24 x 1.5/2.0 ml
Timer:	59 min 50 sec/10 sec increments 99 h 59 min/1 min increments
Power consumption:	170 W
Dimensions (W x D x H):	280 x 350 x 240 mm
Weight:	12.5 kg
Power supply:	230 V, 50/60 Hz

2



6.290 911

3



6.290 912

Description	PK	Cat. No.
Microliter Centrifuge Z 207 M	1	6.290 909
Fixed-angle rotor 24 x 1.5/2.0 ml	1	6.290 910
Fixed-angle rotor 24 x 1.5/2.0 ml, hermetically sealed	1	6.290 911 2
Fixed-angle rotor 18 x for Spin Column Kits	1	6.290 912 3

4



4 Compact centrifuge Z 206 A

The Z 206 A accepts up to 12 x 15 ml conical and round bottom tubes. For tubes with smaller dimensions we offer several adapters. For larger volumes we offer an angle rotor for 6 x 50 ml conical and round bottom tubes.

Hermle

- Microprocessor with LCD display
- Electrical lid lock
- Pre-selection of the rotor type
- Active imbalance-identification and cut off
- Manufactured according to international safety regulations, i.e. IEC 61010
- Noise level under 60 dBA at max. speed
- A large variety of rotors and accessoires
- Easy change of rotors
- Distinct control panel

Specifications

Max. RCF:	4427 x g
Max. speed:	6000 rpm
Max. capacity:	6 x 50 ml
Timer:	59 min 50 sec/10 sec increments 99 h 59 min/1 min increments
Power consumption:	100 W
Dimensions (W x D x H):	280 x 370 x 260 mm
Weight:	12 kg
Power supply:	230 V, 50/60 Hz

5



9.945 728

Description	PK	Cat. No.
Compact centrifuge Z 206 A without rotor	1	9.945 737
Compact centrifuge Z 206 A incl. angle rotor 12 x 15 ml	1	9.945 738
Angle rotor 12 x 15 ml	1	9.945 728 5
Angle rotor 6 x 50 ml	1	9.945 729
Angle rotor 18 x 1.5 / 2.0 ml	1	9.945 739
Swing out rotor 6 x 5 ml	1	9.945 740

1 Compact centrifuge Z 207 A

The Compact Centrifuge, Z 207 A for 8 x 15 ml tubes is ideal for use with small sample sizes. Distinct control panel "Touch" function for easy operation, also when working with gloves.

Hermle

- Microprocessor with large LCD display
- Electrical lid lock
- Active imbalance-identification and cut off
- Manufactured according to international safety regulations, i.e. IEC 61010
- Noise level < 60 dBA at max. speed
- Adapter for tubes with low volume
- Quick-key for short runs
- Storage of up to 99 runs

Scope of supply: Compact centrifuge Z 207 A incl. angle rotor for 8 x 15 ml

1



Specifications

Max. RCF:	4445 x g
Max. speed:	6800 rpm
Max. capacity:	8 x 15 ml
Timer:	59 min 50 sec/10 sec increments 99 h 59 min/1 min increments
Power consumption:	50 W
Dimensions (W x D x H):	280 x 350 x 240 mm
Weight:	8 kg
Power supply:	100-230 V, 50/60 Hz

Description	PK	Cat. No.
Compact centrifuge Z 207 A incl. angle rotor for 8 x 15 ml	1	7.971 698

2 Refrigerated high speed centrifuge Z 32 HK

With a wide range of accessories, the Z 32 HK high speed centrifuge is applicable in a wide variety of research settings. In spite of the remarkably small footprint, the Z 32 HK features a powerful refrigeration system capable of maintaining cool sample temperatures even at maximum speed.

Hermle

- Maintenance-free induction drive
- Microprocessor with large LCD display
- Motor driven lid lock
- Automatic rotor identification system with over speed protection immediately upon rotor installation
- Active imbalance identification and cut off rotor specific
- Imbalance tolerant drive
- CFC-free refrigeration system
- A large variety of rotors and accessories
- Manufactured according to international safety regulations, i.e. IEC 61010
- Audible signal at the end of each run with several melody options
- Quick and easy rotor exchange
- Noise level under 60dBA at max. speed
- Distinct control panel

Without rotor. Please order separately.

2



Specifications

Max. RCF:	38007 x g
Max. speed:	20000 rpm
Max. capacity:	4 x 100 ml
Cooling temperature:	-20 to +40 °C in 1 °C increments
Timer:	59 min 50 sec/10 sec increments 99 h 59 min/1 min increments
Power consumption:	1200W
Dimensions (W x D x H):	400 x 700 x 360 mm
Weight:	71 kg
Power supply:	230 V, 50/60 Hz

Description	PK	Cat. No.
Refrigerated High Speed Centrifuge Z 32 HK	1	6.240 037

1

6.241 114

Universal centrifuges Z 326/Z 326 K

Universal laboratory centrifuge for large volumes (4 x 145 ml) to reaction vessels.

Hermle

- Maintenance-free induction drive
- Motor driven lid lock
- Automatic rotor identification system with over speed protection, immediately upon rotor insertion
- Active imbalance-identification and cut off (rotor specific)
- CFC free refrigeration system (Z 326 K)
- A large variety of rotors and accessories
- Manufactured according to international safety regulations, i.e. IEC 61010
- Audible signal at the end of each run
- Noise level under 60 dBA at max. speed
- Optimized airflow system keeps the samples cool (Z 326)

Without rotor. Please order separately.
2

4.665 884

3

4.665 845

Specifications

Max. RCF:
Max. speed:
Max. capacity:
Cooling temperature Z 326 K:
Timer:

Z 326 // Z 326 K

23542 x g
18000 rpm
4 x 145 ml
-20 to +40 °C in 1 °C increments
59 min 50 sec/10 sec increments
99 h 59 min/1 min increments
455 // 660 W
400 x 480 x 360 // 400 x 700 x 360 mm
43 // 60 kg
230 V, 50/60 Hz

Power consumption:

Dimensions (W x D x H):

Weight:

Power supply:

4

4.665 880

Description	PK	Cat. No.
Universal centrifuges Z 326	1	6.241 114 1
Universal centrifuges Z 326 K	1	6.238 613
Swing out Rotor, 4 place	1	4.665 884 2
Swing out Rotor, 4 place	1	4.665 845 3
Angle rotor for max. 12 x 15 ml	1	9.945 950
Angle rotor for max. 6 x 50 ml	1	9.945 951
Angle rotor for max. 6 x 85 ml	1	4.665 880 4

5

5 Universal Centrifuge Z 306

The small, universal laboratory centrifuge offers a wide range of applications, which covers clinical laboratory requirements, research, as well as industrial laboratory use. The Z 306 offers many accessories, including rotors for microtitreplates and high speed fixed angle rotors for reaction vessels or centrifuge tubes up to 50 ml. Additionally, swing out rotors, which hold a volume of 4 x 100 ml can be used with special adapters for tissue culture tubes and also for all common blood tubes.

Hermle

- Maintenance-free induction drive
- Microprocessor with large LCD display
- Lid lock
- Automatic rotor identification system with over speed protection, immediately upon rotor insertion
- Active imbalance-identification and -cut off (rotor specific)
- Imbalance tolerant drive
- Manufactured according to international safety regulations, i.e. IEC 61010
- Audible signal at the end of each run
- Rotor exchange is easy to handle
- Noise level under 63 dBA at max. speed
- Improved ventilation system keeps samples cool
- Stainless steel chamber

Without rotor. Please order separately.
Specifications

Max. RCF: 18.624 x g
Max. speed: 14.000 rpm
Max. capacity: 4 x 100 ml
Timer: 59 min 50 s/10 s increments
99 h 59 min 50 s/1 min increments
Dimensions (W x D x H): 355 x 474 x 330 mm
Weight: 30 kg
Power supply: 230 V, 50/60 Hz

Type	PK	Cat. No.
Universal Centrifuge Z 306	1	6.255 833

Universal centrifuge Z 366/Z 366 K

These universal table top centrifuges Z 366 and Z 366 K putting new scales regarding the versatility, running features, easy handling and design. Both, the tube capacity of 40 x 15 ml conical tubes and centrifugal forces up to 24325 xg, turning these table top centrifuges Z 366 and Z 366 K into universal high-powered centrifuges.

- Maintenance-free induction drive
- Microprocessor with large LCD Display
- Motor driven lid lock
- Automatic rotor identification system with over speed protection, immediately upon rotor insertion
- Active imbalance-identification and cut off
- CFC-free refrigeration system
- A large variety of rotors and accessories
- Manufactured according to international safety regulations, i.e. IEC 61010
- Audible signal at the end of each run with several melody options
- Rotor exchange is easy to handle
- Noise level < 63 dBA (depends on rotor)
- Optimized airflow system keeps the samples cool

Without rotor. Please order separately.

Specifications

Max. RCF Z 366/Z 366 K:	21379/24325 x g
Max. speed Z 366/Z 366 K:	15000/16000 rpm
Max. capacity:	6 x 250 ml
Cooling temperature Z 366 K:	-20 °C to 40 °C
Timer:	59 min 50 sec/10 sec increments 99 h 59 min/1 min increments
Power consumption Z 366/Z 366 K:	530 W/800 W
Dimensions (W x D x H) Z 366/Z 366 K:	430 x 510 x 360 mm/720 x 510 x 360 mm
Weight Z 366/Z 366 K:	52 kg/77 kg
Power supply:	230 V, 50/60 Hz

Type	PK	Cat. No.
Universal Centrifuge Z 366	1	7.626 860 1
Universal Centrifuge Z 366 K	1	6.268 605 2

Hermle

1



7.626 860

2



6.268 605

Universal centrifuge Z 446/Z 446 K

Cooled and uncooled table centrifuge for a variety of different vessels due to a wide range of various rotors.

- Maintenance-free induction drive
- Microprocessor with large LCD display
- Motor driven lid lock
- Automatic rotor identification system with over speed protection, immediately upon rotor insertion
- Active imbalance identification and cut off (rotor-specific)
- CFC-free refrigeration system
- A large variety of rotors and accessories
- Audible signal at the end of each run
- Permanent display of target and actual value
- 10 acceleration and 10 braking profiles
- Memory for 99 complete runs, incl. rotor type
- Noise level < 65 dBA (depend on rotor)
- Manufactured according to international safety regulations, i. e. IEC 61010
- Stainless steel chamber

Without rotor. Please order separately.

Specifications

Max. RCF Z 446/Z 446 K:	24325 xg/26328 xg
Max. speed	200 to 16000 min ⁻¹
Max. capacity:	4 x 750 ml
Cooling temperature Z 446 K:	-20 to +40 °C
Timer:	59 min 50 sec/10 sec increments 99 h 59 min/1 min increments
Power consumption Z 446/Z 446 K:	640 W/1630 W
Dimensions (W x D x H) Z 446/Z 446 K:	540 x 670 x 390 mm/730 x 670 x 390 mm
Weight Z 446/Z 446 K:	79 kg/111 kg
Power supply:	230 V, 50/60 Hz

Type	PK	Cat. No.
Universal centrifuge Z 446	1	6.282 843
Universal centrifuge Z 446 K	1	6.268 644 3

Hermle

3



6.268 644

1

4.670 663

Floor-standing centrifuges ZK 496

NEW

Hermle

Refrigerated centrifuges for processing large volumes of up to 4 x 1.000 ml as well as blood bags with a large variety of rotors. Available as Floor-standing or Underbench device. Both devices are equipped with castors for easy handling.

- Maintenance-free induction drive
- Microprocessor with large LCD display
- Motor driven lid lock
- Automatic rotor identification system with over speed protection
- Active imbalance identification and cut off (rotor-specific)
- CFC-free refrigeration system
- A large variety of rotors and accessories
- Audible signal at the end of each run, adjustable melody and volume
- With timer function for starting the centrifuge at a pre-set time
- Manufactured according to international safety regulations, i. e. IEC 61010
- Stainless steel chamber

Please order rotors separately.

Specifications

Max. RCF:	16022 xg
Max. speed:	10500 rpm
Max. capacity:	4 x 1000 ml
Cooling temperature:	-20 ... 40 °C
Timer:	59 min 50 s/10 s increments 99 h 59 min/1 min increments
Power consumption:	2300 W
Power supply:	230 V, 50/60 Hz

Type	Description	Dimensions (W x D x H) mm	Net weight kg	PK	Cat. No.
ZK 496	Underbench device	620 x 690 x 700	157	1	4.670 663 1
ZK 496	Floor-standing device	620 x 690 x 980	190	1	4.667 888

2

9.945 939

Accessories for Hermle Centrifuges

Hermle

Type	For	PK	Cat. No.
Angle rotor for 6 x 250 ml	Z 366 / Z 366 K / Z 446 / Z 446 K / ZK 496	1	9.945 942
Angle rotor for max. 30 x 15 ml (round bottom) or 20 x 15 ml (conical)	Z 306 / Z 326 / Z 326 K / Z 366 Z / Z 366 K / Z 32 HK / 36 HK	1	9.945 940
Angle rotor for max. 4 x 85 ml	Z 326 / Z 326 K / Z 366 / Z 366 K / Z 446 / Z 446 K / Z 32 HK / 36 HK	1	9.945 941
Angle rotor for max. 6 x 50 ml	Z 326 / Z 326 K / Z 366 / Z 366 K / Z 446 / Z 446 K / Z 32 HK / 36 HK	1	4.666 077
Angle rotor for max. 24 x 1.5/2.0 ml	Z 306 / Z 326 / Z 326 K / Z 366 / Z 366 K / Z 446 / Z 446 K / Z 32 HK	1	4.665 843
Angle rotor for 4 x 8 PCR Stripes	Z 326 / Z 326 K / Z 446 / Z 446 K / Z 32 HK	1	9.945 948
Angle rotor for max. 24 x 1.5/2.0 ml, aerosol tight	Z 306 / Z 326 / Z 326 K / Z 366 / Z 366 K / Z 446 / Z 446 K / Z 32 HK	1	4.665 882
Angle rotor for max. 44 x 1.5/2.0 ml	Z 326 / Z 326 K / Z 366 / Z 366 K / Z 446 / Z 446 K / Z 32 HK	1	9.945 954
Angle rotor for max. 10 x 50 ml (conical)	Z 326 / Z 326 K / Z 366 / Z 366 K / Z 446 / Z 446 K / Z 32 HK / 36 HK / ZK 496	1	4.666 083
Angle rotor for max. 6 x 85 ml	Z 326 / Z 326 K / Z 366 / Z 366 K / Z 446 / Z 446 K / Z 32 HK / 36 HK	1	9.945 939 2
Angle rotor for max. 20 x 10 ml	Z 326 / Z 326 K / Z 366 / Z 366 K / Z 446 / Z 446 K / Z 32 HK / 36 HK	1	9.945 944
Angle rotor for 30 x 1,5 ml / 2,0 ml	Z 306 / Z 326 / Z 326 K / Z 446 / Z 446 K / Z 32 HK / 36 HK	1	9.945 938
Angle rotor for 12 x 1,5 ml / 2,0 ml	Z 326 / Z 326 K / 36 HK	1	9.945 943
Angle rotor for 12 x 5 ml, with lid	Z 306 / Z 326 / Z 326 K	1	9.945 945
Angle rotor for 4 x 500 ml	Z 446 / Z 446 K / ZK 496	1	9.945 949
Swing out rotor for max. 4 x 250 ml	Z 366 / Z 366 K / 36 HK	1	4.665 885
Swing out rotor for 16 x 50 ml (conical) or 40 x 15 ml (conical)	Z 366 / Z 366 K	1	9.945 952
Swing out rotor for 2 x 3 MTP	Z 306	1	4.665 879
Swing out rotor for 4 x 250 ml	Z 446 / Z 446 K	1	4.665 881
Swing out rotor for max. 4 x 500 ml	Z 446 / Z 446 K	1	4.665 883
Angle rotor for 4 x 750 ml, hermetically tight	Z 446 / Z 446 K / ZK 496	1	9.945 946
Angle rotor for 4 x 1000 ml, hermetically tight	ZK 496	1	9.945 953
Angle rotor for 4 x 100 ml for oil test tubes	OLEUM	1	9.945 947
Rotor 2 x 3 Microplates	Z 306 / Z 326 / Z 326 K / Z 366 / Z 366 K / Z 446 / Z 446 K / Z 32 HK / 36 HK	1	9.945 937

1 Microcentrifuge 5418 R (General Lab Product), cooled

Microcentrifuge for standard molecular biology applications. The compact centrifuge with low access height is characterized by extremely quiet operation.

Eppendorf AG

- 18 place rotor for 1.5/2.0 ml tubes and Microtainer®
- Lid opens automatically after spinning
- Very small profile, minimal bench space required
- Remarkably silent, even without rotor lid
- Standard, certified aerosol-tight rotor
- Convenient Eppendorf two-dial operation
- Rpm/rcf converter
- Short-spin
- The patented compressor technology reduces vibration to a minimum
- Low access height of 26 cm
- Keeps a constant 4 °C at max. speed
- Fast Temp for rapid pre-cooling of the centrifuge

This centrifuge is a General Lab Product for research purposes.

Specifications

Max. RCF:	16.873 x g
Max. speed:	14 000 rpm
Max. capacity:	18 x 1.5/2.0 ml
Temperature:	0 ... +40 °C
Timer:	30 s to 9:59 h, continuous run
Power consumption:	320 W
Dimensions (W x D x H):	300 x 460 x 250 mm
Weight:	22 kg
Power supply:	230 V, 50/60 Hz

1



Type	Description	Plug type	PK	Cat. No.
5418 R	incl. Rotor FA-45-18-11	EU	1	4.660 587
5418 R	incl. Rotor FA-45-18-11	UK	1	4.660 588

Online also available as IVD version.



1

1 Microcentrifuge 5424 R (General Lab Product), cooled

Suitable for all modern molecular biology applications using Eppendorf and PCR tubes. The microcentrifuge with efficient cooling performance offers high temperature accuracy for maximum sample protection and optimal separation results.

Eppendorf AG

- 24-place-centrifuge for 1.5/2.0 ml tubes
- Lid opens automatically after spinning
- Aerosol tight rotors
- 4 different rotors (available as accessories)
- Very quiet in operation, even without rotor lid
- Choice of analogue dial or membrane keypad control
- Adjustable soft ramp acceleration
- The patented compressor technology reduces vibration to a minimum
- Small footprint and low access height of 26 cm
- Keeps a constant 4 °C at max. speed
- Fast Temp for rapid pre-cooling of the centrifuge, for example, from about 21 °C to 4 °C in 8 mins.

This centrifuges are General Lab Products for research purposes.

Specifications	5424 R
Max. RCF:	21.130 x g
Max. speed:	15000 rpm
Max. capacity:	24 x 1.5/2 ml
Cooling temperature:	-10 ... +40 °C
Timer:	30 s to 9:59 h, continuous run
Power consumption:	350 W
Dimensions (W x D x H):	290 x 480 x 260 mm
Weight:	21 kg
Power supply:	230 V, 50/60 Hz

Type	Description	Plug type	PK	Cat. No.
5424 R	Without rotor, with control knobs	EU	1	4.660 595
5424 R	Without rotor, with foil keypad	EU	1	4.660 591
5424 R	With rotor FA 45-24-11, with control knobs	EU	1	4.660 593
5424 R	With rotor FA 45-24-11, with foil keypad	EU	1	4.660 589
5424 R	Without rotor, with control knobs	UK	1	4.660 596
5424 R	Without rotor, with foil keypad	UK	1	4.660 592
5424 R	With rotor FA 45-24-11, with control knobs	UK	1	4.660 594
5424 R	With rotor FA 45-24-11, with foil keypad	UK	1	4.660 590

Other rotors available on request.

Online also available as IVD version.

2

4.661 164

2 Microcentrifuge 5425 (General Lab Product)

Non-refrigerated microcentrifuge for common standard applications with a high sample throughput, providing ergonomic comfort and great flexibility with its 6 rotor options.

Eppendorf AG

- Fast acceleration and deceleration (10 acceleration and braking ramps)
- Lower noise level (< 51 dB)
- Small footprint
- Low loading height for comfortable inserting rotor and samples
- Soft touch one-finger closure for ergonomic operation
- Automatic lid opening after running
- Rotor chamber made of stainless steel

This centrifuges are General Lab Products for research purposes.

Specifications	
Max. RCF:	21.330 x g
Max. speed:	100 ... 2.000 rpm (10-rpm-steps) 2.000 ... 5.000 rpm (50-rpm-steps) 5.000 ... 15.060 rpm (100-rpm-steps)
Max. capacity:	10 x 5.0 ml
Timer:	10 s ... 9:59 h, continuous run
Power consumption:	280 W
Dimensions (W x D x H):	240 x 390 x 240 mm
Weight:	15.6 kg
Power supply:	230 V, 50/60 Hz

Type	Description	PK	Cat. No.
5425	with foil keypad, without rotor	1	4.661 164 2
5425	with foil keypad, with aerosoltight rotor FA-24x2	1	4.661 162
5425	with control knobs, without rotor	1	4.661 168
5425	with control knobs, with aerosoltight rotor FA-24x2	1	4.661 166 3

Other rotors available on request.

Online also available as IVD version.

3

4.661 166

1 Centrifuges 5702/5702 R/5702 RH (General Lab Product)

These low-speed, universally applicable centrifuges are especially suited for low to medium sample throughput in cell culture applications.

Eppendorf AG

- Compact with small footprint
- Maintenance-free motor
- Dial controls and digital display
- Powered lid locking
- Short braking time
- Automatic lid opening (model 5702 only)
- Rotor bowl made of stainless steel
- Optimized: backwards adjusted air flow for sample cooling

Additional features 5702 R:

- Two programme keys for saving the parameters of two standard centrifugation processes
- Adjustable acceleration rate and braking
- Temperature setting from -9 °C to 40 °C
- Stand-by cooling
- Fast-temp-function

Additional features 5702 RH:

- Software control for precise temperature control (depends on rotor)
- Active heating
- Stand-by heating
- Temperature derivation in stationary state at 4 °C and at 37 °C ±1 °C

This centrifuges are General Lab Products for research purposes.

Specifications

	5702/5702 R/5702 RH
Max. RCF:	3000 x g
Max. Speed:	100 to 4400 rpm (100 rpm steps)
Max. Load:	4 x 100 ml
Power consumption:	200 W // 380 W // 380 W
Temperature setting range:	- // -9 ... +40 °C // -9 ... +42 °C
Dimensions (W x D x H):	320 x 400 x 240 mm // 380 x 580 x 260 mm // 380 x 580 x 260 mm
Height (with opened lid):	530 mm // 600 mm // 600 mm
Weight:	20 kg // 36 kg // 36 kg
Power supply:	230 V, 50/60 Hz

Type	Description	PK	Cat. No.
5702	With rotor A-4-38, with adapter for conical tubes, 15/50 ml, with EU-plug	1	4.660 623
5702 R	With rotor A-4-38, with adapter for conical tubes, 15/50 ml, with EU-plug	1	4.660 629
5702 R	With rotor A-4-38, with adapter for blood collection tubes, 13/16-mm, with EU-plug	1	4.660 627
5702 RH	Without rotor, cooled/heated, with EU-plug	1	4.660 631
5702	Without rotor, with UK-plug	1	4.660 622
5702 R	Without rotor, with UK-plug	1	4.660 626

Online also available as IVD version.

1



Benchtop centrifuges, 5804/5804 R/5810/5810 R (General Lab Product)

These centrifuges offer a flexible rotor program with a modular adapter system which can accommodate a high variety of tube lengths.

Eppendorf AG

- Ergonomic access height gives comfortable rotor loading
- Low noise level
- Motorized lid lock
- Reliable cooling at maximum speed*
- Imbalance detector
- Automatic rotor recognition logs rotor performance parameters and prevents these being exceeded
- Optional user setting by speed, rcf or radius correction values
- Values can be changed during centrifugation
- Temperature setting from -9 °C to +40 °C*
- Standby cooling*
- Selectable programme memory for up to 34 individual user programmes
- Short-spin function, speed can be preselected
- Fast-cool function* for rapid cooling of the centrifuge chamber
- 10 gentle acceleration and braking profiles for sensitive sample material

This centrifuges are General Lab Products for research purposes.

* Cooled models 5804 R and 5810 R only

1



1 Benchtop centrifuges 5804/5804 R (General Lab Product)

Eppendorf AG

Specifications	5804 // 5804 R
Max. RCF:	20913 x g
Max. speed:	14000 rpm
Max. Load:	10 x MTP or 2 x DWP
Power consumption:	900 W // 1650 W
Dimensions (W x D x H):	470 x 550 x 340 mm // 640 x 550 x 340 mm
Weight:	55 kg // 80 kg
Power supply:	230 V, 50/60 Hz

Type	Description	Plug type	PK	Cat. No.
5804	Without rotor	EU	1	4.660 633
5804 R	Without rotor	EU	1	4.660 639
5804 R	With rotor A-4-44, with adapter for conical tubes 15 / 50 ml	EU	1	4.660 641
5804 R	With rotor S-4-72, with adapter for conical tubes 15 / 50 ml	EU	1	4.660 643
5804	Without rotor	UK	1	4.660 634
5804 R	Without rotor	UK	1	4.660 640

Online also available as IVD version.

2



2 Benchtop centrifuges 5810/5810 R (General Lab Product)

Eppendorf AG

Specifications	5810 // 5810 R
Max. RCF:	20913 x g
Max. speed:	14000 rpm
Max. Load:	16 x MTP or 4 x DWP
Power consumption:	900 W // 1650 W
Dimensions (W x D x H):	540 x 610 x 350 mm // 700 x 610 x 350 mm
Weight:	68 kg // 99 kg
Power supply:	230 V, 50/60 Hz

Type	Description	Plug type	PK	Cat. No.
5810	Without rotor	EU	1	4.660 645
5810	With rotor A-4-81, with adapter for conical tubes 15 / 50 ml	EU	1	4.660 649
5810 R	With rotor A-4-62, with adapter for conical tubes 15 / 50 ml	EU	1	4.660 657
5810 R	With rotor A-4-81, with adapter for conical tubes 15 / 50 ml	EU	1	4.660 659
5810 R	With rotor S-4-104, with adapter for conical tubes 15 / 50 ml	EU	1	4.660 661
5810	Without rotor	UK	1	4.660 646
5810 R	Without rotor	UK	1	4.660 656

Online also available as IVD version.

1 Roll containers, for centrifuges 5804/5804 R and 5810/5810 R

The roll container provides the flexibility to use the centrifuge where it is needed.

Eppendorf AG

- One drawer
- Place for rotors and accessories
- Four castors, two are lockable



Type	Dimensions (W x D x H) mm	PK	Cat. No.
Roll containers	700 x 620 x 450	1	4.656 042

2 Microcentrifuge 5430/5430 R (General Lab Product)

These centrifuges are used with e.g. rotors for Eppendorf Tubes® and PCR strips, rotors for microplates and 15/50 ml conical tubes, as well as a 48-place rotor, a 16-place rotor for Eppendorf Tubes® 5.0 ml and a swing-out rotor (24 x 1.5/2.0 ml).

Eppendorf AG

Microcentrifuge 5430

- 48 place centrifuge for 1.5ml/2.0ml micro test tubes, 6 x 50 ml Falcon® tubes or 2 x MTP plates
- Automatic rotor identification
- 12 different rotors (available as accessories)
- Stores up to 50 routine programs
- Menu guided operation in 4 different languages
- LCD display with backlighting
- Automatic lid opening following application sequence (only 5430)

Microcentrifuge 5430 R, additional features:

- Temp. range: -11 °C to +40 °C
- +4 °C at max. speed with all rotors
- Continues cooling after the centrifugation process
- Fast Temp for achieving required temperature in shortest possible time
- Fast Temp pro for having the centrifuge refrigerated and ready-for-use at your desired pre-set time

This centrifuges are General Lab Products for research purposes.



Specifications

5430 // 5430 R

Max. RCF:	30.130 x g
Max. speed:	17.500 rpm
Max. capacity:	48 x 1.5/2.0 ml or 6 x 50 ml or 2 x MTP
Cooling temperature:	- // -11 ... +40 °C
Timer:	30 s to 99:59 h, with continuous run
Power consumption:	475 W // 1050 W
Dimensions (W x D x H):	330 x 420 x 250 mm // 380 x 640 x 290 mm
Weight:	29 kg // 56 kg
Power supply:	230 V, 50/60 Hz

Type	Description	Plug type	PK	Cat. No.
5430	Without rotor, with dial setting	EU	1	4.660 611
5430 R	Without rotor, with membrane keypad	EU	1	4.660 615
5430 R	With rotor FA-45-30-11, with dial setting	EU	1	4.660 617
5430	Without rotor	UK	1	4.660 606
5430	With rotor FA-45-30-11, with dial setting	UK	1	4.660 610
5430 R	Without rotor, with dial setting	UK	1	4.660 620

Online also available as IVD version.

Benchtop centrifuges 5910 R/5920 R (General Lab Product)

These centrifuges combine a high capacity and versatility. Its main swing-bucket rotor holds both conical tubes and plates, no need to change rotor buckets or adapters. The 5910 R centrifuge has a low access height for easy operation. The 5910 R centrifuge holds standard 1 liter Nalgene® bottles.

Eppendorf AG

- Plate rotor options for centrifugation of all types of MTP, PCR or Deepwell Plates
- Fixed-angle rotors for high-speed molecular biology applications in tubes from 0.2 to 50 ml
- Aerosol-tight Eppendorf QuickLock® caps and lids allow fast and ergonomic lid locking
- Quiet operation (<59 db)
- Compact footprint
- Automatic rotor recognition and imbalance detection
- FastTemp function for quick pre-cooling and FastTemp pro® function for automatic precooling based on pre-programmable time and date
- Standby cooling function holds temperature when centrifuge is not in use
- ECO shut-off engages after 8 hours (adjustable)

This centrifuges are General Lab Products for research purposes.

1



1 Benchtop centrifuges 5910 R (General Lab Product)

Eppendorf AG

Specifications

Max. RCF:	22.132 x g
Speed:	100 ... 14.000 rpm (in 10 rpm increments)
Max. Load:	4 x 750 ml/4 x 5 MTP
Noise level:	<59 db
Number of programs:	99 (5 keys)
Timer:	10 s to 99 h 59 min, continuous, Short-Spin
Power consumption:	1650 W
Temperature setting range:	-11 ... +40 °C
Dimensions (W x D x H):	720 x 660 x 370 mm
Height (with opened lid):	850 mm
Net weight:	109 kg
Power supply:	230 V, 50/60 Hz

Type	Description	PK	Cat. No.
5910 R	without rotor	1	4.660 683
5910 R	with rotor S-4x500, with square buckets and adapters for conical tubes, 15/50 ml	1	6.273 434

Online also available as IVD version.

2



2 Benchtop centrifuges 5920 R (General Lab Product)

Eppendorf AG

Specifications

Max. RCF:	21.194 x g
Speed:	100 ... 13.700 rpm (in 10 rpm increments)
Max. Load:	4 x 1000 ml/4 x 7 MTP
Noise level:	<60 db
Number of programs:	99 (5 keys)
Timer:	10 s to 99 h 59 min, continuous, Short-Spin
Power consumption:	1650 W
Temperature setting range:	-11 ... +40 °C
Dimensions (W x D x H):	740 x 710 x 400 mm
Height (with opened lid):	940 mm
Net weight:	139 kg
Power supply:	230 V, 50/60 Hz

Type	Description	Plug type	PK	Cat. No.
5920 R	Without rotor	EU	1	4.660 665
5920 R	With rotor S-4xUniversal-Large, with universal buckets and adapters for conical tubes, 15/50 ml	EU	1	4.660 680
5920 R	With rotor S-4xUniversal-Large, with universal buckets and adapters for round bottom tubes, 13/16 mm	EU	1	4.660 678
5920 R	Without rotor	UK	1	4.660 666
5920 R	With rotor S-4x1000, with High Capacity buckets and adapters for conical tubes, 15/50 ml	UK	1	4.660 668
5920 R	With rotor S-4x1000, with Plate/Tube buckets and adapters for conical tubes, 15/50 ml	UK	1	4.660 672

Online also available as IVD version.

1 General purpose centrifuge Megafuge ST4 plus



1

Universal centrifuge for routine applications. Motorised lid latch enables one finger downward motion for easiest closing and locking of centrifuge lid.

Thermo Scientific



- Intuitive touchscreen
- Auto-Lock™ Rotor exchange: Secure, ergonomic push-button rotor exchange in as little as 3 seconds
- ClickSeal™ Bucket Sealing System: System has glove-friendly, one-handed open/close capability
- SMARTSpin™ Technology: optimises the acceleration and braking process and compensates imbalances
- Front USB port

Specifications

Max. RCF: 5590 x g (swing-out rotor)
25830 x g (fixed-angle rotor)

Max. speed: 5300 rpm (swing-out rotor)
15200 rpm (fixed-angle rotor)

Warranty: 5 years

Type	Weight kg	Dimensions (W x D x H) mm	Supply requirements	PK	Cat. No.
ST4 Plus	89	566 x 690 x 362	208 ... 240 V, 50/60 Hz	1	4.672 605
ST4R Plus	120	746 x 690 x 361	220 ... 240 V, 50 Hz / 230 V, 60 Hz	1	4.672 606

2 General purpose centrifuge Multifuge X4 Pro



2

General purpose centrifuge for routine applications. Motorised lid latch enables one finger downward motion for easiest closing and locking of centrifuge lid.

Thermo Scientific



- Intuitive full color touch screen
- Up to 100 program storage
- Display of set and actual parameters
- Easily adjust speed, time and temperature, even during the run
- Auto-Lock™ III rotor system: Secure, ergonomic push-button rotor exchange
- ClickSeal™ Bucket Sealing System: System has glove-friendly, one-handed open/close capability
- SMARTSpin™ Technology: optimises the acceleration and braking process and compensates imbalances

Specifications

Max. RCF: 7164 x g (swing-out rotor)
25830 x g (fixed-angle rotor)

Max. speed: 6000 rpm (swing-out rotor)
15200 rpm (fixed-angle rotor)

Warranty: 5 years

Type	Weight kg	Dimensions (W x D x H) mm	Supply requirements	PK	Cat. No.
X4 pro	89	566 x 690 x 362	208 ... 240 V, 50/60 Hz	1	4.672 607
X4R pro	120	746 x 690 x 361	220 ... 240 V, 50/60 Hz	1	4.672 608



6. Distillation, separation, filtration

Separating, centrifuging/Centrifuge tubes



1 Centrifuge tubes, round bottom, DURAN®

To DIN 58970 part 2. Glass Type I/neutral glass as per USP, EP and JP. Autoclavable. Maximum loading: 4000 xg rcf.

DWK Life Sciences

Capacity ml	Diam. mm	Height mm	PK	Cat. No.
6	12	100	1	9.315 010
12	16	100	1	9.315 011
25	24	100	1	9.315 014
50	34	100	1	9.315 017
80*	40	115	1	9.315 024
80	44	100	1	9.315 026
250*	56	147	1	9.315 036

* Not to DIN.



2 Centrifuge tubes, conical, DURAN®

Autoclavable. Rimless, with conical base. Maximum loading: 4000 xg rcf.

DWK Life Sciences

Volume ml	Diam. mm	Height mm	Angle	PK	Cat. No.
12	16	100	30	1	9.315 509
25	24	100	60	1	9.315 514
50	34	100	60	1	9.315 517



7.920 120

6.803 325

High speed centrifuge tube, borosilicate glass

Borosilicate glass. The tubes have been chemically strengthened to achieve a greater mechanical strength than standard borosilicate centrifuge tubes. These tubes can be centrifuged up to 13.100 RCF when used with an accessory rubber adapter sleeve in a 50 ml rotor cavity. They can withstand temperatures up to 300 °C. Autoclavable.

Description	Volume ml	Diam. mm	Height mm	PK	Cat. No.
without rim	15	18	102	6	6.803 323
without rim	30	24	106	6	6.093 022
screw thread	15	18	102	6	7.920 120 3
screw thread	30	24	106	6	6.234 247
Rubber adapter, 15 ml				2	6.803 324
Rubber adapter, 30 ml				2	6.803 325 4



5 Centrifuge tubes, glass, round bottom, graduated, DURAN®, Borosilicate glass 3.3

In white enamel, rimless. Maximum loading: 3500 xg rcf.

Volume ml	Diam. mm	Height mm	PK	Cat. No.
10 - 15	17	98	1	9.315 237
10 - 15	17	107	1	9.315 240
25	25	100	1	9.315 245



6 Centrifuge tubes, round bottom, AR glass®

Round bottom. Graduated or ungraduated. Maximum loading: 3500 xg rcf.

Volume ml	Diam. mm	Height mm	Graduations	PK	Cat. No.
10 - 15	17	98	no	1	9.315 201
10 - 15	17	107	no	1	9.315 203
10 - 15	17	98	yes	1	9.315 217
10 - 15	17	107	yes	1	9.315 220
25	25	100	yes	1	9.315 225
50 - 55	35	98	no	1	9.315 207
70 - 100	40	115	no	1	9.315 210

6. Distillation, separation, filtration Separating, centrifuging/Centrifuge tubes

1 Centrifuge tubes, AR-GLAS® or borosilicate glass 3.3., graduated

Graduations and inscriptions in high contrast white enamel.

BRAND

- Height: 113 mm
- Subdivision: 0.1 ml
- Wall thickness: 1 mm
- Outer diameter: 17 mm
- Maximum loading: 3500 x g rcf.
- Conical bottom

Nominal capacity ml	Material	Graduations ml	PK	Cat. No.
15	AR-GLAS®	0 - 10	1	9.315 415
15	Borosilicate glass 3.3.	0 - 10	1	9.315 417
15	AR-GLAS®	0 - 15	1	9.315 416
15	Borosilicate glass 3.3.	0 - 15	1	9.315 418

1



Centrifuge tubes, AR-GLAS®, ungraduated, rimless

- Wall thickness: 1 mm
- Maximum loading: 3500 x g rcf.

BRAND

Nominal capacity ml	Ext. diam. mm	Height mm	Base	PK	Cat. No.
11	16.5	98	cone-pointed	100	9.315 423
13	16.5	98	round	100	9.315 421 2

2



9.315 421

Centrifuge tubes, AR-GLAS® or borosilicate glass 3.3., ungraduated, with beaded rim

- Wall thickness approx.: 1 mm
- Maximum loading: 3500 x g rcf.
- Conical bottom

BRAND

Nominal capacity ml	Ext. diam. mm	Height mm	Material	PK	Cat. No.
15	17	113	AR-GLAS®	100	9.315 412 3
15	17	113	Boro 3.3.	100	9.315 413

3



9.315 412

4 ASTM centrifuge tube, cylindrical, with conical base, borosilicate glass 3.3

Cylindrical, with conical base. Graduations and labelling in high-contrast blue enamel. Maximum loading 700 xg rcf. Internal diam. neck approx. 17 mm.

Graduated, ml:	In subdivisions, ml:
0 to 0.5	0.05
0.5 to 2	0.10
2 to 3	0.20
3 to 5	0.50
5 to 10	1.00
10 to 25	5.00
25 to 100	25.0

Description	Capacity ml	Length mm	PK	Cat. No.
acc. to ASTM D 91	100	203	1	9.315 810
former standard ASTM D 96	100	167	1	9.315 820

4



1

1

ASTM centrifuge tube, pear-shaped with cylindrical base, borosilicate glass 3.3

Pear-shaped with cylindrical base. Former standard ASTM D 96. Capacity 100ml. Graduations and labelling in high-contrast blue enamel. Maximum loading 700 xg rcf. Internal diam. neck approx. 17 mm.

Graduated, ml:	In subdivisions, ml:
0 to 1.5	0.10
1.5 to 3	0.50
3 to 5	0.50
5 to 10	1.00
10 to 25	5.00
25 to 100	25.0

Capacity ml	PK	Cat. No.
100	1	9.315 815

2

6.256 488

ASTM Centrifuge Tubes for Oils, with conical base, borosilicate glass 3.3

Conical bottom centrifuge tube is used for testing of petroleum products. Scale and legend are durable white ceramic enamel except California type. Top is tooled to accept snap cap. Conforming to USP Type I and ASTM E438, Type I, Class A requirements.

DWK Life Sciences

Type	Capacity ml	Diam. mm	Length mm	Volume ml	Grad. ml	PK	Cat. No.
6" short cone, Oil	100	45	165	0-0,5 / 0,5-2 / 2-3 / 3-5 / 5-10 / 10-25 / 50 / 100	0,05 / 0,1 / 0,2 / 0,5 / 1 / 5 / - / -	1	6.256 488 2
8" Oil and weathering (end point index), ASTM D2158	100	37	203	0-1 / 1-3 / 3-6 / 6-10 / 10-100	0,05 / 0,1 / 0,2 / 0,5 / 1	12	6.289 839
8" Oil, ASTM D1796, MPMS 10.4, D91, D128, D1093	100	37	203	0-0,5 / 0,5-2 / 2-3 / 3-5 / 5-10 / 10-25 / 25-100	0,05 / 0,1 / 0,2 / 0,5 / 1 / 5 / 25	12	6.269 226
California*, ASTM D91, D893, D1796	100	38	200	0-0,5 / 0,5-2 / 2-3 / 3-5 / 5-10 / 10-25 / 50 / 75 / 100	0,05 / 0,1 / 0,2 / 0,5 / 1 / 5 / - / - / -	12	6.268 457

* with permanent red stripe under the white enamel graduations for easy reading of results.

3

3 LLG-Microcentrifuge tubes, PP



LLG Microtubes cover standard volumes for a variety of sample tests. They are available in 0.5 ml, 1.5 ml and 2.0 ml volumes. These standard Microtubes withstand high centrifugal forces, are temperature and chemically-resistant and guaranteed leak-free. An innovative and modern new generation of Microtubes with new features. Perfect sealing qualities, excellent chemical stability and optimal construction materials guarantee even better resistance to centrifugal and chemical forces. Easy to open and to close thanks to the improved lid geometry. For visual volume control the 1.5 ml tubes are equipped with graduations at 0.5 ml, 1.0 ml and 1.5 ml. The 2.0 ml tubes have graduations at 0.5 ml, 1.0 ml, 1.5 ml and 2.0 ml. The 0.5 ml tubes have no graduations. Certified DNase-, RNase- and pyrogen-free.

Clear, in bags. Suitable for microbiology. Guaranteed metal-free.

Specifications

Autoclavability

Temperature:	121 °C
Pressure:	1.05 bar or 15 psi
Time:	20 min or less

Centrifugation

Fixed angle rotor:	25000 x g
Swing out rotor:	70000 x g

Form	Volume ml	Max. rcf	PK	Cat. No.
conical	0.5	20000	1000	9.409 023
conical	1.5	25000	1000	9.409 024
round	2.0	25000	1000	9.409 025

6. Distillation, separation, filtration Separating, centrifuging/Centrifuge tubes

LLG-Centrifuge tubes, 5 ml, PP



The LLG-Centrifuge tubes, 5 ml, represent the perfect solution for all laboratory applications requiring incubation, centrifugation and sample handling in an intermediate volume range. Available in clear, and amber for use with light sensitive samples, and as an assorted colour pack (green, blue, yellow and red).

- Max. 25.000 x g, suitable for high speed centrifugation
- Graduations every 0.25 ml for easy volume estimation
- A flat, frosted cap and large writing pad for sample labeling and identification
- Autoclavable
- Fits all rotors and racks that hold 15 ml conical tubes, no adapters needed
- Certified free of RNase and DNase

Description	Package contents	PK	Cat. No.
Clear	1 bag of 250 pieces	250	6.281 113 1
Colour assortment green, yellow, red, blue	4 bags of 50 pieces (1 colour per bag)	200	6.281 114 2
Amber	1 bag of 250 pieces	250	6.281 115 3

1



6.281 113

2



6.281 114

3



6.281 115

4 LLG-Centrifuge Tubes economy, PP



- With flat PE caps
- With conical bottom (15 and 50 ml) or with self-standing bottom (50 ml)
- Easy-to-read black volume graduations
- With a large frosted writing area
- Engraved graduation at the conical bottom of each tube
- Max. rotate speed up to 12000 x g for conical bottom tubes and 6000 x g for self-standing tubes
- Autoclavable at 121 °C and freezable to -80 °C
- Leak-proof
- Free of heavy metals, pyrogens and endotoxins
- DNase/RNase-free
- Aseptically or sterile

Capacity ml	Description	Form	Height mm	Diam. mm	PK	Cat. No.
15	Sterile, in bag of 25 pieces	conical	119,6	17	500	4.668 482
50	Sterile, in bag of 25 pieces	conical	113,9	30	500	4.668 483
50	Sterile, in bag of 25 pieces	with rim	116,5	30	500	4.668 486
15	Aseptically, bulk pack	conical	119,6	17	500	6.270 403
50	Aseptically, bulk pack	conical	113,9	30	500	6.270 404
50	Aseptically, bulk pack	with rim	116,5	30	500	6.270 405

4



5 LLG-Centrifuge tubes, PP



Polypropylene tubes with very good thermal, mechanical and chemical stability. With screw closures. Sterile tubes with screwed-on closure. Packed in boxes or bags. With graduations and labelling area.

Centrifugation capacity (Max. RCF): 6000 x g
Height: 120 mm

Description	Form	Capacity ml	Diam. mm	PK	Cat. No.
sterile, single packed*	conical	15	17	50	9.316 062
aseptic, bulk pack	conical	15	17	50	6.263 886
big pack	conical	15	17	500	9.316 063
sterile, single packed*	conical	50	30	50	9.316 064
big pack	conical	50	30	500	9.316 065
aseptic, bulk pack	conical	50	30	50	6.263 887
sterile, single packed*	with rim	50	30	50	9.316 067
big pack, bulk pack	with rim	50	30	50	4.008 506
aseptic, bulk pack	with rim	50	30	50	6.263 888

*Cytotoxicity-free, DNase/RNase- and human DNA-free.

5

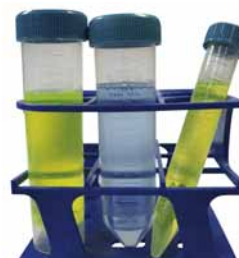

Eppendorf Tubes® 5.0 mL, PP



Eppendorf AG

- Simple, practical and ergonomic single-hand operation. Large labelling area.
- Lid design: Hinged lid for minimized sample evaporation during storage and incubation in a wide range of temperatures from -86 °C to 80 °C
- Certified purity: Available in lot-tested and certified Eppendorf Quality, PCR clean, Sterile and Eppendorf Biopur® purity levels
- Maximum safety and stability for centrifugation up to 25 000 x g.
- Compatible with accessories for conical 15 ml tubes - many existing adapters and racks can be used.
- Available in Eppendorf LoBind® material for maximum recovery of valuable samples

The Starter Pack comprises:

- 400 Eppendorf Tubes® 5.0 mL, PCR clean (Certified purity grade)
- 8 universal adapters for rotors with bores for 15 ml conical tubes
- 2 Tube Racks 5.0 mL (16 spaces; white)
- Free of human DNA, free of DNase and RNase, free of PCR inhibiting agents.
- For PCR preparations or any reactions where DNase or RNase could interfere with the reaction or analysis.

From 80°C on, please use the Tube Clip opener Cat. No. 9.409 294.

Description	Package contents	PK	Cat. No.
Eppendorf Tubes® 5.0 mL, Eppendorf Quality™	2 bags of 100	200	9.409 277 1
Eppendorf Tubes® 5.0 mL, PCR clean	2 bags of 100	200	9.409 278
Eppendorf Tubes® 5.0 mL, Sterile	10 bags of 20	200	9.409 279
Eppendorf Tubes® 5.0 mL, Biopur®	bag of 50, single packed	50	9.409 288
Eppendorf Protein LoBind Tube, PCR clean	2 bags of 50	100	9.409 289
Eppendorf Protein LoBind Tube, PCR clean	2 bags of 100	200	4.665 939
Eppendorf DNA LoBind Tube, PCR clean	4 bags of 50	200	9.409 290
Eppendorf DNA LoBind Tube, PCR clean	2 bags of 100	200	4.665 938
Eppendorf Tubes® 5.0 mL, Eppendorf Quality™, amber (light protection)	2 bags of 100	200	6.265 214 2
Eppendorf Tubes® 5.0 mL, amber (light protection), Sterile	2 bags of 100	200	4.665 937
Tube Clip, Eppendorf Quality™		10	9.409 294 3
5.0 mL Starter Pack, PCR clean	2 Packs with 2 bags of 100 each, 2 Racks (16 spaces each), 8 Universal adapters	1	9.409 291 4
Eppendorf Tubes® 5.0 mL, Forensic DNA Grade	4 bags of 50	200	6.287 838
Eppendorf Tubes® 5.0 mL, Forensic DNA Grade, single packed	4 bags of 50	200	6.287 839

1



9.409 277

2



6.265 214

3



9.409 294

4



9.409 291

5



5 Eppendorf Tubes® 5.0 ml, PP



Eppendorf AG

- Ergonomic operation: Simple, practical and ergonomic operation. Large labelling area.
- Lid design: Screw cap for minimized sample evaporation during storage and incubation in a wide range of temperatures from -86 °C to 100 °C
- Material: Exceptionally high-quality, transparent polypropylene, free of plasticizers, biocides or mold release agents, for reliable test results
- Certified purity: Available in lot-tested and certified Eppendorf Quality, PCR clean and sterile purity levels
- Centrifugation safety: Maximum safety and stability for centrifugation up to 25 000 x g and fast and efficient protocols.
- Conical shape: Compatible with accessories for conical 15 mL tubes - many existing adapters and racks can be used.

Description	Package contents	PK	Cat. No.
Eppendorf Tubes® 5.0 mL, Eppendorf Quality	2 bags of 100	200	6.282 530
Eppendorf Tubes® 5.0 mL, PCR clean	2 bags of 100	200	6.282 531
Eppendorf Tubes® 5.0 mL, pyrogen-, DNase-, RNase and DNA-free	2 bags of 100	200	6.282 532

6. Distillation, separation, filtration Separating, centrifuging/Centrifuge tubes

1 Eppendorf Tubes® 25 ml, PP

NEW

Eppendorf AG



Transparent. For cell culture applications, sample preparations, storage and transport of samples. The SnapTec™ cap version allows single-handed opening and closing for quick liquid extraction or addition. Also available with HDPE screw cap.

- Conical
- Single-Handed Operation
- Tightness from -86 °C to 100 °C
- Max. RZB 17000 x g
- Lower height than 15 ml/50 ml conical tubes
- The SnapTec tubes are autoclavable

Starter pack 1: 200 Eppendorf Conical Tubes® 25 ml with snap cap SnapTec™, PCR clean, 4 single tube stands, 6 adapters for rotors with bore for 50 ml conical tubes

Starter pack 2: 200 Eppendorf Conical Tubes® 25 ml with screw cap, PCR clean, 4 single tube stands, 6 adapters for rotors with bore for 50 ml conical tubes



Description	PK	Cat. No.
Starter pack 1	1	6.311 419
Starter pack 2	1	4.669 460

2 Centrifuge tubes, PP

Greiner Bio-One



Polypropylene tubes with very good thermal, mechanical and chemical stability. Fitted with screw-on closure. Packed in boxes or bags. With graduations and labelling area. Tubes are sterile, cytotoxicity-free, DNase/RNase- and human DNA-free.

Specifications:

Centrifugation capacity (15 - 50 ml): 3215 x g/4500 rpm in swing out rotors
8965 x g/9000 rpm in fixed angle rotors

Form	Capacity ml	Diam. mm	Height mm	PK	Cat. No.
conical	15	17	120	50	9.380 423
conical	15	17	120	500	7.380 423
conical	15	17	120	1000	7.053 718
conical	50	30	115	20	9.380 421
conical	50	30	115	500	7.380 421
conical	50	30	115	300	6.049 748
conical, with rim	50	30	115	25	9.380 422
conical, with rim	50	30	115	450	7.380 422
conical, with rim	50	30	115	300	6.054 664



3 4 Centrifuge tubes, conical tubes, PP/HDPE

Thermo Scientific



New and improved conical tubes with the largest writing area on the market for increased traceability with additional space for labeling information. Recyclable plastic rack reduces waste in the lab. New conical tubes have higher RCF ratings, which enable more applications from low speed to super speed centrifugation. They meet USP class VI requirements and are non-cytotoxic, pyrogen-free and RNase/DNase free. Graduated, leak proof and sterile (SAL 10⁻⁶)

Material tubes: PP
Material caps: HDPE

Description	Capacity ml	Diam. mm	Height mm	Max. rcf	PK	Cat. No.
Bulk	15	17	120	10500 x g*	500	9.401 430
Bulk	50	30	115	17000 x g*	500	9.401 432
Racked	50	30	115	17000 x g*	300	9.401 433

* When fully supported by conical rotor cavity or conical adaptor. Note the maximum speeds listed are guidelines only. These speeds have been achieved in reliability tests based on sedimentation of 1.2 specific gravity fluid at 18 °C.



6. Distillation, separation, filtration

Separating, centrifuging/Centrifuge tubes

1 2 3 LLG-Test and centrifuge tubes rimmed, PS or PP

- Made of ultra clear virgin polypropylene or virgin polystyrene
- Polystyrene tubes are transparent. Polypropylene tubes are opaque, break-resistant
- Tubes with cap are ethylene oxide sterilized
- With label

LLG-Dual-Position Caps for test- and centrifuge tubes, PE

- For culture tubes with an O.D. of 12 mm and 17 mm

2 locking positions possible:

- Closed, but gas exchange is still possible for aerobic growth conditions
- Hermetically sealed for anaerobic growth conditions, for storage or despatch of samples or for centrifugation

Description	Capacity	Diam.	Height	Material	Max.	Max.	PK	Cat. No.
	ml	mm	mm		rcf	temp. °C		
with rim	4	12	75	PS	1400	80	500	6.265 657
with rim	4	12	75	PP	3000	120	500	6.265 658
with rim	12	17	100	PS	3000	80	250	6.265 659
with rim	12	17	100	PP	5500	120	250	6.265 660
with dual-position-cap, sterilized	4	12	75	PS	1400	80	500	6.265 661
with dual-position-cap, sterilized	4	12	75	PP	3000	120	500	6.265 662
with dual-position-cap, sterilized	12	17	100	PS	3000	80	500	6.265 663
with dual-position-cap, sterilized	12	17	100	PP	5500	120	500	6.265 664
dual-position-cap		12		PE	-		1000	6.265 665
dual-position-cap		17		PE	-		1000	6.265 666



4



4 Centrifuge tubes, PP, with rim, without stoppers

BRAND



- Cylindrical
- Autoclavable (121 °C)

Nominal capacity	Ext. diam.	Height	Material	Max.	PK	Cat. No.
ml	mm	mm		rcf		
10	16	100	PP	4500	1	7.019 383
26	24	90	PP	4500	1	7.019 385
30	20	100	PP	4500	1	7.019 386
48	30	100	PP	4500	1	7.019 387
75	35	100	PP	4500	1	7.019 388
110	40	120	PP	4500	1	7.019 389
160	45	120	PP	4500	1	7.019 390

5



5 Stoppers, PE for centrifuge tubes, PP

BRAND



For tubes ml	PK	Cat. No.
10	100	7.019 392
26	100	7.019 394
30	100	7.019 395
48	100	7.019 393
75	100	7.019 396
110	100	7.019 397
160	100	7.019 398

6. Distillation, separation, filtration Separating, centrifuging/Centrifuge tubes

1 Disposable test tubes and centrifuge tubes

Disposable tubes with round or conical bottom, with or without rim, for laboratory use.
Made of PS or PP. Can be used in centrifuge.

Kartell

Type	RCF tested x g	Capacity ml	Height mm	Diam. mm	Rim	Material	PK	Cat. No.
Conical	1000	10	105.0	16.0	without	PS	1000	6.239 142
Cylindrical	1000	10	100.0	16.0	without	PS	500	6.230 885
Cylindrical	1300	5	75.0	12.0	without	PS	1000	6.227 892
Cylindrical	1000	15	150.0	16.0	without	PS	850	4.675 450
RIA	1300	5	70.0	11.0	without	PS	1000	6.224 123
Coagulometer	1300	3	55.0	11.5	without	PS	1000	6.241 859
Coagulometer	3500	3	55.0	11.5	without	PP	1000	6.225 923
Cylindrical	1300	5	87.0	12.0	with	PP	4000	6.259 144
Cylindrical	1000	10	99.3	16.0	with	PS	2000	6.226 185
Cylindrical	3000	10	100.0	16.0	with	PP	2000	6.207 280
Conical	1000	10	101.0	16.0	with	PS	2000	6.233 030



2 Test tubes and centrifuge tubes, PP



Round bottom.

Greiner Bio-One

Capacity ml	Diam. mm	Height mm	PK	Cat. No.
4	12	55	3600	9.400 615
5	12	75	2000	9.400 632
12	16	100	1600	9.400 664
14	17	100	1500	9.400 665



Graduated centrifuge tubes, conical, PP or PMP



Autoclavable. PP tubes can withstand temperatures up to +120 °C. PMP (TPX®) tubes can withstand temperatures up to +170 °C. Rimmed. High chemical resistance. Good transparency, especially when in contact with liquids. Cannot be used with naked flame. Can be used as conventional test tubes.

Kartell

Capacity ml	Diam. mm	Height mm	Grad. ml	Material	PK	Cat. No.
10	16	108		PP	500	9.315 832
15	18	120		PP	500	9.315 833
10	16	107	0.2	PP	100	6.233 811
15	18	118	0.2	PP	100	9.315 834
10	16	107	0.2	PMP (TPX®)	50	6.075 746
15	18	118	0.2	PMP (TPX®)	50	6.231 946



6.075 746

4 Centrifuge tubes, cylindrical, PP



Translucent. PP. Autoclavable. Can withstand temperatures up to +120 °C. Rimmed. High chemical resistance. Cannot be used with naked flame. Can also be used as conventional test tubes.

Kartell

Capacity ml	Diam. mm	Height mm	PK	Cat. No.
7	12	100.0	100	9.315 830
16	17	101.0	500	6.204 878
31	24	93.0	50	6.205 839
48	30	104.0	25	6.205 674
70	35	99.5	20	9.315 831
110	40	119.0	25	6.205 169



➡ Stoppers - please see page 29.



1 Centrifuge tubes, plastic, round bottom, PC, graduated

BRAND



Transparent. PC. Rimless, with moulded graduations. Slightly yellowish in colour. Round bottom. For use with loads up to 20000xg rcf.

Note: the strength of Polycarbonate is reduced when it is autoclaved or cleaned using alkaline detergents.

Volume ml	Diam. mm	Height mm	Graduations ml	PK	Cat. No.
50	35	99	1	1	9.315 329
100	41	115	-	1	9.315 339
100	45	98	2	1	9.315 340



2 Centrifuge tubes, round bottom, PS

Transparent.

BRAND

Type	Rotation speed rpm	Ext. diam. mm	Height mm	PK	Cat. No.
Universal	2000	16	100	2000	9.400 792
Universal	4000	12	75	1000	9.400 782
Coagulation	2000	12	55	1000	9.400 780



3 Grip stoppers for centrifuge tubes, round bottom, LDPE

Neutral.

BRAND

For tubes diam. mm	PK	Cat. No.
12	1000	9.400 788
16	1000	9.400 787



4 Centrifuge tubes Nalgene™ Oak Ridge, FEP

Thermo Scientific



Teflon® FEP with Tefzel® ETFE screw cap. Resistant to all acids, bases and solvents. Autoclavable. Operating temperature range -100 to +150 °C. Can be used brim-full in refrigerated centrifuges at up to 50000xg rcf. Leak-proof. Accessory sealing cap assemblies are available for all sizes.

Volume ml	Diam. mm	Height mm	PK	Cat. No.
10	16.0	81.5	1	9.315 701
30	25.5	93.7	1	9.315 702
50*	28.8	107.7	1	9.315 703

* Capacity: 46 ml to the brim.

Teflon® and Tefzel® are a registered trademark of DuPont.



5 Centrifuge tubes Nalgene™ Oak Ridge, PSU

Thermo Scientific



Transparent. Polysulphone (PSU) with PP screw cap. As stable and robust as PC test-tubes, but considerably more resistant to acids and alkalis. Autoclavable. Can be used in refrigerated or ambient centrifuges at up to 50000 xg rcf. Accessory sealing cap assemblies are available for all sizes. Notes: If autoclaving, the tubes must be filled to 80 % of their total capacity. Polysulphone must not be used with Tween, as this causes hairline cracks to form.

Volume ml	Diam. mm	Height mm	PK	Cat. No.
30	25.7	94.5	1	9.315 708
50*	29.0	107.7	1	9.315 709

* Capacity: 43ml to the brim.

1 Nalgene™ Oak-Ridge centrifuge tubes, PC



Thermo Scientific

Transparent. PC with PP screw cap. Can be used in suitable refrigerated or ambient centrifuges at up to 50.000 xg rcf. Autoclavable. Accessory sealing cap assemblies are available for 10 ml, 30 ml and 50 ml sizes.

Capacity ml	Diam. mm	Height mm	PK	Cat. No.
10	16.1	81.7	1	9.315 691
28	25.4	101.8	1	9.315 692
30	25.7	94.5	1	9.315 693
50*	28.8	107.0	1	9.315 694
85**	38.2	105.7	1	9.315 695

* Capacity: 43ml to the brim.

**Capacity: 81ml to the brim.



2 Nalgene™ Oak-Ridge centrifuge tubes, PP-copolymer



Thermo Scientific

PP-copolymer with PP screw cap. PPCO is more resistant to chemicals than PC. Autoclavable. When wet, the translucent test-tube enables observation of the contents. Can be used in refrigerated and unrefrigerated centrifuges at up to 50.000 xg rcf. Accessory sealing cap assemblies are available for all sizes.

Volume ml	Diam. mm	Height mm	PK	Cat. No.
10	16.0	81.4	1	9.315 711
28	25.4	101.9	1	9.315 712
30	25.5	94.3	1	9.315 713
50*	28.8	106.7	1	9.315 714

* Capacity: 42 ml to the brim.



3 Centrifuge tubes Nalgene™, PC



Thermo Scientific

PC, without closures. Friction-fit closures Type DS3111 for high-speed centrifugation please order separately. Transparent. Autoclavable. Can be used in refrigerated or ambient centrifuges at up to 50000xg rcf. Temperature resistant from -135 to +135 °C. Lip (on Cat. No. 9.315 660 and 9.315 661) allows easier retrieval from rotor cavities.

Volume ml	Diam. mm	Height mm	PK	Cat. No.
12	15.9	103.1	1	9.315 654
15	16.0	114.0	1	9.315 655
16	17.9	99.8	1	9.315 656
38	25.3	88.6	1	9.315 658
50	28.8	103.1	1	9.315 659
50*	28.5	106.2	1	9.315 660
100*	31.5	164.3	1	9.315 661

* with lip





1 Centrifuge bottles Nalgene™, PP-copolymer

Thermo Scientific



PP-copolymer with PP screw cap. Autoclavable.

Volume ml	Diam. mm	Height mm	Max. rcf	PK	Cat. No.
250	61.8	127.7	13,200*	1	9.315 716
500	69.5	170.2	13,700	1	9.315 717
500	73.8	169.8	4,800	1	9.315 720
1000	97.5	184.5	7,100	1	9.315 718
1000	97.7	179.0	7,100	1	9.315 719

* Up to 27500 xg if using the sealing screw cap 9.315 734.



2 Centrifuge bottles Nalgene™, PC

Thermo Scientific



PC with PP screw cap. Crystal clear. Good mechanical strength. Autoclavable. Leak-proof even at low speeds.

In order to ensure that the system is leak-proof even at high speeds and when centrifuging dangerous substances, the 250 ml and 1000 ml sizes must be used in conjunction with sealing screw cap sets.

Volume ml	Diam. mm	Height mm	Max. rcf	PK	Cat. No.
250	61.8	127.6	27,500	1	9.315 721
500	69.5	169.6	13,700	1	9.315 723
1000	97.6	188.4	7,100	1	9.315 724
1000	98.1	180.2	7,100	1	9.315 725



3 Sealing cap assemblies Nalgene™, PP

Thermo Scientific



PP screw cap with Tefzel® ETFE plug liner and viton O-ring. Leak-proof at recommended maximum speed and rcf for tubes. Suitable for working with aggressive chemicals. The 38 mm assembly has a PP shoulder reinforcement ring to prevent collapsing of the 250 ml bottles.

For tubes ml	Screw cap diam. mm	PK	Cat. No.
30	20	1	9.315 732
50	24	1	9.315 733
250	38	1	9.315 734

Tefzel® is registered trademark of DuPont.



4 Sealing cap assemblies with silicone seal Nalgene™, PP

Thermo Scientific



For Oak Ridge centrifuge test tubes made of PP, PC and polysulphone.

For tubes ml	Screw cap diam. mm	PK	Cat. No.
28 / 30	20	2	9.315 738
50	24	2	9.315 739
250	58	2	9.315 740
500 / 1000	63	2	9.315 741



5 Wide-mouth centrifuge bottles Nalgene™, PP-copolymer

Thermo Scientific



PP-copolymer with sealing screw cap. Autoclavable.

Volume ml	Diam. mm	Height mm	Max. rcf x g	PK	Cat. No.
250	60.7	133.4	27500	1	9.315 763
450	69.5	160.0	13700	1	9.315 764

LLG-Filter paper, qualitative grades

Made from 100 % cellulose.
Ash content 0.06 %.
Filtration speed according to DIN 53137.
Capacity of separation according to DIN 53135.

1 LLG-Qualitative filter paper, circles

Very fast, pore size 12 to 15 µm.

- For coarse and voluminous precipitates like hydroxides and sulphides

Diam. mm	Filtration time secs.	PK	Cat. No.
90	10	100	9.045 830
110	10	100	9.045 831
125	10	100	9.045 832
150	10	100	9.045 833
185	10	100	9.045 834



2 LLG-Qualitative filter paper, circles

Medium fast, pore size 5 to 8 µm or 5 to 13 µm

- for fast filtration with fine particles

Diam. mm	Filtration time secs.	Pore size µm	PK	Cat. No.
42.5	50	5 - 8	100	9.045 820
90.0	50	5 - 8	100	9.045 821
110.0	50	5 - 8	100	9.045 822
125.0	50	5 - 8	100	7.970 266
150.0	50	5 - 8	100	7.970 269
185.0	50	5 - 8	100	6.242 668
240.0	50	5 - 8	100	6.242 631
42.5	88	5 - 13	100	9.045 800
47.0	88	5 - 13	100	9.045 801
55.0	88	5 - 13	100	9.045 802
70.0	88	5 - 13	100	9.045 803
90.0	88	5 - 13	100	9.045 804
110.0	88	5 - 13	100	9.045 805
125.0	88	5 - 13	100	9.045 806
150.0	88	5 - 13	100	9.045 807
185.0	88	5 - 13	100	9.045 808
240.0	88	5 - 13	100	9.045 809



3 LLG-Qualitative filter paper, folded filters

Medium fast, pore size 5 to 8 µm.

- For fast filtration with fine particles

Diam. mm	Filtration time secs.	PK	Cat. No.
70	50	100	7.659 027
125	50	100	9.045 825
150	50	100	9.045 826
185	50	100	9.045 827
240	50	100	6.242 632



4 LLG-Qualitative filter paper, circles

Slow, pore size 2 to 3 µm.

- for BaSO₄, SnO₂, CuO, Cu₂O

Diam. mm	Filtration time secs.	PK	Cat. No.
70	180	100	7.970 267
90	180	100	7.970 268
110	180	100	6.242 672
125	180	100	7.970 134
150	180	100	7.970 139
185	180	100	6.242 671
240	200	100	7.971 615



5 LLG-Qualitative filter paper, sheets

Medium fast, pore size 5 to 13 µm.

- for analytical works in laboratories

Dimensions mm	Filtration time secs.	PK	Cat. No.
460 x 570	88	100	9.045 810



Filtration/Filter paper, qualitative

1

1 Qualitative filter papers MN 614, round filters

Medium-fast.

MACHEREY-NAGEL

- Embossed
- For determination of sugar content, colour, essential oils and emulsions
- Weight: 75 g/m²
- Thickness: 0.25 mm

Diam. mm	Filtration time secs.	PK	Cat. No.
55	20	100	9.047 400
70	20	100	9.047 401
90	20	100	9.047 402
110	20	100	9.047 403
125	20	100	9.047 404
150	20	100	9.047 405
185	20	100	9.047 406
240	20	100	9.047 407
270	20	100	9.047 408
320	20	100	9.047 409
385	20	100	9.047 410
500	20	100	9.047 411

2

2 Filter paper, qualitative, type MN 615, circles

Medium speed, smooth.

MACHEREY-NAGEL

Diam. mm	Filtration time secs.	PK	Cat. No.
55	22	100	9.047 500
70	22	100	9.047 501
90	22	100	9.047 502
110	22	100	9.047 503
125	22	100	9.047 504
150	22	100	9.047 505
185	22	100	9.047 506
240	22	100	9.047 507

3

3 Filter paper, qualitative, type MN 615 1/4, filter circles

Medium fast filtration, smooth.

MACHEREY-NAGEL

For fat determinations, free from fats and resins.
Ether soluble residue <0.1 mg for diam. 270 mm filters.

Diam. mm	Filtration time secs.	Thickness mm	PK	Cat. No.
55	22	0.16	100	9.048 500
70	22	0.16	100	9.048 501
90	22	0.16	100	9.048 502
110	22	0.16	100	9.048 503
125	22	0.16	100	9.048 504
150	22	0.16	100	9.048 505
185	22	0.16	100	9.048 506
240	22	0.16	100	9.048 507
270	22	0.16	100	9.048 508
320	22	0.16	100	9.048 509
385	22	0.16	100	9.048 510
400	22	0.16	100	4.001 029
500	22	0.16	100	9.048 511

4

4 Filter paper MN 617 1/4, qualitative, folded filters

Fast filtration, smooth.

MACHEREY-NAGEL

Diam. mm	Filtration time secs.	PK	Cat. No.
90	9	100	9.048 702
110	9	100	9.048 703
125	9	100	9.048 704
150	9	100	9.048 705
185	9	100	9.048 706
240	9	100	9.048 707

6. Distillation, separation, filtration Filtration/Filter paper, qualitative

1 Qualitative Filter Paper, Grade 2555 1/2, qualitative

For filtration of the mash when determining the extract in malt and wort according to the analytical regulations of the EBC. Also used for removal of carbon dioxide from beer.

Whatman

1



Diam. mm	PK	Cat. No.
185	100	7.009 656
240	100	7.009 657
320	100	7.060 298

2 Filter paper, Grade 1

Circles and sheets. Qualitative. The most widely used grade of filter paper.

Whatman

2

Flowrate: Medium
Retention: Medium
Wet strength: Low
Thickness: 0.18 mm



Diam. mm	PK	Cat. No.
10	500	6.228 829
20	400	9.048 942
25	400	9.048 943
30	400	9.048 944
32	100	9.048 937
42,5	100	9.056 199
47	100	9.048 945
55	100	9.056 200
70	100	9.056 201
85	100	9.048 946
90	100	9.056 202
110	100	9.056 203
125	100	9.056 204
150	100	9.056 205
185	100	9.056 206
240	100	9.056 207
270	100	9.056 208
320	100	9.056 209
400	100	9.056 278
500	100	9.056 279
460 x 570	100	9.056 331
26 x 31	1000	9.056 337
75 x 100	500	9.056 338
460 x 570	500	9.056 340
580 x 680	100	9.056 341

3 Filter paper, Grade 2

Circles and sheets. Qualitative. Slightly thicker and more retentive than number 1.

Whatman

3

Flowrate: Medium
Retention: Medium
Wet strength: Low
Thickness: 0.19 mm
Ash: 0.06 %



Diam. mm	PK	Cat. No.
42,5	100	9.056 198
47	100	6.242 786
55	100	9.056 210
70	100	9.056 211
90	100	9.056 212
110	100	9.056 213
125	100	9.056 214
150	100	9.056 215
185	100	9.056 216
240	100	9.056 217
320	100	9.056 219
460 x 570	100	9.056 332
580 x 680	100	6.236 821

Filtration/Filter paper, qualitative



1 Filter paper, Grade 3

Circles and sheets. Qualitative. Very thick. Double the thickness of number 1.

Whatman

Flowrate: Medium
 Retention: High
 Wet strength: High
 Thickness: 0.39 mm
 Ash: 0.06 %

Diam. mm	PK	Cat. No.
55	100	9.056 220
70	100	9.056 221
90	100	9.056 222
110	100	9.056 223
125	100	9.056 224
150	100	9.056 225
185	100	9.056 226
240	100	9.056 227
460 x 570	100	9.056 333



2 Filter paper, Grade 4

Circles. Qualitative. Fast flowrate. Excellent retention of coarse and gelatinous precipitants. Smooth. Supplied in packs of circles as outlined below.

Whatman

Flowrate: Fast
 Retention: High
 Wet strength: Low
 Thickness: 0.21 mm
 Ash: 0.06 %

Diam. mm	PK	Cat. No.
41	100	6.286 923
42,5	100	9.056 231
55	100	9.056 233
70	100	9.056 235
90	100	9.056 196
110	100	9.056 230
125	100	9.056 232
150	100	9.056 234
185	100	9.056 236
240	100	9.056 237
270	100	9.056 238
320	100	9.056 239
460 x 570	100	9.056 334



3 Filter paper, Grade number 5

Circles. Qualitative. Slow flowrate. Retains fine precipitates, grained surface. Supplied in packs of circles as outlined below.

Whatman

Flowrate: Slow
 Retention: High
 Wet strength: High
 Thickness: 0.20 mm
 Ash: 0.06 %

Diam. mm	PK	Cat. No.
55	100	9.056 240
70	100	9.056 241
90	100	9.056 242
110	100	9.056 243
125	100	9.056 244
150	100	9.056 245
185	100	9.056 246
240	100	9.056 247

6. Distillation, separation, filtration Filtration/Filter paper, qualitative

1 Filter paper, Grade number 6

Circles. Qualitative. Slow, faster as Grade 5. Supplied in packs of circles as outlined below.

Whatman

Flowrate: Slow
Retention: High
Wet strength: Low
Thickness: 0.18 mm
Ash: 0.20 %

Diam. mm	PK	Cat. No.
70	100	9.056 251
90	100	9.056 252
110	100	9.056 253
125	100	9.056 254
150	100	9.056 255
185	100	9.056 256
240	100	9.056 257

1



2 Filter Papers, Grade 50, qualitative, circles and sheets

Compatible with Hirsch or Büchner funnels, average thickness 115 µm.
Acid-treated for high wet-strength and chemical resistance.

Whatman

- Nominal particle retention of 2.7 µm
- Slow flow rates (Herzberg filtration speed 2685 s)
- High purity and low ash content (0.015 % ash maximum)

Diam. mm	PK	Cat. No.
42.5	100	6.233 382
55	100	9.056 450
70	100	9.056 451
90	100	9.056 452
110	100	9.056 453
125	100	9.056 454
150	100	9.056 455
185	100	9.056 456
240	100	9.056 457
320	100	9.056 459
500	100	9.056 525
460 x 570	100	9.056 550

2



3 Filter paper, Grade 91

Circles. Qualitative. General purpose schools grade, creped.

Whatman

Flowrate: Medium
Retention: Medium
Wet strength: High
Thickness: 0.205mm

Diam. mm	PK	Cat. No.
110	100	9.048 938
125	100	9.048 933
150	100	9.048 939
185	100	9.048 934
240	100	9.048 940

3



4 Filter paper, Grade 113

Circles. Qualitative. Fast flow. Excellent retention of coarse and gelatinous precipitates, creped.

Whatman

Flow rate: Fast
Retention: Medium
Wet strength: High
Thickness: 0.42mm
Ash: 0.06%

Diam. mm	PK	Cat. No.
90	100	9.049 015
125	100	9.049 016
150	100	9.049 017
185	100	9.049 018
240	100	9.049 019

4



Filtration/Filter paper, qualitative

1

1 Qualitative filter paper, Grade 595, circles

Medium fast 4 to 7 µm

- thin filter paper
- for medium to fine precipitates and general laboratory work
- Weight: 68 g/m²
- Thickness: 0.150 mm

Whatman

Diam. mm	PK	Cat. No.
110	100	9.062 303
125	100	9.062 304
150	100	9.062 305

2

2 Qualitative filter paper, Grade 597, circles and sheets

Medium fast, 4 - 7 µm

- thicker and faster than 595
- for medium to fine precipitates
- Weight 81 g/m²
- Thickness 0.180 mm

Whatman

Diam. mm	PK	Cat. No.
45	100	7.009 631
55	100	9.062 400
70	100	9.062 401
90	100	9.062 402
110	100	9.062 403
125	100	9.062 404
150	100	9.062 405
185	100	9.062 406
240	100	9.062 407
580 x 580	100	9.066 597

3

3 Filter Papers, circles, quadrant folded, cellulose

Filter papers in a flat, quadrant folded format to fit conical filter funnels. Easy and time-saving handling for analyses with high sample throughput.

Whatman

Type	Diam. mm	Thickness mm	Weight g / m ²	Ash content %	PK	Cat. No.
Grade 1 FF	110	0.180	87	0.060	500	4.668 159
Grade 1 FF	125	0.180	87	0.060	500	4.668 160
Grade 1 FF	150	0.180	87	0.060	500	4.668 161
Grade 40 FF	110	0.210	95	0.007	500	4.668 153
Grade 40 FF	125	0.210	95	0.007	500	4.668 154
Grade 40 FF	150	0.210	95	0.007	500	4.668 155
Grade 44 FF	110	0.215	85	0.007	500	4.668 156
Grade 44 FF	125	0.215	85	0.007	500	4.668 157
Grade 44 FF	150	0.215	85	0.007	500	4.668 158

4

4 Filter Papers, circles, pyramid version

Filter papers in a flat, pyramidal folded format. Easy and time-saving handling.

Whatman

Type	Diam. mm	Thickness mm	Weight g / m ²	Ash content %	PK	Cat. No.
Grade 6	125	0.18	100	0.150	1000	4.668 162
Grade 40	125	0.21	95	0.007	1000	4.668 163

We can **supply** this
manufacturer's whole
product range !



Whatman®

6. Distillation, separation, filtration

Filtration/Filter paper, qualitative

1 Filter paper, Grade number 2 V

Qualitative. Folded (pre-pleated) version of Number 2.
 Flowrate: Medium
 Retention: Medium
 Wet strength: Low
 Thickness: 0.19 mm
 Ash: 0.06 %

Whatman

Diam. mm	PK	Cat. No.
125	100	9.056 304
150	100	9.056 305
185	100	9.056 306
240	100	9.056 307
270	100	9.056 308
320	100	9.056 309

1



2 Filter paper, grade 113 V

Circles. Prepleated. Qualitative. Excellent retention of coarse and gelatinous precipitates, creped.

Whatman

Flow rate: Fast
 Retention: Medium
 Wet strength: High
 Thickness: 0.42 mm

Diam. mm	PK	Cat. No.
125	100	9.056 294
150	100	9.056 295
185	100	9.056 296
240	100	9.056 297
270	100	9.056 298
320	100	9.056 299
500	100	9.056 301

2

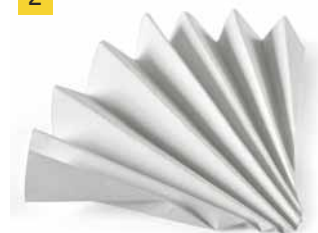

3 Qualitative filter paper, Grade 593 1/2, folded filters

Medium to slow 2 to 5 µm

Whatman

- time saving, because folded filters have a larger surface area than comparable circular filters
- for medium to fine precipitates and general laboratory work
- Weight: 85 g/m²
- Thickness: 0.17 mm

Diam. mm	PK	Cat. No.
185	100	9.063 106
240	100	9.063 107

3



4 Qualitative filter paper, Grade 595 1/2, folded filters

Medium fast, 4 - 7 µm.

Whatman

- time saving, because folded filters have a larger surface area
- filter faster than comparable circular filters
- for medium to fine precipitates and general laboratory work
- Weight: 68 g/m²
- Thickness: 0.15 mm

Diam. mm	PK	Cat. No.
70	100	9.063 301
90	100	9.063 302
110	100	9.063 303
125	100	9.063 304
150	100	9.063 305
185	100	9.063 306
210	100	7.009 626
240	100	9.063 307
270	100	9.063 308
320	100	9.063 309
385	100	9.063 310

4



Filtration/Filter paper, qualitative

1

1 Qualitative filter paper, Grade 597 1/2, folded filters

Medium fast, 4 - 7 µm
Whatman

- time saving, because folded filters have a larger surface area
- for medium to fine precipitates
- Weight: 81 g/m²
- Thickness: 0.18 mm

Diam. mm	PK	Cat. No.
70	100	9.063 401
90	100	9.063 402
110	100	9.063 403
125	100	9.063 404
150	100	9.063 405
185	100	9.063 406
240	100	9.063 407
270	100	9.063 408
320	100	9.063 409
385	100	9.063 410
500	100	9.063 411

2

2 Qualitative filter paper, Grade 602h 1/2, folded filters

Slow < 2 µm
Whatman

- thick filter paper
- for fine precipitates
- Weight: 85 g/m²
- Thickness: 0.15 mm

Diam. mm	PK	Cat. No.
90	100	9.063 702
125	100	9.063 704
150	100	9.063 705
185	100	9.063 706
240	100	9.063 707

3

3 Qualitative filter paper, Grade 604 1/2, folded filters

Fast, 12 to 25 µm
Whatman

- time saving, because folded filters have a larger surface area
- filter faster than comparable circular filters
- for coarse precipitates (e.g. hydroxide and sulphide)
- Weight: 80 g/m²
- Thickness: 0.19 mm

Diam. mm	PK	Cat. No.
125	100	9.063 904
150	100	9.063 905
185	100	9.063 906
240	100	9.063 907
320	100	9.063 909

4

4 Qualitative filter paper, Grade 1573 1/2, folded filters

Fast, 12 to 25 µm
Whatman

- wet-strength
- time saving, because folded filters have a larger surface area than circular filters of the same diameter
- Weight: 88 g/m²
- Thickness: 0.17 mm

Diam. mm	PK	Cat. No.
125	100	9.065 104
150	100	9.065 105
185	100	9.065 106
240	100	9.065 107
270	100	9.065 108
320	100	9.065 109

Filter Paper, qualitative, folded filters

Highly pure filter paper (approx. 0.08 % ash) recommended for precise identification of materials and for sample preparation prior to sensitive detection methods. These filter papers are perfectly qualified for food control according to LFGB paragraph 64 para. 1 and 2, beverage analysis and environmental monitoring.

Hahnemühle

- Made of the same raw materials (super-refined cotton linters and cellulose) like quantitative filter papers
- High stability and durability due to alpha-Cellulose content above 95 %

1 Filter paper 595, qualitative, folded filters

Hahnemühle

Diam.	Weight	Filtration time acc. to Herzberg	Thickness	PK	Cat. No.
mm	g / m ²	s	mm		
90	68	160	0.15	100	4.006 260
110	68	160	0.15	100	4.006 261
125	68	160	0.15	100	4.006 262
150	68	160	0.15	100	4.006 263
185	68	160	0.15	100	4.006 264
240	68	160	0.15	100	4.006 266
270	68	160	0.15	100	4.006 267
320	68	160	0.15	100	4.006 268
385	68	160	0.15	100	4.006 269
500	68	160	0.15	100	4.664 858

2 Filter paper 597, qualitative, folded filters

Hahnemühle

Diam.	Weight	Filtration time acc. to Herzberg	Thickness	PK	Cat. No.
mm	g / m ²	s	mm		
90	85	155	0.18	100	4.006 271
110	85	155	0.18	100	4.006 272
125	85	155	0.18	100	4.006 273
150	85	155	0.18	100	4.006 274
185	85	155	0.18	100	4.006 275
240	85	155	0.18	100	4.006 277
270	85	155	0.18	100	4.006 278
320	85	155	0.18	100	4.006 279
385	85	155	0.18	100	4.006 280

3 Filter Paper, for clarification, folded filters

Recommended for identification of substances, clarification of liquids and for the preparation of samples in a broad range of chemical analysis.

Hahnemühle

- Creped filter papers have a particularly large surface area and correspondingly shorter filtration times
- For quick separation of large particles
- For reliable clarification of viscous liquids

Type	Diam.	Weight	Filtration time acc. to Herzberg	Thickness	PK	Cat. No.
	mm	g / m ²	s	mm		
0858	150	75	110	0.17	100	4.006 179
0858	240	75	110	0.17	100	4.006 181
0858	320	75	110	0.17	100	4.006 182
0860	150	74	120	0.17	100	4.006 184
0860	185	74	120	0.17	100	4.006 185
0860	320	74	120	0.17	100	4.006 187
0905	320	74	40	0.27	100	4.006 188
400	70	65	200	0.17	100	4.006 214
400	90	65	200	0.17	100	4.006 215
400	110	65	200	0.17	100	4.006 216
400	125	65	200	0.17	100	4.006 217
400	130	65	200	0.17	100	4.006 218
400	150	65	200	0.17	100	4.006 219
400	185	65	200	0.17	100	4.006 220
400	200	65	200	0.17	100	4.006 221
400	250	65	200	0.17	100	4.006 223
400	300	65	200	0.17	100	4.006 224
400	320	65	200	0.17	100	4.006 225
400	350	65	200	0.17	100	4.006 226
400	400	65	200	0.17	100	4.006 227
400	500	65	200	0.17	100	4.006 228
400	650	65	200	0.17	100	4.006 229



Filtration/Filter paper, qualitative

1

1 Qualitative Filters for beer analysis

Suitable for analytical methods in breweries to filter and analyse, based upon recommended procedures of the EBC (European Brewery Convention).

Hahnemühle

- Medium fast
- Grained surface

Further sizes on request.

Type	Diam. mm	Weight g / m ²	Filtration time acc. to Herzberg s	Thickness mm	PK	Cat. No.
Folded filter	185	75	110	0.17	100	4.006 207
Folded filter	240	75	110	0.17	100	4.006 208
Folded filter	320	75	110	0.17	100	4.006 209
Filter circles	185	75	110	0.17	100	4.006 395
Filter circles	240	75	110	0.17	100	4.006 396

2

2 Germ Testing Papers

For carrying out germ resistance tests. All papers are made from high-purity cellulose and are free of spores, bacteria and toxic substances that could influence the germination of the seeds. The highly absorbent papers store water for the entire duration of the tests. All germ test papers meet the requirements of ISTA and AOSA.

Hahnemühle

- Reliable seed testing
- Conductivity 40 mS/m
- pH value between 6.0 and 7.5
- High absorbance
- Roots do not grow through the paper
- Papers conform to ISTA recommendations of 2017

Type	Description	Weight g / m ²	Thickness mm	Dimensions (D x W) mm	Colour	PK	Cat. No.
3014	pleated strips for germ testing, 50 double pleats	110	0.22	110 x 2000	white	306	6.254 182
3014	pleated strips for germ testing, 50 double pleats	110	0.22	110 x 2000	white	1008	4.006 111
3236	pleated strips for germ testing, 50 double pleats	110	0.22	110 x 2000	grey	1008	4.006 112
0858	wrapping strips for pleated strips, sheets	75	0.17	110 x 580		500	4.006 047
520b	filter sheet	155	0.65	580 x 580	white	100	6.241 855
5703	absorbent filter paper, technical, sheets	240	0.55	580 x 580	white	100	4.006 062

3

3 Germ testing papers

The testing papers do not contain any substances which could influence the growth of seeding. The colors used are non-toxic to germinating seed. The moisture level is maintained throughout the germination test period. The filter papers comply with ISTA and AOSA requirements.

Ahlstrom-Munksjö

Description	Weight g / m ²	Thickness mm	Dimensions (D x W) mm	Colour	PK	Cat. No.
Grade 1765, pleated strips, 50 double pleats	110	0.22	2000 x 110	white	1000	7.971 775
Grade 1700, with slot for wicks	135	0.31	∅ 85	white	500	7.970 731
Grade 1750	90	0.20	220 x 400	white	500	6.237 070
Grade 1755, PE coated paper	53	0.19	190 x 400	-	500	6.237 071

4

4 Qualitative Filters 551, black, round filters

Recommended for the detection of very fine traces of light-coloured particles and precipitates.

Hahnemühle

- Made of pure celluloses and with constriction of black additives
- White and light-coloured particles can be detected easily by the strong contrast to the black filter paper
- Weight 95 g/m²
- Thickness 0.2 mm
- Filtration speed acc. to Herzberg 850 s

Further sizes on request.

Diam. mm	PK	Cat. No.
90	100	7.657 096
240	100	6.236 831

1 Filter paper, qualitative, Grade 3 hw, folded filters

Sartorius Lab Instruments

Diam. mm	PK	Cat. No.
90	100	9.049 401
110	100	9.049 402
125	100	9.049 403
150	100	9.049 404
185	100	9.049 405
240	100	9.049 406
270	100	9.049 407
320	100	9.049 408
385	100	9.049 409

Other diameters/formats are available on request.

1



2 Filter paper, qualitative, Grade 3 hw, circles

Sartorius Lab Instruments

Material: alpha cellulose (95 %)
 Properties: medium speed filtration, thin
 Filtration time: 15 to 25 secs.
 Surface weight: 65 g/m²
 Ash content: < 0.1 %

Diam. mm	PK	Cat. No.
55	100	9.049 420
70	100	9.049 421
90	100	9.049 422
110	100	9.049 423
125	100	9.049 424
150	100	9.049 425
185	100	9.049 426
240	100	9.049 427
270	100	9.049 428
320	100	9.049 429
385	100	9.049 457

Other diameters/formats are available on request.

2



Filter paper, soil analysis

For detecting nutrients available to plants, low in nitrogen and phosphorus.

Sartorius Lab Instruments

Grade 131

Properties: slow filtration
 Filtration time in accordance with DIN 53137: 80 to 140 secs.
 Surface weight: 80 g/m²

Grade 132

Properties: medium fast filtration
 Filtration time in accordance with DIN 53137: 35 to 75 secs.
 Surface weight: 80 g/m²

Type	Diam. mm	PK	Cat. No.
Folded filters 131	150	100	9.049 550
Folded filters 131	185	100	9.049 551
Folded filters 132	150	100	9.049 552
Folded filters 132	185	100	9.049 553

3 Technical Filter Papers, sheets

Dimensions: 580 x 580 mm, creped.

Sartorius Lab Instruments

Other dimensions are available on request.

Type	Weight g / m ²	Filtration time secs.	PK	Cat. No.
100/N	85	30	100	7.606 410
3 h	65	35	100	7.671 897
3 hw	65	20	100	9.049 458
3 m/N	65	30	100	7.606 373
3 S/h	200	55	100	9.049 619
3 w	65	15	100	9.067 003
4 b	75	22	100	9.067 004
6	80	15	100	7.058 772
6 S/N*	145	12	100	6.253 513

* creped.

3



Filtration/Filter paper, quantitative

LLG-Filter papers for quantitative analysis

Made from 100 % cellulose.
Ash content 0.007 %.
Filtration speed according to DIN 53137.
Capacity of separation according to DIN 53135.

1

1 LLG-Quantitative filter paper, circles

Very fast, pore size 12 to 15 µm

- for coarse, high volume precipitates
- for determinations according to the German Standard Methods for the examination of water, waste water and sludge.
- for $\text{Fe}(\text{OH})_2$, $\text{Al}(\text{OH})_3$, NaSO_4
- ashless, equivalent black tape

Diam. mm	Filtration time secs.	PK	Cat. No.
70	10	100	9.045 840
90	10	100	9.045 841
110	10	100	9.045 842
125	10	100	9.045 843
150	10	100	9.045 844
185	10	100	9.045 845

2

2 LLG-Quantitative filter paper, circles

Fast, pore size 8 to 12 µm.

- most frequently used quantitative filter
- for PbS , Ag_2S , FeS , carbonates
- ashless, equivalent white tape

Diam. mm	Filtration time secs.	PK	Cat. No.
90	20	100	7.970 057
110	20	100	7.970 000
125	20	100	7.970 058
150	20	100	7.970 001
185	20	100	7.970 002
200	20	100	6.242 179

3

3 LLG-Quantitative filter paper, circles

Medium fast, pore size 5 to 8 µm.

- for NH_4MgPO_4 , CaC_2O_4 , BaSO_4
- ashless, equivalent red tape

Diam. mm	Filtration time secs.	PK	Cat. No.
55	50	100	6.256 437
70	50	100	7.970 571
90	50	100	7.970 032
110	50	100	6.242 748
125	50	100	7.970 045
150	50	100	6.252 765
185	50	100	6.242 747
240	50	100	7.970 591

4

4 LLG-Quantitative filter paper, circles

Slow, pore size 2 to 3 µm.

- for very fine precipitates and small particles
- for soil analysis
- for BaSO_4 (hot precipitate), PbSO_4 , Cu_2O , ZnS , NiS
- ashless, equivalent blue tape

Diam. mm	Filtration time secs.	PK	Cat. No.
47	180	100	6.285 586
70	180	100	7.970 271
90	180	100	9.045 850
110	180	100	6.242 670
125	180	100	9.045 851
150	180	100	9.045 852
185	180	100	6.242 669

6. Distillation, separation, filtration Filtration/Filter paper, quantitative

1 Filter Papers, Grade 540, quantitative, round

- Acid-treated for high wet-strength
- Extremely low ash content (0.006 % ash maximum)
- Nominal particle retention of 8 µm
- Medium flow rate (Herzberg filtration speed 200 s)
- High chemical resistance to strong acid and alkali suspensions

Whatman

Diam. mm	PK	Cat. No.
24	100	6.241 936
42,5	100	7.622 636
55	100	9.056 480
90	100	9.056 482
110	100	9.056 483
125	100	9.056 484
150	100	9.056 485
185	100	9.056 486
240	100	9.056 487

1



2 Filter Papers, Grade 541, quantitative, round sheets

- High wet-strength
- High chemical resistance to strong acid and alkali suspensions
- Retention of gelatinous precipitate
- 22 µm nominal particle retention rating
- Fast flow rate (Herzberg filtration speed 34 s)
- Maximum of 0.006 % ash concentration

Whatman

Diam. mm	PK	Cat. No.
42,5	100	9.056 515
47	100	6.302 895
55	100	9.056 490
70	100	9.056 491
90	100	9.056 492
110	100	9.056 493
125	100	9.056 494
150	100	9.056 495
185	100	9.056 496
240	100	9.056 497
270	100	9.056 498
320	100	9.056 499
460 x 570	100	9.056 561

2



3 Quantitative filter paper, Grade 589/1, circles

**Fast 12 to 25 µm
Black ribbon**

- for coarse, high volume precipitates
- for determinations according to the German Standard Methods for the examination of water, waste water and sludge.
- most frequently used quantitative filter
- Weight: 80 g/m²
- Thickness: 0.19 mm

Whatman

Diam. mm	PK	Cat. No.
90	100	9.060 102
110	100	9.060 103
125	100	9.060 104
150	100	9.060 105
185	100	9.060 106

3



4 Quantitative filter paper, type MN 640 w, circles

Fast filtration, smooth, ashless.

MACHERY-NAGEL

Diam. mm	Filtration time secs.	PK	Cat. No.
55	9	100	9.046 200
70	9	100	9.046 201
90	9	100	9.046 202
110	9	100	9.046 203
125	9	100	9.046 204
150	9	100	9.046 205

Grey pack, equivalent grade to black band.

4



Filtration/Filter paper, quantitative

1

1 Quantitative filter paper, type MN 640 m, circles

Medium-fast, smooth, ashless.

MACHEREY-NAGEL

Diam. mm	Filtration time secs.	PK	Cat. No.
55	27	100	9.046 300
70	27	100	9.046 301
90	27	100	9.046 302
110	27	100	9.046 303
125	27	100	9.046 304
150	27	100	9.046 305

White pack, equivalent grade to white band.

2

2 Quantitative filter paper, Grade 589/2
Medium fast, 4 to 12 µm. White ribbon.

Whatman

- for the analysis of foodstuffs
- for carbonates of alkaline earth metals, $(\text{NH}_4)_2[\text{P}(\text{Mo}_3\text{O}_{10})_2] \times \text{aq.}$, $\text{Mg}(\text{NH}_4)\text{PO}_4$, CaC_2O_4 (hot precipitates)
- Weight: 85 g/m²
- Thickness: 0.18 mm

Diam. mm	Description	PK	Cat. No.
12.7	filter paper circles	1000	7.009 571
50.0	filter paper circles	100	7.079 006
55.0	filter paper circles	100	9.060 200
70.0	filter paper circles	100	9.060 201
90.0	filter paper circles	100	9.060 202
110.0	filter paper circles	100	9.060 203
125.0	filter paper circles	100	9.060 204
150.0	filter paper circles	100	9.060 205
185.0	filter paper circles	100	9.060 206
240.0	filter paper circles	100	9.060 207

3

3 Quantitative filter paper, Grade 589/3, circles
Slow < 2 µm. Blue ribbon.

Whatman

- for very fine precipitates and small particles
- for soil analysis
- for BaSO_4 (hot precipitate), PbSO_4 , Cu_2O , ZnS , NiS
- Weight: 84 g/m²
- Thickness: 0.16 mm

Diam. mm	PK	Cat. No.
12.8	1000	7.009 579
110.0	100	9.060 303
125.0	100	9.060 304
150.0	100	9.060 305
185.0	100	9.060 306

4

4 Quantitative filter paper, grade 40

Circles. Quantitative. Ashless.

Whatman

- Flow rate: Medium
- Retention: Medium
- Wet strength: Low
- Thickness: 0.21 mm
- Ash: 0.007 %

Diam. mm	PK	Cat. No.
32	100	9.049 035
42.5	100	9.056 399
55	100	9.056 400
70	100	9.056 401
90	100	9.056 402
110	100	9.056 403
125	100	9.056 404
150	100	9.056 405
185	100	9.056 406
240	100	9.056 407

6. Distillation, separation, filtration Filtration/Filter paper, quantitative

1 Quantitative filter paper, grade 41

Circles. Quantitative. Ashless. For filtration of coarse and gelatinous precipitates. Supplied in box of 100.

Whatman

Flow rate: Fast
Retention: Medium
Wet strength: Low
Thickness: 0.22 mm
Ash: 0.007 %

Diam. mm	PK	Cat. No.
55	100	9.056 410
60	100	9.049 045
70	100	9.056 411
90	100	9.056 412
110	100	9.056 413
125	100	9.056 414
150	100	9.056 415
185	100	9.056 416
240	100	9.056 417



2 Filter paper, grade 42

Circles. Quantitative. Ashless. For filtration of fine precipitates.

Whatman

Flow rate: Slow
Retention: High
Wet strength: Low
Thickness: 0.20 mm
Ash: 0.007 %

Diam. mm	PK	Cat. No.
42.5	100	9.056 419
55	100	9.056 420
70	100	9.056 421
90	100	9.056 422
110	100	9.056 423
125	100	9.056 424
150	100	9.056 425
185	100	9.056 426
240	100	9.056 427



3 Phase separators, 1PS

A silicone impregnated, water repellent paper which can be used to separate aqueous solutions from immiscible solvents. The aqueous phase is retained and the organic phase passes through. Will retain solid particles. Can be used either flat under suction not exceeding 70 mm Hg or quadrant folded in a conical glass funnel. Supplied in box of 100 circles. Note: This paper contains a small quantity of tin complex catalyst. It is therefore not recommended for use when this complex may cause interference, e.g. with the use of dithizone (diphenylthiocarbazone) reagent.

Whatman

Flow rate: Fast
Retention: Medium
Wet strength: High
Thickness: 0.16 mm
Ash: 0.008 %

Diam. mm	PK	Cat. No.
70	100	9.056 891
90	100	9.056 892
110	100	9.056 893
125	100	9.056 894
150	100	9.056 895
185	100	9.056 896
240	100	9.056 897
270	100	9.056 898

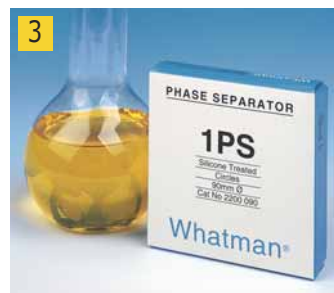

Filtration/Filter paper, quantitative



1 Filter paper, quantitative, round filters

Ashless filters (approx. 0.004%), recommended for quantitative analysis, routine gravimetric tests and sample preparation for instrumental analysis.

Hahnemühle

- Acid-washed and rinsed with water to neutralise
- Free of minerals and metallic ions, ideal for the detection of metallic ions
- For analytical applications, routine quantitative and /or gravimetric procedures
- These filter papers are perfectly qualified for food control, beverage analysis and environmental monitoring

Type	Colour coding	Diam. mm	Weight g / m ²	Filtration time acc. to Herzberg s	Thickness mm	PK	Cat. No.
FP 589/1	black	47.0	79	50	0.19	100	4.006 441
FP 589/1	black	55.0	79	50	0.19	100	4.006 442
FP 589/1	black	70.0	79	50	0.19	100	4.006 443
FP 589/1	black	90.0	79	50	0.19	100	4.006 444
FP 589/1	black	110.0	79	50	0.19	100	4.006 445
FP 589/1	black	125.0	79	50	0.19	100	4.006 446
FP 589/1	black	150.0	79	50	0.19	100	4.006 447
FP 589/1	black	185.0	79	50	0.19	100	4.006 448
FP 589/1	black	240.0	79	50	0.19	100	4.006 449
FP 589/2	white	12.5	85	140	0.18	1000	4.006 450
FP 589/2	white	40.5	85	140	0.18	100	4.006 451
FP 589/2	white	47.0	85	140	0.18	100	4.006 452
FP 589/2	white	55.0	85	140	0.18	100	4.006 453
FP 589/2	white	70.0	85	140	0.18	100	4.006 454
FP 589/2	white	90.0	85	140	0.18	100	4.006 455
FP 589/2	white	110.0	85	140	0.18	100	4.006 456
FP 589/2	white	125.0	85	140	0.18	100	4.006 457
FP 589/2	white	150.0	85	140	0.18	100	4.006 458
FP 589/2	white	185.0	85	140	0.18	100	4.006 459
FP 589/3	blue	47.0	84	750*	0.16	100	4.006 461
FP 589/3	blue	55.0	84	750*	0.16	100	4.006 462
FP 589/3	blue	70.0	84	750*	0.16	100	4.006 463
FP 589/3	blue	90.0	84	750*	0.16	100	4.006 464
FP 589/3	blue	110.0	84	750*	0.16	100	4.006 465
FP 589/3	blue	125.0	84	750*	0.16	100	4.006 466
FP 589/3	blue	150.0	84	750*	0.16	100	4.006 467
FP 589/3	blue	185.0	84	750*	0.16	100	4.006 468
FP 589/3	blue	240.0	84	750*	0.16	100	4.006 469
FP 589/4	yellow	90.0	81	170	0.17	100	4.006 473
FP 589/4	yellow	110.0	81	170	0.17	100	4.006 474
FP 589/4	yellow	125.0	81	170	0.17	100	4.006 475
FP 589/4	yellow	150.0	81	170	0.17	100	4.006 476
FP 589/5	red	55.0	84	450	0.17	100	4.006 480
FP 589/5	red	70.0	84	450	0.17	100	4.006 481
FP 589/5	red	90.0	84	450	0.17	100	4.006 482
FP 589/5	red	110.0	84	450	0.17	100	4.006 483
FP 589/5	red	125.0	84	450	0.17	100	4.006 484
FP 589/5	red	150.0	84	450	0.17	100	4.006 485

*Measured with 100 mm water column instead of 50 mm



2 Filter paper, quantitative, Grade 388 - black spot, circles and sheets

Sartorius Lab Instruments

Properties: Rapid filtration, coarse porosity
 Filtration time: 6 to 14 secs.
 Surface weight: 84 g/m²

Diam. mm	PK	Cat. No.
55	100	9.049 500
70	100	9.049 501
90	100	9.049 502
110	100	9.049 503
125	100	9.049 504
150	100	9.049 505
185	100	9.049 571
240	100	9.049 572

Other formats and diameters are available on request.

1 Quantitative filter paper, Grade 389 - white spot, circles and sheets

Sartorius Lab Instruments

Properties: medium speed filtration
 Filtration time: 16 to 28 secs.
 Surface weight: 84 g/m²

Diam. mm	PK	Cat. No.
55	100	9.049 510
70	100	9.049 511
90	100	9.049 512
110	100	9.049 513
125	100	9.049 514
150	100	9.049 515

Other formats and diameters are available on request.



2 Quantitative filter paper, Grade 391 - blue spot, circles and sheets

Sartorius Lab Instruments

Properties: very slow filtration
 Filtration time: 150 to 250 secs.
 Surface weight: 84 g/m²

Diam. mm	PK	Cat. No.
55	100	9.049 520
70	100	9.049 585
90	100	9.049 586
110	100	9.049 587
125	100	9.049 524
150	100	9.049 588
185	100	9.049 589
240	100	9.049 590
580 x 580	100	9.049 591

Other formats and diameters are available on request.



3 Filter paper, quantitative, Grade 392 - red spot, circles and sheets

Sartorius Lab Instruments

Properties: medium fast filtration
 Filtration time: 35 to 70 secs.
 Surface weight: 84 g/m²

Diam. mm	PK	Cat. No.
55	100	9.049 577
70	100	9.049 578
90	100	9.049 579
110	100	9.049 580
125	100	9.049 581
150	100	9.049 582
185	100	9.049 536
240	100	9.049 583
580 x 580	100	9.049 584

Other formats and diameters are available on request.



4 Filter paper grade 390, green dot, quantitative, round filter

Sartorius Lab Instruments

Slow filtration. These ashless filter papers are used for quantitative and gravimetric analyses as well as for pressure and vacuum filtration.

Diam. mm	Weight g / m ²	Filtration time secs.	PK	Cat. No.
47	84	100	100	6.239 206
55	84	100	100	7.300 360
70	84	100	100	7.300 358
90	84	100	100	7.079 463
100	84	100	100	7.079 766
110	84	100	100	7.079 472
125	84	100	100	7.079 380
150	84	100	100	7.077 523
185	84	100	100	6.206 309



Filtration/Glass-fibre filters

Glass microfibre filters

Glass microfibre filters have a fast filtration and a high loading capacity and particle retention rate. Manufactured without chemical binder from high grade borosilicate glass. (Exception: GF6, GF9). They are suitable for gravity or low suction filtration. Filtration speeds generally very much higher than conventional cellulose papers. Efficient retention of micron size particles. Must be used flat. Ideal for use in flat perforated plate Buchner type funnels (not sintered glass models). Can be used up to 500 °C

Wide range of applications including:

- retention of fine analytical precipitates
- retention of biochemical gelatinous precipitates
- water/air pollution analyses
- as prefilters for membranes
- scintillation counting
- radioimmunoassay.

1

1 LLG-Glass microfibre filters, filter circles

Diam. mm	Pore size µm	Filtration time secs.	Weight g / m ²	Thickness mm	PK	Cat. No.
25	1.6	60	52	0.26	100	9.045 860
37	1.6	60	52	0.26	100	7.970 790
47	1.6	60	52	0.26	100	9.045 861
55	1.6	60	52	0.26	100	6.242 633
90	1.6	60	52	0.26	100	6.252 072
110	1.6	60	52	0.26	100	7.970 339
125	1.6	60	52	0.26	100	7.970 033
150	1.6	60	52	0.26	100	9.045 862
25	1.2	100	52	0.26	100	9.045 865
47	1.2	100	52	0.26	100	6.243 711
55	1.2	100	52	0.26	100	6.251 383
70	1.2	100	52	0.26	100	9.045 866
90	1.2	100	52	0.26	100	9.045 867
110	1.2	100	52	0.26	100	9.045 868
47	0.7	310	75	0.45	100	7.970 106
55	0.7	310	75	0.45	100	7.970 742
70	0.7	310	75	0.45	100	6.253 553

Filtration velocity according to Herzberg

2

2 Pre-filters, glass microfibre, type 134

The standard glass fibre pre-filter, placed directly on top of the membrane filter. With acrylic latex binder (4 % to 6 %, determined by ashing).

Sartorius Lab Instruments

Type

- A: standard glass fiber filter
- B: extra thick glass fiber filter
- C: binder-free glass fiber filter

Diam. mm	Type	PK	Cat. No.
47	C	500	6.202 135
47	A	500	9.053 709
50	A	500	9.053 710
50	C	500	9.053 770
130	A	50	9.053 717

Other formats are available on request.

3

3 Glass microfibre filters, MGB/MGC/MGD/MGF/MG 550-HA

Suitable for analytical and gravimetric analyses, as well as a pre-filter.

Sartorius Lab Instruments

- Hydrophilic
- Liquid Filtration
- Non-sterile

Type	Diam. mm	Weight g / m ²	Thickness mm	Temp. max. °C	PK	Cat. No.
MGB	47	140	0.70	500	50	7.623 804
MGB	50	140	0.70	500	50	6.285 336
MGB	90	140	0.70	500	50	6.281 417
MGB	150	140	0.70	500	50	6.262 966
MGC	47	52	0.26	500	100	7.071 109
MGC	50	52	0.26	500	100	7.400 729
MGC	110	52	0.26	500	100	6.228 307

6. Distillation, separation, filtration Filtration/Glass-fibre filters

1 Glass microfibre filters, grade GF 6, circles

Whatman

Retention rate: 99.97 %
Filtration time according to Gurley: 40 s

Diam. mm	Filtration time secs.	Weight g / m ²	Thickness mm	PK	Cat. No.
55	200*	80	0.35	100	9.068 500
70	200*	80	0.35	100	9.068 501
90	200*	80	0.35	100	9.068 502
110	200*	80	0.35	100	9.068 503
125	200*	80	0.35	100	9.068 504
150	200*	80	0.35	100	9.068 505
185	200*	80	0.35	100	9.068 506
240	200*	80	0.35	100	9.068 507

* to Herzberg

1



2 Glass microfibre filters, grade GF/F

Whatman

This ultra-fine filter has a 98 % retention efficiency for particles as small as 0.7 µm in liquids.
Particle retention to 0.7 µm.

Diam. mm	PK	Cat. No.
24	100	9.056 666
25	100	9.056 676
42.5	100	9.056 716
47	100	9.056 726
55	100	9.056 780
70	100	9.056 781
90	25	9.056 782
110	25	9.056 783
125	25	9.056 784
150	25	9.056 785
257	25	9.056 787
570 x 460	25	9.056 805

2



3 Glass microfibre filters, grade GF/B

Whatman

Three times thicker and with greater wet strength than GF/A. Particle retention to 1 µm.
Supplied in pack quantities as outlined below.

Diam. mm	PK	Cat. No.
24	100	9.056 662
25	100	9.056 672
37	100	9.056 692
42.5	100	9.056 712
47	100	9.056 722
55	100	9.056 750
70	100	9.056 751
90	25	9.056 752
110	25	9.056 753
125	25	9.056 754
150	25	9.056 755
185	25	9.056 756
570 x 460	25	9.056 802

3



4 Glass microfibre filters, grade GF/C

Whatman

Extremely efficient filter made to retain fine particles and micro organisms.
Particle retention to 1.2 µm.

Diam. mm	PK	Cat. No.
21	100	9.056 643
24	100	9.056 663
25	100	9.056 673
37	100	9.056 693
42,5	100	9.056 713
47	100	9.056 723
50	100	9.056 759
55	100	9.056 760
70	100	9.056 761
90	100	9.056 762
100	100	6.240 479
110	100	9.056 763
125	100	9.056 764
150	100	9.056 765
203 x 254	100	6.287 413
254 x 102	50	9.056 816
570 x 460	25	9.056 803

4



Filtration/Glass-fibre filters

1



1 Glass fibre papers Type MN GF 3

MACHEREY-NAGEL

Specifications:

Thickness: 0.28 mm
 Weight: 50 g/m²
 Filtration time: 25 s
 Particle retention: 0.6 µm
 Temperature max.: 500 °C
 Binder: without

Diam. mm	PK	Cat. No.
25	100	4.000 602
37	100	4.000 603
45	100	4.000 604
55	100	4.000 605
70	100	6.072 986
90	100	6.203 996
110	100	6.203 327
125	100	4.000 606
150	100	7.400 610
185	100	4.000 607
240	100	4.000 608
270	100	4.000 609

2



2 Glass Fibre Papers Type MN 85/70

MACHEREY-NAGEL

Specifications:

Thickness: 0.35 mm
 Weight: 70 g/m²
 Filtration time: 15 s
 Particle retention: 0.6 µm
 Temperature max.: 200 °C
 Binder: organic

Diam. mm	PK	Cat. No.
55	100	6.230 315
70	100	4.000 557
90	100	7.078 750
110	100	6.222 839
125	100	7.059 804
150	100	6.226 331
185	100	4.000 558
240	100	6.226 332
270	100	4.000 559
320	100	4.000 560

3



3 Glass fFbre Papers Type MN 85/90

MACHEREY-NAGEL

Can be used up to a maximum of 200 °C. With organic binder.

Specifications

Thickness: 0.4 mm
 Weight: 90 g/m²
 Filtration time: 15 Sec.
 Particle retention: 0.5 µm

Diam. mm	PK	Cat. No.
25	100	4.000 566
37	100	7.058 316
45	100	7.400 141
47	100	6.309 953
55	100	9.049 600
70	100	9.049 601
90	100	9.049 602
110	100	9.049 603
125	100	9.049 604
150	100	9.049 605
185	100	9.049 606
240	100	9.049 607
270	100	4.000 567
320	100	4.000 568

6. Distillation, separation, filtration Filtration/Glass-fibre filters

1 Glass microfibre filters, grade 934-AH

Circles. High retention at high flow rates. Widely used in water pollution monitoring techniques for suspended solids, and is specified in US Method 934-AH. Particle retention to 1.5 µm.

Whatman

Diam. mm	PK	Cat. No.
24	100	9.056 667
47	100	9.056 727
55	100	9.056 730
70	100	9.056 731
90	100	9.056 732
110	100	9.056 733
125	100	9.056 734

1



2 Glass microfibre filters, grade GF/A

The general purpose high efficiency glass microfibre filter. Particle retention to 1.6 µm. Supplied in pack quantities as indicated.

Whatman

Diam. mm	PK	Cat. No.
21	100	9.056 641
24	100	9.056 661
25	100	9.056 671
37	100	9.056 691
42,5	100	9.056 711
47	100	9.056 721
50	100	9.056 725
55	100	9.056 740
60	100	9.056 739
70	100	9.056 741
81	100	6.256 482
90	100	9.056 742
110	100	9.056 743
125	100	9.056 744
150	100	9.056 745
254 x 203	100	9.056 811
570 x 460	25	9.056 801

2



3 Glass microfibre filters, grade GF/D

Thick filter made from less fibres and retaining around 3 µm particles with a very high loading capacity. Extremely high speed. Particle retention to 2.7 µm.

Whatman

Diam. mm	PK	Cat. No.
25	100	9.056 674
47	100	9.056 724
70	100	9.056 771
90	25	9.056 772
110	25	9.056 773
125	25	9.056 774
150	25	9.056 775
257	25	9.056 777

3



4 Quartz microfibre filters, grade QM-A

Manufactured from quartz microfibre to withstand high temperatures. Can be used up to 500 °C.

Whatman

Flow rate: Fast
Retention: Medium
Wet strength: High
Thickness: 0.475 mm

Diam. mm	PK	Cat. No.
25	100	9.056 679
37	100	9.056 699
47	100	9.056 729
55	100	9.056 790
90	100	6.205 852
203 x 254	25	9.056 814

4



Filtration/Glass-fibre filters



1 Glass fibre filters without binder

Recommended filters for controlling both air and water pollution.

Hahnemühle

- Made of 100 % borosilicate glass fibres without binders
- Extremely low content in alkali-earth metals
- Chemical stability: It keeps all its properties in contact with acid solutions (except hydrofluoric acid) and basic solutions at moderate concentrations
- Usable as a pre-filter for membranes to prevent the membranes from silting up
- Deposition of (radioactive) aerosols and monitoring of nuclear power plants
- Gravimetric analysis of organic and inorganic impurities in water and waste water according to DIN 38409 and EN 872 (suspended particles)
- Measurement of immission, measurement of dust in air and gases, monitoring of the efficiency of filtration and dedusting, monitoring the combustion air of power plants and of the steel and iron industry
- Measurement of dust release in workplace and production processes and the purification of compartment air
- Stability at high temperatures: It keeps its properties up to 500 °C
- High flow speed and high permeability to air

Type	Dimensions mm	Weight g / m ²	Filtration time secs.	Thickness mm	PK	Cat. No.
GF50	Ø 25	56	19	0.29	100	4.006 614
GF50	Ø 37	56	19	0.29	100	4.006 615
GF50	Ø 47	56	19	0.29	100	4.006 617
GF50	Ø 70	56	19	0.29	100	4.006 620
GF50	Ø 90	56	19	0.29	100	4.006 622
GF50	Ø 125	56	19	0.29	100	4.006 625
GF50	203 x 254	56	19	0.29	100	4.006 627
GF51	Ø 47	140	44	1.00	100	4.006 630
GF52	Ø 47	54	25	0.28	100	4.006 640
GF52	Ø 50	54	25	0.28	100	4.006 641
GF52	Ø 70	54	25	0.28	100	4.006 643
GF52	Ø 90	54	25	0.28	100	4.006 644
GF52	Ø 110	54	25	0.28	100	4.006 645
GF55	Ø 47	75	67	0.40	100	4.006 661
GF55	60 x 90	75	67	0.40	300	6.292 106

Filtration time acc. to Gurley



2 Fibre Filters with inorganic binder

Recommended filters for environmental analysis and controlling both air and water pollution.

Hahnemühle

- Made of 100 % borosilicate glass fibres with binders
- Glass fibre filters capture fine particles down to 1 µm from liquids, in air, gases and aerosols with even 0.3 to 0.5 µm being absorbed
- Extremely low content in alkali-earth metals
- Chemical stability: It keeps all its properties in contact with acid solutions (except hydrofluoric acid) and basic solutions at moderate concentrations
- Stable at temperatures up to 500 °C
- Gravimetric analysis of organic and inorganic impurities in water and waste water according to DIN 38409 and EN 872 (suspended particles)
- Measurement of immission, measurement of dust in air and gases, monitoring of the efficiency of filtration and dedusting, monitoring the combustion air of power plants and of the steel and iron industry
- Measurement of dust release in workplace and production processes and the purification of compartment air
- Measurement of scintillation

Type	Diam. mm	Weight g / m ²	Filtration time secs.	Thickness mm	PK	Cat. No.
GF 6	25	80	40	0.35	100	4.006 668
GF 6	47	80	40	0.35	100	4.006 671
GF 6	50	80	40	0.35	100	4.006 672
GF 6	55	80	40	0.35	100	4.006 673
GF 6	70	80	40	0.35	100	4.006 674
GF 6	90	80	40	0.35	100	4.006 675
GF 6	100	80	40	0.35	100	4.006 676
GF 6	125	80	40	0.35	100	4.006 678
GF 6	150	80	40	0.35	100	4.006 679
GF 6	185	80	40	0.35	100	4.006 680
GF 8	55	75	12	0.35	100	4.006 684
GF 9	50	70	27	0.35	100	4.006 690
GF 9	90	70	27	0.35	100	4.006 693

Filtration time acc. to Gurley

1 2 Membrane Filters Microsart™ e.motion

The membrane filters suitable for use in the Microsart™ e.motion are individually sterile-sealed, without protective paper on top of each filter, in a specially designed individual package on a band. For complete traceability, the membrane filter type, diameter, lot number and a unique serial number are printed on the package of each membrane filter unit. Specially developed pore structures of the 0.45 µm high Flow membrane filters permit faster filtration based on their high flow rates and throughputs.

Sartorius Lab Instruments

All Microsart membrane filters are "multi-fit" and can be used in all standard dispenser systems.

The membrane filters have a diameter of 47 mm or 50 mm, and are white, green or grey with a high-contrast 3.1 mm grid.



H phrases: H228

Pore size µm	Colour	Diam. mm	PK	Cat. No.
0,45 High Flow	white/black	50	300	6.286 804
0,45 High Flow	white/black	47	300	9.054 050
0,45 High Flow	white/green	47	300	9.054 051
0,45	white/black	47	300	9.054 052
0,45	white/black	50	300	9.054 053
0,45	grey/white	47	300	9.054 054
0,45	grey/white	50	300	9.054 055
0,45	green/dark green	47	300	9.054 056
0,45	green/dark green	50	300	9.054 057
0,45	white/green	47	300	9.054 058
0,45	white/green	50	300	9.054 059
0,65	grey/white	47	300	9.054 060
0,65	grey/white	50	300	9.054 061
0,8	grey/white	47	300	9.054 062
0,8	grey/white	50	300	9.054 063



3 Membrane filters, Grade TE, PTFE with support

3



Whatman

Applications:

- Ideal venting filter for all applications
- For aggressive media and cryogenic liquids
- Separation of free water from organic solutions
- Outstanding as gas/liquid barrier
- Filtration of air and (hot) gases

Properties:

- Chemically inert to aqueous and organic solutions as well as concentrated acids and bases
- Hydrophobic - for aqueous filtration the pressure must be higher than the water breakthrough pressure
- Can be used up to 145 °C
- Can be sterilised by all methods except gamma radiation

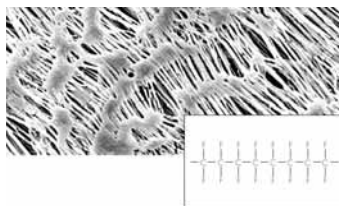

Type	Diam. mm	Pore size µm	PK	Cat. No.
TE 35	25	0.20	50	9.058 682
TE 35	47	0.20	50	9.058 683
TE 35	50	0.20	50	9.058 684
TE 36	47	0.45	50	9.058 663
TE 36	50	0.45	50	9.058 664
TE 37	25	1.00	50	9.058 642
TE 37	47	1.00	50	9.058 643
TE 37	50	1.00	50	9.058 644
TE 38	47	5.00	50	9.058 623
TE 38	50	5.00	50	9.058 624

1

1 Membranfilter, hydrophob, PTFE
Sartorius Lab Instruments

White. For the filtration of air and gases, as well as the filtration of solvents and acids.

- Good chemical resistance
- Autoclavable
- Non-sterile

Diam. mm	Pore size µm	PK	Cat. No.
13	0.20	100	9.054 361
25	0.20	100	9.054 364
47	0.20	100	9.054 368
50	0.20	100	9.054 369
142	0.20	25	9.054 373
13	0.45	100	9.054 341
25	0.45	100	9.054 344
47	0.45	100	9.054 348
90	0.45	25	9.054 351
100	0.45	25	9.054 352
142	0.45	25	9.054 353
293	0.45	25	9.054 358
13	1.20	100	9.054 321
25	1.20	100	9.054 324
47	1.20	100	9.054 328
50	1.20	100	9.054 329
100	1.20	25	9.054 332
142	1.20	25	9.054 335
25	5.00	100	9.054 304
47	5.00	100	9.054 308
50	5.00	100	9.054 309
100	5.00	25	9.054 312
142	5.00	25	9.054 315

2

2 Membrane filters, inorganic, Anodisc®
Whatman

Material: Anopore®. White.

The inorganic membrane Anopore® consists of high-purity aluminium oxide and can be used for a wide range of applications. The unique material has a precise, non-deformable honeycomb structure with a narrow pore size distribution range that guarantees very efficient particle retention. In addition, the membrane has a low protein binding capacity, minimal autofluorescence, is non-toxic and supports cellular growth.

Diam. mm	Pore size µm	PK	Cat. No.
13	0.02	100	9.951 034
25	0.02	50	9.951 035
47	0.02	50	7.604 787
13	0.10	100	9.951 036
25	0.10	50	6.235 017
47	0.10	50	9.951 038
13	0.20	100	9.951 039
25	0.20	50	9.951 040
47	0.20	50	9.951 041

3

3 Membrane filters, Nylon
Whatman

Hydrophilic, durable and compatible with a wide range of aqueous solutions, organic solvents and for the filtration of biological preparations and media. Autoclavable at 121 °C.

Diam. mm	Pore size µm	PK	Cat. No.
13	0.20	100	9.951 042
13	0.45	100	9.951 045
25	0.45	100	9.951 046
47	0.20	100	9.951 043
47	0.80	100	9.951 049
47	0.45	100	9.951 047
90	0.20	50	9.951 044
90	0.45	50	9.951 048

1 Nuclepore® membrane filter, PC



Whatman

- Hydrophilic, low protein binding
- Smooth surface for easy identification of particles
- Highly resistant to chemicals and good thermal stability
- Autoclavable up to 121 °C

Applications: Ideal for environmental and water analysis.

Diam. mm	Pore size µm	PK	Cat. No.
25	0.20	100	7.050 391
25	0.40	100	7.052 016
25	0.80	100	6.314 452
47	0.05	100	6.902 504
47	0.20	100	6.312 964
47	0.40	100	6.313 989

Further products can be found in our online shop.



2 Membrane filters, blotting, Polycarbonate



Sartorius Lab Instruments

Type 230. Polycarbonate (PC), white, non-sterile. Ultrapure, polycarbonate membrane with especially smooth surface and fine pore distribution. Applications include COD/TOC testing, particle analysis or epifluorescence microscopy.

Diam. mm	Pore size µm	PK	Cat. No.
25	0.4	100	9.049 182
47	0.4	100	9.049 183
25	0.2	100	9.049 180
47	0.2	100	9.049 181
50	0.2	100	7.511 100

Other patterns are available on request.



3 Membrane Filters, Grade RC, Regenerated cellulose



Whatman

- spontaneously wetted, very good wet-strength
- high chemical resistance, useful for aqueous and organic media
- hydrophilic
- can be used up to 180 °C
- sterilisable by all methods
- suitable for use as sterile filter to ASTM-D 3862-80

Application: For the sterilisation and particle filtration of aqueous and organic solutions

Type	Diam. mm	Pore size µm	PK	Cat. No.
RC 55	25	0.45	100	9.057 785
RC 55	47	0.45	100	9.057 791
RC 55	50	0.45	100	9.057 792
RC 55	100	0.45	25	9.057 795
RC 55	110	0.45	25	6.234 997
RC 55	142	0.45	25	9.057 798
RC 58	47	0.20	100	9.057 771
RC 58	50	0.20	100	9.057 772
RC 60	50	1.00	100	9.057 712

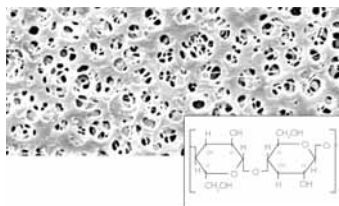

1

1 Membrane filters, regenerated cellulose

Sartorius Lab Instruments



The very low adsorption membranes are hydrophilic, solvent-resistant (pH 3-12) and therefore suitable for the particle removal from solvents.

Diam. mm	Pore size µm	Sterile	PK	Cat. No.
13	0.20	-	100	9.053 161
13	0.45	-	100	9.053 141
25	0.20	-	100	9.053 164
25	0.45	-	100	9.053 144
47	0.20	-	100	9.053 168
47	0.45	-	100	9.053 148
50	0.20	-	100	9.053 169
50	0.45	-	100	9.053 149
50	0.45	+	100	6.265 977
100	0.20	-	25	9.053 172
100	0.45	-	25	9.053 152
142	0.20	-	25	9.053 175
142	0.45	-	25	9.053 155
293	0.20	-	25	9.053 177
293	0.45	-	25	9.053 157

2

2 Membrane filters, cellulose acetate

Sartorius Lab Instruments



Type 111. Resistant to steam sterilisation up to 134 °C, or in dry heat up to 180 °C. Very low adsorption (important when filtering proteinaceous solutions). Suitable for particle removal and ultracleaning of aqueous solutions, methanol, ethanol, high-grade alcohols and residue analysis of fuels and oils. The extractable content of these filters make up <1 % of their weight. Other pore sizes and formats available on request.

Diam. mm	Pore size µm	PK	Cat. No.
25	0.20	100	9.053 064
25	0.45	100	9.053 044
47	0.20	100	9.053 068
47	0.45	100	9.053 048
47	0.65	100	9.053 028
50	0.20	100	9.053 069
50	0.45	100	9.053 049
142	0.20	25	9.053 075
142	0.45	25	9.053 055
142	1.20	25	9.053 195
142	5.00	25	7.017 726
293	1.20	25	9.053 197

Other patterns are available on request.

Membrane filters, Grade OE, made from cellulose acetate

Whatman



Very high wet strength and very low ability for protein binding. For filtration of aqueous, alcohol and oil-based solutions at temperatures up to 180 °C.

Description	Diam. mm	Pore size µm	PK	Cat. No.
OE 67	25	0.45	100	9.057 565
OE 67	47	0.45	100	9.057 571
OE 67	50	0.45	100	9.057 572
OE 67	142	0.45	25	9.057 578
OE 66	25	0.20	100	9.057 605
OE 66	47	0.20	100	9.057 611
OE 66	50	0.20	100	9.057 612
OE 66	142	0.20	25	9.057 618

1 Membrane filters, Grade ME, mixed cellulose esters, Grade ME

Whatman

Applications:

For microbiological analysis (sterile with grid)

Properties:0.45 µm pore size, 100 % microbe retention of *Serratia marcescens*

1.2 µm pore size for microbiological control of yeasts

**Warning**

H phrases: H228

Description	Pore size µm	Diam. mm	PK	Cat. No.
ME 25/21 ST	0.45	50	100	9.058 179
ME 24/21 ST	0.2	47	100	9.058 199
ME 24/21 ST	0.2	50	100	9.058 200

1



2 Membrane filters, Grade ME, made from mixed cellulose esters

Whatman

**Applications:**

- Excellent for gravimetric analysis
- Especially for aqueous solutions
- Ideally suitable for contamination test

Properties:

- Economical
- Constant weight
- Hydrophilic
- Not sterile
- Can be used up to 125 °C
- Autoclavable up to 121 °C

**Warning**

H phrases: H228

Type	Diam. mm	Pore size µm	PK	Cat. No.
ME24	25	0.20	100	9.058 965
ME24	47	0.20	100	9.058 969
ME24	50	0.20	100	9.058 987
ME24	142	0.20	25	9.058 981
ME25	25	0.45	100	9.058 935
ME25	47	0.45	100	9.058 939
ME25	50	0.45	100	9.058 942
ME25	100	0.45	50	9.058 946
ME25	110	0.45	50	9.057 812
ME25	142	0.45	25	9.058 951
ME27	25	0.80	100	9.058 865
ME27	47	0.80	100	9.058 869
ME27	50	0.80	100	9.058 872
ME28	47	1.20	100	9.058 839
ME28	50	1.20	100	9.058 842
ME29	25	3.00	100	9.057 800
ME29	47	3.00	100	9.058 809
ME29	50	3.00	100	9.058 812

2

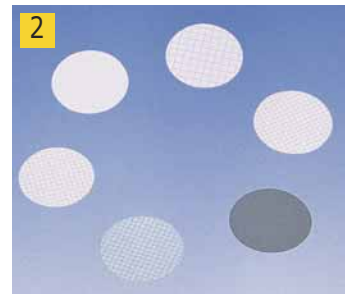

3 Membrane filters, Cellulose mixed ester

Whatman



Composed of cellulose acetate (~20 %) and cellulose nitrate (~80 %).

**Danger**

H phrases: H228

Type	Diam. mm	Pore size µm	PK	Cat. No.
Gridded white	47	0.45	100	9.951 016
Gridded white	25	0.80	100	9.951 018

3



Filtration/Membrane filters

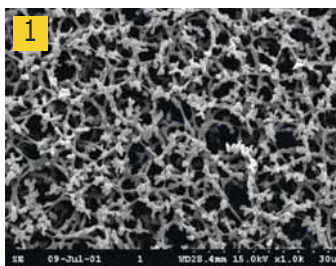

1 Membrane filters, Grade NC, made from cellulose nitrate

Whatman



Applications:

- For prefiltration and dust measurement, clarification and sterile filtration
- For aqueous solutions

Properties:

- Very easily wetted
- Hydrophilic
- Can be used up to 125 °C
- Autoclavable up to 121 °C



Warning

H phrases: H228

Type	Diam. mm	Pore size µm	PK	Cat. No.
NC 10	47	0.10	100	9.057 341
NC 10	50	0.10	100	9.057 342
NC 20	47	0.20	100	9.058 327
NC 20	50	0.20	100	9.058 328
NC 45	25	0.45	100	9.057 219
NC 45	47	0.45	100	9.057 220
NC 45	50	0.45	100	9.057 222
NC 45	100	0.45	50	9.057 225
NC 45	110	0.45	50	9.057 226
NC 45	142	0.45	25	9.057 228

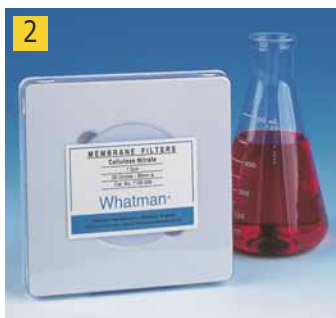

2 Membrane Filters, Cellulose nitrate, WCN

Whatman



Plain white. Circles.

Application

- For prefiltration and dust measurement, clarification and filtration
- Filtration of aqueous solutions

Properties

- Very easily wettable
- Hydrophilic
- Used up to 125 °C
- Autoclavable (121 °C)



Warning

H phrases: H228

Diam. mm	Pore size µm	PK	Cat. No.
25	0.10	100	9.950 979
47	0.10	100	9.950 980
13	0.20	100	9.950 981
25	0.20	100	9.950 982
47	0.20	100	9.950 983
90	0.20	25	9.950 984
142	0.20	25	9.950 985
13	0.45	100	9.950 988
25	0.45	100	9.950 989
47	0.45	100	9.950 991
50	0.45	100	9.950 992
90	0.45	25	9.950 994
142	0.45	25	9.950 995
47	0.65	100	9.950 998
25	0.80	100	9.951 001
37	0.80	100	9.951 002
47	0.80	100	9.951 003
90	0.80	25	9.951 004
25	1.00	100	9.951 005
47	1.00	100	9.951 006
50	1.20	100	9.951 008
142	1.20	25	9.951 009
25	3.00	100	9.951 010
47	3.00	100	9.951 011
25	5.00	100	9.951 012
47	5.00	100	9.951 013
90	5.00	25	9.951 014

1 Membrane filters type 113, cellulose nitrate



Sartorius Lab Instruments

White. Very low content of extractable materials. Weight constant after 60 minutes of drying at 105 °C. Suitable for residue analysis, microscopic viewing in incident or transmitted light, chemotaxis, x-ray fluorescence, spectrometry and gravimetric analysis. Autoclavable at 121 °C. Other pore sizes and formats are available on request.



H phrases: H228

1



Diam. mm	Pore size µm	PK	Cat. No.
25	8.00	100	9.053 304
25	1.20	100	9.053 364
25	0.80	100	9.053 384
25	0.45	100	9.053 424
47	8.00	100	9.053 308
47	1.20	100	9.053 368
47	0.80	100	9.053 388
47	0.45	100	9.053 428
50	8.00	100	9.053 309
50	3.00	100	9.053 349
50	1.20	100	9.053 369
50	0.80	100	9.053 389
50	5.00	100	9.053 329
50	0.45	100	9.053 429

Other patterns are available on request.

2 Membrane filters type 113, cellulose nitrate



Sartorius Lab Instruments

White. Very low content of extractable materials. Weight constant after 60 minutes of drying at 105 °C. Suitable for residue analysis, microscopic viewing in incident or transmitted light, chemotaxis, x-ray fluorescence, spectrometry and gravimetric analysis. Autoclavable at 121 °C. Other pore sizes and formats are available on request.



H phrases: H228

2



Ø mm	Pore size µm	PK	Cat. No.
90	0.45	25	9.053 431
100	1.20	25	9.053 372
142	5.00	25	9.053 335
142	5.00	100	7.017 720
142	0.45	25	9.053 432

Other patterns are available on request.

We can supply this
manufacturer's
whole
product range !



SARTORIUS

Filtration/Membrane filters

1



1 2 Membrane filters, type 114, cellulose nitrate

White membrane with black grid, for detection of bacteria with dyed media, particle count & microscopy, individually, sterile packaged/non sterile.

Sartorius Lab Instruments



H phrases: H228

Diam. mm	Pore size µm	Sterile	PK	Cat. No.
25	0.80	-	100	9.054 014
47*	0.45	+	100	6.234 545
47	0.20	+	300	6.267 187
50	1.20	+	100	6.285 272
47	1.20	+	1000	7.017 045
47	0.80	+	1000	7.017 048
50	0.80	+	100	7.017 049
50	0.45	-	1000	7.017 052
50	0.45	+	1000	7.017 053
50	0.20	+	1000	7.075 961
47	0.20	+	1000	7.078 912
47	1.20	+	100	9.054 002
47	1.20	-	100	9.054 008
50	1.20	-	100	9.054 009
47	0.80	+	100	9.054 012
47	0.80	-	100	9.054 018
50	0.80	-	100	9.054 019
47	0.65	+	100	9.054 022
50	0.65	+	100	9.054 023
47	0.65	-	100	9.054 028
47	0.45	+	100	9.054 032
50	0.45	+	100	9.054 033
25	0.45	-	100	9.054 034
47	0.45	-	100	9.054 038
50	0.45	-	100	9.054 039
47	0.20	+	100	9.054 042
50	0.20	+	100	9.054 043
25	0.20	-	100	9.054 044
47	0.20	-	100	9.054 048
50	0.20	-	100	9.054 049

* High flow.

2



3

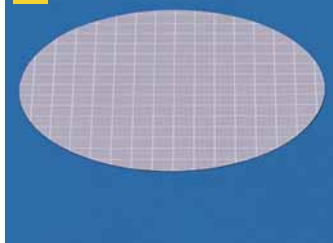

3 Membrane filters Type 130, cellulose nitrate

Gray membrane (after wetting, black) with white grid, for detection of yeasts and molds, particle count and microscopy, individually, sterile packaged/non sterile.

Sartorius Lab Instruments



H phrases: H228

Diam. mm	Pore size µm	Sterile	PK	Cat. No.
50	0.65	+	1000	7.017 078
47 for SMART Filter Dispenser	0.45	+	3	7.054 644
47	0.65	+	100	9.054 122
47	0.45	+	100	9.054 132
50	0.45	+	100	9.054 133
50	0.45	-	100	9.054 139

Other types available on request.

4



4 Membrane filters, type 139, cellulose nitrate

White membrane with green grid, for detection of bacteria with dyed media, particle count and microscopy, individually, sterile packaged/non sterile.

Sartorius Lab Instruments



H phrases: H228

Diam. mm	Pore size µm	Sterile	PK	Cat. No.
47	1.20	+	100	7.200 435
47	0.45	+	100	9.054 460
50	0.45	+	100	9.054 462
47*	0.45	+	100	9.054 464
50*	0.45	+	100	9.054 465

* High flow.

1 LLG-Syringe Filters SPHEROS

Cost-effective syringe filters for filtration of a broad variety of solvents and aqueous or inorganic solutions. These syringe filters cover most applications in HPLC, pharmaceutical, environmental, biotechnology, and food and beverage testing laboratories.

- Robust Polypropylene housing
- Multifunctional syringe filters with female Luer-Lock inlet and male Luer-Slip outlet
- Suitable for all syringes with Luer connection
- Sterile or non-sterile
- Sterile products in individual hard blister packaging and dispenser box



1

2 3 LLG Syringe Filters SPHEROS, Cellulose Acetate

Hydrophilic membrane for filtration of aqueous liquids. Low protein binding capacity. Especially suitable for biological macromolecules, water soluble oligomers and polymers. With female Luer-Lock inlet and male Luer-Slip outlet. Sterile products in individual hard blister packaging and dispenser box.

Filter diam.	Pore size	Housing	Sterile	PK	Cat. No.
mm	µm				
13	0.22	PP, red	-	100	6.272 802
13	0.45	PP, red	-	100	6.272 803
25	0.22	PP, red	-	50	6.272 804
25	0.22	PP, red	-	500	4.668 145
25	0.45	PP, red	-	50	6.272 805
25	0.45	PP, red	-	500	4.668 146
13	0.22	PP, red	+	100	6.272 806
13	0.45	PP, red	+	100	6.272 807
25	0.22	PP, red	+	45	6.272 808
25	0.45	PP, red	+	45	6.272 809

2



3



4 LLG Syringe Filters SPHEROS, PES

Hydrophilic membrane for aqueous and polar organic solutions with low protein binding capacity. Especially suited for sterile filtration of solutions and media in cell culture as well as for ion chromatography and organic acids. With female Luer-Lock inlet and male Luer-Slip outlet. Sterile filters individually packed in a hard blister package.

Filter diam.	Pore size	Housing	Sterile	PK	Cat. No.
mm	µm				
25	0.22	PP, green	-	50	6.272 640
25	0.45	PP, green	-	50	6.272 641
25	0.22	PP, green	+	45	6.272 642
25	0.45	PP, green	+	45	6.272 643

4



5 LLG Syringe Filters SPHEROS, Nylon

Hydrophilic membrane for filtration of aqueous and organic/aqueous liquids with medium polarity. Very good chemical resistance to esters, alkaline solutions and alcohols. With female Luer-Lock inlet and male Luer-Slip outlet.

Filter diam.	Pore size	Housing	Sterile	PK	Cat. No.
mm	µm				
13	0.22	PP, pink	-	100	6.272 810
13	0.45	PP, pink	-	100	6.272 811
25	0.22	PP, pink	-	50	6.272 812
25	0.22	PP, pink	-	500	4.668 147
25	0.45	PP, pink	-	50	6.272 813
25	0.45	PP, pink	-	500	4.668 148

5



6 LLG Syringe Filters SPHEROS, PTFE

Hydrophobic membrane for filtration of non-polar liquids and gases. Very good chemical resistance to all kinds of solvents and alkaline solutions. With female Luer-Lock inlet and male Luer-Slip outlet.

Filter diam.	Pore size	Housing	Sterile	PK	Cat. No.
mm	µm				
13	0.22	PP, white	-	100	6.272 816
13	0.45	PP, white	-	100	6.272 817
25	0.22	PP, white	-	50	6.272 818
25	0.22	PP, white	-	500	4.668 149
25	0.45	PP, white	-	50	6.272 819
25	0.45	PP, white	-	500	4.668 150

6



LLG-Syringe Filters

We offer a line of syringe filters especially designed to provide efficient filtration of a broad variety of fluids, solvents, aqueous or inorganic solutions. Our syringe filters cover most applications in HPLC, pharmaceutical, environmental, biotechnology and food and beverage testing laboratories.

- Housing injected in Polypropylene or MABS
- Multifunctional Syringe filters equipped with Luer-Lock connections on both sides or female Luer-Lock input and male Luer-Slip output
- Suitable for all syringes with Luer connection
- Pre-sterilised or non-sterile
- Sterile products in individual hard blister
- Superior pressure stability

1

1 2 3 LLG Syringe Filter CA, Cellulose acetate

Hydrophilic membrane for filtration of aqueous solutions.

This membrane features excellent shape stability in aqueous solutions and a very low binding capacity for proteins (21 µg per 25 mm Filter). Ideal for use with biological macromolecules, water soluble oligomers and polymers. With Luer-Lock input and Luer-Lock or Luer-Slip output.

2

Type	Filter diam.	Pore size	Housing	PK	Cat. No.
	mm	µm			
non sterile	13	0.20	Acrylic, blue	500	9.055 500
non sterile	13	0.45	Acrylic, yellow	500	9.055 502
non sterile	13	0.80	Acrylic, green	500	9.055 504
non sterile	25	0.20	Acrylic, blue	500	9.055 501
non sterile	25	0.45	Acrylic, yellow	500	9.055 503
non sterile	25	0.80	Acrylic, green	500	7.970 389
sterile	13	0.20	Acrylic, blue	50	9.055 510
sterile	13	0.45	Acrylic, yellow	50	9.055 512
sterile	13	0.80	Acrylic, green	50	6.285 694
sterile	25	0.20	Acrylic, blue	50	9.055 511
sterile	25	0.45	Acrylic, yellow	50	9.055 513
sterile	25	0.80	Acrylic, green	50	6.285 699
sterile	25	0.20	Acrylic, transparent*	50	6.285 703
sterile	25	0.45	Acrylic, transparent*	50	6.285 704
sterile	25	0.80	Acrylic, transparent*	50	6.285 705

*Luer-Slip output

3

4

4 LLG Syringe Filter NY, Nylon/Polyamide

This is a rather hydrophilic membrane; it is recommended for filtration of aqueous and organic/aqueous medium polar liquids. Excellent chemical compatibility with esters, bases and alcohols. With Luer-Lock input and Luer-Slip output.

Type	Filter diam.	Pore size	Housing	PK	Cat. No.
	mm	µm			
non sterile	13	0.22	PP	500	9.055 520
non sterile	13	0.45	PP	500	9.055 522
non sterile	25	0.22	PP	500	9.055 521
non sterile	25	0.45	PP	500	9.055 523
sterile	25	0.22	Acrylic	50	6.285 707
sterile	25	0.45	Acrylic	50	6.285 708

5

5 LLG Syringe Filter PE, Polyethylene

Universal filter membrane for all analytical requirements. For aqueous and aggressive organic solvent filtration. Wide application in sample preparation, Ion chromatography. With Luer-Lock input and Luer-Slip output.

Type	Filter diam.	Pore size	Housing	PK	Cat. No.
	mm	µm			
non sterile	13	0.2	PP	500	9.055 540
non sterile	13	0.5	PP	500	9.055 542
non sterile	25	0.2	PP	500	9.055 541
non sterile	25	0.5	PP	500	9.055 543

1 LLG Syringe Filter RC, Regenerated cellulose

Hydrophilic membrane features very low adsorption. It is recommended for filtration of aqueous and organic/aqueous liquids. For filtration of polar and medium polar liquids. With Luer-Lock input and Luer-Slip output.

Type	Filter diam.	Pore size	Housing	PK	Cat. No.
	mm	µm			
non sterile	13	0.20	PP	500	9.055 530
non sterile	13	0.45	PP	500	9.055 532
non sterile	25	0.20	PP	500	9.055 531
non sterile	25	0.45	PP	500	9.055 533



2 LLG Syringe Filter PTFE, Polytetrafluorethylene

Hydrophobic membrane. Ideal for filtration of non-polar liquids and gases. It is very resistant to various solvents as well as acids and bases. With Luer-Lock input and Luer-Slip output.

Type	Filter diam.	Pore size	Housing	PK	Cat. No.
	mm	µm			
non sterile	13	0.20	PP	500	7.970 402
non sterile	13	0.45	PP	500	7.970 385
non sterile	25	0.20	PP	500	9.055 535
non sterile	25	0.45	PP	500	6.255 331



3 LLG Syringe Filter PVDF, Polyvinylidene fluoride

Hydrophilic membrane for aqueous polar and light unpolar solutions. Very low protein binding High flow rates ideal for use with biological macromolecules, water soluble oligomers and polymers. With Luer-Lock input and Luer-Slip output.

Type	Filter diam.	Pore size	Housing	PK	Cat. No.
	mm	µm			
non sterile	13	0.20	PP	500	7.970 258
non sterile	13	0.45	PP	500	9.055 534
non sterile	25	0.20	PP	500	7.970 387
non sterile	25	0.45	PP	500	7.970 286
sterile	13	0.20	Acrylic	50	6.285 697
sterile	13	0.45	Acrylic	50	6.285 698
sterile	25	0.20	Acrylic	50	6.258 299
sterile	25	0.45	Acrylic	50	6.285 702



4 LLG Syringe Filter GF, Glass-fibre

Hydrophilic membrane suitable for pre-filtration. They can be used for solutions with high particulate loads or for highly viscous solutions (e.g. soil samples, fermentation broths) either alone or in combination with other filters. With Luer-Lock input and Luer-Slip output.

Type	Filter diam.	Pore size	Housing	PK	Cat. No.
	mm	µm			
non sterile	25	0.7	PP	500	9.055 550
non sterile	25	1.0	PP	500	9.055 551
non sterile	25	1.2	PP	500	9.055 552
non sterile	25	3.1	PP	500	9.055 553



5 Syringe filters Puradisc™ PTFE

Hydrophobic membrane. Ideal for filtration of non-polar liquids and gases.

Whatman

Type	Filter diam.	Pore size	Housing	PK	Cat. No.
	mm	µm			
non sterile	4	0.20	PP	100	9.951 252
non sterile	4	0.45	PP	100	9.951 253
non sterile	13	0.10	PP	100	9.951 255
non sterile	13	0.20	PP	100	9.951 256
non sterile	13	0.20	PP w. tip	50	9.951 249
non sterile	13	0.45	PP	100	9.951 257
non sterile	13	0.45	PP w. tip	50	9.951 250
non sterile	13	1.00	PP	100	9.951 258
non sterile	25	0.20	PP	50	9.951 069
non sterile	25	0.20	PP	200	9.951 070
non sterile	25	0.45	PP	50	9.951 071
non sterile	25	0.45	PP	200	9.951 072
non sterile	25	1.00	PP	50	9.951 073



Filtration/Syringe filters

1

1 Syringe filters Puradisc™ Nylon

Hydrophilic membrane; it is recommended for filtration of aqueous and organic/aqueous medium polar liquids.

Whatman

Type	Filter diam.	Pore size	Housing	PK	Cat. No.
	mm	µm			
non sterile	4	0.20	PP	100	9.951 265
non sterile	4	0.45	PP	100	9.951 266
non sterile	13	0.20	PP	100	9.951 268
non sterile	13	0.45	PP	100	9.951 269
non sterile	25	0.20	PP	50	9.951 065
non sterile	25	0.20	PP	200	9.951 066
non sterile	25	0.45	PP	50	9.951 067
non sterile	25	0.45	PP	200	9.951 068
sterile	4	0.20	PP	50	9.951 264

2

2 Syringe filters Puradisc™ Polyethersulfone (PES)

Hydrophilic membrane for aqueous and light organic solutions with a low binding capacity for proteins.

Whatman

Type	Filter diam.	Pore size	Housing	PK	Cat. No.
	mm	µm			
non sterile	13	0.20	PP	100	9.951 239
non sterile	13	0.45	PP	100	9.951 241
non sterile	25	0.20	PP	200	9.951 063
non sterile	25	0.45	PP	200	9.951 064
sterile	13	0.20	PP	50	9.951 238
sterile	13	0.45	PP	50	9.951 240
sterile	25	0.20	PP	50	9.951 061
sterile	25	0.45	PP	50	9.951 062

3

3 Syringe filters Puradisc™ Polypropylene

Suitable for HPLC sample filtration (water-based) and aggressive water solutions such as acids and alkalis.

Whatman

Type	Filter diam.	Pore size	Housing	PK	Cat. No.
	mm	µm			
non sterile	13	0.20	PP	100	9.951 245
non sterile	13	0.45	PP	100	9.951 246
non sterile	25	0.20	PP	50	9.951 074
non sterile	25	0.20	PP	200	9.951 075
non sterile	25	0.45	PP	50	9.951 076
non sterile	25	0.45	PP	200	9.951 077

4

4 Syringe filters Puradisc™ FP30

For aqueous solutions. Polycarbonate (PC) housing. Membrane cellulose nitrate (CN) or cellulose acetate (CA). Filtration of protein-containing solutions with minimal sample loss.

Whatman

Type	Filter diam.	Pore size	Housing	Membrane	PK	Cat. No.
	mm	µm				
non sterile	30	0.20	PC	CA	50	9.049 934
non sterile	30	0.20	PC	CA	100	9.603 585
non sterile	30	0.20	PC	CA	500	9.603 584
non sterile	30	0.20	PC*	CA	500	9.049 919
non sterile	30	0.45	PC	CA	50	9.049 932
non sterile	30	0.45	PC	CA	100	9.049 927
non sterile	30	0.45	PC	CA	500	9.049 933
non sterile	30	0.80	PC	CA	50	9.049 936
non sterile	30	0.80	PC	CA	500	9.049 920
non sterile	30	1.20	PC	CA	50	9.049 937
non sterile	30	1.20	PC	CA	500	9.049 925
non sterile	30	5.00	PC	CN	50	9.049 931
non sterile	30	5.00	PC	CN	100	9.049 926
non sterile	30	5.00	PC	CN	500	9.603 581
sterile	30	0.20	PC	CA	50	9.049 913
sterile	30	0.20	PC*	CA	50	9.049 917
sterile	30	0.45	PC	CA	50	9.049 912
sterile	30	0.80	PC	CA	50	9.049 915
sterile	30	1.20	PC	CA	50	9.049 916
sterile	30	5.00	PC	CN	50	9.049 911
sterile	30	0.20	PC	PTFE	50	9.049 918

* with Luer-Lock outlet

1 2 Syringe filters GD/X®

Whatman GD/X syringe filters are the perfect solution for samples with high viscosity or samples that contain particles. Four filter layers decrease clogging and therefore filter exchange during processing is avoided. These filters allow 3 to 7 times higher throughput than traditional types.

Whatman

Type	Filter diam.	Pore size	Housing	Membrane	PK	Cat. No.
	mm	µm				
non sterile	25	0.20	PP	Nylon	150	9.056 820
non sterile	25	0.45	PP	Nylon	150	9.056 821
non sterile	13	0.20	PP	PVDF	150	6.283 543
non sterile	25	0.20	PP	PVDF	150	9.056 822
non sterile	25	0.45	PP	PVDF	150	9.056 823
non sterile	25	0.20	PP	RC	150	9.056 807
non sterile	25	0.45	PP	RC	150	9.056 809
non sterile	25	0.45	PP	RC	1500	9.056 810
non sterile	25	0.20	PP	PTFE	150	6.073 051
non sterile	25	0.45	PP	PTFE	150	6.204 535
non sterile	13	0.20	PP	CA	150	6.225 246
non sterile	13	0.45	PP	CA	150	7.632 839
non sterile	25	0.20	PP	CA	150	7.630 830
non sterile	25	0.45	PP	CA	150	6.800 153

1



2



3 Inorganic membrane syringe filters, Anotop®

The Anopore® inorganic membrane consists of high-purity aluminium oxide and can be used for a wide range of applications. This unique material has a precise, non-deformable, honeycomb structure with a relatively consistent pore size that guarantees very efficient particle retention. In addition, the membrane has a low protein binding capacity, minimal autofluorescence, is non-toxic and supports cellular growth.

Whatman

- Anotop® 10 Plus/25 Plus contains a glass microfiber prefilter
- Housing: PP
- Extractable materials: low
- Inlet connection: Female luer lock
- Outlet connection: Male slip luer

Housing diameter: 10 mm
 Housing material: PP
 Extractable substances: low
 Retained volume: < 20 µl

3



Type	Residual volume	Filter diam.	Pore size	Membrane	PK	Cat. No.
	ml	mm	µm			
non-sterile	0,02	1	0.02	Anotop® 10	50	9.951 186
non-sterile	0,02	10	0.10	Anotop® 10	50	9.951 187
non-sterile	0,02	10	0.20	Anotop® 10	50	9.951 188
non-sterile	0,15	25	0.02	Anotop® 25	50	9.951 198
non-sterile	0,15	25	0.10	Anotop® 25	50	9.951 199
non-sterile	0,15	25	0.20	Anotop® 25	50	9.951 200
non-sterile	0,15	25	0.20	Anotop® 25	200	9.951 201
sterile	0,02	10	0.02	Anotop® 10	50	9.951 189
sterile	0,02	10	0.10	Anotop® 10	50	9.951 190
sterile	0,02	10	0.20	Anotop® 10	50	9.951 191
sterile	0,15	25	0.02	Anotop® 25	50	9.951 202
sterile	0,15	25	0.10	Anotop® 25	50	9.951 203
sterile	0,15	25	0.20	Anotop® 25	50	9.951 204

Further products can be found in our online shop.



Filtration/Syringe filters

1

1 Syringe filters Spartano®, Regenerated cellulose

Versatile use - ready-to-use filter units with a hydrophilic, low protein-binding membrane made of regenerated cellulose. First class chemical resistance against the usual aqueous and organic HPLC solvents

- Spartano® 13 and 30 are tested and certified for UV absorbance substances at wavelengths of 210 nm and 254 nm with water, methanol and acetonitrile;
- Spartano® 13 has an extremely low hold up volume; <10 µl, for optimal filtration

Whatman
Applications:

Ideal for HPLC sample preparation to achieve reproducible results. Carefully controlled manufacture guarantees lowest traces of UV- absorbing, extractable components.

Type	Filter diam.	Pore size	Housing	PK	Cat. No.
	mm	µm			
non sterile	13	0.20	LLF/LM	100	9.049 948
non sterile	13	0.20	LLF/LM	500	9.049 980
non sterile	13	0.20	LLF/Mini-Tip	100	9.049 943
non sterile	13	0.20	LLF/Mini-Tip	500	9.049 951
non sterile	13	0.45	LLF/LM	100	9.049 949
non sterile	13	0.45	LLF/Mini-Tip	100	9.049 944
non sterile	13	0.45	LLF/Mini-Tip	500	9.049 950
non sterile	30	0.20	LLF/LM	100	9.049 941
non sterile	30	0.20	LLF/LM	500	9.049 965
non sterile	30	0.45	LLF/LM	50	9.049 960
non sterile	30	0.45	LLF/LM	100	9.049 942
non sterile	30	0.45	LLF/LM	500	9.049 959

LLF = luer-lock female
LM = luer male

2

2 Syringe filters, disposable, ReZist® PTFE

- Hydrophobic PTFE-membrane, laminated with polypropylene
- first class chemical resistance opposite to common organic HPLC solvents

Whatman
Application:

Filtration of aggressive solutions.
GF92 membrane to the prefiltration of loaded solutions.

Type	Filter diam.	Pore size	Housing	Membrane	PK	Cat. No.
	mm	µm				
non sterile	13	0.20	PP*	PTFE	100	9.049 981
non sterile	13	0.45	PP*	PTFE	100	9.049 982
sterile	30	0.20	PP	PTFE	50	9.049 955
non sterile	30	0.20	PP	PTFE	100	9.049 961
non sterile	30	0.20	PP	PTFE	500	9.049 990
non sterile	30	0.45	PP	PTFE	100	9.049 962
non sterile	30	0.45	PP	PTFE	500	9.049 991
non sterile	30	1.00	PP	PTFE	100	9.049 963
non sterile	30	1.00	PP	PTFE	500	9.049 992
non sterile	30	5.00	PP	PTFE	100	9.049 964
non sterile	30	5.00	PP	PTFE	500	9.049 993
non sterile	30		PP	GF92	100	9.049 996
non sterile	30		PP	GF92	500	9.049 997

*with Mini-Tip outlet

3

3 Syringe filters, Minisart® High-Flow, PES

Housing MBS. Minisart® High Flow PES (Polyethersulfone) syringe filters for sterile filtration, particle removal and ultra-cleaning. Covers a wide pH range.

Sartorius Lab Instruments

These independent ready-to-use syringe filters with PES membrane filter feature excellent flow speed and high filterable volume. The Minisart® High Flow is a syringe filter for rapid volume sterilisation with maximum user convenience. Ready-to-use units, which offer flow rates at low inlet pressures, allow for a correspondingly rapid sterile filtration.

Filter diam.	Pore size	Description	Colour	Sterile	PK	Cat. No.
mm	µm					
28	0.10	Male Luer Lock	Dark Red	+	50	9.049 866
28	0.22	Male Luer Lock	Royal Blue	x	50	6.261 787
28	0.22	Male Luer Lock	Royal Blue	+	50	9.049 129
28	0.22	Male Luer Slip	Royal Blue	+	50	6.201 927
28	0.22	Male Luer Lock	Royal Blue	-	500	9.049 130
28	0.22	Male Luer Slip	Royal Blue	-	500	6.252 364
28	0.45	Male Luer Lock	Amber	+	50	6.206 703
28	0.45	Male Luer Lock	Amber	-	500	6.201 960
28	0.45	Male Luer Slip	Amber	x	50	6.251 896
28	0.45	Male Luer Slip	Amber	+	50	9.049 865
28	0.45	Male Luer Slip	Amber	-	500	7.400 725

x = sterilization by gamma irradiation

Syringe filter Minisart® NML, SFAC

Housing MBS. SFCA/CA (Surfactant-free Cellulose Acetate) membrane. For sterile, particle free, ultrapure filtration of small volumes of liquid up to approx. 100 ml. Color coded and printed for easy membrane and pore size identification. With hydrophilic cellulose acetate membrane for minimum adsorption. Ready-to-use immediately. With female luer-lock inlet, male luer slip outlet.

Sartorius Lab Instruments

Filter diam.	Pore size	Colour	Description	Sterile	PK	Cat. No.
mm	µm					
28	0.20	Blue	SFCA, Male Luer Lock*	+	50	6.250 269 1
28	0.20	Blue	SFCA, Male Luer Lock*	x	50	6.224 111
28	0.20	Blue	SFCA, Male Luer Lock*	-	500	9.049 107
28	0.20	Blue	SFCA, Male Luer Slip*	+	50	9.604 009
28	0.20	Blue	SFCA, Male Luer Slip*	-	500	7.017 212
28	0.45	Yellow	SFCA, Male Luer Lock*	+	50	6.900 911 2
28	0.45	Yellow	SFCA, Male Luer Lock*	x	50	7.620 792
28	0.45	Yellow	SFCA, Male Luer Lock*	-	500	9.049 108
28	0.45	Yellow	SFCA, Male Luer Slip*	+	50	9.604 011
28	0.45	Yellow	SFCA, Male Luer Slip*	-	500	7.017 213
28	0.65	Pink	SFCA, Male Luer Slip	+	50	6.901 409 3
28	0.80	Green	SFCA, Male Luer Lock	+	50	9.049 103 4
28	0.80	Green	SFCA, Male Luer Lock	-	500	9.049 109
28	1.20	Red	SFCA, Male Luer Lock	+	50	9.049 104
28	1.20	Red	SFCA, Male Luer Lock	-	500	9.049 122
28	5.00	Brown	SFCA, Male Luer Lock*	+	50	9.049 105 5
28	5.00	Brown	SFCA, Male Luer Lock	-	500	9.049 123

* CE-marked
x = sterilization by gamma irradiation



6 Syringe filter Minisart® RC

Housing PP. Regenerated cellulose (RC). Ready-to-use units with a hydrophilic, solvent-resistant membrane made of regenerated cellulose, making sample preparation quick and easy. Suitable for aqueous/organic solutions.

Sartorius Lab Instruments

Filter diam.	Pore size	Description	Colour	Sterile	PK	Cat. No.
mm	µm					
25	0.20	Male Luer Slip	White, Printed	+	50	7.076 270
25	0.20	Male Luer Slip	White, Printed	-	50	9.049 094
25	0.20	Male Luer Slip	White, Printed	-	200	6.250 422
25	0.20	Male Luer Slip	White, Printed	-	500	9.049 095
25	0.45	Male Luer Slip	White, Printed	-	50	9.049 097
25	0.45	Male Luer Slip	White, Printed	-	200	6.201 608
25	0.45	Male Luer Slip	White, Printed	-	500	9.049 098
15	0.20	Male Luer Slip	White, Printed	+	50	7.075 954
15	0.20	Male Luer Slip	White, Printed	-	50	9.049 087
15	0.20	Male Luer Slip	White, Printed	-	500	9.049 088
15	0.45	Male Luer Slip	White, Printed	-	50	9.049 091
15	0.45	Male Luer Slip	White, Printed	-	500	9.049 092
4	0.20	Male Luer Slip	Blue Tray	-	50	9.049 081
4	0.20	Male Luer Slip	Blue Tray	-	500	9.049 082
4	0.45	Male Luer Slip	Yellow Tray	-	50	9.049 084
4	0.45	Male Luer Slip	Yellow Tray	-	500	9.049 085



7 Syringe filter Minisart® NY/NY25 Plus

Housing PP. NY (Nylon) and NY25 Plus (Glass Fiber 0.7 µm² + Nylon).

Sartorius Lab Instruments

Filter diam.	Pore size	Description	Colour	Sterile	PK	Cat. No.
mm	µm					
25	0.20	Male Luer Slip	White, Printed	+	50	7.970 531
25	0.20	Male Luer Slip	White, Printed	-	500	6.232 794
25	0.45	Male Luer Slip	White, Printed	+	50	7.616 056
25	0.45	Male Luer Slip	White, Printed	-	500	6.207 149
15	0.20	Male Luer Slip	White, Printed	-	50	6.255 610
15	0.45	Male Luer Slip	White, Printed	-	50	6.284 026
25	0.45	Male Luer Slip	White, Printed	-	50	6.252 610
25	0.45	Male Luer Slip	White, Printed	-	500	7.500 023



Filtration/Syringe filters



1 Syringe filter Minisart® SRP, PTFE

Housing PP. With a chemical-resistant, hydrophobic PTFE membrane for high purification of solvents or aggressive liquids in HPLC or GC analysis. Low adsorption.

Sartorius Lab Instruments

Filter diam.	Pore size	Description	Colour	Sterile	PK	Cat. No.
mm	µm					
25	0.20	Male Luer Slip	White, Printed	+	50	7.076 124
25	0.20	Male Luer Slip	White, Printed	-	50	9.049 115
25	0.20	Male Luer Slip	White, Printed	-	200	6.250 452
25	0.20	Male Luer Slip	White, Printed	-	500	9.049 114
25	0.45	Male Luer Slip	White, Printed	-	50	9.049 116
25	0.45	Male Luer Slip	White, Printed	-	200	6.250 514
25	0.45	Male Luer Slip	White, Printed	-	500	9.049 117
15	0.20	Male Luer Slip	White, Printed	+	50	7.080 155
15	0.20	Male Luer Slip	White, Printed	-	50	9.604 022
15	0.20	Male Luer Slip	White, Printed	-	500	7.017 207
15	0.45	Male Luer Slip	White, Printed	-	50	9.604 024
15	0.45	Male Luer Slip	White, Printed	-	500	9.049 073
4	0.20	Male Luer Slip	Blue Tray	-	500	6.255 634
4	0.45	Male Luer Slip	Yellow Tray	-	50	9.049 146
4	0.45	Male Luer Slip	Yellow Tray	-	500	9.049 147

Minisart SRP 15 and SRP 25 are also available in 0.2 µm pore sizes (and sterile).

2 Syringe filter CHROMAFIL®, Cellulose acetate (CA)

Hydrophilic membrane for filtration of water-soluble oligomers and polymers, especially suited for biological macromolecules. Very high shape stability in aqueous solutions extremely low binding capacity for proteins (21 µg/ 25 mm filter).

MACHEREY-NAGEL

Type	Filter diam.	Pore size	Housing	PK	Cat. No.
	mm	µm			
non sterile	13	0.20	PP-colourless/labelled*	100	7.971 473
non sterile	13	0.45	PP-colourless/labelled*	100	6.287 307
non sterile	25	0.20	PP-yellow/red	100	9.049 038
non sterile	25	0.20	PP-yellow/red	400	9.049 039
non sterile	25	0.20	PP-colourless/labelled*	100	4.003 419
non sterile	25	0.20	PP-colourless/labelled*	400	4.003 420
non sterile	25	0.45	PP-colourless/red	100	9.049 040
non sterile	25	0.45	PP-colourless/red	400	9.049 041
non sterile	25	0.45	PP-colourless/labelled*	100	4.003 421
non sterile	25	0.45	PP-colourless/labelled*	400	4.003 422
sterile	25	0.20	PP-yellow/red	50	9.049 036
sterile	25	0.45	PP-colourless/red	50	9.049 037

* CHROMAFIL® Xtra



3 Syringe filter CHROMAFIL®, Cellulose mixed ester (MV)

Hydrophilic membrane. This membrane is recommended for all filtrations of aqueous or polar organic samples.

MACHEREY-NAGEL

Type	Filter diam.	Pore size	Housing	PK	Cat. No.
	mm	µm			
non sterile	25	0.20	PP-yellow/yellow	100	9.049 030
non sterile	25	0.20	PP-colourless/labelled*	100	4.003 407
non sterile	25	0.45	PP-colourless/yellow	100	9.049 032
non sterile	25	0.45	PP-colourless/yellow	400	9.049 033
non sterile	25	0.45	PP-colourless/labelled*	100	4.003 405
non sterile	25	0.45	PP-colourless/labelled*	400	4.003 406

* CHROMAFIL® Xtra



1 Syringe filter CHROMAFIL®, regenerated Cellulose (RC)

Hydrophilic membrane with very low adsorption for aqueous and organic/aqueous liquids i.e. polar and medium polar sample solutions. Binding capacity for proteins 84 µg/25 mm filter.

MACHEREY-NAGEL

Type	Filter diam.	Pore size	Housing	PK	Cat. No.
	mm	µm			
non sterile	13	0.20	PP-colourless/labelled*	100	6.287 308
non sterile	13	0.45	PP-colourless/labelled*	100	6.287 309
non sterile	15	0.20	PP-yellow/blue ¹⁾	100	9.049 025
non sterile	15	0.45	PP-colourless/blue ¹⁾	100	9.049 026
non sterile	25	0.20	PP-yellow/blue	100	9.049 042
non sterile	25	0.20	PP-yellow/blue	400	9.049 043
non sterile	25	0.20	PP-colourless/labelled*	100	4.003 424
non sterile	25	0.20	PP-colourless/labelled*	400	4.003 425
non sterile	25	0.45	PP-colourless/blue	100	9.049 044
non sterile	25	0.45	PP-colourless/blue	400	9.049 046
non sterile	25	0.45	PP-colourless/labelled*	100	4.003 426
non sterile	25	0.45	PP-colourless/labelled*	400	6.233 891

* CHROMAFIL® Xtra

¹⁾ with mini tip outlet

1



2 Syringe filter CHROMAFIL®, Polytetrafluoroethylene (PTFE)

A hydrophobic membrane. Ideal for filtration of non-polar liquids and gases. It is very resistant to various solvents as well as acids and bases. By flushing with alcohol, followed by water, the original hydrophobic membrane can be made more hydrophilic.

MACHEREY-NAGEL

Type	Filter diam.	Pore size	Housing	PK	Cat. No.
	mm	µm			
non sterile	3	0.20	PP-colourless	100	9.049 053
non sterile	3	0.45	PP-colourless	100	9.049 054
non sterile	13	0.20	PP-colourless/labelled*	100	7.970 889
non sterile	13	0.45	PP-colourless/labelled*	100	6.268 887
non sterile	15	0.20	PP-yellow/colourless ¹⁾	100	9.049 055
non sterile	15	0.45	PP-colourless ¹⁾	100	9.049 056
non sterile	25	0.20	PP-yellow/colourless	100	9.049 057
non sterile	25	0.20	PP-yellow/colourless	400	9.049 058
non sterile	25	0.20	PP-colourless/labelled*	100	4.003 409
non sterile	25	0.20	PP-colourless/labelled*	400	4.003 410
non sterile	25	0.45	PP-colourless/labelled*	100	9.049 059
non sterile	25	0.45	PP-colourless/labelled*	400	9.049 060
non sterile	25	1.00	PP-colourless/labelled*	100	6.242 808

* CHROMAFIL® Xtra

¹⁾ with mini tip outlet

2



3 Syringe filter CHROMAFIL®, Polyester (PET)

Hydrophilic membrane for polar as well as non-polar solvents. The HPLC filter, especially suited for mixtures of water and organic solvents; for TOC/DOC determination; not cytotoxic, does not inhibit the growth of microorganisms and higher cells. Polyester filter with integrated glass fibre prefilter (GF/PET): recommended for solutions with a high load of particulate matter or for highly viscous solutions.

MACHEREY-NAGEL

Type	Filter diam.	Pore size	Housing	PK	Cat. No.
	mm	µm			
non sterile	15	0.20	PP-yellow/orange ¹⁾	100	9.049 065
non sterile	15	0.45	PP-colourless/orange ¹⁾	100	9.049 066
non sterile	25	0.20	PP-yellow/orange	100	9.049 067
non sterile	25	0.20	PP-yellow/orange	400	9.049 068
non sterile	25	0.20	PP-colourless/labelled*	100	4.003 417
non sterile	25	0.20	PP-colourless/labelled*	400	4.003 418
non sterile	25	0.45	PP-colourless/orange	100	9.049 069
non sterile	25	0.45	PP-colourless/orange	400	9.049 070
non sterile	25	0.45	PP-colourless/labelled*	100	6.232 548
non sterile	25	0.45	PP-colourless/labelled*	400	4.003 416
non sterile	25	1.20	PP-colourless/labelled*	100	6.232 549
non sterile	25	1.20	PP-colourless/labelled*	400	6.233 172
non sterile	25	1.0/0.20	PP-blue/orange ²⁾	100	9.049 079
non sterile	25	1.0/0.45	PP-black/orange ²⁾	100	9.049 080
non sterile	25	1.0/0.20	PP-blue/orange ²⁾	400	9.049 020
non sterile	25	1.0/0.45	PP-black/orange ²⁾	400	9.049 021
non sterile	13	0.20	PP-colourless/labelled*	100	6.287 311
non sterile	13	0.45	PP-colourless/labelled*	100	6.287 312

* CHROMAFIL® Xtra

¹⁾ with mini tip outlet²⁾ with glass-fibre prefilter

3



Filtration/Syringe filters

1

1 Syringe filter CHROMAFIL®, Polyamide (PA)

Hydrophilic membrane. The membrane is recommended for filtration of medium polar organic/aqueous liquids.

MACHEREY-NAGEL

Type	Filter diam.	Pore size	Housing	PK	Cat. No.
	mm	µm			
non sterile	3	0.20	PP-colourless	100	9.049 047
non sterile	3	0.45	PP-colourless	100	9.049 048
non sterile	13	0.20	PP-colourless/labelled*	100	6.287 310
non sterile	13	0.45	PP-colourless/labelled*	100	6.283 261
non sterile	25	0.20	PP-yellow/green	100	9.049 049
non sterile	25	0.20	PP-yellow/green	400	9.049 050
non sterile	25	0.20	PP-colourless/labelled*	100	4.003 411
non sterile	25	0.20	PP-colourless/labelled*	400	4.003 412
non sterile	25	0.45	PP-colourless/green	100	9.049 051
non sterile	25	0.45	PP-colourless/green	400	9.049 052
non sterile	25	0.45	PP-colourless/labelled*	100	6.232 389
non sterile	25	0.45	PP-colourless/labelled*	400	6.234 011

* CHROMAFIL® Xtra

2

2 Syringe filter CHROMAFIL®, Hydrophilized Polytetrafluoroethylene (H-PTFE)

Hydrophilized polytetrafluoroethylene syringe filters labelled for method validation and certification

MACHEREY-NAGEL

- Hydrophobic membrane with additional hydrophilic characteristics
- For polar and nonpolar solutions
- Resistant against all kinds of solvents as well as acids and bases

Type	Filter diam.	Pore size	Housing	PK	Cat. No.
	mm	µm			
non sterile	13	0.20	PP-colourless/labelled	100	6.266 191
non sterile	13	0.45	PP-colourless/labelled	100	6.266 192
non sterile	25	0.20	PP-colourless/labelled	100	6.266 189
non sterile	25	0.45	PP-colourless/labelled	100	7.658 851
non sterile	25	0.45	PP-colourless/labelled	400	6.266 190

3

3 Syringe filter CHROMAFIL®, Polyethersulfone (PES)

Hydrophilic membrane for aqueous and light organic solutions. Very low adsorption of pharmaceuticals and proteins. Good stability against acids and bases. Binding capacity for proteins 29 µg per 25 mm filter.

MACHEREY-NAGEL

Type	Filter diam.	Pore size	Housing	PK	Cat. No.
	mm	µm			
non sterile	25	0.20	PP-colourless/labelled*	100	4.003 427
non sterile	25	0.45	PP-colourless/labelled*	100	4.003 429
non sterile	25	0.45	PP-colourless/labelled*	400	4.003 430
non sterile	25	5.00	PP-colourless/labelled*	100	4.003 431

* CHROMAFIL® Xtra

4

4 Syringe filter CHROMAFIL®, Polyvinylidene fluoride (PVDF)

Hydrophilic membrane, for aqueous solutions, water-soluble oligomers and polymers like proteins binding capacity for proteins 20 µg/25 mm filter. The PVDF filter with integrated glass fibre prefilter (GF/P) is recommended for filtration of biological samples with high particle loads. This filter features a high binding capacity for proteins. Also suited for filtration of polar and non-polar solutions.

MACHEREY-NAGEL

Type	Filter diam.	Pore size	Housing	PK	Cat. No.
	mm	µm			
non sterile	13	0.20	PP-colourless/labelled	100	6.287 313
non sterile	13	0.45	PP-colourless/labelled	100	6.287 314
non sterile	25	0.20	PP-colourless/labelled	100	4.003 413
non sterile	25	0.20	PP-colourless/labelled	400	4.003 414
non sterile	25	0.45	PP-colourless/labelled	100	9.049 063
non sterile	25	0.45	PP-colourless/labelled	400	4.003 415
non sterile	25	1.0/0.45	PP-black/white*	100	4.003 401
non sterile	25	1.0/0.45	PP-black/white*	400	4.003 402

* with glass fibre prefilter

1 Syringe filter CHROMAFIL®, Glass-fibre (GF)

Inert Filter, nominal pore size 1µm, allows higher flow rates than smaller pore filters. For solutions with high loads of particulate matter or for highly viscous solutions (e. g. soil samples, fermentation broths) as prefilters for other CHROMAFIL® filters, they prevent plugging of the membrane.

MACHERY-NAGEL

1



Type	Filter diam. mm	Pore size µm	Housing	PK	Cat. No.
non sterile	15	1	PP-blue/colourless ¹⁾	100	9.049 077
non sterile	25	1	PP-yellow/black	100	9.049 078
non sterile	25	1	PP-yellow/black	400	6.229 751
non sterile	13	1	PP-colourless/labelled*	100	7.971 495
non sterile	25	1	PP-colourless/labelled*	100	6.232 362
non sterile	25	1	PP-colourless/labelled*	400	4.003 423

*CHROMAFIL® Xtra
¹⁾ with mini tip outlet

2 Syringeless filters SEPARA

SEPARA integrates in one single device auto-sampler vial, filtration membrane, plunger, and cap/septa. The single step filtering process is efficient and saves time. Fast and simple to use. Reducing sample loss. After filtration the sample is ready to use in most standard autosampler. The pre-slit cap ensures easy and clean transfer of sample. 5 different septa material, PP vial with Ø 12 x 33 mm, Filtering capacity 0.48 ml, dead volume <30 µl, maximum operating temperature 50 °C

GVS S.p.A.

2



Membrane	Pore size µm	Colour	PK	Cat. No.
Nylon	0.22	light blue	100	6.287 339
PTFE	0.22	pink	100	6.287 340
Regen. Cellulose	0.22	grey	100	6.287 341
PVDF	0.22	yellow	100	6.287 342
PES	0.22	light green	100	6.287 343
Nylon	0.45	blue	100	6.287 344
PTFE	0.45	red	100	6.287 345
Regen. Cellulose	0.45	black	100	6.287 346
PVDF	0.45	orange	100	6.287 347
PES	0.45	green	100	6.287 348

3 Syringeless filters Mini-UniPrep™

The Whatman Mini-UniPrep™ filter provides a quick and easy means of removing particles from HPLC samples. In comparison to other methods the amount of time required for sample preparation is reduced to one third. Mini-Uni-Prep™ is a ready-to-use filter unit consisting of a 0.4ml chamber and a plunger. The plunger contains a filtration membrane at one end and a cap with septum at the other. The plunger is pressed through the sample in the chamber. The pressure generated forces the filtrate into the plunger reservoir, with air escaping through the vent hole until the locking mechanism engages to form an airtight seal. The unit can now be placed in any autosampler and the sample analysed.

Whatman

3



Pore size µm	Membrane	Housing	PK	Cat. No.
0.2	PTFE	PE	100	9.056 824
0.2	RC	PE	100	9.056 825
0.45	RC	PE	100	9.056 826
0.45	PVDF	PE	100	9.056 827
0.45	DpPP	PE	100	9.056 828
0.45	GMF	PE	100	9.056 829
0.45	Nylon	PE	100	9.056 830
0.45	PTFE	PE	100	9.056 831
0.45	PP	PE	100	9.056 832
0.45	PES	PE	100	6.229 725
0.2	PES	PE	100	6.283 544
0.2	PTFE	Glass	100	6.283 545
0.2	Nylon	Glass	100	6.283 546
0.2	RC	Glass	100	6.283 547
0.45	PTFE	Glass	100	6.283 548
0.45	RC	Glass	100	6.283 549
0.2	Nylon	Glass	100	6.401 676

Filtration/Syringe filters



1 Disposable Filtration Capsules, Polycap TF™

Whatman



Hydrophobic PTFE membrane for applications involving organic solvents and chemically aggressive solutions.

- Maximum operating pressure of 4.1 bar forward and 3.0 bar reverse
- 1 µm capsules incorporate a PP prefilter
- Autoclavable up to 132 °C maximum
- Connectors: stepped barb (SB) and female national pipe thread (FNPT)

Porosity	Filter diam.	Connection	Sterile	PK	Cat. No.
µm	mm	in / out			
0,2	36	1/4-3/8" SB / 1/4-3/8" SB	-	1	9.951 126
0,2	75	1/4-3/8" SB / 1/4-3/8" SB	-	1	9.951 128
1,0	36	1/4-3/8" SB / 1/4-3/8" SB	-	1	9.951 127
1,0	75	3/8-1/2" SB / 3/8-1/2" SB	-	1	9.951 129
0,2	36	3/8" FNPT / 3/8" FNPT	-	5	6.803 130
0,2	75	3/8" FNPT / 3/8" FNPT	-	5	6.803 246

Filtration Capsules Polycap TC

Polycap TC filtration capsules feature dual layer polyethersulfone (PES) membranes and provide efficient filtration for aqueous solutions.

Whatman

- 100 % integrity-tested during manufacturing
- Polypropylene housing thermally fused to eliminate surfactants and mold releasing agents that could affect analysis
- Manufactured according to ISO9001:2008 QMS standards
- Available in sterile versions with a filling bell option
- PES membranes protein adsorption characteristics: HAS 0.4 µg/cm²; Insulin 2.0 µg/cm²; gammaglobulin 1.5 µg/cm²
- Connectors: stepped barb (SB)

Porosity	Filter diam.	Connection	Sterile	PK	Cat. No.
µm	mm	in / out			
0,8/0,2*	75	1/4-3/8" SB / 1/4-3/8" SB	+	1	6.257 668
0,8/0,2*	150	3/8-1/2" SB / 1/4-3/8" SB	+	1	6.257 914

* filling bell



2 Mini-cartridge filters

Sartorius Lab Instruments



Mini-cartridge filters are inserted into a stainless steel housing. The bayonet closure provides a secure seal against back-pressure surges. An inner O-ring seals the lower part of the housing (except for the aeration housing). For the filtration of larger volumes and for long service lives. Individually tested. Their integrity can be checked at any time. Can be autoclaved repeatedly.

There are several different types which differ in the filter material used:

Sartobran-P

Heterogeneous double membrane of cellulose acetate, for the sterile filtration of liquids.

Sartofluor

Hydrophobic PTFE membrane filter, for the sterile filtration of air and gases.

Sartopure-PP3

High performance PP fleece prefilters for particle reduction.

Type	Description	PK	Cat. No.
5231507H8B	Sartobran-P (0.1 m ² , 0.45 + 0.2 µm)	5	9.604 602
5231507H9B	Sartobran-P (0.2 m ² , 0.45 + 0.2 µm)	5	9.604 601
5181507T8B	Sartofluor (0.1 m ² , 0.2 µm)	5	9.604 605
5181507T9B	Sartofluor (0.2 m ² , 0.2 µm)	5	9.604 604
5051502P9B	Sartopure-PP3 (0.15 m ² , 3 µm)	5	6.314 874
5051505P8B	Sartopure-PP3 (0.09 m ² , 0.65 µm)	5	6.315 037

1 Membrane filter holders, PC



Sartorius Lab Instruments

Reusable filter holder, without filter. Filter has to be selected separately.
For particle removal, sterile filtration of aqueous solutions or for venting of sterile vessels.
Autoclavable. With Luer connection.

Filter diam.	Pore size	Connection	Colour	Sterile	PK	Cat. No.
mm	µm					
13	0.45	Female Luer Lock Luer Slip	Clear	-	12	9.049 241
25	0.45	Female Luer Lock Luer Slip	Clear	-	12	9.049 242



2 LLG-Inline-filters, PTFE



The 50mm inline filter with its ultra pure Polypropylene housing (ultrasonic welded) is designed to contain 47 mm membranes. The filter comes with 6-12mm hose connectors (tapered) at the inlet and the outlet side. The PTFE-membrane can be used for filtration of aggressive chemicals including acids and non-aqueous solutions. Due to its high filter area of 1735mm² the filter is suitable for long term gas filtration /venting applications, it could be used for filtration of higher volumes of liquid (up to approximately 500ml, depending on the particle load of the filtrated suspension) or for filtration of aggressive non aqueous liquids.

- hydrophobic PTFE-membrane
- Housing polypropylene
- autoclavable at 121 °C for 20 minutes at 2 bar, max. 3 cycles
- stepped hose connector of 6-10 mm on either sides
- high throughput with low pressure drop
- max. operating pressure 4.0 bar

Diam.	Pore size	PK	Cat. No.
mm	µm		
50	0.20	5	9.059 513
50	0.45	5	9.059 514



3 In-line filters Midisart® 2000



Sartorius Lab Instruments

For sterile ventilation of fermenters, culture vessels, etc. or to act as a water barrier between the suction flask and the vacuum pump in filtration applications. The supported PTFE membrane within a PP housing gives excellent chemical resistance. Filter in either direction (3 bar max. pressure).

- Stepped horse-barb of 6-12 mm on either sides
- sterile single packed filters, autoclavable

Filter diam.	Pore size	Connection	Colour	Sterile	PK	Cat. No.
mm	µm					
62	0.45	Hose barb	White	+	12	9.049 156
62	0.45	Hose barb	White	+	25	9.049 157
62	0.20	Hose barb	White	+	12	9.049 151
62	0.20	Hose barb	White	+	25	9.049 152
62	0.20	Hose barb	White	-	100	9.049 153
62	0.45	1/8" NPT	White	+	12	7.017 319
62	0.45	1/8" NPT	White	+	25	7.017 320
62	0.20	1/8" NPT	White	+	12	7.017 321
62	0.20	1/8" NPT	White	+	25	6.227 120



Filtration/Filtration apparatus



1 Filtration capsules, Sartobran 150 and 300



Sartorius Lab Instruments

Ready-to-use pressure filtration capsules for sterile filtration of media and aqueous solutions with volumes of up to 20 litres (Sartobran 150), or 40 litres (Sartobran 300). The units consist of a polypropylene housing containing a double-layer cellulose acetate membrane (0.2 µm and 0.45 µm). The membranes, which have an area of 150 cm² or 300 cm², have extremely low protein adsorption levels. Autoclavable at up to 134 °C. Automatically air vented via an integral PTFE membrane. Sterile and individually packed. With 6 to 12 mm flexible tubing connections (SO) or 1/2 inch tri-clamp (TC).

Type	PK	Cat. No.
Sartobran 150 SO/SO	5	9.604 615
Sartobran 150 TC/SO	5	9.604 616
Sartobran 150 TC/TC	5	9.604 617
Sartobran 300 SO/SO	2	9.604 618
Sartobran 300 SO/SO	5	9.604 619

2 Manifolds Microsart®, stainless steel



For microbiological quality control. Quick connectors at both sides of the manifolds enable fast connections of either tubing, another manifold or end caps. Various funnel and filtration units are available.

Sartorius Lab Instruments

- Full autoclavability without disassembly
- Sterile venting
- Reduced risk of secondary contamination
- Low working height
- Rubber feet providing better stability at the workplace

Scope of supply:

Microsart® Manifolds for Microsart® funnels and filters: Manifold, filter base support with sinter frit, blind coupling, 20 cm tubing and venting filter

Microsart® Manifolds for Biosart® 100 monitors: Manifold, filter base support with sinter frit, Biosart® adapter, blind coupling, 20 cm tubing and venting filter

Microsart® Manifolds for Biosart® 250 funnels: Manifold, filter base support with sinter frit, blind coupling, 20 cm tubing and plug for venting holes

Microsart® Manifolds including stainless steel funnels (100/500 ml): Manifold, filter base support with sinter frit, blind coupling, 20 cm tubing and plug for venting holes

Type	Description	Dimensions (W x D x H) mm	PK	Cat. No.
Microsart® Manifolds for Microsart® funnels and filters	1 branch	176 x 98 x 120 *	1	4.669 470
Microsart® Manifolds for Microsart® funnels and filters	2 branch	246 x 118 x 130*	1	4.669 471
Microsart® Manifolds for Microsart® funnels and filters	3 branch	474 x 98 x 120 *	1	4.669 472
Microsart® Manifolds for Microsart® funnels and filters	6 branch	924 x 98 x 120 *	1	4.669 473
Microsart® Manifolds for Biosart® 100 monitors	1 branch	176 x 98 x 120 *	1	4.669 474
Microsart® Manifolds for Biosart® 100 monitors	2 branch	246 x 118 x 130*	1	4.669 475
Microsart® Manifolds for Biosart® 100 monitors	3 branch	474 x 98 x 120 *	1	4.669 476
Microsart® Manifolds for Biosart® 100 monitors	6 branch	924 x 98 x 120 *	1	4.669 477
Microsart® Manifolds for Biosart® 250 funnels	1 branch	176 x 98 x 120 *	1	4.669 478
Microsart® Manifolds for Biosart® 250 funnels	3 branch	474 x 98 x 120 *	1	4.669 479
Microsart® Manifolds for Biosart® 250 funnels	6 branch	924 x 98 x 120 *	1	4.669 480
Microsart® Manifolds including stainless steel funnels 100 ml	1 branch	176 x 98 x 120 *	1	4.669 481
Microsart® Manifolds including stainless steel funnels 100 ml	3 branch	474 x 98 x 120 *	1	4.669 482
Microsart® Manifolds including stainless steel funnels 100 ml	6 branch	924 x 98 x 120 *	1	4.669 483
Microsart® Manifolds including stainless steel funnels 500 ml	1 branch	176 x 98 x 120 *	1	4.669 484
Microsart® Manifolds including stainless steel funnels 500 ml	3 branch	474 x 98 x 120 *	1	4.669 485
Microsart® Manifolds including stainless steel funnels 500 ml	6 branch	924 x 98 x 120 *	1	4.669 486

* Dimensions without funnels and tubing



1 LLG-Filtering apparatus

Universally applicable filtration unit made of high-quality borosilicate glass. Wide range of applications for filtration with filter paper or membrane filters (47 mm).

- Large funnel (300 ml) with scale
- Filter flask 1 or 2 litres, with scale
- Safe plastic olive
- Filter plate with porosity 2
- Filter plates with porosity 1 or 3 optionally available
- All components available as spare parts

Scope of delivery: 1000 (2000) ml Filter flask NS45/40, funnel 300 ml, filter holder NS45/40 with connector GL14 and filter plate 47 mm (por. 2), clamp.

Description	PK	Cat. No.
LLG-Filtering apparatus 1000 ml	1	6.291 850
LLG-Filtering apparatus 2000 ml	1	6.291 851

1



2 Filtering apparatus DURAN®

The DURAN® filtering apparatus is made of high-quality borosilicate glass. Aside from glass, the medium only comes into chemical contact with PTFE. This means that the filtering apparatus can be used to filter virtually any chemical. Thanks to the PTFE disc holder, fritted glass discs of different porosities can be used in addition to the slit-sieve disc. This creates a wide application scope for filtration using filter paper, membrane filters (47mm) or simply using glass filters. Different porosities are available between 10 µm and 160µm, which makes it possible to perform coarse and fine filtration in addition to analytical filtration. Furthermore, the filtering apparatus is suitable for the filtration of HPLC media, testing for bacterial contamination, residue analysis and the filtration of other media.

DWK Life Sciences

Scope of delivery: 1000 (2000) ml suction bottle with NS 45/40, extension NS 45/40 with hose connection GL 14, PTFE adapter plate, Filter disc D50 (Porosität 2), slit-sieve disc D48, filter funnel 250 (500) ml, clamp (Alu), straight plastic hose connection with seal, threaded cap GL 14

Description	PK	Cat. No.
Filtering apparatus DURAN®, 1000 ml / 250 ml	1	9.052 744
Filtering apparatus DURAN®, 2000 ml / 500 ml	1	7.910 686

2



3 Glass units for vacuum filtration, PTFE-coated

Type 163. For particle testing or radiochemical work. For ultrafiltration and sterile filtration. Autoclavable. PTFE-coated, steel screen filter support.

Sartorius Lab Instruments

Type	Capacity ml	Filter size mm	PK	Cat. No.
Unit for vacuum filtration, PTFE-coated	30	Ø 25	1	9.604 205
Unit for vacuum filtration, PTFE-coated	250	Ø 47/50	1	9.604 308
Rubber stopper			1	6.202 667
Perforated plate and PTFE-ring			1	7.017 199
Clamps			1	7.017 296
Perforated plate, PTFE coated			1	7.017 297

3



4 Glass vacuum filter holders, glass frit

Two compact, glass vacuum filter holders for simple particle testing and clarification of solutions. With glass frit membrane filter support and anodised aluminium clamp.

Sartorius Lab Instruments

Scope of delivery

Size 25 mm, 30 ml: Glass vacuum filtration unit with filter support consisting of PTFE ring and glass frit.

Size 47/50 mm, 250 ml: Glass vacuum filtration unit with silicone cover and filter support consisting of PTFE ring and glass frit.

Type	For Filter size	Volume ml	PK	Cat. No.
with glass frit	25 mm dia.	30	1	9.604 204
with glass frit	47/50 mm dia.	250	1	9.604 307

4



Filtration/Filtration apparatus



1 Filter holders, Type 16309

Completely made of glass.
For particle removal from solvents. With 250 ml attachment.
For filter Ø 47 and 50 mm. With ground in vacuum bottle made of borosilicate glass, 1 l.

Sartorius Lab Instruments

Type	Capacity ml	Filter size mm	PK	Cat. No.
All-glass unit	250	Ø 47 - 50mm	1	9.604 076



2 Vacuum filtration equipment, GV 025 series

- funnel volume 60 ml
- for filter 25 mm diameter

Whatman

Type	Description	PK	Cat. No.
GV/MV 050/0/06	Spring clip complete	1	7.010 136
GV 025/0/01	Glass attachment 60 ml	1	7.010 149
GV 025/0/03	Glass frit	1	7.010 151
GV 025/0/05	PTFE centering ring	1	7.010 152
GV 025/0/06	Feather clamp complete	1	7.010 153
GV 025/2/02	Lower part from glass	1	7.010 155
GV 025/2/08	Erlenmeyer flasks 250 ml	1	7.010 157
GV 050/0/01	Glass essay 250 ml	1	7.010 158
GV 050/0/02	Lower part from glass	1	7.010 159
GV 050/0/03	Glass frit	1	7.010 160
GV 050/0/05	PTFE centering ring	1	7.010 161
GV 050/2/12	Lower part with NS 45	1	7.010 166
GV 025/0	Vacuum filtration equipment 25 mm, glass frit D2, 60 ml	1	9.603 250
GV 025/2	Vacuum filtration equipment 25 mm, glass frit D2, 60 ml funnel volume, 250 ml erlenmeyer flask	1	9.603 252



3 Vacuum or pressure filtration apparatus, Typ 16510, PC

For vacuum or pressure filtration up to 2 bar.
For ultra or sterile filtration.
With collecting bottle 250 ml.
For filter 47 mm diameter filters.

Sartorius Lab Instruments

Type	Volume ml	Filter size mm	PK	Cat. No.
PC filtration apparatus	250	Ø 47mm	1	9.049 243



1 LLG-Porcelain filter crucibles, DIN 12909

Glazed, with porous bottom.

Capacity ml	Ext. diam. mm	Height mm	Pore size µm	PK	Cat. No.
8	25	28	6	1	9.052 080
8	25	28	7	1	9.052 081
8	25	28	8	1	9.052 082
15	30	35	6	1	9.052 083
15	30	35	7	1	9.052 084
15	30	35	8	1	9.052 085
25	35	40	6	1	6.233 176
25	35	40	7	1	6.233 748
25	35	40	8	1	9.052 086
35	40	43	6	1	9.052 087
35	40	43	7	1	9.052 088
35	40	43	8	1	9.052 089
50	45	50	6	1	9.052 090
50	45	50	7	1	9.052 091
50	45	50	8	1	9.052 092

1



2 Filter crucibles, VitraPOR®, borosilicate glass 3.3

For analytical filtration in laboratories.

ROBU

- Resistant to acids, alkalis and solvents
- Temperature resistant up to 540 °C
- With numbering

Capacity ml	Diam. mm	Porosity	PK	Cat. No.
15	23	1	1	9.052 060
15	23	2	1	9.052 061
15	23	3	1	9.052 062
15	23	4	1	9.052 063
15	23	5	1	9.052 064
30	30	0	1	6.087 623
30	30	1	1	9.052 036
30	30	2	1	9.052 037
30	30	3	1	9.052 038
30	30	4	1	9.052 039
30	30	5	1	9.052 040
30	30	ASTM Coarse	1	4.671 417
30	30	ASTM Fine	1	6.273 460
50	40	0	1	6.280 506
50	40	1	1	9.052 041
50	40	2	1	9.052 042
50	40	3	1	9.052 043
50	40	4	1	9.052 044
50	40	5	1	9.052 065
50	40	ASTM Coarse	1	7.982 409
50	40	ASTM Fine	1	7.971 642

2



3 Filter-Crucibles VitraPOR®, CFE, Borosilicate Glass 3.3

For crude fibre extraction in common systems with numbering.

ROBU

The filter discs of the CFE crucibles have an improved sintering hardness to withstand the chemical load in the analytical processes.

Capacity ml	Diam. mm	Porosity	PK	Cat. No.
30	34	1	1	6.204 827
30	34	2	1	6.302 168
30	34	3	1	6.203 889

3



Filtration/Filtration apparatus



1 Filter crucibles, DURAN®

With sintered glass filter disc at base, as outlined below.
Glass Type I/neutral glass as per USP, EP and JP. Autoclavable.

DWK Life Sciences

Capacity ml	Diam. mm	Porosity	PK	Cat. No.
30	36	1	1	9.052 021
30	36	2	1	9.052 022
30	36	3	1	9.052 023
30	36	4	1	9.052 024
30	36	5	1	9.052 025
50	46	1	1	9.052 031
50	46	2	1	9.052 032
50	46	3	1	9.052 033
50	46	4	1	9.052 034



2 Rubber sleeves, EPDM



For filter crucibles. Temperature resistant up to 150 °C. Autoclavable.

Deutsch & Neumann

Diam. mm	PK	Cat. No.
26	1	9.052 114
33	1	9.052 121
41	1	9.052 126
49	1	9.052 131



3 Adapters for filter crucibles, borosilicate glass 3.3

Borosilicate glass 3.3, autoclavable.

ROBU

Diam. mm	Stem diam. mm	PK	Cat. No.
34	10	1	9.052 213
40	10	1	9.052 214
50	10	1	9.052 215



4 Adapters for filter crucibles, Duran®

Glass Type I/neutral glass as per USP, EP and JP. Autoclavable.

DWK Life Sciences

Diam. mm	Height mm	PK	Cat. No.
27	108	1	9.052 216
34	110	1	9.052 222
41	125	1	9.052 226
50	132	1	9.052 232



5 Filter holders, DURAN®

DURAN®. Dismountable, modular filter holders with screwthreaded top manifold, PP funnel outlet and two FKM seals. Accessory sintered filter discs (9.052 941 to 9.052 954) are screwed in between two FKM seals. The filter discs are easy to replace. Membrane or paper filters can be stretched across the disc. Filter plates must be ordered separately.

DWK Life Sciences

Capacity ml	Plate diam. mm	Thread diam. mm	PK	Cat. No.
30	24	28	1	9.052 903
250	50	54	1	9.052 905
1000	90	95	1	9.052 910

➔ Exhaust Device please see page 1271.

1 Filter holders, glass, top manifold only, DURAN®

DURAN®. For use in dismountable filter holders. With screwthread, without PP outlet funnel, filter disc or FKM rubber seals.

DWK Life Sciences

Capacity ml	Thread diam. mm	PK	Cat. No.
30	28	1	9.052 913
250	54	1	9.052 915
1000	95	1	9.052 920



2 Filter discs, DURAN®

With glass rim. For use in dismountable filter holders. Patented design. Filter discs must always be screwed in between two FKM rubber seals. Without top manifold, PP outlet funnel or seals.

DWK Life Sciences

Plate diam. mm	Porosity	PK	Cat. No.
24	1	1	9.052 941
24	2	1	9.052 942
24	3	1	9.052 943
24	4	1	9.052 944
50	1	1	9.052 951
50	2	1	9.052 952
50	3	1	9.052 953
50	4	1	9.052 954
90	1	1	9.052 961
90	2	1	9.052 962
90	3	1	9.052 963
90	4	1	9.052 964



3 Filter discs, VitraPOR®

Surfaces untreated, round centered. Further sizes and bi-plane ground are available online.

NEW
ROBU

Plate diam. mm	Thickness mm	Porosity	PK	Cat. No.
30	3,5 ± 0,8	2	1	6.072 553
30	3,5 ± 0,8	3	1	6.201 347
30	3,5 ± 0,8	4	1	6.259 302
30	3,5 ± 0,8	Fine	1	4.671 418
60	5,0 ± 1,1	2	1	4.671 419
60	5,0 ± 1,1	3	1	4.671 421
60	5,0 ± 1,1	4	1	6.267 343
60	5,0 ± 1,1	Fine	1	4.671 422
90	6,5 ± 1,5	2	1	4.671 423
90	6,5 ± 1,5	3	1	4.671 424
90	6,5 ± 1,5	4	1	4.671 425
90	6,5 ± 1,5	Fine	1	4.671 426
120	8,5 ± 1,9	2	1	6.262 268
120	8,5 ± 1,9	3	1	4.671 427
120	8,5 ± 1,9	4	1	4.671 428
120	8,5 ± 1,9	Fine	1	4.671 429



4 FKM seals

For use in dismountable filter holders.

DWK Life Sciences

For diam. mm	PK	Cat. No.
24	1	9.052 923
50	1	9.052 925
90	1	9.052 930



Filtration/Filtration apparatus



1 Slotted sieve disc (perforated plate) DURAN®

Can be used in the 250ml capacity dismountable filter holder as a carrier for membrane and paper filters.

DWK Life Sciences

Plate diam.	PK	Cat. No.
mm		
48	1	9.052 901



2 Filter funnels VitraPOR®, Borosilicate glass 3.3

Borosilicate glass 3.3, with sintered disc filter as outlined below. Autoclavable.

ROBU

Capacity	Diam.	Stem diam.	Porosity	PK	Cat. No.
ml	mm	mm			
50	36	10	1	1	9.052 367
50	36	10	2	1	9.052 368
50	36	10	3	1	9.052 369
50	36	10	4	1	9.052 370
75	48	10	1	1	9.052 371
75	48	10	2	1	9.052 372
75	48	10	3	1	9.052 373
75	48	10	4	1	9.052 374
125	60	10	1	1	9.052 375
125	60	10	2	1	9.052 376
125	60	10	3	1	9.052 377
125	60	10	4	1	9.052 378
250	80	18	1	1	9.052 066
250	80	18	2	1	9.052 067
250	80	18	3	1	9.052 068
250	80	18	4	1	9.052 069
500	95	22	1	1	9.052 379
500	95	22	2	1	9.052 380
500	95	22	3	1	9.052 381
500	95	22	4	1	9.052 382
1000	124	22	1	1	9.052 383
1000	124	22	2	1	9.052 384
1000	124	22	3	1	9.052 385
1000	124	22	4	1	9.052 386
4000	180	30	1	1	9.052 387
4000	180	30	2	1	9.052 388
4000	180	30	3	1	9.052 389
4000	180	30	4	1	9.052 390



3 Filter funnels, glass DURAN®

Glass Type I/neutral glass as per USP, EP and JP. Autoclavable.

DWK Life Sciences

Capacity	Diam.	Stem diam.	Height	Porosity	PK	Cat. No.
ml	mm	mm	mm			
50	35	10	130	1	1	9.052 301
50	35	10	130	2	1	9.052 302
50	35	10	130	3	1	9.052 303
50	35	10	130	4	1	9.052 304
50	35	10	130	5	1	9.052 305
75	45	10	132	1	1	9.052 311
75	45	10	132	2	1	9.052 312
75	45	10	132	3	1	9.052 313
75	45	10	132	4	1	9.052 314
75	45	10	132	5	1	9.052 315
125	60	10	140	1	1	9.052 321
125	60	10	140	2	1	9.052 322
125	60	10	140	3	1	9.052 323
125	60	10	140	4	1	9.052 324
125	60	10	140	5	1	9.052 325
500	95	22	240	1	1	9.052 331
500	95	22	240	2	1	9.052 332
500	95	22	240	3	1	9.052 333
500	95	22	240	4	1	9.052 334
500	95	22	240	5	1	9.052 335
1000	120	22	270	1	1	9.052 341
1000	120	22	270	2	1	9.052 342
1000	120	22	270	3	1	9.052 343
1000	120	22	270	4	1	9.052 344
1000	120	22	270	5	1	9.052 345
4000	175	30	425	1	1	9.052 361
4000	175	30	425	2	1	9.052 362
4000	175	30	425	3	1	9.052 363
4000	175	30	425	4	1	9.052 364

6. Distillation, separation, filtration Filtration/Filtration apparatus

1 Filter funnels, glass DURAN®, conical

Conical. Glass Type I/neutral glass as per USP, EP and JP. Autoclavable.

DWK Life Sciences

Capacity: 25 mm
 Diameter: 55 mm
 Plate diameter: 25 mm
 Stem diameter: 8 mm
 Height: 100 mm

Type	Porosity	PK	Cat. No.
39D	3	1	9.052 453
39D	4	1	9.052 454



2 Slotted sieve filter funnels (Buchner funnels), DURAN®

Buchner pattern funnel with slotted sieve (perforated) filter plate.
 Glass Type I/neutral glass as per USP, EP and JP. Autoclavable.

DWK Life Sciences

Capacity	Diam.	Stem	Height	PK	Cat. No.
ml	mm	diam. mm	mm		
70	48	10	132	1	9.252 022
125	60	10	140	1	9.252 028
220	73	18	190	1	9.252 034
500	95	22	240	1	9.252 044
1000	120	22	270	1	9.252 054



3 LLG Buchner funnels, porcelain

For filterpaper diam.	Capacity	PK	Cat. No.
mm	ml		
45	35	1	6.239 903
55	70	1	6.237 328
70	120	1	6.231 541
90	240	1	9.252 500
110	400	1	9.252 501
125	600	1	9.252 502
150	1000	1	9.252 503
185	2000	1	9.252 504
240	4000	1	9.252 505
295	7000	1	9.252 506



4 Buchner funnels, porcelain

To DIN 12905.

Haldenwanger

For filter diam.	Capacity	DIN	PK	Cat. No.
mm	ml			
18	3		1	9.252 018
27	10		1	9.252 027
40	25		1	6.078 858
45	50	12905	1	9.252 045
55	75	12905	1	9.252 055
70	135	12905	1	9.252 070
90	290	12905	1	9.252 090
110	580	12905	1	9.252 110
125	795	12905	1	9.252 125
150	1250	12905	1	9.252 150
185	1900	12905	1	9.252 185
240	4300	12905	1	9.252 240
270	5800	12905	1	9.252 270
320	10600	12905	1	9.252 320



Filtration/Filtration apparatus



1

1 Buchner funnels, PTFE

NEW

BOLA



Chemically resistant and temperature resistant from -200 to 250 °C. FDA conform. Autoclavable.

For filterpaper diam.		Capacity	PK	Cat. No.
mm	ml			
45	50		1	4.668 557
55	75		1	4.668 558
70	135		1	4.668 559
90	390		1	4.668 560



2

2 Filter funnels, PP, Buchner

Kartell



PP. Two-piece construction. Top and bottom sections can be separated. Easy to clean. Autoclavable. Suitable for foodstuff.

For filterpaper diam.		Capacity	PK	Cat. No.
mm	ml			
42.5	40		1	9.252 330
55	70		1	9.252 331
70	180		1	9.252 332
80	285		1	9.252 333
90	390		1	9.252 334
110	810		1	9.252 335
160	2100		1	9.252 338
240	6000		1	9.252 339



3

3 Protective collars, EPDM.

For filter flasks.

Special design centres the funnel and flask and provides stable support for funnels, filters and manifolds placed on them. A clean seal is made between the flask rim and container placed on it. Application of the vacuum provides a tight seal. Also provides all-round protection for glass filter flask rims, significantly reducing impact damage and extending working life.

For bottles ml	Diam.	Height	PK	Cat. No.
	mm	mm		
100	23	11	1	9.052 391
250, 500	33	15	1	9.052 392
1000	44	25	1	9.052 393
2000, 3000	58	25	1	9.052 394
5000, 10000	68	25	1	9.052 395



4

4 Rubber Spacers (GuKo), natural rubber

Deutsch & Neumann

Rubber Spacers, made of natural rubber (NR). Conical, to fit filter funnels or crucibles into suction flasks. Durometer 40 Shore A

Top diam. mm	Bottom diam. mm	Height mm	Wall thickness mm	Colour	PK	Cat. No.
21	12.0	18	2.5	grey	1	9.052 412
27	17.0	20	3.0	grey	1	9.052 417
33	21.0	24	3.0	grey	1	9.052 423
41	27.5	27	4.0	grey	1	9.052 427
53	33.0	34	5.0	grey	1	9.052 432
68	48.0	35	5.5	grey	1	9.052 436
78	58.0	35	6.0	grey	1	9.052 439
89	66.0	40	6.5	grey	1	9.052 443
33	21.0	24	3.0	red	1	6.079 121
41	27.5	27	4.0	red	1	6.071 789
53	33.0	34	5.0	red	1	6.078 202
68	48.0	35	5.5	red	1	6.071 787
78	58.0	35	6.0	red	1	6.071 788
89	66.0	40	6.5	red	1	6.070 153

1 Set of rubber spacers (GuKo), natural rubber

Comprises of 5, 7 or 8 Gukos with an external lower diameter of 12 mm, 17 mm, 21 mm, 27.5 mm, 33 mm, 48 mm, 58 mm and 66 mm each. Hardness 40 Shore A.

Deutsch & Neumann

1



Type	Colour	PK	Cat. No.
1-5, 5-parts	grey	1	6.077 882
1-7, 7-parts	grey	1	6.077 417
1-8, 8-parts	grey	1	9.052 400
1-5, 5-parts	red	1	6.078 144
1-7, 7-parts	red	1	6.078 145
1-8, 8-parts	red	1	6.077 415

Vacuum Adapter, PTFE

For safe assembly of standard filter funnels made of glass or plastic on laboratory bottles. With lateral 2-step hose connector for connection to a vacuum pump. Pass-through with O-ring made of FKM. FDA conform. Chemikally resistant. Autoclavable.

BOLA

Specifications

Temperature range: -15 - 200 °C
 2-step hose connector (outer diam. 1/outer diam. 2): 9 mm/12 mm

2 Vacuum Adapter GL, PTFE

NEW

BOLA

2



For funnel outlet diam. mm	For thread size GL	PK	Cat. No.
22	45	1	6.273 897

3 Vacuum Adapter NS, PTFE

NEW

BOLA

3



For funnel outlet diam. mm	Joint size (NS)	PK	Cat. No.
8	14/23	1	4.670 724
11	19/26	1	4.670 725
22	29/32	1	6.273 419
22	45/40	1	4.670 723

4 Filter flasks, Erlenmeyer shape, borosilicate glass 3.3

According to ISO 6556 standards. The glass side arm or the Polypropylene side arm is suitable to work with 6 mm to 10 mm hose diameters. The Polypropylene side arm has a screw thread connector for easy and safe fitting of the tubing.

ISOLAB

4



Capacity ml	lateral connection	PK	Cat. No.
100	glass	1	4.008 437
250	glass	1	6.241 652
500	glass	1	6.241 291
1000	glass	1	6.239 008
2000	glass	1	4.008 438
100	PP	1	4.008 439
250	PP	1	6.237 706
500	PP	1	6.237 707
1000	PP	1	6.237 708
2000	PP	1	6.242 170

5 Filter flasks, Erlenmeyer shape, DURAN®

DIN 12476. ISO 6556. With PBT tubing connection and silicone (VMQ) seal. Heavy wall for vacuum use. These filtering flasks fulfil the regulations of the equipment and product safety regulations.

DWK Life Sciences

5



Capacity ml	Diam. mm	Neck diam. mm	Height mm	PK	Cat. No.
100	64	24	105	1	9.051 424
250	85	34	155	1	9.051 436
500	105	34	185	1	9.051 444
1000	135	45	230	1	9.051 454
2000	166	60	255	1	9.051 455

Filtration/Filtration apparatus

1



1 Filter flasks, bottle shape, DURAN®

NEW

DIN 12476. ISO 6556. With PBT tubing connection and silicone (VMQ) seal. Heavy wall for vacuum use. These filtering flasks fulfil the regulations of the equipment and product safety regulations.

DWK Life Sciences

Capacity	Diam.	Neck diam.	Height	PK	Cat. No.
ml	mm	mm	mm		
3000	170	58	295	1	9.051 456
5000	185	68	360	1	9.051 457
10000	240	70	420	1	9.051 458
15000	257	70	500	1	9.051 459
20000	290	70	535	1	9.051 460

2



2 DURAN® Filtering Flask with Glass Hose Connection, Erlenmeyer shape



DWK Life Sciences

Due to the heavy wall thickness the apparatus is vacuum-tight.

Capacity	Diam.	Neck diam.	Height	PK	Cat. No.
ml	mm	mm	mm		
100	64	24	105	1	9.051 201
250	85	34	155	1	9.051 202
500	105	34	185	1	9.051 205
1000	135	45	230	1	9.051 210
2000	166	60	255	1	9.051 220

3



3 Filter flasks, glass DURAN®

DIN 12476. ISO 6556. Erlenmeyer shape. Heavy wall, for vacuum use. With ground 17.5/26 socket for vacuum tubing with 15 mm to 18 mm external diameter. These filtering flasks fulfil the regulations of the "equipment and product safety regulations".

DWK Life Sciences

Capacity	Diam.	Neck diam.	Height	PK	Cat. No.
ml	mm	mm	mm		
250	85	34	155	1	9.051 236
500	105	34	185	1	9.051 244
1000	135	45	230	1	9.051 254
2000	166	60	255	1	9.051 263

4



4 Filter flasks with side-arm socket, glass DURAN®

Bottle shape. Heavy wall, for vacuum use. With ground 17.5/26 socket for vacuum tubing with 15 mm to 18 mm external diameter. These filtering flasks fulfil the regulations of the "equipment and product safety regulations".

DWK Life Sciences

Capacity	Diam.	Neck diam.	Height	PK	Cat. No.
ml	mm	mm	mm		
3000	170	58	295	1	9.051 268
5000	185	68	360	1	9.051 273
10000	240	70	420	1	9.051 286
15000	255	70	500	1	9.051 288
20000	290	70	535	1	9.051 291

5



5 Filter flask DURAN®

Witt-pattern. Complete with interchangeable, flat-ground jointed, tube lid with cone, and plastic flexible tubing connection on one side. Vacuum resistant.

DWK Life Sciences

DN	Height	Lid	PK	Cat. No.
	mm			
100	160	29/32	1	9.051 519
150	200	29/32	1	9.051 531
200	300	29/32	1	7.022 240
100	160	45/40	1	9.051 619
150	200	45/40	1	9.051 631

Cooling	754
Cryogenic tubes	754
Cryogenic boxes	757
Cryogenic racks	763
Cryogenic accessories	763
Biobanking	766
Cryogenic storage tanks	768
Liquid nitrogen-Accessories	768
Dewar flasks	769
Low and Ultra low temperature freezers	772
Refrigerators and Freezers	785
Refrigerators and Freezers ex protected	787
Ice machines	789
Transport boxes	790
Temperature regulators	796
Heating-Thermostats	796
Cooling-Thermostats	812
Circulator baths	821
Dynamic Temperature Control Systems	826
Temperature Control Accessories	827
Heating	829
Water baths	829
Shaking water baths	836
Heating baths	839
Hotplates	841
Heating mantles	846
Temperature controllers, thermostats	851
Microwaves	852
Universal, Heating and Drying incubators	853
Vacuum drying incubators	862
Incubators	864
Cooling incubators	870
CO ₂ -Incubators	875
Shaking incubators	878
Thermoblocks	889
Test incubators	898
Ovens, Furnaces	903

Cooling/Cryogenic tubes

Warning

Do not use CryoTubes in the liquid phase of liquid nitrogen unless correctly sealed. Improper use may cause liquified nitrogen to be trapped inside the vial and lead to pressure build-up, resulting in possible explosion or biohazard release.

➔ Products for nitrogen storage - please see page 768.

1



1 LLG-Cryotubes, PP, sterile



With star-shape in the screw cap, for automated capper/decapper. Temperature resistant down to -196°C. **Not appropriate for operations in liquid nitrogen.** With marking area, fill line and graduations printed on the vial. Safe and precise handling of biotechnology materials. Bar-code printed on each tube. DNase/RNase free. Vials and caps are autoclavable at 121 °C.

Homogeneous conception:

- all made from polypropylene
- single-body, single-turn screw cap

Printed graduations for accurate measurements. Large white area for writing specimen identification. Sterile.

Packed in 2 bags of 50 tubes.

Description	Capacity ml	Ext. diam. mm	Height mm	Thread	PK	Cat. No.
self-standing	1.2	12.6	40.2	external	100	9.401 160
self-standing	1.2	12.6	40.2	internal	100	9.401 161
self-standing	2.0	12.6	45.6	external	100	9.401 162
self-standing	2.0	12.6	48.2	internal	100	9.401 163
without ring	2.0	12.6	44.5	external	100	9.401 164
without ring	2.0	12.6	47.0	internal	100	9.401 165
self-standing	5.0	12.6	87.6	external	100	9.401 166
without ring	5.0	12.6	89.2	internal	100	9.401 167
self-standing	5.0	12.6	90.3	internal	100	9.401 168

Fits in 10 x 10 Cryobox System 100™ 5026, Order No: 9.400 927

2



2 Insert cap disks for LLG cryotubes, PP

Cap-disk with star-shaped insert. For colour-coding of cryotubes and quick identification of the samples.

Colour	PK	Cat. No.
blue	1000	9.401 170
white	1000	9.401 171
yellow	1000	9.401 172
pink	1000	9.401 173
red	1000	9.401 174
green	1000	9.401 175



7. Heating and cooling technology

Cooling/Cryogenic tubes

1 2 Cryogenic tubes, PP



BRAND

Designed for storage of biological material, such as microorganisms, human and animal cells, etc. in the gas phase of liquid nitrogen.
 Graduated, 12.5 mm o.d. Large frosted marking area and coloured cap inserts for easy sample identification.
 Temperature stability to -196 °C. gamma-ray sterile (SAL 10⁻⁶) and autoclavable at 121 °C (2 bar), according to DIN EN 285. Cryogenic vials are sterile, RNase-, DNase-, DNA- and endotoxin-free.



Description	Capacity	Grad. up to	Height	Thread	PK	Cat. No.
	ml	ml	mm			
self-standing	1.2	1.0	41	external	1000	6.801 655
round-bottom	2.0	1.8	47	external	1000	6.206 393
self-standing	2.0	1.8	49	external	1000	7.079 366
self-standing	3.0	3.0	70	external	1000	6.802 266
self-standing	4.0	3.6	76	external	1000	7.059 827
self-standing	5.0	4.5	90	external	1000	7.300 349
self-standing	1.2	1.0	41	internal	1000	7.300 557
self-standing	2.0	1.8	49	internal	1000	7.053 349
round-bottom	2.0	1.8	48	internal	1000	7.604 109
round-bottom	4.0	3.6	70	internal	1000	9.401 223
self-standing	4.0	3.6	71	internal	1000	9.401 224
round-bottom	5.0	4.6	90	internal	1000	7.610 567



3 Cap coders, PP for Brand® cryogenic tubes

For colour coding. Fit for all sizes.

BRAND

Colour	PK	Cat. No.
white	500	7.200 575
blue	500	7.077 849
red	500	7.053 350
green	500	7.079 679
yellow	500	7.600 162



4 Cryovials with external screw thread, PP

With screw cap, self-standing. Increase storage capacity in mechanical and gaseous phase liquid nitrogen freezers. With writing area and graduation. Gamma radiation sterilized. One-handed operation possible. DNase/RNase free. Pyrogen-free and non-cytotoxic.
 SYSTEM 100: Cryovials for space-saving storage (10 x 10 per box).

Thermo Scientific



Type	Cover type	Description	Sterile	Capacity	Ext. diam. mm	Height mm	PK	Cat. No.
				ml				
5000	PP	silicone gasket, SYSTEM 100	+	1.0	12.0	38	500	4.675 510
5000	PP	silicone gasket, SYSTEM 100	+	1.5	12.0	48	500	4.675 511
5000	HDPE	sealing ring	+	1.2	13.5	38	500	4.675 512
5000	HDPE	sealing ring	+	2.0	13.5	48	500	4.675 513
5000	HDPE	sealing ring	+	5.0	13.5	92	250	4.675 514
5005* **	HDPE	without inlay	+	15.0	33.0	47	75	9.400 950

*not DNase-/RNase-free

**Flat bottom

Also available in a larger pack size (1000 pc.).

5 Colour Coders for Cryotubes Nalgene™, PS

Coloured PS cap inserts.

Thermo Scientific

Colour	PK	Cat. No.
white	100	9.400 967
yellow	100	9.400 968
blue	100	9.400 969
green	100	9.400 970
red	100	9.400 971



➔ Cryo labels - please see page 764.

Cooling/Cryogenic tubes



1 2 Cryotubes Nunc with External Thread, PP/PE

Intended for cryogenic transportation and storage of biological material. Available in three different tube types: Round or conical bottom shape with starfoot or round without foot (= non free standing). Conform to the IATA requirements for the transport of diagnostic specimens and to the US pharmacopoeia USP Class VI. Packed in resealable zip lock bags with printed catalog no. and lot. no. Pyrogen-free. Non-toxic. Sterile (SAL 10⁻⁶). Certified RNase- and DNase-free.

Thermo Scientific

Material tubes: PP
Material screw caps: PE



Warning:
Do not use CryoTubes in the liquid phase of liquid nitrogen unless correctly sealed in Nunc CryoFlex™ Tubing (Cat. No. 4.009 142). Improper use may cause liquified nitrogen to be trapped inside the vial and lead to pressure build-up, resulting in possible explosion or biohazard release.

Description	Capacity	Ext. diam.	Height	PK	Cat. No.
	ml	mm	mm		
Conical, starfoot and writing area	1.0	12.5	41	2000	4.675 472
Round, starfoot and writing area	1.8	12.5	48	1800	4.675 471
Round, starfoot and writing area	4.5	12.5	91	1200	4.675 474
Conical, starfoot	1.0	12.5	41	2000	4.009 087
Round, starfoot	1.8	12.5	48	1800	4.675 478
Round, starfoot	4.5	12.5	91	1200	4.008 952
Round, writing area*	1.0	12.4	30	500	6.800 399

* Closure design does not permit the use of Cryo Color Coders.



3 4 Cryotubes Nunc with Internal Thread, PP, sterile

Intended for cryogenic transportation and storage of biological material. Internal thread with a silicone gasket provides the best possible seal. Available in four different bottom shapes: Round with or without free standing and round or conical with starfoot. Conform to the IATA requirements for the transport of diagnostic specimens and to the US pharmacopoeia USP Class VI. Packed in resealable zip lock bags with printed catalog no. and lot. no. Pyrogen-free. Non-toxic. Sterile (SAL 10⁻⁶). Certified RNase- and DNase-free. Material tube and screw cap: PP

Thermo Scientific

Warning:
Do not use CryoTubes in the liquid phase of liquid nitrogen unless correctly sealed in Nunc CryoFlex™ Tubing (Cat. No. 4.009 142). Improper use may cause liquified nitrogen to be trapped inside the vial and lead to pressure build-up, resulting in possible explosion or biohazard release.



Description	Capacity	Ext. diam.	Height	PK	Cat. No.
	ml	mm	mm		
Round and writing area	1.8	12.5	48.0	2000	4.675 469
Round and writing area	3.6	12.5	70.0	1600	4.675 480
Round and writing area	4.5	12.5	92.0	1200	4.675 481
Round, starfoot and writing area	1.8	12.5	49.0	1800	4.675 476
Round, starfoot and writing area	3.6	12.5	72.0	1600	4.675 473
Round, starfoot and writing area	4.5	12.5	92.0	1200	4.675 475
Round, free standing and writing area	1.8	12.5	49.0	1800	4.675 477
Round, starfoot	0.5	8.8	35.0	960	4.008 814
Round, starfoot	1.0	8.8	48.5	960	4.008 821
Conical, starfoot and writing area	1.0	12.5	42.0	2000	4.675 470
Conical, free standing and writing area	1.0	12.5	42.0	2000	4.675 479

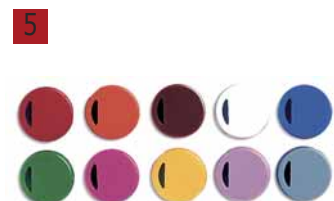

5 Colour Coders for Cryotubes Nunc™, PC

Use Nunc Cryo Colour Coders as part of a versatile and comprehensive filing system. Fit all CryoTubes™ and are available in 10 different colours.

Thermo Scientific

Colour	PK	Cat. No.
Red	500	7.079 568
Orange	2000	9.401 272
Brown	500	7.630 646
White	2000	9.401 274
Blue	2000	9.401 275
Green	2000	9.401 276
Magenta	500	6.204 811
Yellow	2000	9.401 278
Purple	500	6.901 208
Grey	500	6.901 244
Assorted colours	500	7.200 519

1 Cryogenic vial racks, PC

Blue. Safe storage and transport of cryogenic vials.

Heathrow Scientific

- Drainage holes in each well
- Alphanumeric identification
- Temperature resistant up to -196 °C
- Autoclavable

Volume	Array	For tubes diam.	PK	Cat. No.
litres		mm		
2 - 5	50	12.9	4	6.238 908



2 LLG-Cryogenic storage boxes, plastic coated, 136 x 136

Freezer and cryogenic storage boxes (CryoBoxes). Dimensions: 136 x 136mm square. For the storage of samples. Made of cardboard, **plastic coated** without divider. With lid. Further colours available on request.

Colour	Int. height mm	PK	Cat. No.
white	32	1	4.653 682
blue	32	1	6.269 788
red	32	1	6.269 789
green	32	1	6.269 790
white	50	1	6.080 130
yellow	50	1	6.077 876
blue	50	1	6.077 875
green	50	1	6.081 021
red	50	1	6.081 022
white	75	1	6.802 726
blue	75	1	6.260 006
red	75	1	6.260 007
green	75	1	6.260 008
yellow	75	1	6.260 009
white	100	1	6.237 840
blue	100	1	6.260 010
red	100	1	6.260 011
yellow	100	1	4.654 547
white	130	1	6.083 519



3 LLG-Partition inserts for Cryoboxes, 136 x 136

For cryoboxes 136 x 136 mm. With compartment heights and formats as indicated. Other sizes available on request.

Height	Array	For tubes diam.	PK	Cat. No.
mm		mm		
22	7 x 7	17.9	1	4.654 558
22	8 x 8	15.7	1	4.654 557
22	9 x 9	13.9	1	4.654 556
22	10 x 10	12.5	1	4.654 555
40	9 x 9	13.9	1	9.405 872
22	12 x 12	10.2	1	4.654 554
22	13 x 13	9.4	1	4.654 553
22	14 x 14	8.7	1	4.654 552
22	16 x 16	7.5	1	6.257 202
30	4 x 4	32.0	1	6.305 840
30	5 x 5	25.5	1	9.401 055
30	6 x 6	21.0	1	6.090 419
30	7 x 7	17.9	1	7.617 877
30	8 x 8	15.7	1	6.243 752
30	9 x 9	13.9	1	9.405 871
30	10 x 10	12.5	1	9.405 875
30	12 x 12	10.2	1	9.401 050
30	13 x 13	9.4	1	6.228 893
30	14 x 14	8.7	1	6.260 016
30	16 x 16	7.5	1	9.405 883
40	4 x 4	32.0	1	6.401 505
40	5 x 5	25.5	1	6.260 020
40	6 x 6	21.0	1	6.202 839
40	7 x 7	17.9	1	6.802 215
40	8 x 8	15.7	1	6.900 361
40	10 x 10	12.5	1	9.405 876
40	12 x 12	10.2	1	9.405 880
65	6 x 6	21.0	1	6.201 071
65	8 x 8	15.7	1	6.801 789
65	9 x 9	13.9	1	9.405 873
65	10 x 10	12.5	1	9.405 877
65	4 x 4	32.0	1	9.405 870
65	5 x 5	25.5	1	6.079 677

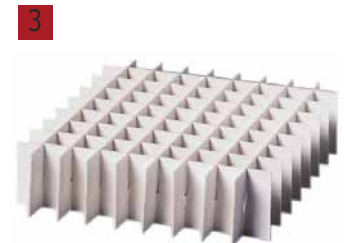

Cooling/Cryogenic boxes

1

1 LLG-Cryogenic storage boxes, plastic coated, 133 x 133

Dimensions: 133 x 133mm square. For the storage of samples. Made of cardboard, **plastic coated**. Without divider. With lid. Further sizes and colours available on request.

Colour	Int. height mm	PK	Cat. No.
white	32	1	6.260 029
red	32	1	6.234 735
green	32	1	4.654 505
yellow	32	1	4.654 506
blue	32	1	6.802 431
white	50	1	6.082 701
red	50	1	6.081 654
green	50	1	6.084 538
yellow	50	1	6.260 091
blue	50	1	6.700 568
white	75	1	6.801 707
green	75	1	6.803 056
yellow	75	1	6.260 031
blue	75	1	9.698 776
white	100	1	6.260 032
red	100	1	9.698 787
green	100	1	9.698 788
yellow	100	1	9.698 789
blue	100	1	9.698 786
white	130	1	6.260 033

2

2 LLG Partition inserts for Cryoboxes, 133 x 133

For cryoboxes 133 x 133 mm. With compartment heights and formats as indicated. Other sizes available on request.

Height mm	Array	For tubes diam. mm	PK	Cat. No.
22	8 x 8	15.0	1	4.654 512
22	9 x 9	13.0	1	6.265 799
22	10 x 10	12.0	1	6.265 800
22	12 x 12	9.8	1	4.653 626
30	4 x 4	30.8	1	6.260 038
30	5 x 5	24.5	1	7.606 811
30	6 x 6	20.3	1	6.265 798
30	7 x 7	17.3	1	9.698 773
30	8 x 8	15.0	1	9.698 772
30	9 x 9	13.0	1	6.081 879
30	10 x 10	12.0	1	6.075 820
30	12 x 12	9.8	1	6.260 035
40	4 x 4	30.8	1	4.654 519
40	5 x 5	24.5	1	6.260 044
40	6 x 6	20.3	1	6.260 043
40	7 x 7	17.3	1	9.698 783
40	8 x 8	15.0	1	9.698 782
40	9 x 9	13.0	1	9.698 781
40	10 x 10	12.0	1	9.698 780
65	3 x 3	41.2	1	4.654 521
65	4 x 4	30.8	1	6.079 079
65	5 x 5	24.5	1	6.260 046
65	6 x 6	20.3	1	6.206 129
65	7 x 7	17.3	1	9.698 793
65	8 x 8	15.0	1	9.698 792
65	9 x 9	13.0	1	9.698 791
65	10 x 10	12.0	1	9.698 790
30	14 x 14	8.3	1	4.654 514

3

3 Cryogenic Cardboard Boxes, 145 x 145 and Partitions

For storage of large samples and 15 and 50 ml tubes. One size box safely stores 15 and 50 ml tubes in LN₂ or mechanical freezers. Choose from two partitions for your tube size. Colour white.

Heathrow Scientific

Description	Int. height mm	PK	Cat. No.
Box for 15 or 50 ml tubes, with lid	122	1	6.254 570
Partition for 16 x 50 ml tubes	122	1	6.254 571
Partition for 36 x 15 ml tubes	122	1	6.254 572

1 LLG-Cryogenic storage boxes, PP, autoclavable



With 81 places, 9 x 9 grid and numerical coded. Robust hinge with safe snap-on lid, stackable for safe transport. Minimised liquid retention. Guaranteed metal free. Temperature resistant from -90 °C - +121 °C, autoclavable at 121 °C, opened, 20 minutes. Dimensions: 133 x 133 x 52 mm

1



Colour	Array	PK	Cat. No.
Magenta/clear	9 x 9	1	9.405 800

Cryogenic Boxes true north® Flatpack

Reusable, economical and moisture resistant plastic. Made from polypropylene material. Easy self-assemble boxes shipped flat-packed saving space in the laboratory. More durable than card boxes as they are not susceptible to moisture. Significantly reduces the chance of mould. Suitable for repeated freezing and defreezing. Dividers included with the boxes.

Heathrow Scientific

2

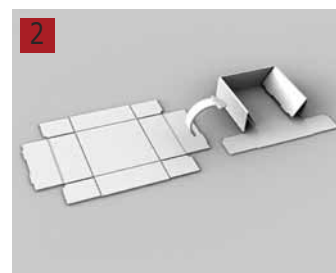

2 Cryogenic Boxes true north® Flatpack, PP

Store down to temperatures of -80 °C.

Heathrow Scientific

3



For tubes	Colour	Dimensions (W x D x H)	Array	PK	Cat. No.
ml		mm			
0.2	white	133 x 130 x 30	144	10	6.281 163
0.5	white	133 x 130 x 42	81	10	6.281 166
0.5	blue	133 x 130 x 42	81	10	6.281 167
1.5/2.0	white	133 x 130 x 51	81	10	6.281 158
1.5/2.0	blue	133 x 130 x 51	81	10	6.281 161
5.0	white	133 x 130 x 75	25	10	6.281 169
5.0	blue	133 x 130 x 75	25	10	6.281 170
15	white	145 x 147 x 120	36	10	6.281 172
15	blue	145 x 147 x 120	36	10	6.281 173
50	white	145 x 147 x 120	16	10	6.281 159
50	blue	145 x 147 x 120	16	10	6.281 160

4 Cryogenic storage boxes Arctic Square®, PC, autoclavable



Safely store vials from -196 to +121 °C for repeated use in mechanical freezers as well as liquid nitrogen. Boxes are designed with unique features to help the user orient, identify, and access vials with ease. The forward-sloped base and high-contrast, imprinted indexing on the transparent lid ensure quick visual orientation. Hinged lid allows easy one-handed access to samples. A built-in stop prevents the lid from swinging too far when the box is picked up by the lid, helping to prevent accidental spills. The 5 x 5 array box does not have hinged lid. All boxes include vent and drainage holes. Stackable. Autoclavable.

Heathrow Scientific

4



For tubes	Colour	Dimensions (W x D x H)	Array	PK	Cat. No.
		mm			
up to 2.0 ml	red	76 x 76 x 53	5 x 5	1	9.405 911
up to 2.0 ml	red, blue, green, purple	133 x 133 x 53	9 x 9	4	9.405 913
up to 2.0 ml	blue	133 x 133 x 53	10 x 10	1	9.405 910

Cooling/Cryogenic boxes

1

1 Storage boxes, PC for cryogenic tubes



BRAND

Operating range: -196 °C to +121 °C (in gas phase of liquid nitrogen).
Autoclavable at 121 °C (2 bar), according to DIN EN 285.

For tubes	For thread type	Width	Depth	Height	Aperture array	PK	Cat. No.
ml		mm	mm	mm	qty.		
1.2 and 2	internal / external	132	132	52	81	1	7.400 583
3, 4 and 5	external	132	132	95	81	1	7.071 111
1.2 and 2	internal	132	132	52	100	1	7.300 574

2

2 Cryogenic boxes, PP, 133 x 133



Ratiolab

For cryogenic storage of cryotubes.

- 9 x 9 grid
- Grid numerically coded
- Removable grid inserts
- Hinge with safe snap-on lid
- Stackable
- Drain bores at the bottom for dew liquid
- Temperature resistant from -90 to 121 °C
- Autoclavable

Colour	Height	For tubes	PK	Cat. No.
	mm	ml		
natural	52	1.2 ... 2	1	9.405 890
yellow	52	1.2 ... 2	1	9.405 892
red	52	1.2 ... 2	1	9.405 894
green	52	1.2 ... 2	1	9.405 896
blue	52	1.2 ... 2	1	9.405 898
black	52	1.2 ... 2	1	9.405 900
natural	75	3 ... 4	1	9.405 891
yellow	75	3 ... 4	1	9.405 893
red	75	3 ... 4	1	9.405 895
green	75	3 ... 4	1	9.405 897
blue	75	3 ... 4	1	9.405 899
black	75	3 ... 4	1	9.405 901

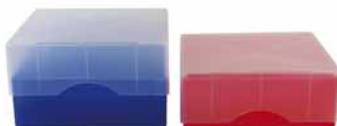
3

3 4 Cryogenic boxes, slip lid with adaptable height, PP, 133 x 133

Ratiolab

- Made from polypropylene
- Height adaptable from 50 mm to 75 mm, by turning the lid 90°
- 9 x 9 array, 10 x 10 array
- Numerical coded places (except black box)
- Drain bores at the bottom for dew liquids
- Autoclavable, temperature resistant from -90 °C to +121 °C

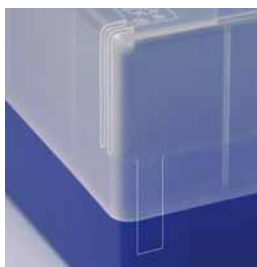
4

Colour	For tubes diam.	Array	PK	Cat. No.
	mm			
natural	13	9 x 9	5	9.405 840
yellow	13	9 x 9	5	9.405 843
red	13	9 x 9	5	9.405 845
green	13	9 x 9	5	9.405 844
blue	13	9 x 9	5	9.405 842
black	13	9 x 9	5	9.405 846
natural, yellow, red, green, blue	13	9 x 9	5	9.405 841
natural	11.5	10 x 10	5	9.405 847
yellow	11.5	10 x 10	5	9.405 848
red	11.5	10 x 10	5	9.405 849
green	11.5	10 x 10	5	9.405 850
blue	11.5	10 x 10	5	9.405 851
black	11.5	10 x 10	5	9.405 852
natural, yellow, red, green, blue	11.5	10 x 10	5	9.405 855

1 Cryogenic Boxes, CryoBoxes™, PC



Thermo Scientific

1



Robust design, autoclavable. With printed grid on lid for cryovials and similar tubes up to 13.5 mm diameter (except type 5026: up to Ø 12.5 mm). Temperature resistant from -196 to 121 °C. With grid numbers for reliable identification of individual samples.

Type 5050 is a plain box with transparent PC lid, without grid, used for storing tubes of various sizes.

Type	For tubes ml	Dimensions (l x w x h) mm	Array	PK	Cat. No.
5026	1/1.5	133 x 133 x 52	10 x 10	1	9.400 927
5025	1.2/2.0	76 x 76 x 52	5 x 5	1	9.400 946
5026	1.2/2.0	133 x 133 x 52	9 x 9	1	9.400 947
5027	5.0	133 x 133 x 95	9 x 9	1	9.400 948
5050		133 x 133 x 52	1	1	9.400 949

2 Cryogenic boxes, 81 well, PP, autoclavable



The boxes are made of polypropylene and can be used in temperatures as low as -90 °C. The boxes are autoclavable at +121 °C for 20 minutes. The boxes have a fixed grid divider with 9x9 cells and are suited for 1.0 ml and 2 ml cryogenic vials. Cellcodes are printed on the lid for easy identification.

2



Type	Dimensions (W x D x H) mm	PK	Cat. No.
blue	130 x 130 x 50	1	9.698 708
green	130 x 130 x 50	1	9.698 709
natural	130 x 130 x 50	1	9.698 710
red	130 x 130 x 50	1	9.698 711
yellow	130 x 130 x 50	1	9.698 712

3 Cryogenic boxes, PP, 81 well, autoclavable



Heathrow Scientific

3



Polypropylene box fits in standard freezer racks. Locate tubes is easily with moulded grid lines and a moulded reference point on the lid. Stores 1.5 ml to 2.0 ml microtubes under easy-open, friction-fit lid. Dimensions: 130 mm x 130 mm x 47 mm. Autoclavable.

Colour	PK	Cat. No.
natural	1	9.193 983
blue	1	7.078 821
green	1	7.058 103
pink	1	7.058 102
yellow	1	7.078 822
orange	1	7.083 522
black	1	6.282 195
blue, green, pink, yellow, orange	5	9.193 984

Cooling/Cryogenic boxes

1

1 Microtube Storage Boxes, PP, 50-/100-Well

Heathrow Scientific

Autoclavable. Compact storage box has angled front slot for easy access to tubes. Rugged, polypropylene box has durable three-point hinges, snapping clasp for secure closure, moulded grid lines on lid, imprinted coordinates on bottom of base and imprinted and raised coordinates on tube wells. Ideal for sample or case study storage. Holds 1.5 ml to 2.0 ml microtubes. Resist storage temperatures from -80 to +121 °C.

Colour	Dimensions (l x w x h)	Array	PK	Cat. No.
mm				
blue, green, purple, yellow, orange	141 x 92 x 56	50	5	9.193 985
natural	141 x 92 x 56	50	1	6.243 162
blue, green, purple, yellow, orange	141 x 151 x 57	100	5	9.193 981
natural	141 x 151 x 57	100	1	6.206 710
black	141 x 151 x 57	100	1	6.253 894

2 Microtube Storage Boxes, PC

Manufactured from polycarbonate with high mechanical strength and high temperature resistance between -196 to +121 °C. Uniquely designed to carry 81 cryo tubes in 9 x 9 array "Hedgehog" designed tube compartments holds the tube in their position firmly. Unique design with vent and drainage holes guarantees best, efficient air circulation. Forward slope base ensures quick visual orientation. Easily stackable for reducing storage space. Hinged lid with built-in stop allows easy one-handed access to tubes. Clear box lid enables easy identification of box content and protects the tubes from dust, moisture and other environmental effects. Alphanumerical index both on tube rows and the lid enables easy identification of tube positions. Box is supplied together with a disposable forceps, made from ABS, with fine end for easy handling and fast removal of tubes.

ISOLAB

Volume ml	Colour	Dimensions (W x D x H) mm	PK	Cat. No.
2.0	green	133 x 133 x 53	1	4.664 457
5.0	blue	133 x 133 x 96	1	6.286 848

2

3

3 50-/100-Well cryogenic boxes, EPS

Heathrow Scientific

Inexpensive freezer storage. Lightweight 1.5ml to 2.0ml microtube racks are ideal for long-term studies or tube storage. Two-piece racks are constructed of expanded polystyrene (EPS) foam. Extra spacing between wells allows easy gripping with fingertips. Racks stack securely with nesting features on lid and base. Resist storage temperatures from -80 °C up to +70 °C. Not autoclavable.

Dimensions (l x w x h) mm	No. of wells	PK	Cat. No.
210 x 100 x 71	50	1	9.193 987
336 x 95 x 73	100	1	9.193 986

4

4 Cryoware marker set Nalgene™, Type 6313

Thermo Scientific

For durable labelling of cardboard, plastic and cloth material for use at ultra-low temperatures. Non-smudge and non-running. Removable with alcohol. Extra fine point. Two packs available: 1 pack contains one each red, green, black and blue marker while the other pack contains black markers only.

Type	Description	PK	Cat. No.
6313	Assorted	4	9.400 978
6313	Black	4	9.400 979

1 Chest Freezers Racks, vertical

Stainless steel racks, suitable for all brands of chest freezer.
For boxes up to 136 x 136 mm.

Type	Width	Depth	Height	Height Box	PK	Cat. No.
	mm	mm	mm	mm		
7 x 1	140	141	390	approx. 53	1	9.698 962
10 x 1	140	141	557	approx. 53	1	9.698 746
11 x 1	140	141	613	approx. 53	1	9.698 963
12 x 1	140	140	665	approx. 53	1	9.698 964
13 x 1	140	141	724	approx. 53	1	9.698 965
5 x 1	140	141	406	approx. 78	1	9.698 967
8 x 1	140	141	649	approx. 78	1	9.698 966
9 x 1	140	141	730	approx. 78	1	9.698 968

1



2 Upright Freezer Racks

Stainless steel racks, suitable for all brands of upright freezers.
For boxes up to 136 mm x 136 mm.

Type	Width	Depth	Height	Height Box	PK	Cat. No.
	mm	mm	mm	mm		
2 x 3	140	423	164	approx. 75	1	9.698 954
4 x 3	140	419	221	approx. 50	1	9.698 950
6 x 4	140	562	331	approx. 50	1	9.698 959
4 x 4	556	140	326	approx. 78	1	9.698 960
5 x 4	556	140	407	approx. 78	1	9.698 961
4 x 4	558	139	221	approx. 53	1	9.698 969
3 x 4	558	139	168	approx. 53	1	9.698 970
5 x 4	558	139	276	approx. 53	1	9.698 971
7 x 4	556	140	392	approx. 53	1	9.698 972
4 x 5	688	139	221	approx. 53	1	9.698 973
5 x 3	419	139	276	approx. 53	1	9.698 974
3 x 4	556	139	240	approx. 78	1	9.698 975
3 x 3	419	139	240	approx. 78	1	9.698 976

2



3 Racks for cryoboxes Arctic Squares®

Stainless steel. Fits most standard upright freezers.

Heathrow Scientific

Overall rack size (H x W x D): 238 x 139 x 571 mm.

With four drawers to hold 16 boxes of 133 x 133 x 53 mm.

Drawers feature a unique stop that when fully extended pivot down allowing for easy box access.

Freezer rack also includes a pull-out wire handle for easy removal off the shelf. Polycarbonate drawer handles provide a user-friendly grip. Includes a slot and label for drawer/sample identification.

Type	PK	Cat. No.
Arctic Squares®	1	9.193 980

3



4 Deep freeze labels TOUGH-SPOTS®

Pre-cut Peel-off round labels for 0.5 and 1.5/2.0 ml microcentrifuge tube tops.

Heathrow Scientific

Temperature resistant from -196 °C to 80 °C.

Easy to write on: PVC labels accept writing from most lab markers.

Convenient: Dispensing box assists in labeling individual tubes used in small experiments.

Colour	Diam.	For vessels	PK	Cat. No.
	mm			
White	9.5	0.5 ml Tubes	1000	9.040 711
Blue	9.5	0.5 ml Tubes	1000	9.040 712
Green	9.5	0.5 ml Tubes	1000	9.040 713
Red	9.5	0.5 ml Tubes	1000	9.040 714
Yellow	9.5	0.5 ml Tubes	1000	9.040 715
Pink	9.5	0.5 ml Tubes	1000	6.267 506
Coffee	9.5	0.5 ml Tubes	1000	6.267 517
Orange	9.5	0.5 ml Tubes	1000	6.267 518
White	13.0	1.5/2.0 ml Tubes	1000	9.040 716
Blue	13.0	1.5/2.0 ml Tubes	1000	9.040 717
Green	13.0	1.5/2.0 ml Tubes	1000	9.040 718
Red	13.0	1.5/2.0 ml Tubes	1000	9.040 719
Yellow	13.0	1.5/2.0 ml Tubes	1000	9.040 720
Lavendel	13.0	1.5/2.0 ml Tubes	1000	6.287 530

4



Cooling/Cryogenic accessories



1 Deep freeze labels Cryo-Babies®/Cryo-Tags®

Temperature resistant from -196 °C to +150 °C. All labels withstand freezer temperatures down to -196 °C (liquid and vapour phase nitrogen), boiling water baths, autoclaving and moderate ovens (150 °C). Chemically inert labels resist most organic solvents and caustic agents. They adhere to most plastics, glass and metals without cracking, peeling or degrading. Made with a flexible, polyolefin label material and acrylic adhesive. This unique combination expands and contracts together with temperature fluctuations resulting in a strong adhesive bond. Convenient dispensing box assists in labeling individual tubes used in small experiments. Easy to write on. PVC labels accept writing from most lab markers including solvent resistant pens.

Heathrow Scientific

Type	Colour	Dimensions (W x D) mm	For vessels	PK	Cat. No.
Cryo-Babies®	White	24 x 13	0.5 ml tubes	1000	9.100 030
Cryo-Babies®	White	33 x 13	1.5/2.0 ml tubes	1000	9.100 031
Cryo-Tags®	White	38 x 13	General application	1000	9.100 032

2



2 Deep freeze labels

Manufactured from polyfiber grade flexible paper with acrylic resin adhesive back. This unique combination expands and retracts together with temperature fluctuations and always guarantees a strong adhesive bond. Chemically inert, resists to water, moisture and most organic solvents and caustic agents. Can be used between -196 to +80 °C temperature range. Sticks to any clean surface including PTFE coated surfaces without cracking, peeling and degrading. Peels off without leaving any sticky residue. Recommended to be used on tube caps with different diameters. Supplied as white color or pack of 6 different colors matching the universal hazard color codes (yellow for chemical reactivity, blue for health hazards, green for safety, red for flammability, orange tape for biohazard and white for general use).

ISOLAB

Diam. mm	Colour	For vessels	PK	Cat. No.
9.5	white	0.5 ml Tubes	1000	6.286 763
9.5	yellow, blue, green, red, orange, white	0.5 ml Tubes	6000	6.286 764
13.0	white	1.5/2.0 ml Tubes	1000	6.286 765
13.0	yellow, blue, green, red, orange, white	1.5/2.0 ml Tubes	6000	6.286 766
19.0	white	15 ml Tubes	500	6.286 767
25.0	white	50 ml Tubes	500	6.286 768

3



3 Label Dispenser for Deep freeze labels

Perfect organizer for fast and efficient use of labels. Manufactured from clear acrylic and holds 6 label box. Drop the label box in the label dispenser and feed the paper through the slot. The writing surface enables easy and clean writing on the label. The sharp cutting edge helps to tear off the labels. A weighted base with nonskid pads prevents sliding or lifting. The article is delivered without pen.

ISOLAB

Type	PK	Cat. No.
Label Dispenser for Deep freeze labels	1	6.286 769

4



9.409 015

LLG-Temperature block exact, aluminium

Suitable for both cooling and heating, universally usable, uniform temperature distribution within the block, ideal for all temperature-sensitive applications.

Aluminum blocks with conical compartments and closed bottom for easy and precise tempering of reaction tubes and PCR tubes. The precisely adapted shape of the borings and the closed bottom offer advantages compared with cylindrical drilled blocks with open bottom, such as much better heat transfer and temperature accuracy. Made of a special aluminum alloy with high thermal conductivity. Identical temperature conditions for all samples. Compact size, requiring little space. Suitable for 96-well plates, 8 or 12 strips and single tubes.

Ideal for working with 8- or 12-channel pipettes. Blocks for different tube sizes and combinations of tube sizes as indicated, all working steps in one block, holes closed at the bottom and tapered to fit perfectly the respective tube sizes and offer an optimum heat exchange.

5



9.409 017

Array	Dimensions (W x D x H) mm	PK	Cat. No.
96 x 0.2 ml PCR tubes + 6 x 1.5 ml tubes	118 x 89 x 24	1	9.409 015
36 x 0.5 ml tubes + 11 x 1.5 ml tubes	180 x 79 x 24	1	9.409 016
24 x 1.5 ml tubes	115 x 89 x 34	1	9.409 017
24 x 2.0 ml tubes	115 x 89 x 34	1	9.409 018
25 x 2.0 ml Cryogenic tubes with round bottom	197 x 99 x 32	1	9.409 006
12 x 15.0 ml Centrifuge tubes	75 x 89 x 38	1	9.409 008

➔ Cryogenic items - please see our chapter 7.

Cryovial racks Nalgene™, PC



Thermo Scientific

Autoclavable. Space-saving. Choice of sizes to hold 25 or 50 cryovials of 1.2, 2.0 or 5 ml capacities. With moulded identification numbers and letters. One-handed operation possible.



9.400 958

Width	Length	Height	Aperture array qty.	Colour	PK	Cat. No.
mm	mm	mm				
102	197	28	5 x 10	white	1	9.400 944
102	197	22	5 x 5, staggered	blue	1	9.400 958

Floating cryovial racks Nalgene™, Type 5974, PP

For 0.5 to 2.0 ml test tubes and cryovials. Racks will float with a full load of filled tubes. With moulded identification numbers and letters.

Thermo Scientific



Type	For tubes	Description	Colour	Dimensions (W x D x H)	Array	PK	Cat. No.
	ml			mm			
5974	1.0/1.2/1.5/2.0	Square	white	103 x 103 x 65	4 x 4	1	9.400 982
5974	1.0/1.2/1.5/2.0	Circular	white	66 dia.	8	4	9.400 983
5974	1.0/1.2/1.5/2.0	Circular	white	96 dia.	20	4	9.400 984

Floating Tube Racks, PE

Polyethylene foam. Resist water absorption so racks can be washed and reused. Ideal for floating tubes in water baths, tubs, or beakers. Racks include detachable carrying handles, to lift samples out of baths easily.

Heathrow Scientific

Type	For tubes	Colour	Array	PK	Cat. No.
	ml				
Diamond	50	green	4	5	6.238 546
Parallelogram	15	blue	8	5	6.238 547
Rectangle	1.5 to 2.0	yellow	24	5	6.238 545
Round	0.2/0.5/1.5 to 2	blue	18	5	6.240 378

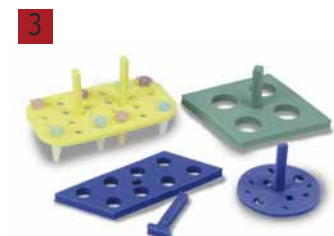

Cryogenic storage boxes Transformer™ Cube, PP



Heathrow Scientific

For storage of large samples or 15 and 50 ml tubes. Robust, rugged polypropylene construction complete with two Snap-In grids for 16 x 15 ml and 9 x 50 ml tubes. Holds tubes securely upright in deep grid wells. Locate tubes easily with numbering of inserts on lid, imprinted grid and first tube orientation. Use without grids for larger sized product storage. Fill with ice and use as a temporary low temperature workstation. Autoclavable. Dimensions: 125 x 125 x 129 mm. For temperatures from -80 to 121 °C. Purple box with clear lid.



Type	PK	Cat. No.
Box with 2 inserts	1	6.243 251

➔ Further Racks - please see page 33.

1

4.658 426

Storage tubes Matrix™ with 2D barcode and screw cap, sterile

For storage in the gas phase of liquid nitrogen. Screw cap tubes Matrix™ with 2D code for sample storage up to gas phase of liquid nitrogen. SBS format with 8x12 grid allows both manual and automated storage. The 2D screw cap tubes can be picked and sorted by a robot.

Thermo Scientific

Capacity	Description	Package contents	PK	Cat. No.
ml				
0.2	in barcoded rack	5 racks of 96	480	4.658 426
0.5	in barcoded rack	5 racks of 96	480	4.658 412
0.5	in barcoded rack, with white patch	5 racks of 96	480	4.658 413
0.5	2D and linear barcode, in barcoded rack	5 racks of 96	480	4.658 414
0.5	in barcoded rack, brown, with red cap	5 racks of 96	480	4.658 415
1.0	in barcoded rack	5 racks of 96	480	4.658 398
1.0	in barcoded rack, with white patch	5 racks of 96	480	4.658 399
1.0	2D and linear barcode, in barcoded rack	5 racks of 96	480	4.658 400
1.0	in barcoded rack, brown, with red cap	5 racks of 96	480	4.658 401

2

4.658 418

Storage tubes Matrix™ with 2D barcode and coloured screw cap, sterile

For storage in the gas phase of liquid nitrogen.

Thermo Scientific

Capacity	Colour	Description	Package contents	PK	Cat. No.
ml	Cover				
0.5	blue	in barcoded rack	5 racks of 96	480	4.658 416
0.5	grey	in barcoded rack	5 racks of 96	480	4.658 417
0.5	purple	in barcoded rack	5 racks of 96	480	4.658 418
0.5	red	in barcoded rack	5 racks of 96	480	4.658 419
0.5	white	in barcoded rack	5 racks of 96	480	4.658 420
0.5	yellow	in barcoded rack	5 racks of 96	480	4.658 425
1.0	blue	in barcoded rack	5 racks of 96	480	4.658 402
1.0	grey	in barcoded rack	5 racks of 96	480	4.658 403
1.0	purple	in barcoded rack	5 racks of 96	480	4.658 404
1.0	red	in barcoded rack	5 racks of 96	480	4.658 405
1.0	white	in barcoded rack	5 racks of 96	480	4.658 406
1.0	yellow	in barcoded rack	5 racks of 96	480	4.658 407

3

4.658 407

➔ Empty racks for storage tubes can be found in our webshop.

4

8-channel Decapper for screw cap tubes

Process a full rack of Thermo Scientific™ Matrix™ or Thermo Scientific™ Nunc™ tubes in less than one minute with this ergonomic, manual capper/decapper. The Thermo Scientific™ 8-Channel Screw Cap Capper/Decapper is designed to cap tubes to the optimal torque to maintain sample integrity and prevent sample loss during storage. The 8-channel Capper/Decapper is a practical addition to benchtop processing of screw top storage tubes.

Thermo Scientific

- Improves processing throughput of manual procedures with automated column-wise decapping and capping in just four seconds
- Ensures reproducibility by capping all tubes to the optimal torque level specified for the tube
- Allows anyone in the lab to cap or decap tubes with a light weight, easy-to-use and ergonomic design
- Stand allows easy storage of removed caps during sample processing steps
- Virtually always available for use with long battery life and quick recharge time

For tubes	PK	Cat. No.
Matrix™ ScrewTop (0.5 ml, 1.0 ml)	1	7.659 021
Matrix™ ScrewTop (0.2 ml), Nunc Cryobank (0.5 ml, 1.0 ml, 1.8 ml, 2.0 ml, 5.0 ml)	1	4.658 357

1 Capping Systems Matrix™ SepraSeal

For open tubes without screw cap.

Thermo Scientific™ Matrix™ SepraSeal tube sealing solutions complement the innovative line of Thermo Scientific Matrix 2D and non-2D coded storage tubes. Available in a range of formats, colors and sterility, there is a sealing option to meet a range of application and storage requirements.

Enhanced Materials

- Made of an advanced thermoplastic elastomer that offers excellent chemical resistance and low vapor transmission rates
- Elastomer ensures sealing performance will not degrade, even after multiple cap piercings

Sample Access Options

- Designed for storage down to -20 °C, Matrix SepraSeal mats are available in sterile, nonsterile, solid, or pre-split, in a range of colors for quick visual sample identification
- Solid seals can be removed for sample access with the Matrix SepraSeal cap removal tool
- For applications involving repetitive sample access, a pre-split Matrix SepraSeal can be pierced by automated liquid handling equipment, requiring very little pressure, while maintaining seal integrity with self sealing closure

Application Flexibility

- Individual tube capping or apply 96 caps at once
- Supplied in mats of 96 caps each, sealing is secure and consistent every time when applied with the Thermo Scientific SuperSealer

Thermo Scientific



Cover type	Description	Package contents	PK	Cat. No.
Natural	non-sterile	10 mats of 96	960	6.251 983
Blue	non-sterile	10 mats of 96	960	4.658 359
Green	non-sterile	10 mats of 96	960	4.658 360
Grey	non-sterile	10 mats of 96	960	4.658 361
Purple	non-sterile	10 mats of 96	960	4.658 362
Red	non-sterile	10 mats of 96	960	4.658 363
Yellow	non-sterile	10 mats of 96	960	4.658 364
Natural	sterile	10 mats of 96	960	4.658 300
Blue	sterile	10 mats of 96	960	4.658 365
Green	sterile	10 mats of 96	960	4.658 366
Grey	sterile	10 mats of 96	960	4.658 367
Purple	sterile	10 mats of 96	960	4.658 368
Red	sterile	10 mats of 96	960	4.658 369
Yellow	sterile	10 mats of 96	960	4.658 370
Natural	non-sterile, pre-slit	10 mats of 96	960	6.253 949
Blue	non-sterile, pre-slit	10 mats of 96	960	6.253 981
Green	non-sterile, pre-slit	10 mats of 96	960	6.253 980
Grey	non-sterile, pre-slit	10 mats of 96	960	4.658 371
Purple	non-sterile, pre-slit	10 mats of 96	960	4.658 374
Red	non-sterile, pre-slit	10 mats of 96	960	6.253 979
Yellow	non-sterile, pre-slit	10 mats of 96	960	6.253 982
Natural	sterile, pre-slit	10 mats of 96	960	6.254 687
Blue	sterile, pre-slit	10 mats of 96	960	4.658 375
Green	sterile, pre-slit	10 mats of 96	960	4.658 376
Grey	sterile, pre-slit	10 mats of 96	960	4.658 377
Purple	sterile, pre-slit	10 mats of 96	960	4.658 378
Red	sterile, pre-slit	10 mats of 96	960	4.658 379
Yellow	sterile, pre-slit	10 mats of 96	960	4.658 380
Natural	sterile, pre-slit	1 bag of 500	500	4.658 312
	Cap Removal Tool		1	6.254 390

2 2D Barcode Reader VisionMate™ ST for single tubes

The Thermo Scientific™ VisionMate™ ST Barcode Reader is a compact single tube reader used for instant scanning of individual 2D barcoded tubes into any file or database application. Simple plug-and-play installation via automatically installed USB port allows simple and easy set up. USB working temperature: 4 to 30 °C.

- Instant read time
- Simple to install and use
- For individual sample retrieval
- Export via comma-separated variable file, Microsoft® Excel™, XML, COM port, ODBC or TCP socket
- Supported Barcode Type: any Thermo Scientific 2D Barcoded Storage Tube as well as virtually any other tube with high contrast 2D codes

Thermo Scientific



Type	Dimensions (W x D x H) mm	Weight kg	PK	Cat. No.
VisionMate™ ST	111 x 87 x 70	0.8	1	6.268 861

1

1 Liquid nitrogen container BIO GT, aluminium

NEW

KGW

For storage and transport of biological materials.

- Super-insulation foil in the vacuum space
- Low evaporation rate
- Transport handle
- With vacuum valve
- Loose lid-on plug
- Canister made of stainless steel

Type	Capacity	External dimensions (Ø x H) mm	No. of vials 2ml	No. of straws 0.25 ml	No. of canisters	Static holding time Days	PK	Cat. No.
	L							
GT 2K *	2.0	174 x 392		330	3	25	1	4.672 667
GT 3	3.7	250 x 405		1560	6	33	1	9.524 383
GT 11	12.2	308 x 630	180	3120	6	130	1	9.524 386
GT 21	21.0	388 x 660	180	3120	6	225	1	7.982 553
GT 26	26.7	468 x 460		7380	9	90	1	9.524 392
GT 38	37.0	468 x 715	612	9840	6	245	1	9.524 393
GT 40	40.0	468 x 710	1200	16400	10	140	1	9.524 394

* Canister made of plastic

2

2 Liquid nitrogen container, aluminium

NEW

KGW

For storage and transport of liquid nitrogen.

- Super-insulation foil in the vacuum space
- Low evaporation rate
- Vacuum valve
- Small-flange KF NW 50
- Loosely resting plug

Type	Capacity	External dimensions (Ø x H) mm	Evaporation rate	Weight empty/full	Static holding time Days	PK	Cat. No.
	L		L/ day	kg			
ALU 10	12.0	305 x 550	0.2	6 / 14	67	1	6.256 041
ALU 26	26.0	388 x 670	0.2	14 / 35	130	1	6.257 855
ALU 35	34.0	468 x 655	0.24	16 / 43	140	1	6.238 955
ALU 60	60.0	468 x 870	0.4	21.5 / 70	150	1	6.235 695

Accessories for liquid nitrogen container made of aluminium

KGW

Description	PK	Cat. No.
Transfer siphon EK1 incl. safety valve, manometer, pressure reduction valve made of stainless steel, fluid valve made of stainless steel, clamp and O-ring	1	6.234 251
Transfer tube made of stainless steel, 1.5 m	1	7.621 719
Transfer tube with phase separator	1	6.234 252
Screw coupling for pipes (OD 8 mm)	1	6.226 301
Screw adapter	1	6.226 302
Clamp for KF NW 50	1	6.234 253
O-ring KF NW 50 with centering	1	6.234 254

3

3 CryoStor Storage Cane 6-fold Aluminium

Thermo Scientific

- For frozen storage of cryovials.
- Also suitable for tubes protected with Thermo Scientific™ CryoFlex™ tubing
- Compatible with colour coders that attach to the end of the cane and can be written on

Length mm	PK	Cat. No.
290	50	6.084 320

4

4 Aluminium holder Nalgene™ CryoCane™, Type 5015

Thermo Scientific

For frozen storage of cryovials 1.2, 1.5 or 2.0 ml.

For	Type	Length mm	PK	Cat. No.
5 cryovials	5015	290	1	9.400 956
6 cryovials	5015	300	12	9.400 935

7. Heating and cooling technology

Cooling/Liquid nitrogen-Accessories-Dewar flasks

1 Sleeve Nalgene™ CryoSleeve™, Type 5016

Made of transparent PVC. For KryoCane™ aluminium vial holder.

Thermo Scientific

Type	Length mm	PK	Cat. No.
5016	273	100	9.400 957



2 Dewar flasks Nalgene™, Type 4150, HDPE

With vented, insulating HDPE lid. PE covered handle. Unbreakable and completely safe for short term storage of ice water, dry ice solvents and liquid nitrogen.

Also suitable for use as warming baths. Chemical-resistant, reinforced walls, filled with urethane foam, are temperature resistant from -196 to +100 °C.

1, 2 and 4 litre flasks have a carrying handle.

Thermo Scientific

Type	Capacity Litres	Top diam. mm	Int. height mm	PK	Cat. No.
4150	1	96	195	1	9.031 961
4150	2	122	231	1	9.031 962
4150	4	158	259	1	9.031 964
4150	10	198	396	1	9.031 970



3 Dewar flasks, shallow form, for CO₂ and LN₂

DURAN®. DIN 12492. Dish-shaped. Generally for thermostating round bottom flasks to a constant temperature as hot or cold baths. With structured aluminium casing and edge protection. Suitable for use with magnetic stirrers.

KGW

Capacity ml	Int. diam. mm	Height mm	PK	Cat. No.
120	77	50	1	9.032 422
260	100	65	1	9.032 423
400	110	70	1	9.032 425
680	138	80	1	9.032 426
1600	170	110	1	9.032 427
3000	200	125	1	6.075 807



Dewar carrying flasks, cylindrical, for CO₂ and LN₂

DURAN®. DIN EN ISO 16496. Cylindrical design with insulated lid, held by two spring clips and aluminium carrying handle. For cooling, storage and transport of small samples of temperature-sensitive goods e.g. with liquid nitrogen (LN₂) or dry ice (CO₂).

When storing liquid nitrogen (LN₂) or CO₂ a hole (diam. approx. 2 mm) in centre of the lid is necessary that no overpressure can arise in the vessel.

Type B: blue-coated metal cover

Type BE: stainless steel cover

Type	Capacity Litres	Int. diam. mm	Int. height mm	PK	Cat. No.
26 B	1	100	150	1	9.032 726
27 B	2	138	170	1	9.032 727
28 B	3	138	230	1	9.032 728
29 B	4	138	310	1	9.032 729
26 BE	1	100	150	1	9.032 736
27 BE	2	138	170	1	9.032 737
28 BE	3	138	230	1	9.032 738
29 BE	4	138	310	1	9.032 739



Cooling/Dewar flasks

1 2 3 4 Dewar vessels, cylindrical, for CO₂ and LN₂

DURAN®. DIN 12492. Cylindrical. Borosilicate glass 3.3. With blue coated protective casing out of metal or structured aluminium casing. Large opening. With insulated lid. Carrying handles as indicated. For cooling and storage of temperature-sensitive goods e.g. with dry ice (CO₂). When storing liquid nitrogen (LN₂) a hole (diam. approx. 2 mm) in centre of the lid is necessary.

KGW

Capacity l	Int. diam. mm	Int. height mm	Figure	With	PK	Cat. No.
10	200	350	a	Handle	1	9.032 131
10	200	350	d	Handle	1	9.032 742
14	200	500	a	Handle	1	9.032 132
14	200	500	d	Handle	1	6.070 411
21	250	480	c	Side grips	1	9.032 133
21	250	480	b	Side grips	1	9.032 743
28*	250	620	c	Side grips	1	9.032 134
28	250	620	b	Side grips	1	6.300 165

*Linen bag included.



a



b



c



d

5

5 Dewar flasks, cylindrical, for CO₂ and LN₂

DURAN®. DIN EN ISO 16496. Cylindrical. With blue coated protective casing made of metal. All vessels can also be supplied without casing, unsilvered or silvered with opposite viewing strips. Stoppers - please order separately.

KGW



Type	Capacity ml	Int. diam. mm	Int. height mm	PK	Cat. No.
00 C	100	40	90	1	9.032 011
0 C	200	40	170	1	9.032 012
1 C	300	47	190	1	9.032 013
2 C	450	47	270	1	9.032 014
3 C	500	57	210	1	9.032 015
4 C	750	57	310	1	9.032 016
5 C	1250	57	500	1	9.032 017
6 C	800	67	240	1	9.032 018
7 C	1200	67	350	1	9.032 019
9 C	1000	77	235	1	9.032 021
10 C	1500	77	345	1	9.032 022
11 C	2100	77	500	1	9.032 023
12 C	1500	90	245	1	9.032 024
13 C	2000	90	340	1	9.032 025
14 C	3200	90	600	1	9.032 026
15 C	1500	100	240	1	9.032 027
16 C	2000	100	290	1	9.032 028
17 C	4000	100	600	1	9.032 029
18 C	2500	110	290	1	9.032 030
19 C	5000	110	600	1	9.032 031
20 C	3000	138	230	1	9.032 032
S 21 C	4000	138	310	1	9.032 033
S 22 C	8000	138	600	1	9.032 034

7. Heating and cooling technology

Cooling/Dewar flasks

1 Dewar flasks, cylindrical, with side grip

DURAN®. DIN EN ISO 16496.

KGW

With blue coated protective casing out of metal and side grip.

Type	Capacity ml	Int. diam. mm	Ext. diam. mm	Int. height mm	PK	Cat. No.
G0C	200	40	56	170	1	7.200 338
G1C	300	47	60	190	1	6.803 703
G3C	500	57	70	210	1	6.800 771
G6C	800	67	80	240	1	6.083 078
G9C	1000	77	95	235	1	6.053 660
G7C	1200	67	80	350	1	6.078 740
G10C	1500	77	95	345	1	6.059 732
G12C	1500	90	115	245	1	6.076 560
G13C	2000	90	115	340	1	6.076 997
G15C	1500	100	120	240	1	6.070 692
G16C	2000	100	120	290	1	6.801 610
G18C	2500	110	130	290	1	6.070 548
GS21C	4000	138	160	310	1	6.090 309



2 Chrome steel Dewar flasks

Nickel chromium steel, unbreakable, open top. With high-vacuum, permanent insulation. Temperature range -269 to +300 °C. 5 year insulation guarantee.

Capacity L	Tubing i.d. mm	Int. height mm	PK	Cat. No.
0.5	180	79	1	9.031 981
1.0	88	207	1	9.031 982
1.0	103	158	1	9.031 983
2.0	103	286	1	9.031 984
3.0	159	189	1	9.031 985
6.0	269	189	1	9.031 986



3 Lid in cork for chrome steel Dewar flasks

Cork.

For	PK	Cat. No.
0,9 l (9.031 981)	1	9.031 971
1,0 l (9.031 982)	1	9.031 972
1,0-2,0 l (9.031 983 + 9.031 984)	1	9.031 973
3,0-6,0 l (9.031 985 + 9.031 986)	1	9.031 975



4 Dewar flasks, spherical, for LN₂

DURAN®. DIN 16496. Spherical. Brushed aluminium casing with insulating lid and carrying handle.

KGW

Capacity Litres	Neck diam. mm	Ext. diam. mm	PK	Cat. No.
1	30	175	1	9.032 740
3	60	225	1	9.032 741
5	60	260	1	9.032 115
10	65	330	1	9.032 127



1

9.699 310

Ultra low temperature freezer, ULUF, up to -90 °C

- Low energy consumption
- Low noise level, low heat dissipation
- Insulated inner doors
- Castors
- Lock on door
- Ergonomic loading
- Heated door frame, heated vacuum valve
- 100 % HCFC/CFC free
- Premade porthole for external temperature probes (diam. 11 mm)
- Single-compressor (ULUF 15, 65, 125, 450, 550) or two compressor systems (ULUF 750) as security in case of failure of a compressor.

Arctiko

Controller features

- Temperature graph
- Micro processor controller with digital display
- Approx. 72 hours battery back up for alarms, loggings and temperature display in case of power cut
- Visual and acoustic alarm, adjustable high/low temperature alarm, power failure alarm, probe failure alarm, instrument failure alarm, open door alarm, contact for remote alarm, prepared for GSM alarm
- Prepared for connection of 2 additional probes
- Integrated data logger (software included)
- RS485/232 Interface
- Computer USB data read out
- Direct download/upload on/from USB memory stick
- Auto cycle if probe failure
- Ambient temperature display
- Shows all alarms as text (no codes)
- 3-level password protected
- Battery level indication
- Integrated memory
- Display text available in different languages

Accessories (optional on request): Racks and boxes, CO₂ backup system, GSM alarm module, cryo gloves, water cooled condensers.

5 year warranty on the compressor.

2

9.699 311

Type	Capacity	External dimensions (W x D x H) mm	Internal dimensions (W x D x H) mm	Temp. range	Weight kg	PK	Cat. No.
	Litres			max. °C			
ULUF 15	7	400 x 630 x 665	150 x 143 x 310	-90 ... -40	55	1	6.264 066
ULUF 65	55	600 x 700 x 810	360 x 468 x 320	-86 ... -40	80	1	9.699 310 1
ULUF 125	115	950 x 725 x 810	360 x 493 x 530	-86 ... -40	100	1	9.699 311 2
ULUF 450-2M	393	720 x 885 x 1990	480 x 608 x 1345	-86 ... -40	175	1	6.266 243
ULUF 550-2M	556	920 x 885 x 1990	680 x 608 x 1345	-86 ... -40	203	1	7.983 050
ULUF 750-2M*	646	1030 x 885 x 1989	790 x 680 x 1345	-86 ... -40	254	1	6.290 902

*Dual Cooling System: Increased safety due to 2 separate cooling systems.

3

3 Ultra-low temperature freezer, UFV series up to -90 °C

NEW

BINDER

The ultra-low freezers are suitable for the stable long-term storage of sensitive samples and guarantee a constant low temperature. The ultra-low freezers are designed for -90 °C, but can be used in a temperature range from -40 °C to -90 °C.

- Climate-neutral refrigerants R-290 and R-170
- Interior completely made of stainless steel
- Powerful cascade compression refrigeration machine
- Efficient thermal insulation through vacuum insulation panels
- Removable interior doors made of stainless steel
- 3 flexibly positionable shelves made of stainless steel
- Water cooling (depending on variant)
- Optical and acoustic alarms

Specifications

Temperature range:	-90 ... -40 °C
Port hole:	2 x Ø 28 mm, rear
Interface:	Ethernet
Power supply:	230 V/50 Hz
Warranty:	5 years

Type	Description	Capacity	External dimensions (W x D x H) mm	Internal dimensions (W x D x H) mm	PK	Cat. No.
		Litres				
UFV500	Standard	477	826 x 938 x 1966	606 x 605 x 1300	1	4.668 590
UFV700	Standard	700	1110 x 938 x 1966	890 x 605 x 1300	1	4.664 563
UFV500	With water cooling	477	826 x 938 x 1966	606 x 605 x 1300	1	4.668 591
UFV700	With water cooling	700	1110 x 938 x 1966	890 x 605 x 1300	1	6.275 022

Ultra low temperature Upright Freezers, ULT Series, up to -86 °C



1

Supreme stability, reliability, user-friendliness and small dimensions make these freezers the perfect choice for use inside the lab. For temporary to long term storage. Low power consumption, natural refrigerant, cyclopentane insulation combined with recyclable materials, makes these freezers very environmental friendly. The unit is easy to install. Due to the small footprint, transport through all standard sized doors is possible. In combination with a low weight, it is also easy to move around. The material is galvanized and pre-coated steel on the outside and stainless steel on the inside.

Nordiclub ApS



4.672 429

- Temperature logger with USB port
- Data logging 35.000 Entries
- Battery Backup for min. 48 h
- Digital controller with display
- High/low temperature alarm
- Door alarm
- Contact for remote alarm
- Porthole for external probe & CO₂ backup Ø12 mm
- Eco-friendly, HCFC-free Nature R refrigerant

Extended exchange warranty - in warranty cases which cannot be quickly solved onsite the client receives a new unit.

Racks must be ordered separately.

Specifications

Adjustable shelves, stainless steel:	2 (5 for U250)
Internal humidity:	<5 %
Temperature probes:	1/PT 1000
Noise level:	57 dB (64 dB for U250)
Power consumption 24/h:	6.2 kWh (12.8 kWh for U250)
Power supply:	230 V/50 Hz

Type	Capacity	Internal dimensions (W x D x H) mm	External dimensions (W x D x H) mm	Weight kg	Temp. range max. °C	PK	Cat. No.
	Litres						
ULT U100, under bench	91	430 x 425 x 625	595 x 630 x 830	60	-86 ... -60	1	4.672 428
ULT U250	221	435 x 370 x 1420	600 x 630 x 2055	122	-86 ... -60	1	4.672 429

Ultra low temperature Chest Freezers, ULT Series, up to -86 °C



2

Freezer for temporary to longer term storage or daily use. Ideal where space is limited, but the user still needs a regular storage capacity. Low power consumption, natural refrigerant, cyclopentane insulation combined with recyclable materials, makes these freezers very environmental friendly. The unit is easy to install. Due to the small footprint, transport through all standard sized doors is possible. The freezer also has four castors, which makes it very mobile. The material is galvanized and pre-coated steel on the outside and precoated white steel on the inside.

Nordiclub ApS



4.672 427

- Digital controller with display
- Audible and visual alarm
- High/low temperature alarm
- Contact for remote alarm
- Battery Backup 48 h
- Porthole for external probe & CO₂ backup Ø12 mm
- Eco-friendly, HCFC-free Nature R refrigerant

Extended exchange warranty - in warranty cases which cannot be quickly solved onsite the client receives new unit.

Racks must be ordered separately.

Specifications

Internal humidity:	<5 %
Temperature probes:	1/PT 1000
Noise level:	55 dB
Power consumption 24/h (kWh):	5.1 (C75), 5.3 (C200), 8.1 (C300), 9.1 (C400)
Power supply:	230 V/50 Hz

Type	Capacity	Internal dimensions (W x D x H) mm	External dimensions (W x D x H) mm	Weight kg	Temp. range max. °C	PK	Cat. No.
	Litres						
ULT C75	71	390 x 390 x 465	555 x 580 x 930	45	-86 ... -60	1	4.672 424
ULT C200	189	550 x 440 x 635	920 x 630 x 890	65	-86 ... -60	1	4.672 425
ULT C300	284	890 x 440 x 635	1265 x 630 x 890	71	-86 ... -60	1	4.672 426
ULT C400	368	1190 x 440 x 635	1560 x 630 x 890	80	-86 ... -60	1	4.672 427

➔ Accessories please see page 780.

Ultra low temperature freezer, ULTF series, up to -86 °C

The ULTF range shows that high performance freezing with focus on low energy consumption is the future. The range has been updated with our advanced Arctiko controller which ensures that all alarm and data logging features are included as standard. The ULTF range is produced with the true and original single compressor technology which ensures the lowest noise level available.

Arctiko

- Single compressor
- Low energy consumption
- Low noise level
- Low heat dissipation
- 100% HCFC/CFC free
- Sub lids
- Castors and key lock
- Prepared porthole for external temperature probes

Controller features

- Temperature graph
- Micro processor controller with digital display
- Approx. 72 hours battery back up for alarms, loggings and temperature display in case of power cut
- Visual and acoustic alarm
- Adjustable high/low temperature alarm
- Power, probe and instrument failure alarm,
- Open door alarm
- Contact for remote alarm
- Prepared for GSM Alarm
- Prepared for connection of 2 additional probes
- Integrated data logger
- RS485/232 Interface
- Direct upload of new software via USB memory stick
- Direct download of logged data on USB memory stick
- Auto cycle in case of probe failure
- Ambient temperature display
- Shows all alarms (displayed as text, no codes)
- 3-level password protected
- Battery level indication
- Integrated memory for 30 years
- Display text available in different languages

5 year warranty on the compressor.

Type	Capacity	External dimensions (W x D x H) mm	Internal dimensions (W x D x H) mm	Temp. range	Weight	PK	Cat. No.
	Litres			max. °C	kg		
ULTF 80	71	552 x 648 x 850	390 x 390 x 450	-86 ... -40	53	1	9.699 320 1
ULTF 220	189	920 x 695 x 885	760 x 440 x 635	-86 ... -40	64	1	9.699 321
ULTF 320	284	1262 x 698 x 885	1100 x 440 x 630	-86 ... -40	76	1	9.699 322
ULTF 420	368	1562 x 698 x 885	1400 x 440 x 630	-86 ... -40	88	1	9.699 323 2

1



9.699 320

2



9.699 323

Freezer boxes B35-50/B35-85, up to -85 °C

The cold boxes are small benchtop units for cooling and freezing in all laboratories. Due in particular to its compact space-saving design and the low-noise cooling unit, the cold box is suitable for direct use in the workplace.

Fryka-Kältetechnik

- Vacuum-Insulation: large interior space with small external dimensions and low power consumption
- Extremely low noise refrigeration unit
- Models with temperature range -85 °C with two-stage cascade refrigeration system
- with natural refrigerants (R-290, R-170)
- Interior made of high quality stainless steel
- Interior without fittings allows easy cleaning and disinfection
- Side air vent, so suitable for installation directly on walls
- Bushing (diameter 10 mm), e.g. for temperature monitoring with external sensors
- Maximum safety, due to mains-independent alarm, battery lasting approx. 72 hours
- Visual and audible signal
- Microprocessor-controlled with membrane keyboard and easy-to-read LED display
- Potential-free contact for connection to an external alarm system
- RS485 interface
- 100 mV/K-output for connection to a temperature recording system
- Lockable insulating door with door frame heating and double magnetic seal with additional sealing surface
- Stackable unit, max. 2 units

Cold boxes B35 //logg:

- Touchscreen control with color display and integrated data logger for full traceability
- User-friendly menu structure, remote access via network/internet
- Real-time display of the temperature profile and further values
- Recording the temperature profiles and alarm events
- Integrated memory with up to 12 years memory capacity
- Data for transfer to PC can be read out via USB interface
- Ethernet interface (RJ45)

Stainless steel shelf B 35-RS: 5 drawers, each for 6 standard cryoboxes (135 x 135 x 52 mm).
Extra gaps for optimal, uniform and rapid cooling of the entire frozen product (please order separately).

Specifications

Control accuracy: ±1 K
 Ambient temperature: +12 to +30 °C
 Power supply: 230 V/50 Hz

Type	Capacity	Internal dimensions (W x D x H) mm	External dimensions (W x D x H) mm	Weight kg	Temp. range max. °C	PK	Cat. No.
	Litres						
B 35-50	35	425 x 300 x 280	580 x 765 x 540	65	-50 ... -10	1	6.284 402
B 35-50 //logg	35	425 x 300 x 280	580 x 765 x 580	65	-50 ... -10	1	6.284 403
B 35-85	35	425 x 300 x 280	580 x 765 x 540	81	-85 ... -50	1	7.982 609
B 35-85 //logg	35	425 x 300 x 280	580 x 765 x 580	81	-85 ... -50	1	6.284 404
Shelf B 35-RS						1	6.284 406

1



7.982 609

2



6.284 406

3



6.284 406

FRYKA

COOLING AND FREEZING UP TO

-85°C



**MADE
IN
GERMANY**

Cooling and freezing of gases, liquids and solids

Robust and durable technology, sophisticated functions as well as a particularly simple handling: All that makes FRYKA recirculating chillers and freezers the first choice in many segments of modern research and industry.

www.fryka.de

Underbench freezers TUS 50-100/TUS 80-100, up to -80 °C

The freezers have a usable space of 100 litres and can be used for cooling and freezing in industrial and scientific laboratories. Particularly due its compact, space-saving design with low-noise cooling unit, the underbench freezer is suitable for use directly under or even on the desk at work.

Fryka-Kältetechnik

- Vacuum-Insulation: large interior space with small external dimensions and low power consumption
- Extremely low noise refrigeration unit
- Models with temperature range -80 °C: with two-stage cascade refrigeration system
- With natural refrigerants (R-290, R-170)
- Interior made of high quality stainless steel
- Bushing (diameter 19 mm), e.g. for temperature monitoring with external sensors
- Maximum safety, due to mains-independent alarm, battery lasting approx. 72 hours
- Visual and audible signal
- Microprocessor-controlled with membrane keyboard and easy-to-read LED display
- Potential-free contact for connection to an external alarm system
- RS485 interface
- 100 mV/K-output for connection to a temperature recording system
- Lockable insulating door with door frame heating and double magnetic seal with additional sealing surface
- One Inlaid grille included
- Optionally available: Four fixed rollers, two with a brake, H: 805 mm.
Stainless steel shelf TS 100-RS (alternative to Inlaid grille): For 81 standard cryoboxes.
Nine drawers, each for nine standard cryoboxes. Extra gaps for optimum, uniform and rapid cooling of all the refrigerated items.

Underbench freezers TUS 50-100/TUS 80-100 //logg:

- Touchscreen control with color display and integrated data logger for full traceability
- User-friendly menu structure, remote access via network/internet
- Real-time display of the temperature profile and further values
- Recording the temperature profiles and alarm events
- Integrated memory with up to 12 years memory capacity
- Data for transfer to PC can be read out via USB interface
- Ethernet interface (RJ45)

Specifications

Control accuracy:	±1 K
Ambient temperature:	+12 to +30 °C
Power supply:	230 V/50 Hz

Type	Capacity	Internal dimensions (W x D x H) mm	External dimensions (W x D x H) mm	Weight kg	Temp. range max. °C	PK	Cat. No.
	Litres						
TUS 50-100	100	450 x 450 x 500	950 x 730 x 750	120	-50 ... -10	1	6.284 408
TUS 50-100 //logg	100	450 x 450 x 500	950 x 730 x 750	120	-50 ... -10	1	6.284 409
TUS 80-100	100	450 x 450 x 500	950 x 730 x 750	120	-80 ... -50	1	6.284 410
TUS 80-100 //logg	100	450 x 450 x 500	950 x 730 x 750	120	-80 ... -50	1	6.284 411
Shelf TS 100-RS						1	6.284 416
Inlaid grille (additional)						1	6.284 419

1



6.284 410

2



6.284 411

3



6.284 416

Chest freezers TT 50-90/TT 85-90, up to -85 °C

NEW

Fryka-Kältetechnik

The chest freezers are used successfully in the laboratory as well as in industry due to their compact design, their technical properties and their reliability. The use of vacuum insulation panels (VIP), enables a extensive interior space with compact external dimensions. The interior is made of high-grade stainless steel. Models with temperature range -85 °C have a two-stage cascade refrigeration system for high performance and high safety. A bushing (diameter 19 mm) enables temperature monitoring with external sensors.

- Extremely quiet cooling unit, with natural refrigerants (R-290, R-170)
- Visual and acoustic alarm signal
- Lockable cover latch with lever action
- Microprocessor-controlled adjustment with membrane keyboard and LED display
- Independant alarm system, with battery capacity for approx. 72 hours
- Interface (RS485)

TT 50-90 logg/TT 85-90 logg:

- Touchscreen control with color display and integrated data logger
- Remote access via network/internet
- Real-time display of the temperature profile and further values
- Recording the temperature profiles and alarm events
- Integrated memory with up to 12 years memory capacity
- Data for transfer to PC can be read out via USB interface
- Ethernet interface (RJ45)

Specifications

Ambient temperature:	12 ... 30 °C
Control accuracy:	±0.5 K
Power supply:	230 V/50 Hz

Type	Capacity	Internal dimensions (W x D x H) mm	External dimensions (W x D x H) mm	Weight kg	Temp. range max. °C	PK	Cat. No.
	Litres						
TT 50-90	90	590 x 430 x 370	760 x 710 x 880	92	-50 ... -10	1	6.284 420
TT 50-90 logg	90	590 x 430 x 370	760 x 710 x 880	92	-50 ... -10	1	6.284 421
TT 85-90	90	590 x 430 x 370	760 x 710 x 880	110	-85 ... -50	1	6.284 422
TT 85-90 logg	90	590 x 430 x 370	760 x 710 x 880	110	-85 ... -50	1	6.284 423

2 TT 90-RC stainless steel shelf for TT 50-90/TT 85-90

NEW

Fryka-Kältetechnik

Extra gaps ensure optimal, uniform and rapid cooling of all the refrigerated items.

- For storage of 6 standard cryoboxes (135 x 135 x 52 mm) per shelf
- 12 shelves possible per chest

Type	PK	Cat. No.
Stainless steel shelf TT 90-RC	1	6.284 424

1

6.284 423

2

7. Heating and cooling technology

Cooling/Low and Ultra low temperature freezers

Ultra low temperature freezers HDE/TDE series, to -86 °C

NEW

1

Environmentally friendly, energy-saving freezers with a temperature range from -50 to -86 °C.

Thermo Scientific

- Maximum 24 minutes temperature recovery time after door opening
- Ergonomic design
- Very quiet operation below 53 dB (A)
- Compatible with most racking systems
- Natural refrigerants based on hydrocarbons
- Water-blown foam insulation: avoids harmful emissions and reduces long-term propellant outgassing
- Capacity for 300-600 boxes depending on model
- Intuitive touch-screen operation with display of all relevant data
- Data logger function with secure cloud storage option and smartphone connection

Herafreeze™ HDE models with 5 interior doors and 5 compartments for inserts < 24 cm height
TDE models with 4 interior doors and 4 compartments for units < 30 cm height



6.311 315

2



4.668 940

Type	For	Capacity	Internal dimensions (W x D x H) mm	External dimensions (W x D x H) mm	PK	Cat. No.
		Litres				
HDE 30086 FV	300 x 5 cm boxes	422	452 x 719 x 1301	584 x 977 x 1981	1	6.311 317
HDE 40086 FV	400 x 5 cm boxes	549	588 x 719 x 1301	719 x 977 x 1981	1	4.668 935
HDE 50086 FV	500 x 5 cm boxes	682	730 x 719 x 1301	864 x 977 x 1981	1	6.311 315
HDE 60086 FV	600 x 5 cm boxes	816	873 x 719 x 1301	1006 x 977 x 1981	1	4.668 936
TDE 30086 FV	300 x 5 cm boxes	422	452 x 719 x 1301	584 x 977 x 1981	1	4.668 937
TDE 40086 FV	400 x 5 cm boxes	549	588 x 719 x 1301	719 x 977 x 1981	1	4.668 938
TDE 50086 FV	500 x 5 cm boxes	682	730 x 719 x 1301	864 x 977 x 1981	1	4.668 939
TDE 60086 FV	600 x 5 cm boxes	816	873 x 719 x 1301	1006 x 977 x 1981	1	4.668 940

Upright Freezers LT/XLT Series, up to -65 °C

NEW

3

Freezer for temporary to longer term storage or daily use. Ideal where space is limited, but the user still needs a regular storage capacity. The unit is easy to install. Due to the small footprint, transport through all standard sized doors is possible. The freezer also has four castors with brakes, which makes it very mobile. The material is galvanized and pre-coated steel on the outside, stainless steel on the inside and cyclopentane for efficient insulation.

Nordiclab ApS

- Temperature logger with USB port
- Data logging 35.000 Entries
- Battery Backup 48 h
- Digital controller with display
- High/low temperature alarm
- Door alarm
- Contact for remote alarm
- Porthole for external probe & CO₂ backup Ø12 mm
- Integrated lock
- Eco-friendly, HCFC-free Nature R refrigerant (MLT U250 with HCFC-free R290 refrigerant)
- ISO 9001, 14001 & 18001 OHSAS Certified

Extended exchange warranty - in warranty cases which cannot be quickly solved onsite the client receives a new unit.

Racks must be ordered separately.

Specifications

Adjustable shelves, stainless steel:	5
Internal humidity:	<5 %
Temperature probes:	1/PT 1000
Noise level:	60 dB (57 dB for MLT U250)
Power consumption 24/h:	6.25 kWh (5.3kWh for LT U250)
Power supply:	230 V/50 Hz



4.672 436

Type	Capacity	Internal dimensions (W x D x H) mm	External dimensions (W x D x H) mm	Weight kg	Temp. range max. °C	PK	Cat. No.
	Litres						
MLT U250	236	440 x 430 x 1439	600 x 690 x 2055	115	-30 ... -15	1	4.672 443
LT U250	236	420 x 370 x 1420	600 x 690 x 2055	115	-45 ... -10	1	4.672 442
XLT U250	221	420 x 370 x 1420	600 x 690 x 2055	120	-65 ... -30	1	4.672 436

1

4.672 437

Chest Freezers LT/XLT Series, up to -65 °C

NEW

Nordiclub ApS

Freezer for temporary to longer term storage or daily use. Ideal where space is limited, but the user still needs a regular storage capacity. The unit is easy to install.

Due to the small footprint, transport through all standard sized doors is possible. The freezer also has four castors (XLT C75 without castors, with legs), which makes it very mobile. The material is galvanized and pre-coated steel on the outside, precoated white steel on the inside and cyclopentane for efficient insulation.

- Digital controller with display
- Audible and visual alarm
- High/low temperature alarm
- Porthole for external probe & CO₂ backup Ø12 mm
- Integrated lock
- Eco-friendly, HCFC-free Nature R refrigerant at -65 °C and HCFC-free R290 refrigerant at -45 °C
- ISO 9001, 14001 & 18001 OHSAS Certified

Extended exchange warranty - in warranty cases which cannot be quickly solved onsite the client receives a new unit.

Racks must be ordered separately.

Specifications

Baskets:	1 (3 for LT C500 and XLT C300/C500/4 for XLT C400)
Internal humidity:	<5 %
Temperature probes:	1/PTC at -45 °C/1/PT 1000 at -65 °C
Noise level:	55 dB
Power supply:	230 V/50 Hz

Type	Capacity	Internal dimensions (W x D x H) mm	External dimensions (W x D x H) mm	Weight kg	Temp. range max. °C	PK	Cat. No.
	Litres						
LT C150	133	350 x 440 x 635	720 x 630 x 890	51	-45 ... -10	1	4.672 437
LT C200	189	550 x 440 x 635	920 x 630 x 890	65	-45 ... -10	1	4.672 438
LT C300	284	890 x 440 x 635	1260 x 630 x 890	71	-45 ... -10	1	4.672 439
LT C400	368	1190 x 440 x 635	1560 x 630 x 890	80	-45 ... -10	1	4.672 440
LT C500	476	1290 x 500 x 640	1660 x 690 x 890	108	-45 ... -10	1	4.672 441
XLT C75	71	390 x 390 x 465	555 x 580 x 900	48	-65 ... -30	1	4.672 430
XLT C150	133	350 x 440 x 635	720 x 630 x 890	56	-65 ... -30	1	4.672 431
XLT C200	189	550 x 440 x 635	920 x 630 x 890	65	-65 ... -30	1	4.672 432
XLT C300	284	890 x 440 x 635	1260 x 630 x 890	71	-65 ... -30	1	4.672 433
XLT C400	268	1190 x 440 x 635	1560 x 630 x 890	80	-65 ... -30	1	4.672 434
XLT C500	476	1290 x 500 x 640	1660 x 690 x 890	108	-65 ... -30	1	4.672 435

Racks for Upright and Chest Freezers and Ultra low temperature Freezers, LT/XLT/ULT Series

NEW

Nordiclub ApS

Type	Dimensions (W x D x H)	No. of racks	Boxes/ Racks	Height Box mm	PK	Cat. No.
	mm					
XLT C75, ULT C75	140 x 140 x 445	5	8	50	1	4.672 445
XLT C75, ULT C75	140 x 140 x 406	5	5	75	1	4.672 448
XLT C75, ULT C75	140 x 140 x 425	5	4	100	1	4.672 451
ULT U100	420 x 416 x 590	1	74	50	1	4.672 458
ULT U100	420 x 416 x 590	1	45	75	1	4.672 461
ULT U100	420 x 416 x 590	1	33	100	1	4.672 463
LT C150-500, XLT C150-500, ULT C200-400	140 x 140 x 335	3	6	50	1	4.672 444
LT C150-500, XLT C150-500, ULT C200-400	140 x 140 x 610	6	11	50	1	4.672 446
LT C150-500, XLT C150-500, ULT C200-400	140 x 140 x 326	3	4	75	1	4.672 447
LT C150-500, XLT C150-500, ULT C200-400	140 x 140 x 629	6	8	75	1	4.672 449
LT C150-500, XLT C150-500, ULT C200-400	140 x 140 x 320	3	3	100	1	4.672 450
LT C150-500, XLT C150-500, ULT C200-400	140 x 140 x 530	6	5	100	1	4.672 452
LT U250, XLT U250, ULT U250	135 x 280 x 225	3	8	50	1	4.672 453
LT U250, XLT U250, ULT U250	135 x 280 x 275	12	10	50	1	4.672 457
LT U250, XLT U250, ULT U250	135 x 280 x 160	3	4	75	1	4.672 459
LT U250, XLT U250, ULT U250	135 x 280 x 240	12	6	75	1	4.672 460
LT U250, XLT U250, ULT U250	135 x 280 x 210	15	4	100	1	4.672 462

1 Mini-Freezer KBT 08-51, up to -50 °C

The mini-freezers are the ideal solution for chilling material samples directly at the workplace.

Fryka-Kältetechnik

1



- Electronic temperature control with LED display, 2 controls available
- Refrigeration unit: low noise, air-cooled, low maintenance
- with natural refrigerant R-1270
- Housing parts made of high quality stainless steel
- Insulated stainless steel hinges and hinged lid with magnetic seal
- Ram protection ring going over and under

ST71 control

- Electronic temperature control with LED display
- Optical and acoustic alarm

ST100 control

- Microprocessor-controlled, with membrane keyboard and easy-to-read LED display
- Protection against unintentional activation
- Alarm system that is separate from the mains, with battery capacity for approx. 72 hours
- Display of the maximum temperature reached in the interior area during the fault
- RS485 interface, potential-free contact for connection to an external alarm system and 100 mV/K output
- Optical and acoustic alarm

Specifications

Temperature range:	-50 ... -30 °C
Control accuracy:	±1 K
Capacity:	8 l
Ambient temperature:	12 ... 30 °C
Dimensions, internal (W x D x H):	150 x 300 x 200 mm
Dimensions, external (W x D x H):	360 x 490 x 570 mm
Weight:	36 kg
Power supply:	230 V/50 Hz

Type	PK	Cat. No.
Mini-Freezer KBT 08-51 with ST71 control	1	6.284 427
Mini-Freezer KBT 08-51 with ST100 control	1	4.671 415
Mini-Freezer KBT 08-51 with ST100 control and convection	1	4.671 416

2 Laboratory refrigerators and freezers LKPv/LGPv with professional electronic controller, up to -2 °C/-35 °C

The laboratory appliances incorporating Profi electronic controllers offer many advantages. High-grade materials, high-performance components and accurate workmanship right down to the last detail ensure the high quality of the Liebherr appliances. Wherever huge storing capacity is required the large-scale laboratory appliances with Profi electronic controller are the ideal solution.

Liebherr

2



- Dynamic cooling system
- Profi electronic controller with integrated real-time clock
- Castors, thereof two with brake
- Integrated, ergonomic handle
- Plastic-coated grid shelves and CNS inner liner
- Glass door (..23) with ceiling light (seperately switchable)
- Hot-gas defrost system for very short defrost cycles

Security package:

- Integrated data memory (Alarm events and temperature profile)
- Visual and audible temperature and door alarm
- Mains-independent power supply of the electronic controller
- Infrared and RS 485 interface enabling external documentation
- Volt-free contact for alarm forwarding to an external remote warning system
- Maximum temperature stability and consistency according to IEC 60068-3
- 3-point calibration
- Access port for an external temperature sensor
- Lock

Type	Capacity	External dimensions (W x D x H) mm	Internal dimensions (W x D x H) mm	Energy consumption kWh (24 h)	Temp. range max. °C	PK	Cat. No.
	Litres						
LKPv 6523	597	700 x 830 x 2160	533 x 650 x 1500	1.564	0 ... 16	1	9.698 395
LKPv 1423	1361	1430 x 830 x 2160	1236 x 650 x 1500	2.246	0 ... 16	1	6.264 055
LKPv 6520	597	700 x 830 x 2160	533 x 650 x 1550	1.361	-2 ... 16	1	9.698 686
LKPv 8420	856	790 x 980 x 2160	620 x 850 x 1550	1.652	-2 ... 16	1	9.698 697
LKPv 1420	1361	1430 x 830 x 2160	1236 x 650 x 1550	1.956	-2 ... 16	1	9.698 688
LGPv 1420	1361	1430 x 830 x 2160	1236 x 650 x 1550	7.271	-26 ... -9	1	9.698 693
LGPv 6520	697	700 x 830 x 2160	533 x 650 x 1550	3.745	-35 ... -9	1	9.698 692
LGPv 8420	856	790 x 980 x 2160	620 x 850 x 1550	4.761	-35 ... -9	1	9.698 698

1

1 Laboratory refrigerators and freezers ES series, up to +1 °C/-30 °C
Thermo Scientific

Designed for routine sample protection where laboratory space is limited. Our new ES Series lab refrigerators, freezers and combination refrigerator/freezer are the ideal choice when there is limited space in the laboratory. All ES Series models deliver the sample protection, performance, security and quality you have come to depend on from us:

- with EU plug and UK adapter
- Integrated controller
- Digital temperature display
- High and low temperature alarms
- Standard door locks, lockable
- Low energy consumption
- Access ports
- Defrost type automatic for temperature range +1 to +10 °C and manual for temperature range -19 to -21 °C

Equipment

98F-AEV-TS:	3 drawers
232F-AEV-TS:	2 shelves, 3 baskets
288R-AEV-TS:	5 shelves, 1 basket
263C-AEV-TS/263C-AXV-TS:	3 shelves, 2 half baskets (R) / 1 shelf 2 baskets (F)

Type	Capacity l	External dimensions (W x D x H) mm	Internal dimensions (W x D x H) mm	Energy consumption kWh (24 h)	Temp. range °C	PK	Cat. No.
98F-AEV-TS	98	599 x 658 x 850	420 x 440 x 650	0.4	-18 ... -25	1	6.315 197
232F-AEV-TS	232	595 x 640 x 1570	440 x 430 x 1300	1.0	-18 ... -25	1	9.536 239
288R-AEV-TS	288	595 x 634 x 1570	480 x 445 x 1382	0.5	1 ... 11	1	9.536 213
263C-AEV-TS	159 (R) / 109 (F)	545 x 600 x 1680	457 x 450 x 725 (R) / 408 x 415 x 670 (F)	0.9	1 ... 11 / -10 ... -30	1	9.536 219
263C-AXV-TS	159 (R) / 109 (F)	545 x 600 x 1680	457 x 450 x 725 (R) / 408 x 415 x 670 (F)	0.9	1 ... 11 / -12 ... -20	1	6.265 834

(R) refrigerated area, (F) freeze area

2

2 Biomedical freezers FLEXA LFE, up to -25 °C
NEW
Artiko

Freezers with flexible interior, adjustable shelves and high temperature stability. Ideal for storing biological and medical samples.

- With natural refrigerant R-290
- Static cooling
- Digital controller
- LED display with touch operation
- Visual/acoustic alarm when door is open
- Alarm at over/under temperature and temperature sensor failure
- Lockable door
- Selectable door stop

Scope of supply LFE 110: Freezer, 3 adjustable shelves (2 x regular size, 1 x small), 1 basket

Scope of supply LFE 360: Freezer, 5 adjustable shelves (regular size), 1 basket

Specifications

Temperature range:	-15 ... -25 °C
Power supply:	230 V, 50/60 Hz

Type	Capacity l	Internal dimensions (W x D x H) mm	External dimensions (W x D x H) mm	Weight kg	Energy consumption kWh (24 h)	PK	Cat. No.
LFE 110*	107	460 x 410/230* x 680	600 x 600 x 835	45	1.1	1	4.667 926
LFE 360*	356	440 x 500/311* x 1690	600 x 700 x 1865	97	3.2	1	4.667 927

* Depth at bottom of device

➔ Accessories - please see page 785.

1 Cold box B 30-20, up to -20 °C

Compact desktop cold box for cooling and freezing for all laboratories. Due to the low-noise cooling unit, the cold box can be used directly in the workplace. The space-saving box has an insulating glass pane in the door, so that the cooling material can be observed during freezing.

Fryka-Kältetechnik

- Extremely low noise refrigeration unit
- Microprocessor-controlled with membrane keyboard and easy-to-read LED display
- with natural refrigerant R-1270
- Interior made of high quality stainless steel
- Interior without fittings allows easy cleaning and disinfection
- Bushing (diameter 10 mm), e.g. for temperature monitoring with external sensors
- Lockable door with insulating glass, door frame heating and double magnetic seal with additional lip
- Stackable unit, max. 3 boxes

1



Stainless steel shelf B 30-RS: 4 drawers, each for 4 standard cryoboxes. Drawer size (W x D x H): 300 x 280 x 52 mm. Extra gaps for optimal, uniform and rapid cooling of the entire frozen product (please order separately).

Specifications

Temperature range:	-20 to +10 °C
Control accuracy:	±1 K
Capacity:	30 l
Ambient temperature:	+12 to +30 °C
Dimensions, internal (W x D x H):	360 x 350 x 230 mm
Dimensions, external (W x D x H):	530 x 700 x 460 mm
Weight:	42 kg
Power supply:	230 V/50 Hz

Description	PK	Cat. No.
Cold box B 30-20	1	6.284 401
Shelf B 30-RS	1	6.284 405

High-Performance refrigerators and freezers TSX series

The TSX Series high performance refrigerators and freezers are designed for the storage of media, reagents and other laboratory products. V-drive increases compressor speed to quickly restore temperature after door openings.

Thermo Scientific

- Whisper quiet with a sound level of 52 dBA
- Natural refrigerants (R290)
- Compatible with wireless monitoring systems and remote alarm contacts
- Audible and optical alarm
- GMP Clean Room Class A/ISO 6 (ISO EN 14644-1) compatible with appropriate pre-install preparation
- Four 2" casters, the front two are lockable
- Self-closing door with 90° stop
- Optional chart recorders available

High performance freezers TSX Series, up to -35 °C



2

- TSX 5030 FV is equipped with 2 doors
- With auto defrost

Thermo Scientific

Specifications

Temperature range:	-35 ... -15 °C
Power supply:	230 V, 50 Hz

Type	Capacity l	External dimensions (W x D x H) mm	Internal dimensions (W x D x H) mm	No. of shelves	PK	Cat. No.
TSX 1230 FV	326	619 x 790 x 1854	508 x 554 x 1331	4	1	4.671 810
TSX 2330 FV	650	711 x 962 x 1994	610 x 723 x 1473	4	1	4.672 628
TSX 3030 FV	827	864 x 962 x 1994	762 x 723 x 1473	4	1	6.312 076
TSX 5030 FV	1447	1435 x 962 x 1994	1334 x 723 x 1473	8	1	4.672 629



4.672 629

1

4.672 644

High-Performance plasma freezers TSX series, up to -35 °C

NEW

- With auto defrost
- Meets AABB and FDA requirements for the storage of plasma
- Fully extendable stainless steel drawers
- Standard factory-installed chart recorder

Thermo Scientific

Specifications

 Temperaturrange: -35 ... -15 °C
 Power supply: 230 V, 50 Hz

Type	Description	Capacity l	External dimensions (W x D x H) mm	Internal dimensions (W x D x H) mm	PK	Cat. No.
TSX 1230 LV	1 door and 7 drawers	326	619 x 790 x 1854	508 x 554 x 1331	1	4.672 643
TSX 2330 LV	1 door and 7 drawers	650	711 x 962 x 1994	610 x 723 x 1473	1	4.672 644
TSX 3030 LV	1 door and 7 drawers	827	864 x 962 x 1994	762 x 723 x 1473	1	4.672 645
TSX 5030 LV	2 doors and 14 drawers	1447	1435 x 962 x 1994	1334 x 724 x 1473	1	4.672 646

2

4.672 647

High-Performance enzyme freezers TSX series, up to -25 °C

NEW

- Without auto defrost
- Cold wall convection cooling
- With enzyme bins

Thermo Scientific

Specifications

 Temperaturrange: -25 ... -15 °C
 Power supply: 230 V, 50 Hz

Type	Description	Capacity l	External dimensions (W x D x H) mm	Internal dimensions (W x D x H) mm	PK	Cat. No.
TSX 2320 EV	9 shelves, 45 bins	650	711 x 990 x 1994	610 x 723 x 1473	1	4.672 647
TSX 3020 EV	9 shelves, 54 bins	827	864 x 990 x 1994	762 x 723 x 1473	1	4.672 648

3

4.672 631

High-Performance lab refrigerators TSX Series, up to +2 °C

NEW

With glass door or solid door.

Thermo Scientific

- Bright, LED interior lighting
- Heat-free defrost for maximum temperature uniformity

Specifications

 Temperaturrange: 2 ... 8 °C
 Power supply: 230 V, 50 Hz

Type	Description	Capacity l	External dimensions (W x D x H) mm	Internal dimensions (W x D x H) mm	No. of shelves	PK	Cat. No.
TSX 1205 GV	With glass door	326	619 x 775 x 1854	508 x 554 x 1331	4	1	4.672 630
TSX 2305 GV	With glass door	650	711 x 962 x 1994	610 x 723 x 1473	4	1	4.672 631
TSX 3005 GV	With glass door	827	864 x 947 x 1994	762 x 723 x 1473	4	1	4.672 632
TSX 4505 GV	With double sliding glass door	1297	1435 x 931 x 1994	1334 x 724 x 1473	8	1	4.672 633
TSX 5005 GV	With 2 glass doors	1447	1435 x 962 x 1994	1334 x 724 x 1473	8	1	4.672 634
TSX 1205 SV	With solid door	326	619 x 790 x 1854	508 x 554 x 1331	4	1	4.672 635
TSX 2305 SV	With solid door	650	711 x 962 x 1994	610 x 723 x 1473	4	1	4.672 636
TSX 3005 SV	With solid door	827	864 x 962 x 1994	762 x 723 x 1473	4	1	4.672 637
TSX 5005 SV	With 2 solid doors	1447	1435 x 962 x 1994	1334 x 724 x 1473	8	1	4.672 638

7. Heating and cooling technology

Cooling/Refrigerators and Freezers

1 Laboratory refrigerators GPS series up to +1 °C

Medium and large capacities designed for routine sample protection. With capacities ranging from space-saving 400 L to spacious 1400 L, our new GPS Series lab refrigerators meet the demands of today's laboratory requirements. All models contain sample protection features designed for the rigorous demands of the laboratory environment.

Thermo Scientific

- With EU plug and UK adapter
- Integrated controller
- Digital temperature display
- High and low temperature alarms
- Standard door locks, lockable
- Standard casters
- Choice of glass or solid door
- Automatic defrost
- Access ports

Equipment

R400/R700: 3 shelves
R14X: 6 shelves



Type	Capacity Litres	External dimensions (W x D x H) mm	Internal dimensions (W x D x H) mm	Energy consumption kWh (24 h)	Temp. range max. °C	doors	PK	Cat. No.
R400-SAEV-TS	400	600 x 600 x 1900	480 x 500 x 1150	3.1	1 ... 11	solid	1	9.536 221
R400-GAEV-TS	400	600 x 600 x 1900	480 x 500 x 1150	3.6	1 ... 11	glass	1	9.536 223
R700-SAEV-TS	700	790 x 860 x 1980	600 x 660 x 1300	3.4	1 ... 11	solid	1	9.536 225
R700-GAEV-TS	700	790 x 860 x 1980	600 x 660 x 1300	5.3	1 ... 11	glass	1	9.536 227
R14X-SAEV-TS	1400	1400 x 800 x 1980	1300 x 660 x 1300	2.6	1 ... 11	solid	1	9.536 229
R14X-GAEV-TS	1400	1400 x 800 x 1980	1300 x 660 x 1300	7.7	1 ... 11	glass	1	9.536 231

2 Biomedical refrigerators FLEXA LRE/PRE, up to 2 °C

Refrigerators with flexible interior, adjustable shelves and high temperature stability. Ideal for storing biological and medical samples.

Artiko

- Environmentally friendly refrigerant
- Convection cooling
- Digital controller
- LED display with touch operation
- Visual/acoustic alarm when door is open
- Alarm at over/under temperature and temperature sensor failure
- Lockable door
- Selectable door stop

LRE models: With LED interior lighting

PRE models: With LED interior lighting and glass doors

Scope of supply LRE/PRE 120: Refrigerator, 3 adjustable shelves (2 x regular size, 1 x small), 1 basket

Scope of supply LRE/PRE 440: Refrigerator, 5 adjustable shelves (regular size), 1 basket

Specifications

Temperature range: 2 ... 8 °C
Power supply: 230 V, 50/60 Hz



Type	Capacity l	Internal dimensions (W x D x H) mm	External dimensions (W x D x H) mm	Weight kg	Energy consumption kWh (24 h)	PK	Cat. No.
LRE 120*	117	480 x 410/240* x 690	600 x 600 x 835	51	0.9	1	4.667 920
LRE 440*	437	475 x 500/341* x 1723	600 x 700 x 1865	93	1.9	1	4.667 921
PRE 120*	117	480 x 410/240* x 690	600 x 600 x 835	51	1.2	1	4.667 924
PRE 440*	437	475 x 500/365* x 1723	600 x 700 x 1865	105	2.3	1	4.667 925

* Depth at bottom of device

Accessories for laboratory refrigerators and freezers LR/LF series

Artiko

Type	PK	Cat. No.
Stainless steel grid for LF 660-2/700/1400, incl. carrier	1	6.270 299
Plastic grid for LR/LF/LFF/PR/PF 660/700/1400 incl. carrier	1	7.971 172
Plastic grid for LF 300, incl. carrier	1	7.971 324

Laboratory refrigerators LKv/LKUv and laboratory fridge-freezer LCv, up to 3 °C/-30 °C

Wherever floor space is limited or under-worktop installation is planned, the laboratory refrigerators with Comfort electronic controllers are the ideal solution. The range comprises two freestanding (LKv) and two underworktop (LKUv) laboratory refrigerators, in each case with glass door and solid door versions. The temperature can be set from +3 °C to +8 °C. The forced-air cooling system in conjunction with the precision electronic controller ensures temperature consistency and uniform temperature distribution in the interior. The LCv 4010 laboratory fridge-freezer, which has two separately cooling circuits, further extends the range of compact laboratory appliances.

Liebherr

- Dynamic cooling system
- Precision electronic controller with digital temperature display
- Glass door (..13) with ceiling light (separately switchable)
- Convenient, clear view drawers (LCv 4010)
- Self-closing door with integrated lock

Security package:

- Visual and audible temperature and door alarm
- Visual power failure alarm when mains power returns
- Integrated data memory with min/max temperatures
- Volt-free contact for alarm forwarding to an external remote warning system
- RS 485 interface enabling external documentation
- Access port for an external temperature sensor
- Maximum temperature stability and consistency according to IEC 60068-3

Type	Capacity l	External dimensions (W x D x H) mm	Internal dimensions (W x D x H) mm	Energy consumption kWh (24 h)	Temp. range max. °C	PK Cat. No.	
						PK	Cat. No.
LKv 3913*	386	601 x 618 x 1840	440 x 435 x 1635	1.315	3 ... 16	1	7.940 344 1
LKv 3910	361	601 x 618 x 1840	440 x 435 x 1635	0.846	3 ... 16	1	6.313 863
LKUv 1613*	152	601 x 618 x 820	440 x 435 x 670	1.010	3 ... 16	1	9.698 699 2
LKUv 1610	142	601 x 618 x 820	440 x 435 x 670	0.747	3 ... 16	1	9.698 680 3
LCv 4010	254/107	601 x 618 x 2000	440 x 441 x 1105 / 433 x 435 x 597	1.8	3 ... 16 / -30 ... -9	1	7.627 795 4

*Glass door

1

7.940 344

2

9.698 699

3

9.698 680

4

7.627 795

5

5 Refrigerator drawers AluCool® including dividers

High quality aluminium drawers including frame on smooth-running wheels with pull-out stop. Includes flexible dividing system with card pockets. Depending on the specific need, the dividing system allows the storage of drugs, blood and plasma with a space saving of up to 30%. With a few simple steps, the flexible dividers are taken out and the drawer can be cleaned easily and hygienically.

H+H System

Typ A:

FKS 1800/1802/2600 /2602/3600/3602; FKU 1800/1805; UKS 1800/1801/2600/2602/3600/3602/3650; FKEx 1800/2600/3600

Typ B:

FKUv 1610/1612/1660/1662; LKexv 3910; LKv 3910/3912; LKUexv 1610; LKUv 1610/1612

The AluCool® drawers can be retrofitted at any refrigerator - to save and optimise valuable space.

Tool-free assembly without damaging the refrigerator interior.

Division: 3 channels with 12 universal dividers. Width of the channels can be changed in 1 cm steps.

Type	Refrigerator internal dimensions (W x D) mm	PK	Cat. No.
A	441 x 513	1	9.698 980
B	435 x 440	1	9.698 981

Pharmacy refrigerators MK, up to +2 °C

Liebherr pharmaceutical refrigerators compliant with DIN 58345 safely store high-quality preparations and sensitive medications at all times. This is achieved by a combination of precise electronic controls, highly effective insulation, an optimised forced-air cooling system, and premium-quality workmanship.

Liebherr

1



6.283 866

- Maintenance of an operating temperature from +2 °C to +8 °C, visual and audible warning installation for high and low temperature
- Can be used in ambient temperatures from +10 °C to +35 °C
- Noise emission less than 48 dB(A)
- Visual and audible power failure alarm for at least 12 h
- Safety thermostat to avoid temperatures below +2 °C
- Mechanical resistance of internal fittings at least 100 kg/m²
- Lockable door optionally made of steel or insulating glass

Type	Capacity	External dimensions (W x D x H) mm	Internal dimensions (W x D x H) mm	Energy consumption kWh (24 h)	Temp. range °C	Weight kg	PK	Cat. No.
MKUv 1610-21	109/142	601 x 618 x 820	440 x 435 x 670	0.747	5	39	1	6.283 386
MKUv 1613-20*	109/152	601 x 618 x 820	440 x 435 x 670	1.010	5	45	1	6.283 865
MKv 3910-21	280/361	601 x 618 x 1840	440 x 435 x 1635	0.846	5	68	1	6.283 694
MKv 3913-20*	278/386	601 x 618 x 1840	440 x 435 x 1635	1.315	5	85	1	6.283 866

*with insulating glass door with switchable LED illumination

2 LLG-Laboratory Power Failure Detector

- Immediate visual and acoustic alarm
- Alarm can sound for short power outages, or for larger periods of at least 12 hours (can be switched off manually).
- Plug safety cover offers protection against accidental disconnection of plug
- Maximum total power of connected devices. 3500W power supply 230V 50Hz
- Suitable for European plugs
- Max. Rating 16 A
- With built-in battery

Scope of supply:

- 1 x power failure detector
- 2 x plug safety caps
- 2 x screws

2



Type	PK	Cat. No.
LLG-Laboratory Power Failure Detector	1	6.255 819

3 4 Spark-free laboratory refrigerators, up to +1 °C

The German guidelines "Working Safely in Laboratories BG-I 850-0" stipulates that interior space must be explosion-protected where hazardous, explosive atmospheres can develop (for example, due to the presence of flammable liquids). Such explosive atmospheres can be created by stored flammable liquids, for example. The laboratory refrigerators by Lovibond® meet these requirements. The interiors are free from sparking sources and are therefore explosion-proof. With glass shelves. Variable temperature control from +1 °C to 15 °C. Temperature is continuously controlled by thermostat. The digital temperature display enables the interior temperature to be easily read.

Lovibond®

- Spark-free according to BG-I 850-0
- Dynamic cooling system
- 1 °C to 15 °C, continuously adjustable
- Digital temperature display
- High energy efficiency
- Robust materials
- Lockable

3



4

Capacity l	External dimensions (W x D x H) mm	Internal dimensions (W x D x H) mm	Temp. range max. °C	Weight kg	PK	Cat. No.
160	600 x 600 x 860	513 x 441 x 702	+1 ... +15	41	1	9.699 005
220	600 x 610 x 1250	470 x 440 x 1062*	+1 ... +15	53	1	9.699 006
300	600 x 610 x 1640	470 x 440 x 1452*	+1 ... +15	64	1	9.699 007
490	750 x 730 x 1640	600 x 460 1452*	+1 ... +15	84	1	9.699 008

* with "fan stop" function, which switches the fan off when the door is opened.



1 Spark-free laboratory refrigerators LKexv, up to +1 °C

Laboratory refrigerators with dynamic cooling and spark-free interior. Designed especially for storing explosive and highly flammable substances. The interiors of the LKexv models meet all the safety requirements of the EU Directive 94/9EC (ATEX 95). The appliances excel with a large capacity and rugged design. The cooling temperature is continuously adjustable from +1 °C to +15 °C with the aid of the thermostat integrated in the control panel. Certified according to ATEX 95.

Liebherr



Features: Flexible, hygienic interior, Glass shelves, Water tray, Lock, Reversible door hinges.

Type	Capacity Litres	External dimensions (W x D x H) mm	Internal dimensions (W x D x H) mm	Energy consumption kWh (24 h)	PK	Cat. No.
LKexv 2600	240	600 x 610 x 1250	470 x 440 x 1062	0.786	1	6.264 468
LKexv 3600	333	600 x 610 x 1641	470 x 440 x 1452	0.947	1	7.671 880
LKexv 5400	554	750 x 729 x 1640	600 x 560 x 1452	0.983	1	6.262 810

2 Spark-free laboratory refrigerators and freezers MediLine with comfort electronic controller, up to 3 °C/-30 °C

Refrigerators and freezers specially designed for the storage of explosive and highly flammable substances. With comfort electronics and spark-free interior. The interiors of the units meet the safety requirements of the EU Directive 94/9/EC (ATEX 95) and are tested by the ATEX conformity assessment body electro-suisse (SEV).

Liebherr



- Precision electronic controller with digital temperature display
- Self-closing door with integrated lock
- Visual and audible temperature and door alarm
- Visual power failure alarm as well as sensor defect alarm
- Integrated data memory with min/max temperatures
- Alarm forwarding to an external remote warning system
- RS 485 Interface for external documentation
- 1-point calibration
- Maximum temperature stability and consistency according to IEC 60068-3
- Access port for an external temperature sensor

Cooling units LKexv/LKUexv

- With dynamic cooling system
- Flexible, height-adjustable glass shelves

Freezers LGex/LGUex/LCexv

- With static cooling system
- Convenient and comfortable drawers
- Model LCexv 4010 equipped with 2 doors

Type	External dimensions (W x D x H) mm	Internal dimensions (W x D x H) mm	Temp. range max. °C	Plug type	PK	Cat. No.
LKexv 3910	601 x 618 x 1840	440 x 435 x 1635	3 ... 16	EU	1	9.698 685 2
LKUexv 1610	601 x 618 x 820	440 x 435 x 670	3 ... 16	EU	1	9.698 682
LGex 3410	601 x 618 x 1840	420 x 400 x 1587	-30 ... -9	EU	1	9.698 691
LGUex 1500	601 x 618 x 820	454 x 450 x 663	-26 ... -9	EU	1	9.698 690
LCexv 4010	601 x 618 x 2003	440 x 441 x 1105 / 433 x 433 x 597	3 ... 16 / -30 ... -9	EU	1	9.698 677

1

2

9.698 685

1 Flake ice maker with reservoir, UFP series, air cooled NEW

For fast, HACCP-compliant production of various quantities of compact, granular ice flakes for laboratories, the chemical industry and food production. The ice is produced by a vertical stainless steel evaporator and transported by a worm gear to the head of the cylinder, pressed and broken into the desired size. For the production of up to 153 kg of ice per day.

MANITOWOC®

The new refrigerant R290 meets the requirements of the latest EU regulations, reduces energy consumption by up to 30 %, has no ozone depletion potential and only a very low global warming potential.

- Robust stainless steel evaporator
- Easy ice removal
- Suitable for demineralised water
- Closed system for optimum hygiene
- Environmentally friendly refrigerant
- Air-cooled
- Depending on model, has storage capacities from 20 to 55 kg
- Stainless steel housing
- Easy to clean
- Height-adjustable feet from 110 to 150 mm
- Comfortable and safe operation
- Low energy consumption

Scope of supply: Flake ice maker with height-adjustable stainless steel feet, ice shovel, water inlet and outlet set

Specifications

Refrigerant: R290
 Permissible ambient temperature: 10 ... 43 °C
 Power supply: 230 V, 50 Hz



Type	Output kg/24 hrs. up to kg	Rating W	Capacity kg	Dimensions (W x D x H) mm	Weight kg	PK	Cat. No.
UFP 0244 A	113	470	20	500 x 660 x 843	67	1	4.667 960
UFP 0200 A	113	470	30	500 x 660 x 843	76	1	4.667 961
UFP 0388 A	153	700	40	738 x 690 x 1070	102	1	4.667 962
UFP 0399 A	153	700	55	738 x 690 x 1173	105	1	4.667 963

2 3 Flake ice makers with/without reservoir, air-cooled

Manufactured according to DIN ISO 9001. For preparing solid and saturated ice flakes of hygienic, 0.5 °C cold ice. With electronic control of the ice temperature. The units have a stainless steel housing and an antimicrobial coated interior. Air-cooled versions, with cleaning indication.

Scotsman / HIBU

- MF models without reservoir (please order separately).
- AF models without drain pump
- EF models standard with drain pump. The drain pump allows an installation or set-up without any drainage height or distance problems. Place your ice maker just where it is needed even lower than the actual drain outlet (can be up to 1.70 m higher). Distance to drain outlet up to 15 meters. Drain can be placed up to 1.70 higher.
- 2 year warranty.

Scope of supply: Flake ice maker, 1 x scoop

Also available with water-cooled compressor. Alternative models available on request. A specially built model for laboratory-grade water is available on request.



9.580 006



9.580 045

Type	Capacity kg	Depth mm	Width mm	Height mm	Output kg/24 hrs. up to kg	Rating W	PK	Cat. No.
Ice flake maker AF 80	25	620	535	890	73	340	1	9.580 006
Ice flake maker AF 103	30	622	592	1078	120	550	1	9.580 040
Ice flake maker AF 124	40	605	950	872	122	510	1	9.580 041
Ice flake maker AF156	60	605	950	1083	160	590	1	9.580 042
Ice flake maker AF 206	60	605	950	1083	200	950	1	9.580 043
Ice flake maker EF 103	30	622	592	1078	120	550	1	9.580 045
Ice flake maker EF 124	40	605	950	872	122	510	1	9.580 046
Ice flake maker EF 156	60	605	950	1083	160	590	1	9.580 047
Ice flake maker EF 206	60	605	950	1083	200	950	1	9.580 048
Ice flake maker MF 26*		536	564	531	140	500	1	9.580 009
Ice flake maker MF 36*		536	564	531	200	900	1	9.580 016
Reservoir SB 193 for MF 26/MF 36	129	845	569	1048			1	9.580 010
Reservoir SB 393 for MF 26/MF 36 incl. cover adapter	181	850	769	1048			1	9.580 049

* without reservoir

➔ Scoops please see page 138.

Cooling/Ice machines-Transport boxes



1 Dry Ice Machines SnowPack®

The dry ice machine SnowPack® produces dry ice tablets of -79 °C with 50 or 250 g weight within a short time. Suitable for all European siphon carbon dioxide cylinders with valve (W 21.80 x 1¼" acc. to DIN 477-1, no. 6) without pressure regulator.

Bürkle

- Produces dry ice tablets at -79 °C with 50 or 250 g
- Operates without electricity
- Taint and odour free

Applications: Hospitals, universities, schools, laboratories, chemical industry, materials testing.
Examples of use: Lowering the temperature in cooling baths or cold traps, pre-cooling tissue samples, ensuring safe transport or embedding biological substances, freezing blood and tissue samples, studies in chemistry, physics and materials technology, etc.

Gassing period (per tablet):

approx. 1 min

Tablets per 22 kg bottle (dependent on ambient temperature and pressure):

either 90 or 16 pieces approx.

Type	Diam. mm	Height mm	Tablet weight g	PK	Cat. No.
SnowPack® 50	50	30	50	1	9.253 006
SnowPack® 250	80	60	250	1	9.253 008



2 Cooling Boxes, Isotherm Extreme

- Strong, high quality PU insulation
- Compact and robust cool boxes
- Cover can be locked with carrier bracket
- Rubber seal for airtight seal

Campingaz

Type	Capacity l	Internal dimensions (W x D x H) mm	External dimensions (W x D x H) mm	Weight g	PK	Cat. No.
Isotherm Extreme	10	265 x 165 x 250	350 x 225 x 310	1400	1	9.031 821



3 Cooling Boxes, Icetime® Plus

- Strong, high quality PU insulation,
- Lockable lid, which clicks audibly when closing
- Handle for easy transport

Campingaz

Type	Capacity l	External dimensions (W x D x H) mm	Weight g	PK	Cat. No.
Icetime® Plus	26	407 x 313 x 424	2400	1	6.284 954
Icetime® Plus	30	410 x 310 x 460	2600	1	6.284 527



4 Cooling bag Fold'N Cool™

The cooler Fold'N Cool™ 30 L has a wide range of uses and can be laid flat after use. 1 large front pocket with zip, 2 carrying handles and hanging loop.

Campingaz

- 100 % polyester with PU coating on the back
- Easy-to-clean inner material, food-free PEVA
- Isolation: high-performance EPE foam
- Dark blue/grey

Type	Capacity l	External dimensions (W x D x H) mm	Weight g	PK	Cat. No.
Fold'N Cool™	30	390 x 250 x 380	760	1	6.266 054

1 Cool packs Freez'Pack®

- Composition: water, carboxymethyl cellulose, acticides and blue dye
- Suitable for food contact (non-toxic coolant)
- Dishwasher safe

Campingaz

Type	Weight g	Dimensions (W x D x H) mm	PK	Cat. No.
Freez'Pack® 2 x M5	200	150 x 80 x 25	2	6.236 733
Freez'Pack® M10	370	180 x 95 x 30	1	6.262 337
Freez'Pack® M20	741	200 x 172 x 30	1	6.803 624
Freez'Pack® M30	1100	255 x 210 x 30	1	6.802 089



Cool packs Icecatch®

Icecatch® cool packs for temperature sensitive products used in the pharmaceutical, biotech, medical and food industries. Icecatch® cool packs distinguish themselves through the following specific features:

- Reliable cold storage through the use of immobilised coolant
- For repeat usage due to the use of robust PA/PE film
- Disposal with the domestic trash due to the use of non-poisonous ingredients
- Unobjectionable use in the pharmaceutical and food industries
- Phase transition 0 °C

Icecatch

Icecatch®-Gel

- Spreading of heat absorption around the 0 °C range through the use of immobilised cooling gel
- Optimal price/heat absorption capacity relationship
- Filled with cooling gel

Icecatch®-Solid

- Maximum dimensional stability during the freezing process through the use of hard foam
- Filled with hard foam

Icecatch®-Solid Insulated 2 - 8 °C

- A perfect cool pack in combination with our System packaging for the +2 °C up to +8 °C transport
- Maximum dimensional stability during the freezing process through the use of hard foam, coolant and integrated isolation layer
- Filled with hard foam and isolation layer



9.695 000



Attention

H phrases: H302



9.695 007

Type	Description	Dimensions (W x D x H) mm	Weight g	PK	Cat. No.
Icecatch®-Gel	with cooling gel	90 x 110 x 20	90	120	9.695 000
Icecatch®-Gel	with cooling gel	90 x 150 x 20	170	80	9.695 001
Icecatch®-Gel	with cooling gel	90 x 180 x 20	230	60	9.695 002
Icecatch®-Gel	with cooling gel	140 x 190 x 30	460	32	9.695 003
Icecatch®-Gel	with cooling gel	140 x 240 x 40	690	24	9.695 004
Icecatch®-Solid	with hard foam/cool medium	195 x 130 x 20	500	27	6.262 659
Icecatch®-Solid	with hard foam/cool medium	105 x 180 x 40	630	12	6.262 660
Icecatch®-Solid	with hard foam/cool medium	280 x 190 x 25	1100	12	9.695 006
Icecatch®-Solid Insulated	with hard foam/cool medium and isolation layer	195 x 130 x 23	500	24	9.695 008
Icecatch®-Solid Insulated	with hard foam/cool medium and isolation layer	280 x 190 x 30	1100	12	9.695 007
Icecatch®-Solid Insulated	with hard foam/cool medium and isolation layer	280 x 190 x 45	1700	8	9.695 009

Cooling/Transport boxes

1



1 Isolation Box Icecatch®, EPS

The standard thermo boxes made of EPS (Styrofoam®) for temperature sensitive products used in the Pharmaceutical and food industries which have to be stored and transported within a specific temperature spectrum. In combination with the Icecatch cooling elements the perfect solution for the transport of temperature sensitive products.

Icecatch

Specifications:

Colour: White
Foam weight: 20 g/l

Capacity L	Internal dimensions (W x D x H) mm	External dimensions (W x D x H) mm	Wall thickness mm	PK	Cat. No.
3.1	200 x 115 x 135	260 x 170 x 190	30	1	9.695 030
3.1	200 x 115 x 135	260 x 170 x 190	30	5	6.290 853
9.1	275 x 195 x 170	335 x 255 x 230	30	1	9.695 031
9.1	275 x 195 x 170	335 x 255 x 230	30	5	6.290 854
12.8	305 x 210 x 200	365 x 270 x 250	30	1	9.695 032
18.8	300 x 250 x 250	400 x 350 x 350	50	1	9.695 033
26.3	420 x 305 x 205	480 x 365 x 255	30	1	9.695 034

2



2 Isolating box with lid, Neopor®

Neopor® is characterised by its outstanding hot and cold thermal insulation properties (a further 20 % over Styropor), its high compressive strength, shock absorbing properties, low weight and insensitivity to moisture. It also contains infrared absorbers and reflectors. Compared to conventional insulating materials, they diminish heat conductivity and lend the material its characteristic silver-grey color.

Storopack Deutschland

Description	Capacity L	External dimensions (W x D x H) mm	Internal dimensions (W x D x H) mm	PK	Cat. No.
Isolating box with lid	3.5	165 x 165 x 130	225 x 225 x 195	1	6.267 991
Isolating baffle ring	6.2	350 x 350 x 100	250 x 250 x 100	1	7.656 681
Isolating box with lid	12.5	350 x 350 x 300	250 x 250 x 200	1	7.656 680
Isolating box with lid	101.5	690 x 565 x 470	590 x 465 x 370	1	7.661 033

3 Euronormboxes, PP, stackable

Solid transparent plastic containers, odorless, cold- and heat-resistant, stable against the most acids and alkalis. Dishwasher safe, food safe. Two sizes (40 x 30 cm and 60 x 40 cm) available.

- Corresponding lids please order separately
- Suitable Trolley (Cat. No.: 9.301 502)

Type	Capacity l	External dimensions (W x D x H) mm	Colour	PK	Cat. No.
Euronormbox	20	400 x 300 x 220	transparent	1	9.301 503
Lid	-	400 x 300 x 10	transparent	1	9.301 506
Euronormbox	46	600 x 400 x 220	transparent	1	9.301 504
Euronormbox	66	600 x 400 x 320	transparent	1	9.301 505
Lid	-	600 x 400 x 10	transparent	1	9.301 507
Euronormbox	20	400 x 300 x 220	grey	1	6.283 913
Lid	-	400 x 300 x 10	grey	1	6.283 914

Suitable accessories can be found in our online shop.

3



1 Ice buckets and pans PolarSafe™, PS

Argos Technologies

These polystyrene buckets and pans are produced with thick walls to provide rigidity and strength, and yet are very lightweight. Perfectly suited for use with ice, dry ice and slurry ice. Even liquid nitrogen can be stored in these containers. All products provide excellent insulating properties to help keep temperature sensitive samples safely chilled. PolarSafe™ buckets come with snug fitting lids to minimize evaporation loss and to maximize cooling. They feature easy-grab knobs on each lid and prominent recessed handles to facilitate transport. The pans, without a lid feature unique gripping ridges and pour spouts to facilitate the disposal of cooling agents.



Description	Colour	Capacity	Dimensions (l x w x h) mm	PK	Cat. No.
		L			
Ice Bucket*	black	2.5	276 x 308 x 114	1	6.281 562
Ice Bucket*	blue	5.0	276 x 308 x 173	1	6.281 563
Ice Pan	blue	4.0	305 x 229 x 127	1	6.281 565

* with lid

2 Cool Containers True North®, PU

Heathrow Scientific

Rigid polyurethane container provides durability for chilling your temperature sensitive samples. Excellent insulation properties for ultra cold. Use with ice, dry ice and ice-salt slurries, etc. For low temperature use down to -196°C. Minimize evaporation loss with close fit lid. Easily remove with comfortable recessed knobs. Keyed lid and base fit together to conveniently store lid under base. With spout and ergonomic handles for safe handling. Stackable.



Colour	Capacity	Dimensions (l x w x h) mm	PK	Cat. No.
	l			
black	4	234 x 181*	1	9.010 691
green	1	267 x 195.5 x 114	1	9.010 692
blue	4	381 x 254 x 182	1	9.010 693
red	9	521 x 292 x 163	1	9.010 694

*(diam. x H)

3 4 Insulated container Magic Touch 2™

Bel-Art Products

Superior insulating properties combined with high chemical resistance make Magic Touch 2™ laboratory ice buckets and pans compatible not only with wet ice, but also with ultra-low temperature materials including dry ice, ice-salt mixtures, dry ice solvent mixtures, or liquid nitrogen. Their lightly textured non-slip finish and raised edge provides secure transport and a stylish look.

Expanded urethane icewares are

- lightweight
- durable
- non-sweating
- impervious to moisture and odors
- able to withstand a wide temperature range: -196 °C to 100 °C
- provided with a convenient pour spout, drip-proof rims and fill line
- furnished with perfect fitting lid
- easy and secure to stack because of a keyed lid and base



Type	Colour	Capacity	Dimensions (l x w x h) mm	PK	Cat. No.
		L			
Mini Ice Pan	blue	1.0	183 x 183 x 116	1	9.010 632
Mini Ice Pan	red	1.0	183 x 183 x 116	1	9.010 633
Midi Ice Pan	blue	4.0	304 x 229 x 200	1	9.010 638
Midi Ice Pan	red	4.0	304 x 229 x 200	1	9.010 639
Maxi Ice Pan*	blue	9.0	420 x 303 x 200	1	9.010 640
Maxi Ice Pan*	red	9.0	420 x 303 x 200	1	9.010 641
Handy Ice Bucket	blue	2.5	(diam. x H) 268 x 164	1	9.010 634
Handy Ice Bucket	red	2.5	(diam. x H) 268 x 164	1	9.010 635
N'Icer Ice Bucket	blue	4.0	(diam. x H) 268 x 212	1	9.010 636
N'Icer Ice Bucket	red	4.0	(diam. x H) 268 x 212	1	9.010 637

* without lid

Cooling/Transport boxes



9.401 090

Cryo-Safe™ Coolers

Use to protect samples on the bench, during transport, or in freezers with defrost cycle and fluctuating temperatures

Bel-Art Products

Polycarbonate. A non-toxic freezing gel is isolated within the walls of the cooler, guaranteeing that labels or marks on the vials or tube are not damaged.

- The indexed and transparent (9.401 090, 9.401 091, 9.401 092) or gel-filled (9.401 093, 9.401 094) polycarbonate lid shows tube location and matches locations printed on the cooler
- Side handles (9.401 090, 9.401 091) or a wire handle for easy carrying
- Coolers can be stacked to save space and maximize freezer volume
- Rubber feet to prevent slipping
- All polycarbonate cooler body easy to clean

Store at -20 °C for 24 hours prior to use

for -15 °C-Cryo-Safe-Boxes

Store at -20 °C for a few hours until the temperature of the cooler falls below 0 °C for -0 °C-Cryo-Safe-Boxes



9.401 094

For tubes	Dimensions (l x w x h)	Array	Temperature-maintained	PK	Cat. No.
ml	mm				
0.5 ml, 1.5 ml	145 x 100 x 95	12	≤ 0 °C for 2.5 h	1	9.401 090
0.5 ml, 1.5 ml, 2.0 ml	145 x 100 x 95	12	≤ -15 °C for 1 h	1	9.401 091
15 ml	197 x 140 x 190	12	≤ 0 °C for 3 h	1	9.401 092
0.5 ml, 1.5 ml	243 x 157 x 146	32	≤ 0 °C for 3 h	1	9.401 093
0.5 ml, 1.5 ml, 2.0 ml	243 x 157 x 146	32	≤ -15 °C for 1.5 h	1	9.401 094



Labtop Cooler Nalgene™, Type 5115, 5116, DS5116

The economical alternative for keeping samples and biochemical reagents cool at the workbench or for protecting against temperature fluctuations and power failure in refrigeration apparatus. With write-on, gridded lid. Lids fit one way to maintain the correct grid orientation. Robust, space-saving and stackable. With non-slip rubber feet. Can be used down to -135 °C. Adapters are also supplied for 0.5 ml microtubes.

Thermo Scientific

Type	Description	Aperture array	Temperature-maintained on lab bench	PK	Cat. No.
5115	Clear lid, without gel, for 1.5 - 2.0 ml tubes	12	≤ -15 °C up to 1 hr.	1	9.400 929
DS5116	Clear lid, without gel, for 1.5 - 2.0 ml tubes	12	≤ 1 °C up to 3.5 hrs.	1	9.400 930
5115	White lid, with gel, for 1.5 - 2.0 ml tubes	32	≤ -15 °C up to 2 hrs.	1	9.400 932
DS5116	White lid, with gel, for 1.5 - 2.0 ml tubes	32	≤ 1 °C up to 5 hrs.	1	9.400 933



4 Mini coolers, PC

Mini coolers are designed to protect a wide range of solutions (enzymes, DNA, RNA, cell suspensions) by helping to maintain freezer temperatures on the lab bench.

BRAND

Durable polycarbonate filled with non-toxic gel.

Mini coolers hold twelve 0.5 ml to 2.0 ml tubes.

Colour	Temperature-maintained on lab bench	PK	Cat. No.
red	0 °C, up to 60 min	1	6.802 253
yellow	-20 °C up to 60 min	1	7.300 442
white	-70 °C up to 45 min	1	7.090 437

1 Cooling Block Systems, FreezeBox™

Blue. FreezeBox™ is a new, energy-saving, environmentally friendly and safe cooling equipment, without additives. It does not require electricity (except for pre-cooling the cores in the freezer) and no ice for low-temperature cooling of biological samples. The system can be used ice-free, is lightweight, easy to transport and ideal for the collection and storage of biological samples. It can be combined with interchangeable cores and different tube modules. Cooling cores can be tempered in a refrigerator or freezer and inserted into the FreezeBox™. For operation with dry ice, leave out the cooling core and fill with 200 g dry ice instead.

- For use with cooling core, ice or dry ice
- Easy to clean and disinfect
- Durable, suitable for frequent use
- Easy to mount



Type	Description	Dimensions (W x D x H) mm	PK	Cat. No.
FreezeBox™	with cooling core, -0.5 °C ... 4 °C and CM-01-module	152 x 170 x 123	1	4.665 848
FreezeBox™	with cooling core, -0.5 °C ... 4 °C and CM-02-module	152 x 170 x 123	1	4.665 856
FreezeBox™	with cooling core, -0.5 °C ... 4 °C and CM-03-module	152 x 170 x 123	1	4.665 857
FreezeBox™	with cooling core, -0.5 °C ... 4 °C and CM-04-module	152 x 170 x 123	1	4.665 858
FreezeBox™	with freeze core, -18 °C ... -4 °C and CM-01-module	152 x 170 x 123	1	4.665 859
FreezeBox™	with freeze core, -18 °C ... -4 °C and CM-02-module	152 x 170 x 123	1	4.665 860
FreezeBox™	with freeze core, -18 °C ... -4 °C and CM-03-module	152 x 170 x 123	1	4.665 861
FreezeBox™	with freeze core, -18 °C ... -4 °C and CM-04-module	152 x 170 x 123	1	4.665 862
FreezeBox™	Empty FreezeBox™	152 x 170 x 123	1	4.665 849
Cooling core	for -0.5 °C ... 4 °C	105 x 100 x 26	1	4.665 850
Freeze core	for -18 °C ... -4 °C	105 x 100 x 26	1	4.665 851
CM-01-module	for 30 x 2 ml tubes, Ø 12,6	119 x 101 x 38	1	4.665 852
CM-02-module	for 48 x 1.5 ml tubes, Ø 11	119 x 101 x 38	1	4.665 853
CM-03-module	for 30 x 5 ml tubes, Ø 13,5	119 x 101 x 38	1	4.665 854
CM-04-module	for 96 PCR-tubes, Ø 7	119 x 101 x 38	1	4.665 855

Freezing Aid for Cell Cultures, FreezerCell™

FreezerCell™ can be used for a variety of cell types, including stem cells, primary cells, cell lines and yeasts. The FreezerCell™ does not require any additives and only needs to be placed in an ultra deep freezer and the cooling runs at -1°C per minute. Fill the freezing aid with the cryotubes and freeze for approx. 3 hours at -80 °C. Then the samples are ready to transfer to a nitrogen tank. This gentle method ensures a high survival rate of the cells during the freezing process.

- No pre-cooling necessary
- Consistent temperature distribution, even with partial loading
- Lid can be opened easily



4.665 863

Type	Dimensions (W x D x H) mm	PK	Cat. No.
Hexagon shape for 12 tubes	108 x 108 x 100	1	4.665 863
Square shape for 12 tubes	117 x 117 x 100	1	4.665 865



4.665 865

4 Nalgene Freezing container Mr. Frosty, PC

With 120mm diameter screw cap in blue HDPE, vial holder made of white HDPE. Suitable for 18 x 1.2/2.0 ml cryovials. Foam interior. Cooling rate 1 °C/min. Tubes can be easily removed. Each aperture has a moulded number for identification. Stackable.

Thermo Scientific

For tubes ml	Diam. mm	Height mm	No. of tubes	PK	Cat. No.
1.0-2.0	117	86	18	1	9.400 945
3.6	117	151	12	1	9.400 990
4.5-5.0	117	151	12	1	9.400 991



1

1 Immersion circulator

Immersion circulator for all kinds of water baths. It clamps securely to both straight and curved tank walls. The patented, closed housing protects the user and the heating element.

PolyScience

- Temperature stability ± 0.07 °C
- Minimum working depth 7.5 inch/19 cm
- Large LCD-display
- Display resolution 0.1 °C
- Displays actual and set point temperature simultaneously
- Integrated pump and heater protection
- Integrated over-temperature protection
- Low liquid level protection
- Included clamp for straight and curved tank walls
- Maximum pressure 0.12 bar/1.8 psi with a maximum pressure flow rate of 11.9 l/min

Type	Dimensions (W x D x H) mm	Pump max. l/min / bar	Temp. range max. °C	PK	Cat. No.
MX	109 x 97 x 358	11.9 / 0.12	135	1	6.281 081

2

2 Open Tanks

For use with Immersion circulator LX and MX.

PolyScience

Filling volume	Dimensions (W x D x H)	Bath opening	Bath tank depth	Temp. range	Material	PK	Cat. No.
L	mm	mm	mm	max. °C			
8	302 x 174 x 232	284 x 156	203	85	Polycarbonate	1	6.281 082
11	406 x 174 x 232	389 x 156	203	85	Polycarbonate	1	4.658 653
14	513 x 174 x 232	493 x 156	203	85	Polycarbonate	1	4.658 654
17	351 x 324 x 232	312 x 305	203	85	Polycarbonate	1	4.658 655
23	455 x 324 x 232	417 x 305	203	85	Polycarbonate	1	4.658 656
28	561 x 324 x 232	523 x 305	203	85	Polycarbonate	1	4.658 657

3

3 Open Bath Systems, Stainless Steel

An economical alternative to integrated heating baths for liquid temperatures up to 150 °C.

PolyScience

Controller bridge rests securely on the bath, yet is easily removed for tank cleaning.

Generous bath opening provides ready access to samples and the included bath cover improves stability.

- Working temperatures from ambient +10° up to 150 °C
- Advanced Programmable, Advanced Digital or MX Temperature Controller
- 6, 10, 20 or 28 liter reservoir
- DuraTop™ Chemical Resistant Bridge, Swivel 180™ Rotating Controller (on Advanced Programmable and Advanced Digital models)
- Lidded opening for optional cooling coil (10, 20 and 28 liter models)
- External circulation capability
- Complies with DIN 12876-1 Class I safety requirements for use with non-flammable liquids
- Incl. bath cover

Working temperature range: +10° ... +150 °C (+135 °C, MX type)

Temperature stability: ± 0.01 °C (± 0.07 °C, MX type)

Heating capacity: 2.2 kW (1.1 kW, MX type)

Pump capacity: 16.7 l/min/0.25 bar (AP, AD type)

11.9 l/min/0.12 bar (MX type)

Type	Filling volume	Dimensions (W x D x H)	Bath opening	Bath tank depth	PK	Cat. No.
	L	mm	mm	mm		
MX	6	340 x 206 x 406	100 x 110	152	1	4.658 641
MX	10	353 x 342 x 406	99 x 255	152	1	4.658 644
MX	20	531 x 342 x 406	264 x 228	152	1	4.658 647
MX	28	531 x 342 x 457	257 x 214	203	1	4.658 650
AD	6	340 x 206 x 378	100 x 110	152	1	4.658 640
AD	10	353 x 342 x 378	99 x 255	152	1	4.658 643
AD	20	531 x 342 x 378	264 x 228	152	1	4.658 646
AD	28	531 x 342 x 427	257 x 214	203	1	4.658 649
AP	6	340 x 206 x 378	100 x 110	152	1	4.658 639
AP	10	353 x 342 x 378	99 x 255	152	1	4.658 642
AP	20	531 x 342 x 378	264 x 228	152	1	4.658 645
AP	28	531 x 342 x 427	257 x 214	203	1	4.658 648

YOUR FORMULA FOR SUCCESS

Quality
Reliability
Durability

Experience
Experience
Experience



PolyScience[®]
Temperature Control Solutions



CHILLERS AND COOLERS

GENERAL PURPOSE WATER BATHS

CIRCULATING BATHS

APPLICATION-SPECIFIC BATHS

 **PolyScience**[®]
Temperature Control Solutions[®]

  
@polysciencelab

 
polyscience.com

QUALITY

RELIABILITY

DURABILITY

VALUE

1

1 Refrigerated/heated circulators

The circulators are available in 4 bath sizes combined with 4 different temperature controllers. A large, 180° freely rotatable display allows good visibility and control of the values set from different angles.

PolyScience

- Temperature range -40 to 200 °C
- Reservoir sizes ranging from 7 liters to 45 liters
- Working temperature from ambient +10 °C to 200 °C
- Pressure and suction pump (selected models)
- Incl. lid and LidDock™ lid holder
- DuraTop™, precision-molded phenolic bath top resists laboratory chemicals
- Large bath opening and drain
- Swivel 180™, display with a 180° viewing radius
- Easy hook-up of fluid connections
- Intuitive setup and operation, featuring multi-language help and screen prompts
- Simplified setup and maintenance
- Class III safety, according to DIN 12876-1 Class III standards for use with flammable liquids (selected models)

2

2 Heated Circulating Baths with MX Temperature Controller

- Working Temperature: Ambient +10° to +135 °C
- Temperature Stability: ±0.07 °C
- Pump: 1-speed
- Pump Pressure (max.): 1.8 psi (0.12 bar)
- External Circulation: Closed loop

PolyScience

Bath capacity	External dimensions (W x D x H)	Pressure pump max.	Heating capacity	Bath opening	Bath tank depth	PK	Cat. No.
L	mm	L/min bar	kW	mm	mm		
7	499 x 221 x 437	11.9/0.12	1.1	157 x 142	127	1	6.281 071
15	569 x 368 x 452	11.9/0.12	1.1	212 x 276	140	1	7.920 413
20	610 x 419 x 452	11.9/0.12	1.1	250 x 316	140	1	4.658 635

3

3 Thermostatic controllers Optima™ T100/TC120

Combine with a plastic or stainless steel tank or with an accessory T-clamp for independent use. The two general purpose heating circulators offer excellent temperature stability and uniformity with a cooling/heating range of 0 °C to +100 °C* (T100) and -15 °C to +120 °C* (TC120).

Grant

***For using at or below room temperature you need additional flow coolers C1G (9.920 765) or C2G (9.920 766).**

Features:

T100: visual alarm, 2 point recalibration, fixed over temperature cut-out

TC120: visual and audible alarm, timer, 2 point recalibration, adjustable over temperature cut-out, pump for external circulation

T Clamp: For attaching the thermostats to any vertical sided tank with a maximum wall thickness of 35 mm for rectangular tanks, 30 mm for circular tanks (300 mm diameter), and a capacity of up to 50 L.

Models with clamps available on request.

Specifications

Temperature range with stainless steel tank

T100:

0 °C to +100 °C*

TC120:

-15 °C to +120 °C*

Stability/Uniformity (DIN 12876) at 70 °C:

±0.05 °C/±0.1 °C

Setting resolution:

0.1 °C

Display:

4 digit LED

No. of pre-set temperatures:

3

Recalibration points:

2

Heating power (230 V):

1.3 kW

Power supply (230 V/50-60 Hz):

1.4 kW

TC120 only:

Timer:

1 to 6000 mins

Pump max. pressure:

210 mbar

Flow rate max.:

16 l/min

Type	Description	PK	Cat. No.
T100	without pump	1	9.699 630
TC120	with pump	1	9.699 631
T clamp	-	1	9.699 634

7. Heating and cooling technology

Temperature regulators/Heating-Thermostats

1 Thermostatic controllers Optima™ TX150/TXF200

Combine with a plastic or stainless steel tank or with an accessory T-clamp for independent use. The two advanced heating circulators feature a modern, icon driven programming interface and full colour display. Cooling/heating range: -15 °C to +150 °C* (TX150) and -15 °C to +200 °C* (TXF200). ***For using at or below room temperature you need additional flow coolers C1G (9.920 765) or C2G (9.920 766).**

Grant

1



Features:

Visual and audible alarm, timer, 5 point recalibration, adjustable over temperature cut-out, pump, external probe, programmable, relay, menu system, program storage, USB port.

T Clamp: For attaching the thermostats to any vertical sided tank with a maximum wall thickness of 35 mm for rectangular tanks, 30 mm for circular tanks (300 mm diameter), and a capacity of up to 50 L.

Models with clamps available on request.

Specifications

Temperature range with stainless steel tank

TX150:	-15 °C to 150 °C*
TXF200:	-15 °C to 200 °C*
Stability/Uniformity (DIN 12876) at 70 °C:	±0.01 °C / ±0.05 °C
Setting resolution:	0.1 °C (0.01 °C with Labwise)
Display:	QVGA TFT
Timer:	1 min to 99 hrs 59 mins
No. of pre-set temperatures:	3
Recalibration points:	5
Heating power (230 V):	1.9 kW
Power supply (230 V/50-60 Hz):	2.0 kW
Interface:	USB and RS232
Pump max. pressure	
TX150:	310 mbar
TXF200:	530 mbar
Flow rate max.	
TX150:	18 l/min
TXF200:	22 l/min (adjustable)

Type	Programmable	PK	Cat. No.
TX150	remote via PC/labtop, 1 program / 30 segments	1	9.699 632
TXF200	direct via user interface or remote via PC/labtop, 10 programs / 100 segments	1	9.699 633
T clamp	-	1	9.699 634

Accessories for water baths Optima™ series

Drain syphon SY1: For the rapid draining of baths.

Grant

Heat exchange coil CW5: For use with precision and general purpose stirred baths.

Temperature range 2 °C above coolant temperature.
Coil diameter/l mm 77/55, pipe bore inlet/outlet 7 mm.

PP spheres PS20: Between operating temperatures 60 °C and 100 °C and below room temperature a lid or layers of polypropylene spheres can be used. Above 100 °C a lid must be used.

C1G refrigerated cooler:

For use with all stainless steel Optima™ baths ranging from 0 °C to +40 °C. For 220 - 240 V 50 Hz single phase supplies.

C2G refrigerated cooler:

For use with all stainless steel Optima™ baths ranging from -15 °C to +40 °C. A bath lid must be used at temperatures below 0°C, in order to achieve optimum performance. For 220 - 240 V 50 Hz single phase supplies.

2



6.239 419

Type	PK	Cat. No.
Drain syphon SY1	1	9.699 096
Heat exchange coil CW5	1	9.920 764
PP spheres PS20	300	6.239 419
Refrigerated cooler C1G	1	9.920 765
Refrigerated cooler C2G	1	9.920 766



1 Stirred thermostatic baths Optima™ series

Complete units including plastic or stainless steel bath, bridge mounting plate and thermostatic controller. For 220-240V, 50/60Hz.

Grant

- The two general purpose heating circulators offer excellent temperature stability and uniformity with a cooling/heating range of 0 to 100 °C (T100) and -15 °C to +120 °C (TC120).
- The two advanced heating circulators feature a modern, icon driven programming interface and full color display. Cooling/heating range: -15 °C to +150 °C (TX150) and -15 °C to +200 °C (TXF200).
- Grant stirred baths and circulators provide a source of precision heating and cooling. Complete range of 32 models covers basic to more sophisticated needs, each model representing excellent value for money and featuring intuitive programming and accurate, safe temperature control.
- An accessory gabled hinged lid is available to reduce evaporation, avoid heat loss and avoid sample contamination.
- High efficiency stainless steel (ST) tanks (range -15 °C to +200 °C)
- A drain trap is included on the ST12, ST18, ST26 and ST38

Accessory polypropylene spheres or a lid must be used at temperatures between 60 °C and 100 °C. Above 100 °C only a lid must be used.

For using at or below room temperature you need additional flow coolers C1G (9.920 765) or C2G (9.920 766).

Please see article table for usable working space. External dimensions incl. controller.

Please order spheres and lids separately.

Type	Capacity	External dimensions (W x D x H) mm	Working space W x D x H mm	Temp. range	Material	PK	Cat. No.
				max. °C			
T100-P5	5	235 x 325 x 380	150 x 120 x 155	amb. +15 ... +99	plastic	1	9.699 640
T100-P12	12	350 x 415 x 380	280 x 210 x 155	amb. +5 ... +99	plastic	1	9.699 641
T100-P18	18	350 x 600 x 380	375 x 280 x 155	amb. +5 ... +99	plastic	1	9.699 642
T100-ST5	5	180 x 330 x 395	150 x 150 x 150	amb. +15 ... +100	stainless steel	1	9.699 643
T100-ST12	12	330 x 360 x 415	300 x 205 x 150	amb. +5 ... +100 *	stainless steel	1	9.699 644
T100-ST18	18	330 x 540 x 415	300 x 385 x 150	amb. +5 ... +100 *	stainless steel	1	9.699 645
T100-ST26	26	330 x 540 x 465	300 x 385 x 200	amb. +5 ... +100 *	stainless steel	1	9.699 646
T100-ST38	38	330 x 730 x 460	300 x 575 x 200	amb. +5 ... +100 *	stainless steel	1	9.699 647
TC120-P5	5	235 x 325 x 380	150 x 120 x 155	amb. +15 ... +99	plastic	1	9.699 648
TC120-P12	12	350 x 415 x 380	280 x 210 x 155	amb. +5 ... +99	plastic	1	9.699 649
TC120-P18	18	350 x 600 x 380	375 x 280 x 155	amb. +5 ... +99	plastic	1	9.699 650
TC120-ST5	5	180 x 330 x 395	150 x 150 x 150	amb. +15 ... +120 *	stainless steel	1	9.699 651
TC120-ST12	12	330 x 360 x 415	300 x 205 x 150	amb. +5 ... +120 *	stainless steel	1	9.699 652
TC120-ST18	18	330 x 540 x 415	300 x 385 x 150	amb. +5 ... +120 *	stainless steel	1	9.699 653
TC120-ST26	26	330 x 540 x 465	300 x 385 x 200	amb. +5 ... +120 * **	stainless steel	1	9.699 654
TC120-ST38	38	330 x 730 x 460	300 x 575 x 200	amb. +5 ... +120 * **	stainless steel	1	9.699 655
TX150-P5	5	235 x 325 x 380	150 x 120 x 155	amb. +15 ... +99	plastic	1	9.699 656
TX150-P12	12	350 x 415 x 380	280 x 210 x 155	amb. +5 ... +99	plastic	1	9.699 657
TX150-P18	18	350 x 600 x 380	375 x 280 x 155	amb. +5 ... +99	plastic	1	9.699 658
TX150-ST5	5	180 x 330 x 395	150 x 150 x 150	amb. +15 ... +150 *	stainless steel	1	9.699 659
TX150-ST12	12	330 x 360 x 415	300 x 205 x 150	amb. +5 ... +150 *	stainless steel	1	9.699 660
TX150-ST18	18	330 x 540 x 415	300 x 385 x 150	amb. +5 ... +150 *	stainless steel	1	9.699 661
TX150-ST26	26	330 x 540 x 465	300 x 385 x 200	amb. +5 ... +150 * **	stainless steel	1	9.699 662
TX150-ST38	38	330 x 730 x 460	300 x 575 x 200	amb. +5 ... +150 * **	stainless steel	1	9.699 663
TXF200-P5	5	235 x 325 x 380	150 x 120 x 155	amb. +15 ... +99	plastic	1	9.699 664
TXF200-P12	12	350 x 415 x 380	280 x 210 x 155	amb. +5 ... +99	plastic	1	9.699 665
TXF200-P18	18	350 x 600 x 380	375 x 280 x 155	amb. +5 ... +99	plastic	1	9.699 666
TXF200-ST5	5	180 x 330 x 395	150 x 150 x 150	amb. +15 ... +200 *	stainless steel	1	9.699 667
TXF200-ST12	12	330 x 360 x 415	300 x 205 x 150	amb. +5 ... +200 *	stainless steel	1	9.699 668
TXF200-ST18	18	330 x 540 x 415	300 x 385 x 150	amb. +5 ... +200 *	stainless steel	1	9.699 669
TXF200-ST26	26	330 x 540 x 465	300 x 385 x 200	amb. +5 ... +200 * **	stainless steel	1	9.699 670
TXF200-ST38	38	330 x 730 x 460	300 x 575 x 200	amb. +5 ... +200	stainless steel	1	9.699 671

* Temperature range can be extended to 0 °C with accessory cooling of flow cooler 9.920 765.

** Temperature range can be extended to -15 °C with accessory cooling of flow cooler 9.920 766.

2



9.699 086

Lids for water baths Optima™ series

Grant

3

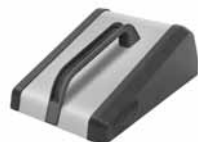

9.905 724

Type	For	Description	Material	PK	Cat. No.
PL 5	bath P 5	Flat	Stainless steel	1	9.699 085
PL 12	bath P 12	Flat	Plastic	1	9.699 086
PL 18	bath P 18	Flat	Plastic	1	9.699 087
STL5	bath ST5	Flat	Stainless steel	1	9.905 723
STL12	bath ST12	Gabled with hinge	Stainless steel	1	9.905 724
STL26	bath ST26 and ST18	Gabled with hinge	Stainless steel	1	9.905 725
STL38	bath ST38	Gabled with hinge	Stainless steel	1	9.905 726

1 Baths and Circulators

The Huber circulators are split into two product lines, the Compatible Control models and the simpler KISS models. Both model lines represent classically constructed laboratory circulators with open baths. Baths and circulators for heating applications up to +300 °C are available, as well as models for heating and cooling applications from -90 °C to +200 °C. Immersion or bridge circulators are suitable for thermal control of existing baths. The Ministat, the smallest cooling and heating circulator in the world, is the first choice for operation in fume-hoods or integrating into systems.

Circulators with Pilot ONE Controller

Models with Pilot ONE Controller convincing in practice with their highly precise temperature control and a professional range of functions even in the basic version. The electronic upgrade function "E-grade" allows a simple and low cost expansion of functions at any time. Operation is simple using large colour displays, an easily understandable menu and an individually customisable display. Models with the Pilot ONE have powerful pressure and suction pumps with continuously variable speed control for adjusting circulation to the bath in use. Further connections are available via the optional Com.G@te, e.g. RS232 and RS485, analogue interface 4 to 20 mA or 0 to 10 V, standby signal and programmable alarm.

Circulators using the KISS Controller

The functions of models with the low price KISS controller concentrate on the essentials. KISS models are suitable for numerous typical laboratory applications, such as temperature control of samples, analysis, materials testing, as well as the external temperature control of test equipment or experimental constructions. The machine achieves a temperature stability of ±0.05 °C and are fitted with an over temperature and low fluid level protection. The safety systems are according to class III/FL (DIN 12876) for use with flammable fluids.

Advantages and Functions (model dependent):

- Working Temperatures from -90 °C to +300 °C
- Models for internal and external temperature control
- High heating and cooling powers up to 7kW
- Powerful controllable circulation pumps
- Function expansion with the E-grade system is available at any time
- High precision cascade temperature control
- Large and full colour 5.7" TFT touchscreen
- Programmer with calendar/clock function
- Extended range of languages including a selection of European and Asian
- Comprehensive warning and safety functions
- Large, bright OLED display
- Simple operation via a plain text menu
- RS232 and USB Interfaces
- Safety class 3 (FL) to DIN 12876
- Internal and external temperature control

Huber



2 Immersion circulators KISS E and CC-E

Immersion circulators are the basis of many combinations of polycarbonate and stainless steel baths. Together with a cooling bath it is possible to get exact and reproducible temperatures down to -30 °C. All models are equipped with a powerful suction pressure pump and comply with safety class III (FL) for use with flammable liquids. Pump adapters for external tempering and cooling coils for cooling water connection are available as accessories.

Huber

Temp. control range °C:	(-30) 25 to 200 °C
Safety class:	FL, III
Heating capacity kW:	2 kW
suction max. (CC-E):	22 l/min/0.4 bar
suction max. (CC-E xd):	17 l/min/0.25 bar
suction max. (KISS E):	10.5 l/min/0.17 bar
Immersion depth (CC-E, KISS E):	150 mm
(CC-E xd):	195 mm

Type	Pump max. l/min / bar	Dimensions (W x D x H) mm	Temp. Stability K	PK	Cat. No.
CC-E	27 / 0.7	132 x 159 x 315	0,01*	1	9.859 201
CC-E xd	22 / 0.4	132 x 159 x 360	0,01	1	6.313 816
KISS E	14 / 0.25	132 x 163 x 312	0,05*	1	6.272 332

*according to DIN 12876, measured in 12-litre stainless steel bath.

2





1 Thermostatic baths with polycarbonate tanks

The transparent polycarbonate baths are suitable for use up to 100 °C. An immersion thermostat is mounted on the bath bridge for all models. With a pump adapter, this combination can also be used with external, closed applications. Models with the Pilot ONE controller have a variable speed pressure/suction pump and are therefore also suitable for external open applications.

Huber

Temperature max.: 100 °C
 Temp. Stability at 70 °C to DIN12876
 KISS E: 0.05 K
 CC-E: 0.02 K
 Safety class: FL, III
 Bath depth: 150 mm

Type	Bath capacity		Pressure pump max.		Dimensions (W x D x H)	Bath opening	PK	Cat. No.
	L	L/min bar	L/min bar	mm	mm			
CC-106A	6	27 / 0,7	147 x 307 x 330	130 x 110	1	9.859 203		
KISS-106A	6	14 / 0,25	147 x 307 x 330	130 x 110	1	6.272 334		
CC-108A	8	27 / 0,7	147 x 407 x 330	130 x 210	1	9.859 204		
KISS-108A	8	14 / 0,25	147 x 407 x 330	130 x 210	1	6.272 335		
CC-110A	10	27 / 0,7	147 x 507 x 330	130 x 310	1	9.859 205		
KISS-110A	10	14 / 0,25	147 x 507 x 330	130 x 310	1	6.272 336		
CC-112A	12	27 / 0,7	333 x 360 x 335	275 x 161	1	9.859 206		
KISS-112A	12	14 / 0,25	333 x 360 x 335	275 x 161	1	6.272 337		
CC-118A	18	27 / 0,7	333 x 520 x 335	275 x 321	1	9.859 207		
KISS-118A	18	14 / 0,25	333 x 520 x 335	275 x 321	1	6.272 338		



2 Heating circulators with stainless steel baths

The insulated stainless steel baths are suitable for use up to 200°C. All models have a bridge-mounted immersion circulator. With a pump adapter, this combination can also be used with externally closed and externally open (with option level control) applications. Models with the Pilot ONE controller have a variable speed pressure/suction pump and are therefore also suitable for external open applications.

Huber

Stability to DIN 12876:
 CC models: 0.02 K
 KISS models: 0.05 K
 Max. temp.: 200 °C
 Safety class: FL, III

Type	Bath capacity		Pressure pump max.		Dimensions (W x D x H)	Bath tank depth	Bath opening	PK	Cat. No.
	L	L/min bar	L/min bar	mm	mm	mm			
CC-208B	8.5	27 / 0.7	290 x 350 x 375	150	230 x 127	1	9.859 212		
KISS-208B	8.5	14 / 0.25	290 x 350 x 375	150	230 x 127	1	6.272 343		
CC-212B	12	27 / 0.7	350 x 375 x 375	150	290 x 152	1	9.859 208		
KISS-212B	12	14 / 0.25	350 x 375 x 375	150	290 x 152	1	6.272 342		
CC-215B	15	27 / 0.7	350 x 375 x 425	200	290 x 152	1	9.859 209		
KISS-215B	15	14 / 0.25	350 x 375 x 425	200	290 x 152	1	6.272 341		
CC-220B	20	27 / 0.7	350 x 555 x 375	150	290 x 329	1	9.859 210		
KISS-220B	20	14 / 0.25	350 x 555 x 375	150	290 x 329	1	6.272 340		
CC-225B	25	27 / 0.7	350 x 555 x 425	200	290 x 329	1	9.859 211		
KISS-225B	25	14 / 0.25	350 x 555 x 425	200	290 x 329	1	6.272 339		



OUR POWER DWARFS FOR YOUR LABORATORY

Our smallest – Stars in every laboratory



Inspired by **temperature**

Our smallest ones are convincing as an inexpensive and environmentally friendly solution for numerous laboratory applications. The units require little space on the laboratory bench and are therefore ideally suited for high-precision temperature control of research reactors, reactor blocks, vapour barriers, vacuum pumps, rotary evaporators or heat exchangers.

huber

www.huber-online.com



1

1 Heating circulators

Good things come in small packages! Thanks to their low bath volumes the models CC-104A und KISS-104A (with polycarbonate bath) as well as the CC-202C and KISS-202C (with stainless steel bath) are especially suitable for controlling the temperature of small external applications. All models are fitted with rear mounted M16x1 pump connections as standard. Models with the Pilot ONE have a speed regulated pressure/suction pump. The temperature constancy, in accordance with DIN12876, is 0.02 K with the Compatible Control models and 0.05 K for the KISS models. Models CC-202C and KISS-202C are fitted with an integrated cooling coil as standard. With the models CC-104A and KISS-104A the cooling coil is an optional extra.

Huber

Temperature range
 CC-104A/KISS-104A: (15) 25 to 100 °C
 CC-202C/KISS-202C: (-30) 45 to 200 °C
 Temp. Stability to DIN 12876
 CC models: 0.02 K
 KISS models: 0.05 K
 Safety class: FL, III
 Bath depth: 150 mm
 Heating capacity: 2kW

Type	Suction pump cap.	Pressure pump max.	Dimensions (W x D x H)	Bath opening	PK	Cat. No.
	L/min bar	L/min bar	mm	mm		
CC-104A	22/0.4	27/0.7	147 x 235 x 330	Ø 25	1	9.859 213
CC-202C	22/0.4	27/0.7	178 x 260 x 355	Ø 25	1	9.859 220
KISS-202C	10.5/0.17	14/0.25	178 x 260 x 355	Ø 25	1	6.272 344

2 Heating bath circulators

Heating bath circulators are suitable for temperatures up to 200 °C or 300 °C depending on model. The Compatible Control models have a continuously variable pressure and suction pump. The pump pressure can be controlled with an optional pressure sensor, and so can protect your valuable glass-ware from breakage. The machines are preferred and used for temperature control of externally connected applications. Additionally there is the ability to control the temperature of objects placed directly in the open bath.

Huber

Temperature control range
 CC-205B/KISS-205B: (20) 45 ... 200 °C
 CC-304B/CC-308B/CC-315B: 28 ... 300 °C
 Safety class: FL, III
 Stability to DIN 12876
 CC-205B/CC-304B/CC-308B/CC-315B: 0.02 K
 KISS-205B: 0.05 K

Type	Bath capacity	Suction pump cap.	Pressure pump max.	Dimensions (W x D x H)	Heating capacity	PK	Cat. No.
	L	L/min bar	L/min bar	mm	kW		
CC-205B	5.0	22 / 0.4	27 / 0.7	178 x 337 x 355	2.0	1	9.859 221
KISS-205B	5.0	10.5 / 0.17	14 / 0.25	178 x 337 x 355	2.0	1	6.272 345
CC-304B	5.0	18.5 / 0.4	25 / 0.7	210 x 335 x 392	3.0	1	9.859 222
CC-308B	8.5 / 5.2*	18.5 / 0.4	25 / 0.7	242 x 404 x 392	3.0	1	9.859 223
CC-315B	15 / 8.5*	18.5 / 0.4	25 / 0.7	335 x 382 x 433	3.0 / 4.0	1	9.859 224

*using displacement insert

2

1 Thermoregulators CORIO™

JULABO

The CORIO™ C Immersion Circulator is the basic model of the CORIO™ circulator portfolio. The bath attachment clamp is included in delivery and facilitates mounting of the circulator on any bath tank up to 30 liters. With a few simple steps you can install a pump set onto the CORIO™ CD Immersion Circulator. In no time at all, your circulator is ready for temperature control of an external application.

- Precise temperature control
- For internal standard applications
- Immersion depth: 7.5 to 16.5 cm
- Bright, white, easy to read display
- Whisper quiet
- Easy operation

CORIO™ C

- For bath tank up to 30 liters
- Class I (NFL) according to DIN 12876-1
- Circulation capacity 6 l/min at 0.1 bar

CORIO™ CD

- For bath tank up to 50 liters
- Pump change-over between internal and external circulation
- USB interface
- Class III (FL) according to DIN 12876-1
- Circulation capacity 15 l/min at 0.35 bar

Delivery without bath please order separately.

To adapt the CORIO™ Immersion Circulator to your individual application we offer a comprehensive range of accessories (racks, bath lids, and more).

Type	Heating capacity kW	Working Temp. range °C	Temp. stability ± °C	PK	Cat. No.
CORIO™ C	2	+20 ... +100	0.03	1	7.673 349
CORIO™ CD	2	+20 ... +150	0.03	1	4.658 066

Pump set for CORIO™ CD with connectors M16x1, Art. No. 4.658 027

1



2 Thermoregulators CORIO™ CP

NEW

JULABO

CORIO CP thermoregulators are capable to control the temperature of external applications in combination with an optional pump set. Suitable for bath vessels with a volume of up to 50 l.

- For internal and external applications (accessories required)
- Bright, white, easily visible display, even from a distance
- Very quiet
- Easy operation
- Low-level warning system
- Pump switch for internal and external circulation
- Powerful, continuously variable pump
- USB connection
- RS232 interface
- Class III (FL) according to DIN 12876-1

Scope of supply: Thermoregulator, mains power cable, bath attachment clamp

Specifications

Setting accuracy:	0.01 °C
Pump output:	8 ... 27 l/min
Pump pressure:	0.1 ... 0.7 bar
Immersion depth:	75 ... 165 mm
Max. viscosity:	50 cSt
Timer:	0 ... 999 min
Permissible ambient temperature:	5 ... 40 °C
Dimensions (W x D x H):	132 x 160 x 362 mm
Weight:	2.5 kg
Power supply:	230 V/50 Hz

Type	Working Temp. range °C	Temp. stability ± °C	Heating capacity kW	PK	Cat. No.
CP	20 ... 200	0.02	2	1	4.669 404

2



1

1 Thermoregulators DYNEO™ DD

JULABO

For internal and external applications. The thermoregulators with maximum flexibility can be mounted with the sturdy bath clamp to any bath up to 50 liters. Equipped with USB interface, also available with optional analogue (extra code A) or RS232 (extra code D) interface.

- Easy switching between internal and external circulation (optional pump set, Cat. No. 4.658 027)
- Large colour TFT Display
- Easy to operate via central controller
- Integrated programmer for 8 x 60 program steps
- Class III (FL) acc. to DIN 12876-1
- Continuously adjustable, powerful pressure pump
- External Pt100 sensor connection
- Installation cooling coil for counter-cooling, Cat No. 4.658 026, available separately

Bath clamp included.

Specifications

Operating temperature range:	20...200 °C
Temperature stability:	0.01 °C
Heating capacity:	2 kW
Flow rate:	8 ... 27 l/min
Pump capacity:	0.1 ... 0.7 bar
Dimensions (W x D x H):	130 x 160 x 360 mm
Weight:	2.5 kg
Power supply:	200-230 V, 50/60 Hz

Type	PK	Cat. No.
DD	1	4.663 220
DD.A	1	4.663 233
DD.D	1	4.663 246

2

2 Bridge circulators MAGIO MS and MX

NEW

JULABO

Thanks to the adjustable stainless steel bridge the thermostats can be used with bath tanks up to a filling volume of 100 litres and bath widths from 33 to 68 cm.

- Simple control of complex applications
- Infinitely adjustable, extremely powerful pressure and suction pump
- Large, high-resolution TFT touch display with multilingual user interface
- Medium-contacting parts made of stainless steel
- Integrated programmer
- External Pt100 connection
- USB interface
- RS232 interface
- Ethernet interface
- Analogue interfaces (optionally)
- Classification III according to DIN 12876-1

Specifications:

Temperature stability:	±0.01 °C
Flow rate:	16 ... 31 l/min
Pump pressure:	0.24 ... 0.92 bar
Suction pressure:	0.03 ... 0.4 bar
Immersion depth:	150 mm // 200 mm
Heating capacity:	2000 W // 3000 W
Permissible ambient temperature:	5 ... 40 °C
Power supply:	230 V/50 ... 60 Hz

MS-Z // MX-Z

Type	Dimensions (W x D x H) mm	Temp. range °C	Heating power W	PK	Cat. No.
MS-Z	340 x 190 x 360	20 ... 300	2000	1	4.678 302
MX-Z	340 x 190 x 410	20 ... 300	3000	1	4.678 309

1 Heating circulators MAGIO MS and MX NEW 1

For precise temperature control of internal and external applications from 3 to 26 litres.



- Simple control of complex applications
- Infinitely adjustable, extremely powerful pressure and suction pump
- Large, high-resolution TFT touch display with multilingual user interface
- Medium-contacting parts made of stainless steel
- Integrated programmer
- External Pt100 connection
- USB interface
- RS232 interface
- Ethernet interface
- Analogue interfaces (optionally)
- Classification III according to DIN 12876-1
- High quality thermal insulation of the bath tanks
- Integrated drain cock for easy and safe emptying

Specifications:	MS-BC // MX-BC
Temperature stability:	±0.01 °C
Flow rate:	16 ... 31 l/min
Pump pressure:	0.24 ... 0.92 bar
Suction pressure:	0.03 ... 0.4 bar
Heating capacity:	2000 W // 3000 W
Permissible ambient temperature:	5 ... 40 °C
Power supply:	230 V/50 ... 60 Hz

Type	Filling volume	Dimensions (W x D x H)	Bath opening	Bath tank depth	Temp. range	Heating power	PK	Cat. No.
	L	mm	mm	mm	°C	W		
MS-BC4	3 ... 4.5	230 x 410 x 420	130 x 150	150	20 ... 300	2000	1	4.678 303
MX-BC6	4.5 ... 6	240 x 440 x 470	130 x 150	200	20 ... 300	3000	1	4.678 310
MX-BC12	8.5 ... 12	330 x 490 x 470	220 x 150	200	20 ... 300	3000	1	4.678 311
MX-BC26	19 ... 26	390 x 620 x 480	260 x 350	200	20 ... 300	3000	1	4.678 312

2 3 Accessories for heating thermostats CORIO™

Transparent bath tanks and stainless steel bath tank for CORIO™

JULABO

For Type	Description	Internal dimensions (W x D x H) mm	External dimensions (W x D x H) mm	PK	Cat. No.
C,CD	Transparent bath tank BT5, up to +100 °C	150 x 300 x 150	220 x 370 x 160	1	4.658 013
C,CD	Transparent bath tank BT9, up to +100 °C	240 x 300 x 150	310 x 370 x 160	1	4.658 014
C,CD	Transparent bath tank BT19, up to +100 °C	300 x 500 x 150	370 x 580 x 160	1	4.658 015
C,CD	Transparent bath tank BT27, up to +100 °C	300 x 500 x 200	370 x 580 x 210	1	4.658 016
C,CD	Stainless steel bath tank B5, up to +150 °C	150 x 300 x 150	220 x 370 x 200	1	4.658 017
C,CD	Stainless steel bath tank B13, up to +150 °C	300 x 320 x 150	370 x 400 x 200	1	4.658 018
C,CD	Stainless steel bath tank B17, up to +150 °C	300 x 320 x 200	370 x 400 x 250	1	4.658 019
C,CD	Stainless steel bath tank B19, up to +150 °C	300 x 500 x 150	370 x 580 x 200	1	4.658 020
C,CD	Stainless steel bath tank B27, up to +150 °C	300 x 500 x 200	370 x 580 x 250	1	4.658 021
C,CD	Stainless steel bath tank B33, up to +150 °C	830 x 300 x 150	900 x 360 x 200	1	4.658 022
C,CD	Stainless steel bath tank B39, up to +150 °C	300 x 500 x 300	340 x 580 x 350	1	4.658 023

2



3



1

1 Circulator Baths, CORIO™ C with transparent bath tanks

CORIO™ C Open Heating Bath Circulators for internal temperature applications with transparent bath tanks for working temperatures from 20 °C to 100 °C.

JULABO

- For internal applications
 - Bright, white, easy to read display
 - Whisper quiet
- Working temperature range: 20 ... 100 °C
 Temperature stability: ±0.03 °C
 Heating capacity: 2 kW
 Pump capacity: 6 l/min/0.1 bar

Type	Filling volume	Dimensions (W x D x H)	Bath opening	Bath tank depth	PK	Cat. No.
	L	mm	mm	mm		
CORIO™ C-BT5	3.5 - 5	230 x 380 x 380	150 x 150	150	1	4.657 985
CORIO™ C-BT9	6 - 9	320 x 380 x 380	230 x 150	150	1	4.657 986
CORIO™ C-BT19	14 - 19	380 x 580 x 380	300 x 350	150	1	4.657 987
CORIO™ C-BT27	20 - 27	380 x 580 x 430	300 x 350	200	1	4.657 988

2

2 Circulator Baths, CORIO™ C with stainless steel bath tanks

CORIO™ C Open Heating Bath Circulators for internal temperature applications with stainless steel bath tanks for working temperatures from +20 °C to +100 °C, complete set with bath tanks.

JULABO

- For internal applications
 - Bright, white, easy to read display
 - Whisper quiet
 - Integrated drain screw (except for B5)
- Working temperature range: 20 ... 100 °C
 Temperature stability: ±0.03 °C
 Heating capacity: 2 kW
 Flow rate: 6 l/min
 Pressure: 0.1 bar

Type	Filling volume	Dimensions (W x D x H)	Bath opening	Bath tank depth	PK	Cat. No.
	L	mm	mm	mm		
CORIO™ C-B5	3.5 - 5	230 x 380 x 410	150 x 150	150	1	4.657 989
CORIO™ C-B13	9 - 13	380 x 400 x 420	300 x 180	150	1	4.657 990
CORIO™ C-B17	13 - 17	380 x 400 x 470	300 x 180	200	1	4.657 991
CORIO™ C-B19	14 - 19	380 x 580 x 420	300 x 350	150	1	4.657 992
CORIO™ C-B27	17 - 27	380 x 580 x 470	300 x 350	200	1	4.657 993

3

3 Circulator baths, CORIO™ CD with transparent bath tanks

CORIO™ CD Open Heating Bath Circulators for internal and external temperature applications with transparent bath tanks for working temperatures from +20 °C to +100 °C. The Open Heating Bath Circulator of the new CORIO™ series feature durable, high-quality transparent bath tanks and pump connections.

JULABO

- For internal and external applications
 - Bright, white, easy to read display
 - Very quiet
 - Pump change-over between internal and external circulation
 - USB connection
 - Class III (FL) according to DIN 12876-1
- Working temperature range: 20 ... 100 °C
 Temperature stability: ±0.03 °C
 Heating capacity: 2 kW
 Flow rate: 15 l/min
 Pressure: 0.35 bar

Type	Filling volume	Dimensions (W x D x H)	Bath opening	Bath tank depth	PK	Cat. No.
	L	mm	mm	mm		
CORIO™ CD-BT5	3.5 - 5	230 x 380 x 380	150 x 150	150	1	4.657 994
CORIO™ CD-BT19	14 - 19	380 x 580 x 380	300 x 350	150	1	4.657 995
CORIO™ CD-BT27	20 - 27	380 x 580 x 430	300 x 350	200	1	4.657 996

1 Circulator baths, CORIO™ CD with stainless steel bath tanks

CORIO™ CD Open Heating Bath Circulators for internal and external temperature applications with stainless steel bath tanks for working temperatures from +20 °C to +150 °C. The Open Heating Bath Circulators of the new CORIO™ series feature high-quality bath tanks made of stainless steel and with pump connections.

JULABO

- For internal and external applications
- Bright, white, easy to read display
- Very quiet
- Pump change-over between internal and external circulation
- USB connection
- Integrated drain screw (except for B5)

Working temperature range: 20 ... 150 °C
 Temperature stability: ±0.03 °C
 Heating capacity: 2 kW
 Flow rate: 15 l/min
 Pressure: 0.35

Type	Filling volume	Dimensions (W x D x H)	Bath opening	Bath tank depth	PK	Cat. No.
	L	mm	mm	mm		
CORIO™ CD-B5	3.5 - 5	230 x 380 x 410	150 x 150	150	1	4.657 997
CORIO™ CD-B13	9 - 13	380 x 400 x 420	300 x 180	150	1	4.657 998
CORIO™ CD-B17	13 - 17	380 x 400 x 470	300 x 180	200	1	4.657 999
CORIO™ CD-B19	14 - 19	380 x 580 x 420	300 x 350	150	1	4.658 000
CORIO™ CD-B27	17 - 27	380 x 580 x 470	300 x 350	200	1	4.658 001
CORIO™ CD-B33	26 - 39	910 x 360 x 430	660 x 320	150	1	4.658 002
CORIO™ CD-B39	35 - 41	540 x 340 x 570	330 x 300	300	1	4.658 003

Bath covers

Flat bath cover or lift-up gable bath cover made of stainless steel.

JULABO

For Type	Description	Material	PK	Cat. No.
B5, B15	Flat bath cover	stainless steel	1	4.658 040
B13, B17	Flat bath cover	stainless steel	1	4.658 036
B19, B27, B19, B27	Flat bath cover	stainless steel	1	4.658 037
B33	Flat bath cover	stainless steel	1	4.658 038
B39	Flat bath cover	stainless steel	1	4.658 039
B13, B17	Lift-up gable bath cover	stainless steel	1	4.658 033
B19, B27, B19, B27	Lift-up gable bath cover	stainless steel	1	4.658 034
B33	Lift-up gable bath cover	stainless steel	1	4.658 035

4 Circulator Baths, CORIO™ CD

CORIO™ CD Heating Circulators for internal and external temperature applications with stainless steel baths for working temperatures from +20 °C to +150 °C. CORIO™ Heating Circulators feature professional technology for demanding applications. These units facilitate internal temperature control in the bath tank or control of externally connected applications.

JULABO

- For internal and external applications
- Bright, white, easy to read display
- Very quiet
- Pump change-over between internal and external circulation
- USB connection
- High-quality bath tanks made of stainless steel with bath lid and drain tap
- Integrated cooling coil for counter-cooling

Working temperature range: +20 ... +150 °C
 Temperature stability: ±0.03 °C
 Heating capacity: 2 kW
 Flow rate: 15 l/min
 Pressure: 0.35 bar

Type	Filling volume	Dimensions (W x D x H)	Bath opening	Bath tank depth	PK	Cat. No.
	L	mm	mm	mm		
CORIO™ CD-BC4	3 - 4,5	230 x 410 x 420	130 x 150	150	1	4.658 004
CORIO™ CD-BC6	4,5 - 6	240 x 440 x 470	130 x 150	200	1	4.658 005
CORIO™ CD-BC12	8,5 - 12	330 x 490 x 470	220 x 150	200	1	4.658 006
CORIO™ CD-BC26	19 - 26	390 x 620 x 480	260 x 350	200	1	4.658 007



1

1 Circulator Baths, CORIO™ CP

NEW
 JULABO

With insulated stainless steel bath tanks, flexible performance and an operating temperature range of up to 200 °C. Temperature control is possible either in the internal bath or in a connected external application.

- Suitable for internal and external applications
- High-quality stainless steel bath vessels with bath lid and drain
- Integrated pump connections M16x1
- Integrated cooling coil for counter-cooling
- Bright, white, easily visible display, even from a distance
- Low-level warning system
- Easy switching between internal and external circulation
- Powerful, continuously variable pump
- Pump capacity adjustable from 8 to 27 l/min
- Very quiet
- Rubber feet for secure standing
- USB connection
- RS232 interface
- 3-point calibration
- Class III (FL) according to DIN 12876-1

Scope of supply: Circulator bath, mains power cable, connection box, bath, bath cover, hose connectors 8 and 12 mm

Specifications

Temperature range:	20 ... 200 °C
Setting accuracy:	0.01 °C
Temperature uniformity:	±0.02 °C
Pump output:	8 ... 27 l/min
Pump pressure:	0.1 ... 0.7 bar
Heat output:	2 kW
Timer:	0 ... 999 min
Hose connector inner width:	8/12 mm
Permissible ambient temperature:	5 ... 40 °C
Power supply:	230 V/50 Hz

Type	Capacity of the bath litres	Bath opening mm	Bath tank depth mm	Weight kg	External dimensions (W x D x H) mm	PK	Cat. No.
CP-BC4	4.5	130 x 150	150	8.5	230 x 410 x 420	1	4.669 405
CP-BC6	6.0	130 x 150	200	10.0	240 x 440 x 470	1	4.670 677
CP-BC12	12.0	220 x 150	200	12.0	330 x 490 x 470	1	4.670 678
CP-BC26	26.0	260 x 350	200	19.0	390 x 620 x 480	1	4.670 679

2

2 Reaction vessels, cylindrical, with thermostatic jacket

Lenz

- With graduation
- Laboratory flange LF
- Groove
- Flat bottom
- Two connectors with threads GL 14 or GL 18
- Made of DURAN® tubing

Other sizes on request.

Nominal capacity ml	Flange (LF)	Outer/ inner diam. mm	Height mm	Int. height mm	Connection	PK	Cat. No.
100	60	90/60	135	115	GL 14	1	9.142 726
250	60	90/60	190	170	GL 14	1	9.142 727
500	60	90/60	275	255	GL 14	1	9.142 728
1000	60	90/60	245	220	GL 18	1	6.243 104
250	100	130/93	160	140	GL 18	1	6.243 105
500	100	130/93	180	155	GL 18	1	9.142 741
1000	100	130/93	245	220	GL 18	1	9.142 742
2000	100	130/93	375	350	GL 18	1	9.142 744
3000	100	190/150	325	285	GL 18	1	6.243 106
4000	100	190/150	380	340	GL 18	1	9.142 747
2000	150	190/150	265	225	GL 18	1	9.142 754
3000	150	190/150	320	280	GL 18	1	6.089 893
4000	150	190/150	375	335	GL 18	1	9.142 757
5000	150	190/150	430	390	GL 18	1	6.243 107
6000	150	190/150	485	445	GL 18	1	9.142 759

1 Heating circulator baths DYNEO™ DD

For internal and external applications. With powerful components and a large, easy-to-read colored TFT display. Operation is simple and intuitive via the central controller on the front of the device. Equipped with USB interface and with additional analogue (extra code A) or RS232 (extra code D) interface.

JULABO

1



- Easy switching between internal and external circulation
- Integrated cooling coil for counter-cooling
- Built-in drain tap
- Integrated programmer for 8 x 60 program steps
- Class III (FL) acc. to DIN 12876-1
- Continuously adjustable, powerful pressure pump
- Pump connections M16x1 (outer thread)
- External Pt100 sensor connection

2 hose connectors for 8 and 12 mm I.W. and bath lid included.

Specifications

Operating temperature range:	20...200 °C
Temperature stability:	0.01 °C
Heating capacity:	2 kW
Flow rate:	8 ... 27 l/min
Pump capacity:	0.1 ... 0.7 bar
Power supply:	200-230 V, 50/60 Hz

Type	Filling volume	Bath opening	Bath tank depth	Weight	PK	Cat. No.
	L					
DD-BC4	3.0 - 4.5	130 x 150	150	8.5	1	4.663 221
DD-BC6	4.5 - 6.0	130 x 150	200	9.7	1	4.663 222
DD-BC12	8.5 - 12.0	220 x 150	200	11.9	1	4.663 223
DD-BC26	19.0 - 26.0	260 x 350	200	18.7	1	4.663 224
DD-BC4.A	3.0 - 4.5	130 x 150	150	8.5	1	4.663 234
DD-BC6.A	4.5 - 6.0	130 x 150	200	9.7	1	4.663 235
DD-BC12.A	8.5 - 12.0	220 x 150	200	11.9	1	4.663 236
DD-BC26.A	19.0 - 26.0	260 x 350	200	18.7	1	4.663 237
DD-BC4.D	3.0 - 4.5	130 x 150	150	8.5	1	4.663 247
DD-BC6.D	4.5 - 6.0	130 x 150	200	9.7	1	4.663 248
DD-BC12.D	8.5 - 12.0	220 x 150	200	11.9	1	4.663 249
DD-BC26.D	19.0 - 26.0	260 x 350	200	18.7	1	4.663 250

2 Stabilizing/Weighting rings, lead

LAB-Rings to stabilise glassware and plasticware on shakers or to immerse in water baths. Vinyl-coated lead rings will not mark or scratch benchtops and labware.

Heathrow Scientific

2



Type	For flasks ml	Int. diam. mm	PK	Cat. No.
O-Shape	5 ... 10	18	1	7.072 085
O-Shape	125 ... 500	48	1	6.243 010
O-Shape	250 ... 1000	51	1	6.242 742
O-Shape	500 ... 2000	57	1	6.243 011
O-Shape	1000 ... 4000	70	1	7.054 161
C-Shape	125 ... 500	42	1	9.149 902
C-Shape	250 ... 1000	51	1	9.149 905
C-Shape	500 ... 2000	54	1	9.149 906
C-Shape	1000 ... 4000	66	1	9.149 907

➔ Water baths please see page 829.



1

1 Refrigerated/heated circulators

The circulators are available in 4 bath sizes combined with 4 different temperature controllers. A large, 180° freely rotatable display allows good visibility and control of the values set from different angles.

PolyScience

- Temperature range -40 to 200 °C
- Reservoir sizes ranging from 7 liters to 45 liters
- Working temperature from ambient +10 °C to 200 °C
- Pressure and suction pump (selected models)
- Incl. lid and LidDock™ lid holder
- DuraTop™, precision-molded phenolic bath top resists laboratory chemicals
- Large bath opening and drain
- Swivel 180™, display with a 180° viewing radius
- Easy hook-up of fluid connections
- Intuitive setup and operation, featuring multi-language help and screen prompts
- Simplified setup and maintenance
- Class III safety, according to DIN 12876-1 Class III standards for use with flammable liquids (selected models)

2

2 Refrigerated Circulators with MX Temperature Controller

PolyScience

- Working Temperature: From -30° up to +135 °C
- Temperature Stability: ±0.07 °C
- Pressure Pump with one pump speed
- Maximum Pressure: 1.8 psi (0.12 bar)
- External circulation: closed loop

Capacity	Dimensions (W x D x H)	Heating capacity	Cooling capacity kW at 20 °C	Temp. range	Bath opening	Bath tank depth	PK	Cat. No.
l	mm	kW		max. °C	mm	mm		
7	157 x 142 x 127	1.1	0.2	-20 ... +135	157 x 142	127	1	4.658 606
15	212 x 276 x 140	1.1	0.9	-30 ... +135	212 x 276	140	1	4.658 616
20	250 x 316 x 140	1.1	0.9	-30 ... +135	250 x 316	140	1	6.283 678

3

3 Refrigerated Circulators with Standard Digital (SD) Temperature Controller

PolyScience

- Working Temperature: From -30° up to +170 °C
- Temperature Stability: ±0.04 °C
- Large, universal icon and English display
- Swivel 180™ Rotating Controller
- Pressure Pump with two speeds
- Pump pressure max. 2.9 psi (0.20 bar)
- On-board connectivity: RS-232 serial output
- Adjustable over- or under-temperature
- Automatic performance optimization
- Single-point calibration capability

Capacity	Dimensions (W x D x H)	Heating capacity	Cooling capacity kW at 20 °C	Temp. range	Bath opening	Bath tank depth	PK	Cat. No.
l	mm	kW		max. °C	mm	mm		
7	157 x 142 x 127	2.2	0.2	-20 ... +170	157 x 142	127	1	6.280 874
15	212 x 276 x 140	2.2	0.9	-30 ... +170	212 x 276	127	1	4.658 615
20	250 x 316 x 140	2.2	0.9	-30 ... +170	250 x 316	140	1	4.658 620
28	314 x 359 x 140	2.2	0.9	-30 ... +170	314 x 359	140	1	4.658 623

7. Heating and cooling technology

Temperature regulators/Cooling-Thermostats

1 Refrigerated Circulators with Advanced Digital (AD) Temperature Controller

- Working Temperature: From -40° up to +200 °C
- Temperature Stability: ±0.01 °C
- Intuitive 3.75" (9.5 cm) display with touch-pad control
- 4 languages: French, German, Spanish, English
- Swivel 180™ Rotating Controller
- Pump speed variable external temperature control capability
- Pump pressure max. 4.3 psi (0.3 bar)
- On-board connectivity: USB-A & B, Ethernet, RS-232/RS-485, and external temperature probe
- Adjustable over- or under-temperature
- On-screen prompts
- Single-point calibration capability

PolyScience



Capacity	Dimensions (W x D x H)	Heating capacity	Cooling capacity kW at 20 °C	Temp. range	Bath opening	Bath tank depth	PK	Cat. No.
l	mm	kW		max. °C	mm	mm		
7	157 x 142 x 127	2.2	0.20	-20 ... +200	157 x 142	127	1	6.281 080
7	157 x 142 x 127	2.2	0.36	-40 ... +200	157 x 142	127	1	4.658 612
15	212 x 276 x 140	2.2	0.90	-30 ... +200	212 x 276	140	1	4.658 614
15	212 x 276 x 140	2.2	1.00	-40 ... +200	212 x 276	140	1	4.658 618
20	250 x 316 x 140	2.2	0.90	-30 ... +200	250 x 316	140	1	6.281 652
28	314 x 359 x 140	2.2	0.90	-30 ... +200	314 x 359	140	1	4.658 622
45	549 x 398 x 140	2.2	1.40	-25 ... +135	549 x 398	140	1	4.658 625

2 Refrigerated Circulators with Advanced Programmable (AP) Temperature Controller

- Working Temperature: From -40° up to +200 °C
- Temperature Stability: ±0.005 °C
- Time/temperature programming (ten 100-step programs)
- Intuitive 4.3" (10.9 cm) SmartTouch display
- 11 languages: French, German, Spanish, Chinese, Arabic, English, Portuguese, Russian, Hindi, Italian, Korean
- Variable speed pump with open- and closed-loop external circulation capability
- Swivel 180™ Rotating Controller
- On-board connectivity: USB-A & B, Ethernet, RS-232/RS-485, remote on/off and external temperature probe
- Event scheduling (time & date) with real-time clock
- Review temperature trends for up to 10 days
- Multiple selectable "home" screens
- On-screen help
- Automatic and/or user-adjustable performance optimization
- 10-point calibration capability

PolyScience



Capacity	Dimensions (W x D x H)	Heating capacity	Cooling capacity kW at 20 °C	Temp. range	Bath opening	Bath tank depth	PK	Cat. No.
l	mm	kW		max. °C	mm	mm		
7	157 x 142 x 127	2.2	0.20	-20 ... 200	157 x 142	127	1	4.658 605
7	157 x 142 x 127	2.2	0.36	-40 ... 200	157 x 142	127	1	4.658 611
15	212 x 276 x 140	2.2	0.92	-30 ... 200	212 x 276	140	1	4.658 613
15	212 x 276 x 140	2.2	1.00	-40 ... 200	212 x 276	140	1	4.658 617
20	250 x 316 x 140	2.2	0.92	-30 ... 200	250 x 316	140	1	4.658 619
28	314 x 359 x 140	2.2	0.92	-30 ... 200	314 x 359	140	1	4.658 621
45	549 x 398 x 140	2.2	1.40	-25 ... 135	549 x 398	140	1	4.658 624

3 Refrigerated/heated circulating baths LT ecocool

Consisting of two models, all products in the LT ecocool range are supplied assembled as ready to use kits, complete with accessory hosing, clips and connectors as standard.

Grant

- Choice of two models, temperature range -25 °C to 150 °C (model dependent)
- Industry leading 4 year warranty with Grant renowned service and support, no registration required
- Active cooling through the whole temperature range
- True energy saving of up to 80% against standard compressor units
- Thermostat and chiller work in harmony, neither will operate alone, eliminating any danger of overheating or freezing
- Single front switch for user convenience
- Modern, sleek, attractive design



Type	Capacity	Dimensions (W x D x H)	Heating power	Cooling capacity kW at 20/0/-20°C	Temp. range	PK	Cat. No.
	l	mm	W		max. °C		
LT ecocool 100	5	245 x 430 x 640	2160	210/184/21	-20 to 100	1	6.282 852
LT ecocool 150	6	245 x 430 x 640	2280	378/189/53	-25 to 150	1	6.286 686

1

1 Refrigerated circulators LTC 4

Versatile system for the laboratory, with a comprehensive specification to suit most low temperature applications.

Grant

- Optima™ digital thermostat for precise temperature control: assembled with TX 150
- Cooling/heating range -30 to 100 °C
- Stability ± 0.1 °C
- Powerful integral pump; allows temperature-controlled fluid to be circulated to external devices (18 L/min, 310 mbar)
- Easy to use rotary dial and two function keys
- Clear 4 digit display - easy to read from a distance for instant reassurance
- Visual alarm and countdown timer; alerts you when your attention is required
- User calibration facility for optimum accuracy at the required operating temperature
- Operating setpoint plus 3 adjustable preset temperatures for convenience
- Liquid protection and over-temperature cut-out
- Easy access to coolant reservoir for local cooling of tubes, bottles etc.
- Powerful efficient cooling, ozone-friendly refrigerant
- Dual-position bridge plate, ensures visibility/accessibility of the thermostat whilst optimising bench space
- Robust construction, corrosion resistant materials, stainless steel tank; durable in demanding environments
- 5 °C thermostat on/off switch; stops tank freezing when operating with water

Type	Capacity	Dimensions (W x D x H)	Heating power	Cooling capacity kW at 20/0/-20 °C	Temp. range	PK	Cat. No.
	l	mm	W		max. °C		
LTC 4	20	390 x 490 x 730	1900	0.90/0.50/0.18	-30 to +100	1	9.721 067

2 Cooling circulators

Combinations of immersion circulators and insulated refrigeration baths are low-cost solutions for direct thermoregulation within the temperature range -20/-30 °C to +200 °C. The refrigeration baths operate with natural refrigerants. A pump adapter (optional) can be fitted for thermoregulation of externally closed applications. Models with the Pilot ONE controller have a variable speed pressure/suction pump and are therefore suitable for external open thermoregulation applications. The temperature stability is 0.02 K for the Compatible Control models and 0.05 K for the KISS models.

Huber

Type	Bath capacity	Pump max.	Dimensions (W x D x H)	Bath opening	Cooling capacity kW at 0/-10/-20 °C	Working Temp. range °C	PK	Cat. No.
	L	l/min / bar	mm	mm				
CC-K12	12	27 / 0.7	350 x 560 x 430	290 x 152	0.2/0.12/0.05	-20 ... +200	1	9.859 227
KISS-K12	12	14 / 0.25	350 x 560 x 430	290 x 152	0.2/0.12/0.05	-20 ... +200	1	6.287 658
CC-K15	15	27 / 0.7	350 x 560 x 430	290 x 152	0.2/0.12/0.05	-20 ... +200	1	9.859 228
KISS-K15	15	14 / 0.25	350 x 560 x 430	290 x 152	0.2/0.12/0.05	-20 ... +200	1	6.272 329
CC-K20	20	27 / 0.7	350 x 555 x 615	290 x 329	0.35/0.27/0.16	-30 ... +200	1	9.859 229
KISS-K20	20	14 / 0.25	350 x 555 x 615	290 x 329	0.35/0.27/0.16	-30 ... +200	1	6.272 330
CC-K25	25	27 / 0.7	350 x 555 x 615	290 x 329	0.35/0.27/0.16	-30 ... +200	1	9.859 230
KISS-K25	25	14 / 0.25	350 x 555 x 615	290 x 329	0.35/0.27/0.16	-30 ... +200	1	6.272 331

2

1 Compatible Control Refrigeration Circulators K6

The K6 models are compact refrigeration bath circulators for temperatures from -25 to 200 °C. These units are a combination of a refrigerated bath and immersion circulator, in combination with an integrated pump they are suitable for external open (with level control) and closed applications. The CC-E immersion circulator with its suction/pressure pump is suitable to externally open and closed applications. The temperature stability is 0.02 K for the Compatible Control models and 0.05 K for the KISS models.

Safety class: FL, III
 Heating capacity: 2 kW
 Pressure pump
 CC-K6/CC-K6s: 27 L/min/0.7 bar
 KISS-K6/KISS-K6s: 14 L/min/0.25 bar

Huber



Type	Bath capacity	Dimensions (W x D x H)	Bath opening	Cooling capacity kW at 0/-10/-20 °C	Temp. range	PK	Cat. No.
	L	mm	mm		max. °C		
CC-K6	4.5	210 x 400 x 546	140 x 120	0.15/0.1/0.05	-25 ... +200	1	9.859 226
KISS-K6	4.5	210 x 400 x 546	140 x 120	0.15/0.1/0.05	-25 ... +200	1	6.272 327
CC-K6s	4.5	210 x 400 x 546	140 x 120	0.21/0.15/0.05	-25 ... +200	1	9.859 225
KISS-K6s	4.5	210 x 400 x 546	140 x 120	0.21/0.15/0.05	-25 ... +200	1	6.272 328

All units use natural refrigerant as standard.

2 Compact refrigerated circulators - Ministat®

Exceptionally compact and powerful, Ministats have been the smallest cooling circulators in the world since 1976. Their compact form allows them to be placed in small spaces, e.g. in a laboratory extraction hood. Compliance with DIN 12876, class 3 allows them to be used unsupervised in continual operation. The maximum ambient temperature is 40 °C. The powerful variable speed pressure/suction pump can thermoregulate objects in the bath or external applications. The maximum pressure can be controlled using an optional pressure sensor - VPC (Variable Pressure Control) - which protects delicate glassware. The small volume and high power of the Ministats means exceptionally rapid heating and cooling rates are achieved. Optional displacement inserts reduce the bath volume by approximately 50 % amplifying this effect and reducing moisture absorption in the thermal fluid. All models have Active Cooling Control for cooling power control at the maximum working temperature and an automatic cooling power regulation for energy saving operation and reduced heat dissipation into the lab. The bath opening is large enough to allow small objects to be thermoregulated within. All parts in contact with the thermal fluid are made of stainless steel or Polycarbonate. Ministats have the Pilot ONE with Plug & Play technology (proven since 1980). In the event of service the controller can be simply swapped. Using a data cable the Ministat can be remotely controlled. The Pilot ONE has a state of the art microprocessor controller and a high precision temperature measurement system for exact and reproducible temperature control. The functionality and TFT-display are supported by Easy Control. Typical applications for the smallest cooling circulator in the world are external closed systems e.g. photometer, refractometer and viscosimeter.

Huber



Pump pressure max.: 27 L/min / 0.7 bar
 Max. suction: 20 L/min / 0.4 bar
 Temperature Stability to DIN 12876: 0.02 K

Type	Bath capacity	Dimensions (W x D x H)	Bath tank depth	Heating power	Cooling capacity kW at 0/-20/-30 °C	Working Temp. range	PK	Cat. No.
	L	mm	mm	W		max. °C		
Ministat® 125	2.75/1.3*	225 x 370 x 429	120	1000	0.21/0.05/--	-25 ... +150	1	6.257 173
Ministat® 125w	2.75/1.3*	225 x 370 x 429	120	1000	0.20/0.10/--	-25 ... +150	1	9.859 232
Ministat® 230	3.2/1.7*	255 x 450 x 476	135	2000	0.38/0.25/0.14	-40 ... +200	1	9.859 233
Ministat® 230w	3.2/1.7*	255 x 450 x 476	135	2000	0.38/0.25/0.14	-40 ... +200	1	9.859 234
Ministat® 240	4.9/2.8*	300 x 465 x 516	157	2000	0.55/0.35/0.125	-45 ... +200	1	9.859 235
Ministat® 240w	4.9/2.8*	300 x 465 x 516	157	2000	0.55/0.35/0.125	-45 ... +200	1	9.859 236

All units use natural refrigerant as standard.

*with displacement insert

1
1 Refrigeration Bath Circulators to -45 °C

HUBER refrigerated bath circulators perform safe and repeatable heating and cooling tasks in the lab. The models are covering the range to -45 °C with a selection of heating and cooling powers are available with air or water cooling (w). Natural refrigerants for environmentally friendly operation are available on request. A powerful variable speed pressure/suction pump allows the thermoregulation of objects directly in the bath or can be used to control external applications. The pump speed is stepless and when used in combination with an optional pressure sensor the maximum pressure can be controlled. VPC (Variable Pressure Control) ensures the best circulation and protects delicate glass apparatus from breakage caused by overpressure. Small volume and high heating and cooling powers result in the shortest heating and cooling rates. Optional displacement inserts reduce the bath volume by half increasing this effect. Additionally the bath surface area is reduced, lowering moisture absorption. The optional calibration insert allows all HUBER refrigeration circulators to be used as calibration baths. The calibration insert ensures an even temperature distribution with a temperature stability of ±0.01K. All models have Active Cooling Control for cooling power control at the maximum working temperature and an automatic cooling power regulation for energy saving operation and reduced heat dissipation into the lab. Depending on the model carry handles or castors are fitted for easy transportation. The drain is located on the front of the unit to enable simple drainage of the bath. The cover plate is thermoregulated to avoid condensation. All models have the Pilot ONE with Plug & Play technology which can be simply swapped in the event of a service. The Pilot ONE can be used as a remote control (with data cable). The Pilot ONE is a high tech microprocessor based controller with a high precision measurement system for exact and reproducible results. The wide ranging functionality is supported by a large TFT display and simple operation. HUBER refrigeration circulators can be equipped with a Com.G@te to the NAMUR standard to enable integration in a process control system. Depending on the bath dimensions objects can be thermoregulated within the bath. Typical applications for these classics are the thermoregulation of externally closed systems, e.g. photometer, refractometer, viscosimeter, double-jacketed reactors and autoclaves. They are used in miniplants, kilo labs, for stock point measurement, for low temperature calibration, for petroleum tests and many more applications.

Huber

Option: Natural refrigerant available on request

Pump data

Max. pressure:

25 L/min/0.7 bar

Max. suction:

18.5 L/min/0.4 bar

Temp. stability acc. to DIN 12876:

0.02 K

Type	Bath capacity	Bath tank depth	Heating power	Cooling capacity	Working Temp. range °C	PK	Cat. No.
	L	mm	W	KW at 100/20/0/-20/-30/-40°C			
CC-405	5	150	1500	0.7 / 0.7 / 0.7 / 0.45 / 0.18 / 0.03	-40 ... +200	1	9.859 237
CC-405w	5	150	1500	0.7 / 0.7 / 0.7 / 0.45 / 0.18 / 0.03	-40 ... +200	1	9.859 238
CC-410	22 / 8.5*	200	3000	0.8 / 0.8 / 0.8 / 0.5 / 0.15 / 0.1	-45 ... +200	1	9.857 403
CC-410wl	22 / 8.5*	200	3000	0.8 / 0.8 / 0.8 / 0.5 / 0.15 / 0.1	-45 ... +200	1	9.859 243
CC-415	5	150	1500	1.2 / 1.2 / 1.0 / 0.6 / 0.2 / 0.05	-40 ... +200	1	9.859 239
CC-415wl	5	150	1500	1.2 / 1.2 / 1.0 / 0.6 / 0.2 / 0.05	-40 ... +200	1	9.859 240

*with displacement insert

2
2 Double-walled wide-mouth bottles GLS 80®, DURAN®

The DURAN® double-walled wide-mouth bottles GLS 80® incorporate an integral jacket that isolates the contents from the external environment. Heated or cooled liquids can be circulated through the jacket to control the temperature within the screw topped DURAN® bottle.

DWK Life Sciences

Applications

- Simple, low cost, jacketed chemostat or bioreactor for cell culture.
- Vessel for temperature-controlled reactions such as enzyme digestions.
- Simple continuous flow stirred reactor system with the optional GLS 80® cap components.
- Thermostatic vessel to maintain fluids, or high viscosity liquids at a constant temperature, useful when working with endo- or exothermic reactions.
- Large cold trap or condenser when used with dry ice in the inner container.

Features

- Usable temperature range of - 40 to + 120 °C.
- Manufactured from DURAN® borosilicate 3.3 glass.
- All components are fully autoclavable.
- Available in two sizes: 500 and 1000 ml.
- Compatible with full range of wide mouth GLS 80® connection cap systems for liquid addition or removal during processing.

Capacity	Diam.	Height without closure	PK	Cat. No.
ml	mm	mm		
500	110	170	1	6.266 805
1000	110	270	1	6.266 806

1 Refrigeration Bath circulators to -55°C

Compact design and high cooling capacity at low temperatures.

Option: Natural refrigerant available on request

Heating capacity

CC-505/CC-505wl: 1.5 kW

CC-508 to CC-525w: 3.0 kW

Pump data CC-505 to CC-525w

Max. pressure: 25 L/min / 0.7 bar

Max. suction: 18.5 L/min / 0.4 bar

Supply requirement

CC-505 to CC-508w: 230 V / 50 Hz

CC-510 to CC-525w: 400 V / 50 Hz

Temp. stability acc. to DIN 12876: ±0.02 K

Huber



Type	Bath capacity	Bath tank depth	Cooling capacity KW at 100/20/0/-20/-40°C	Working Temp. range °C	PK	Cat. No.
	L	mm				
CC-505	5	150	1.2 / 1.2 / 1.0 / 0.6 / 0.15	-50 ... +200	1	9.859 241
CC-505wl	5	150	1.2 / 1.2 / 1.0 / 0.6 / 0.15	-50 ... +200	1	9.859 242
CC-508w	5	160	1.5 / 1.5 / 1.5 / 1.0 / 0.3	-55 ... +200	1	9.857 401
CC-510	26/15*	200	2.1 / 2.1 / 2.1 / 1.0 / 0.4	-50 ... +200	1	9.859 256
CC-510w	18/11*	200	2.4 / 2.4 / 2.4 / 1.0 / 0.4	-50 ... +200	1	9.859 245
CC-515	26/15*	200	3.3 / 3.3 / 3.3 / 1.6 / 0.6	-55 ... +200	1	9.859 247
CC-515w	18/11*	200	3.3 / 3.3 / 3.3 / 1.6 / 0.6	-55 ... +200	1	9.859 246
CC-520w	17/10*	200	5.0 / 5.0 / 5.0 / 3.0 / 1.5	-55 ... +200	1	9.859 248
CC-525w	17/10*	200	7.0 / 7.0 / 5.0 / 3.0 / 1.5	-55 ... +100	1	9.859 249

*with displacement insert

Function version available by E-grade.

2 Refrigerated circulator baths, CORIO™ CD

CORIO™ CD Heating Circulators for internal and external temperature applications with stainless steel baths for working temperatures from -40 °C to +150 °C.

CORIO™ Heating Circulators feature professional technology for demanding applications.

These units facilitate internal temperature control in the bath tank or control of externally connected applications.

- For internal and external applications
- Bright, white, easy to read display
- Very quiet
- Pump change-over between internal and external circulation
- External pump connections (M16x1)
- USB connection
- High-quality bath tanks made of stainless steel with bath lid and drain tap
- Integrated cooling coil for counter-cooling
- Removable ventilation grille
- Refrigeration machines without lateral ventilation openings
- Class III (FL) according to DIN 12876-1

JULABO



Specifications

Temperature stability: ±0.03 °C

Heating capacity: 2 kW

Flow rate: 15 l/min

Pressure: 0.35 bar

Type	Filling volume	Dimensions (W x D x H)	Bath opening	Bath tank depth	Working Temp. range °C	Cooling capacity kW at 20/0/-20°C	PK	Cat. No.
	L	mm	mm	mm				
CORIO™ CD-200F	3 - 4	230 x 390 x 650	130 x 150	150	-20 - 150	0.22 / 0.17 / 0.06	1	4.658 008
CORIO™ CD-201F	3 - 4	440 x 410 x 440	130 x 150	150	-20 - 150	0.22 / 0.17 / 0.06	1	4.658 009
CORIO™ CD-300F	3 - 4	240 x 420 x 660	130 x 150	150	-25 - 150	0.31 / 0.28 / 0.11	1	4.658 010
CORIO™ CD-600F	5 - 7,5	330 x 470 x 690	220 x 150	150	-35 - 150	0.6 / 0.46 / 0.18	1	4.658 011
CORIO™ CD-601F	8 - 10	360 x 460 x 740	220 x 150	200	-40 - 150	0.6 / 0.46 / 0.18	1	6.283 539
CORIO™ CD-900F	21 - 30	390 x 620 x 750	260 x 350	200	-40 - 150	0.9 / 0.8 / 0.35	1	6.283 540
CORIO™ CD-1000F	5 - 7,5	420 x 490 x 700	220 x 150	150	-40 - 150	1.0 / 0.98 / 0.53	1	6.283 541
CORIO™ CD-1001F	42 - 56	450 x 640 x 950	350 x 410	300	-38 - 100	1.0 / 0.9 / 0.35	1	6.283 542

1



1 Refrigerated circulators CORIO™ CP

NEW
 JULABO

With insulated stainless steel bath tanks, flexible performance and an operating temperature range of up to 200 °C. Temperature control is possible either in the internal bath or in a connected external application.

- Suitable for internal and external applications
- High-quality stainless steel bath vessels including bath lid and drain
- Refrigerating units without side ventilation openings
- More space in the bath due to space-saving evaporator coils
- External pump connections M16x1
- Bright, white, easily visible display, even from a distance
- Low-level warning system
- Simple switching between internal and external circulation
- Powerful, continuously variable pump
- Pump capacity adjustable from 8 to 27 l/min
- Very quiet
- Rubber feet for secure standing
- Removable air vent
- USB connection
- RS232 interface
- Class III (FL) according to DIN 12876-1

Scope of supply: refrigerated circulator, mains power cable, connection box, bath cover, connecting cable, refrigerator, hose connectors 8 and 12 mm

Specifications

Setting accuracy:	0.01 °C
Temperature uniformity:	±0.03 °C
Pump output:	8 ... 27 l/min
Pump pressure:	0.1 ... 0.7 bar
Heat output:	2 kW
Timer:	0 ... 999 min
Hose connector inner width:	8/12 mm
Permissible ambient temperature:	5 ... 40 °C
Power supply:	230 V/50 Hz

Type	Capacity of the bath litres	Bath opening mm	Bath tank depth mm	Temp. range °C	External dimensions (W x D x H) mm	Cooling capacity kW at 20/0/-20°C	PK	Cat. No.
CP-200F	4.0	130 x 150	150	-20 ... 200	230 x 390 x 650	0.22 / 0.17 / 0.02	1	4.670 680
CP-201F	4.0	130 x 150	150	-20 ... 200	440 x 410 x 440	0.22 / 0.17 / 0.02	1	4.670 681
CP-300F	4.0	130 x 150	150	-30 ... 200	240 x 420 x 660	0.31 / 0.28 / 0.08	1	4.670 683
CP-600F	7.5	220 x 150	150	-35 ... 200	330 x 470 x 690	0.6 / 0.44 / 0.16	1	4.670 684
CP-601F	10.0	220 x 150	200	-35 ... 200	360 x 460 x 740	0.6 / 0.44 / 0.16	1	4.670 685
CP-900F	30.0	260 x 350	200	-38 ... 200	390 x 620 x 750	0.9 / 0.8 / 0.31	1	4.670 686
CP-1000F	7.5	220 x 150	150	-50 ... 200	420 x 490 x 700	1.0 / 0.96 / 0.51	1	4.670 687
CP-1001F	56.0	350 x 410	300	-38 ... 100	450 x 640 x 950	1.0 / 0.85 / 0.32	1	4.670 688



1 Refrigerated/heated circulators MAGIO MS



1

For precise, reliable temperature control of demanding external applications, e.g. in basic research, in material testing and in technical installations.

- Simple control of complex applications
- Infinitely adjustable, extremely powerful pressure and suction pump
- Large, high-resolution TFT touch display with multilingual user interface
- Medium-contacting parts made of stainless steel
- Integrated programmer
- External Pt100 connection
- USB interface
- RS232 interface
- Ethernet interface
- Analogue interfaces (optionally)
- Classification III according to DIN 12876-1



Specifications:

Temperature stability:	±0.01 °C
Flow rate:	16 ... 31 l/min
Pump pressure:	0.24 ... 0.92 bar
Suction pressure:	0.03 ... 0.4 bar
Heating capacity:	2000 W
Permissible ambient temperature:	5 ... 40 °C
Power supply:	230 V/50 ... 60 Hz

Type	Filling volume	Dimensions (W x D x H)	Bath opening	Bath tank depth	Temp. range	Cooling capacity kW at 20/0/-20°C	PK	Cat. No.
	L	mm	mm	mm	°C			
MS-300F	3 ... 4	240 x 420 x 660	130 x 150	150	-25 ... 200	0.3/0.24/0.06	1	4.678 304
MS-600F	5 ... 7.5	330 x 470 x 690	220 x 150	150	-35 ... 200	0.6/0.44/0.16	1	4.678 305
MS-601F	8 ... 10	330 x 470 x 740	220 x 150	200	-35 ... 200	0.6/0.52/0.16	1	4.678 306
MS-900F	21 ... 30	390 x 620 x 750	260 x 350	200	-38 ... 200	0.9/0.8/0.31	1	4.678 307
MS-1000F	21 ... 30	420 x 490 x 700	180 x 130	150	-50 ... 200	1.0/0.96/0.51	1	4.678 308

2 Water bath preservative liquid Aqua Stabil



2

- Prevents build-up of algae and bacteria in bath tanks providing hygienic operation
- No contamination of the tank or immersion thermostat components
- Economical - only 2 ml of Aqua Stabil is required for every 1 litres of water
- Remains effective for weeks, as shown by colour indicator.

This product is a disinfectant containing biocides. Please inquire its availability and legal information.

H phrases: H412



Volume ml	PK	Cat. No.
100	1	9.858 040

We can supply this
manufacturer's
 whole
product range !



1
1 Refrigerated circulator baths DYNEO™ DD

Ideal for internal and external applications. With powerful components and a large, easy to read colored TFT display. Operation is simple and intuitive via the central controller on the front of the device. Equipped with USB interface, also available with optional analogue (extra code A) or RS232 (extra code D) interface.

JULABO

- Easy switching between internal and external circulation
- Built-in drain tap
- Integrated programmer for 8 x 60 program steps
- Class III (FL) acc. to DIN 12876-1
- Continuously adjustable, powerful pressure pump
- Pump connectors M16x1
- External Pt100 sensor connection

2 hose connectors for 8 and 12 mm I.W. and bath lid included.

Specifications

Temperature stability:	0.01 °C
Heating capacity:	2 kW
Flow rate:	8 ... 27 l/min
Pump capacity:	0.1 ... 0.7 bar
Power supply:	230 V, 50/60Hz



Type	Working Temp. range °C	Filling volume L	Bath opening mm	Bath tank depth mm	Cooling capacity kW at 20/0/-20°C	PK	Cat. No.
DD-200F	-20...200	3.0 - 4.0	130 x 150	150	0.22 / 0.17 / 0.02	1	4.663 225
DD-201F	-20...200	3.0 - 4.0	130 x 150	150	0.22 / 0.17 / 0.02	1	4.663 226
DD-300F	-30...200	3.0 - 4.0	130 x 150	150	0.31 / 0.28 / 0.08	1	4.663 227
DD-600F	-35...200	5.0 - 7.5	220 x 150	150	0.6 / 0.44 / 0.16	1	4.663 228
DD-601F	-35...200	5.0 - 7.5	220 x 150	20	0.6 / 0.44 / 0.16	1	4.663 229
DD-900F	-38...200	21.0 - 30.0	260 x 350	20	0.9 / 0.8 / 0.31	1	4.663 230
DD-1000F	-50...200	5.0 - 7.5	180 x 130	15	1.0 / 0.96 / 0.51	1	4.663 231
DD-1001F	-38...100	42.0 - 56.0	350 x 410	30	1.0 / 0.85 / 0.32	1	4.663 232
DD-200F.A	-20...200	3.0 - 4.0	130 x 150	150	0.22 / 0.17 / 0.02	1	4.663 238
DD-201F.A	-20...200	3.0 - 4.0	130 x 150	150	0.22 / 0.17 / 0.02	1	4.663 239
DD-300F.A	-30...200	3.0 - 4.0	130 x 150	150	0.31 / 0.28 / 0.08	1	4.663 240
DD-600F.A	-35...200	5.0 - 7.5	220 x 150	150	0.6 / 0.44 / 0.16	1	4.663 241
DD-601F.A	-35...200	5.0 - 7.5	220 x 150	20	0.6 / 0.44 / 0.16	1	4.663 242
DD-900F.A	-38...200	21.0 - 30.0	260 x 350	20	0.9 / 0.8 / 0.31	1	4.663 243
DD-1000F.A	-50...200	5.0 - 7.5	180 x 130	15	1.0 / 0.96 / 0.51	1	4.663 244
DD-1001F.A	-38...100	42.0 - 56.0	350 x 410	30	1.0 / 0.85 / 0.32	1	4.663 245
DD-200F.D	-20...200	3.0 - 4.0	130 x 150	150	0.22 / 0.17 / 0.02	1	4.663 251
DD-201F.D	-20...200	3.0 - 4.0	130 x 150	150	0.22 / 0.17 / 0.02	1	4.663 252
DD-300F.D	-30...200	3.0 - 4.0	130 x 150	150	0.31 / 0.28 / 0.08	1	4.663 253
DD-600F.D	-35...200	5.0 - 7.5	220 x 150	150	0.6 / 0.44 / 0.16	1	4.663 254
DD-601F.D	-35...200	5.0 - 7.5	220 x 150	20	0.6 / 0.44 / 0.16	1	4.663 255
DD-900F.D	-38...200	21.0 - 30.0	260 x 350	20	0.9 / 0.8 / 0.31	1	4.663 256
DD-1000F.D	-50...200	5.0 - 7.5	180 x 130	15	1.0 / 0.96 / 0.51	1	4.663 257
DD-1001F.D	-38...100	42.0 - 56.0	350 x 410	30	1.0 / 0.85 / 0.32	1	4.663 258

Pump set for Circulator baths CORIO CD™, CORIO CP™, DYNEO™ DD

JULABO

Type	For Type	PK	Cat. No.
Pump set with pump connectors M16x1	CD	1	4.658 027
Pump set with pump connectors M16x1	CP, DD	1	4.663 259

➔ Further JULABO Refrigerated circulator baths for lower temperature ranges available on request.

1 Chiller DuraChill®



Stable and reliable cooling for many common heat removal applications, including laser etching, AA furnaces, ICP, rotary evaporators, vacuum systems, reaction vessels, plasma etching, and condenser cooling. The chillers are available with turbine or positive displacement pump.

- A bright, full-color touchscreen display
- Cooling at ambient temperatures up to 30 °C
- DynamicFilter™ self-cleaning filter system
- Liquid level sensor
- UV light system to prevent growth inhibitors
- User-adjustable temperature, pressure, and flow rate alarms
- External temperature tracking and communications capability (optionally)
- Cool Command™
- WhisperCool® noise reduction system
- Self-diagnostics service and functionality system
- Front fill reservoir
- 4 Casters, 2 of them locking



Specifications:

Working temperature: -10 ... 70 °C
 Temperatur stability: ±0.1 °C
 Cooling capacity: 850 ... 2900 W
 Connectivity: RS232, status relay, dry contact
 Power supply: 240 V, 50 Hz

Type	Description	Pressure bar	Flow rate (50/60Hz) L / min.	Cooling capacity kW at 20 °C	PK	Cat. No.
CA 02	With positive displacement pump	1.4 ... 5.7	7.6	0.7	1	4.675 228
CA 02	With turbine pump	1.4 ... 5.2	8.3	0.7	1	4.675 229
CA 03	With positive displacement pump	1.4 ... 5.7	7.6	1.28	1	4.675 230
CA 03	With turbine pump	1.4 ... 5.2	8.3	1.28	1	4.675 231
CA 05	With positive displacement pump	1.4 ... 5.7	7.6	1.84	1	4.675 232
CA 05	With turbine pump	1.4 ... 5.2	8.3	1.84	1	4.675 233
CA 10	With positive displacement pump	1.4 ... 5.7	11.0	2.65	1	4.675 234
CA 10	With turbine pump	1.4 ... 5.2	11.0	2.65	1	7.984 151

2 Benchtop Chillers



These powerful, low-temperature chillers are well matched for use with rotary evaporators, vacuum systems, spectrometers, and other analytical equipment. They also are available with a mobile cart accessory for convenient placement under a bench.

- Large, easy to read LED display
- Space-saving design
- Cooling at ambient temperatures as high as 35 °C
- Temperature Stability ±0.1 °C
- Low flow shut-off and alarm, high and low temperature alarms
- Front mounted fluid level gauge
- Simple setup, operation, and maintenance
- Choice of pumps



LS

Type	With	Working Temp. range °C	Pressure bar	Flow rate (50/60 Hz) L / min.	Cooling capacity kW at 20/0/-10 °C	PK	Cat. No.
LS	Centrifugal Pump	-20 ... +40	0.4	12.9	1.16 / 0.69 / 0.435	1	4.658 658
LS	Centrifugal Pump	-20 ... +40	0.7	11.7	1.19 / 0.7 / 0.46	1	4.658 659
LS	Turbine Pump	-20 ... +40	2.2	8.3	0.8 / 0.5 / 0.3	1	4.658 660
LM	Centrifugal Pump	-10 ... +30	0.3	6.8	0.52 / 0.25 / 0.14	1	4.658 661
LM	Centrifugal Pump	-10 ... +30	0.9	11.4	0.39 / 0.17 / 0.11	1	4.658 662
MM	Centrifugal Pump	-5 ... +50	0.9	11.4	0.39 / 0.175 / -	1	4.658 663
MM	Centrifugal Pump	-5 ... +50	0.3	6.8	0.4 / 0.19 / -	1	6.280 728



1 Unichiller® in alternative bench-top or tower housing formats

Unichillers are intelligent chillers which are used mainly as an environmentally friendly and economic alternative to tap water for process cooling. Low temperatures increase efficiency and recovery rates in condensation processes. In contrast to tap water a set-point can be selected between -10/-20°C to 40°C and controlled with a temperature stability of ±0.5°C. The product range includes air cooled and water cooled models, with cooling powers from 0.3kW to 50kW. Most models can be factory fitted with a heater if required. Housings are made of stainless steel to ensure long life. Compact, value-for-money units are available in classic look with cooling powers up to 2.5kW for cooling applications in the lab. Models from Minichiller to Unichiller 025w are suitable for on or under the lab bench. The proven Huber tower housing models offer power with small footprints. These models are fitted with the exchangeable Pilot ONE controller and are used in both research and production. The range of cooling powers available is from 0.3kW to 50kW. Unichillers with an optional heating become powerful process circulators (additional charge on request). The desktop models are equipped with the Pilot ONE- and OLÉ-controller.

Huber



2 Chillers, Minichiller®

Small, robust and cost effective with its stainless steel casing. The Minichiller is the smallest Unichiller in the world. Minichillers are available with air or water-cooled refrigeration systems, illuminated level indicator, overflow and drain on the front. The filling port is on the top of the unit. All models use natural refrigerants as standard. Minichillers have suction and pressure pumps and therefore have the advantage of have a high flow at low pressure. This is particularly interesting for all pressure sensitive applications (e.g. glass condensors).

Huber

Supply req.: 230V 50/60Hz

Type	Cooling capacity kW at 15/0/-10°C	Working Temp. range °C	Dimensions (W x D x H) mm	PK	Cat. No.
Minichiller® 280 OLÉ	0.28/0.2/-	-5 ... 40	225 x 360 x 380	1	6.272 350
Minichiller® 300 OLÉ	0.3/0.2/0.14	-20 ... 40 (80)*	225 x 360 x 380	1	6.272 346
Minichiller® 300w OLÉ	0.3/0.2/0.14	-20 ... 40 (80)*	225 x 360 x 380	1	6.272 347
Minichiller® 600 OLÉ	0.6/0.5/0.35	-20 ... 40	280 x 490 x 424	1	6.272 348
Minichiller® 600w OLÉ	0.6/0.5/0.35	-20 ... 40	280 x 490 x 424	1	4.675 313
Minichiller® 900w OLÉ	0.9/0.7/0.4	-25 ... 40	280 x 490 x 424	1	4.664 642

* Permissible temperature in return line 80 °C

We can **supply** this
manufacturer's
whole
product range !



1 Unichiller® with Pilot ONE controller



1

High performance Unichiller with Pilot ONE controller for standard applications. The Unichiller offers cooling powers up to 2.5 kW. The chiller is ideal for standard cooling applications in the laboratory or in industry. The energy efficient function of the chiller reduces the water consumption for many applications, helping to protect the environment and reducing operating costs. The models are fitted with the Pilot ONE controller including 5.7" colour touch screen and 2 x USB, Ethernet and RS232 connections. P-models include circulating pumps with a high discharge pressure for applications with high pressure drops.

- Cooling power up to 2.5 kW
- Air- and watercooled models
- Compact, robust stainless steel housings
- Fitted with wheels for easy handling
- Optional heating up to +100 °C

Power supply: 230 V, 50/60 Hz



Type	Working Temp. range °C	Cooling capacity kW at 15/0/-10 °C	Flow rate		Pressure max. bar	PK	Cat. No.
			L / min.				
Unichiller® 007	-20 ... 40	0.7/0.55/0.4	29		1.0	1	4.675 316
Unichiller® 007w	-20 ... 40	0.7/0.55/0.4	29		1.0	1	4.675 317
Unichiller® P007	-20 ... 40	0.7/0.55/0.4	25		2.5	1	4.675 327
Unichiller® P007w	-20 ... 40	0.7/0.55/0.4	25		2.5	1	4.675 328
Unichiller® 010	-20 ... 40	1.0/0.8/0.5	29		1.0	1	4.675 318
Unichiller® 010w	-20 ... 40	1.0/0.8/0.5	29		1.0	1	4.675 319
Unichiller® P010	-20 ... 40	1.0/0.8/0.5	25		2.5	1	6.273 296
Unichiller® P010w	-20 ... 40	1.0/0.8/0.5	25		2.5	1	4.675 329
Unichiller® 012	-20 ... 40	1.2/1.0/0.7	29		1.0	1	4.675 320
Unichiller® 012w	-20 ... 40	1.2/1.0/0.7	29		1.0	1	4.675 321
Unichiller® P012	-20 ... 40	1.2/1.0/0.7	25		2.5	1	4.675 330
Unichiller® P012w	-20 ... 40	1.2/1.0/0.7	25		2.5	1	6.288 870
Unichiller® 015	-20 ... 40	1.5/1.0/0.7	29		1.0	1	4.675 322
Unichiller® 015w	-20 ... 40	1.5/1.0/0.7	29		1.0	1	4.675 323
Unichiller® P015	-20 ... 40	1.5/1.0/0.7	25		2.5	1	4.675 331
Unichiller® P015w	-20 ... 40	1.5/1.0/0.7	25		2.5	1	4.675 332
Unichiller® 022	-10 ... 40	2.2/1.6/1.0	29		1.0	1	4.675 324
Unichiller® 022w	-10 ... 40	2.2/1.6/1.0	29		1.0	1	4.675 325
Unichiller® P022	-10 ... 40	2.2/1.6/1.0	25		2.5	1	4.675 333
Unichiller® P022w	-10 ... 40	2.2/1.6/1.0	25		2.5	1	4.675 334
Unichiller® 025	-10 ... 40	2.5/2.0/1.2	29		1.0	1	7.971 768
Unichiller® 025w	-10 ... 40	2.5/2.0/1.2	29		1.0	1	4.675 326
Unichiller® P025	-10 ... 40	2.5/2.0/1.2	25		2.5	1	4.675 335
Unichiller® P025w	-10 ... 40	2.5/2.0/1.2	25		2.5	1	4.675 336

2 Hoses

Huber

2



Type	Temp.-working range °C	Length cm	Material	PK	Cat. No.
NW 12 M16 x 1	-50 ... 200	150	Metal	1	9.857 215
NW 12 M16 x 1	-50 ... 200	200	Metal	1	9.857 216
NW 12 M16 x 1	-50 ... 200	300	Metal	1	9.857 217
NW 12 M16 x 1	-100 ... 350	100	Metal	1	9.857 121
NW 12 M16 x 1	-100 ... 350	150	Metal	1	9.857 122
NW 12 M16 x 1	-100 ... 350	200	Metal	1	9.857 045
NW 12 M16 x 1	-100 ... 350	300	Metal	1	9.857 124
NW 12 M24 x 1,5	-60 ... 260	100	Plastic	1	7.900 874
NW 12 M24 x 1,5	-60 ... 260	150	Plastic	1	6.254 865
NW 12 M24 x 1,5	-100 ... 350	100	Metal	1	9.857 218
NW 12 M24 x 1,5	-100 ... 350	150	Metal	1	6.229 781
NW 12 M24 x 1,5	-100 ... 350	200	Metal	1	9.857 219
NW 12 M24 x 1,5	-100 ... 350	300	Metal	1	9.857 220
NW 12 M24 x 1,5	-120 ... 400	100	Metal	1	9.857 046
NW 12 M24 x 1,5	-120 ... 400	150	Metal	1	9.857 047
NW 12 M24 x 1,5	-120 ... 400	200	Metal	1	9.857 048
NW 12 M24 x 1,5	-120 ... 400	300	Metal	1	9.857 049
NW 20 M30 x 1,5	-60 ... 260	100	Plastic	1	6.261 514
NW 20 M30 x 1,5	-60 ... 260	150	Plastic	1	6.258 999
NW 20 M30 x 1,5	-60 ... 260	200	Plastic	1	7.671 774
NW 20 M30 x 1,5	-60 ... 260	300	Plastic	1	6.254 719
NW 20 M30 x 1,5	-100 ... 350	100	Metal	1	9.857 125
NW 20 M30 x 1,5	-100 ... 350	150	Metal	1	9.857 126
NW 20 M30 x 1,5	-100 ... 350	200	Metal	1	9.857 127
NW 20 M30 x 1,5	-100 ... 350	300	Metal	1	9.857 128
NW 25 M38 x 1,5	-60 ... 260	100	Plastic	1	4.675 343
NW 25 M38 x 1,5	-60 ... 260	150	Plastic	1	4.675 344
NW 25 M38 x 1,5	-60 ... 260	200	Plastic	1	6.269 871
NW 25 M38 x 1,5	-60 ... 260	300	Plastic	1	4.675 345
NW 25 M38 x 1,5	-100 ... 350	100	Metal	1	9.857 129
NW 25 M38 x 1,5	-100 ... 350	150	Metal	1	9.857 130
NW 25 M38 x 1,5	-100 ... 350	200	Metal	1	9.857 131
NW 25 M38 x 1,5	-100 ... 350	300	Metal	1	9.857 132

1

1 Unichiller® with OLÉ controller

High performance Unichiller with OLÉ controller for standard applications.

Huber

The Unichiller with the OLÉ controller offers cooling powers up to 2.5 kW.

The chiller is ideal for standard cooling applications in the laboratory or in industry. The energy efficient function of the chiller reduces the water consumption for many applications, helping to protect the environment and reducing operating costs. All models are fitted with the OLÉ controller with its modern OLED display as well as for RS232, USB interfaces and PT100 measurement sensor connection.

P-models include circulating pumps with a high discharge pressure for applications with high pressure drops.

- Cooling power up to 2.5 kW
- Air- and watercooled models
- Compact, robust stainless steel housings
- Fitted with wheels for easy handling
- Optional heating up to +100°C

Power supply: 230 V, 50/60 Hz

Type	Working Temp. range °C	Cooling capacity kW at 15/0/-10°C	Flow rate L / min.	Pressure		PK	Cat. No.
					max. bar		
Unichiller® 007 OLÉ	-20 ... 40	0.7/0.55/0.4	29		1,0	1	6.272 357
Unichiller® 007w OLÉ	-20 ... 40	0.7/0.55/0.4	29		1,0	1	4.675 314
Unichiller® P007 OLÉ	-20 ... 40	0.7/0.55/0.4	25		2,5	1	6.288 861
Unichiller® 010 OLÉ	-20 ... 40	1.0/0.8/0.5	29		1,0	1	6.272 358
Unichiller® 010w OLÉ	-20 ... 40	1.0/0.8/0.5	29		1,0	1	4.667 602
Unichiller® P010 OLÉ	-20 ... 40	1.0/0.8/0.5	25		2,5	1	6.288 863
Unichiller® 012 OLÉ	-20 ... 40	1.2/1.0/0.7	29		1,0	1	6.272 351
Unichiller® 012w OLÉ	-20 ... 40	1.2/1.0/0.7	29		1,0	1	4.675 315
Unichiller® P012 OLÉ	-20 ... 40	1.2/1.0/0.7	25		2,5	1	6.288 852
Unichiller® P012w OLÉ	-20 ... 40	1.2/1.0/0.7	25		2,5	1	6.288 864
Unichiller® 015 OLÉ	-20 ... 40	1.5/1.0/0.7	29		1,0	1	6.272 352
Unichiller® 015w OLÉ	-20 ... 40	1.5/1.0/0.7	29		1,0	1	6.272 359
Unichiller® P015 OLÉ	-20 ... 40	1.5/1.0/0.7	25		2,5	1	6.288 853
Unichiller® P015w OLÉ	-20 ... 40	1.5/1.0/0.7	25		2,5	1	6.288 865
Unichiller® 022 OLÉ	-10 ... 40	2.2/1.6/1.0	29		1,0	1	6.272 355
Unichiller® 022w OLÉ	-10 ... 40	2.2/1.6/1.0	29		1,0	1	6.272 353
Unichiller® P022 OLÉ	-10 ... 40	2.2/1.6/1.0	25		2,5	1	6.288 857
Unichiller® P022w OLÉ	-10 ... 40	2.2/1.6/1.0	25		2,5	1	6.288 854
Unichiller® 025 OLÉ	-10 ... 40	2.5/2.0/1.2	29		1,0	1	6.272 356
Unichiller® 025w OLÉ	-10 ... 40	2.5/2.0/1.2	29		1,0	1	6.272 354
Unichiller® P025 OLÉ	-10 ... 40	2.5/2.0/1.2	25		2,5	1	6.288 859
Unichiller® P025w OLÉ	-10 ... 40	2.5/2.0/1.2	25		2,5	1	6.288 856

2

2 Compact Recirculating Cooler, F-Series

JULABO

- Environmentally friendly operation with low energy consumption
- No side vents, instruments can be placed right next to other equipment
- All wetted parts made of stainless steel or high grade plastic
- Large, bright LED display
- Compact design and small foot print
- Splash-proof keypad
- Drain tap
- Easy filling

Type	Flow rate L / min.	Cooling capacity kW at 20/0/-10°C	Working Temp. range °C	Temp. stability ± °C	Pressure bar	PK	Cat. No.
F250	15	0.25/0.18/0.09	-10 to +40	0.5	0.35	1	9.698 525
F500	24	0.5/0.25	0 to +40	0.5	0.5	1	9.698 528
F1000	23	1.0/0.35	0 to +40	0.5	1.0	1	9.698 526

1 Flow coolers, FL series

JULABO

- Working temperature range covers -20 °C to +40 °C, the temperature stability of the PID control is ±0.5 °C
- splash-proof keypad with integral mains switch
- large, bright LED display
- reliable Microprocessor PID temperature control
- filling level indicator
- powerful immersion pumps, suitable for continuous operation
- permissible temperature within return line: +80 °C max.
- easy filling from the top with hinged protective lid
- low liquid level protection with visual and audible alarm signal
- stainless steel bath tanks
- removable venting grille for cleaning of the condenser
- front drain
- no side vents
- RS232 interface for PC connection
- Ingress protection class acc. to IEC 529: IP 21
- pressure indicator
- adjustable bypass for pump pressure

1



Type	Flow rate	Cooling capacity kW at	Working Temp. range °C	Temp. stability ± °C	Pressure bar	PK	Cat. No.
	L / min.	20/0/-10°C					
FL300	15	0.3/0.2/0.15	-20 to 40	0.5	0.35	1	9.698 530
FL601	23	0.6/0.4/0.33	-20 to 40	0.5	1.0	1	9.698 531
FL1201	23	1.2/0.9/0.6	-20 to 40	0.5	1.0	1	9.698 532
FL1203	40	1.2/0.8/0.5	-20 to 40	0.5	0.5-3.0	1	9.698 533
FL1701	23	1.7/1.1/0.85	-20 to 40	0.5	1.0	1	9.698 534
FL1703	40	1.7/1.0/0.75	-20 to 40	0.5	0.5-3.0	1	9.698 535
FL2503	40	2.5/1.5/1.2	-20 to 40	0.5	0.5-3.0	1	9.698 536
FL2506	60	2.5/1.0/0.3	-15 to 40	0.5	0.5-6.0	1	9.698 537
FL4003	40	4.0/2.4/1.5	-20 to 40	0.5	0.5-3.0	1	9.698 538
FL4006	60	4.0/1.9/0.9	-20 to 40	0.5	0.5-6.0	1	9.698 539
FL7006	60	7.0/5.1/3.0	-20 to 40	0.5	0.5-6.0	1	9.698 540
FL11006	60	11.0/7.5/5.0	-20 to 40	0.5	0.5-6.0	1	9.698 541
FL20006	80	20.0/10/6	-20 to 40	0.5	0.8-6.0	1	9.698 550

2 Recirculating chillers ULK

NEW

2

For cooling applications and processes in laboratory and industry. Thanks to the space-saving design and the particularly quiet cooling unit, the Chiller is ideally suited for installation directly at the workplace.

Fryka-Kältetechnik

- Higher energy efficiency through fan with EC technology
- Pleasantly quiet and space saving
- Refrigeration unit: fully hermetically sealed, air-cooled, low maintenance
- Integrated funnel
- Self-sealing hose connector with quick coupling
- Touchscreen controller with high-grade glass screen and integrated flow and digital fill level indicators
- Freeze-up and thermal overload protection
- Flow control with dry running protection
- Optical and acoustical alarm
- MOD bus interface optionally available



Type	Working Temp. range °C	Pressure bar	Flow rate L / min.	Cooling capacity kW at 20 °C	PK	Cat. No.
ULK 602	-10 ... 40	0.6	10	650	1	6.284 440
ULK 1002	-10 ... 40	2.9	12	1200	1	6.284 441
ULK 2002	-10 ... 40	2.9	12	2300	1	6.284 442

1

9.857 916

Highly Dynamic Temperature Control Systems Presto™

The models of JULABO's new Presto generation set new standards for highly dynamic temperature control systems. They represent the optimal solution for highly precise external temperature control applications. Temperature control of jacketed reactor vessels, reactor systems, autoclaves, distillations, pilot plants, semiconductor industries.

JULABO

The advantages of PRESTO models:

- Extremely short heat-up and cool-down times
- Powerful circulating pump with adjustable pump pressure
- Wide working temperature ranges without change of thermal fluid
- Large TFT touch screen for interactive operation
- Digital and analog interfaces
- Handles and castors allow for easy set-up
- Low filling volume
- Small dimensions

2

9.857 917

Specifications

Temperature stability:	±0.01 ... 0.05 °C
Pump capacity	
Flow rate:	
A30	25 l/min
A40/W40/A80/W80	16 ... 40 l/min
A45/A45t/W50/W50t	35 ... 76 l/min
A85/A85t	35 ... 80 l/min
Pressure:	
A30	0.5 bar
A40/W40/A80/W80	0.3 ... 1.7 bar
A45/A45t/W50/W50t/A85/A85t	0.48 ... 3.2 bar

Type	Dimensions (W x D x H)	Heating capacity	Cooling capacity kW at 20 °C	Working Temp. range °C	Cooling capacity kW at 20/0/-20°C	PK	Cat. No.
	mm	kW					
A 30	242 x 583 x 612	2.7	0.5	-30 ... 250	0.5 / 0.4 / 0.17	1	9.857 915
A 40	323 x 583 x 662	2.7	1.2	-40 ... 250	1.2 / 0.9 / 0.6	1	9.857 916
W 40	323 x 583 x 662	2.7	1.2	-40 ... 250	1.2 / 1.0 / 0.55	1	9.857 917
A 45	530 x 665 x 1260	6.0	3.5	-45 ... 250	3.5 / 3.3 / 1.8	1	4.672 122
A 45t	530 x 665 x 1260	6.0	3.5	-45 ... 250	3.5 / 3.3 / 1.8	1	4.672 123
W 50	530 x 665 x 1260	6.0	7.5	-50 ... 250	7.5 / 6.5 / 3.0	1	4.658 069
W 50t	530 x 665 x 1260	6.0	7.5	-50 ... 250	7.5 / 6.5 / 3.0	1	4.658 070
A 80	430 x 650 x 1258	1.8	1.2	-80 ... 250	1.2 / 1.2 / 1.1	1	9.857 918
W 80	430 x 650 x 1258	1.8	1.2	-80 ... 250	1.2 / 1.2 / 1.1	1	9.857 919
A 80t	430 x 650 x 1260	3.4	1.2	-80 ... 250	1.2 / 1.2 / 1.1	1	9.857 920
W 80t	430 x 650 x 1260	3.4	1.2	-80 ... 250	1.2 / 1.2 / 1.1	1	9.857 921

3

3 Reaction vessels, cylindrical, with thermostatic jacket and withdrawal valve

NEW

- With graduation
- Laboratory flange LF
- With groove
- Two connectors with threads GL 14 or GL 18
- Made of DURAN® tubing

Lenz

Other sizes on request.

Nominal capacity	Flange (LF)	Outer/inner diam.	Height	Int. height	Connection	Bore	PK	Cat. No.
ml		mm	mm	mm		mm		
100	60	90/60	245	115	GL 14	10	1	9.142 766
250	60	90/60	300	170	GL 14	10	1	9.142 767
500	60	90/60	385	255	GL 14	10	1	9.142 768
1000	60	90/60	360	220	GL 14	10	1	6.233 770
250	100	130/99	275	140	GL 18	10	1	6.230 277
500	100	130/99	295	155	GL 18	10	1	9.142 781
1000	100	130/99	360	220	GL 18	10	1	9.142 782
2000	100	130/99	490	350	GL 18	10	1	9.142 784
3000	100	190/150	440	285	GL 18	10	1	6.243 114
4000	100	190/150	495	340	GL 18	10	1	9.142 787
2000	150	190/150	375	225	GL 18	10	1	6.233 793
3000	150	190/150	430	280	GL 18	10	1	6.243 115
4000	150	190/150	485	335	GL 18	10	1	7.635 340
5000	150	190/150	540	390	GL 18	10	1	6.224 194
6000	150	190/150	595	445	GL 18	10	1	6.243 116
10000	150	315/240	640	480	GL 18	20	1	6.240 516

7. Heating and cooling technology

Temperature regulators/Temperature Control Accessories

1 2 Function upgrade for Huber circulators

E-grade - innovative activation keys for the functionality to suit your budget and process requirements

Huber

Every application requires particular functions. If the circulator is to be used in a range of applications it will generally require greater functionality. The required functionality grows with the complexity of the application. The innovative "E-grade" has the answer. Models with the Pilot ONE Controller have a comprehensive range of functions suited to the classical temperature control applications. The E-grade allows the functionality to be extended at any time to suit new process requirements and budget. E-grade stands for electronic upgrade and it is simple to do: To extend the functionality a unit specific code is entered via the controller. This code is specific to the serial number of the unit and is either already entered at the factory for new units or it can be activated at a later date. The code is sent by email. There is no requirement for a hardware or software update.

The E-grade "Explore" for Unistats is more than just another functions package. It makes important information available to users of Unistat temperature control systems. Temperature values and temperature differentials as well as for the actual heating power, cooling power and pump power within the system are displayed on the touch-panel. E-grade "Explore" is an evolution of the existing Unistat technology. Existing sensors are utilised to make important process temperature and power data visible. In addition to making the data visible on the display of the device, it can also be accessed via the digital interfaces for further processing.

- Application examples for E-grade® "Explore":
- Process and product development and optimisation
 - Use-Tests of raw materials, quality control
 - Enhanced data collection for scale-up trials

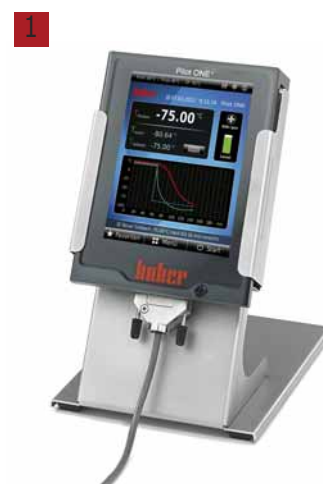

Type	PK	Cat. No.
E-grade® "Exclusive"	1	9.699 100
E-grade® "Professional"	1	9.699 101



1

1 Thermal fluids

Huber thermal fluids are recommended because they have the best possible thermodynamic and environmental characteristics. Safe reliable operation relies on compliance with safety standards to ensure optimal results.

Huber

Danger

H phrases: H304

Type	Description	Capacity l	Temp. range °C	PK	Cat. No.
P20.190.40	Thermal fluid MinOil	5	+20 ... +190	1	6.201 643
P20.190.40	Thermal fluid MinOil	20	+20 ... +190	1	6.239 618
P20.275.50	Thermal fluid SilOil	5	+20 ... +275	1	6.201 670
P20.275.50	Thermal fluid SilOil	10	+20 ... +275	1	6.203 535
M20.195/235.20	Thermal fluid SilOil	5	-20 ... +195/235	1	6.306 078
M20.195/235.20	Thermal fluid SilOil	10	-20 ... +195/235	1	6.250 420
M40.165.10/220.10	Thermal fluid SilOil	5	-40 ... +165/220	1	6.250 278
M40.165.10/220.10	Thermal fluid SilOil	10	-40 ... +165/220	1	6.304 378
M60.115/200.05	Thermal fluid SilOil	5	-60 ... +115/200	1	6.201 255
M60.115/200.05	Thermal fluid SilOil	10	-60 ... +115/200	1	6.225 263
M90.055/170.03	Thermal fluid SilOil	5	-90 ... +55/170	1	7.615 661
M90.055/170.03	Thermal fluid SilOil	10	-90 ... +55/170	1	6.202 172

Further thermal fluids available on request

2

2 Tempering Liquids

Long-term tested for safe and reliable operation. Suitable for temperature control in refrigerated circulators.

JULABO

- Low toxicity
- Low viscosity
- High stability
- Almost odor-free
- Good thermal conductivity
- Low corrosion susceptibility
- Wide temperature ranges



H phrases: H302|H373

Type	Temp. range °C	Capacity Litres	Description	PK	Cat. No.
Thermal M	+70...+170	10	Heating Thermostats	1	6.100 525
Thermal M	+70...+170	5	Heating Thermostats	1	6.051 961
Thermal HS	+50...+250	10	Heating Thermostats	1	6.100 527
Thermal HS	+50...+250	5	Heating Thermostats	1	6.100 528
Thermal HY	-80...+55	10	Heating-, Cooling Thermostats	1	6.100 529
Thermal HY	-80...+55	5	Heating-, Cooling Thermostats	1	6.100 530
Thermal H20S	0...+220	10	Heating-, Cooling Thermostats	1	6.100 533
Thermal H20S	0...+220	5	Heating-, Cooling Thermostats	1	6.100 534
Thermal H5	-50...+105	10	Flow Coolers, Cooling Thermostats	1	6.100 531
Thermal H5	-50...+105	5	Flow Coolers, Cooling Thermostats	1	6.100 532
Thermal G	-30...+80	10	Flow Coolers, Cooling Thermostats	1	6.206 171
Thermal G	-30...+80	5	Flow Coolers, Cooling Thermostats	1	6.229 933
Thermal H10	(-40)-20...+180	10	Flow Coolers, Cooling Thermostats	1	6.222 284
Thermal H10	(-40)-20...+180	5	Flow Coolers, Cooling Thermostats	1	6.207 217
Thermal H250S	+20...+250	5	High Temperature Thermostats (Forte HT)	1	6.264 316
Thermal HL30	-30...+90	5	Dynamic Temperature Control Systems	1	6.287 812
Thermal HL60	-60...+250	10	Dynamic Temperature Control Systems	1	6.281 890
Thermal HL60	-60...+250	5	Dynamic Temperature Control Systems	1	7.647 214
Thermal HL 90	-90 ... +200	5	Dynamic Temperature Control Systems	1	4.672 125
Thermal HL 90	-90 ... +200	10	Dynamic Temperature Control Systems	1	4.672 124

1 Water baths Precision incl. Thermal Beads

The general purpose water baths, Precision, are rugged, high performance baths for temperatures up to 100°C (TSGP02 up to 90 °C). Over-temperature safety circuit is designed to prevent thermal runaway. Benefit from outstanding chemical and corrosion resistance with epoxy powder-coated exterior, and easily clean the chamber with its seamless stainless-steel interior. With timer.

Thermo Scientific

- Advanced microprocessor controller is designed for extended functionality
- Protect your work with audible alarms
- Conveniently save commonly used settings with four temperature presets
- Clear polycarbonate gable cover

Scope of supply: Bath incl. gable cover, diffuser tray, TSGP02 and TSGP05 with hand pump, all other models with drain hose.



Type	Capacity of the bath litres	Internal dimensions (W x D x H) mm	External dimensions (W x D x H) mm	Rated capacity kW	With	PK	Cat. No.
TSGP02PM05	2	138 x 155 x 150	230 x 199 x 233	0.2	4 l Thermal Beads	1	6.290 947
TSGP05PM05	5	154 x 300 x 150	246 x 355 x 232	0.3	4 l Thermal Beads	1	6.273 859
TSGP10PM05	10	301 x 330 x 150	393 x 383 x 233	0.8	8 l Thermal Beads	1	6.273 860
TSGP20PM05	20	297 x 500 x 150	392 x 555 x 233	1.2	16 l Thermal Beads	1	6.273 861
TSGP28PM05	28	297 x 500 x 200	392 x 555 x 282	1.2	24 l Thermal Beads	1	6.273 862
TSGP15PM05	5 + 10	154 x 300 x 150 + 301 x 330 x 150	246 x 355 x 232 + 393 x 383 x 233	1.1	12 l Thermal Beads	1	6.273 863

2 Thermal beads for Water baths Precision

Thermal beads replace water in laboratory baths or ice in ice buckets to prevent contamination. A bath filled with Thermal Beads can be left unattended and is always available at the set temperature without danger of water evaporating to dryness.

Thermo Scientific

- Small, non-uniform metal beads composed of a dry metallic thermal alloy
- Cleaning with biodegradable disinfectant every 2 - 4 weeks only
- Good temperature stability and uniformity
- Energy-efficient
- Minimizes maintenance such as emptying, cleaning, monitoring, and refilling the bath
- Holds common lab vessels in place without accessories such as racks, floats, and weights



Description	PK	Cat. No.
Thermal beads, 4 l	1	6.290 968



Heating/Water baths

1

1 Digital water baths

The unstirred, general purpose water baths are available in 5 sizes: 2, 5, 10, 20 and 28 liters.

PolyScience

- Color TFT display with control panel
- Calibration offset feature
- Low liquid alarm
- Over temperature alarm
- 5 user programmable pre-sets (temperature and duration)
- 5 languages (English, German, French, Spanish and Chinese)
- Integrated independent timer
- Eco-mode
- Safety thermostat
- High-gabled, clear lids accommodate taller media bottles
- Rear-mounted drain (10, 20 and 28 liters)
- Recessed Handles

Scope of supply: Digital water bath, incl. lid

Specifications:

Temperature range:	Ambient +5 °C ... 100 °C
Temperature uniformity:	±0.2 °C
Temperature stability:	±0.1 °C
Power supply:	240 V, 50 Hz

Type	Capacity of the bath litres	Internal dimensions (W x D x H) mm	External dimensions (W x D x H) mm	Rated capacity kW	PK	Cat. No.
WBE02A12E	2	109 x 99 x 152	305 x 229 x 267	0.12	1	6.274 985
WBE05A12E	5	274 x 127 x 152	305 x 368 x 267	0.36	1	6.274 986
WBE10A12E	10	295 x 269 x 152	432 x 393 x 305	1.00	1	6.274 987
WBE20A12E	20	432 x 241 x 152	445 x 572 x 305	1.40	1	6.274 988
WBE28A12E	28	432 x 241 x 203	445 x 572 x 356	1.40	1	6.274 989

2

2 Basic digital water baths JB Academy

An ideal choice for schools and colleges requiring a basic simple-to-use quality water bath. Base tray included as standard. A great value range consisting of three models.

Grant

- Ambient + 5 °C to 95 °C
- Unique Set and Forget™ technology, fast heat-up, reliable temperature control
- Stability ±0.5 °C
- Simple, intuitive controls, quick and easy to set temperature
- Practical front panel lock, disables front panel controls preventing unintentional temperature changes
- 3 year warranty

Accessory polypropylene spheres or a lid must be used at temperatures between +60 °C and +99 °C.

Please order lid and PP spheres separately.

Type	Capacity of the bath litres	Internal dimensions (W x D x H) mm	External dimensions (W x D x H) mm	Rated capacity kW	PK	Cat. No.
JBA5	5	281 x 131 x 132	335 x 215 x 200	0.35	1	9.905 875
JBA12	12	306 x 281 x 132	360 x 365 x 225	0.80	1	9.905 876
JBA18	18	281 x 485 x 132	335 x 570 x 275	1.40	1	9.905 877

3

3 Water bath preservative liquid Aqua Stabil

- Prevents build-up of algae and bacteria in bath tanks providing hygienic operation
- No contamination of the tank or immersion thermostat components
- Economical - only 2 ml of Aqua Stabil is required for every 1 litres of water
- Remains effective for weeks, as shown by colour indicator.

JULABO

This product is a disinfectant containing biocides. Please inquire its availability and legal information.

H phrases: H412

Volume ml	PK	Cat. No.
100	1	9.858 040

1 Digital water baths JB Nova

General purpose water baths with stable temperature control, simple controls and fast heat up. A choice of four models with a base tray and lid included as standard.

Grant

- Ambient +5 °C to 95 °C
- Unique Set and Forget™ technology, fast reliable temperature control
- Stability ±0.5 °C
- Simple, intuitive controls, quick and easy to set temperature
- Drain tap on 12 L, 18 L and 26 L baths
- Practical front panel lock - disables front panel controls preventing unintentional temperature changes
- 3-year warranty



Accessory polypropylene spheres or a lid must be used at temperatures between +60 °C and +99 °C.

Please order PP spheres separately.

Type	Capacity of the bath litres	Internal dimensions (W x D x H) mm	External dimensions (W x D x H) mm	Rated capacity kW	PK	Cat. No.
JBN5	5	281 x 131 x 132	335 x 215 x 200	0.35	1	9.905 870
JBN12	12	308 x 281 x 132	360 x 380 x 225	0.80	1	9.905 871
JBN18	18	281 x 485 x 132	335 x 590 x 275	1.40	1	9.905 872
JBN26	26	278 x 481 x 182	335 x 590 x 275	1.40	1	9.905 873

2 Unstirred water baths SUB Aqua Pro series, digital

High quality and excellent temperature stability, in a value-for-money package designed to meet the needs of the world's researchers. The SUB Aqua Pro range is composed of eight models, including shallow and dual baths.

Grant

- Three programmable temperature presets
 - Drain tap on SUB Aqua Pro 12, 18, 26 and 34
 - Front panel lock-out
 - Countdown timer with audible buzzer
 - Ambient +5 °C to 99 °C operation
 - Stability ±0.2 °C
 - Digital PID control for quick heat-up and precision control throughout the temperature range
 - User-settable sample protection and fixed thermal cut-out
 - High grade stainless steel tanks
 - Non drip polycarbonate lid and base tray included as standard
- Available as 120V or 230V.



Accessory polypropylene spheres or a lid must be used at temperatures between +60 °C and +99 °C.

Please order PP spheres separately.

Type	Capacity of the bath litres	Internal dimensions (W x D x H) mm	External dimensions (W x D x H) mm	Rated capacity kW	PK	Cat. No.
SUB Aqua Pro 2	2	131 x 117 x 132	185 x 200 x 200	0.25	1	9.905 860
SUB Aqua Pro 2s	2	289 x 139 x 47	335 x 215 x 150	0.35	1	9.905 861
SUB Aqua Pro 5	5	281 x 131 x 132	335 x 215 x 200	0.35	1	9.905 862
SUB Aqua Pro 12	12	306 x 281 x 132	360 x 380 x 225	0.80	1	9.905 863
SUB Aqua Pro 18	18	281 x 485 x 132	335 x 590 x 275	1.05	1	9.905 864
SUB Aqua Pro 26	26	278 x 481 x 182	335 x 590 x 275	1.05	1	9.905 865
SUB Aqua Pro 34	34	281 x 635 x 180	335 x 770 x 275	1.30	1	9.905 866
SUB Aqua Pro Dual	5 + 12	281 x 131 x 132 & 306 x 281 x 132	545 x 380 x 225	1.15	1	9.905 867

3 LLG- Floating pellets, PP

Pellets with 20 mm diameter. Can cover 0.1 m². Protect against evaporation and rapid temperature loss. Decreases hazardous vapors. Resistant against most acids, bases, solvents and mineral oils. Temperature stable up to +100 °C.

Description	PK	Cat. No.
Floating pellets	250	6.266 611



Heating/Water baths

Water baths PURA™

Flexible in use for all purposes in research and quality control. All PURA™ water baths (except PURA™ 4) have an integrated drain screw. The bright, easy-to-read white LED display is clearly visible, even from a distance. With integrated side recessed grips for easy transport and non-slip rubber feet for safe standing. The complete interior surface of the water baths can be used, as there are no installation elements in the interior.

JULABO

- Including platform
- Integrated timer
- Working temperature range from 18 to 99.9 °C (with counter-cooling/bath cover)
- Models with filling volumes from 0.8 to 36 liters available
- High temperature accuracy of 0.15 °C
- Bright display with membrane keypad
- Splash-proof
- Built-in dry-running protection

Please order bath cover separately

1

1 Water bath PURA™ 4

For 1 test tube rack.

JULABO

Specifications

Bath volume:	0.8 ... 4.5 l
Bath opening (W x D x H):	120 x 270 x 140 mm
Heating capacity:	0.5 kW
Weight:	4.9 kg
Overall dimensions (W x D x H):	210 x 350 x 220 mm
Power supply:	230 V, 50-60 Hz

Type	PK	Cat. No.
PURA™ 4	1	4.667 880

2

2 Water bath PURA™ 10

For 2 test tube racks.

JULABO

Specifications

Bath volume:	1.4 ... 9.5 l
Bath opening (W x D x H):	220 x 270 x 140 mm
Heating capacity:	1.2 kW
Weight:	7 kg
Overall dimensions (W x D x H):	310 x 350 x 220 mm
Power supply:	230 V, 50-60 Hz

Type	PK	Cat. No.
PURA™ 10	1	4.667 881

3

3 Water bath PURA™ 14

For 3 test tube racks.

JULABO

Specifications

Bath volume:	2 ... 14 l
Bath opening (W x D x H):	330 x 270 x 140 mm
Heating capacity:	1.8 kW
Weight:	8.5 kg
Overall dimensions (W x D x H):	420 x 350 x 220 mm
Power supply:	230 V, 50-60 Hz

Type	PK	Cat. No.
PURA™ 14	1	4.667 882

4

4 Water bath PURA™ 22

For 5 test tube racks.

JULABO

Specifications

Bath volume:	3.4 ... 25.5 l
Bath opening (W x D x H):	550 x 270 x 180 mm
Heating capacity:	2.0 kW
Weight:	11.5 kg
Overall dimensions (W x D x H):	640 x 350 x 260 mm
Power supply:	230 V, 50-60 Hz

Type	PK	Cat. No.
PURA™ 22	1	4.667 883

1 Water bath PURA™ 30

For 7 test tube racks.

JULABO

Specifications

Bath volume:	4.8 ... 36.0 l
Bath opening (W x D x H):	770 x 270 x 180 mm
Heating capacity:	2.0 kW
Weight:	14.5 kg
Overall dimensions (W x D x H):	860 x 350 x 260 mm
Power supply:	230 V, 50-60 Hz

Type	PK	Cat. No.
PURA™ 30	1	4.667 884



Lids for Water baths, PURA™

JULABO

For model	Description	PK	Cat. No.
PURA™ 4	Hinged bath cover	1	9.857 931
PURA™ 10	Hinged bath cover	1	9.857 932
PURA™ 14	Hinged bath cover	1	9.857 933
PURA™ 22	Hinged bath cover	1	9.857 934
PURA™ 30	Hinged bath cover	1	9.857 935
PURA™ 10	Flat bath cover, with 4 openings Ø 92 mm	1	9.857 922
PURA™ 10	Flat bath cover, with 1 openings Ø 190 mm	1	9.857 923
PURA™ 14	Flat bath cover, with 6 openings Ø 92 mm	1	9.857 924
PURA™ 22	Flat bath cover, with 8 openings Ø 92 mm	1	9.857 925
PURA™ 22	Flat bath cover, with 6 openings Ø 115 mm	1	9.857 926
PURA™ 22	Flat bath cover, with 2 openings Ø 190 mm	1	9.857 927
PURA™ 30	Flat bath cover, with 10 openings Ø 115 mm	1	9.857 928
PURA™ 30	Flat bath cover, with 3 openings Ø 190 mm	1	9.857 929



9.857 932

3 Test tube trays for PURA™

JULABO

For Type	Description	PK	Cat. No.
PURA™	Test tube rack for 60 tubes 100 x 16/17 mm diam.	1	4.658 041
PURA™	Test tube rack for 90 tubes 75 x 12/13 mm diam.	1	4.658 042
PURA™	Test tube rack for 21 tubes 30 mm diam.	1	4.658 043



4 Water baths Hydro

NEW

LAUDA

The Hydro water baths are optimally equipped for every application in the laboratory. With their precise temperature distribution, they are designed for the needs of biological, medical or biochemical laboratories. The H 8 A and H 16 A models are also equipped with a circulation system for optional mixing.

- Interior made of high quality stainless steel
- Applications in the boiling range possible (temperature range: 25 to 100 °C)
- TFT color display for intuitive operation, temperature display in °C and °F
- Programmable timer
- Optical and acoustic alarm in the event of an error

Type	Capacity of the bath	Internal dimensions (W x D x H)	External dimensions (W x D x H)	Rated capacity	PK	Cat. No.
	litres	mm	mm	kW		
H 4	4	245 x 100 x 165	340 x 290 x 275	0.5	1	4.672 291
H 8	8	245 x 200 x 165	340 x 395 x 275	1.0	1	4.672 292
H 8 A	8	245 x 200 x 165	340 x 395 x 275	1.0	1	4.672 297
H 16	16	400 x 245 x 165	500 x 440 x 275	1.5	1	4.672 293
H 16 A	16	400 x 245 x 165	500 x 440 x 275	1.5	1	4.672 298
H 22	22	400 x 245 x 225	500 x 440 x 345	1.5	1	4.672 294
H 24	24	600 x 245 x 165	700 x 440 x 275	1.5	1	4.672 295
H 41	41	410 x 296 x 335	510 x 490 x 476	1.5	1	4.672 296



Water baths WNB/WNE

The Memmert waterbath is available in six model sizes and two performance classes. In addition to the Basic class for standard temperature control tasks, the Excellent version provides precise test procedures with a maximum of safety. The 3-sided heating ensures excellent temperature homogeneity.

WNB = water bath, natural circulation, temperature controller BASIC with 2-fold overtemperature protection

WNE = water bath, natural circulation, temperature controller EXCELLENT with 3-fold overtemperature protection, filling level control and calibration option

Specifications

Working-temperature range:

at least 5 °C above ambient to +95 °C and additional boiling stage

Setting temperature-range:

+10 °C to +95 °C and boiling stage

Temperature variation:

±0.1 K

Temperature distribution:

±0.25 K (sizes 7 - 29), ±0.3 K (size 45)

Power supply:

230 V, 50/60 Hz; 115 V, 50/60 Hz no extra charge

1 Water baths WNB

Water bath with natural circulation and temperature controller BASIC with 2-fold overtemperature protection

Memmert

Without covers - please order separately!

Type	Capacity of the bath litres	Internal dimensions (W x D x H) mm	External dimensions (W x D x H) mm	Rated capacity kW	Net weight kg	PK	Cat. No.
WNB7	7	240 x 210 x 140	468 x 356 x 238 *	1.2	11	1	9.906 581
WNB10	10	350 x 210 x 140	578 x 356 x 238 *	1.2	13	1	9.906 582
WNB14	14	350 x 290 x 140	578 x 436 x 238 *	1.8	15	1	9.906 583
WNB22	22	350 x 290 x 220	578 x 436 x 296 *	2.0	17	1	9.906 584
WNB29	29	590 x 350 x 140	818 x 516 x 238 *	2.4	24	1	9.906 585
WNB45	45	590 x 350 x 220	818 x 516 x 296 *	2.8	26	1	9.906 586

* Weight and height with flat cover.

1



Water baths WNB with gabled cover

Memmert

Type	Capacity of the bath litres	Internal dimensions (W x D x H) mm	External dimensions (W x D x H) mm	Rated capacity kW	Net weight kg	PK	Cat. No.
WNB7	7	240 x 210 x 140	468 x 356 x 337	1.2	11	1	6.290 896
WNB10	10	350 x 210 x 140	578 x 356 x 337	1.2	13	1	6.290 897
WNB14	14	350 x 290 x 140	578 x 436 x 347	1.8	15	1	6.290 898
WNB22	22	350 x 290 x 220	578 x 436 x 405	2.0	17	1	6.290 899
WNB29	29	590 x 350 x 140	818 x 516 x 343	2.4	24	1	6.290 900
WNB45	45	590 x 350 x 220	818 x 516 x 401	2.8	26	1	6.290 901

1 Water baths WNE

Water bath with natural circulation and temperature controller EXCELLENT with 3-fold overtemperature protection, filling level control and calibration option.

Memmert

Without covers - please order separately!

Type	Capacity of the bath litres	Internal dimensions (W x D x H) mm	External dimensions (W x D x H) mm	Rated capacity kW	Net weight kg	PK	Cat. No.
WNE7	7	240 x 210 x 140	468 x 356 x 238*	1.2	11	1	9.906 591
WNE10	10	350 x 210 x 140	578 x 356 x 238*	1.2	13	1	9.906 592
WNE14	14	350 x 290 x 140	578 x 436 x 238*	1.8	15	1	9.906 593
WNE22	22	350 x 290 x 220	578 x 436 x 296*	2.0	17	1	9.906 594
WNE29	29	590 x 350 x 140	818 x 516 x 238*	2.4	24	1	9.906 595
WNE45	45	590 x 350 x 220	818 x 516 x 296*	2.8	26	1	9.906 596

*Weight and height with flat cover.



Options and accessories for water baths

Flat cover: Flat stainless steel cover with openings and concentric ring sets

Gable cover: Stainless steel gable cover, also suitable for shaking device and Peltier cooling device

Shaking device: Shaking device including support frame (for racks or support basket with perforated mounting shelf) for use in water baths, shaking speed 35-160 strokes per minute (horizontal back/forth movement), requires gable cover

Peltier-cooling device CDP115: For precise operation with temperatures starting from +10 °C. The temperature is controlled via the electronic controller of the waterbath with a precision of ±0.1 K. Easy fitting to bath by snap-on-technology, suitable for all tank sizes. Power supply: 230 V, 50/60 Hz or 115 V, 60 Hz (please state in case of order).

Effective cooling capacity: 115 W. Pumping capacity of circulation pump for coolant: 600 ml/min

Bottom grid: reversible for 2 heights (30 mm and 60 mm)

Memmert

Type	For Volume l	Diam. mm	Openings	PK	Cat. No.
Flat cover	7	147	1	1	9.906 530
Flat cover	10	107	3	1	9.906 531
Flat cover	14	87	6	1	9.906 532
Flat cover	22	87	6	1	9.906 533
Flat cover	29	107	8	1	9.906 534
Flat cover	45	107	8	1	9.906 537
Flat cover	29/45	147	4	1	6.073 294
Gable cover	7			1	9.906 561
Gable cover	10			1	9.906 562
Gable cover	14/22			1	6.306 619
Gable cover	29/45			1	6.228 924
CDP115 Peltier Cooling Device	all			1	9.906 651
Water level control	all			1	9.906 650
Installation and connection set for Peltier cooling device CDP115	all			1	7.900 153
Bottom grid	7			1	6.302 001
Bottom grid	10			1	7.076 000
Bottom grid	14			1	6.200 774
Bottom grid	22			1	7.076 101
Bottom grid	29			1	7.083 478
Bottom grid	45			1	6.801 467
Shaking device	14/22			1	7.075 941
Shaking device	29/45			1	6.228 923

Further accessories can be found in our online shop.

Heating/Shaking water baths

1



1 Shaking water baths LSB Aqua Pro

- Reliable linear shaking mechanism for consistent results
- Excellent temperature stability and uniformity of ± 0.1 °C
- Simple controls, clear, bright display
- Set and Forget™ technology, fast heat-up accurate temperature control
- Extensive choice of trays for a wide variety of vessels. Trays sold separately
- Discreet magnetically coupled shaking mechanism maximises working area
- Advanced dry start/run dry protection, prevents costly service repairs
- Universal frame and polycarbonate lid included

Grant

Accessory polypropylene spheres or a lid must be used at temperatures between +60 °C and +99 °C. Accessory cooling is required for temperatures below ambient.

Please order PP spheres separately.

Minimum working depth:	60mm
Temperature range:	ambient +5 to 99 °C
Display:	LED
Linear shaking speed:	20 to 200 rpm (depending on load)
Shaking speed display resolution:	1 rpm
Linear shaking stroke length:	20 mm
Timer:	1 to 999 min
Drain tap:	yes
Supply voltage:	220-230 V

Type	Capacity of the bath litres	Internal dimensions (W x D x H) mm	External dimensions (W x D x H) mm	Dimensions Shaking trays (D x W) mm	PK	Cat. No.
LSB12	12	323 x 298 x 118	360 x 380 x 275	240 x 235	1	6.264 684
LSB18	18	298 x 500 x 118	335 x 565 x 275	420 x 235	1	6.264 685

2



2 Shaking water bath OLS 26 Aqua Pro

A combined orbital/linear shaking bath for ultimate flexibility and usability. Combined orbital/linear motion in one bath, simply rotate tray carrier 180°.

Grant

- Excellent temperature stability and uniformity of ± 0.1 °C
- Adjustable shaking speed/intensity for application optimisation
- Set and Forget™ technology - fast heat-up accurate temperature control
- Extensive choice of trays for a wide variety of vessels. Trays sold separately
- Includes adjustable high temp cut-off/alarm, countdown timer, presets, calibration facility and dry start/run dry protection
- Discreet magnetically coupled shaking mechanism maximises working area
- Universal frame and polycarbonate lid included

Accessory polypropylene spheres or a lid must be used at temperatures between +60 °C and +99 °C. Accessory cooling is required for temperatures below ambient.

Please order PP spheres separately.

Tank size:	26 l
Minimum working depth:	70 mm
Temperature range:	ambient +5 to 99 °C (0 to 99 °C with accessory cooling)
Uniformity:	± 0.1 °C
Stability:	± 0.1 °C
Display:	2 x LED (individual displays & controls for temperature and shaking speed)
Orbital and Linear shaking speed:	20 to 200 rpm (depending on load)
Orbital shaking radius:	9 mm
Shaking speed display resolution:	1 rpm
Linear shaking stroke length:	18, 28, 36 mm
Shaking tray area:	380 x 235 mm
Timer:	1 to 999 min
Drain Tap:	yes
Supply voltage:	220-230 V

Type	Capacity of the bath litres	Internal dimensions (W x D x H) mm	External dimensions (W x D x H) mm	PK	Cat. No.
OLS 26	26	298 x 500 x 159	335 x 565 x 325	1	6.264 683

Accessories for shaking water baths

Grant

Type	For	PK	Cat. No.
Refrigerated immersion cooler CC26	OLS26	1	6.264 808
Cooling coil CW26	OLS26	1	6.264 809
Spring clamp SC-25	25 ml flask	1	6.264 810
Spring clamp SC-50	50 ml flask	1	6.264 811
Spring clamp SC-100	100 ml flask	1	6.264 812
Spring clamp SC-250	250 ml flask	1	6.264 813
Spring clamp SC-500	500 ml flask	1	6.264 814
Spring clamp SC-1000	1000 ml flask	1	6.264 815

1 2 Trays for shaking water baths OLS/LSB series

Versatile stainless steel trays. Designed to accommodate a variety of vessels. Adjustable spring configuration for maximum flask capacity.

Grant

Type	For	PK	Cat. No.
Universal tray TU12	LSB12	1	6.264 687
Universal tray TU18	LSB18	1	6.264 688
Universal tray TU26	OLS26	1	6.264 686
Test tube tray TS26	OLS26	1	6.264 689
Test tube tray TS12	LSB12	1	6.264 690
Test tube tray TS18	LSB18	1	6.264 691
Flask tray TF26	OLS26	1	6.264 695
Flask tray TF12	LSB12	1	6.264 696
Flask tray TF18	LSB18	1	6.264 697
Base tray SBT12	LSB12	1	6.264 698
Base tray SBT26	OLS26/LSB18	1	6.264 699



3 Shaking water baths Hydro

NEW
LAUDA

With their excellent temperature homogeneity, the universal Hydro shaking water baths are designed for the needs of biological, medical or biochemical laboratories. The models H 20 S and H 20 SW shaking water baths have a linear, oscillating shaking movement, while model H 20 SOW moves the sample in an orbital motion.

- For boiling range applications
- TFT display
- Speed controller for load-independent, continuously adjustable shaking movement
- Soft, controlled start of the shaking movement
- Dry run protection (safety class I, NFL)
- Maintenance free and reliable
- H 20 SW and H 20 SOW with integrated cooling coil



Specifications	H 20 S (SW) // H 20 SOW
Type of movement:	linear // orbital
Speed Range:	10 ... 250 rpm
Shaking diameter:	22 mm // 14 mm
Temperature stability:	±0.1 K
Heating power:	1.5 kW
Power supply:	230 V, 50/60 Hz

Type	Capacity of the bath	Internal dimensions (W x D x H)	External dimensions (W x D x H)	Temp. range	PK	Cat. No.
	litres	mm	mm	°C		
H 20 S	20	450 x 300 x 160	715 x 520 x 330	25 ... 99.9	1	4.672 299
H 20 SW	20	450 x 300 x 160	715 x 520 x 330	10 ... 99.9	1	4.672 300
H 20 SOW	20	450 x 300 x 155	632 x 500 x 390	10 ... 80	1	4.672 301

1 Shaking water baths, SW series

For simultaneous heating and shaking of samples, e.g. incubations, hybridizations etc.
 Reciprocal motion.

JULABO

- microprocessor technology with PID temperature control
- bright Multi-Display (LED) indicates five different temperature values and shaking speed
- splash-proof mains switch, built into plastic membrane keypad
- easy-to-use controls
- timer for selecting desired operating period
- RS232 interface provided
- shaking frequency 20 to 200 strokes/min., with 15 mm stroke
- removable shaking carriage
- model SW23 has an internal circulation pump giving enhanced temperature stability

Bath lid not included.

Type	Capacity of the bath litres	Internal dimensions (W x D x H) mm	External dimensions (W x D x H) mm	PK	Cat. No.
SW22	20	500 x 300 x 180	700 x 350 x 260	1	9.906 383
SW23	20	500 x 300 x 180	700 x 350 x 260	1	9.906 384

1



2

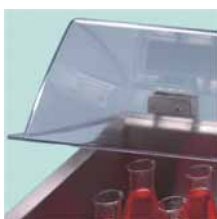

2 Shaking water baths, SW 22, SW 23, accessories

JULABO

Type	PK	Cat. No.
Hinged Makrolon® lid	1	9.906 401
Constant level device/cooling set	1	9.906 402

3



3 Test tube trays

JULABO

For	PK	Cat. No.
240 test tubes, 16/17 mm Ø	1	9.906 420
360 test tubes, 12/13 mm Ø	1	9.906 421
360 microlitre vessels, 30 x 11/12 mm Ø	1	9.906 422
84 test tubes, 30 mm Ø	1	9.906 423

➔ Water bath protection agent please see page 830.

1 Sand Baths with Performance Control and Thermostatic Controller

For continuous operation. Electrical sand baths with thermostatic temperature control and separate power controller for performance adjustment to the heating requirements. Anodised aluminium alloy hotplate. Excellent uniform temperature distribution over the entire heating surface. Asbestos free. The sand bath frame is tightly screwed onto the hotplate so that the sand is in direct contact with the hotplate. Useful depth 50 mm. Stainless steel controller housing, with painted central section. Height-adjustable feet. Connection cable approximately 1.7 m. With earthed plug for 230 V supplies up to 3300 W. A 400 V 3-phase model is also available.

Gestigkeit



Type	Min. operating temperature RT + °C	Max. operating temperature °C	Hot-plate mm	Dimensions (W x D x H) mm	Net weight kg	PK	Cat. No.
ST 72	50	300	360 x 360	358 x 358 x 220	14	1	9.645 814
ST 82	50	300	360 x 510	364 x 514 x 220	21	1	9.645 815
ST 92-2	50	300	440 x 590	442 x 592 x 220	28	1	9.645 816
ST 93-230	100	370	440 x 590	442 x 592 x 220	28	1	9.645 819
ST 92-3	50	300	440 x 590	442 x 592 x 220	28	1	9.645 820

* special production

2 Heating Bath HB eco



2

Compact and ergonomic heating safety bath.

- Ergonomic handles
- Clear, black-and-white display
- Alternating set-point/actual temperature display
- USB interface

Specifications

Heating output:	1400 W
Temperature range:	ambient ... 99 °C
Setting accuracy:	±1 K
Offset:	±2 K
Material:	Stainless steel 1.4404
Useful volume:	4 l
Dimensions, internal (diam. x H):	225 x 130 mm
Dimensions, external (W x D x H):	330 x 325 x 190 mm
Weight:	3.9 kg
Power supply:	200 ...240/100 ... 120 V, 50/60 Hz
IP code acc. to DIN EN 60529:	IP 21

Type	PK	Cat. No.
HB eco	1	6.311 083

IKA



3 Heating Bath HB Digital

Compact and ergonomic heating safety bath for all tempering media.

- Ergonomic handles
- Key button to lock heating bath temperature
- Clear, black-and-white display
- Permanent set-point/actual temperature display
- 3 different safety operating modes
- USB interface

Specifications

Heating output:	1350 W
Temperature range:	ambient ... 180 °C
Setting accuracy:	±1 K
Offset:	±1 K
Material:	Stainless steel 1.4404
Useful volume:	4 l
Dimensions, internal (diam. x H):	225 x 130 mm
Dimensions, external (W x D x H):	330 x 325 x 190 mm
Weight:	3.9 kg
Power supply:	200 ...240/100 ... 120 V, 50/60 Hz
IP code acc. to DIN EN 60529:	IP 21

Type	PK	Cat. No.
HB digital	1	9.729 918

IKA

3



Heating/Heating baths

1

1 Heating bath HBR 4 control

The heating bath is noted for:

- Cylindrical bath shape
- Heating elements integrated into the bath base
- Heat transfer media can be low-viscous oil (50 mPas) or water
- Two carry handles
- Infinitely variable safety temperature limiter according to DIN 12877
- Double-jacketed mantle protection against burns
- Digital display for target, actual and safety temperatures as well as speed
- Integrated magnetic stirrer drive to circulate the tempering fluid, allowing for better heat distribution in the bath
- RS 232 interface

IKA

Specifications

Heating output:	1000 W
Temperature range:	ambient up to 200 °C
Setting accuracy:	±1 K
Offset:	±1 K
Material:	stainless steel 1.4301
Useful volume:	max. 4 l
Ext./int. height:	250/160 mm
Dimensions (W x D x H):	340 x 250 x 340 mm
Weight:	4.4 kg
Protection class DIN EN 60529:	IP 20
Tested to DIN 12877 II.	

Type	PK	Cat. No.
HBR 4 control	1	6.282 329

2

2 Heating bath liquid, BUDDER

Use:

BUDDER heating bath liquid can be used continuously as a heating medium up to approx. 170 °C. Higher temperatures (below flash point) are possible, but will result in rapid darkening. The low pour point allows the bath liquid also to be used as a cooling medium. Mixtures with 10 % to 30 % water achieve best results.

Buddeberg

The crucial advantages of BUDDER heating bath liquid compared to the oils or other organic liquid mainly used are:

- accidental spillage of water into the bath does not lead to dangerous spitting at temperatures over 100 °C, as the water dissolves in the heating bath liquid and subsequently evaporates safely
- BUDDER heating bath liquid can easily be rinsed away with water which eases cleaning of laboratory equipment, e.g. distillation flasks, and also bench or floor if the bath liquid is accidentally spilled.
- BUDDER heating bath liquid does not foam when mixed with water.

Viscosity on addition of water:

BUDDER heating bath liquid is quite viscous at ambient or low temperatures, and therefore sometimes difficult to dispense. The addition of 10-20 % water reduces the viscosity and enables easier handling. If the mixture is then heated to 100 °C, the water evaporates without boiling. Further heating is only shortly delayed by this. Before next heating, water can be added again.

Water solubility: BUDDER heating bath liquid can be mixed with water in any ratio.

The hardness of the water has no effect on the bath liquid.

Chemical character:	Modified polyglycoether
Appearance:	Clear, colourless or lightly yellowish liquid
Storage time:	When stored for long periods (over 2 years) the product may become darker. This does not affect the performance of the product.
Water solubility:	Heating bath liquid BUDDER can be mixed with water in any ratio.
pH value (DIN ISO 976):	6-8 (100 g/l, 20 °C)
Solidification temperature (DIN ISO 3016):	approx. -39 °C
Boiling point:	200 °C
Density (DIN 51757, 23 °C):	approx. 1.13 g/cm ³ to 1.17 g/cm ³
Flashpoint (DIN EN ISO 2592):	> 290 °C
Ignition temperature (DIN 51794):	approx. 390 °C

Container	PK	Cat. No.
5 litres	1	9.906 200

Hotplate Ceran®

Housing made of stainless steel, brushed and polished, in a unique Softline Design, Schott Ceran® cooking surface. Adjustable power control with power-saving or power control in 9 steps (TC = Touch Control). Two-circle HiLight technique, thus extra large heating zone (dia. 210 mm) can be activated. Thermal shutdown and automatic cooking system. Residual heat indicator and warning light. Temperature range (empty): 0 to approx. 460 °C. Power supply 230 V.

Type	Dimensions (W x D x H) mm	Hot-plate mm	Heating capacity W	PK	Cat. No.
CT 2200/E	305 x 410 x 75	Ø 140/210	1000/2200	1	9.645 510
CT 2203/TC	305 x 410 x 75	Ø 140/210	1000/2200	1	9.645 511
CT 3400/E	550 x 310 x 65	Ø 140/210, Ø 145	1000/2200, 1200	1	6.261 651
CT 3010	300 x 600 x 80	Ø 145, Ø 180	1200, 1800	1	7.940 294

1



9.645 510

Hotplate induction Ceran®

- casing made of brushed stainless steel in softline design
- Schott Ceran® cooking surface, superior and easy to clean
- with superior induction technology, pot recognition
- safe, user-friendly and extremely energy-saving
- temperature selection in 21 levels in steps of 10 °C from 60 °C (keeping warm) up to 260 °C
- power selection in 9 levels, powerboost (2200 W) for additional performance
- timer up to 99 minutes, automatic switch-off and signal tone
- electronic regulation via touch control sensors
- integrated safety functions, overheating protection
- indicators for residual heat, standby and power-on

Specifications

Heating zone: 80 - 200 mm Ø
 Weight: 3.5 kg
 Power supply: 230 V ~ 2200 W

Type	Dimensions (W x D x H) mm	PK	Cat. No.
Hotplate induction Ceran®	305 x 410 x 75	1	7.672 290

2



Hotplates, analogue, CB300 and CB500

Energy regulator control with glass ceramic top plate and 'hot' warning lamp which illuminates when the plate temperature exceeds 50 °C. For 230 V 50/60 Hz single phase supplies. With BioCote, silver-based, antimicrobial protection. Maximum temperature as indicated.

Stuart

Type	Dimensions (W x D x H) mm	Hot-plate mm	Rating W	Max. temp. °C	Weight kg	PK	Cat. No.
CB300	320 x 370 x 120	300 x 300	1200	450	6	1	9.645 338
CB500	520 x 360 x 130	500 x 300	2250	375	12	1	9.645 316

3



Hotplate CP 300, analogue

NEW

Stuart

A heated glass ceramic plate mounted in a block of pure PTFE creates a powerful hotplate which is chemically resistant, even to concentrated acids. The separate temperature controller is connected to the hotplate via a 2 metre PTFE coated lead, which allows the hotplate to be located in fume hoods.

- Ideal for acid digestions or trace metal analysis
- PTFE construction with glass ceramic plate for exceptional resistance to chemical attack
- Can be cleaned with concentrated nitric acid
- Controller is fitted with a hot warning light for temperatures above 50 °C

Specifications

Max. temperature: 400 °C
 Heater power: 900 W
 Heated area: 200 x 200 mm
 Dimensions Hotplate (W x D x H): 320 x 360 x 60 mm
 Dimensions Controller (W x D x H): 150 x 160 x 65 mm
 Net weight: 11 kg
 Power supply: 230 V, 50/60 Hz

Type	PK	Cat. No.
CP 300	1	6.230 893

4



➔ Boiling chips - please see page 638.

Hotplates SS/CS/SD/CD/SP150

Hotplates with accurate temperature control.

Stuart

- Spill-resistant front control panel with chemically toughened glass for extra resilience
- Hot surface warning light flashes when plate temperature is above 50 °C
- Durable chip-resistant aluminum top plate offers excellent heat transmission, rapid heating, and oven temperature distribution
- Ceramic top plate is chemical resistant and easy to clean, plus the white surface ensures good visibility of colour changes
- With an integral fixing point for a retort rod
- With BioCote, silver-based, antimicrobial protection

SP150 additionally with:

- Full-colour 10-cm TFT screen which simultaneously displays target settings and the actual temperature
- Individual profiles can be created and saved
- User calibration for adjusting the temperature output ($\pm 5\%$ at 50 and 450 °C)
- Incl. Pt100 Temperature sensor

Specifications

Max. load:	15 l
Display resolution:	1 °C
Accuracy:	± 1 °C
Dimensions Hotplate (W x D x H):	150 x 150 mm
Dimensions (W x D x H):	180 x 300 x 93 mm
Net weight:	2.5 kg
Power supply:	230 V, 50/60 Hz
Warranty:	3 years

1



4.672 501

Hotplate SS150/CS150, analogue

With basic interface and an LED array indicating the temperature, offering the same quality as the two higher end models. With connection for contact thermometer SCT-1.

NEW

Stuart

Specifications	SS150 // CS150
Max. temperature:	325 °C // 450 °C
Heater power:	700 W // 500 W
Heated area:	150 x 150 mm // 120 x 120 mm

2



4.672 502

Type	Material stirring surface	Colour	PK	Cat. No.
SS150B	Aluminium, ceramic coated	Blue	1	4.672 499
SS150K	Aluminium, ceramic coated	Black	1	4.672 500
SS150W	Aluminium, ceramic coated	White	1	4.672 501
CS150B	Glass ceramic	Blue	1	4.672 502
CS150K	Glass ceramic	Black	1	4.672 503
CS150W	Glass ceramic	White	1	4.672 504

3



4.672 514

Hotplate SD150/CD150/SP150, digital

With digital interface for a digital temperature setting. With connection for contact thermometer SCT-1.

NEW

Specifications	SD150/SP150 // CD150
Max. temperature:	325 °C // 450 °C
Heater power:	700 W // 500 W
Heated area:	150 x 150 mm // 120 x 120 mm

4



4.672 576

Type	Material stirring surface	Colour	PK	Cat. No.
SD150B	Aluminium, ceramic coated	Blue	1	4.672 511
SD150K	Aluminium, ceramic coated	Black	1	4.672 512
SD150W	Aluminium, ceramic coated	White	1	4.672 513
CD150B	Glass ceramic	Blue	1	4.672 514
CD150K	Glass ceramic	Black	1	4.672 515
CD150W	Glass ceramic	White	1	4.672 516
SP150B	Aluminium, ceramic coated	Blue	1	4.672 575
SP150W	Aluminium, ceramic coated	White	1	4.672 576
SP150K	Aluminium, ceramic coated	Black	1	4.672 577
SP150P	Aluminium, ceramic coated	Pink	1	4.672 578

1 Hotplates, analogue, SB 300 and SB 500

Maximum temperature 300 °C. Energy regulator control with cast aluminium/silicon alloy top plate and 'hot' warning lamp which illuminates when the plate temperature exceeds 50 °C. The 300 mm x 300 mm top plate model has a retort rod mounting at the rear of the housing. With BioCote, silver-based, antimicrobial protection.

Stuart



Type	Dimensions (W x D x H) mm	Hot-plate mm	Rating W	Max. temp. °C	Weight kg	PK	Cat. No.
SB300	320 x 370 x 120	300 x 300	600	300	6	1	9.645 331
SB500	520 x 360 x 130	500 x 300	1500	300	12	1	9.645 317

2 Hotplates digital, SD 300 and SD 500

Maximum temperature 300 °C. Digital setting and control of plate temperature with 1 °C resolution and cast aluminium/silicon alloy top plate. The 300 x 300 mm top plate model has a retort rod mounting at the rear of the housing. With BioCote, silver-based, antimicrobial protection. For 230V 50/60 Hz single phase supplies.

Stuart



Type	Dimensions (W x D x H) mm	Hot-plate mm	Rating W	Max. temp. °C	Weight kg	PK	Cat. No.
SD300	320 x 370 x 105	300 x 300	600	300	6	1	9.645 320
SD500	520 x 360 x 130	300 x 500	1500	300	12	1	9.645 321

Hotplates C-MAG HP 4/C-MAG HP 7/C-MAG HP 10

Made of glass ceramic which offers excellent chemical resistance.
- fixed safety circuit of 550 °C

IKA

- Hot Top indicator: Hot surface warning to prevent burns
- exact temperature setting via digital display (LED)
- digital error code display
- raised control panel for protection against spilt liquids

C-MAG HP 7, C-MAG HP 10 additionally:
adapter according to DIN 12878 for connecting a contact thermometer, e.g. ETS-D5, enables precise temperature control



9.720 496

Specifications

Heating function

Temperature display:	digital
Heat output	
C-MAG HP 4:	250 W
C-MAG HP 7:	1000 W
C-MAG HP 10:	1500 W
Heating rate (1 litre H ₂ O)	
C-MAG HP 4:	2.5 K/min
C-MAG HP 7/HP 10:	5 K/min
Temperature range:	50 to 500 °C
Setting accuracy:	±10 K
Safety circuit fixed:	550 °C
Control accuracy with sensor	
C-MAG HP 4:	-
C-MAG HP 7/HP 10:	ETS-D5/±0.5 K

Heating plate

Material:	glass ceramic
Dimensions	
C-MAG HP 4:	100 x 100 mm
C-MAG HP 7:	180 x 180 mm
C-MAG HP 10:	260 x 260 mm
Tested to DIN EN IEC 61010-1.	



9.720 497



9.720 498

Type	Dimensions (W x D x H) mm	Weight kg	Plug type	PK	Cat. No.
C-MAG HP 4	150 x 260 x 105	3	EU	1	9.720 496
C-MAG HP 7	220 x 330 x 105	5	EU	1	9.720 497
C-MAG HP 10	300 x 415 x 105	6	EU	1	9.720 498

Optional accessories: HP 7 and HP 10 additionally: Electronical thermometer ETS-D5

Heating/Hotplates

1

1 High-performance hotplates

With thermostatic temperature control. CERAN® glass ceramic material is highly resistant to breakage and changes in temperature, free from distortion, permeable to infrared light and highly acid-resistant. Bench-top instrument with built-in controller. SR model - with separate controller for wall mounting.

Gestigkeit

Type	Dimensions (W x D x H) mm	Hot-plate mm	Rating		Temp. range max. °C	Supply requirements V	Weight kg	PK	Cat. No.
			W						
4 A	440 x 300 x 100	430 x 140	1500		50 - 500	230	5.0	1	7.603 031
11 A	290 x 410 x 100	280 x 280	2000		50 - 500	230	5.5	1	9.645 711
22 A	290 x 560 x 100	280 x 430	3000		50 - 500	230	6.5	1	9.645 712
33 A	440 x 560 x 100	430 x 430	4400		50 - 500	3x400	9.0	1	9.645 714
44 A	590 x 560 x 100	580 x 430	5700		50 - 500	3x400	11.5	1	9.645 715
4 SR	440 x 180 x 100	430 x 140	1500		50 - 500	230	5.0	1	6.803 027
11 SR	290 x 290 x 100	280 x 280	2000		50 - 500	230	5.5	1	9.645 721
22 SR	290 x 440 x 100	280 x 430	3000		50 - 500	230	6.5	1	9.645 722
33 SR	440 x 440 x 100	430 x 430	4400		50 - 500	3x400	9.0	1	9.645 724
44 SR	590 x 440 x 100	580 x 430	5700		50 - 500	3x400	11.5	1	9.645 725
33 EB	440 x 440 x 100	430 x 430	4400		50 - 500	3x400	9.0	1	9.645 734

2

2 High-performance hotplate CERAN®

High-performance CERAN® glass ceramic hotplate with circular heating area 145 mm diameter and square placement surface made of glass ceramic (175 x 175), stainless steel housing, power controller (adjustable 10 % to 100 %) and integral temperature monitor.

Gestigkeit

Type	Dimensions (W x D x H) mm	Hot-plate mm	Rating		Temp. range max. °C	Supply requirements V	Weight kg	PK	Cat. No.
			W						
CT 10	200 x 290 x 85	∅ 145	1200		500	230	2.6	1	9.645 740

3

3 Precision hotplate, PZ 44

Automatic, precise regulation of temperatures between 20 and 450 °C. Digital presetting and temperature display. Three power levels (825 W, 1650 W and 3300 W) can be set and an additional electronic power controller (adjustable 10 % to 100 %) is provided. At 825 W and 3300 W settings the entire plate surface is heated. At 1650 W setting only the right hand side of the plate is heated. As a result of heat conduction, the temperature from the right hand side to the left edge of the plate varies by approx. 40 %. Built-in relay allows direct connection of electronic contact thermometers. With solid, flat, low-distortion, cast GG15 alloy. Switching differential ±1 K.

Gestigkeit

Type	Dimensions (W x D x H) mm	Hot-plate mm	Rating		Temp. range max. °C	Supply requirements V	Weight kg	PK	Cat. No.
			W						
PZ 44	320 x 470 x 190	290 x 440	3300		20 to 450	230*	23	1	9.645 744

* 400 V, 3-ph. versions are also available on request

1 Precision hotplates, PZ-series

For continuous operation. Provide extremely accurate, uniform temperatures, even in plate corners and on edges. Polished anodised aluminium heating surface. Microprocessor-controlled temperature controller with temperature setting up to 99.9 in 0.1 °C steps, over 99.9 in 1 °C steps. Actual temperature displayed continuously. With separate power controller for performance adjustment to the heating requirements from 10 to 100 %. Built-in relay allows direct connection of electronic contact thermometers. Adjustable temperature monitor from 50 to 300 °C (with PZ 28-1, 30 to 110 °C) to prevent excess temperatures.

Gestigkeit



Type	Dimensions (W x D x H) mm	Hot-plate mm	Rating W	Temp. range max. °C	Supply requirements V	Weight kg	PK	Cat. No.
PZ 28-1	210 x 300 x 135	200 x 280	500	20 to 110	230	7	1	9.645 827
PZ 28-2	210 x 300 x 135	200 x 280	1100	20 to 300	230	7	1	9.645 828
PZ 35	365 x 365 x 155	350 x 350	2200	20 to 300	230	14	1	9.645 824
PZ 60	620 x 200 x 155	610 x 160	2000	20 to 300	230	12	1	9.645 829

2 Hotplates with Performance Control and Thermostatic Controller

For continuous operation. Electric hotplates with thermostatic temperature control and separate power controller for performance adjustment to the heating requirements. Anodised aluminium alloy hotplate. Excellent uniform temperature distribution over entire heating surface. Asbestos free. Stainless steel housing, with painted central section. Height-adjustable feet. Mains cable approximately 1.7 m. With earthed plug for 230 V supplies up to 3300 W. A 400V 3-phase model is also available.

Gestigkeit



Type	Dimensions (W x D x H) mm	Hot-plate mm	Rating W	Temp. range max. °C	Supply requirements V	Weight kg	PK	Cat. No.
HT 02	312 x 312 x 170	300 x 300	1800	50 - 300	230	11	1	9.645 781
HT 12	358 x 358 x 170	350 x 350	2200	50 - 300	230	13	1	9.645 782
TH 11	308 x 458 x 170	290 x 440	1650	30 - 110	230	14	1	9.645 773
TH 13	308 x 458 x 170	290 x 440	2400	100 - 370	230	14	1	9.645 793
HT 22	514 x 364 x 170	350 x 500	2850	50 - 300	230	19	1	9.645 785
HT 31	592 x 442 x 170	430 x 580	2000	30 - 110	230	26	1	9.645 776
HT 32-230	592 x 442 x 170	430 x 580	4000	50 - 300	230	26	1	9.645 786
HT 32-400	592 x 442 x 170	430 x 580	4000	50 - 300	3x400	26	1	9.645 787
HT 33-230	592 x 442 x 170	430 x 580	4000	100 - 370	230	26	1	9.645 796

3 Multiple hotplate systems behrotest®

Multiple hotplate systems, 360 W, with individually adjustable heating controls and indicator lights. Maximum surface temperature 400 °C.

behr



HB4 + HBS4

Type	Description	Dimensions (W x D x H) mm	PK	Cat. No.
HB 4	4 hotplates with metal protective grills, 94 mm diam.	530 x 320 x 150/760*	1	9.645 590
HB 6	6 hotplates with metal protective grills, 94 mm diam.	760 x 320 x 150/760*	1	9.645 591
HB 8	8 hotplates with metal protective grills, 94 mm diam.	900 x 320 x 150/760*	1	9.645 594
HBS 4	Holder for HB 4 incl. 4 support rods		1	9.645 592
HBS 6	Holder for HB 6 incl. 6 support rods		1	9.645 593
HBS 8	Holder for HB 8 incl. 8 support rods		1	9.645 595

*with support rod

Heating/Heating mantles



1 Standard heating mantles series KM-G

LabHEAT®-Heating mantles for flasks, round bottom. Flexible glass yarn heating element, outer jacket in glass silk, with diam. 60 mm bottom out-let from 500 ml, max. heating element temperature 450 °C, 1.5 m power supply (earthed) cable with heating-zone switch and RCD (residual current detection), nominal voltage 230 V AC.

SAF Wärmetechnik

Capacity	Flask diam.	Rating	Heating zones	PK	Cat. No.
ml	mm	W			
25	41	65	1	1	9.642 401
50	51	75	1	1	9.642 402
100	64	120	1	1	9.642 403
250	85	180	2	1	9.642 404
500	105	250	2	1	9.642 405
1000	131	450	2	1	9.642 406
2000	166	600	2	1	9.642 407
3000	185	800	2	1	9.642 408
4000	207	900	2*	1	9.642 409
5000	223	1200	2*	1	9.642 410
6000	236	1400	2*	1	9.642 411
10000	279	2000	2*	1	9.642 412
20000	345	2200	2*	1	9.642 413

Heating mantles with other specifications available on request.

*with 4 heating zones available on request



2 Standard heating mantles series KM-GH

LabHEAT®-Heating mantles for flasks, round bottom. Designed identical to series KM-G, but the heating element is made of heat-resistant quartz yarn and permits a maximum temperature up to 900 °C; 1.5 m power supply (earthed) cable with heating-zone switch and RCD (residual current detection); nominal voltage 230 V AC.

SAF Wärmetechnik

Capacity	Flask diam.	Rating	Heating zones	PK	Cat. No.
ml	mm	W			
100	64	200	1	1	9.642 440
250	85	300	2	1	9.642 441
500	105	500	2	1	9.642 442
1000	131	750	2	1	9.642 443
2000	166	1200	2	1	9.642 444
4000	207	1800	2	1	9.642 445
6000	236	2500	2	1	9.642 446

Heating mantles with other specifications available on request.



3 4 Accessories for Standard heating mantles

LabHEAT® - Accessories made of stainless steel (1.4301) for higher stability or to integrate within support wall. The heating mantles are able to be suspended on its four clips.

SAF Wärmetechnik

For mantle	Description	PK	Cat. No.
ml			
100	Tripod	1	9.642 600
250	Tripod	1	9.642 601
500	Tripod	1	9.642 602
1000	Tripod	1	9.642 603
2000	Tripod	1	9.642 604
3000	Tripod	1	9.642 605
4000	Tripod	1	9.642 606
5000	Tripod	1	9.642 607
6000	Tripod	1	9.642 608
10000	Tripod	1	9.642 609
20000	Tripod	1	9.642 610
25	Support ring	1	9.642 620
50	Support ring	1	9.642 621
100	Support ring	1	9.642 622
250	Support ring	1	9.642 623
500	Support ring	1	9.642 624
1000	Support ring	1	9.642 625
2000	Support ring	1	9.642 626
3000	Support ring	1	9.642 627
4000	Support ring	1	9.642 628

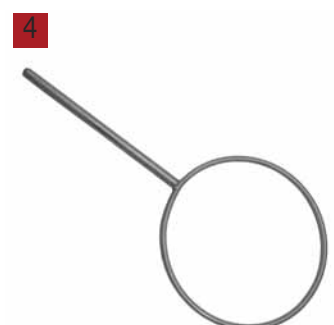

1 Metal-cased heating mantles series KM-M, without controller

LabHEAT® - Heating mantles for flasks, round bottom. Flexible glass yarn heating element in plastic coated, chemical-resistant metal housing with built-in power-on and heating zone switch; max. heating element temperature 450 °C; 1.5 m power supply (earthed) cable and RCD (residual current detection); nominal voltage 230 V AC. SAF Wärmetechnik

Capacity	Flask diam.	Rating	Heating zones	PK	Cat. No.
ml	mm	W			
50	51	55	1	1	9.642 500
100	64	100	1	1	9.642 501
250	85	150	2	1	9.642 502
500	105	200	2	1	9.642 503
1000	131	300	2	1	9.642 504
2000	166	500	2	1	9.642 505
3000	185	600	2	1	9.642 506
4000	207	750	2	1	9.642 507
5000	223	860	2	1	9.642 508
6000	236	1000	2	1	9.642 509
10000	279	1400	2	1	9.642 510
20000	345	2000	2	1	9.642 511

Serial heating units and Heating mantles with other specifications available on request.

1



2 Metal-cased heating mantles series KM-ME, with controller

LabHEAT® - Heating mantles for flasks, round bottom. Flexible glass yarn heating element in plastic coated, chemical-resistant metal housing with built-in power-on and heating zone switch, **in addition equipped with a controller** which allows a continuous adjustment of the heater power; max. heating element temperature 450 °C; 1.5 m power supply (earthed) cable and RCD (residual current detection); nominal voltage 230 V AC. SAF Wärmetechnik

Capacity	Flask diam.	Rating	Heating zones	PK	Cat. No.
ml	mm	W			
50	51	55	1	1	9.642 520
100	64	100	1	1	9.642 521
250	85	150	2	1	9.642 522
500	105	200	2	1	9.642 523
1000	131	300	2	1	9.642 524
2000	166	500	2	1	9.642 525
3000	185	600	2	1	9.642 526
4000	207	750	2	1	9.642 527
5000	223	860	2	1	9.642 528
6000	236	1000	2	1	9.642 529
10000	279	1400	2	1	9.642 530
20000	345	2000	2	1	9.642 531

Heating mantles with other specifications available on request.

2



3 Electronic heating mantles, EM series

Polypropylene outer case is resilient and chemically resistant. Highly efficient in heating up to a maximum element temperature of 450 °C. The flexible heating element is suspended in a thermal insulating cartridge to provide maximum heat transfer with minimum risk of flask breakage. Even at full power output, the exterior remains "cool-to-touch" due to good heating element insulation. All heating mantles have support clamp for rods of up to 12 mm diameter, and are double fused, with earth (ground) screen to protect the user from electric shocks. Available as 220-240 V 50/60 Hz models; spare heater cartridges are available on request. Electrothermal

For flasks	Width	Depth	Height	Power	PK	Cat. No.
ml	mm	mm	mm	W		
100	175	260	127	60	1	9.643 033
250	175	260	127	150	1	9.643 034
500	238	310	145	200	1	9.643 035
1000	238	310	145	300	1	9.643 036
2000	350	400	190	500	1	9.643 037
3000	350	400	190	500	1	9.643 038
5000	350	400	190	800	1	9.643 039

3



Heating/Heating mantles

1

1

Multi-size Heating Mantles, series KM-MPE for different sized round bottom flasks

LabHEAT®-Heating mantles for flasks, round bottom. Designed and technically identical to series KM-ME, but can be used **for round flasks of three different sizes**, max. heating element temperature 450 °C; 1.5 m power supply (earthed) cable and RCD (residual current detection); nominal voltage 230V AC also equipped with a controller which allows a continuous adjustment of power.

SAF Wärmetechnik

Capacity	Flask diam.	Rating	Heating zones	PK	Cat. No.
ml	mm	W			
50 to 250	51 to 85	160	3	1	9.642 540
250 to 1000	85 to 131	350	3	1	9.642 541
1000 to 3000	131 to 185	700	3	1	9.642 542

Serial Heating Units and Heating Mantles with other specifications available on request.

2

2

Metal-cased heating mantles, series KM-MEB

With corrosion-resistant stainless steel heating bowl to protect against leaking liquid resulting of a broken flask.

SAF Wärmetechnik

- increased working safety in the lab
- plastic-coated, chemically resistant metal housing
- predrilled threaded hole on rear allows to fix the stativ clamp
- 2 heating zones
- with built-in controller allows a continuous adjustment of power outlet
- thermally insulated and earthed
- with built-in heating zone switch and residual current detection (RCD)

Capacity	Flask diam.	Rating	Heating zones	PK	Cat. No.
ml	mm	W			
250	85	150	2	1	6.310 317
500	105	200	2	1	6.310 318
1000	131	300	2	1	6.310 319
2000	166	500	2	1	6.310 320

3

3

Electronic multi-size heating mantles, spill-proof, EMX series

Solid stainless steel liner, which protects against fluid spills and is easy to clean, with central aperture to accommodate round-bottom and pear-shaped flask and 60° funnels. Polypropylene outer case is resilient and chemically-resistant. Highly efficient in heating up to an element temperature of 450 °C. Even at full power output, the exterior remains "cool-to-touch" due to good heating element insulation. All heating mantles have support clamp for rods of up to 12 mm diameter, and are double fused, with earth (ground) screen to protect the user from electric shocks. Available as 220-240 V 50/60 Hz models; spare heater cartridges are available on request.

Electrothermal

For round bottom flasks, pear-shaped flasks and 60° funnels (Mantle is open at the bottom).

For flasks	Width	Depth	Height	Power	PK	Cat. No.
ml	mm	mm	mm	W		
500 - 1000	238	310	145	240	1	9.643 081
2000 - 5000	350	400	190	600	1	9.643 083

4

4

Electronic multi-size heating mantles, V-shaped, EMV series

Solid, with mesh stainless steel liner, which protects against fluid spills, with central aperture to accommodate round-bottom and pear-shaped flask and 60° funnels. Polypropylene outer case is resilient and chemically-resistant. Highly efficient in heating up to a maximum element temperature of 450°C. Even at full power output, the exterior remains "cool-to-touch" due to good heating element insulation. All heating mantles have support clamp for rods of up to 12 mm diameter, and are double fused, with earth (ground) screen to protect the user from electric shocks. Available as 220-240 V 50/60 Hz models; spare heater cartridges are available on request.

Electrothermal

For round bottom flasks, pear-shaped flasks and 60° funnels (Mantle is open at the bottom).

For flasks	For funnel diam.	Dimensions (W x D x H)	Power	PK	Cat. No.
ml	mm	mm	W		
10 to 50	50 to 100	175 x 260 x 127	60	1	9.643 072
100 to 250	75 to 100	175 x 260 x 127	150	1	9.643 073
500 to 1000	100 to 200	238 x 310 x 145	300	1	9.643 074
2000 to 5000 *	200 to 300	350 x 400 x 190	800	1	9.643 075

* With 2 circuits, 1 x 300, 1 x 500 W.

1 Heating mantles Electrothermal® CMUV NEW

Heating mantle has a "V"-shaped design for large, pear-shaped and round-bottom flasks. *Electrothermal*
 The bottom opening allows 60° funnels of various diameters to be accommodated.
 Coiled heating element provides optimal heat transfer. Control heat throughout the mantle using three separate electrical circuits (top, middle, and bottom), each controlled with its own dial switch.

- Cool-to-the-touch design with powder-coated aluminium casing
- Indicator lamps for "power on" and "heat on" operation

Scope of supply: Heating mantle, three sets of integrated support rod clamps, power cords with UK and EU plugs

Specifications

Max. working temperature: 450 °C
 Dimensions (W x D x H): 485 x 485 x 300 mm
 Power supply: 230 V, 50/60 Hz

Type	For flasks ml	PK	Cat. No.
CMUV10/CL	10000	1	6.282 660
CMUV20/CL	20000	1	4.672 211
CMUV22/CL	22000	1	4.011 144



2 Stirring heating mantles LabHEAT® KM-MER series

LabHEAT® - Heating mantles for flasks, round bottom. Designed and technical identical *SAF Wärmetechnik*
 to series KM-ME, but **in addition equipped with a magnetic stirrer**;
 rotational frequency up to 1600 rpm max. heating element temperature 450 °C,
 1.5 m power supply (earthed) cable and RCD (residual current detection);
 nominal voltage 230 V AC.

Capacity ml	Flask diam. mm	Rating W	Heating zones	PK	Cat. No.
100	64	100	1	1	9.642 545
250	85	150	2	1	9.642 546
500	105	200	2	1	9.642 547
1000	131	300	2	1	9.642 548

Serial heating units and Heating mantles with other specifications available on request.



3 Electronic stirrer mantles, EMA series

Built-in adjustable heater control up to an element temperature of 450 °C and magnetic *Electrothermal*
 stirring control up to approx. 520 rpm with auto-reverse facility and automatic stirrer bar trap; the stirrer unit has an independent power supply. Polypropylene outer case is resilient and chemically-resistant. Even at full power output, the exterior remains "cool-to-touch" due to good heating element insulation. All heating mantles have support clamp for rods of up to 12 mm diameter, and are double fused, with earth (ground) screen to protect the user from electric shocks. Available as 220-240 V 50/60 Hz models; spare heater cartridges are available on request.

For flasks ml	Width mm	Depth mm	Height mm	Power W	PK	Cat. No.
50	175	260	133	80	1	9.643 122
100	175	260	133	80	1	9.643 123
250	175	260	133	170	1	9.643 124
500	238	310	157	220	1	9.643 125
1000	238	310	157	320	1	9.643 126
2000	350	400	197	520	1	9.643 127



4 Support clamp KM-SK

LabHEAT®-Accessories for metal-cased heating mantles and serial heating unit to *SAF Wärmetechnik*
 fix support rods up to diameter 12 mm or to integrate the metal-cased heating mantles within support wall.

Type	PK	Cat. No.
KM-SK	1	9.642 630



Heating/Heating mantles

1



1 Glass fibre-insulated heating tapes series KM-HT-BS30

LabHEAT®-Heating tapes. No protection against ingress of water; with inner metal protective braiding and glass fibre insulation; product dimensions 30 x 5 mm; min. bending radius > 15 mm; max. heating element temperature 450 °C; preterminated with 1.0 m cold end; nominal voltage 230V AC.

SAF Wärmetechnik

Length cm	Heating power W	PK	Cat. No.
50	125	1	9.642 720
100	250	1	9.642 721
150	375	1	9.642 722
200	500	1	9.642 723
250	625	1	9.642 724
300	750	1	9.642 725
400	1000	1	9.642 726
500	1250	1	9.642 727
700	1500	1	9.642 728
1000	2000	1	9.642 729

Other lengths and other specifications available on request.

2



2 Glass fibre-insulated heating cables series KM-HC-G

LabHEAT®-Heating cables. No protection against ingress of water; glass fibre insulation without protective braiding; outer diameters dia. 3.5 to 4.5 mm; min. bending radius > 5 mm; max. heating element temperature 450 °C; preterminated with 2 x 1.5 m cold end; nominal voltage 230 V AC.

SAF Wärmetechnik

Length cm	Heating power W	PK	Cat. No.
50	75	1	9.642 750
100	150	1	9.642 751
150	225	1	9.642 752
200	300	1	9.642 753
250	375	1	9.642 754
300	450	1	9.642 755
400	600	1	9.642 756
500	750	1	9.642 757
600	900	1	9.642 758

Other lengths and other specifications available on request.

3



3 Power controller KM-L116 for heating mantles

LabHEAT®-regulator for heating mantles. Electromechanical; infinitely variable control over power outlet; plastic housing (H x W x D) 55 x 65 x 120 mm; switching power max. 2990 W (13 A); 1.5 m power supply (earthed) cable with plug.

SAF Wärmetechnik

Type	PK	Cat. No.
KM-L116	1	9.642 660

4



4 Laboratory regulator series KM-RX1000

LabHEAT®-regulator. Freely configurable electronic temperature regulator with two displays indicating the desired and actual values. PID self-optimisation, with ramp function, USB port, for external configuration. Pt-100 or thermocouples for temperatures up to 1200 °C, metal housing (H x W x D) 75 x 205 x 140 mm with fixed support clamp, switching power max. 2300 W (10A), 1.5 m power supply (earthed) cable with plug. Nominal voltage 230 V AC.

SAF Wärmetechnik

Type	Description	Sensor / Alarm connection	PK	Cat. No.
KM-RX 1001	Laboratory regulator	Socket / Socket	1	7.619 815
KM-RX 1004	Laboratory regulator	Clamps / Clamps	1	9.642 654

7. Heating and cooling technology

Heating/Heating mantles-Temperature controllers, thermostats

1 Temperature sensors for Laboratory regulator series KM-RX

LabHEAT®-sensors. Suitable for temperature control and KM-KM-RX1001 RX1004 with permanently attached cable, with or without diode plug.

SAF Wärmetechnik

KM-TP2: Pt100, up to 400 °C, sheathed element V2A, dia. 4 x 50 mm,
 KM-TPG: Pt100, up to 250 °C, glass tube, dia. 6 x 40 0mm,
 KM-TNS: NiCr-Ni, up to 1200 °C, rod sensor in Inconell, dia. 1.5 x 300 mm
 KM-TNF: NiCr-Ni, up to 400 °C, flat sensor, 0.4 x 15 x 400 mm

Type	For	Length m	Description	PK	Cat. No.
KM-TP2	KM-RX1001	2.0	with diode plug	1	7.619 816
KM-TPG	KM-RX1001	1.5	with diode plug	1	9.642 674
KM-TNS	KM-RX1001	2.0	with diode plug	1	6.237 998
KM-TNF	KM-RX1001	1.5	with diode plug	1	6.236 355
KM-TP2	KM-RX1004	2.0	without diode plug	1	9.642 672
KM-TPG	KM-RX1004	1.5	without diode plug	1	9.642 673
KM-TNS	KM-RX1004	2.0	without diode plug	1	9.642 671
KM-TNF	KM-RX1004	1.5	without diode plug	1	9.642 670

Further models available on request.



2 Power controller, Voltron 20

Alternating current resistance controller with interference suppressor for variable, no-power-loss control of hotplates, heating tapes, soldering irons, light bulbs, infrared radiators etc., control range 25 V to 225V. With single throw on/off potentiometer and shielded fuse holder for safe fuse replacement away from the internal circuit. Fitted with interference suppressor in accordance with EN standard.

Type	Power W	PK	Cat. No.
Voltron 20	2000	1	9.725 094



3 Temperature controllers, TEMPAT®-D

For controlling temperature of heating coils, hotplates, ovens, infrared radiators and water baths. TEMPAT®-D has a 10 mm high, LED display which can even be seen in dark rooms and allows monitoring of actual temperature at any time. Set point can be entered via a 3 or 4 figure coding switch with 1 °C resolution. Built-in sensor breakdown fuse, switching interval display and Xp trimmer to adjust variable gain amplification between 0 and 10 K. Sensor connection is via a plug-in socket.

Appropriate temperature sensor please order separately.

If no temperature sensor is ordered, a loose plug is supplied.

Specifications

Input: 230 V, 50/60 Hz
 Switching capacity: 2300 W, 10A
 Connection, appliance: 1.20M long connection cable with impact resistant plug
 Consumer load: earthed schuko socket, other plug-in connections in accordance with Swiss or French/Belgian standards, for example can be supplied at additional cost.
 Housing: Polycarbonate plastic, gray
 Dimensions: 188 mm x 110 mm x 70 mm
 On/off switch: via dipole luminous rocker switch
 Probe connection: via socket
 Contact assignment Pt100: 1 and 2
 Contact load: 1 + 3
 Accuracy: ±1 % from measuring range value



For	Temp. range °C	PK	Cat. No.
Probe Pt100	0 ... 400	1	9.725 381
Probe Fe-CuNi	0 ... 600	1	9.725 382
Probe NiCr-Ni	0 ... 1200	1	9.725 383

4 Probe for temperature controllers, TEMPAT®

All probes with 2m connecting cable and plug.

Type	Diam. mm	Length mm	PK	Cat. No.
Probe Pt100	1.6*	250	1	9.725 320
Probe Pt100	2.0*	250	1	9.725 321
Probe Pt100	3.0*	250	1	7.601 585
Glass-probe Pt100	2.5	250	1	9.725 322
Glass-probe Pt100	3.0	250	1	9.725 323
Probe Fe-CuNi	1.5**	250	1	9.725 394
Probe NiCr-Ni	1.5**	250	1	9.725 395

* probe tube stainless steel 4301.

**mantle of austenitic stainless steel.





1 Power controller, VOLTRON-PLUS F

Alternating current controller for variable and no-loss control of resistive and inductive power devices with the following additional features:

- On/off luminous rocker switch, dipole switching, 10 A (4)
- IC controlled, hysteresis free
- Quiet running
- Anti-interference grade N
- Fast-blow fuse
- Protected fuse holder
- Power-on indicator lamp

Specifications

Voltage:	220-235 V, 50/60 Hz
Switching capacity:	Max. 2000 VA
Switching current:	Max. 10A
Electronics:	Phase controls
Regulating range:	0 to 235 V a.c.
Dimensions:	150 x 80 x 55 mm
Weight:	0.7 kg

Type	PK	Cat. No.
VOLTRON-PLUS F	1	9.725 363



2 Microwave SEVERIN MW 7875, silver/black

- wattage: approx. 700 W
- interior capacity: approx. 20 l
- power continuously variable, (by time or weight)
- 30 minute timer with acoustic signal
- turntable dia. approx. 24.5 cm
- heat resistant housing
- Dimensions (W x D x H) : 452 x 352 x 262 mm

Rating W	Colour	PK	Cat. No.
700	silver/black	1	4.658 443



3 Microwave Severin MW 7873

- wattage: approx. 900 W
- interior capacity: approx. 30 l
- interior height: approx. 210 mm, suitable for 800 ml Erlenmeyer flask
- turntable dia. approx. 315 mm
- Dimensions (W x D x H) : 510 x 430 x 305 mm
- 5 steps selectable
- power continuously variable, (by time or weight)
- 35 minute timer with acoustic signal

Type	PK	Cat. No.
Severin MW 7873	1	7.672 991



Universal drying oven LLG-uniOVEN 42 and LLG-uniOVEN 110

1

Microprocessor controlled universal drying oven with **forced convection** including two shelves. Each shelf of the uniOVEN 42 and uniOVEN 110 has a load capacity of 20 kg, the total load capacity of each unit is 50 kg. The maximum number of shelves is 7 for uniOVEN 42 and 10 for uniOVEN 110 with a distance of 40 mm between shelves.

- Quick and intuitive operation
- Microprocessor control with integrated auto-diagnostic system
- Forced convection with fan
- Digital display for time and temperature
- **Timer:** 1 minute to 99.9 h and continuous
- Delayed start timer: 1 minute to 99.9 h
- Outlet for vapour exhaustion
- Acoustical and visible information for end of program
- Acoustical and optical alarm at temperature differences
- Interior made of stainless steel
- Adjustable over temperature protection at 300 °C

Scope of supply: LLG-uniOVEN incl. 2 shelves

Specifications	LLG-uniOVEN 42 // LLG-uniOVEN 110
Internal volume:	42 l // 110 l
Temperature range:	50 ... 250 °C
Temperature accuracy:	±1 °C (at 70 °C)
Temperature uniformity:	±2 °C (at 70 °C)
Permissible ambient temperature:	5 ... 40 °C
Permissible relative moisture:	80 %, not condensing
Dimensions (W x D x H):	420 x 280 x 360 // 500 x 445 x 500 mm
Weight:	39 kg // 66 kg
Power supply:	230 V, 50/60 Hz
Warranty:	3 years



6.263 670

2



6.263 675

Type	Nom. capacity	Internal dimensions (W x D x H) mm	External dimensions (W x D x H) mm	Rated capacity kW	Plug type	PK	Cat. No.
LLG-uniOVEN 42	42	420 x 280 x 360	705 x 505 x 540	0.85	EU	1	6.263 670
LLG-uniOVEN 42	42	420 x 280 x 360	705 x 505 x 540	0.85	UK	1	6.263 673
LLG-uniOVEN 110	110	500 x 445 x 500	790 x 665 x 680	1.55	EU	1	6.263 675
LLG-uniOVEN 110	110	500 x 445 x 500	790 x 665 x 680	1.55	UK	1	6.263 678

Accessories for Universal drying ovens LLG-uniOVEN 42/110

Description	PK	Cat. No.
Shelf for LLG-uniOVEN 42	1	6.263 671
Shelf carrier for LLG-uniOVEN 42	2	6.263 672
Shelf for LLG-uniOVEN 110	1	6.263 676
Shelf carrier for LLG-uniOVEN 110	2	6.263 677

3 Drying oven E28 series

3

Robust, space-saving, low-profile ovens with mechanical and adjustable chamber ventilation.

BINDER

- Temperature range: 60 to 230 °C
- Hydraulic thermostat temperature control
- Adjustable exhaust air flap
- Timer 0 to 120 min
- Available with, or without, TB (Class 1)
- Power supply 230 V, 50/60 Hz

The number of shelves included in the scope of delivery is listed in the table.



Type	Nom. capacity	Max. grids	Included grids	Internal dimensions (W x D x H) mm	External dimensions (W x D x H) mm	Rated capacity kW	PK	Cat. No.
E 28	28	4	2	400 x 250 x 280	580 x 425 x 405	0.8	1	9.883 543
E 28*	28	4	2	400 x 250 x 280	580 x 425 x 405	0.8	1	9.883 544

* with TB (Class 1)

1 Universal Ovens UN/UF and UNplus/UFplus

The all-round genius among heating ovens covers a multitude of applications, ideally at temperatures above +50 °C. The fresh air is preheated in the pre-heating chamber to avoid temperature fluctuations.

Memmert

Specifications

Type designation:	N = Natural convection F = Forced air circulation plus = TwinDISPLAY
Working temperature range:	at least 5 °C (UN/UNplus) or 10 °C (UF/UFplus) above ambient to +300 °C
Setting temperature range:	+20 to +300 °C
Setting accuracy:	up to 99.9 °C: 0.1 °C/from 100 °C: 0.5 °C
Power supply:	230 V, 50/60 Hz (sizes 30 - 260) 400 V (sizes 450 - 1060)

Universal Ovens UN and UF

SingleDISPLAY: ControlCOCKPIT with one colour display

Memmert

You can find a detailed description of the "SingleDISPLAY" model at www.memmert.com

Type	Nom. capacity	Max. grids	Included grids	Internal dimensions (W x D x H) mm	External dimensions (W x D x H) mm	Rated capacity	Net weight	PK	Cat. No.
	L					kW	kg		
UN30	32	3	1	400 x 250* x 320	585 x 434** x 704	1.6	45	1	9.869 681
UN55	53	4	1	400 x 330* x 400	585 x 514** x 784	2.0	57	1	9.869 682
UN75	74	6	2	400 x 330* x 560	585 x 514** x 944	2.5	66	1	9.869 683
UN110	108	5	2	560 x 400* x 480	745 x 584** x 864	2.8	74	1	9.869 684
UN160	161	8	2	560 x 400* x 720	745 x 584** x 1104	3.2	96	1	9.869 685
UN260	256	9	2	640 x 500* x 800	824 x 684** x 1183	3.4	110	1	9.869 686
UN450	449	8	2	1040 x 600* x 720	1224 x 784** x 1247	5.8	161	1	9.869 687
UN750	749	14	2	1040 x 600* x 1200	1224 x 784** x 1720	7.0	217	1	9.869 688
UF30	32	3	1	400 x 250* x 320	585 x 434** x 704	1.6	45	1	9.869 697
UF55	53	4	1	400 x 330* x 400	585 x 514** x 784	2.0	57	1	9.869 698
UF75	74	6	2	400 x 330* x 560	585 x 514** x 944	2.5	66	1	9.869 699
UF110	108	5	2	560 x 400* x 480	745 x 584** x 864	2.8	74	1	9.869 700
UF160	161	8	2	560 x 400* x 720	745 x 584** x 1104	3.2	96	1	9.869 701
UF260	256	9	2	640 x 500* x 800	824 x 684** x 1183	3.4	110	1	9.869 702
UF450	449	8	2	1040 x 600* x 720	1224 x 784** x 1247	5.8	161	1	9.869 703
UF750	749	14	2	1040 x 600* x 1200	1224 x 784** x 1720	7.0	217	1	9.869 704
UF1060	1060	14	1	1040 x 850* x 1200	1224 x 1035** x 1720	7.0	252	1	6.266 314

* Less 39 mm for fan

**Depth without door handle, please add 56 mm

1



9.869 695

2



9.869 697

Universal Ovens UNplus and UFplus

TwinDISPLAY: ControlCOCKPIT with two colour displays

Memmert

You can find a detailed description of the "TwinDISPLAY" model at www.memmert.com

Type	Nom. capacity	Max. grids	Included grids	Internal dimensions (W x D x H) mm	External dimensions (W x D x H) mm	Rated capacity kW	Net weight kg	PK	Cat. No.
	L								
UN30plus	32	3	1	400 x 250* x 320	585 x 434** x 704	1.6	45	1	9.869 689
UN55plus	53	4	1	400 x 330* x 400	585 x 514** x 784	2.0	57	1	9.869 690
UN75plus	74	6	2	400 x 330* x 560	585 x 514** x 944	2.5	66	1	9.869 691
UN110plus	108	5	2	560 x 400* x 480	745 x 584** x 864	2.8	74	1	9.869 692
UN160plus	161	8	2	560 x 400* x 720	745 x 584** x 1104	3.2	96	1	9.869 693
UN260plus	256	9	2	640 x 500* x 800	824 x 684** x 1183	3.4	110	1	9.869 694
UN450plus	449	8	2	1040 x 600* x 720	1224 x 784** x 1247	5.8	161	1	9.869 695
UN750plus	749	14	2	1040 x 600* x 1200	1224 x 784** x 1720	7.0	217	1	9.869 696
UF30plus	32	3	1	400 x 250* x 320	585 x 434** x 704	1.6	45	1	9.869 705
UF55plus	53	4	1	400 x 330* x 400	585 x 514** x 784	2.0	57	1	9.869 706
UF75plus	74	6	2	400 x 330* x 560	585 x 514** x 944	2.5	66	1	9.869 707
UF110plus	108	5	2	560 x 400* x 480	745 x 584** x 864	2.8	74	1	9.869 708
UF160plus	161	8	2	560 x 400* x 720	745 x 584** x 1104	3.2	96	1	9.869 709
UF260plus	256	9	2	640 x 500* x 800	824 x 684** x 1183	3.4	110	1	9.869 710
UF450plus	449	8	2	1040 x 600* x 720	1224 x 784** x 1247	5.8	161	1	9.869 711
UF750plus	749	14	2	1040 x 600* x 1200	1224 x 784** x 1720	7.0	217	1	9.869 712
UF1060plus	1060	14	1	1040 x 850* x 1200	1224 x 1035** x 1720	7.0	252	1	9.869 713

* Less 39 mm for fan

**Depth without door handle, please add 56 mm

Suitable accessories can be found in our online shop.

1



9.869 708

2 3 Heating ovens, ED, FD, FED series - Classic.Line

Diversity for all types of thermal, whether efficient drying, long-term controlled elevated temperatures or sterilization tasks for homogeneous temperature distribution: a BINDER oven and heating chamber is up to any tasks thanks to its wide temperature range.

ED Series: Drying ovens with gravity convection.

FD Series: Drying ovens with forced convection.

FED Series: Heating chambers with forced convection and enhanced timer functions.

Equipment:

- Temperature range from 5°C above ambient temperature to 300 °C
- Independent adjustable temperature safety device class 2 (DIN 12880), with visual temperature alarm
- Optional RS 422 Interface for APT-COM™ Data Control System communication software

The number of shelves included in the scope of delivery is listed in the table.

BINDER



3



Type	Nom. capacity	Max. grids	Included grids	Internal dimensions (W x D x H) mm	External dimensions (W x D x H) mm	Rated capacity kW	Type of auxiliary energy	PK	Cat. No.
	L								
ED 23	20	4	2	222 x 300 x 330	435 x 520 x 495	0.8	230 V, 50/60 Hz	1	9.883 529
ED 23	20	4	2	222 x 300 x 330	435 x 520 x 495	8.0	230 V, 50/60 Hz	1	9.883 530
ED 400	400	10	2	1000 x 520 x 800	1235 x 765 x 1025	3.4	400 V, 50/60 Hz	1	9.883 551
FD 23	20	4	2	222 x 300 x 330	435 x 520 x 495	0.8	230 V, 50/60 Hz	1	9.883 808
FED 400	400	10	2	1000 x 510 x 800	1235 x 765 x 1025	3.4	400 V, 50/60 Hz	1	9.883 803

* with RS 422



1 Heating ovens ED-S/FD-S Solid.Line

For drying and heating in research and quality control.
With ramp function, optical temperature alert and delayed power-off.

BINDER

- APT.line™ preheating chamber technology
- Natural convection with homogenous temperature distribution
- Adjustable exhaust air flap
- Digital controller with timer
- Easy and ergonomical door opening
- Class 2 integrated independent adjustable temperature safety device (DIN 12880) with visual alarm

Scope of delivery: Heating oven, 1 chrome plated rack incl. shelf supports

Heating oven ED-S 56 Solid.Line with natural convection

With natural convection for homogenous temperature distribution.

BINDER

Specifications

Temperature range:	RT + 10 °C ... 250 °C
Temperature variation at 150 °C:	±2.8 °C
Heating-up time to 150 °C:	60 min
Permitted load:	30 kg
Weight:	38 kg
Power supply:	230 V, 50/60 Hz

Type	PK	Cat. No.
ED-S 56	1	4.665 042

Heating oven ED-S 115 Solid.Line with natural convection



With natural convection for homogenous temperature distribution.

BINDER

Specifications

Temperature range:	RT + 7 °C ... 250 °C
Temperature variation at 150 °C:	±2.8 °C
Heating-up time to 150 °C:	55 min
Interior volume:	118 l
Internal dimensions:	550 x 390 x 550 mm
External dimensions:	745 x 565 x 735 mm
Permitted load:	75 kg
Max. shelves:	5
Weight:	54 kg
Power supply:	230 V, 50/60 Hz

Type	PK	Cat. No.
ED-S 115	1	4.667 816

Heating oven FD-S 56 Solid.Line with forced convection

With forced convection for homogenous temperature distribution.

BINDER

Specifications

Temperature range:	RT + 10 °C ... 250 °C
Temperature variation at 150 °C:	±2.6 °C
Heating-up time to 150 °C:	20 min
Permitted load:	30 kg
Weight:	38 kg
Power supply:	230 V, 50/60 Hz

Type	PK	Cat. No.
FD-S 56	1	4.665 196

Heating oven FD-S 115 Solid.Line with forced convection



With forced convection for homogenous temperature distribution.

BINDER

Specifications

Temperature range:	RT + 10 °C ... 250 °C
Temperature variation at 150 °C:	±2.4 °C
Heating-up time to 150 °C:	22 min
Interior volume:	106 l
Internal dimensions:	550 x 350 x 550 mm
External dimensions:	745 x 565 x 735 mm
Permitted load:	75 kg
Max. shelves:	5
Weight:	54 kg
Power supply:	230 V, 50/60 Hz

Type	PK	Cat. No.
FD-S 115	1	4.665 522

1 Heating ovens, ED, FD, FED series - Avantgarde.Line

The drying chambers with natural convection (Type designation ED) or forced convection (Type designation FD, FED) are renowned due to their new design, convenient operation, and efficiency. The latest APT.line™ technology offers outstanding temperature accuracy.

BINDER



Equipment:

- Temperature range series ED: room temperature plus 5-6 °C to 300 °C
- Temperature range series FD, FED: room temperature plus 10 °C to 300 °C
- Controller with LCD display
- Electromechanical control of the exhaust air flap
- Class 2 independent temperature safety device (DIN 12880) with visual temperature alarm
- USB port for recording data

The number of shelves included in the scope of delivery is listed in the table.

Type	Nom. capacity	Max. grids	Included grids	Internal dimensions (W x D x H) mm	External dimensions (W x D x H) mm	Rated capacity kW	Type of auxiliary energy	PK	Cat. No.
	L								
ED 56	57	4	2	360 x 380 x 420	560 x 565 x 625	1.05	230 V, 50/60 Hz	1	4.658 061
ED 115	114	5	2	510 x 425 x 530	710 x 605 x 735	1.25	230 V, 50/60 Hz	1	4.658 059
ED 260	260	8	2	610 x 550 x 760	810 x 760 x 965	2.25	230 V, 50/60 Hz	1	6.280 292
FD 56	60	4	2	400 x 345 x 440	560 x 565 x 625	1.10	230 V, 50/60 Hz	1	6.280 069
FD 115	116	5	2	550 x 385 x 550	710 x 605 x 735	1.30	230 V, 50/60 Hz	1	4.658 060
FD 260	260	8	2	650 x 515 x 780	810 x 760 x 965	2.30	230 V, 50/60 Hz	1	6.280 362
FD 720	741	16	2	1000 x 570 x 1300	1165 x 870 x 1590	4.50	400 V, 50/60 Hz	1	6.291 250
FED 56	60	4	2	400 x 345 x 440	560 x 565 x 625	1.10	230 V, 50/60 Hz	1	6.280 295
FED 115	116	5	2	550 x 385 x 550	710 x 605 x 735	1.30	230 V, 50/60 Hz	1	6.280 284
FED 260	260	8	2	650 x 515 x 780	810 x 760 x 965	2.30	230 V, 50/60 Hz	1	6.280 296
FED 720	741	16	2	1000 x 570 x 1300	1165 x 870 x 1590	4.50	400 V, 50/60 Hz	1	4.668 970

2 3 Accessories for incubators, drying and heat chambers

Insert grids and shelves, chrome-plated or stainless steel.

BINDER

Type	For	PK	Cat. No.
Shelves, perforated	BF 56, FD 56, MKF 56, MK 56, FED 56	1	6.272 895
Shelves, perforated, stainless steel	BD 56, ED 56	1	6.290 544
Shelves, perforated, stainless steel	FD 115, FED 115, BF 115	1	6.313 969
Shelves, perforated, stainless steel	KBF-S 240, KBF P 240, KBF LQC 240, KBWF 240, KB 400, KB 240, KBF 240, KMF 240, KBW 400, KBW 240	1	6.233 078
Shelves, perforated, stainless steel	FP 720, M 720	1	6.242 769
Shelves, perforated, stainless steel	KMF 720, KB 720, KBF P 720, KBF LQC 720, KBF-S 720, KBF 720, KBWF 720, KBW 720	1	6.237 182
Shelves, perforated, stainless steel	KBF 1020, KBF-S 1020	1	6.312 312
Insert grids, chrome-plated	BF 56, FD 56, FED 56	1	6.280 337
Insert grids, chrome-plated	BD 115, ED 115	1	6.283 062
Insert grids, chrome-plated	FD 115, FED 115, BF 115	1	6.287 278
Insert grids, chrome-plated	FP 115, M 115, FDL 115	1	6.901 132
Insert grids, chrome-plated	ED 260, BD 260	1	4.664 397
Insert grids, chrome-plated	FED 260, BF 260, FD 260	1	6.270 116
Insert grids, chrome-plated	BF 400, BD 400, FP 400, ED 400, FED 400, M 400	1	6.223 529
Insert grids, chrome-plated	BF 720, FD 720, FED 720	1	6.291 569
Insert grids, chrome-plated	FP 720, M 720	1	6.510 242
Insert grids, stainless steel	MKT 115, KB 115, FP 115, MK 115, MKF 115, M 115, MKFT 115, FDL 115	1	6.059 089
Insert grids, stainless steel	M 240, FP240	1	6.058 638
Insert grids, stainless steel	KBF-S 240, KBF P 240, KBF LQC 240, KBWF 240, KB 400, KB 240, KBF 240, KBW 400, KBW 240, KMF 240	1	6.206 325
Insert grids, stainless steel	FED 260, BF 260, FD 260	1	6.314 255
Insert grids, reinforced, stainless steel	FP 720, M 720	1	6.240 557
Insert grids, stainless steel	BF 720, FD 720, FED 720	1	6.275 805
Insert grids, stainless steel	ED 720, BD 720	1	6.313 789

2



3



DryingOven 125 basic dry/control dry

Powerful drying cabinets with rapid heating and exact temperature regulation guarantees reproducible results. Thanks to its high quality insulation, the device has a very large interior of 125L in relation to its total volume. This structure also reduces odour emissions, operating costs, and ensures excellent temperature uniformity.

IKA

- Oven basic dry with natural convection up to 250 °C
- Oven control dry with recirculating air up to 300 °C
- Electronically adjustable ventilation
- Clear LED display and control menu
- Key lock function
- Timer from 1 minute up to 100 days
- Adjustable temperature limit
- USB Interface
- For up to 6 shelves
- Interior made of stainless steel
- Also available with glass door
- Door opening possible up to max. 180°



Additional features Oven 125 control dry:

- Recirculating air drying cabinet with automatic fan switch-off
- Recirculating air adjustable in 10 steps
- Real-time clock
- Temperature selection limited TWB (DIN 12880)
- Illuminated interior
- Cable bushing at the rear for measurements inside the oven
- RS 232 Interface
- Direct saving of data on USB stick
- Interface for additional temperature sensor (display and control possible)
- 2 large TFT Displays

Scope of supply: Oven with 2 shelves and calibration certificate at 160 °C.

Specifications

Internal volume:	basic dry // control dry 125 l
Ambient temperature:	5 ... 40 °C
Working temperature:	RT+ 5 ... 250 °C // RT+ 5 ... 300 °C
Adjustment and display resolution:	0.1 K
Temperature stability (150 °C):	±0.3 K
Ambient humidity:	80 %
Heating power:	2400 W
Outer Dimensions (W x D x H):	700 x 650 x 825 mm
Inner Dimensions (W x D x H):	550 x 525 x 450 mm
Weight:	55 kg // 82 kg
Power supply:	230 V, 50/60 Hz
Protection class:	IP 20

Type	Nom. capacity	Max. grids	Included grids	Internal dimensions (W x D x H) mm	External dimensions (W x D x H) mm	Rated capacity kW	PK Cat. No.
	L						
Oven basic dry	125	6	2	550 x 525 x 450	700 x 650 x 825	2.45	1 6.289 337
Oven basic dry - glass	125	6	2	550 x 525 x 450	700 x 650 x 825	2.45	1 6.289 338 
Oven control dry	125	6	2	550 x 525 x 450	700 x 650 x 825	2.45	1 4.663 261 
Oven control dry - glass	125	6	2	550 x 525 x 450	700 x 650 x 825	2.45	1 4.663 262



6.289 338



4.663 261

1 Ovens Heratherm™

1

The series provide bench-top models with 60, 100 or 180 l as well as floor models with 400 or 750 l chamber volume and 3 different fittings, each optionally with gravity or mechanical convection.

Thermo Scientific

- Very high energy efficiency, environmentally friendly materials (reduced use of formaldehyde), reduced heat emission
- Programmable timer
- Small footprint
- Flexible shelf system doubles the number of shelves and therefore the footprint
- Very good spatial and temporal temperature stability
- Automatic visual and acoustic over-temperature alarm
- Very low temperatures at outer wall
- Easy to read vacuum fluorescent display
- Intuitive user interface for setting temperature
- Easy cleaning due to edgeless fabrication



Heratherm™ General Protocol:

Perfect for routine daily work from 10 to 250 °C. Chambers made from corrosion-resistant st. steel with rounded corners. Timer, mechanical exhaust vent as well as 2 shelves are incl. as standard.

Heratherm™ Advanced Protocol:

For a greater flexibility and accuracy of temperature values. With V2A st. steel interior, works up to 330 °C at highly stable temperatures. Digital timer for daily or weekly On/OFF cycles. Up to 10 cycles can be stored and combined as ramps. Fan speed and air valve can be integrated into ramp programming. Selectable quick start function allows for extremely fast heating.

Specifications

Power supply: 230 V, 60 Hz

Temperature range: 10 to 250 °C (General Protocol/Advanced Protocol floor models)

10 to 330 °C (Advanced Protocol benchtop models/Advanced Protocol Security)

2 Heratherm™ General Protocol Ovens

2

Thermo Scientific™ Heratherm™ General Protocol ovens are perfect for routine daily work, providing the ideal heating and drying solution for your applications.

Thermo Scientific

- Low energy consumption
- Built in timer
- Excellent footprint/volume ratio
- Tabletop models in 3 sizes (60 L, 100 L, 180 L), floor models in 2 sizes (400 L, 750 L)
- Inner chambers made from corrosion-resistant stainless steel with rounded corners for easy cleaning
- Large, easy to view vacuum fluorescent display
- Simple, microprocessor-based touch button controls
- Doors can be opened over 180° making these units easy to access
- Automatic overtemperature alarm system to protect samples
- Gravity convection units (Type designation OGS) are designed to protect delicate samples while offering temperature uniformity of ±4 °C with temperature stability of ±0.4 °C at 150 °C
- Mechanical convection models (Type designation OM) provide a temperature uniformity of ±3.3 °C with temperature stability of ±0.3 °C at 150 °C
- The exhaust vent can be used as an access port for an external temperature sensor
- Lockable casters for easy mobility and stability (floor models only)
- All Heratherm™ ovens come standard with a RS232 data interface



The number of shelves included in the scope of delivery is listed in the table.

Type	Nom. capacity	Max. grids	Included grids	Internal dimensions (W x D x H) mm	External dimensions (W x D x H) mm	Rated capacity kW	PK	Cat. No.
	L							
OGS60	65	13	2	328 x 415 x 480	530 x 565 x 720	1.80	1	4.009 206
OGS100	105	16	2	438 x 414 x 580	640 x 565 x 820	3.10	1	4.009 207
OGS180	176	19	2	438 x 589 x 680	640 x 738 x 920	3.10	1	4.009 208
OGS400	419	39	2	544 x 590 x 1307	778 x 770 x 1545	2.40	1	9.534 156
OGS750	774	39	2	1004 x 590 x 1307	1261 x 770 x 1545	3.00	1	9.534 159
OGS750-3/N/PE	774	39	2	1004 x 590 x 1307	1261 x 770 x 1545	6.35	1	9.534 161
OMS60	66	13	2	354 x 368 x 508	530 x 565 x 720	1.40	1	4.009 209
OMS100	104	16	2	464 x 368 x 608	640 x 565 x 820	3.06	1	4.009 210
OMS180	179	19	2	464 x 543 x 708	640 x 738 x 920	3.06	1	4.009 211

1 2 Heratherm™ Advanced Protocol Ovens

As well as incorporating all the benefits of Thermo Scientific™ Heratherm™ General Protocol ovens, the Heratherm™ Advanced Protocol range boasts additional features providing even more flexibility, accuracy and dependability.

Thermo Scientific

- Sophisticated timer extends the automation options available to the user: turn on or off after a pre-set time, choose between a recurring weekly timer or run oven based on the 24 hour clock
- Highest level of temperature uniformity
- Exceptionally low energy consumption - 60 litre models just need 170W (gravity convection) and 275W (mechanical convection) per hour to maintain 150°C
- Adjustable fan speed for application related airflow
- Programmable controller for temperature ramps and dwells (store up to 10 programs with 10 discrete steps, features electronically controlled fan speed and damper position)
- Access port allows the introduction of sensors for independent data monitoring
- A simple calibration routine ensures temperature accuracy over time
- Boost function enables rapid heating up - no need to run the oven 24/7 (tabletop models only)
- Optional stainless steel exterior

The number of shelves included in the scope of delivery is listed in the table.

Specifications

Type designation:

OGH = Natural convection

OMH = Forced air circulation

Temperature range:

10 to 330 °C

Power supply:

230 V/50 Hz

Type	Nom. capacity L	Max. grids	Included grids	Internal dimensions (W x D x H) mm	External dimensions (W x D x H) mm	Rated capacity kW	PK	Cat. No.
OGH60	61	13	2	328 x 389 x 480	530 x 565 x 720	1.80	1	4.009 212
OGH60 SS*	61	13	2	328 x 389 x 480	530 x 565 x 720	1.80	1	4.009 215
OGH100	99	16	2	438 x 389 x 580	640 x 565 x 820	3.10	1	4.009 213
OGH100 SS*	99	16	2	438 x 389 x 580	640 x 565 x 820	3.10	1	4.009 216
OGH180	168	19	2	438 x 564 x 680	640 x 738 x 920	3.10	1	4.009 214
OGH180 SS*	168	19	2	438 x 564 x 680	640 x 738 x 920	3.10	1	4.009 217
OMH60	62	13	2	354 x 343 x 508	530 x 565 x 720	1.40	1	4.009 218
OMH60 SS*	62	13	2	354 x 343 x 508	530 x 565 x 720	1.40	1	4.009 221
OMH100	97	16	2	464 x 343 x 608	640 x 565 x 820	3.06	1	4.009 219
OMH100 SS*	97	16	2	464 x 343 x 608	640 x 565 x 820	3.06	1	4.009 222
OMH180	170	19	2	464 x 518 x 708	640 x 738 x 920	3.06	1	4.009 220
OMH180 SS*	170	19	2	464 x 518 x 708	640 x 738 x 920	3.06	1	4.009 223
OMH400	396	39	2	544 x 545 x 1335	778 x 770 x 1545	3.00	1	9.534 157
OMH400 SS	396	39	2	544 x 545 x 1335	778 x 770 x 1545	3.00	1	9.534 158
OMH750	731	39	2	1004 x 545 x 1335	1261 x 770 x 1545	3.00	1	9.534 162
OMH750 SS	731	39	2	1004 x 545 x 1335	1261 x 770 x 1545	3.00	1	9.534 163
OMH750-3P	731	39	2	1004 x 545 x 1335	1261 x 770 x 1545	5.75	1	9.534 165

*Stainless steel housing.

1



2



1 Heratherm™ Advanced Protocol Security Ovens

1

The Thermo Scientific™ Heratherm™ Advanced Protocol Security portfolio combines the benefits of the Advanced Protocol line with an extra layer of security for applications where process reliability and sample protection are paramount.

Thermo Scientific

Additional security features provide peace of mind for precious samples:

- Auto-dry function deactivates oven when the samples are dry, saving energy (optional sample temperature sensor is required to utilize this feature)
- Standard overtemperature alarm and an additional undertemperature alarm
- Door lock prevents disruption, tampering or accidental opening
- Door alarm notifies the operator when door is left open accidentally
- Socket for independent sample sensor (option): When connected, exact sample temperature is shown on display for additional peace of mind

The number of shelves included in the scope of delivery is listed in the table.



Specifications

Type designation: OGH = Natural convection, OGH = Forced air circulation
 Temperature range: 10 to 330 °C
 Power supply: 230 V/50 Hz

Type	Nom. capacity	Max. grids	Included grids	Internal dimensions (W x D x H) mm	External dimensions (W x D x H) mm	Rated capacity kW	PK	Cat. No.
OGH60-S	61	13	2	328 x 389 x 480	530 x 565 x 720	1.81	1	4.009 224
OGH60-S SS*	61	13	2	328 x 389 x 480	530 x 565 x 720	1.81	1	4.009 227
OGH100-S	99	16	2	438 x 389 x 580	640 x 565 x 820	3.10	1	4.009 225
OGH100-S SS*	99	16	2	438 x 389 x 580	640 x 565 x 820	3.10	1	4.009 228
OGH180-S	168	19	2	438 x 564 x 680	640 x 738 x 920	3.10	1	4.009 226
OGH180-S SS*	168	19	2	438 x 564 x 680	640 x 738 x 920	3.10	1	4.009 229
OMH60-S	62	13	2	328 x 343 x 508	530 x 565 x 720	1.40	1	4.009 230
OMH60-S SS*	62	13	2	328 x 343 x 508	530 x 565 x 720	1.40	1	4.009 233
OMH100-S	97	16	2	438 x 343 x 608	640 x 565 x 820	3.06	1	4.009 231
OMH100-S SS*	97	16	2	438 x 343 x 608	640 x 565 x 820	3.06	1	4.009 234
OMH180-S	170	19	2	464 x 518 x 708	640 x 738 x 920	3.06	1	4.009 232
OMH180-S SS*	170	19	2	464 x 518 x 708	640 x 738 x 920	3.06	1	4.009 235

*Stainless steel housing.

Accessories for Heratherm™ Ovens

Thermo Scientific

For	Description	PK	Cat. No.
OGS60, OGH60, OGH60 SS, OGH60-S, OGH60-S SS	Shelf incl. 2 shelf supports	1	4.009 236
OGS100, OGH100, OGH100 SS, OGH100-S, OGH100-S SS	Shelf incl. 2 shelf supports	1	4.009 237
OGS180, OGH180, OGH180 SS, OGH180-S, OGH180-S SS	Shelf incl. 2 shelf supports	1	4.009 238
OMS60, OMH60, OMH60 SS, OMH60-S, OMH60-S SS	Shelf incl. 2 shelf supports	1	4.009 239
OMS100, OMH100, OMH100 SS, OMH100-S, OMH100-S SS	Shelf incl. 2 shelf supports	1	4.009 240
OMS180, OMH180, OMH180 SS, OMH180-S, OMH180-S SS	Shelf incl. 2 shelf supports	1	4.009 241
OGS60, OGH60, OGH60 SS, OGH60-S, OGH60-S SS, OMS60, OMH60, OMH60 SS, OMH60-S, OMH60-S SS	Kit for stacking 60 L units	1	4.009 246
OGS100, OGH100, OGH100 SS, OGH100-S, OGH100-S SS, OMS100, OMH100, OMH100 SS, OMH100-S, OMH100-S SS	Kit for stacking 100 L units	1	4.009 247
OGS180, OGH180, OGH180 SS, OGH180-S, OGH180-S SS, OMS180, OMH180, OMH180 SS, OMH180-S, OMH180-S SS	Kit for stacking 180 L units	1	4.009 248
OGS60, OGH60, OGH60 SS, OGH60-S, OGH60-S SS, OMS60, OMH60, OMH60 SS, OMH60-S, OMH60-S SS	Support stand with castors	1	4.009 249
OGS100, OGH100, OGH100 SS, OGH100-S, OGH100-S SS, OMS100, OMH100, OMH100 SS, OMH100-S, OMH100-S SS	Support stand with castors	1	4.009 250
OGS180, OGH180, OGH180 SS, OGH180-S, OGH180-S SS, OMS180, OMH180, OMH180 SS, OMH180-S, OMH180-S SS	Support stand with castors	1	4.009 251
OGS750 / OMH750	Wire mesh shelf	1	9.534 167
OMH750 3PH / IMH750-S	Wire mesh shelf	1	9.534 168
400 L Modelle	Silicone-free Viton sealing	1	9.534 171
750 L Modelle	Silicone-free Viton sealing	1	9.534 172

Heating/Vacuum drying incubators

1

1 Vacuum drying ovens VD/VDL series

NEW

BINDER

For gentle, fast drying without residues, incrustations or oxidation.

- Direct heat transfer through large thermal conducting plates
- Program-controlled drying monitoring with automatic ventilation at end of process
- Internal data logger, measured values can be read out in open format via USB
- Inert gas connection
- Shatterproof, spring-mounted safety glass panel
- Large viewing window
- Aluminum expansion racks, can be custom-positioned
- Ethernet interface

Vacuum drying ovens VD:

- Temperature range: RT +10 °C to 220 °C
- For non-flammable solvents
- Controller with digital display of pressure and temperature
- 2 relay outputs, 24 V DC (max. 0.4 A)

Vacuum drying ovens VDL:

- Temperature range: RT +10 °C to 110 °C
- For flammable solvents
- ATEX conformity for units: EX II 2/3/- G IIB T3 Gb/Gc/- X
- Intuitive touchscreen controller with graphical pressure and temperature display
- Pressure control device for heating activated from < 100 mbar

Type	Nom. capacity	Max. grids	Included grids	Internal dimensions (W x D x H) mm	External dimensions (W x D x H) mm	Rated capacity kW	Type of auxiliary energy	PK	Cat. No.
	L								
VD 23	24	4	1	285 x 295 x 285	523 x 413 x 698	0.9	200 ... 230 V, 50/60 Hz	1	4.678 317
VD 56	55	5	1	400 x 343 x 400	638 x 461 x 815	1.4	200 ... 230 V, 50/60 Hz	1	4.678 318
VD 115	119	6	1	506 x 460 x 506	743 x 581 x 942	1.6	200 ... 230 V, 50/60 Hz	1	4.678 319
VDL 23	24	4	2	285 x 295 x 285	523 x 413 x 698	0.9	200 ... 230 V, 50/60 Hz	1	4.678 320
VDL 56	55	5	2	400 x 343 x 400	638 x 461 x 815	1.4	200 ... 230 V, 50/60 Hz	1	4.678 321
VDL 115	119	6	2	506 x 460 x 506	743 x 581 x 942	1.6	200 ... 230 V, 50/60 Hz	1	4.678 322

2

2

LLG-Porcelain evaporating dishes with spout, flat bottom, medium form

Glazed.

Capacity ml	Ext. diam. mm	Height mm	PK	Cat. No.
22	54	22	1	7.970 673
62	70	30	1	6.268 802
93	86	33	1	6.251 474
154	98	40	1	6.253 566
265	112	50	1	6.262 379
330	126	53	1	6.257 949
450	145	55	1	6.269 244
620	151	63	1	6.257 950
800	169	68	1	6.269 245
1200	195	74	1	6.241 820
3000	254	105	1	7.971 013



Vacuum Ovens VO

1

Memmert

Reliable, comfortable and energy-efficient - that's how vacuum drying works today. Separately adjustable and directly heated thermoshelves ensure precise temperature control and, thanks to the digital pressure control, the chamber load is not only dried at high speed but also extremely gently in our powerful and robust vacuum drying oven.

- Safety glass door with armoured glass on the inside and splinter shield on the outside
- Digital pressure control
- Directly heated and individually controllable thermoshelves
- With 2 thermoshelf connections
- Optional: Pump base cabinet and energy-efficient vacuum pump

Model variant TwinDISPLAY: ControlCOCKPIT with two colour displays

You can find a detailed description of the "TwinDISPLAY" model at www.memmert.com

Scope of supply: Vacuum drying oven, 1 aluminium thermoshelf, calibration certificate (for 160 °C at 20 mbar), software AtmoCONTROL



4.663 352

Specifications

Working temperature range:	at least 5 above ambient to +200 °C
Setting temperature range:	20 °C to +200 °C
Setting accuracy:	up to 99.9: 0.1 °C/ from 100: 0.5 °C
Vacuum:	5 to 1100 mbar
Power supply:	230 V, 50/60 Hz

Type	Nom. capacity	Max. shelves	Included shelves	Internal dimensions (W x D x H) mm	External dimensions (W x D x H) mm	Rated capacity kW	Net weight kg	PK	Cat. No.
	L								
VO29	29	1	1	385 x 250 x 305	550 x 400 x 607	0.82	55	1	4.663 352
VO49	49	2	1	385 x 330 x 385	550 x 480 x 687	2.02	83	1	4.663 353
VO101	101	2	1	545 x 400 x 465	710 x 550 x 767	2.42	110	1	4.663 354

Accessories for vacuum ovens VO

Premium module: The premium module comprises the inert gas inlet (only sizes 49/101), extra connectors for thermoshelves, one for VO29, two for VO49/VO101, an additional thermoshelf for model size 49/101.

Memmert

Vacuum pump module: Without pump with antivibration metal plate at the bottom to accommodate the vacuum pump, including full-sight glass door, socket, signal cable and connecting hose to the vacuum oven.

Chemical-resistant vacuum pump: With 4x diaphragm, pump capacity: approx. 50 l/min = 3.0 m³/h, automatic purge control, with signal cable (3 m) to control the rotation speed and vacuum connecting hose (3 m).

Description	For Volume l	PK	Cat. No.
Thermoshelf, aluminium, eloxadised material 3.3547	29	1	9.537 938
Thermoshelf, aluminium, eloxadised material 3.3547	49	1	9.537 939
Thermoshelf, aluminium, eloxadised material 3.3547	101	1	9.537 940
Thermoshelf stainless steel, material 1.4404	29	1	6.071 767
Thermoshelf stainless steel, material 1.4404	49	1	9.537 941
Thermoshelf stainless steel, material 1.4404	101	1	6.225 112
Chemical-resistant vacuum pump	all	1	4.663 358
Vacuum pump module	29	1	4.663 355
Vacuum pump module	49	1	4.663 356
Vacuum pump module	101	1	4.663 357
Premium module	29	1	9.537 944
Premium module	49	1	9.537 945
Premium module	101	1	9.537 946
Subframe, tubular steel, black enamelled	29	1	6.225 455
Subframe, tubular steel, black enamelled	49	1	4.664 347
Subframe, tubular steel, black enamelled	101	1	6.260 454

Further accessories can be found in our online shop.

1

1 Mini-Incubator CULTURA® M inclusive Multitrack

The CULTURA® M Mini-Incubator has specifically been designed for the incubation of contact slides and dipslides, as well as common Petri dishes for detecting bacteria, fungi and yeast. With its extremely small footprint, it can easily be transported wherever you need to use it. The Cultura® M incubator has an internal capacity of approximately 4 L. It is used in the areas of medical diagnostics and water analytics. The transparent door allows you to check inside the incubator without opening the door. Supplied with one Multitrack for the incubation of up to 18 dipslides and one thermometer.

Specifications

Temperature range:	25 to 45 °C
Temperature uniformity:	±1.0 °C
Capacity:	4 l
External dimensions (W x D x H):	310 x 168 x 155 mm
Internal dimensions (W x D x H):	220 x 150 x 120 mm
Weight:	1.1 kg
Power supply:	230 V, 50 Hz
Warranty:	2 Years

Type	PK	Cat. No.
Mini-Incubator CULTURA® M incl. Multitrack for 18 tests	1	6.280 441

2

2 Incubator Lovibond® DI 10

Designed for the reliable incubation of dipslides in laboratories and field work.

Lovibond®

- Low voltage, in-car operation possible
- Holds up to 12 dipslides or 10 quanti-discs
- Excellent temperature stability
- Programmable incubation period setting
- LCD Temperature display with up/down push button control
- Rapid heating times for fast testing
- External status LEDs

Scope of supply: Incubator incl. external 12 V universal power supply, set of leads (UK, EU, US), 12 V in-car power adapter

Temperature range:	ambient +5 ... +40 °C (±0.5 °C)
Dimensions (W x D x H):	246 x 215 x 162 mm
Weight:	1.7 kg
Power supply:	110/220-240 V or 12 V

Type	PK	Cat. No.
Lovibond® DI 10	1	6.291 192
Dipslide-Holder	1	6.274 399

3

3 Microbiological rapid tests Lovibond® Dipslides

The Lovibond® Dipslides are designed to test liquids as well as surfaces.

Lovibond®

These dual-sided Dipslides are available in a wide range of different media types. They are ideal for use in many applications including evaporative cooling towers, closed water circuits, cutting fluids, food testing, and many more.

Description	PK	Cat. No.
TTC/TTC for total viable count (TVC)	10	6.282 520
TTC/MALT for Yeast, Moulds, Fungi, TVC	10	6.282 521
TTC/ROSE for Yeast, Moulds, Fungi, TVC	10	6.282 522
TTC/MAC for coliforms, TVC	10	6.282 523
TTC/E.COLI for E. coli/coliforms, TVC	10	6.282 524
PDM/MAC for Pseudomonas species, coliforms	10	6.282 525
TTC/PDM for Pseudomonas species, TVC	10	6.282 526
SRB for Sulphate reducing bacteria	10	6.282 527
NRB for Nitrite reducing bacteria	10	6.282 528
R2A/R2A - TTC for testing of potable water	10	6.282 529

1 2 Mini-Incubator LLG-uni^{INCUB} 20

The **portable** LLG-uni^{INCUB} 20 **digital** incubator is ideally suited for haematology and microbiology applications, such as the cultivation of contact plates for microbiological hygiene analysis. Due to its small footprint and economical price, it is also the perfect incubator for educational institutions and small laboratories. The LLG-uni^{INCUB} 20 incubator features a large internal chamber with a capacity of 20 liter, capable of storing flasks and bottles up to 2 liter. In addition, the incubator includes two adjustable/removable shelves for increased capacity, as well as an electrical socket. The digital temperature control eliminates the need for external thermometers and repetitive "fine tuning" of an analog control knob. Optimum temperature distribution throughout the cabinet interior by fan circulation. The LLG-mini tumbling shaker uni^{SHAKER} 2 which can be positioned inside the incubator (please order separately).

Scope of supply: incubator, mains adapter, mains cable for integrated socket, 12 V cigarette lighter cable, 2 grid shelves, 1 drip tray

Specifications LLG-uni^{INCUB} 20

Temperature range:	Ambient + 5 °C to 60 °C
Accuracy:	±0.5 °C
Temperature uniformity:	±1.5 °C
Capacity:	20 l
External dimensions (W x D x H):	335 x 370 x 475 mm
Internal dimensions (W x D x H):	260 x 235 x 325 mm
Weight:	6.5 kg
Power supply:	100 - 240 V, 50/60 Hz
Warranty:	3 years

Type	Max. grids	Included grids	Plug type	PK	Cat. No.
LLG-uni ^{INCUB} 20	4	2	EU	1	6.263 570
LLG-uni ^{INCUB} 20	4	2	UK	1	6.263 571
Set LLG-uni ^{INCUB} 20 incl. LLG-uni ^{SHAKER} 2	4	2	EU	1	6.280 597



3 Mini-Incubator Heratherm™ Compact

The most compact unit of the Heratherm™ microbiological incubator family has an 18 L capacity, ideal for personalized workspace.

Thermo Scientific

- Minimal footprint for space restricted lab areas
- Temperatures at or below ambient
- High temperature accuracy
- Internal light facilitates sample observation

Specifications

Temperature range:	17 to 50 °C
Convection technology:	Mechanical convection
Temperature deviation at 37 °C (spatial):	±1.2 °C
Temperature deviation at 37 °C (over time):	±0.2 °C
Footprint:	0.12 m ²
Chamber volume:	approx. 18 l
Dimensions chamber (W x H x D):	180 x 310 x 290 mm
Dimensions, external (W x H x D):	260 x 415 x 470 mm
Number of shelves:	2 (incl. in delivery)/max. 3
Max. shelf load:	2 kg
Power supply/max. current:	45 W/0.45 - 0.85 A
Weight:	7.2 kg

Type	PK	Cat. No.
Compact Incubator Heratherm™	1	4.009 190
Compact Incubator Heratherm™ *	1	4.672 604

* without window



Incubators IN/IF and INplus/IFplus

Incubators for research, medicine, pharmaceuticals and food technology. Organic chamber loads require gentle heating. F or this reason, the heating and control system are especially optimised for low temperatures of up to +80 °C. To prevent temperature overshoots, temperature is increased within a very narrow control range and kept exactly at the setpoint value.

- with all-round surface heating
- fresh air is pre-heated
- with inner glass door

Specifications

Type designation:	N = Natural convection, F = Forced air circulation plus = TwinDISPLAY
Working temperature range:	at least 5°C (IN/INplus), at least 10°C (IF/IFplus) above ambient to +80 °C
Setting temperature range:	+20 °C to +80 °C
Setting accuracy:	0.1 °C
Power supply:	230 V, 50/60 Hz

Incubators IN and IF

SingleDISPLAY: ControlCOCKPIT with one colour display

Memmert

You can find a detailed description of the "SingleDISPLAY" model at www.memmert.com

Type	Nom. capacity	Max. grids	Included grids	Internal dimensions (W x D x H) mm	External dimensions (W x D x H) mm	Rated capacity kW	Net weight kg	PK	Cat. No.
	L								
IN30	32	3	1	400 x 250* x 320	585 x 434** x 704	1.60	48	1	9.537 961
IN55	53	4	1	400 x 330* x 400	585 x 514** x 784	1.00	57	1	9.537 962
IN75	74	6	2	400 x 330* x 560	585 x 514** x 944	1.25	66	1	9.537 963
IN110	108	5	2	560 x 400* x 480	745 x 584** x 864	1.40	76	1	9.537 964
IN160	161	8	2	560 x 400* x 720	745 x 584** x 1104	1.60	96	1	9.537 965
IN260	256	9	2	640 x 500* x 800	824 x 684** x 1183	1.70	110	1	9.537 966
IN450	449	8	2	1040 x 600* x 720	1224 x 784** x 1247	1.80	161	1	9.537 967
IN750	749	14	2	1040 x 600* x 1200	1224 x 784** x 1720	2.00	217	1	9.537 968
IF30	32	3	1	400 x 250* x 320	585 x 434** x 704	1.60	48	1	9.537 977
IF55	53	4	1	400 x 330* x 400	585 x 514** x 784	1.00	57	1	9.537 978
IF75	74	6	2	400 x 330* x 560	585 x 514** x 944	1.25	66	1	9.537 979
IF110	108	5	2	560 x 400* x 480	745 x 584** x 864	1.40	76	1	9.537 980
IF160	161	8	2	560 x 400* x 720	745 x 584** x 1104	1.60	96	1	9.537 981
IF260	256	9	2	640 x 500* x 800	824 x 684** x 1183	1.70	110	1	9.537 982
IF450	449	8	2	1040 x 600* x 720	1224 x 784** x 1247	1.80	161	1	9.537 983
IF750	749	14	2	1040 x 600* x 1200	1224 x 784** x 1720	2.00	217	1	9.537 984

* Less 39 mm for fan

**Depth without door handle, please add 56 mm

1

9.537 961

Incubators INplus and IFplus

TwinDISPLAY: ControlCOCKPIT with two colour displays

You can find a detailed description of the "TwinDISPLAY" model at www.memmert.com

Memmert



9.537 990

Type	Nom. capacity	Max. grids	Included grids	Internal dimensions (W x D x H) mm	External dimensions (W x D x H) mm	Rated capacity kW	Net weight kg	PK	Cat. No.
	L								
IN30plus	32	3	1	400 x 250* x 320	585 x 434** x 704	1.60	48	1	9.537 969
IN55plus	53	4	1	400 x 330* x 400	585 x 514** x 784	1.00	57	1	9.537 970
IN75plus	74	6	2	400 x 330* x 560	585 x 514** x 944	1.25	66	1	9.537 971
IN110plus	108	5	2	560 x 400* x 480	745 x 584** x 864	1.40	76	1	9.537 972
IN160plus	161	8	2	560 x 400* x 720	745 x 584** x 1104	1.60	96	1	9.537 973
IN260plus	256	9	2	640 x 500* x 800	824 x 684** x 1183	1.70	110	1	9.537 974
IN450plus	449	8	2	1040 x 600* x 720	1224 x 784** x 1247	1.80	161	1	9.537 975
IN750plus	749	14	2	1040 x 600* x 1200	1224 x 784** x 1720	2.00	217	1	9.537 976
IF30plus	32	3	1	400 x 250* x 320	585 x 434** x 704	1.60	48	1	9.537 985
IF55plus	53	4	1	400 x 330* x 400	585 x 514** x 784	1.00	57	1	9.537 986
IF75plus	74	6	2	400 x 330* x 560	585 x 514** x 944	1.25	66	1	9.537 987
IF110plus	108	5	2	560 x 400* x 480	745 x 584** x 864	1.40	76	1	9.537 988
IF160plus	161	8	2	560 x 400* x 720	745 x 584** x 1104	1.60	96	1	9.537 989
IF260plus	256	9	2	640 x 500* x 800	824 x 684** x 1183	1.70	110	1	9.537 990
IF450plus	449	8	2	1040 x 600* x 720	1224 x 784** x 1247	1.80	161	1	9.537 991
IF750plus	749	14	2	1040 x 600* x 1200	1224 x 784** x 1720	2.00	217	1	9.537 992

* Less 39 mm for fan

**Depth without door handle, please add 56 mm

Accessories for Universal Ovens and Incubators

Additional stainless steel grids and drip trays are available on request.

Memmert

Type	For Volume l	Load max. kg	PK	Cat. No.
Stainless steel grid	30	20	1	9.537 203
Stainless steel grid	55/75	20	1	6.231 512
Stainless steel grid	110/160	20	1	6.232 433
Stainless steel grid	260	20	1	9.537 204
Stainless steel grid	450/750	30	1	6.222 688
Stainless steel grid	1060	60	1	6.266 337

Further accessories can be found in our online shop.

2 Incubators, BD, BF series - Classic.Line

BINDER incubators stand for optimal incubation and for results that are reproducible in every routine test, even under high batch throughputs in long-term operation.

BINDER

Serie BD: Incubators with gravity convection.

Serie BF: Incubators with forced convection.

Equipment:

- Temperature range: from 5°C above room temperature to 100 °C
- Independent temperature safety device class 3.1 (DIN 12880) with optical and audible temperature alarm
- RS 422 interface for use with APT-COM™ DataControlSystem communication software
- Inner door made of tempered safety glass
- Power supply 230 V, 50/60 Hz



Type	Nom. capacity	Max. grids	Included grids	Internal dimensions (W x D x H) mm	External dimensions (W x D x H) mm	Rated capacity kW	PK	Cat. No.
	L							
BD 23	20	4	2	222 x 277 x 330	435 x 520 x 495	0.20	1	9.883 599
BD 400	400	9	2	1000 x 500 x 800	1235 x 765 x 1025	0.85	1	9.883 603
BF 400	400	9	2	1000 x 500 x 800	1235 x 765 x 1025	0.85	1	6.203 549

1

1 Incubators BD-S Solid.Line with natural convection

Standard incubators for research and quality control.

BINDER

- APT.line™ preheating chamber technology for exact temperature control
- Natural convection with homogenous temperature distribution
- Adjustable exhaust air flap
- Digital controller with timer
- Inner door made from safety glass
- Class 3.1 integrated independent adjustable temperature safety device (DIN 12880) with visual alarm

Specifications

Temperature range:	BD-S 56 // BD-S 115
Temperature variation at 37 °C:	RT +5 °C ... 70 °C
Recovery time after 30 sec. door open at 37 °C:	0.7 °C // 0.5 °C
Interior volume:	15 min.
Internal dimensions:	62 l // 118 l
External dimensions:	400 x 350 x 440 mm // 550 x 390 x 550 mm
Permitted load:	595 x 525 x 625 mm // 745 x 565 x 735 mm
Max. shelves:	30 kg // 75 kg
Weight:	3 // 5
Power supply:	38 kg // 54 kg
	230 V, 50/60 Hz

Type	Nom. capacity L	Max. grids	Included grids	Internal dimensions (W x D x H) mm	External dimensions (W x D x H) mm	PK	Cat. No.
BD-S 56	62	3	1	400 x 350 x 440	595 x 525 x 625	1	4.667 815
BD-S 115	118	5	1	550 x 390 x 550	745 x 565 x 735	1	4.667 817

2

2 Incubators, BD, BF series - Avantgarde.Line

The new Avantgarde.Line incubators, with their exceptional efficiency and perfect temperature accuracy thanks to the very latest APT.line™ technology has the real appeal.

BINDER

Series BD: Incubator with natural convection
 Series BF: Incubator with forced convection

Equipment:

- Up to 30% lower energy consumption compared to the previous model
- APT.Line™ technology for homogenous temperature distribution and accuracy
- Electromechanical control of the exhaust air flap
- Controller with LCD display
- Inner door made of tempered safety glass
- 2 chrome-plated racks
- Stackable up to 115 l
- Temperature range Series BD: ambient temperature plus 5 °C to 100 °C
- Temperature range Series BF: ambient temperature plus 7-8 °C to 100 °C
- Class 3.1 integrated independent temperature safety device (DIN 12880) with visual alarm
- USB port for recording data
- Power supply 230 V, 50/60 Hz

Type	Nom. capacity L	Max. grids	Included grids	Internal dimensions (W x D x H) mm	External dimensions (W x D x H) mm	Rated capacity kW	PK	Cat. No.
BF 56	59	4	2	400 x 340 x 440	560 x 565 x 625	0.40	1	4.658 058
BF 115	115	5	2	550 x 380 x 550	710 x 605 x 735	0.40	1	6.280 293
BF 260	260	8	2	610 x 545 x 760	810 x 760 x 965	0.90	1	6.270 115
BF 720	734	16	2	1000 x 565 x 1300	1165 x 870 x 1590	1.75	1	4.664 254
BD 56	57	4	2	360 x 380 x 420	560 x 565 x 625	0.30	1	6.280 269
BD 115	115	5	2	510 x 420 x 530	710 x 605 x 735	0.35	1	6.280 290
BD 260	260	8	2	610 x 545 x 760	813,5 x 813 x 962	0.85	1	6.280 291
BD 720	737	16	2	960 x 600 x 1280	1165 x 870 x 1590	1.65	1	6.274 532

1 Microbiological Incubators Heratherm™

Thermo Scientific Heratherm™ microbiological incubators are available in four different models, providing three different incubator airflow technologies in a choice of six sizes.

- Safe
- Safe view of samples through internal glass door, without impact on temperature
 - Safe conditions with superior temperature uniformity
 - Safe containment with automatic alarm for temperature deviations
- Easy
- Easy temperature setting with intuitive user interface
 - Easy to remove shelf system
 - Easy to clean interior with rounded corners
 - Easy to read large display
- Efficient
- Efficient small footprint to optimize benchtop space
 - Conveniently stackable without the need for tools or stacking kits
 - Efficient utilization of interior with flexible shelf system



2 3 Heratherm General Protocol Microbiological Incubators

Thermo Scientific Heratherm General Protocol incubators have been designed for your routine applications in pharmaceutical, medical, food and research laboratories.

Thermo Scientific

- Gravity convection provides gentle air flow and minimal drying out
- Corrosion resistant stainless steel chamber (AISI 430)
- Intuitive user interface for easy temperature setting
- Large vacuum fluorescent display for easy reading
- Safe view of samples through internal glass door, without impact on temperature
- Automatic overtemperature alarm
- Easy to remove "One Click" - shelf system
- Easy to clean interior with rounded corners
- Efficient small footprint to optimize benchtop space
- Efficient utilization of interior with flexible shelf system
- Tabletop models conveniently stackable without the need for tools or stacking kits
- Lockable casters for easy mobility and stability (floor models only)



Specifications

Temperature range: ambient +5 °C to 75 °C
 Power supply: 230 V/50/60 Hz



Type	Nom. capacity	Max. grids	Included grids	Internal dimensions (W x D x H) mm	External dimensions (W x D x H) mm	Rated capacity kW	PK	Cat. No.
	L							
IGS60	75	13	2	354 x 414 x 508	530 x 565 x 720	0.30	1	4.009 191
IGS100	117	16	2	464 x 414 x 608	640 x 565 x 820	0.54	1	4.009 192
IGS180	194	19	2	464 x 589 x 708	640 x 738 x 920	0.71	1	4.009 193
IGS400	405	39	2	544 x 569 x 1307	778 x 770 x 1545	1.20	1	9.534 150
IGS750	747	39	2	1004 x 569 x 1307	1261 x 770 x 1545	1.50	1	9.534 153

Accessories for Heratherm Microbiological Incubators

Thermo Scientific

Description	PK	Cat. No.
Wire mesh shelf for 60 L Incubators including 2 shelf supports, 338 mm x 336 mm	1	4.009 239
Wire mesh shelf for 100 L Incubators including 2 shelf supports, 448 mm x 336 mm	1	4.009 240
Wire mesh shelf for 180 L Incubators including 2 shelf supports, 448 mm x 511 mm	1	4.009 241
Kit for stacking 60 L units	1	4.009 246
Kit for stacking 100 L units	1	4.009 247
Kit for stacking 180 L units	1	4.009 248
Perforated stainless steel insert for all 400 litre Incubators	1	9.534 169
Perforated stainless steel insert for all 750 litre Incubators	1	9.534 170
Silicone free viton door sealing for all 400 litre Incubators	1	9.534 171
Silicone free viton door sealing for all 750 litre Incubators	1	9.534 172

Heating/Cooling incubators

1



1 2 Cooling incubator LLG-uniINCUBATOR 28 Cool

The LLG-uniINCUBATOR 28 Cool is a small cooling incubator with 28 litres and a temperature range of 3 °C - 45 °C. Natural convection prevents the samples from drying and enables cultivation and storage of long-term samples. The device is suitable for food controls, research, various cultivation processes and protein crystallization.

- Control panel for temperature setting
- Good temperature distribution due to 5 cooling and heating surfaces
- Peltier cooling and heating system
- Lockable
- Max. 6 shelves possible

Scope of supply: Cooling incubator LLG-uniINCUBATOR 28 Cool with power plug, 2 shelves, key, instruction manual

Specifications

Temperature range:	3 °C ... 45 °C
Accuracy/Temperature uniformity:	±0.5 °C
Capacity:	28 l
External dimensions (W x D x H):	420 x 413 x 485 mm
Internal dimensions (W x D x H):	329 x 219 x 369 mm
Weight:	13.5 kg
Power supply:	100 ... 240 V, 50/60 Hz
Warranty:	3 years

2



Type	Max. grids	Included grids	Rated capacity kW	Plug type	PK	Cat. No.
LLG-uniINCUBATOR 28 Cool	6	2	0.075	EU	1	6.263 575
LLG-uniINCUBATOR 28 Cool	6	2	0.075	UK	1	6.263 418

3



4.666 794

Cooled incubators FOC series

Versatile cooled incubators with class A+ energy efficiency. The auto-tuning temperature control system ensures excellent temperature stability and temperature distribution.

Velp Scientifica

- High efficiency, low operating costs
- 2 internal sockets for further devices
- Optionally available software TEMPSoft™ for setting times, temperatures, ramps and alarm thresholds
- Wireless data transmission
- Forced ventilation for uniform temperature distribution
- 3-digit display for indoor temperature
- The FOC 200I model has an internal glass door
- The FOC 200IL model has an internal glass door and illuminated shelves

Scope of supply: Cooled incubator, shelves

Specifications

	FOC 120 // FOC 200
Temperature range:	3 ... 50 °C
Temperature accuracy:	±0.5 °C
Volume:	120 l // 200 l
Outer dimensions:	540 x 550 x 905 mm // 540 x 600 x 1263 mm
Power rating:	120 W // 400 W
Weight:	36 kg // 46.3 kg
Power supply:	230 V, 50/60 Hz

4



4.666 795

Type	Nom. capacity L	Max. grids	Included grids	Rated capacity kW	PK	Cat. No.
FOC 120E	120	2	2	0.12	1	4.666 793
FOC 120I	120	2	2	0.12	1	4.666 796
FOC 200E	200	6	4	0.40	1	4.666 794
FOC 200I	200	6	4	0.40	1	4.666 797
FOC 200IL	200	6	4	0.40	1	4.666 795

Cooling incubators, KB, KT series

Series KB: Cooling incubators with compressor technology, for safe, reproducible incubation, even at high ambient temperatures.

Temperature range: -10 °C to 100 °C (KB 23: 0 °C to 100 °C).

Series KT: Cooling incubators with thermoelectric cooling, combines exceptional performance with low energy consumption. Temperature range: 4 °C to 100 °C.

- Adjustable fan speed Controller with time-segment and real-time programming
- Inner door made of tempered safety glass
- 2 stainless steel racks
- Class 3.1 independent temperature safety device (DIN 12880) with visual and audible temperature alarm
- Computer interface: Ethernet or RS 422
- Data recording and USB interface (Series KT)

BINDER

1



6.269 765

Type	Nom. capacity	Max. grids	Included grids	Internal dimensions (W x D x H) mm	External dimensions (W x D x H) mm	Rated capacity kW	Type of auxiliary energy	PK	Cat. No.
	L								
KT 53	52	5	2	400 x 334 x 400	660 x 630 x 635	0.4	200 ... 240 V, 50/60 Hz	1	6.280 289
KT 115	102	6	2	600 x 355 x 455	860 x 655 x 715	0.7	200 ... 240 V, 50/60 Hz	1	6.280 268
KT 170	163	10	2	600 x 355 x 765	860 x 655 x 1025	0.8	200 ... 240 V, 50/60 Hz	1	6.269 765
KB 23	20	3	2	222 x 277 x 330	435 x 600 x 620	0.3	230 V, 50/60 Hz	1	9.883 528
KB 53	53	4	2	400 x 330 x 400	635 x 665 x 840	0.6	230 V, 50 Hz	1	9.883 568
KB 115	115	5	2	600 x 400 x 480	835 x 730 x 1025	0.7	230 V, 50 Hz	1	9.883 569
KB 240	240	9	2	650 x 485 x 785	930 x 880 x 1460	1.2	200 ... 240 V, 50 Hz	1	9.883 570
KB 400	400	15	2	650 x 485 x 1270	930 x 880 x 1945	1.4	200 ... 240 V, 50/60 Hz	1	9.883 571
KB 720	720	15	2	970 x 576 x 1250	1255 x 970 x 1925	2.3	200 ... 240 V, 50/60 Hz	1	9.883 572

2 Thermostatic cabinets

The incubators from Lovibond® are designed for continuous tempering for different applications, mainly for the determination of BOD, the storage of wastewater samples, and the determination of enzymatic activity. The temperature range is +2 °C up to +40 °C and can be regulated in steps of 0.1°C. Temperature tolerance is defined with ±1 °C respectively ±0.5 °C (at 20 °C). Low energy consumption due to reinforced isolation. The interior of the cabinets is equipped with sockets for connecting stirrers. There are 3 models available with standard doors from 135 to 445 litres net capacity, and 2 models with glass doors with 140 and 255 litres net capacity. Illuminated LED display with actual/setpoint display.

Lovibond®

- Temperature range 2 °C to 40 °C, continuously adjustable in steps of 0.1 °C
- Low power consumption
- Illuminated LED display of preset and current temperatures
- Ideal for BOD determination at 20 °C
- Power sockets inside the incubator
- 5 models in 3 sizes
- Standard door or glass door

2



Specifications

Coolant: R134a
 Fan: Axial, delivery rate 320 m³/h
 Power supply: 220-230 V/50 Hz

Capacity l	External dimensions (W x D x H) mm	Internal dimensions (W x D x H) mm	Weight kg	Temp. range max. °C	PK	Cat. No.
135	600 x 600 x 850	513 x 441 x 704	39.0	+2 ... +40	1	9.699 142
255	600 x 610 x 1640	470 x 440 x 1452	61.0	+2 ... +40	1	9.699 144
445	750 x 730 x 1640	600 x 560 x 1452	78.5	+2 ... +40	1	9.699 145
140	600 x 600 x 850*	513 x 441 x 702	48.0	+2 ... +40	1	9.699 146
256	600 x 610 x 1640*	470 x 440 x 1452	77.0	+2 ... +40	1	9.699 147

* With glass door

Heating/Cooling incubators

1



9.538 012

Cooled Storage Incubators, IPS

Sample storage, incubating and cooling in the food industry, medicine, the cosmetics industry or pharmaceuticals. The storage cooled incubators with Peltier elements, heat and cool seamlessly with one system.

Memmert

- double doors as standard: prevents contamination and drops in temperature, and at the same time an optimal view of the load through fully glazed interior doors
- fans integrated in the Peltier elements ensure rapid energy transport and optimal temperature distribution

Model variant SingleDISPLAY: ControlCOCKPIT with one colour display

You can find a detailed description of the "SingleDISPLAY" model at www.memmert.com

Specifications

Working temperature range:	+14 °C to +45 °C
Setting temperature range:	+14 °C to +45 °C
Setting accuracy:	0.1 °C
Power supply:	230/115V, 50/60 Hz

Type	Nom. capacity	Max. grids	Included grids	Internal dimensions (W x D x H) mm	External dimensions (W x D x H) mm	Rated capacity kW	Net weight kg	PK	Cat. No.
	L								
IPS260	256	9	2	640 x 500** x 800	824 x 754* x 1183	0.55	113	1	9.538 011
IPS750	749	14	2	1040 x 600** x 1200	1224 x 856* x 1720	0.55	230	1	9.538 012

* Depth without door handle, please add 56 mm
**Less 10 mm for fan - Peltier

Suitable accessories can be found in our online shop.

2



2 Refrigerated incubator RI-150/RI-250

NEW

Thermo Scientific

For incubation and test applications below ambient temperature as well as standard incubation applications at 37 °C in warm environments.

- Available in 2 sizes as tabletop or standalone unit
- Standalone unit has lockable casters for easy mobility
- Door with viewing window
- Microprocessor control for precise temperature adjustment
- Timer function
- Temperature alarm, overtemperature shutdown
- Port hole on the right side of the device for inserting monitoring probes or cables
- RS232 data interface for temperature monitoring (software not included in delivery)
- IQ and OQ documentation and qualification service available
- Automatic defrosting
- Overheating protection in fan motor

Specifications

Temperature range:	4 ... 60 °C
Power supply:	230 V, 50 Hz
Warranty:	1 year

Type	Nom. capacity	Included grids	Internal dimensions (W x D x H) mm	External dimensions (W x D x H) mm	PK	Cat. No.
	L					
RI-150, tabletop	150	2	550 x 450 x 615	652 x 605 x 1050	1	4.672 602
RI-250, standalone unit	250	3	550 x 450 x 1015	652 x 605 x 1450	1	4.672 603

Peltier-cooled incubators IPP and IPPplus

Heating and cooling seamlessly with one system thanks to Peltier technology. In this respect, cooled incubators IPP not only contribute to climate protection, but it also achieves an additional decrease in operating costs of up to 90 % compared to compressor technology.

- Extremely quiet, vibration-free and space saving as no compressor is required
- No condensation in the interior chamber: due to the closed Peltier cooling system no outside air is exchanged
- LED light module for sizes 110 to 750 (as an option): dimmable LED light in three alternative colour temperatures (cold white light, warm white light or cold white and warm white light, dimmable in steps of 1 %)

Specifications

Type designation:	plus = TwinDISPLAY
Working temperature range without light:	0 (at least 20 below ambient) to +70 °C
Working temperature range with light:	+10 to +40 °C
Setting temperature range:	0 to +70 °C
Setting accuracy:	0.1 °C
Power supply:	230 V, 50/60 Hz

Peltier-cooled incubators IPP

SingleDISPLAY: ControlCOCKPIT with one colour display

Memmert

You can find a detailed description of the "SingleDISPLAY" model at www.memmert.com

Type	Nom. capacity	Max. grids	Included grids	Internal dimensions (W x D x H) mm	External dimensions (W x D x H) mm	Rated capacity		PK	Cat. No.
	L					kW	kg		
IPP30	32	3	1	400 x 250* x 320	585 x 506** x 704	0.140	40	1	9.538 001
IPP55	53	4	1	400 x 330* x 400	585 x 586** x 784	0.275	52	1	9.538 002
IPP110	108	5	2	560 x 400* x 480	745 x 656** x 864	0.550	78	1	9.538 003
IPP260	256	9	2	640 x 500* x 800	824 x 756** x 1183	0.820	114	1	9.538 004
IPP410	384	14	2	640 x 500* x 1200	824 x 756** x 1720	1.030	157	1	6.312 192
IPP750	749	14	2	1040 x 600* x 1200	1224 x 856** x 1720	1.300	230	1	9.538 005

* Less 10 mm for fan - Peltier

**Depth without door handle, please add 56 mm

Peltier-cooled incubators IPPplus

TwinDISPLAY: ControlCOCKPIT with two colour displays

Memmert

You can find a detailed description of the "TwinDISPLAY" model at www.memmert.com

Type	Nom. capacity	Max. grids	Included grids	Internal dimensions (W x D x H) mm	External dimensions (W x D x H) mm	Rated capacity		PK	Cat. No.
	L					kW	kg		
IPP30plus	32	3	1	400 x 250* x 320	585 x 506** x 704	0.140	40	1	9.538 006
IPP55plus	53	4	1	400 x 330* x 400	585 x 586** x 784	0.275	52	1	9.538 007
IPP110plus	108	5	2	560 x 400* x 480	745 x 656** x 864	0.550	78	1	9.538 008
IPP260plus	256	9	2	640 x 500* x 800	824 x 756** x 1183	0.820	114	1	9.538 009
IPP410plus	384	14	2	640 x 500* x 1200	824 x 756** x 1720	1.030	157	1	6.312 193
IPP750plus	749	14	2	1040 x 600* x 1200	1224 x 856** x 1720	1.300	230	1	9.538 010

* Less 10 mm for fan - Peltier

**Depth without door handle, please add 56 mm

Suitable accessories can be found in our online shop.

1



9.538 002

2



9.538 008

Heating/Cooling incubators

1



9.538 021

Cooled incubators with compressor cooling ICPEco

NEW

Memmert

This environmentally-friendly incubator is cooled with climate-friendly CO₂. Thanks to the excellent thermodynamic properties of the refrigerant CO₂ (R744) and the finely adjusted control technology, the ICPEco cooled incubator is both powerful and high-precision. Without critical temperature overshoots, it keeps the temperatures exactly at the setpoint.

- double doors standard for all models: Prevention of contamination and drops in temperature, and at the same time an optimum view of the sensitive load through wide-area interior glass doors
- very good air circulation in the working chamber through sophisticated ventilation technology
- intelligent defrosting function

Model variant TwinDISPLAY: ControlCOCKPIT with two TFT colour displays

You can find a detailed description of the "TwinDISPLAY" model at www.memmert.com

Specifications

Working temperature range: -12 to +60 °C

(not suitable for long-term storing at sub-zero temperatures, during permanent operation, the inner glass door may ice over)

Setting temperature range: -12 to +60 °C

Setting accuracy: 0.1 °C

Power supply: 230 V, 50/60 Hz

2



9.538 023

Type	Nom. capacity	Max. grids	Included grids	Internal dimensions (W x D x H) mm	External dimensions (W x D x H) mm	Rated capacity kW	Net weight kg	PK	Cat. No.
	L								
ICP110eco	108	5	2	560 x 400* x 480	745 x 584** x 1233	1.2	118	1	6.314 845
ICP260eco	256	9	2	640 x 500* x 800	824 x 684** x 1552	1.2	162	1	9.538 021
ICP450eco	449	8	2	1040 x 600* x 720	1224 x 784** x 1467	1.2	222	1	9.538 022
ICP750eco	749	14	2	1040 x 600* x 1200	1224 x 784** x 1950	1.2	254	1	9.538 023

* Less 33 mm for fan

**Depth without door handle, please add 56 mm

3

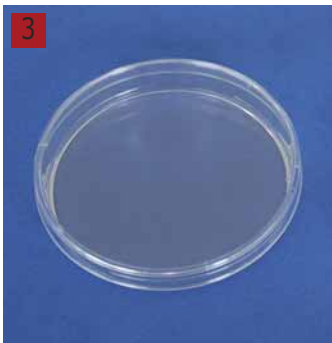

LLG-Petridishes, PS

Made of high quality optical clear polystyrene. Produced under aseptic conditions in an ISO 6 cleanroom. Contact plate with counting grid.

- With a smooth surface for an optimal distribution of the transport medium
- Stable thickness to prevent any deformations while using
- Stackable
- With or without vents
- Aseptic (90 mm diam.) or beta irradiated sterile versions (all sizes)
- Packed in sleeves á 10 dishes or 20 dishes (90 mm diam. dishes)

Ext. diam. mm	Description	Height approx. mm	PK	Cat. No.
90	with triple vents, aseptic	16	480	6.285 823
90	without vents, aseptic	16	480	6.285 824
90	with triple vents, sterile	16	480	6.285 816
90	without vents, sterile	16	480	6.285 817
60	with triple vents, sterile	14	1080	4.678 371
60	without vents, sterile	14	1080	4.678 372
55	contact plate, sterile	17	1000	6.285 821
150	with triple vents, sterile	19	180	6.285 822

1 CO₂ Incubators CellCulture®

The CellCulture® CO₂ incubators from Esco are widely used in scientific research to grow and maintain cell cultures. Typical fields of application include tissue engineering, neuroscience, cancer research and other mammalian cell research applications.

ESCO



- Fast and uniform temperature, CO₂ and O₂ control (O₂ suppressed models)
- HEPA filtration system with internal blower (some models)
- Capacitive humidity sensor
- IR CO₂-sensor with automatic auto zero
- Quick recovery time for temperature, CO₂ and humidity after door opening
- Stainless steel 1.4301 (AISI 304) or copper interior
- 90 °C moist heat decon system (models with air jacket)
- Easy to clean due to removable lids and inner door
- Serial RS485 communication port
- Low maintenance
- Stackable

Options on request:

Additional shelves, stacking kits, rollerbase, chart recorder

CO₂ Incubators CelCulture® with High Heat Sterilization NEW

ESCO

Incubator with 180 °C high heat sterilization cycle, for efficient contamination protection. Conforms to the international standards for dry heat sterilization.

- Stainless steel chamber
- Heat-resistant sensors
- IR CO₂ sensor
- O₂ Sensor (for suppressed O₂ model)
- 2 MB built-in flash memory for data and event logging

Type	Nom. capacity	Max. grids	Included grids	Internal dimensions (W x D x H) mm	External dimensions (W x D x H) mm	PK	Cat. No.
	L						
With ULPA Filter	170	7	4	505 x 535 x 633	660 x 660 x 905	1	4.678 084
With ULPA Filter	240	7	4	595 x 640 x 633	750 x 770 x 905	1	4.678 085
With ULPA Filter, O ₂ suppressed	170	7	4	505 x 535 x 633	660 x 660 x 905	1	4.678 086
With ULPA Filter, O ₂ suppressed	240	7	4	595 x 640 x 633	750 x 770 x 905	1	4.678 087
Without ULPA Filter	170	7	4	505 x 535 x 633	660 x 660 x 905	1	4.678 088
Without ULPA Filter	240	7	4	595 x 640 x 633	750 x 770 x 905	1	4.678 089
Without ULPA Filter, O ₂ suppressed	170	7	4	505 x 535 x 633	660 x 660 x 905	1	4.678 090
Without ULPA Filter, O ₂ suppressed	240	7	4	595 x 640 x 633	750 x 770 x 905	1	4.678 091

2 3 CO₂ incubator Heracell™ VIOS™ 160i with Cell Locker™ system NEW

Thermo Scientific

The CO₂ incubator with the Cell Locker™ system is designed for improved culturing efficiency and security for sensitive cultures. Six individual, autoclavable polycarbonate chambers divide the incubator chamber. Each Cell Locker™ chamber has dual 0.2 µm membrane filters, that permit air circulation but exclude microbial contaminants. When the Cell Locker™ chamber is opened, the temperature, CO₂ concentration and humidity in the unopened Cell Locker™ chambers remain stable.

- Provides security from cross contamination due to culture isolation in separate chambers
- Interior made of electropolished stainless steel or pure copper
- ISO class 5 HEPA filtered air
- Steri-Run overnight 180 °C sterilisation cycle achieves total sterilization (12 log SAL)
- iCAN Touchscreen with LED display
- Temperature resistant IR CO₂ sensor
- THRIVE technology for optimal air circulation



Specifications

Volume: 165 l
 Dimensions, external (W x H x D): 637 x 880 x 900 mm
 Dimensions, internal (W x H x D): 470 x 576 x 607 mm
 Weight: 83 kg
 Power supply: 230 V, 50/60 Hz

Type	PK	Cat. No.
Copper interior	1	6.312 578
Stainless steel interior	1	6.312 579



Heating/CO₂-Incubators

1



1 Cell Locker™ chambers for CO₂ incubator Heracell™ VIOS™ 160i

NEW

Thermo Scientific

Transparent. Each Cell Locker™ holds 9 each T-75 cell culture flasks, 20 each 6-well plates, or 24 each 96-well plates. The Cell Locker™ can be manually disinfected or can be autoclaved a maximum of 12 times.

- Tapered box for easy installation into incubator
- Easy and secure one handed latch and pull
- Non-slick sliding tray with tip protection
- Removable cover for protected transport
- Membrane filter (0.2 µm)

Description	PK	Cat. No.
Package of 6 Cell Locker™ with copper sliding tray	6	6.312 571
Package of 6 Cell Locker™ with stainless steel sliding tray	6	6.312 573

2



2 CO₂ Incubators ICOMed

Memmert

The CO₂ incubator ICOMed is the perfect solution: Thanks to the battery-buffered ControlCOCKPIT, the operating display, logging and CO₂ control remain fully functional even when there is a power failure. All parameters are logged in accordance with the FDA and, when individually adjusted ranges for CO₂, O₂, temperature and humidity are exceeded, notifications can be sent to a mobile phone in addition to an alarm. With its rounded corners, the interior is easy to clean and can be sterilised for 60 minutes at 180 °C (including all sensors). The active humidity control offers optimal protection for cell and tissue cultures. It minimizes evaporation in the interior and ensures short recovery times. Every Memmert CO₂ incubator ICOMed is a medical device of class IIa according to MDD 93/42/EEC until 26 May 2024 according to the transitional provisions by the (EU) 2017/745 article 120 (2).

- fully insulated stainless steel door and heated inner glass door

Model variant TwinDISPLAY: ControlCOCKPIT with two colour displays

You can find a detailed description of the "TwinDISPLAY" model at www.memmert.com

Specifications

Working temperature range:	at least 5 above ambient up to +50 °C (standard sterilisation programme: 60 minutes at 180 °C)
Setting temperature range:	+18 °C up to +50 °C
Setting accuracy temperature:	0.1 °C
Humidity limitation thanks to a Peltier element:	when water dish is full and inserted, the Peltier element limits the value of relative humidity in the interior to 93 % rh ±2.5 %
Setting range active humidity control:	40 to 97 % rh and rh-Off
Setting accuracy humidity:	0.5 % rh
CO ₂ -concentration:	0 to 20 %
O ₂ -concentration:	1 to 20 %
Setting accuracy CO ₂ :	0.1 %
Setting accuracy O ₂ :	0.1 %
Power supply:	230 V, 50/60 Hz

Type	Nom. capacity	Max. shelves	Included shelves	Internal dimensions (W x D x H) mm	External dimensions (W x D x H) mm	Rated capacity kW	Net weight kg	PK	Cat. No.
	L								
ICO50med	56	5	1	400 x 330* x 425	559 x 521** x 795	1.10	55	1	6.283 118
ICO105med	107	6	2	560 x 400* x 480	719 x 591** x 850	1.30	75	1	6.283 119
ICO150med	156	10	2	560 x 400* x 700	719 x 591** x 1070	1.50	90	1	6.283 120
ICO240med	241	12	2	600 x 500* x 810	759 x 691** x 1180	1.65	110	1	6.283 121

* Less 35 mm for fan

**Depth without door handle, depth of door handle 56 mm

Suitable accessories can be found in our online shop.

3



3 Cell Culture Flasks EasyFlask™/TripleFlask™, non-treated, PS/HDPE, pyrogen-free

Thermo Scientific

Non-treated, sterile flasks for suspension cell cultures. White caps for easy identification. Pyrogen-free.
Material flasks: Polystyrene
Material caps: HDPE

Type	Working volume ml	Culture surface cm ²	Neck	PK	Cat. No.
EasyFlask™	7	25	curved	200	6.702 724
EasyFlask™	30	75	curved	100	6.222 672
EasyFlask™	55	175	curved	30	7.900 288
TripleFlask™	200	500	straight	32	7.900 289

For our Cell Culture range - please see page 1331.

1 CO₂ incubators, CB series with sterilizable sensor

Suitable for all incubation tasks, even for complex experiments under hypoxic conditions. Models with additional O₂ control, **active humidification** and split interior doors are available. With intuitive touchscreen controller, DuoDoor™ system for simultaneous opening of outer and inner door as well as lockable door handle. CO₂ autodiagnostic system to protect cell cultures.

BINDER



- Unit and CO₂ sensor can be sterilized with hot air at 180 °C
- Double-pan humidification system with condensation protection
- Seamless inner compartment made of stainless steel
- Measured values can be read out via USB and Ethernet interface
- Sealing inner door made of safety glass
- Stackable with adapter
- Fault diagnosis system with optical and acoustic alarm
- Internal data recording, can be read out via USB
- Ethernet interface

Type G: with divided inner door

Type F (CB170): with active humidification

Type O: with O₂ control

Specifications

Working temperature range: RT + 7 °C ... 60 °C
 CO₂ range: 0 ... 20 %
 Humidity range: 90 ... 95 %
 Power supply: 200 ... 240 V, 50/60 Hz

Type	Nom. capacity	Max. grids	Included grids	Internal dimensions (W x D x H) mm	External dimensions (W x D x H) mm	Rated capacity kW	PK	Cat. No.
	L							
CB060-230V	53	3	2	400 x 330 x 400	580 x 545 x 720	1.0	1	9.883 726
CB060-230V-O	53	3	2	400 x 330 x 400	580 x 545 x 720	1.0	1	9.883 738
CB060-230V-G*	53	2	2	400 x 330 x 400	580 x 550 x 720	1.0	1	9.883 732
CB060-230V-GO*	53	2	2	400 x 330 x 400	580 x 550 x 720	1.0	1	9.883 744
CB170-230V	170	6	3	560 x 505 x 600	680 x 715 x 870	1.4	1	6.274 262
CB170-230V-O	170	6	3	560 x 505 x 600	680 x 715 x 870	1.4	1	4.663 953
CB170-230V-F	170	6	3	560 x 505 x 600	680 x 715 x 870	1.4	1	6.312 166
CB170-230V-OF	170	6	3	560 x 505 x 600	680 x 715 x 870	1.4	1	6.312 167
CB260-230V	267	8	3	620 x 575 x 750	740 x 785 x 1020	1.5	1	4.678 809
CB260-230V-O	267	8	3	620 x 575 x 750	740 x 785 x 1020	1.5	1	4.678 810
CB260-230V-F	267	8	3	620 x 575 x 750	740 x 785 x 1020	1.5	1	4.678 811
CB260-230V-OF	267	8	3	620 x 575 x 750	740 x 785 x 1020	1.5	1	4.678 812

*with four-part inner door

Further models can be found in our online shop.

2 Cell and Tissue Culture Dishes, treated, PS, sterile



Dishes with treated surface, suitable for adhesion cells.

- Easy and secure stacking
- Sterilized by gamma irradiation
- Pyrogen-free



Diam. mm	Height mm	Culture surface cm ²	PK	Cat. No.
18	12	12.0	300	4.672 542
33	13	8.5	960	4.672 543
52	18	21.2	600	4.672 544
55	14	3.3	600	4.672 545
68	15	36.3	600	4.672 546
85	17	55.0	500	4.672 547
88	22	60.8	300	4.672 548
136	22	143.0	120	4.672 549
136	22	143.0	100	4.672 550

Heating/Shaking incubators

1



1 Incubator 1000, Suitable for Heidolph Shakers

Modular system for shaking, mixing and heating with visual reaction control. Compatible shakers are Duomax 1030, Polymax 1040, Titramax 1000, Unimax 1010 and Promax 1020.

Heidolph

- Heating module with a heating capacity of 300 W allows for quick and gentle temperature adjustments up to 65 °C
- Digital temperature setting of target temperature of 65 °C and separate display for actual temperature (accuracy of ±2°C up to 50°C and ±4°C over 50°C)
- Low noise blower allows for quick and even temperature distribution throughout the entire enclosure
- One incubation system can be used for several shakers, fast conversion possible
- To protect samples from thermal damages this unit features a safety circuit to prevent overheating
- Unlimited visual reaction control due to transparent and non-fogging PETG hoods
- 3 hoods options available: A flat hood for small vessels and microtiter plates, a high hood for all common medium sized vessels and a high hood XL for larger Erlenmeyer flasks up to 2000 ml
- The incubator hoods open instantly and interlock in any position

Please order hoods separately.

Type	PK	Cat. No.
Incubator 1000, heating module	1	9.839 875

2



2 Hoods for Inkubator 1000

Heidolph

Description	PK	Cat. No.
Incubation hood, low	1	9.839 876
Incubation hood, high	1	9.839 877
Incubation hood XL	1	9.839 878

3



6.251 451

Shaking Incubators ES-20/ES-80

Stable and reliable orbital shaker-incubator for vigorous or even mixing and incubation of samples in a variety of flasks and vessels. For Life Sciences, suitable for growing cell cultures in flasks, extracting tissue samples at physiological, temperatures, and sample preparation processes, mixing of biological liquids as well as the incubation and cultivation of biological liquids, growing e-coli, bioluminescence preparation.

Grant

- Variable speed: 50 to 250 rpm
- Digital control of time, temperature and shaking speed for accuracy and repeatability
- Display 2-line 16 character LCD
- Interchangeable platforms for shaking/incubating different vessels (please order separately)

Specifications

Speed range:	50 to 250 rpm
Temperature range ES-20:	+25 to 42 °C
Temperature range ES-80:	+25 to 80 °C
Temperature setting resolution:	0.1 °C
Stability:	±0.5 °C
Shaking movement:	orbital
Orbit ES-20:	10 mm
Orbit ES-80:	20 mm
Continuous operation ES-20:	720 hrs
Continuous operation ES-80:	168 hrs
Timer:	1 min to 96 hrs
Load capacity ES-20:	2.5 kg
Load capacity ES-80:	8 kg
Power supply:	230 V 50/60 Hz

4



9.721 056

Type	Load capacity	Internal dimensions (W x D x H)	External dimensions (W x D x H)	PK	Cat. No.
	kg	mm	mm		
ES-20	2.5	305 x 260 x 250	340 x 340 x 435	1	6.251 451 3
ES-80	8.0	390 x 450 x 300	590 x 525 x 510	1	9.721 056 4

7. Heating and cooling technology

Heating/Shaking incubators

Accessories for Shaking Incubators ES-20/ES-80

Grant

Type	Description	For Type	PK	Cat. No.
P12-100	Platform with clamps for 12 x 100 ml flasks / 150 ml beakers	ES-20	1	9.721 023
PP-4	Flat platform with non slip rubber mat	ES-20	1	9.721 022
P6-250	Platform with clamps for 6 x 250 ml flasks / 300 ml beakers	ES-20	1	9.721 024
PUP-12	Universal platform	ES-20	1	9.721 021
P16-88	Platform with spring holders for 88 tubes up to 30 mm	ES-20	1	9.721 049
PP-400	Flat platform with non slip rubber mat	ES-80	1	9.721 060
P30-100	Platform with clamps for 30 x 100 ml flasks	ES-80	1	9.721 061
P16-250	Platform with clamps for 16 x 250 ml flasks	ES-80	1	9.721 062
P9-500	Platform with clamps for 9 x 500 ml flasks	ES-80	1	9.721 063
P6-1000	Platform with clamps for 6 x 1000 ml flasks	ES-80	1	9.721 064

1



9.721 023

2



9.721 021

3



9.721 049

4 Shaking Incubator 211DS

NEW

4

Labnet

Due to a small footprint, compact, stackable design and expanded temperature range, this shaking incubator is ideal for molecular biology and general use. With integral orbital shaker. Two full and one half shelves are supplied with each incubator.

- Temperature control system SmartChek™
- Internal electrical outlet
- Flask capacity: 4 x 1 l, 5 x 500 ml, 9 x 250 ml or 16 x 125 ml
- Gasket door with large viewing area

Specifications

Temperature range:	Ambient +5 °C ... 80 °C
Precision:	±0.5 °C
Temperature setting resolution:	0.1 °C
Shaker orbit:	19 mm
Shaker speed:	20 ... 300 rpm
Timer:	0 ... 99 min. or continuous
Chamber volume:	49 l
Chamber Dimensions (W x D x H):	343 x 375 x 381 mm
Total Dimensions (W x D x H):	425 x 550 x 580 mm
Weight:	37.7 kg
Power supply:	230 V, 50/60 Hz



Type	PK	Cat. No.
211DS	1	6.265 178

Accessories for Shaking Incubator 211DS

NEW

5

Labnet

Description	PK	Cat. No.
Clamp for 125 ml flask	1	6.265 183
Clamp for 250 ml flask	1	6.261 512
Clamp for 500 ml flask	1	6.261 520
Clamp for 1000 ml flask	1	6.265 184
Flat platform with non-slip rubber mat	1	6.265 181
Flask clamp platform, predrilled	1	6.265 179
Universal spring loaded platform	1	6.265 180
Stacking adapter	1	4.676 172

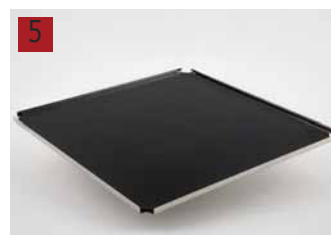

6.265 181

Heating/Shaking incubators

1

1 Benchtop Shaking Incubator 222DS

Labnet

The Benchtop Shaking Incubator is a combination of a shaker and a temperature chamber, designed for shaking and heat treatment of sensitive samples. It replaces two devices, reduces time and space needed. It is very suitable for biochemistry, microbiology and medicine laboratories in which thermal and shaking treatment of samples is a daily used routine.

- High temperature working range
- Can be used in cold rooms too
- Digital readout of all parameters - read temporary or preset RPM, temperature, time, acceleration
- Parameter changes while the device is running (except timer)
- Last parameter values reside in the memory even if the device was switched off
- Precisely adjusted and maintained temperature regulation within 0.5 °C of absolute deviation from the set temperature
- HOLD and STEP time function with 1 minute resolution
- Easy interchangeable platforms
- Lid sensor

Universal attachment and non-slip mat please order separately.

Specifications

Temperature range:	Ambient +5 °C ... 70 °C
Precision:	±0.5 °C
Speed range:	20 ... 300 rpm
Timer:	1 min - 99 hours or continuous
Platform size:	300 x 300 mm
Supply requirements:	230 V, 50 Hz

Type	PK	Cat. No.
222DS	1	6.259 079

2

6.259 082

Accessories for Benchtop Shaking Incubator 222DS

NEW

Labnet

Description	PK	Cat. No.
Universal platform 30 x 30 cm	1	6.259 080
Non-slip mat	2	6.259 082

3

3 Shaking Incubator 311DS

NEW

Labnet

Incubator with built-in orbital shaker. Stable temperature conditions and a broad temperature range enables the use of this incubator for cell cultures, washing blots, bacterial cultures, yeast cultures, entomology studies, egg hatching, hybridization washes, mixing and re-suspensions. Opening the door stops operation of the shaker. The incubator is supplied with one shelf.

- Temperature control system SmartChek™
- Broad temperature range
- High uniformity and accuracy
- Gasket door with large viewing area
- Adjustable shelves

Flat platform with non-slip rubber mat, flask platforms, additional shelves please order separately.

Specifications

Temperature range:	Ambient +5 °C ... 80 °C
Precision:	±0.5 °C
Temperature setting resolution:	0.1 °C
Shaker orbit:	19 mm
Shaker speed:	20 ... 300 rpm
Timer:	0 ... 99 min or continuous
Chamber volume:	71 l
Chamber Dimensions (W x D x H):	442 x 396 x 406 mm
Total Dimensions (W x D x H):	574 x 544 x 635 mm
Weight:	63.6 kg
Power supply:	230 V, 50/60 Hz

Type	PK	Cat. No.
311DS	1	6.261 509

Accessories for Shaking Incubator 311DS



1

Description	PK	Cat. No.
Platform with 6 x 1000 ml flask clamps	1	4.676 163
Platform with 20 x 125 ml flask clamps	1	4.676 164
Platform with 4 x 2000 ml flask clamps	1	4.676 165
Platform with 12 x 250 ml flask clamps	1	4.676 166
Platform with 30 x 50 ml flask clamps	1	4.676 167
Platform with 8 x 500 ml flask clamps	1	4.676 168
Rack holder, fits I-5330, holds 1 x K566 for 15 ml tubes	1	4.676 169
Rack holder, fits I-5330, holds 1 x K568 for 50 ml tubes	1	4.676 170
Flat shaker platform with non-slip rubber mat	1	4.676 171
Additional full size shelf	1	6.261 510
Shaker platform pre-drilled for flask clamps (clamps sold separately)	1	6.261 511



4.676 165

Benchtop shaking incubators Genie Temp-Shaker 100/300

For shaking and incubation of samples. The incubation chamber can be opened from 3 sides and tilted to the side to load the platform or take samples.

Scientific Industries

- Removable incubation chamber
- Very good temperature distribution
- Minimum temperature loss when opening the chamber
- The maximum working temperature of 75 °C is reached in 20 minutes
- Transparent incubation chamber

Genie Temp-Shaker 100

For shaking speeds up to 100 min⁻¹. Available with adhering mat.

Genie Temp-Shaker 300

For shaking speeds up to 300 min⁻¹. Available with adhering mat, ratcheting clamps or flask clamps.

Specifications	Temp-Shaker 100 // Temp-Shaker 300
Shaking movement:	orbital
Orbit:	19 mm
Max. shaker weight:	3 kg
Speed range:	20 ... 100 min ⁻¹ // 35 ... 300 min ⁻¹
Temperature range:	28 ... 75 °C
Platform dimensions (W x D):	305 x 305 mm
Chamber volume:	40 l
Overall dimensions (W x D x H):	450 x 480 x 305 mm
Weight:	9 kg
Ambient temperature range:	0 ... 38 °C

Type	Plug type	PK	Cat. No.
Genie Temp-Shaker 100	EU	1	4.668 295
Genie Temp-Shaker 100	UK	1	4.668 296
Genie Temp-Shaker 100	CH	1	4.668 297
Genie Temp-Shaker 300, with ratcheting clamps	without	1	4.668 298
Genie Temp-Shaker 300, with flask clamps	without	1	4.668 299
Genie Temp-Shaker 300, with adhering mat	without	1	4.668 300
Genie Temp-Shaker 300, with ratcheting clamps	EU	1	4.668 301
Genie Temp-Shaker 300, with flask clamps	EU	1	4.668 302
Genie Temp-Shaker 300, with adhering mat	EU	1	4.668 303
Genie Temp-Shaker 300, with ratcheting clamps	UK	1	4.668 304
Genie Temp-Shaker 300, with flask clamps	UK	1	4.668 305
Genie Temp-Shaker 300, with adhering mat	UK	1	4.668 306
Genie Temp-Shaker 300, with ratcheting clamps	CH	1	4.668 307
Genie Temp-Shaker 300, with flask clamps	CH	1	4.668 308
Genie Temp-Shaker 300, with adhering mat	CH	1	4.668 309

2



4.668 295

3



4.668 302

Heating/Shaking incubators

1



1 Shaking incubator with cooling ISICMBCDG

OHAUS

The Incubating/Cooling Orbital Shaker is microplate ready without the need for any additional accessories. Optional modular blocks can accommodate micro-tubes, centrifuge tubes, vials, or culture tubes. Unit holds microplates or modular blocks with a 127 mm tall interior capacity. Ideal for analyses that require a stable, controlled temperature.

- Heats to 65 °C and cools to 10 °C below ambient
- LED displays for temperature, speed and time
- Temperature Calibration Mode
- Triple Eccentric Drive
- Overload Protection
- Speed Ramping Feature
- Audible Alarm
- Caution Hot Indicator
- Polycarbonate Lid

Scope of supply: Thermo Shaker incl. adapter bracket for blocks

Without blocks. Please order separately.

Specifications

Temperature range:	10 °C below ambient to +65 °C
Temperature uniformity:	±0.5 °C at +37 °C
Speed with microplates:	100 to 1200 rpm
Speed with blocks:	100 to 600 rpm
Accuracy:	±2 %
Timer:	1 s to 160 h
Orbit:	3 mm
Max. load:	2 microplates or 2 blocks
Permissible ambient conditions:	5 to 40 °C
Dimensions (L x W x H):	455 x 279 x 267 mm
Weight:	15.4 kg
Power supply:	230 V, 50/60 Hz

Type	PK	Cat. No.
ISICMBCDG	1	4.659 474

2



4.659 479

2 Shaking Incubator with rocking or tumbling motion

OHAUS

The Incubating Rocking and Tumbling Shakers combine smooth rocking or tumbling motion and general purpose incubation in one compact bench top unit.

- Electronic tilt adjustment while unit is operating
- LED displays for temperature, speed and tilt angle, and time
- Timer with audible alarm
- Overload Protection
- Speed Ramping Feature
- Caution Hot Indicator
- Polycarbonate Lid

Scope of supply: Shaking Incubator incl. built-in tray and lid

Specifications

Temperature range:	ambient +5 °C to 65 °C
Temperature uniformity:	±0.5 °C at 37 °C
Tilt angle Rocking shaker/Tumbling shaker:	0 to 15°/0 to 20°
Timer:	1 s to 160 h
Max. loading:	4.5 kg
Permissible ambient conditions:	5 to 40 °C
Overall Dimensions (L x B x H):	432 x 279 x 267 mm
Interior Dimensions (L x B x H):	273 x 197 x 97 mm
Interior Dimensions Tumbling shaker (L x B x H):	273 x 197 x 86 mm
Weight:	10 kg
Power supply:	230 V, 50/60 Hz

3



4.659 480

Type	PK	Cat. No.
Rocking shaker ISRK04HDG	1	4.659 479
Tumbling shaker ISWV02HDG	1	4.659 480

7. Heating and cooling technology

Heating/Shaking incubators

Shaking Incubators ISLD

The Incubating Light Duty Orbital Shakers are designed to heat and shake a variety of samples. The Microplate Shakers are optimized for shaking microplates, deep-well plates, or micro-tubes. Available with opaque lid for light sensitive samples.

- LED displays for temperature, speed and time
- Timer with audible alarm
- Calibration mode for temperature
- Microprocessor Control
- PID Temperature Controller
- Triple Eccentric Drive
- LED Display
- Temperature Calibration Mode
- Overload Protection
- Speed Ramping Feature
- Audible Alarm
- Spill-Resistant Design
- Polycarbonate Lid

Scope of supply:

04HDG: Shaking Incubator incl. built-in tray and lid

MPHDG: Shaking Incubators incl. built in tray for microplates, deep-well plates, or micro-tubes and lid

MPHDGL: as MPHDG, but with opaque lid

Specifications

Temperature range:	ambient +5 °C to 65 °C
Temperature uniformity:	±0.5 °C at 37 °C
Speed/Accuracy:	100 to 1200 rpm/±2 %
Timer:	1 s to 160 h
Orbit:	3 mm
Max. Load	
Orbital shaker	3.6 kg
Microplate shaker	4 microplates or 2 racks for microtubes
Permissible ambient conditions:	5 to 40 °C
Weight:	13.6 kg
Power supply:	230 V, 50/60 Hz

Type	PK	Cat. No.
04HDG	1	4.659 471 ■
MPHDG	1	4.659 473 ■
MPHDGL	1	4.659 472 ■

Blocks for Benchtop Shaking Incubators

For	No. of wells	Plate format mm	Depth mm	PK	Cat. No.
Microplates*		107 x 71 x 2.5	23.0	1	4.659 810
384 Well Plates*	384	Ø 4.0	8.1	1	4.659 811 ■
0.2 ml PCR Plates*	384	Ø 6.4	12.7	1	4.659 812
0.5 ml Microplates**	30	Ø 7.9	24.6	1	4.659 813 ■
1.5 ml Microplates**	24	Ø 11.1	35.3	1	4.659 814
2.0 ml Microplates**	24	Ø 11.5	35.3	1	4.659 815
5-7 ml Tubes	24	Ø 12.0	36.1	1	4.659 816
2.0 ml Cryogenic Tubes	24	Ø 12.6	36.0	1	4.659 817 ■
5 ml Eppendorf™ Tubes	9	Ø 16.8	49.0	1	4.659 818
15 ml conical Tubes	9	Ø 17.3	104.4	1	4.659 819
50 ml conical Tubes	4	Ø 30.0	100.9	1	4.659 820

*with lid
**with empty rack and cover

OHAUS 1



4.659 471

2



4.659 473

3



4.659 472

4



4.659 811

5



4.659 817

Heating/Shaking incubators

1

1 Shaking incubators SI500/SI600/SI600C

These combined shakers and incubators are ideal for scientists doing cell culturing procedures, especially suspension culture applications. All units are compact enough to be positioned on the laboratory bench.

Stuart

When SI600C is combined with the SRC4 recirculating cooler, or equivalent, the SI600C can operate at temperatures down to 15 °C below ambient (min. 5 °C). On the SI600C all viewing windows are also double glazed to prevent condensation. The Incubators have a versatile clamping system which secures most sizes and mixtures of flask up to 1 litre on the SI500 and 2 litres on the SI600 and SI600C. Typically, the SI500 platform will accommodate the following Erlenmeyer flasks: 12 x 250 ml, or 9 x 500 ml or 4 x 1000 ml while the SI600 and SI600C can accommodate the following: 6 x 2000ml, 9 x 1000ml or 15 x 500ml.

- Microprocessor controlled
- 51 or 115 Litre capacity available
- Digital display for temperature and speed
- Timer from 1 second to 9 days
- USB connection
- Unique retractable platform for easy loading and unloading
- With alarm function

Specifications

Temperature range	
SI500 + SI600:	Amb.+5 °C to + 60 °C
SI600C:	Amb. -15 °C (min. 5 °C) to 60 °C*
Display resolution:	0.1 °C
Precision:	±0.5 °C at 37 °C
Fluctuation:	±0.5 °C at 37 °C
Variation:	< 0.5 °C at 37 °C
Speed range:	30 to 300 rpm
Platform size	
SI500 // SI600 + SI600C:	335 x 335 mm // 526 x 390 mm
Max. vessel height	
SI500 // SI600 + SI600C:	250 mm // 300 mm
Volume	
SI500 // SI600 + SI600C:	51 l // 115 l
Max. load	
SI500 + SI600C // SI600:	10 kg // 15 kg
Heater power	
SI500 // SI600 + SI600C:	250 W // 400 W
Supply requirements:	230 V, 50 Hz

Type	Nom. capacity		Load capacity	Internal dimensions (W x D x H) mm	External dimensions (W x D x H) mm	PK	Cat. No.
	L	kg					
SI500	51	10		422 x 408 x 297	450 x 474 x 522	1	9.951 612
SI600	115	15		660 x 470 x 395	675 x 542 x 640	1	9.645 351
SI600C	115	10		625 x 455 x 380	675 x 562(592**) x 640	1	6.287 436

* Requires separate recirculating cooler (6.287 437)

** 592 mm with cooling connectors attached

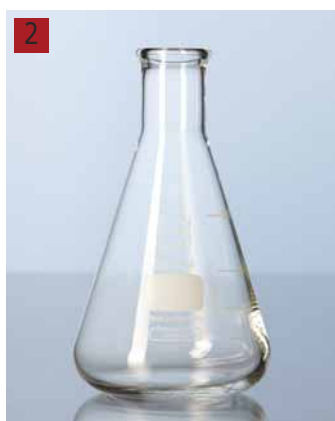
2

2 Erlenmeyer flasks, DURAN® Super Duty, narrow neck

With approximate graduations. Reinforced sturdy rim, and increased mechanical strength for heavy duty. Glass type I/neutral glass as per USP, EP and JP.

DWK Life Sciences

With Retrace Code (Batch Identification) certificate available via the Internet. Autoclavable.

Capacity	Neck diam.	Bottom diam.	Height	PK	Cat. No.
ml	mm	mm	mm		
25	22	42	75	1	9.141 270
50	22	51	90	1	9.141 271
100	22	64	105	1	9.141 272
250	34	85	145	1	9.141 273
500	34	105	180	1	9.141 274
1000	42	131	220	1	9.141 275
2000	50	166	280	1	9.141 276
5000	52	220	365	1	9.141 277

7. Heating and cooling technology

Heating/Shaking incubators

KS 3000 i control/KS 3000 ic control

Innovatively designed, compact incubator shaker to safely allow unattended operation in a temperature-controlled environment. The unit has a large LED display for speed, temperature and timer. An integrated PID temperature control allows the use of PT 1000 temperature sensors to assure highly accurate temperature control. The electronically controlled incubator comes equipped with RS 232 and USB ports for PC interface. All functions can be controlled and documented using labworldsoft® (software sold separately).

- Controls with antimicrobial coating for reduction of bacteria
- Junction box in the workspace for connection of an additional temperature sensor, e.g. PT 1000 (included with delivery)
- Wide range of attachments allows for using almost all shapes and sizes of vessels
- Unit stops automatically when hood is lifted
- Collecting tray with drain hose on rear of the unit
- Electronic timer
- Error code display

KS 3000 ic control additionally with built-in cooler for connection to an external cooling unit.

Specifications

Shaking movement:	orbital
Orbit:	20 mm
Max. shaker weight (with attachment):	7.5 kg
Motor rating input/output:	45/10 W
Power consumption:	1.120 W
Speed:	10 to 500 rpm
Timer:	1 s to 999 h
Speed display:	LED
Heater power:	1000 W
Temperature range KS 3000 i:	RT +5 °C to +80 °C
Temperature range KS 3000 ic:	RT -10 °C to +80 °C
Temperature stability (200 ml H ₂ O at target T=37 °C, RT 25 °C):	±0.1 K
Temperature range (inlet T>3 °C) for KS 3000 ic:	+12 to +80 °C
Dimensions (W x D x H):	465 x 695 x 430 mm
Protection class acc. to DIN EN 60529:	IP 30
Interface:	RS 232, USB
Power supply:	230 V, 50/60 Hz



9.837 882

Type	Nom. capacity L	Plug type	PK	Cat. No.
KS 3000 i control	50	EU	1	9.837 881
KS 3000 i control	50	UK	1	9.837 883
KS 3000 i control	50	CH	1	9.837 884
KS 3000 ic control	50	EU	1	9.837 882
KS 3000 ic control	50	UK	1	9.837 885
KS 3000 ic control	50	CH	1	9.837 886

2 Erlenmeyer flasks DURAN® Super Duty, wide neck

With approximate graduations. Reinforced, sturdy rim and increased mechanical strength for heavy duty. Glass Type I/neutral glass as per USP, EP and JP. With retrace code (Batch Identification). Certificate available via the Internet. Autoclavable.

Capacity ml	Neck diam. mm	Bottom diam. mm	Height mm	PK	Cat. No.
100	34	64	105	1	9.141 280
250	50	85	140	1	9.141 281
500	50	105	175	1	9.141 282
1000	50	131	220	1	9.141 283



Heating/Shaking incubators

1

1 Incubator Shaker KS4000i control

Innovative incubator shaker design allowing unattended operation in a temperature-controlled environment.

IKA

- large LED display for speed and time settings
- controls with antimicrobial coating for reduction of bacteria
- integrated PID temperature control (two Pt1000 temperature sensors can be used)
- socket in the work area for connection of an additional temperature sensor e.g. PT1000.60 (included in delivery)
- electronic temperature and speed control
- electronic timer switch: 0 to 999h (set by the minute or by the hour)
- KS 4000 ic with built-in cooler for connection to an external cooling unit e.g. RC 2 basic
- unit switches off automatically if disturbed
- unit stops automatically when hood is lifted
- collecting tray for spillages with draining tube at rear of unit
- all functions can be controlled and documented using labworldsoft® software
- attachments not included - Please order accessories as required

Specifications

Shaking movement:	orbital
Orbit:	20 mm
Max. shaker weight (with attachment):	20 kg
Motor rating input/output:	82/24 W
Power consumption:	1120 W (at 230 V)
Operating time:	continuous
Speed range:	10 to 500 rpm
Timer switch (select minutes/hours):	0 to 999 h/continuous
Heater power:	1000 W
Temperature range:	RT +5 °C to 80 °C
Temperature stability (200 ml H ₂ O at target T = 37 °C, RT 25 °C):	0.1 K
Recirculating cooler:	additional cooling function for KS 4000 ic
Dimensions (W x D x H):	580 x 750 x 525 mm
Space required (W x D):	600 x 600 mm
Weight:	55 kg
Permissible ambient temperature:	15 to 32 °C
Protection class acc. to DIN EN 60529:	IP 30
Interface:	RS232
Supply requirements:	230 V 50/60 Hz
Tested to DIN EN IEC 61010-1.	

Type	Nom. capacity L	Plug type	PK	Cat. No.
KS 4000 i control	90	EU	1	9.837 890
KS 4000 i control	90	UK	1	4.008 075
KS 4000 ic control	90	EU	1	9.837 891
KS 4000 ic control	90	UK	1	4.008 077

2

9.837 894

Accessories for Incubator Shaker KS4000i control

AS 4000.1 Universal attachment

IKA

For various types of vessels. Infinitely variable clamping rolls allow universal adaptation to various vessels.

Included with delivery: 1 x AS 1.400 Basic holder, 6 x AS 1.401 Clamping roll, 12 x AS 1.402 Fastening screw

AS 4000.2 Fixing clip attachment

For shaking flasks, Erlenmeyer flasks and bottles with a round crosssection (without fixing clips).

Number of fixing clips (volume): 50 x AS 2.1(25ml), 48 x AS 2.2 (50ml), 25 x AS 2.3 (100ml), 16 x AS 2.4 (250ml), 12 x AS 2.5 (500ml), 7 x AS 2.6 (1000 ml)

AS 4000.3 Dish attachment

For smooth shaking operations in the low viscosity range, e.g. for cell cultures, nutrient media in Petri dishes, culture bottles and vessels with a low centre of gravity. With integrated slip-resistant foil (PP).

3

9.837 893

Type	Description	Dimensions Set-up plate (W x D) mm	Weight g	PK	Cat. No.
AS 4000.1	Universal attachment	360 x 410	3200	1	9.837 894
AS 1.402	Fastening screw*			1	9.837 897
AS 4000.2	Fixing clip attachment	430 x 430	2650	1	9.837 893
AS 4000.3	Dish attachment	430 x 430	800	1	9.837 892
STICKMAX	Adhesive mat	200 x 200		1	6.236 293

*Spare parts for universal attachment.

1 MaxQ 4450 Compact Benchtop Incubated Shakers, orbital

- Holds up to 4 x 1L flasks.
- Requires minimal bench space.
- Choose between two temperature ranges, 5 °C above ambient to 80 °C or 5 °C below ambient to 80 °C.
- Clear lid lets you view samples without disturbing internal temperature
- Triple eccentric drive handles heavy loads, provides uniform agitation and c
ontinuous 24-hour operation, even at high speeds.
- Monitor and control chamber temperature range with ±0.1 °C accuracy and ±0.5 °C uniformity at 37 °C.
- View speed, operating time and temperature simultaneously on three individual LED displays.
- Visual/audible alarms alert you to temperature deviations. Heat turns off if temperature deviates ±1°C of set point.
- Soft start feature eliminates sudden starts and stops, splashing of vessel contents or wetting of flask closure.
- Retains parameters during power failure and restarts unit automatically after power is restored.
- Over-temperature safety feature with independent thermostat provides additional backup
by controlling heat if main temperature controller fails.
- Safety interlock stops platform motion when lid is opened.
- 5 year warranty and 10 year on drive mechanism.

Thermo Scientific



Specifications

Speed range, rpm:	15 to 500 ±1 rpm digital 40 to 400 ±1 rpm analog
Temperature range:	±0.1 °C accuracy at 37°
Operating time:	0.1 hour to 999 hours or 0.1 minute to 999 minutes
Dimensions (L x W x H):	691 x 358 x 401 mm
Supply requirements:	240 V, 50/60 Hz

Type	PK	Cat. No.
MaxQ 4450, Benchtop Incubated Shaker, digital	1	4.011 063
MaxQ 4450, Benchtop Incubated Shaker with Cooling Coil, digital	1	4.011 064

2 Universal Platform for MaxQ Shaker

Thermo Scientific

For	Dimensions (W x D) mm	PK	Cat. No.
MaxQ 4450	280 x 330	1	4.009 327
MaxQ 6000	460 x 460	1	4.009 330



3 Clamps for MaxQ Shaker (except MaxQ 8000)

Thermo Scientific

Description	PK	Cat. No.
Clamps for Microplate/Deep-well plate	1	4.009 340
Clamps for Erlenmeyer Flask 10 ml	1	4.010 229
Clamps for Erlenmeyer Flask 25 ml	1	4.009 332
Clamps for Erlenmeyer Flask 50 ml	1	4.010 230
Clamps for Erlenmeyer Flask 125 ml	1	4.009 333
Clamps for Erlenmeyer Flask 250 ml	1	4.010 231
Clamps for Erlenmeyer Flask 300 ml	1	4.009 334
Clamps for Erlenmeyer Flask 500 ml	1	4.010 232
Clamps for Erlenmeyer Flask 1000 ml	1	4.010 233
Clamps for Erlenmeyer Flask 2000 ml	1	4.009 335
Clamps for Erlenmeyer Flask 4000 ml	1	4.009 336
Clamps for Erlenmeyer Flask 6000 ml	1	4.009 337
Clamps for Low Form Culture Flask 2500 ml	1	4.009 338
Clamps for Fernbach Flask 2800 ml	1	4.009 339



Heating/Shaking incubators



1 MaxQ 6000 Incubated and Refrigerated Stackable Shakers, orbital

Thermo Scientific

- Available in incubated or refrigerated models.
- Units can be stacked two high on the floor with the stacking kit accessory.
- Two adjustable-height shelves provide added storage.
- Large viewing window and internal light offer sample visibility.
- View temperature, speed and time simultaneously on three individual displays.
- Door can be hinged from the right or left by the user for convenient placement in lab.
- Triple eccentric drive handles heavy loads, provides uniform agitation and continuous 24-hour operation, even at high speeds.
- Visual/audible alarms alert you to temperature deviations.
Heat turns off if temperature deviates ± 1 °C of set point.
- Shaker shut down and visual/audible alarms signal if unit operates ± 10 % of set speed, preventing shaker from moving.
- Unbalanced load sensor stops platform motion when excess vibration is detected visual/audio alarms signal until condition is corrected.
- Soft start feature eliminates sudden starts and stops, splashing of vessel contents or wetting of flask closure.
- Retains parameters during power failure and restarts unit automatically after power is restored.
- Over-temperature safety feature with independent thermostat provides additional backup by controlling heat if main temperature controller fails.
- Safety interlock stops shaking motion when the door is open.
- 5 year warranty and 10 year on drive mechanism.

Specifications

Speed range:	15 rpm to 300 rpm ± 1 rpm (stacked) 15 rpm to 500 rpm ± 1 rpm (unstacked)
Temperature	
Floor Shaker:	10 °C above ambient to 80 °C
Refrigerated Floor Shaker:	15 °C below ambient to 80 °C
Timer:	0.1 hr. up to 999 hr. or 0.1 to 999 min.
Power supply	
Floor Shaker:	240 V 50/60 Hz, 4.5A, 1100 W
Refrigerated Floor Shaker:	240 V 50/60 Hz, 7A, 1500 W
Dimensions (L x W x H):	838 x 699 x 1029 mm

Type	Load capacity kg	PK	Cat. No.
MaxQ 6000, Stackable Incubated Floor Shaker, digital	15.9	1	4.011 067
MaxQ 6000S, Stackable Incubated and Refrigerated Floor Shaker	15.9	1	4.011 068



2 Adhesive Flask Mat for MaxQ Shakers

Thermo Scientific

Our Adhesive Flask Mat is an alternative to flask clamps for securing odd shaped objects such as bottles, volumetric flasks and test tube racks to a shaker platform. Simply place the 21 cm x 21 cm Adhesive Flask Mat on an anodised aluminum or stainless steel shaker platform and secure the vessel to it. It will hold Erlenmeyer flasks as large as 4 L that contain 2 L of media at speeds up to 250 rpm. The mat is not suitable for use in water baths.

- Easy-to-view samples. The white background makes it easy to determine when to harvest your samples
- Simple to clean. Can be restored to like new condition by wiping with alcohol
- Long lasting. Months of use without losing adhesive properties

Description	PK	Cat. No.
Flask Mat	1	4.009 506

1 Digital dry bath LLG-uniBLOCKTHERM

Suitable for use in microbiological, histological, clinical, industrial and environmental laboratories. Various types of optional heating blocks are available as accessories for the LLG-uniBLOCKTHERM.

- Digital control with LED display
- Can be used up to 120 °C
- For timer and continuous operation
- Can be used with different heating blocks
- 1 x block unit
- With overheating protection

Scope of supply: LLG-uniBLOCKTHERM, removal tool, lid

Please order heating blocks separately.

Specifications

Temperature range:	RT ... 120 °C
Temperature uniformity:	±0.5 °C
Temperature accuracy:	±0.5 °C
Timer:	0 ... 99:59:00 min
Block material:	Aluminium
Dimensions (W x D x H):	175 x 290 x 85 mm
Weight:	3 kg
Power supply:	220 ... 240 V, 50/60 Hz
Warranty:	3 years

Type	Plug type	PK	Cat. No.
LLG-uniBLOCKTHERM	EU	1	6.263 460
LLG-uniBLOCKTHERM	UK	1	6.263 461



Accessories for LLG-uniBLOCKTHERM

Description	No. of wells	Diam.	Depth	PK	Cat. No.
		mm	mm		
Heating block 54 x 0.2 ml	54	6.4	15	1	6.263 462
Heating block 40 x 0.5 ml	40	8.2	26.4	1	6.263 463
Heating block 40 x 1.5 ml	40	11	34.7	1	6.263 464
Heating block 40 x 2.0 ml	40	11	34.7	1	6.263 465
Heating block 28 x 5/15 ml	28	17	48	1	6.263 466
Heating block 8 x 50 ml	8	29.8	48	1	6.263 467
Heating block for 96/384 Microplate	-	-	-	1	6.263 468
Heating block for each 18 x 0.2 ml, 0.5 ml and 1.5/2.0 ml	-	-	-	1	6.263 469



Heating/Thermoblocks

1

1 Digital Dry Bath AccuBlock™ Mini

Labnet

AccuBlock™ Mini combines digital control, a fast heating microtube block and a convenient AccuRack™ transfer system, all in an ultra compact footprint. With a temperature range to 100 °C which can be set in increments of 0.1 °C, AccuBlock™ Mini is suitable for a range of uses in life science, molecular biology, environmental and industrial laboratories and a variety of applications including incubation, enzyme reactions, immunoassays.

- Accepts up to 12 x 1.5 ml tapered microcentrifuge tubes
- With thermometer well for temperature confirmation and calibration
- Microprocessor controlled heating element
- Easy to read 4 digit LCD display
- Built in calibration mode allows end users to calibrate the bath as needed

The included AccuRack™ allows quick loading or unloading of all sample tubes simultaneously. It is self standing and can be used to hold samples while they are prepared for loading. Samples can also be loaded directly into the AccuBlock™ Mini without the AccuRack™.

Specifications:

Temperature range:	Ambient +5 °C ... 100 °C, resolution 0.1 °C
Temperature uniformity:	±0.2 °C
Temperature accuracy:	±0.2 °C
Timer:	0 ... 19 h 59 min or continuous
Block material:	Anodized aluminum
Block capacity:	12 x 1.5 ml tubes
Dimensions (W x D x H):	140 x 120 x 60 mm
Weight:	1.3 kg
Supply requirements:	230 V 50/60 Hz

Type	PK	Cat. No.
AccuBlock™ Mini	1	9.945 780

2

6.272 368

Dry Baths, AccuBlock™

Labnet

The device is available in single, dual, and four block configurations and provide a broad temperature range up to 150 °C, which makes them useful for a variety of applications in molecular biology, histology, clinical, environmental, and industrial laboratories.

- Single, dual and four block capacity
- Dual display
- USB connectivity enables traceability of data
- Molded block chamber

Please order blocks separately.
Specifications

Temperature range:	Ambient +5 to +150 °C, adjustable in 0.1 °C steps
Temperature uniformity:	±0.2 °C
Temperature resolution:	±0.1 °C
Temperature accuracy:	±0.3 °C
Temperature control:	Microprocessor
Timer:	1 ... 99 h 59 min or continuous
Block material:	Aluminium
Dimensions (W x D x H)	
Single/Dual Block:	210 x 290 x 120 mm
4 Block:	210 x 390 x 120 mm
Weight	
Single/Dual Block:	3.2 kg
4 Block:	4.4 kg
Power supply:	230 V, 50/60 Hz

Type	PK	Cat. No.
Single Block	1	6.272 368 2
Dual Block	1	6.272 369 3
Four Block	1	6.272 370 4

3

6.272 369

4

6.272 370

Accessories for Dry Baths, AccuBlock™

Labnet

Type	For	PK	Cat. No.
Block	24 x 1.5 ml tubes	1	6.224 191
Block	20 x 2.0 ml tubes	1	6.233 664
Block	24 x 0.5 ml tubes	1	6.235 417
Block	48 x 0.2 ml PCR tubes or 6 x 0.2 ml strips	1	9.945 763
Block	12 x 15 ml centrifuge tubes	1	9.945 764
Block	5 x 50 ml centrifuge tubes	1	9.945 765

Dry Block Heaters, digital

Designed for applications that require repeatable results and superior temperature stability. These multi-purpose units are ideal for incubation and activation of cultures, enzyme reactions, immunoassays, melting/boiling points, and a wide variety of other laboratory procedures. Integral support rod holder with locking knob accepts optional External Temperature Probe Kit. Optional External Temperature Probe Kit monitors actual block or sample temperature. Each of the models accept separate interchangeable modular blocks, accommodating various tube sizes from 0.2 ml microtubes to 50 ml centrifuge tubes. Each block has a thermometer well for measuring block temperature. Efficient heating due to close tube-and-block contact for maximum heat retention.

- Microprocessor Control
- LED Display
- Temperature Calibration Mode
- Caution Hot Indicator
- Audible Alarm

Without blocks. Please order separately.

Specifications

Temperature range:	ambient +5 to 120 °C
Temperature stability at 37 °C:	±0.2 °C
Uniformity within block at 37 °C:	±0.2 °C
Uniformity across blocks at 37 °C/Heat up time to 100 °C	
1 block:	-/45 min
2 blocks:	±0.1 °C/50 min
4 blocks:	±0.2 °C/60 min
6 blocks:	±0.3 °C/65 min
Permissible ambient conditions:	18 to 33 °C
Power supply:	230 V, 50/60 Hz

Capacity	Length mm	Width mm	Height mm	PK	Cat. No.
1 block	315	203	89	1	4.659 491
2 blocks	391	203	89	1	4.659 494
4 blocks	429	203	89	1	4.659 495
6 blocks	531	203	89	1	4.659 496

1



4.659 491

2



4.659 495

Blocks for Microcentrifuge and Centrifuge tubes for Dry Block Heaters

For	No. of wells	Diam. mm	Depth mm	PK	Cat. No.
0.5 ml Tubes	30	7.9	27.6	1	4.659 841
1.5 ml Tubes	20	11.1	39.1	1	4.659 843
1.5 ml Eppendorf™ Tubes	20	11.5	39.9	1	4.659 846
2 ml Eppendorf™ Tubes	20	11.5	38.1	1	4.659 875
2 ml Corning™ Tubes	20	10.9	38.1	1	4.659 876
50 ml Conical Tubes	5	29.0	47.6	1	4.659 852
15 ml Conical Tubes	12	17.1	44.5	1	4.659 856

Blocks and Combination Blocks for Standard Test Tubes for Dry Block Heaters

For tubes	No. of wells	Diam. mm	Depth mm	PK	Cat. No.
6 mm	30	8.3	48.4	1	4.659 842
10 mm	24	10.7	48.4	1	4.659 835
12/13 mm	20	13.9	48.4	1	4.659 836
12/13 mm	16	13.9	48.4	1	4.659 849
15/16 mm	12	17.5	48.4	1	4.659 837
17/18 mm	12	19.1	48.4	1	4.659 879
20 mm	8	21.0	48.4	1	4.659 838
25 mm	6	26.2	48.4	1	4.659 839
35 mm	4	35.0	47.6	1	4.659 851
2.5 ml	30	6.35	27	1	4.659 847
6 mm / 12/13 mm / 25 mm	6 / 5 / 3	8.3 / 13.8 / 26.2	48.4 / 48.4 / 48.4	1	4.659 840
1.5 ml / 15 ml / 50 ml	4 / 3 / 2	11.1 / 17.1 / 29.0	39.1 / 44.5 / 47.6	1	4.659 877
0.5 ml / 1.5 ml / 2 ml	6 / 10 / 5	7.9 / 11.1 / 11.5	27.6 / 39.1 / 38.1	1	4.659 878

OHAUS

3



4.659 852

4



4.659 856

5



4.659 842

6



4.659 840

Heating/Thermoblocks



1 Block thermostats PCH-1/PCH-2/PCH-3

Personal benchtop cooling/heating dry block for microcentrifuge tubes. The ingenious block construction, combined with the powerful Peltier module, produces very rapid cooling and heating.

Grant

Temperature range:	-10 to +100 °C
Heat up, amb. to 100 °C:	15 min
Cool down, 100 °C to amb.:	15 min
Cool down, amb. to -10 °C:	21 min

Type	Description	PK	Cat. No.
PCH-1	20 x 0.5 ml and 12 x 1.5 ml microtubes	1	9.721 009
PCH-2	20 x 1.5 ml microtubes	1	9.721 010
PCH-3	20 x 2.0 ml microtubes	1	9.721 066



2 Block thermostat CH3-150 Combitherm-2



Grant

Block thermostat with cooling and heating function and with 2 independent modules for interchangeable blocks, combined in a single unit. Control panel is divided in two parts for separate control of cooling and heating blocks.

- Digital temperature control for optimum precision
- Digital timer with sound alarm
- User adjustable programs for temperature and time: 16 heating programs and 16 cooling programs
- Temperature Calibration Function
- With protective lid

Specifications

Temperature range heating/cooling:	25 ... 150 °C/-3 ... 20 °C
Temperature control range heating/cooling:	ambient +5 ... 150 °C/ambient -23 ... ambient +5 °C
Temperature uniformity:	±0.1 °C
Temperature accuracy:	0.1 °C
Timer:	1 min ... 99 h 59 min
Dimensions (W x D x H):	295 x 285 x 220 mm
Weight:	5.6 kg
Power supply:	230 V, 50/60 Hz

Type	PK	Cat. No.
CH3-150 Combitherm-2	1	7.983 641



3 Changeable blocks for CH3-150 Combitherm-2



Grant

For tubes	No. of wells	Depth mm	Description	PK	Cat. No.
12 mm	18	58	round bottom	1	4.671 969
13 mm	10	30	flat bottom	1	4.671 968
16 mm	10	56	flat bottom	1	7.983 642
25 mm	6	40	flat bottom	1	7.983 643
29 mm	5	40	flat bottom	1	4.671 972
48 mm	2	58	flat bottom	1	4.671 970
1.5 ml	23		conical bottom	1	4.671 971

We can supply this
**manufacturer's whole
 product range !**



1 Microtube block thermostat BTD

Grant's block heating system BTD with fixed block is designed for rapid and precise heating of microtubes up to 100 °C.

Grant

- Digital temperature control for optimum precision
- Heating block holds combinations of four microtube sizes simultaneously
 - up to a total of 49 tubes: 24 x 1.5/2.0 ml, 15 x 0.5 ml, 10 x 0.2 ml
- Flexible tube sizes and rapid heat-up time enables swift change of application
- Convenient integral timer for time-sensitive incubations
- Sturdy, durable, easy-to-clean plastic construction; compact design with small footprint
- 2-line display for simple and precise setting of temperature/time and for monitoring current status during operation

Specifications

Temperature range: ambient +5 to 100 °C
 Stability at 37 °C: ±0.1 °C
 Uniformity: ±0.1 °C
 Heat-up times: 25 °C to 100 °C in 15 min
 25 °C to 37 °C in 4 min
 Timer: 1 min to 96 h
 Power supply: 230 V, 50/60 Hz

Type	Dimensions (W x D x H) mm	Power W	PK	Cat. No.
BTD	210 x 230 x 110	200	1	6.223 310



2 3 Block thermostats, QBD and QBH series

For controlled dry heating of test tubes, microplates and Eppendorf tubes in interchangeable aluminium blocks. The following models are available:

Grant

- Choose from 3 digital systems with 1, 2 or 4 interchangeable blocks (QBD models) and 1 digital high-temperature system (QBH2) with 2 blocks
- Fast heat-up time and in-block temperature sensing capability using external sensor probe. Please order Cat. No. 6.228 714 separately.
- Built-in timer, programmable delayed start and RS232 output for data monitoring
- Includes block removal tool

Requires but does not include interchangeable QB-series blocks

Specifications

Temperature range: ambient 5 to 130 °C, QBH2: ambient 5 to 200 °C
 Stability at 37 °C: ±0.1 °C
 Uniformity within the block at 37 °C: ±0.1 °C
 across similar blocks at 37 °C: ±0.2 °C
 Supply requirements: 230 V, 50/60 Hz, single phase

Type	Width mm	Length mm	Height mm	Power W	Blocks accepted	PK	Cat. No.
QBD1	200	230	100	150	1	1	9.852 307
QBD2	200	280	100	300	2	1	9.852 308
QBD4	200	380	100	600	4	1	9.852 309
QBH2	200	280	100	300	2	1	9.852 310

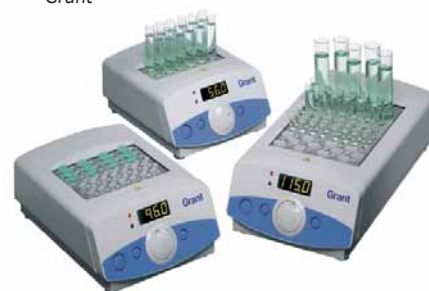

3



4 Digital block thermostats QB, for QBD, QBH series

Accessory blocks for QB series only. Interchangeable. Machined aluminium, (L x W x H) 140 x 50 x 63 mm. Holes drilled as indicated.

Grant

Type	For tubes diam. mm	No. of holes	PK	Cat. No.
QB-10	10 mm	24	1	9.951 661
QB-12	12 mm	24	1	9.951 662
QB-16	16 mm	12	1	9.951 663
QB-18	18 mm	12	1	9.951 664
QB-24	24 mm	5	1	9.951 665
QB-50	50 ml	4	1	6.075 814
QB-H	0.2 ml	56	1	9.951 666
QB-E0	0.5 ml	24	1	9.951 667
QB-E1	1.5 ml	24	1	9.951 668
QB-E2	2.0 ml	24	1	9.951 669
QB-E5	5.0 ml	12	1	6.266 809

Further blocks available on request.

4



Heating/Thermoblocks

1

9.852 300

Block Heaters, analogue and digital, SBH series

- choice of either analogue or digital models
- digital models available with either 130 or 200 °C maximum temperature
- three block model for extra capacity
- dual control models have two blocks with independent temperature control
- uniform and stable block temperatures

Stuart

Designed for the precise heating of test-tubes, microcentrifuge tubes, cuvettes and microplates. Range comprises an economical analogue model with easy to use, dial setting and advanced digital models with bright, easy to read, LED display which facilitates setting of the required temperature and also accurate monitoring of the actual temperature. Excellent temperature stability and uniformity is maintained via sensitive, microprocessor control. Heats to 100°C in <12 mins.

Supplied complete with block extraction tool but without aluminium blocks which must be ordered separately. With BioCote, silver-based, antimicrobial protection.

2

9.852 303

Specifications

Temperature stability at 37 °C: ±0.1 °C
 Uniformity within block at 37 °C: ±0.1 °C
 Uniformity within block at 130 °C: ±1 °C
 Electrical supply: 230 V 50 Hz

SBH130 // SBH130D // SBH200D

Number of blocks: 2
 Temperature range: Amb.+8 °C to +130 °C // Amb.+8 °C to +130 °C // Amb.+8 °C to +200 °C

Display type: Calibrated knob // LED // LED
 Display resolution: 10 °C // 0.1 °C // 0.1 °C
 Dimensions (W x D x H) mm: 235 x 280 x 115 mm
 Net weight: 2.1 kg // 2.3 kg // 2.3 kg
 Heater power: 300W

SBH130D/3 // SBH200D/3

Number of blocks: 3
 Temperature range: Amb.+8 °C to +130 °C // Amb.+8 °C to +200 °C

Display type: LED
 Display resolution: 0.1 °C
 Dimensions (W x D x H) mm: 310 x 280 x 115 mm
 Net weight: 3.2 kg
 Heater power: 450 W

SBH130DC // SBH200DC

Number of blocks: 2 (independent control)
 Temperature range: Amb.+8 °C to +130 °C // +50 °C to +200 °C

Display type: LED
 Display resolution: 0.1 °C
 Dimensions (W x D x H) mm: 310 x 280 x 115 mm
 Net weight: 2.9 kg
 Heater power: 300 W

3

6.207 050

Type	Description	PK	Cat. No.
SBH130	Block heater, 2 block, analogue, 130 °C	1	9.852 300 1
SBH130D	Block heater, 2 block, digital, 130 °C	1	9.852 301
SBH200D	Block heater, 2 block, digital, 200 °C	1	9.852 302
SBH130D/3	Block heater, 3 block, digital, 130 °C	1	7.624 685
SBH200D/3	Block heater, 3 block, digital, 200 °C	1	9.852 303 2
SBH130DC	Block heater, 2 block, digital, dual control, 130 °C	1	6.207 050 3
SBH200DC	Block heater, 2 block, digital, dual control, 200 °C	1	9.852 315

4

Aluminium blocks SHT for block heaters Stuart SBH series

Stuart

For	PK	Cat. No.
20 x 10.5 mm Ø tubes	1	9.951 617
20 x 12.5 mm Ø tubes	1	9.951 618
12 x 16.5 mm Ø tubes	1	9.951 619
8 x 19.5 mm Ø tubes	1	9.951 620
Solid, for user to drill as required	1	9.951 621
48 x 0.2 ml centrifuge tubes	1	9.951 622
20 x 1.5 ml Eppendorf Tubes®	1	9.951 623
20 x 2.0 ml Eppendorf Tubes®	1	9.951 624
15 x 10 mm cuvettes*	1	9.951 625

*Separations can be removed to take larger cells

Dry Block Heater

Digital block heaters for 1, 2, 3 or 4 aluminium blocks provides precise temperature control in small vessels. Included PT 1000 temperature sensor allows temperature control directly in the sample vessel. It is used with PCR tubes, PCR strips, Greiner tubes, microplates and cuvettes. The block heater is ideal for melting and boiling point determination, enzyme reactions, incubation and activation of cultures, immunoassays, DNA denaturation, culture media tests, coagulation tests, blood-urea-nitrogen determinations and in situ hybridizations.

- Stepless adjustable temperature up to 120 °C
- Timer: Countdown, adjustable from 1 min to 99 h 59min
- Counter: Display of heating time
- Highly versatile with a large number of blocks
- Error code display
- Fixed safety circuit
- Acoustic signal at end of test

Without blocks. Please order separately.

Specifications

Temperature range	RT to +120 °C
Display:	LED
Heat control accuracy:	±1 K
Connection for ext. temperature sensor:	DIN 12878
Control accuracy with sensor:	±1 K
Temperature constancy in medium:	±1 K
Temperature stability within the blocks at 37 °C:	±0.2 °C
Temperature stability within the blocks at 60 °C:	±0.4 °C
Fixed safety circuit:	+150 °C
Protection class acc. to DIN EN 60529:	IP 21
Power supply:	220-240 V, 50/60 Hz

IKA



9.816 801



9.816 807

Type	Dimensions (W x D x H)	Dimensions Set-up plate (W x D)	Heating power	Plug type	PK	Cat. No.
	mm	mm				
Dry Block Heater 1	151 x 228 x 73	95 x 76	165	EU	1	9.816 801 1
Dry Block Heater 1	151 x 228 x 73	95 x 76	165	UK	1	9.816 802
Dry Block Heater 1	151 x 228 x 73	95 x 76	165	CH	1	9.816 803
Dry Block Heater 2	151 x 304 x 73	95 x 152	250	EU	1	9.816 804
Dry Block Heater 2	151 x 304 x 73	95 x 152	250	UK	1	9.816 805
Dry Block Heater 2	151 x 304 x 73	95 x 152	250	CH	1	9.816 806
Dry Block Heater 3	151 x 380 x 73	95 x 228	330	EU	1	9.816 807 2
Dry Block Heater 3	151 x 380 x 73	95 x 228	330	UK	1	9.816 808
Dry Block Heater 3	151 x 380 x 73	95 x 228	330	CH	1	9.816 809
Dry Block Heater 4	151 x 456 x 73	95 x 304	412	EU	1	9.816 810
Dry Block Heater 4	151 x 456 x 73	95 x 304	412	UK	1	9.816 811
Dry Block Heater 4	151 x 456 x 73	95 x 304	412	CH	1	9.816 812

Aluminium blocks for Dry Block Heater

Type	Description	PK	Cat. No.
DB 1.1	Single block for PCR tubes (0.5 ml), holes (diam. x D): 7.9 x 27.6 mm	1	9.816 813 3
DB 1.2	Single block for Eppendorf® microtubes (1.5 ml), holes (diam. x D): 11.5 x 36.9 mm	1	9.816 814
DB 3.1	Single block for centrifuge tube combination 0.5 ml, 15 ml, 50 ml	1	9.816 815
DB 3.2	Single block for microtube combination 1.5 ml, 15 ml, 50 ml	1	9.816 816
DB 6.3	Double block for 1 x 96 well plates (0.2 ml), holes (diam. x D): 6.4 x 15.5 mm	1	9.816 817
DB 7.1	Double block for 96 or 384 wellplates, depth: 13.5 mm	1	9.816 818

Further blocks available on request.

IKA



9.816 813

Heating/Thermoblocks

1



1 Dry Block Heater Matrix Δ+

NEW

IKA

Powerful Dry Block Heater for samples with very small volumes, e.g. blood samples, pharmaceutical agents, DNA/RNA samples, DNA/RNA samples or Elisa assays.

Wide range of exchangeable attachments for various applications available.

- Without cross-contamination
- Large and clear display with a convenient menu structure allows for intuitive operation
- Robust aluminum die cast housing

Please order attachments separately.

Specifications

Temperature range:	ambient -30 ... 100 °C
Temperature control:	±1 K
Heating/cooling rate:	±5 K/min
Uniformity:	0.5 °C
Display:	TFT
Programs:	2
Timer:	1 s ... 6000 min
Capacity:	0.3 kg
Dimensions (W x D x H):	220 x 350 x 125 mm
Weight:	8.8 kg
Power consumption:	100 W
Power supply:	100 ... 240 V, 50/60 Hz
IP code:	IP 21

Type	PK	Cat. No.
Matrix Δ+	1	4.664 745

2



2 Cooling/Heating block Eppendorf ThermoStat C

Eppendorf AG

The ideal device to accurately set and maintain temperatures.

Precise temperature control is achieved using optimally balanced heating and cooling elements (peltier technology). The cooling and heating temperature keys provide quick access to five important experimental temperatures (4 °C, 16 °C, 37 °C, 56 °C and 95 °C).

You can also individually store 15 programs.

- Excellent temperature accuracy
- Precise temperature control from -10 to +110 °C
(+110 °C can be set when using 12 mm and cryo SmartBlocks™)
- Prevent condensation and improve temperature homogeneity with the new ThermoTop
- Comprehensive range of program functions

Specifications

Temperature operation range:	min: +30 °C below RT, max: +110 °C
Temperature adjustable range:	-10 to +110 °C (+110 °C can be set when using 12 mm and cryo SmartBlocks™)
Accuracy/ resolution:	±0.5 °C at +20 to +45 °C
Max. heating time:	5.5 °C/min
Max. cooling time:	5 °C/min between +110 °C and RT
Dimensions (W x D x H):	206 x 304 x 131 mm
Capacity:	dependent on Eppendorf SmartBlock™
Weight:	4.3 kg
Power consumption:	200 W (max.)
Power supply:	220 - 240 V ±10 %, 50/60 Hz

Type	Description	PK	Cat. No.
Eppendorf ThermoStat C	Basic device without Eppendorf SmartBlock™	1	9.776 903

1 Exchangeable blocks Eppendorf SmartBlocks™ and accessories for Eppendorf ThermoMixer™ C and ThermoStat C

Exchangeable blocks:

Flexibility has never been this easy.

Eppendorf offers a variety of SmartBlocks™ for tubes from 0.5 ml to 50 ml.

- Fast and simple block exchange due to Eppendorf Quick Release
- Optimized block design guarantees maximum temperature transfer to the sample

Transfer Racks:

- Autoclavable transport aid for tubes from 0.5 to 2.0 ml
- For transferring up to 24 tubes in/from the heating block at the same time
- Offers protection against burns when transferring hot samples

SmartExtender:

A heatable frame/attachment for mixer, with separate temperature control (3 °C above RT to 110 °C), for simultaneous operation at two different temperatures.

- Enables 2 incubations at the same time

Eppendorf AG

Type	Description	PK	Cat. No.
Eppendorf SmartBlock™ 0.5 mL	24 tubes, 0.5 ml	1	9.776 906
Eppendorf SmartBlock™ 1.5 mL	24 tubes, 1.5 ml	1	9.776 907
Eppendorf SmartBlock™ 2.0 mL	24 tubes, 2.0 ml	1	9.776 908
Eppendorf SmartBlock™ 5.0 mL	8 Eppendorf Tubes®, 5.0 ml	1	9.776 909
Eppendorf SmartBlock™ 15 mL	8 conical tubes, 15 ml	1	9.776 910
Eppendorf SmartBlock™ 50 mL	4 conical tubes, 50 ml	1	9.776 911
Eppendorf SmartBlock™ 12 mm	24 tubes, diam. 11 to 11.9 mm	1	9.776 912
Eppendorf SmartBlock™ cryo	24 cryogenic tubes, 1.5 to 2.0 ml, all bottom forms	1	9.776 913
Eppendorf SmartBlock™ plates	For micro plates and Deepwell plates, incl. lid	1	9.776 914
Eppendorf SmartBlock™ PCR 96	PCR plates 96, incl. lid	1	9.776 915
Eppendorf SmartBlock™ PCR 384	PCR plates 384, incl. lid	1	9.776 916
Eppendorf SmartExtender™	12 tubes 1.5 - 2.0 ml	1	4.664 579
Transfer Rack	For 24 tubes, 0.5 ml	1	6.280 936
Transfer Rack	For 24 tubes, 1.5 to 2.0 ml	1	6.280 935

1



1

9.868 022

Constant Climate Chambers HPP

They are simply unbeatable in energy efficiency. Furthermore, as constant climate chambers HPP have a very long maintenance free service life, they are perfectly suited for stability tests, storage in controlled environments and conditioning. The high precision temperature control as well as the active humidification and dehumidification were particularly adapted to the ICH guidelines, option Q1A, for stability tests.

Memmert

- LED light module for sizes 110 to 750 (as an option): dimmable LED light in three alternative colour temperatures (cold white light, warm white light or cold white and warm white light, dimmable in steps of 1 %)
 - Heating and cooling seamlessly with one system thanks to Peltier technology
- Almost vibration-free and extremely quiet

Model variant TwinDISPLAY: ControlCOCKPIT with two colour displays

You can find a detailed description of the "TwinDISPLAY" model at www.memmert.com

Specifications

Working temperature range sizes 110 - 1060: without light, without humidity:	0 (at least 20 °C below ambient) to +70 °C
without light, with humidity:	+5 °C (at least 20 °C below ambient) to +70 °C
Working temperature range sizes 110 - 750: with light, without/with humidity:	+15 to +40 °C
Setting temperature range sizes 1400 - 2200: without light, without/with humidity:	+15 °C (at least 10 °C below ambient) to +60 °C
Setting accurate temperature:	0.1 °C
Setting ranges humidity:	
Sizes 110 - 1060: without light	10 to 90 % rh
Size 1400 - 2200: without light	10 to 80 % rh
Sizes 110 - 750: with light	10 to 85 % rh
Setting accurate humidity:	0.5 % rh
Power supply:	230 V, 50/60 Hz

Type	Nom. capacity	Max. grids	Included grids	Internal dimensions (W x D x H) mm	External dimensions (W x D x H) mm	Rated capacity kW	Net weight kg	PK	Cat. No.
	L								
HPP110	108	5	2	560 x 400* x 480	745 x 656** x 864	0.65	77	1	9.868 021
HPP260	256	9	2	640 x 500* x 800	824 x 756** x 1183	0.92	122	1	9.868 022
HPP410	384	14	2	640 x 500* x 1200	824 x 756** x 1720	1.30	160	1	6.312 191
HPP750	749	14	2	1040 x 600* x 1200	1224 x 856** x 1720	1.50	208	1	9.868 023
HPP1060	1060	14	2	1040 x 850* x 1200	1224 x 1107** x 1720	1.60	260	1	6.272 235
HPP1400	1360	28	4	1250 x 750* x 1450	1435 x 1007** x 1913	3.10	450	1	6.286 315
HPP2200	2140	42	6	1972 x 750* x 1450	2157 x 1007** x 1913	3.50	493	1	6.312 160

* Less 10 mm for fan-Peltier

**Depth without door handle, please add 56mm

2

Options and accessories for constant climate chamber HPP

Light module cold white 6.500 K:

LED strips arranged on the side walls of the interior, 10 for model 110; 14 for models 260, 410 and 750; programme controlled dimming from 0 to 100 % (in 1 % steps); ramp programming in combination with temperature and humidity

Memmert

Light module cold white 6.500 K + warm white 2.700 K:

LED light strips - 10 strips for model 110; 14 strips for model 260, 410 and 750 (5 resp. 7 alternating cold white light strips and 5 resp. 7 warm white light strips); on the side walls of the interior, programme controlled dimming from 0 to 100 % (in 1 % steps); ramp programming in combination with temperature and humidity

Type	Description	For Volume l	PK	Cat. No.
T7	Light module cold white 6,500 kelvin	110	1	9.868 024
T7	Light module cold white 6,500 kelvin	260	1	9.868 025
T7	Light module cold white 6,500 kelvin	410/750	1	9.868 026
T8	Light module cold white 6,500 kelvin + warm white 2,700 kelvin	110	1	9.868 027
T8	Light module cold white 6,500 kelvin + warm white 2,700 kelvin	260	1	9.868 028
T8	Light module cold white 6,500 kelvin + warm white 2,700 kelvin	410/750	1	9.868 029
E20165	Stainless steel grid	110	1	6.232 433
E28891	Stainless steel grid	260/410	1	9.537 204
E20182	Stainless steel grid	750	1	6.222 688
B41251	Stainless steel grid	1060	1	6.312 988
B38955	Stainless steel grid	1400/2200	1	4.663 195
B00325	Perforated stainless steel shelf	110	1	9.867 707
B29725	Perforated stainless steel shelf	260/410	1	6.262 685
B00328	Perforated stainless steel shelf	750	1	6.266 306
B32549	Perforated stainless steel shelf	1060	1	6.310 098

Further accessories can be found in our online shop.

Climate Chambers ICHeco



1

Climate-friendly and powerful: the ICHeco climate chamber for the stability testing of pharmaceuticals, cosmetics or food works with environmentally-friendly CO₂ (R744) as refrigerant. No icing, no drying out of samples, no dehumidification of the working chamber. Compared to appliances with refrigerant R134a, it scores with faster cooling-down times. In the ICHeco L climate chamber, stability tests in accordance with ICH guidelines Q1B, option 2, can be performed, thanks to an illumination unit. Fluorescent lights with cold white light (daylight: light colour 865, 6.500 K) and UV radiation in the spectral range of 320 - 400 nm. Daylight and UV light comply with standard illuminant D65.

Model variant TwinDISPLAY: ControlCOCKPIT with two colour displays

You can find a detailed description of the "TwinDISPLAY" model at www.memmert.com

- Different variants of ICHeco:
- ICHeco with humidity control
- ICHeco L with humidity control and light



9.538 024

Specifications

Working temperature range with humidity and/or light (ICHeco/ICHeco L):	+10 °C to +60 °C
Working temperature range without humidity (ICHeco):	-10°C to +60°C
Working temperature range without humidity (ICHeco L):	0 °C to +60 °C
Setting temperature range ICHeco:	-10 to +60 °C
Setting temperature range ICHeco L:	0°C to +60°C
Setting accuracy temperature:	0.1 °C
Setting range humidity:	10 to 80 % rh
Setting accuracy humidity:	0.5 % rh
Power supply:	230 V, 50/60 Hz

Type	Nom. capacity	Max. grids	Included grids	Internal dimensions (W x D x H) mm	External dimensions (W x D x H) mm	Rated capacity kW	Net weight kg	PK	Cat. No.
L									
ICH110eco	108	5	2	560 x 400* x 480	745 x 585** x 1233	1.35	114	1	6.314 847
ICH260eco	256	9	2	640 x 500* x 800	824 x 685** x 1552	1.35	165	1	9.538 024
ICH750eco	749	14	2	1040 x 600* x 1200	1224 x 785** x 1950	1.35	254	1	9.538 025
ICH110Leco	108	5	2	560 x 400* x 480	745 x 585** x 1233	1.45	114	1	6.314 850
ICH260Leco	256	9	2	640 x 500* x 800	824 x 685** x 1552	1.45	165	1	9.538 026
ICH750Leco	749	14	2	1040 x 600* x 1200	1224 x 785** x 1950	1.55	254	1	9.538 027

* Less 33 mm for fan
 **Depth without door handle, please add 56 mm

Further products can be found in our online shop.

Humidity Chambers HCP



2

The Memmert humidity chamber HCP - This climate chamber offers a full range of comfort, reliability and safety. This humidity chamber is ideally suited for environmental testing, environmental simulation, accelerated service life tests and 85/85 tests according to IEC 60068-2-67 and IEC 60068-2-78.

The active humidity control is the guarantee for ideal homogeneity of temperature and humidity as well as for short recovery times after opening the door. In combination with heating on all six sides, including heated inner glass door, it also minimises vaporisation in the interior and thus the risk of condensed water dripping onto the test object. An aluminium thermal conductive layer supports optimum temperature distribution and serves as a heat accumulator in case of a temporary power failure.

Model variant TwinDISPLAY: ControlCOCKPIT with two colour displays

You can find a detailed description of the "TwinDISPLAY" model at www.memmert.com



4.662 063

Specifications

Setting range active humidity control:	20 to 95 % rh
Setting accurate humidity:	0.5 % rh
Working temperature range:	at least 7 °C above ambient up to +90 °C
Setting temperature range:	+18 °C to +90 °C
Setting accurate temperature:	0.1 °C
Power supply:	230 V, 50/60 Hz

Type	Nom. capacity	Max. grids	Included shelves	Internal dimensions (W x D x H) mm	External dimensions (W x D x H) mm	Rated capacity kW	Net weight kg	PK	Cat. No.
L									
HCP50	56	5	1	400 x 330* x 425	559 x 521** x 795	1.52	55	1	4.662 063
HCP105	107	6	2	560 x 400* x 480	719 x 591** x 850	1.72	75	1	4.662 064
HCP150	156	10	2	560 x 400* x 700	719 x 591** x 1070	1.80	90	1	4.662 065
HCP240	241	12	2	600 x 500* x 810	759 x 691** x 1180	1.84	110	1	4.662 066

* Less 35 mm for fan
 **Depth without door handle, depth of door handle 56 mm

Suitable accessories can be found in our online shop.

Heating/Test incubators

1



1 Constant climate chambers, KBF/KMF series

For long-term stable temperature/humidity simulations in one chamber.
The constant climate chambers are ideal for norm-compliant work according to ICH guidelines and work independently of the water supply.

BINDER

KBF Series: Constant climate chambers with large temperature range:
0 °C to 70 °C and humidity range: 10 % RH to 80 % RH.

KMF Series: Ideal for demanding stress tests, e.g. at 85 °C and 85 % RH.
Temperature range: -10 °C to 100 °C and humidity range 10 % RH to 98 % RH.

Equipment:

- Electronically controlled APT.line™ preheating chamber with cooling system
- Inner chamber made of stainless steel
- Intuitive touchscreen controller with time-segment and real-time programming with internal data recording
- Humidity regulation with capacitive humidity sensor and vapor humidification
- Inner glass door with seal
- Independent temperature safety device class 3.1 (DIN 12880) with optical and audible temperature alarm
- Avoidance of glass corrosion by special TIMELESS coating
- Access port with silicone plug diam. 30 mm, left side
- Door heating
- Ethernet interface for communication software APT-COM™ DataControlSystem
- Internal data logger, measured values can be read out in open format via USB
- Power supply 200 ... 230 V, 50/60 Hz

Type	Internal volume litres	External dimensions (W x D x H) mm	Internal dimensions (W x D x H) mm	PK	Cat. No.
KBF 115	102	880 x 650 x 1050	600 x 351 x 483	1	6.270 830
KBF 240	247	925 x 800 x 1460	650 x 485 x 785	1	4.661 323
KBF 720	700	1250 x 890 x 1925	973 x 576 x 1250	1	6.291 134
KBF 1020	1020	1250 x 1145 x 1925	976 x 836 x 1250	1	4.661 324
KMF 115	102	880 x 650 x 1050	600 x 351 x 483	1	6.287 692
KMF 240	247	930 x 800 x 1465	650 x 485 x 785	1	4.661 325
KMF 720	700	1250 x 890 x 1925	973 x 576 x 1250	1	4.661 326

2



2 Constant climate chambers, KBF P/KBF LQC

NEW
BINDER

For long-term stable temperature/humidity simulations in one chamber.
The constant climate chambers are ideal for norm-compliant work according to ICH guidelines and work independently of the water supply.

KBF P Series: Constant climate chambers with ICH-compliant lighting and variably positionable light cassettes.

KBF LQC Series: Constant climate chambers with ICH-compliant light source and patented light dose control for UV-A and VIS. Temperature range: 0 °C to 70 °C and humidity range: 10 % RH to 80 % RH.

Equipment:

- Electronically controlled APT.line™ preheating chamber with cooling system
- Inner chamber made of stainless steel
- Intuitive touchscreen controller with time-segment and real-time programming with internal data recording
- Humidity regulation with capacitive humidity sensor and vapor humidification
- Inner glass door with seal
- Independent temperature safety device class 3.1 (DIN 12880) with optical and audible temperature alarm
- Avoidance of glass corrosion by special TIMELESS coating
- Access port with silicone plug diam. 30 mm, left side
- Door heating
- Ethernet interface for communication software APT-COM™ DataControlSystem
- Internal data logger, measured values can be read out in open format via USB
- Power supply 200 ... 230 V, 50/60 Hz

Type	Internal volume litres	External dimensions (W x D x H) mm	Internal dimensions (W x D x H) mm	PK	Cat. No.
KBF P 240	247	925 x 800 x 1460	650 x 485 x 785	1	9.883 583
KBF P 720	700	1250 x 890 x 1925	973 x 1250 x 576	1	9.883 584
KBF LQC 240	247	925 x 800 x 1460	650 x 485 x 785	1	6.236 223
KBF LQC 720	700	1250 x 890 x 1925	973 x 576 x 1250	1	6.236 224

1 Constant climate chambers series KBF-S Solid.Line

Constant climate chambers for long-term tests and accelerated stability tests of pharmaceutical products according to the ICH guideline Q1A. With corrosion and condensate-free stainless steel interior for homogeneous temperature and humidity conditions.

BINDER

- Electronically controlled APT.line™ preheating chamber with cooling system
- Inner chamber made completely of stainless steel
- 2 stainless steel racks incl. shelf support
- Intuitive touchscreen controller with time segment and real-time programming with internal measured value recording
- Humidity control with capacitive humidity sensor and vapor humidification
- Independent temperature safety device class 3.1 (DIN 12880) with optical and audible alarm
- Access port with silicone plug diam. 30mm, left side
- LCD display for indication of temperature, humidity, alarms and additional information
- Internal data logger with USB interface
- Independent water supply via canisters
- Models from 240 l capacity with double swivel castors and brake

Specifications

Humidity range:	20 ... 80 % r.F.
Humidity accuracy:	2.0 %
Temperature range:	0 ... 70 °C
Temperature accuracy:	±0.1 °C
Computer interface:	Ethernet
Power supply:	200 ... 230 V, 50/60 Hz

Type	Internal volume litres	External dimensions (W x D x H) mm	Internal dimensions (W x D x H) mm	Plug type	PK	Cat. No.
KBF-S 115	102	880 x 650 x 1050	600 x 351 x 483	EU	1	6.275 186
KBF-S 240	247	925 x 800 x 1460	650 x 485 x 785	EU	1	4.665 284
KBF-S 270	700	1250 x 890 x 1925	973 x 576 x 1250	EU	1	4.665 286
KBF-S 1020	1020	1250 x 1145 x 1925	976 x 1250 x 836	EU	1	6.275 188



Material test chambers, FP and M series

The material test chambers from BINDER are highly precise and have a wide temperature range, as well as comprehensive programming options, with which you can customise ramps, profiles and processes.

BINDER

FP Series: Material test chamber with forced convection.
M Series: Material test chambers with individual programming.

- Electronically controlled APT.line™ preheating chamber assuring temperature accuracy and reproducible results
- Adjustable fan speed
- 2 chrome-plated racks
- Temperature range from 5°C above ambient temperature to 300 °C
- Independent adjustable temperature safety device class 2 (DIN 12880), with visual temperature alarm
- RS 422 interface for use with APT-COM™ DataControlSystem communication software



9.883 710



9.883 565

Type	Internal volume litres	External dimensions (W x D x H) mm	Internal dimensions (W x D x H) mm	Type of auxiliary energy	PK	Cat. No.
FP 53	53	635 x 575 x 620	400 x 340 x 400	230 V, 50/60 Hz	1	9.883 710
FP 115	115	835 x 645 x 705	600 x 410 x 480	230 V, 50/60 Hz	1	9.883 711
FP 240	240	1035 x 745 x 825	800 x 510 x 600	230 V, 50/60 Hz	1	9.883 712
FP 400	400	1235 x 765 x 1025	1000 x 510 x 800	400 V, 50/60 Hz	1	9.883 713
FP 720	720	1235 x 865 x 1530	1000 x 610 x 1200	400 V, 50/60 Hz	1	9.883 714
M 53	53	635 x 575 x 780	400 x 340 x 400	230 V, 50/60 Hz	1	9.883 563
M 115	115	835 x 645 x 865	600 x 410 x 480	230 V, 50/60 Hz	1	9.883 564
M 240	240	1035 x 745 x 985	800 x 510 x 600	230 V, 50/60 Hz	1	9.883 565
M 400	400	1235 x 765 x 1185	1000 x 510 x 800	400 V, 50/60 Hz	1	9.883 566
M 720	720	1235 x 865 x 1695	1000 x 610 x 1200	400 V, 50/60 Hz	1	9.883 567

Growth chambers, KBW, KBWF series

Homogeneous lighting conditions with constant temperature and humidity conditions, the BINDER growth chambers. The responsive humidification system, the high-performance cooling and uniform light distribution ensure optimal growth conditions.

BINDER

KBW Series: Growth chambers with light.

KBWF Series: Growth chambers with light and humidity.

Equipment:

- Electronically controlled APT.line™ preheating chamber
- Temperature range 0 °C to 70 °C (without humidity and illumination)
- Humidity range 10 % to 80 % RH (KBWF)
- 2 variable position illumination cassettes each with 5 daylight fluorescent illumination tubes
- Controller with time-segment and real-time programming
- Humidity regulation with capacitive humidity sensor and vapor humidification (KBWF)
- Independent temperature safety device class 3.1 (DIN 12880) with optical and audible temperature alarm
- Ethernet or RS 422 interface for communication software APT-COM™ DataControlSystem

Type	Internal volume litres	External dimensions (W x D x H) mm	Internal dimensions (W x D x H) mm	Type of auxiliary energy	PK	Cat. No.
KBW 240	247	925 x 800 x 1460	650 x 485 x 785	200 ... 240 V, 50 Hz	1	9.883 573
KBW 400	400	925 x 800 x 1945	650 x 485 x 1270	200 ... 240 V, 50/60 Hz	1	9.883 535
KBW 720	698	1255 x 887 x 1925	970 x 576 x 1270	200 ... 240 V, 50/60 Hz	1	9.883 574
KBWF 240	247	930 x 800 x 1460	650 x 485 x 785	200 ... 240 V, 50 Hz	1	9.883 575
KBWF 720	720	1255 x 890 x 1925	973 x 576 x 1250	200 ... 240 V, 50 Hz	1	9.883 576



9.883 535



9.883 576



3 Rapid incinerator

For individual and series incineration of solids and liquids. Upper platform with 8 openings of 34 mm diameter, for porcelain crucibles up to 50 mm diameter. Upper platform and housing made of stainless steel. With 120 minute timer with audible signal after timed period and separate continuous operation switch. A safety switch switches the mains supply off/on automatically on opening/closing the incinerator chamber. With 1.5 metre cable and earthed plug.

Gestigkeit

Type SVR/E

With electronic temperature control which allows stepless heating adjustment from 10 to 100 %. Complete for use.

Type SVD 95

With digital temperature adjustment and display. Complete for use.

Type	Dimensions (W x D x H) mm	Rating W	Temp. range max. °C	Supply requirements V	Weight kg	PK	Cat. No.
SVR/E	450 x 310 x 180	2500	950	230	7	1	9.884 140
SVD 95	450 x 310 x 180	2500	950	220	7	1	9.884 141
Heating element EH 400 for SVR/E (spare part)						1	9.884 142
Heating element EH 95 for SVD 95 (spare part)						1	9.884 143

Muffle furnaces up to 1300 °C



1

High temperature furnaces with glass fibre insulated chamber.
Suitable for applications in industry, science and medicine.

- Ceramic bottom plate
- Side-opening, down-opening or top-opening door, depending on model
- Controls easily accessible in the socket
- Fast heating times
- Furnace housing made of powder-coated metal
- Good temperature stability
- Energy saving
- Models with Omron E5CC controller: time and temperature can be set
- Models with Omron E5CC-T controller: 8 storable programs



4.669 221

Model numbers with "1100" up to 1100 °C
Model numbers with "1300" up to 1300 °C

Type	Nom. capacity	Description	Internal dimensions (W x D x H) mm	Type of auxiliary energy	PK	Cat. No.
	L					
SNOL 3/1100 LHM01*	3	Top-opening	120 x 200 x 105	230 V, 50 Hz	1	4.669 202
SNOL 8.2/1100 LHM01*	8	Top-opening	195 x 310 x 135	230 V, 50 Hz	1	4.669 203
SNOL 8.2/1100 LSM01*	8	Side-opening	195 x 310 x 135	230 V, 50 Hz	1	4.669 204
SNOL 8.2/1100 LZM01*	8	Down-opening	195 x 310 x 135	230 V, 50 Hz	1	4.669 205
SNOL 13/1100 LHM01*	13	Top-opening	220 x 335 x 170	230 V, 50 Hz	1	4.669 206
SNOL 22/1100 LHM01*	22	Top-opening	280 x 500 x 160	230 V, 50 Hz	1	4.669 207
SNOL 39/1100 LHM01*	39	Top-opening	320 x 495 x 230	400 V, 50 Hz	1	4.669 208
SNOL 6.7/1300 LSM01*	7	Side-opening	145 x 310 x 135	230 V, 50 Hz	1	4.669 209
SNOL 10/1300 LHM01*	10	Top-opening	190 x 335 x 170	230 V, 50 Hz	1	4.669 210
SNOL 3/1100 LHM01**	3	Top-opening	120 x 200 x 105	230 V, 50 Hz	1	4.669 220
SNOL 8.2/1100 LHM01**	8	Top-opening	195 x 310 x 135	230 V, 50 Hz	1	4.669 221
SNOL 8.2/1100 LSM01**	8	Side-opening	195 x 310 x 135	230 V, 50 Hz	1	4.669 222
SNOL 8.2/1100 LZM01**	8	Down-opening	195 x 310 x 135	230 V, 50 Hz	1	4.669 223
SNOL 13/1100 LHM01**	13	Top-opening	220 x 335 x 170	230 V, 50 Hz	1	4.669 224
SNOL 22/1100 LHM01**	22	Top-opening	280 x 500 x 160	230 V, 50 Hz	1	4.669 225
SNOL 39/1100 LHM01**	39	Top-opening	320 x 495 x 230	400 V, 50 Hz	1	4.669 226
SNOL 6.7/1300 LSM01**	7	Side-opening	145 x 310 x 135	230 V, 50 Hz	1	4.669 227
SNOL 10/1300 LHM01**	10	Top-opening	190 x 335 x 170	230 V, 50 Hz	1	4.669 228

* with Omron E5CC controller
**with Omron E5CC-T controller

2 Muffle Furnaces Series LE 1/11 - LE 14/11 up to 1100 °C

Nabertherm

2

Compact muffle furnaces with dual shell furnace housing of rust-free stainless steel and heating elements encased in quartz glass tubes.

- Tmax 1100 °C, working temperature 1050 °C
- Heating from two sides from heating elements in quartz glass tubes
- Maintenance-friendly replacement of heating elements and insulation
- Insulation only made of materials that are classified as not carcinogenic acc. to TRGS 905, class 1 or 2
- Housing made of sheets of textured stainless steel
- Dual shell housing for low external temperatures and high stability
- Flap door which can also be used as a work platform
- Exhaust air outlet in rear wall
- Compact dimensions and light weight
- Controller mounted under the door to save space
- Equipped with the basic controller R 7 with one free storeable temperature, which is dwelled until the controller is switch off
- Standard power supply 230 V, 1/N/PE, 50/60 Hz



Type/Controller	Capacity	External dimensions (W x D x H) mm	Internal dimensions (W x D x H) mm	Rating kW	Weight kg	PK	Cat. No.
LE 1/11/R7	1	290 x 280 x 406	90 x 115 x 110	1.5	10	1	9.764 543
LE 2/11/R7	2	330 x 385 x 406	110 x 180 x 110	1.8	10	1	9.764 537
LE 6/11/R7	6	390 x 434 x 466	170 x 200 x 170	1.8	18	1	9.764 539
LE 14/11/R7	14	440 x 534 x 516	220 x 300 x 220	2.9	25	1	9.764 541

External dimensions vary for versions with additional equipment. Dimensions on request.

Safety gloves, heat protection - please see page 239.

Heating/Ovens, Furnaces

Muffle furnaces series L/LT 1100 °C to 1400 °C

For daily laboratory use. Models with flap door or lift door available, for temperatures from 1100 °C to 1400 °C.

Nabertherm

- Dual shell housing made of textured stainless steel sheets for low external temperatures and high stability
- Adjustable air inlet integrated in door
- Exhaust air outlet in rear wall of furnace
- Solid state relays provide low-noise operation
- Optionally available with flap door (L models) that can be used as work platform or with lift door (LT models) with hot surface facing away from the operator
- Available with the programmable controllers B 410 and C 450 with adjustable ramps and hold times (L 1/12 with R7 or 3216)
- All insulation materials used are classified as non-carcinogenic according to TRGS 905, Class 1 or 2
- Standard connection 220-240 V 1/N/PE 50/60 Hz

1100 °C and 1200 °C models

- Ceramic heating plates with integrated heating wire, splash and exhaust protected, easy to replace
- heating from two sides (heating from three sides for muffle furnaces with interior volumes of 24 litres and 40 litres)

1300 °C and 1400 °C models

- Heating elements on support tubes for free heat radiation, short heating times and long service life
- Heating from two sides

Optional

- Chimney, chimney with fan or catalytic converter
- Over-temperature limiter with adjustable cutout temperature for thermal protection class 2 in accordance with EN 60519-2 as temperature limiter to protect the furnace and load
- Protective gas connection to purge with non-flammable protective or reaction gases (not available in combination with chimney, chimney with fan or catalytic converter)
- Manual or automatic gas supply system
- Process control and documentation via VCD software package for monitoring, documentation and control

1



1

Muffle furnaces series LT 3/11 - LT 40/11, max. 1100 °C, with lift door

Max. temperature 1100 °C. Lift door with hot surface facing away from the operator.

Nabertherm

Type	Nom. capacity	Internal dimensions (W x D x H) mm	External dimensions (W x D x H) mm	Power consumption W	PK	Cat. No.
LT 3/11/B410	3	160 x 140 x 100	385 x 330 x 405	1200	1	6.241 787
LT 5/11/B410	5	200 x 170 x 130	385 x 390 x 460	2400	1	6.260 949
LT 9/11/B410	9	230 x 240 x 170	415 x 455 x 515	3000	1	6.241 499
LT 15/11/B410	15	230 x 340 x 170	415 x 555 x 515	3500	1	6.237 183
LT 24/11 *	24	280 x 340 x 250	490 x 555 x 580	4500	1	6.274 993
LT 40/11/B410*	40	320 x 490 x 250	530 x 705 x 580	6000	1	6.239 613

*400 V 3/N/PE 50/60 Hz connector as standard

External dimensions vary for versions with additional equipment. Dimensions on request.

2



2

Muffle furnaces series L 3/11 - L 40/11, max. 1100 °C, with flap door

Max. temperature 1100 °C. Flap door can be used as work platform.

Nabertherm

Type	Nom. capacity	Internal dimensions (W x D x H) mm	External dimensions (W x D x H) mm	Power consumption W	PK	Cat. No.
L 3/11/B410	3	160 x 140 x 100	385 x 330 x 405	1200	1	6.059 769
L 5/11/B410	5	200 x 170 x 130	385 x 390 x 460	2400	1	6.092 769
L 9/11/B410	9	230 x 240 x 170	415 x 455 x 515	3000	1	6.302 391
L 15/11/B410	15	230 x 340 x 170	415 x 555 x 515	3500	1	6.056 446
L 24/11/B410*	24	280 x 340 x 250	490 x 555 x 580	4500	1	6.206 861
L 40/11/B410*	40	320 x 490 x 250	530 x 705 x 580	6000	1	7.660 691

* 400 V 3/N/PE 50/60 Hz connector as standard

External dimensions vary for versions with additional equipment. Dimensions on request.

1 Muffle furnaces series LT 3/12 - LT 40/12, max. 1200 °C, with lift door

Max. temperature 1200 °C. Lift door with hot surface facing away from the operator.

Nabertherm

Type	Nom. capacity	Internal dimensions (W x D x H) mm	External dimensions (W x D x H) mm	Power consumption W	PK	Cat. No.
LT 3/12/B410	3	160x 140 x 100	385 x 330 x 405	1200	1	6.256 646
LT 5/12/B410	5	200 x 170 x 130	385 x 390 x 460	2400	1	6.284 369
LT 9/12/B410	9	230 x 240 x 170	415 x 455 x 515	3000	1	6.244 089
LT 15/12/B410	15	230 x 340 x 170	415 x 555 x 515	3500	1	6.240 063
LT 24/12/B410*	24	280 x 340 x 250	490 x 555 x 580	4500	1	6.287 691
LT 40/12/B410*	40	320 x 490 x 250	530 x 705 x 580	6000	1	4.660 518

* 400 V 3/N/PE 50/60 Hz connector as standard

External dimensions vary for versions with additional equipment. Dimensions on request.



2 Muffle furnaces series L 1/12 - L 40/12, max. 1200 °C, with flap door

Max. temperature 1200 °C. Flap door can be used as work platform.

Nabertherm

Type	Nom. capacity	Internal dimensions (W x D x H) mm	External dimensions (W x D x H) mm	Power consumption W	PK	Cat. No.
L 1/12	1	90 x 115 x 110	290 x 280 x 430	1500	1	4.675 300
L 3/12/B410	3	160 x 140 x 100	385 x 330 x 405	1200	1	6.201 618
L 5/12/B410	5	200 x 170 x 130	385 x 390 x 460	2400	1	6.223 409
L 9/12/B410	9	230 x 240 x 170	415 x 455 x 515	3000	1	6.226 450
L 15/12/B410	15	230 x 340 x 170	415 x 555 x 515	3500	1	6.233 463
L 24/12/B410*	24	280 x 340 x 250	490 x 555 x 580	4500	1	6.265 211
L 40/12/B410*	40	320 x 490 x 250	530 x 705 x 580	6000	1	6.234 225

* 400 V 3/N/PE 50/60 Hz connector as standard

External dimensions vary for versions with additional equipment. Dimensions on request.



Ashing furnaces up to 1300 °C



Ashing furnaces with glass fibre insulated chamber. Suitable for applications in industry, science and medicine.

- Fan-assisted chimney for air extraction
- Side- opening, down-opening or top-opening door, depending on model
- Continuous air change in the chamber
- Controls easily accessible in the socket
- Fast heating times
- Furnace housing made of powder-coated metal
- Good temperature stability
- Energy saving
- Models with Omron E5CC controller: time and temperature can be set
- Models with Omron E5CC-T controller: 8 storable programs

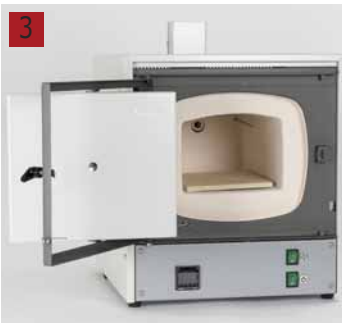

4.669 231

Model numbers with "1100" up to 1100 °C

Model numbers with "1300" up to 1300 °C

Type	Nom. capacity	Description	Internal dimensions (W x D x H) mm	Type of auxiliary energy	PK	Cat. No.
SNOL 3/1100 LHM21*	3	Top-opening	120 x 200 x 105	230 V, 50 Hz	1	4.669 211
SNOL 8,2/1100 LHM21*	8	Top-opening	195 x 310 x 135	230 V, 50 Hz	1	4.669 212
SNOL 8,2/1100 LSM21*	8	Side-opening	195 x 310 x 135	230 V, 50 Hz	1	4.669 213
SNOL 8,2/1100 LZM21*	8	Down-opening	200 x 300 x 133	230 V, 50 Hz	1	4.669 214
SNOL 13/1100 LHM21*	13	Top-opening	220 x 335 x 170	230 V, 50 Hz	1	4.669 215
SNOL 22/1100 LHM21*	22	Top-opening	280 x 500 x 160	230 V, 50 Hz	1	4.669 216
SNOL 39/1100 LHM21*	39	Top-opening	320 x 495 x 230	400 V, 50 Hz	1	4.669 217
SNOL 6,7/1300 LSM21*	7	Side-opening	145 x 310 x 135	230 V, 50 Hz	1	4.669 218
SNOL 10/1300 LHM21*	10	Top-opening	190 x 335 x 170	230 V, 50 Hz	1	4.669 219
SNOL 3/1100 LHM21**	3	Top-opening	120 x 200 x 105	230 V, 50 Hz	1	4.669 229
SNOL 8,2/1100 LHM21**	8	Top-opening	195 x 310 x 135	230 V, 50 Hz	1	4.669 230
SNOL 8,2/1100 LSM21**	8	Side-opening	195 x 310 x 135	230 V, 50 Hz	1	4.669 231
SNOL 8,2/1100 LZM21**	8	Down-opening	195 x 310 x 135	230 V, 50 Hz	1	4.669 232
SNOL 13/1100 LHM21**	13	Top-opening	220 x 335 x 170	230 V, 50 Hz	1	4.669 233
SNOL 22/1100 LHM21**	22	Top-opening	280 x 500 x 160	230 V, 50 Hz	1	4.669 234
SNOL 39/1100 LHM21**	39	Top-opening	320 x 495 x 230	400 V, 50 Hz	1	4.669 235
SNOL 6,7/1300 LSM21**	7	Side-opening	145 x 310 x 135	230 V, 50 Hz	1	4.669 236
SNOL 10/1300 LHM21**	10	Top-opening	190 x 335 x 170	230 V, 50 Hz	1	4.669 237

* with Omron E5CC controller

**with Omron E5CC-T controller

Heating/Ovens, Furnaces



6.310 023



6.310 029

High-temperature chamber furnaces with air circulation NA/N

Nabertherm

These chamber furnaces with air circulation are characterized by their extremely high temperature uniformity. Hence, they are especially suitable for processes such as cooling, crystallizing, preheating, curing, but also for numerous processes in tool making. Due to the modular concept, the forced convection furnaces can be adjusted to the process requirements by adding suitable equipment.

- Tmax 450 °C, 650 °C, or 850 °C
- Horizontal air circulation
- Swing door hinged on the right
- Temperature uniformity up to ± 4 °C according to DIN 17052-1 (model NA 15/65 up to ± 5 °C)
- Optimum air flow and temperature uniformity through high circulation rates
- One frame sheet and rails for two additional trays included in the scope of delivery (NA 15/65 without frame sheet)
- Stainless steel air-baffles in the furnace for optimum air circulation
- Base frame included in the delivery, NA 15/65 designed as table-top model
- Air inlet and exhaust air flaps as additional equipment for using as drying oven
- NTLog Basic for Nabertherm controller: recording of process data with USB-flash drive
- Available with the programmable controllers B 400 and C 440 with adjustable ramps and hold times (NA 15/65 with B 410 or C 450)
- Standard power supply 400 V 3/N/PE 50/60 Hz (NA 15/65: 220 - 240 V, 1/N/PE)

Type/Controller	Temp. max. °C	Capacity L	Rating kW	Internal dimensions (W x D x H) mm	External dimensions (W x D x H) mm	PK	Cat. No.
NA 30/45/B400	450	30	3.6	290 x 420 x 260	1040 x 1290 x 1385	1	6.310 019
NA 60/45/B400	450	60	6.6	350 x 500 x 350	1100 x 1370 x 1475	1	6.310 021
NA 120/45/B400	450	120	9.8	450 x 600 x 450	1250 x 1550 x 1550	1	6.310 023
NA 250/45/B400	450	250	12.8	600 x 750 x 600	1350 x 1650 x 1725	1	6.310 025
NA 500/45/B400	450	500	18.8	750 x 1000 x 750	1550 x 1900 x 1820	1	6.310 027
NA 15/65 HA/B410*	650	15	2.8	295 x 340 x 170	470 x 790 x 460	1	6.310 029
NA 30/65/B400	650	30	7.0	290 x 420 x 260	870 x 1290 x 1385	1	6.310 031
NA 60/65/B400	650	60	10.0	350 x 500 x 350	910 x 1390 x 1475	1	6.310 033
NA 120/65/B400	650	120	13.0	450 x 600 x 450	990 x 1470 x 1550	1	6.310 035
NA 250/65/B400	650	250	21.0	600 x 750 x 600	1170 x 1650 x 1680	1	6.310 037

*Standard power supply 220-240 V 1/N/PE 50/60 Hz

External dimensions vary for versions with additional equipment. Dimensions on request.



6.226 571



6.285 618

Chamber furnaces

NEW

Nabertherm

The chamber furnaces are suitable for Annealing, Hardening and Brazing.

The furnaces can be extended with a variety of accessories, like annealing boxes for operation under protective gas, roller guides, or a cooling station with a quench tank. Even high-performance applications like the annealing of titanium can be implemented without the use of expensive and complicated annealing systems.

- Robust insulation with light refractory bricks
- Deep furnace chamber with three-sides heating: from both side walls and bottom
- Low energy consumption due to multi-layer insulation
- Base frame included
- N 7/H - N 17/HR designed as table-top model
- Parallel guided downward swinging door (user protected from heat radiation)
- NTLog Basic for Nabertherm controller: recording of process data with USB-flash drive
- Available with the programmable controllers B 400 and C 440 with adjustable ramps and hold times

Type	Temp. max. °C	Capacity L	Internal dimensions (W x D x H) mm	External dimensions (W x D x H) mm	Type of auxiliary energy	PK	Cat. No.
N 7/H	1280	9	250 x 250 x 140	800 x 650 x 600	230 V, 1/N/PE, 50 Hz	1	6.226 571
N 11/H	1280	11	250 x 350 x 140	800 x 750 x 600	230 V, 1/N/PE, 50 Hz	1	6.227 200
N 11/HR	1280	11	250 x 350 x 140	800 x 750 x 600	400 V, 3/N/PE, 50 Hz	1	6.226 570
N 31/H	1280	30	350 x 350 x 250	1040 x 1100 x 1340	400 V, 3/N/PE, 50 Hz	1	4.675 220
N 41/H	1280	40	350 x 500 x 250	1040 x 1250 x 1340	400 V, 3/N/PE, 50 Hz	1	6.241 122
N 61/H	1280	60	350 x 750 x 250	1040 x 1500 x 1340	400 V, 3/N/PE, 50 Hz	1	6.285 618
N 87/H	1280	87	350 x 1000 x 250	1040 x 1750 x 1340	400 V, 3/N/PE, 50 Hz	1	4.675 221

1 Tube Furnaces

These compact tube furnaces with integrated control systems can be used universally for many processes. Equipped with a standard working tube of C 530 ceramic and two fiber plugs, these tube furnaces have an unbeatable price/performance ratio.

Nabertherm



- Tmax 1200 °C or 1300 °C
- Single-zoned design as standard
- Dual shell housing made of sheets of textured stainless steel
- Outer tube diameter of 50 to 170 mm, heated length from 250 to 1000 mm
- Working tube of C 530 ceramic including two fiber plugs as standard equipment
- Solid state relays provide for lownoise operation
- Available with the programmable controllers B 410, C 450 and P 480 (for three-zoned design) with adjustable ramps and hold times
- Standard power supply 400 V 3/N/PE 50/60 Hz (R 50/250 und R 50/500: 220 V, 1/N/PE, 50/60 Hz)

Option:

- Over-temperature limiter with adjustable cutout temperature for thermal protection class 2 in accordance with EN 60519-2 as temperature limiter to protect the furnace and load
- Charge control with temperature measurement in the working tube and in the furnace chamber outside the tube
- Three-zoned design (heated length from 500 mm)
- Working tubes
- Gas supply systems for protective gas or vacuum operation
- Process control and documentation with VCD software package

Type/Controller	Tube diam. mm	Tube length mm	Max. temp. °C	Dimensions (W x D x H) mm	Power W	PK	Cat. No.
R 50/250/12/B410	40	450	1200	434 x 340 x 508	1.6	1	9.764 651
R 50/500/12/B410	40	700	1200	670 x 340 x 508	2.3	1	9.764 653
R 170/750/12/B410	150	1100	1200	920 x 460 x 628	11.5	1	9.764 659
R 170/1000/12/B410	150	1350	1200	1170 x 460 x 628	11.5	1	9.764 661
R 50/250/13/B410	40	450	1300	434 x 340 x 508	1.6	1	9.764 663
R 50/500/13/B410	40	700	1300	670 x 340 x 508	2.3	1	9.764 665
R 120/500/13/B410	100	850	1300	670 x 410 x 578	6.5	1	9.764 667
R 170/750/13/B410	150	1100	1300	920 x 460 x 628	11.5	1	9.764 671
R 170/1000/13/B410	150	1350	1300	1170 x 460 x 628	11.5	1	9.764 673
R 120/500/12/B410	100	850	1200	670 x 410 x 578	6.5	1	9.764 655

2 3 Tube Furnaces with Stand

NEW

Nabertherm

These compact tube furnaces are used when laboratory experiments must be performed horizontally, vertically, or at specific angles. The ability to configure the angle of tilt and the working height, and their compact design, also make these tube furnaces suitable for integration into existing process systems.

- Vertical or horizontal operation freely adjustable
- Working height freely adjustable
- Working tube made of C 530 ceramic
- Control system integrated in furnace base
- NTLog Basic for Nabertherm controller: recording of process data with USB-flash drive
- Available with the programmable controllers B 410 and C 450 with adjustable ramps and hold times

Specifications

Power input: 1800 W
 Power supply: 230 V, 1/N/PE, 50/60 Hz

Type	Tube diam. mm	Tube length mm	Temp. max. °C	Dimensions (W x D x H) mm	Weight kg	PK	Cat. No.
RT 50-250/11	50	360	1100	350 x 380 x 740	25	1	6.242 203
RT 50-250/13	50	360	1300	350 x 380 x 740	25	1	6.240 831
RT 30-200/15	30	360	1500	445 x 475 x 740	45	1	4.675 222

4 Glass drying pistol

Ideally suited for drying of small sample volumes. This sample dryer, for analysing substances and synthetic products, uses heat, desiccant and vacuum at the same time for optimum results. Its temperature range can be adjusted between +30 °C to +160 °C, with a temperature stability of ±1°C.

LABC-Labortechnik

- The two-part drying vessel is approximately two parts of DURAN® glass:
- 1) Drying tube with an outer diameter of 44 mm, length inside 200 mm, joint NS45.
 - 2) Ground flask with stopcock for connection to a vacuum pump.

The glass drying oven needs to be fixed with screw stand rod at the laboratory stand to be secured. Dimensions (without mounting for tripod and Flask): H 120 mm x B 195 mm x T 185 mm. Weight: 2 kg

Supplied with: Glass drying oven consisting of heating element with support rod and glassware with ground drying tube and ground flask with stopcock.

Type	PK	Cat. No.
Glass drying oven	1	6.269 737
Glassware for Glass drying oven	1	6.269 738

2



3



4





HORO Dr. Hofmann GmbH



Electric Laboratory Burner

A universal heat source for laboratory and education

- Heating
- Drying
- Tempering
- Humidifying
- EX-proofed
- Individual

HORO Dr. Hofmann GmbH
 Rudolf-Diesel-Straße 2-8
 73760 Ostfildern-Nellingen
 Germany

Tel.: +49 711 341 6995-0
 Fax: +49 711 341 6995-19
 info@horo.eu
 www.horo.eu



made in Germany

Volumetric apparatus	910
Measuring cylinders	910
Mixing cylinders	916
Graduated flasks	917
Pipettes	927
Volumetric pipettes	927
Graduated pipettes	931
Pasteur pipettes	936
Serological pipettes.....	938
Pipette controllers.....	939
Pipette balls.....	942
Pipettes Accessories.....	943
Capillary tubes	946
Microlitre pipettes.....	949
Positive displacement pipettes	979
Pipette tips	981
Reagent Reservoirs	1000
Dispensing	1002
Hand dispensers	1002
Bottletop dispensers	1009
Titration	1021
Burettes	1021
Titrators	1027
Digital burettes	1031
Pumps	1037
Drum pumps.....	1037
Peristaltic pumps	1042
Dosing pumps	1053
Rotary piston pumps	1054
Microfluidics	1055
Syringe pumps	1055
Hoses and connections	1057

1

1

Measuring cylinders, borosilicate glass 3.3, tall form, class A, blue graduated

- Conformity certified with batch ID
- DIN EN ISO 4788
- Hexagonal foot with spout
- Calibrated to contain (IN)
- Inscriptions are printed with blue enamel
- Batch certificate can be downloaded from website

ISOLAB

Capacity	Tolerance	Max. height	PK	Cat. No.
ml	± ml	mm		
5	0.05	115	1	9.274 170
10	0.10	140	1	9.274 171
25	0.25	170	1	9.274 172
50	0.50	200	1	9.274 173
100	0.50	260	1	9.274 174
250	1.00	335	1	9.274 175
500	2.50	390	1	9.274 176
1000	5.00	470	1	9.274 177
2000	10.00	570	1	9.274 178

2

2

Measuring cylinders, DURAN®, tall form, class A, blue graduation

IN (TD) calibrated. With spout and hexagonal glass base. Main point ring graduation. With dated batch identification. Declaration of conformity acc. to DIN 12600.

Hirschmann

Graduation in durable blue enamel, acc. to DIN EN ISO 4788.

For those products batch calibration reports, which are free of charge, can be generated and printed on www.hirschmannlab.com. Additional single calibration reports or DAkkS certificates (former DKD calibration reports) are available.

Capacity	Grad.	Tolerance	Height	PK	Cat. No.
ml	ml	± ml	mm		
5	0.1	0.05	115	1	9.274 180
10	0.2	0.1	140	1	9.274 181
25	0.5	0.25	170	1	9.274 182
50	1	0.5	200	1	9.274 183
100	1	0.5	260	1	9.274 184
250	2	1.0	335	1	9.274 185
500	5	2.5	390	1	9.274 186
1000	10	5.0	470	1	9.274 187
2000	20	10.0	500	1	9.274 188

Also available with dated batch identification acc. to USP (US Pharmacopeia).

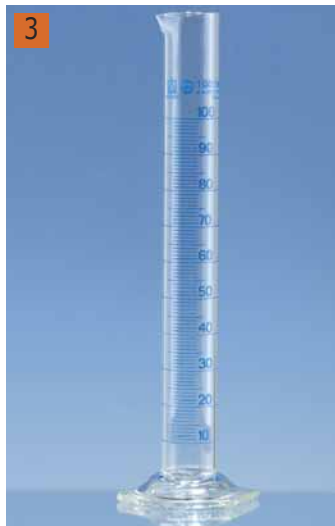
3

3

Measuring cylinders, borosilicate glass 3.3, tall form, class A, blue graduated

With spout, tall form. BLAUBRAND®. To DIN EN ISO 4788.

BRAND

DE-M marking with works certified batch number. With spout and hexagonal foot.

Graduations and inscriptions in highly contrasting blue enamel. Calibrated to contain (IN). All BLAUBRAND® cylinders are delivered with batch number and batch certificate. Also available with individual works, USP, or DAkkS (former DKD) calibration certificate on request. The batch certificate is also available to download from the manufacturer's website.

Capacity	Grad.	Tolerance	Height	PK	Cat. No.
ml	ml	± ml	mm		
5	0.1	0.05	115	1	9.274 105
10	0.2	0.10	140	1	9.274 108
25	0.5	0.25	170	1	9.274 120
50	1	0.5	200	1	9.274 128
100	1	0.5	260	1	9.274 138
250	2	1.0	335	1	9.274 148
500	5	2.5	365	1	9.274 154
1000	10	5.0	465	1	9.274 162
2000	20	10	505	1	9.274 164

1 Measuring cylinders USP, borosilicate glass 3.3, tall form, class A, blue graduated

DIN EN ISO 4788, DE-M marking. Calibrated to contain (IN). Ring marks at major graduations. Marks and inscriptions in high contrast blue enamel. With spout and hexagonal base. Incl. USP batch certificate. On request, also available with USP individual certificate.

BRAND

Capacity	Grad.	Tolerance	Height	PK	Cat. No.
ml	ml	± ml	mm		
5	0.1	0.05	115	1	6.261 319
10	0.2	0.10	140	1	6.261 318
25	0.5	0.17	170	1	6.261 317
50	1	0.25	200	1	6.261 316
100	1	0.5	260	1	6.261 315
250	2	1.0	335	1	6.261 314
500	5	2.0	365	1	9.275 006
1000	10	3.0	465	1	6.261 313
2000	20	6.0	505	1	9.275 007

1



2 Measuring cylinders, DURAN®, tall form, class A, amber stain graduation

IN (TC) calibrated. With spout and hexagonal glass base. Main point ring graduation. With dated batch identification. Declaration of conformity acc. to DIN 12600.

Hirschmann

With durable amber stain graduation, acc. to DIN EN ISO 4788.

For those products batch calibration reports, which are free of charge, can be generated and printed on www.hirschmannlab.com. Additional single calibration reports or DAkkS certificates (former DKD calibration reports) are available.

Capacity	Grad.	Tolerance	Height	PK	Cat. No.
ml	ml	± ml	mm		
5	0.1	0.05	115	1	6.901 399
10	0.2	0.1	140	1	6.250 413
25	0.5	0.25	170	1	6.700 903
50	1.0	0.5	200	1	6.201 104
100	1.0	0.5	260	1	6.303 988
250	2.0	1.0	335	1	6.250 483
500	5.0	2.5	390	1	6.222 339
1000	10.0	5.0	470	1	6.200 496
2000	20.0	10.0	500	1	6.206 675

2



3 Measuring cylinders, Borosilicate glass 3.3, tall form, class B, white graduation

Flawless spout design assures pouring without any drips. Thick and durable polypropylene base reduces the risk of breakage during use and cleaning. Base perfectly fits the cylinder body and can easily be dismantled.

ISOLAB

Capacity	PK	Cat. No.
ml		
10	2	6.286 599
25	2	6.286 600
50	2	6.286 601
100	2	6.286 602
250	2	6.286 603
500	2	6.286 604
1000	2	6.286 605

3



4 Measuring cylinders, DURAN®, tall form, class B, blue graduation

IN (TD) calibrated. With spout and hexagonal glass base, short line. Tolerances better than class B requirements. Graduation in durable blue enamel, acc. to DIN EN ISO 4788.

Hirschmann

Capacity	Grad.	Tolerance	Height	PK	Cat. No.
ml	ml	± ml	mm		
5	0.1	0.075	115	1	9.274 198
10	0.2	0.15	140	1	9.274 199
25	0.5	0.375	170	1	9.274 200
50	1	0.75	200	1	9.274 201
100	1	0.75	260	1	9.274 202
250	2	1.5	335	1	9.274 203
500	5	3.75	390	1	9.274 204
1000	10	7.5	470	1	9.274 206
2000	20	15.0	500	1	9.274 207

4



1

1

Measuring cylinders, DURAN®, tall form, class B, amber stain graduation

IN (TC) calibrated. With spout and hexagonal glass base, short line. Tolerances better than class B requirements. With durable amber stain graduation, DIN EN ISO 4788.

Hirschmann

Capacity	Grad.	Tolerance	Height	PK	Cat. No.
ml	ml	± ml	mm		
5	0.1	0.075	115	1	6.078 159
10	0.2	0.15	140	1	6.200 432
25	0.5	0.375	170	1	6.200 433
50	1.0	0.75	200	1	7.200 508
100	1.0	0.75	260	1	6.510 180
250	2.0	1.5	335	1	6.200 434
500	5.0	3.8	390	1	6.510 181
1000	10.0	7.5	470	1	6.510 182
2000	20.0	15.0	500	1	6.510 183
5000*	50.0	37.5	650	1	7.510 242

* Supplementary to DIN.

2

2

Measuring cylinders, borosilicate glass 3.3, tall form, class B, amber graduation

Available with glass, or detachable plastic, feet and PP protective collars (plastic feet and collar are not autoclavable). With spout, tall form. SILBERBRAND Eterna. Class B.

BRAND

To DIN EN ISO 4788. With spout and hexagonal foot.

Graduations and inscriptions in Eterna permanent amber stain. Calibrated to contain (IN).

Capacity	Grad.	Tolerance	Height	Foot	PK	Cat. No.
ml	ml	± ml	mm			
5	0.1	0.08	115	Glass	1	9.274 005
10	0.2	0.15	140	Glass	1	9.274 008
25	0.5	0.4	170	Glass	1	9.274 020
50	1	0.8	200	Glass	1	9.274 028
100	1	0.8	260	Glass	1	9.274 038
250	2	1.5	335	Glass	1	9.274 048
500	5	4	365	Glass	1	9.274 054
1000	10	8	465	Glass	1	9.274 062
2000	20	15	505	Glass	1	9.274 064

3

3

Measuring cylinders, DURAN®, low form, class B, amber stain graduation

IN (TC) calibrated. With spout and hexagonal glass base. Tolerances better than class B requirements. Short line graduation. With durable amber stain graduation, DIN EN ISO 4788.

Hirschmann

Capacity	Grad.	Tolerance	Height	PK	Cat. No.
ml	ml	± ml	mm		
10	1	0.3	100	1	9.274 190
25	1	0.5	125	1	9.274 191
50	2	1.0	150	1	9.274 192
100	2	1.0	170	1	9.274 193
250	5	2.0	220	1	9.274 194
500	10	5.0	255	1	9.274 195
1000	20	10.0	295	1	9.274 196
2000	50	20.0	345	1	9.274 197

4

4

Measuring cylinders, Borosilicate glass 3.3, low form, class B, amber graduations

Low form. SILBERBRAND Eterna. DIN EN ISO 4788. With spout and hexagonal foot. Graduations and inscriptions in Eterna permanent amber stain. Calibrated to contain IN.

BRAND

Capacity	Grad.	Height	Tolerance	PK	Cat. No.
ml	ml	mm	± ml		
10	1	90	0,3	1	9.274 608
25	1	115	0,5	1	9.274 620
50	2	145	1	1	9.274 628
100	2	165	1	1	9.274 638
250	5	195	2	1	9.274 648
500	10	250	5	1	9.274 654
1000	20	285	10	1	9.274 662
2000	50	340	20	1	9.274 664

1 Measuring cylinders, PP, tall form, class B, blue graduations



ISOLAB

Tall form, highly transparent, with blue graduations, hexagonal base, calibrated to contain (IN). Tolerances class B according to DIN 12681/ISO 6706. Exposure to temperatures above 60°C may effect accuracy. Cleaning up to max. 60°C is recommended to preserve marks and inscriptions.

Capacity ml	Tolerance ± ml	Height mm	PK	Cat. No.
10	0.200	135	1	9.274 080
25	0.500	160	1	9.274 081
50	1.000	195	1	9.274 082
100	1.000	240	1	9.274 083
250	2.000	320	1	9.274 084
500	5.000	380	1	9.274 085
1000	10.000	465	1	9.274 086

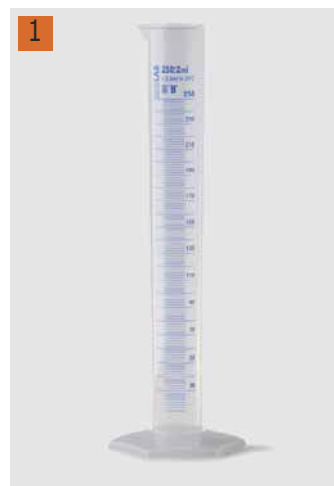

2 Measuring cylinders, PP, tall form, class B, moulded graduations



ISOLAB

- Manufactured from ultra clear, virgin polypropylene and its thick walls eliminate distortion.
- They offer high transparency, chemical resistance and remarkable heat tolerance.
- They meet the highest quality standards according to DIN 12681 and ISO 6706.
- Individually calibrated through automatic calibration process carried out by robots.
- Permanent quality control through all steps eliminate possible deviations from nominal values.
- Cylinders are calibrated to contain (In) and the tolerances are according to DIN/ISO Class "B" standards.
- Graduations are embossed and specially designed for plastic and resistant to 60°C.
- For consistent accuracy, polypropylene measuring cylinders should not be used with liquids over 60°C and should not be kept under direct sunlight or overheated conditions.

Capacity ml	Tolerance ± ml	Grad. ml	Height mm	PK	Cat. No.
10	0.2	0.2	135	1	6.243 541
25	0.5	0.5	160	1	6.243 542
50	1.0	1.0	195	1	6.243 543
100	1.0	1.0	240	1	6.243 544
250	2.0	2.0	320	1	6.243 545
500	5.0	5.0	380	1	6.243 546
1000	10.0	10.0	465	1	6.243 547



3 Graduated cylinders, PP, tall form, class B, embossed scale



BRAND

Transparent. Exposure to temperatures up to 80°C will not cause permanent exceeding of tolerance limits! Cleaning temperature below 60°C is recommended to preserve marks and inscriptions.

- DIN 12681 and ISO 6706
- Calibrated to contain (TC, In)

Capacity ml	Type	Grad. ml	Tolerance ± ml	Height mm	PK	Cat. No.
10	With batch certificate	0.2	0.2	145	1	9.274 760
25	With batch certificate	0.5	0.5	170	1	9.274 761
50	With batch certificate	1.0	1.0	200	1	9.274 762
100	With batch certificate	1.0	1.0	250	1	9.274 763
250	With batch certificate	2.0	2.0	315	1	9.274 764
500	With batch certificate	5.0	5.0	360	1	9.274 765
1000	With batch certificate	10.0	10.0	440	1	9.274 766
2000	With batch certificate	20.0	20.0	535	1	9.274 767



1

1 Measuring cylinders, PP, tall form, class B, blue moulded graduations

VITLAB



Highly transparent. With easily readable, raised, embossed blue scale and ring marks at the primary scale points. Calibrated 'In'. Class B tolerances according to DIN 12681/ISO 6706. Hexagonal base with bottom studs provides high stability. Thermal stress up to 80°C does not cause tolerance limits to be permanently exceeded. To preserve markings, do not clean at temperatures exceeding 60°C. Food-safe product according to regulation (EU) No. 10/2011.

Capacity	Grad.	Tolerance	Diam.	Height	PK	Cat. No.
ml	ml	± ml	mm	mm		
10	0.20	0.2	15	145	1	9.274 408
25	0.50	0.5	22	170	1	9.274 409
50	1.00	1.0	27	200	1	9.274 410
100	1.00	1.0	33	250	1	9.274 411
250	2.00	2.0	44	315	1	9.274 412
500	5.00	5.0	58	360	1	9.274 413
1000	10.00	10.0	69	440	1	9.274 414
2000	20.00	20.0	97	482	1	9.274 415

2

2 Measuring cylinders, PP, tall form, class B, moulded graduations

VITLAB



Tall form. Highly transparent. With a raised scale and ring marks at the primary scale points, calibrated 'In'. Class B tolerances according to DIN 12681/ISO 6706. Hexagonal base with bottom studs provides high stability. Thermal stress up to 80°C does not cause tolerance limits to be permanently exceeded. Food-safe product according to regulation (EU) No. 10/2011.

Capacity	Grad.	Tolerance	Diam.	Height	PK	Cat. No.
ml	ml	± ml	mm	mm		
10	0.20	0.2	15	145	1	7.075 031
25	0.50	0.5	22	170	1	9.274 420
50	1.00	1.0	27	200	1	9.274 428
100	1.00	1.0	33	250	1	9.274 438
250	2.00	2.0	44	315	1	9.274 448
500	5.00	5.0	58	360	1	9.274 454
1000	10.00	10.0	69	440	1	9.274 462
2000	20.00	20.0	97	482	1	9.274 464

3

3 Measuring cylinders, PP, with handle, moulded graduations

Bel-Art Products



The large handle provides a secure grip for safer, more controlled and convenient pouring. A double scale is accurate and easy to read. The wide hexagonal base prevents tip over and rolling on the benchtop. One litre and two litre sizes. Autoclavable at 121°C

Capacity	Height	PK	Cat. No.
ml	mm		
1000	440	1	7.638 738
2000	490	1	9.274 870

1 Measuring cylinders, PMP, tall form, class A, blue graduations



BRAND

Clear. Exposure to temperatures up to 121 °C (autoclaving) will not cause permanently exceeded error limits. Cleaning at temperatures below 60°C is recommended to preserve graduations and inscriptions. Class A tolerance is not affected even after 20 washes and 10 autoclave treatments. (DIN 12681 requires: 10 washes and 3 autoclave treatments). Supplied with batch number and one batch certificate per packing unit. On request, they are also available with an individual certificate, USP individual certificate or DAkkS calibration certificate. Batch and individual certificates can also be downloaded at the supplier's website.

- DIN 12681 and ISO 6706
- DE-M marking
- With blue printed graduations and inscriptions



Capacity	Type	Grad.	Tolerance	Height	PK	Cat. No.
ml		ml	A ± ml	mm		
10	With batch certificate	0.2	0.10	145	1	9.274 790
25	With batch certificate	0.5	0.25	170	1	9.274 791
25	With DAkkS calibration certificate	0.5	0.25	170	1	6.222 951
50	With batch certificate	1	0.5	200	1	9.274 792
50	With individual certificate	1	0.5	200	2	6.290 030
100	With batch certificate	1	0.5	250	1	9.274 793
250	With batch certificate	2	1.0	315	1	9.274 794
500	With batch certificate	5	2.5	360	1	9.274 795
1000	With batch certificate	10	5	440	1	9.274 796
2000	With batch certificate	20	10	535	1	9.274 797

2 Measuring cylinders, SAN, low form, class B, moulded graduations



VITLAB

Short form. Crystal clear. With a raised scale and ring marks at the primary scale points, calibrated IN. Thermal stress up to 60 °C does not cause tolerance limits to be permanently exceeded. Food-safe product according to regulation (EU) No. 10/2011.

Capacity	Grad.	Tolerance	Diam.	Height	PK	Cat. No.
ml	ml	± ml	mm	mm		
50	1,00	1,00	27	142	1	7.060 691
100	2,00	2,00	37	163	1	7.008 999
250	5,00	5,00	51	192	1	7.060 692
500	10,00	10,00	67	218	1	7.060 693
1000	20,00	20,00	78	285	1	7.060 694



3 Measuring cylinders, SAN, tall form, class B, moulded graduations



VITLAB

Tall form. Crystal clear. With a raised scale and ring marks at the primary scale points, calibrated IN. Class B tolerances according to DIN 12681/ISO 6706. Hexagonal base with bottom studs provides high stability. Thermal stress up to 60 °C does not cause tolerance limits to be permanently exceeded. Food-safe product according to regulation (EU) No. 10/2011.

Capacity	Grad.	Tolerance	Diam.	Height	PK	Cat. No.
ml	ml	± ml	mm	mm		
50	1,00	1,00	28	199	1	7.009 011
100	1,00	1,00	34	260	1	7.009 014
250	2,00	2,00	47	315	1	7.009 017
500	5,00	5,00	61	350	1	7.009 020
1000	10,00	10,00	76	415	1	7.009 023



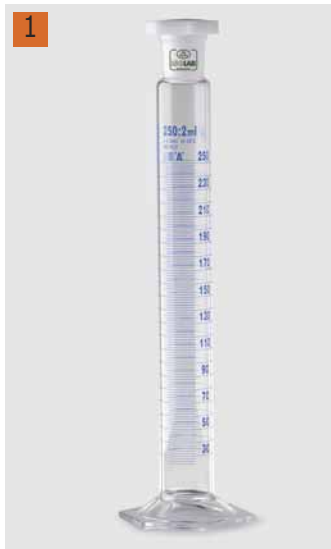

1 Mixing cylinders, borosilicate glass 3.3, tall form, class A, blue graduated

- Conformity certified
- DIN EN ISO 4788
- With PE-stopper
- Hexagonal foot
- Inscriptions are printed with blue enamel
- Batch certificate can be downloaded from website

ISOLAB

Capacity	Tolerance	Max. height	PK	Cat. No.
ml	± ml	mm		
10	0.100	160	1	9.275 070
25	0.250	195	1	9.275 071
50	0.500	230	1	9.275 072
100	0.500	290	1	9.275 073
250	1.000	370	1	9.275 074
500	2.500	410	1	9.275 075
1000	5.000	520	1	9.275 076

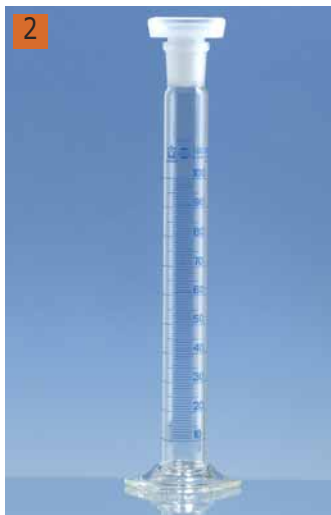

2 Mixing cylinders, borosilicate glass 3.3, tall form, class A, blue graduated

All BLAUBRAND® cylinders are supplied with batch number and one batch certificate per packing unit. On request, they are also available with an individual certificate, USP individual certificate or DAkkS calibration certificate. Batch and individual certificates can also be downloaded at the supplier's website.

BRAND

- BLAUBRAND®
- DIN EN ISO 4788
- DE-M marking
- PP stoppers and hexagonal foot
- Graduations and inscriptions in highly contrasting blue enamel
- Calibrated to contain (IN)

Capacity	Type	Grad.	Height	Neck	PK	Cat. No.
ml		ml	mm	NS		
10	With batch certificate	0,2	160	10/19	1	9.275 208
25	With batch certificate	0,5	190	14/23	1	9.275 220
50	With batch certificate	1	220	19/26	1	9.275 228
50	With individual certificate	1	220	19/26	2	6.290 029
100	With batch certificate	1	285	24/29	1	9.275 238
250	With batch certificate	2	350	29/32	1	9.275 248
250	With DAkkS calibration certificate	2	350	29/32	1	6.269 685
500*	With batch certificate	5	395	34/35	1	9.275 254
1000*	With batch certificate	10	500	45/40	1	9.275 262

* Fitted with PE octagonal stoppers.



3 Mixing cylinders, borosilicate glass 3.3, stoppered, class B, amber graduated

SILBERBRAND Eterna. Class B. To DIN EN ISO 4788.

BRAND

With PP stoppers and hexagonal foot. Graduations and inscriptions in Eterna amber stain. Calibrated to contain (IN). Height given is overall height without stopper

Capacity	Grad.	Height	Joint size (NS)	PK	Cat. No.
ml	ml	mm			
10	0.2	160	10/19	1	9.275 008
25	0.5	190	14/23	1	9.275 020
50	1.0	220	19/26	1	9.275 028
100	1.0	285	24/29	1	9.275 038
250	2.0	350	29/32	1	9.275 048
500*	5	395	34/35	1	9.275 054
1000*	10	500	45/40	1	9.275 062

* Fitted with PE octagonal stoppers.

1 Volumetric trapezoidal flasks, Borosilicate glass 3.3, class A, blue graduated NEW

- Conformity certified, with batch certificate
- DIN EN ISO 1042
- With NS and PE stoppers

ISOLAB

Nominal capacity ml	Joint size (NS)	PK	Cat. No.
1	7/16	2	4.678 051
2	7/16	2	4.678 052
3	7/16	2	4.678 053
4	7/16	2	4.678 054
5	7/16	2	4.678 036
10	10/19	2	4.678 055
20	10/19	2	4.678 056
25	10/19	2	4.678 057
50	12/21	2	4.678 037



2 Volumetric trapezoidal flasks, DURAN®, class A, blue graduation, with PE stopper

IN (TD) calibrated. With dated batch identification. Declaration of conformity acc. to DIN 12600. Hirschmann
 NS ground with poly stopper. Ring mark and graduation in high contrasting blue enamel.

According to DIN EN ISO 1042.
 For those products batch calibration reports, which are free of charge, can be generated and printed on www.hirschmannlab.com. Additional single calibration reports or DAkkS certificates (former DKD calibration reports) are available.

Capacity ml	Tolerance ± ml	Height mm	Joint size (NS)	PK	Cat. No.
1	0.025	60	7/16	1	9.276 645
2	0.025	70	7/16	1	9.276 646
5	0.025	70	7/16	1	9.276 647
5*	0.04	70	10/19	1	9.276 648
10	0.025	90	7/16	1	9.276 649
10*	0.04	90	10/19	1	9.276 650
20	0.04	110	10/19	1	9.276 651
25	0.04	110	10/19	1	9.276 652
50	0.06	140	12/21	1	9.276 653

* wide neck.



3 Volumetric trapezoidal flasks, borosilicate glass 3.3, class A, blue graduations

All BLAUBRAND® volumetric flasks are delivered with batch number and one batch certificate included per pack. Also available with individual works or DAkkS calibration certificate, please enquire. BRAND

BLAUBRAND® volumetric flasks (except wide-neck flasks). Individual and batch works, USP calibration certificates are also available on request. Models with glass stoppers available on request. The batch certificate is also available to download from the supplier's website.

- DIN EN ISO 1042
- DE-M marking
- Graduations and inscriptions in highly contrasting blue enamel
- Calibrated to contain (IN)



Nominal capacity ml	Tolerance ± ml	Joint size (NS)	Description	PK	Cat. No.
1	0.025	7/16	With PP stoppers, incl. one batch certificate	1	9.276 001
2	0.025	7/16	With PP stoppers, incl. one batch certificate	1	9.276 002
5	0.025	7/16	With PP stoppers, incl. one batch certificate	1	9.276 003
10 *	0.04	10/19	With PP stoppers, incl. one batch certificate	1	9.276 004
20	0.04	10/19	With PP stoppers, incl. one batch certificate	1	9.276 006
25	0.04	10/19	With PP stoppers, incl. one batch certificate	1	9.276 007
50	0.06	12/21	With PP stoppers, incl. one batch certificate	1	9.276 008

* Wide neck version



1 Volumetric flasks, borosilicate glass 3.3, class A, blue graduated, with PE stoppers

Borosilicate glass 3.3. Conformity certified, with batch certificate. With NS and PE stoppers, to DIN EN ISO 1042. Calibrated to contain (IN) and all the tolerances are according to DIN/ISO Class A standards.

ISOLAB

Capacity	Tolerance	Joint size (NS)	PK	Cat. No.
ml	± ml			
5	0,025	10/19	1	9.276 600
10	0,025	10/19	1	9.276 601
20	0,040	10/19	1	9.276 602
25	0,040	10/19	1	9.276 603
25	0,060	12/21	1	4.008 300
50	0,060	12/21	1	9.276 604
50	0,060	14/23	1	9.276 605
100	0,100	12/21	1	9.276 606
100	0,100	14/23	1	9.276 607
150	0,150	14/23	1	6.241 814
200	0,150	14/23	1	9.276 608
250	0,150	14/23	1	9.276 609
300	0,200	14/23	1	4.008 301
400	0,200	19/26	1	4.008 302
500	0,250	19/26	1	9.276 610
1000	0,400	24/29	1	9.276 611
2000	0,600	29/32	1	9.276 612
5000	1,200	34/35	1	9.276 613
10000	2,000	45/40	1	9.276 614



2 Volumetric flasks, borosilicate glass 3.3, class A, blue graduated, with PE stoppers, coated

The flasks are coated with a special formulated coating that holds the broken parts together in case of breakage. The transparent coating can resist up to 135°C with maximum period of 30 minutes. Coated flasks should not be exposed directly to open flame.

ISOLAB

- Conformity certified, with batch certificate
- DIN EN ISO 1042
- Calibrated to contain (IN)

Nominal capacity	Joint size (NS)	PK	Cat. No.
ml			
5	10/19	2	4.678 019
10	10/19	2	4.678 020
20	10/19	2	4.678 021
25	10/19	2	4.678 022
25	12/21	2	4.678 023
50	12/21	2	4.678 024
50	14/23	2	4.678 025
100	12/21	2	4.678 026
100	14/23	2	4.678 027
150	14/23	2	4.678 028
200	14/23	2	4.678 029
250	14/23	2	4.678 030
300	14/23	2	4.678 031
400	19/26	2	4.678 032
500	19/26	2	4.678 033
1000	24/29	2	4.678 034
2000	29/32	2	4.678 035



1 Volumetric Flasks, Borosilicate Glass 3.3, Class A, Blue Graduations, with PP-/PE-stoppers

All BLAUBRAND® volumetric flasks are delivered with batch number and one batch certificate included per pack. Also available with individual works or DAkkS (former DKD) calibration certificate, please enquire.

BRAND

- DIN EN ISO 1042
- DE-M marking
- Ring marks and inscriptions in highly contrasting blue enamel
- Calibrated to contain (IN)

Capacity ml	Tolerance ± ml	Joint size (NS)	Cover type	PK	Cat. No.
5 *	0.04	10/19	PP	1	9.276 438
10 *	0.025	7/16	PP	1	6.272 008
10 *	0.04	10/19	PP	1	9.276 443
20	0.04	10/19	PP	1	9.276 446
20 *	0.06	12/21	PP	1	6.239 438
25	0.04	10/19	PP	1	9.276 447
25 *	0.06	12/21	PP	1	4.000 074
50	0.06	12/21	PP	1	9.276 448
50 *	0.10	14/23	PP	1	9.276 456
100	0.10	12/21	PP	1	9.276 449
100	0.10	14/23	PP	1	9.276 457
200	0.15	14/23	PP	1	9.276 450
250	0.15	14/23	PP	1	9.276 451
500	0.25	19/26	PP	1	9.276 452
1000	0.40	24/29	PP	1	9.276 453
2000	0.60	29/32	PP	1	9.276 454
5000	1.20	34/35	PE	1	9.276 455
1000 *	0.60	28/32	PP	1	7.408 401
10000**	2.00	45/40	PE	1	9.276 436

*Wide mouth

**Supplementary to DIN.

1



2 Volumetric flasks, DURAN®, class A, blue graduation, with PE stoppers

IN (TD) calibrated. With dated batch identification. Declaration of conformity acc. to DIN 12600. With NS ground and polystopper. Ring mark and graduation in durable blue enamel, acc. to DIN EN ISO 1042.

Hirschmann

For those products batch calibration reports, which are free of charge, can be generated and printed on www.hirschmannlab.com. Additional single calibration reports or DAkkS certificates (former DKD calibration reports) are available.

Capacity ml	Tolerance ± ml	Height mm	Joint size (NS)	PK	Cat. No.
5	0.025	70	7/16	1	9.276 680
5 **	0.04	70	10/19	1	9.276 681
10	0.025	90	7/16	1	9.276 682
10 **	0.04	90	10/19	1	9.276 683
20	0.04	110	10/19	1	9.276 684
20 **	0.06	105	12/21	1	9.276 679
25	0.04	110	10/19	1	9.276 685
25 **	0.06	110	12/21	1	9.276 686
50	0.06	140	12/21	1	9.276 687
50 **	0.08	140	14/23	1	9.276 688
100	0.1	170	12/21	1	9.276 689
100	0.1	170	14/23	1	9.276 690
200	0.15	210	14/23	1	9.276 691
250	0.15	220	14/23	1	9.276 692
500	0.25	260	19/26	1	9.276 693
1000 **	0.6	300	29/32	1	9.276 694
1000	0.4	300	24/29	1	9.276 695
2000	0.6	370	29/32	1	9.276 696
5000	1.2	470	34/35	1	9.276 697
10000*	2.0	570	45/40	1	9.276 698

* Supplementary to DIN.

**Wide neck.

Also available with dated batch identification acc. to USP (US Pharmacopeia)

2



1

1

Volumetric flasks, DURAN®, class A, blue graduation, with hollow glass stopper

IN (TD) calibrated. With dated batch identification. Declaration of conformity acc. to DIN 12600. NS ground with glass stopper. Ring mark and graduation in high contrasting blue enamel. According to DIN EN ISO 1042.

Hirschmann

For those products batch calibration reports, which are free of charge, can be generated and printed on www.hirschmannlab.com. Additional single calibration reports or DAkkS certificates (former DKD calibration reports) are available.

Capacity ml	Tolerance ± ml	Height mm	Joint size (NS)	PK	Cat. No.
5	0.025	70	7/16	1	9.276 470
5**	0.04	70	10/19	1	9.276 471
10	0.025	90	7/16	1	9.276 472
10**	0.04	90	10/19	1	9.276 473
20	0.04	110	10/19	1	9.276 474
20**	0.06	105	12/21	1	9.276 489
25	0.04	110	10/19	1	9.276 475
25**	0.06	110	12/21	1	9.276 476
50	0.06	140	12/21	1	9.276 477
50**	0.08	140	14/23	1	9.276 478
100	0.1	170	12/21	1	9.276 479
100	0.1	170	14/23	1	9.276 480
200	0.15	210	14/23	1	9.276 481
250	0.15	220	14/23	1	9.276 482
500	0.25	260	19/26	1	9.276 483
1000**	0.6	300	29/32	1	9.276 484
1000	0.4	300	24/29	1	9.276 485
2000	0.6	370	29/32	1	9.276 486
5000	1.2	470	34/35	1	9.276 487
10000*	2.0	570	45/40	1	9.276 488

* Supplementary to DIN.

**wide neck.

2

2

Volumetric Flasks, Borosilicate Glass 3.3, Class A, Blue Graduations, with Glass Stoppers

All BLAUBRAND® volumetric flasks are delivered with batch number and one batch certificate included per pack. Also available with individual works or DAkkS (former DKD) calibration certificate, please enquire.

BRAND

- DIN EN ISO 1042
- DE-M marking
- Ring marks and inscriptions in highly contrasting blue enamel
- Calibrated to contain (IN)

Nominal capacity ml	Tolerance ± ml	Joint size (NS)	PK	Cat. No.
5 *	0.04	10/19	1	7.018 535
10 *	0.04	10/19	1	7.018 546
20	0.04	10/19	1	7.018 536
20 *	0.06	12/21	1	6.238 693
25	0.04	10/19	1	7.018 537
25 *	0.06	12/21	1	7.018 553
50	0.06	12/21	1	7.018 538
50 *	0.08	14/23	1	7.018 549
100	0.10	12/21	1	7.018 539
100	0.10	14/23	1	7.018 550
200	0.15	14/23	1	7.018 540
250	0.15	14/23	1	7.018 541
500	0.25	19/26	1	7.018 542
1000	0.4	24/29	1	7.018 543
2000	0.6	29/32	1	7.018 544
5000	1.2	34/35	1	7.018 545
5000	1.2	34/35	1	6.231 160

*Wide mouth



1 Volumetric flasks USP, borosilicate glass 3.3, class A, blue graduations

BLAUBRAND®, DIN EN ISO 1042, DE-M marking. Calibrated to contain (TC, IN).
Marks and inscriptions in high contrast blue enamel. Incl. USP batch certificate.
On request, also available with USP individual certificate.

BRAND

Capacity ml	Tolerance ± ml	Joint size (NS)	With	PK	Cat. No.
5	0.02	10/19*	PP stopper	1	6.231 839
10	0.02	10/19*	PP stopper	1	6.231 840
20	0.02	10/19*	PP stopper	1	6.231 841
25	0.03	10/19	PP stopper	1	6.231 842
50	0.05	12/21	PP stopper	1	6.231 843
100	0.08	14/23	PP stopper	1	6.229 183
200	0.10	14/23	PP stopper	1	6.231 844
250	0.12	14/23	PP stopper	1	6.231 845
500	0.20	19/26	PP stopper	1	6.231 846
1000	0.30	24/29	PP stopper	1	6.229 184
2000	0.50	29/32	PP stopper	1	6.231 849
5	0.02	10/19*	glass stopper	1	6.265 803
10	0.02	10/19*	glass stopper	1	6.265 769
20	0.02	10/19*	glass stopper	2	6.285 869
25	0.03	10/19	glass stopper	1	6.265 770
50	0.05	12/21	glass stopper	1	6.265 771
100	0.08	14/23	glass stopper	1	6.265 772
200	0.10	14/23	glass stopper	1	6.265 773
250	0.12	14/23	glass stopper	1	6.265 774
500	0.20	19/26	glass stopper	1	7.660 539
1000	0.50	24/29	glass stopper	1	7.659 410
2000	0.30	29/32	glass stopper	1	6.265 775

*additionally to ISO

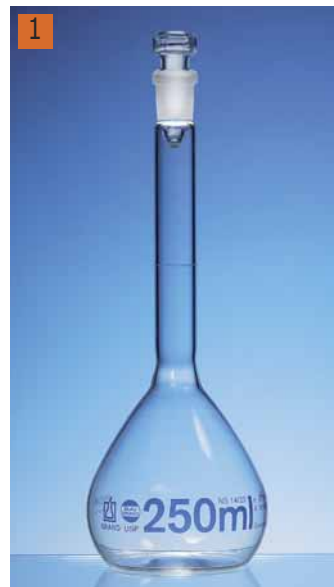

2 Volumetric flasks, DURAN®, with beaded rim, class A, blue graduation

IN (TD) calibrated. With beaded rim and dated batch identification. Declaration of conformity
acc. to DIN 12600. Ring mark and graduation in high contrasting blue enamel.
According to DIN EN ISO 1042.

Hirschmann

For those products, batch calibration reports, which are free of charge, can be generated and printed on
www.hirschmannlab.com. Additional single calibration reports or DAkkS certificates (former DKD calibration reports)
are available.

Capacity ml	Tolerance ± ml	Height mm	PK	Cat. No.
5	0.025	70	1	9.276 715
10	0.025	90	1	9.276 716
20	0.04	110	1	9.276 717
25	0.04	110	1	9.276 718
50	0.06	140	1	9.276 719
100	0.1	170	1	9.276 720
200	0.15	210	1	9.276 733
250	0.15	220	1	9.276 734
500	0.25	260	1	9.276 735
1000	0.4	300	1	9.276 736
2000	0.6	370	1	9.276 737
5000	1.2	470	1	9.276 738
10000*	2.0	570	1	9.276 739

* additional to DIN

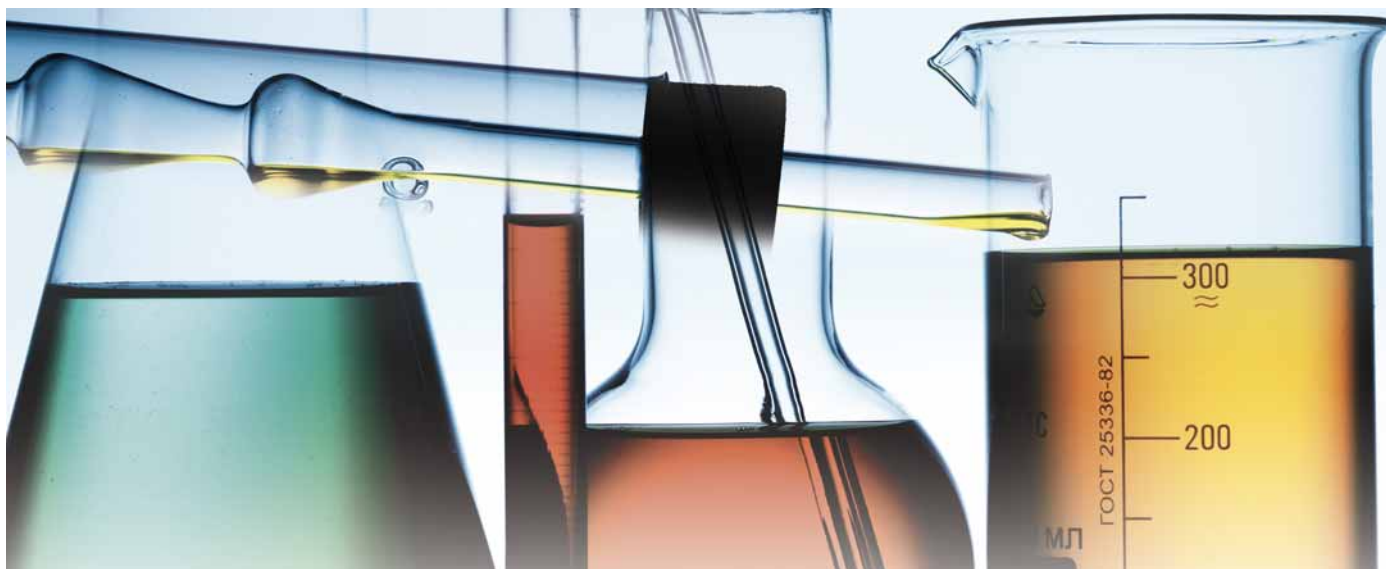

1

1

Volumetric flasks, DURAN®, class A, amber stain graduation, with PE stoppers

IN (TD) calibrated. With dated batch identification. Declaration of conformity acc. to DIN 12600. NS ground with polystopper. With durable amber stain graduation. According to DIN EN ISO 1042.

Hirschmann

For those products batch calibration reports, which are free of charge, can be generated and printed on www.hirschmannlab.com. Additional single calibration reports or DAkkS certificates (former DKD calibration reports) are available.

Capacity ml	Tolerance ± ml	Height ± 5mm	NS	PK	Cat. No.
5	0,025	70	7/16	1	6.252 081
5*	0,04	70	10/19	1	9.276 758
10	0,025	90	7/16	1	6.240 839
10*	0,04	90	10/19	1	9.276 759
20	0,04	110	10/19	1	9.276 760
20*	0,06	105	12/21	1	6.250 442
25	0,04	110	10/19	1	9.276 761
25*	0,06	110	12/21	1	6.201 520
50	0,06	140	12/21	1	9.276 762
50*	0,08	140	14/23	1	9.276 763
100	0,1	170	12/21	1	9.276 764
100	0,1	170	14/23	1	9.276 765
200	0,15	210	14/23	1	9.276 766
250	0,15	220	14/23	1	9.276 767
500	0,25	260	19/26	1	9.276 768
1000*	0,6	300	19/32	1	6.260 422
1000	0,4	300	24/29	1	9.276 769
2000	0,6	370	29/32	1	9.276 770
5000	1,2	470	34/35	1	6.230 835
10000	2	570	45/40	1	6.260 423

* wide neck

2

2

Volumetric Flasks, Borosilicate Glass 3.3, Class A, Amber Graduations, with PP Stoppers

BLAUBRAND® Eterna. To DIN EN ISO 1042. DE-M marking. With batch number. Graduation and inscriptions in Eterna amber stain. Calibrated to contain (IN). PP stoppers.

BRAND

All BLAUBRAND® volumetric flasks are delivered with batch number and one batch certificate included per pack.

Also available with individual works or DAkkS (former DKD) calibration certificate, please enquire.

BLAUBRAND® volumetric flasks (except wide-neck flasks) are also available with individual and batch USP certification.

The batch certificate is also available to download from the manufacturer's website.

Capacity ml	Tolerance ± ml	Joint size (NS)	PK	Cat. No.
5 *	0,04	10/19	1	9.276 260
10 *	0,04	10/19	1	9.276 261
20	0,04	10/19	1	9.276 262
20*	0,06	12/21	1	4.007 850
25	0,04	10/19	1	4.007 849
25*	0,06	12/21	1	9.276 263
50	0,06	12/21	1	9.276 264
50*	0,10	14/23	1	9.276 265
100	0,10	14/23	1	9.276 270
200	0,15	14/23	1	9.276 271
250	0,15	14/23	1	9.276 272
500	0,25	19/26	1	9.276 273
1000	0,40	24/29	1	9.276 274
2000	0,60	29/32	1	9.276 275

*Wide mouth



1 Volumetric flasks, borosilicate glass, amber, class A, white graduated, with PE stoppers

Amber Borosilicate glass with PE stoppers, DE-M marking, with batch certificate and white enamel graduations. According to DIN EN ISO 1042. Calibrated to contain (IN) and all the tolerances are according to DIN/ISO Class A standards.

ISOLAB

Capacity	Tolerance	Joint size (NS)	PK	Cat. No.
ml	± ml			
5	0,025	10/19	1	9.276 620
10	0,025	10/19	1	9.276 621
20	0,040	10/19	1	9.276 622
25	0,040	10/19	1	9.276 623
25	0,060	12/21	1	4.008 303
50	0,060	12/21	1	9.276 624
50	0,060	14/23	1	9.276 625
100	0,100	12/21	1	9.276 626
100	0,100	14/23	1	9.276 627
200	0,150	14/23	1	9.276 628
250	0,150	14/23	1	9.276 629
500	0,250	19/26	1	9.276 630
1000	0,400	24/29	1	9.276 631
2000	0,600	29/32	1	4.008 306



2 Volumetric Flasks, Borosilicate Glass 3.3, Class A, Amber Glass, White Graduation

BLAUBRAND®, DIN EN ISO 1042, DE-M marking. Calibrated to contain (TC, IN). Marks and inscriptions in high contrast white enamel. All BLAUBRAND® volumetric flasks are supplied with a batch number and an accompanying batch certificate in the original packaging. On request, they are also available with an individual certificate or DAkkS calibration certificate.

BRAND



7.018 562

Capacity	Tolerance	With	PK	Cat. No.
ml	± ml			
5 *	0.04	PP stoppers	1	7.018 554
10*	0.04	PP stoppers	1	7.018 555
20	0.04	PP stoppers	1	7.018 556
25	0.04	PP stoppers	1	7.018 557
50	0.06	PP stoppers	1	7.018 558
50*	0.08	PP stoppers	1	7.018 559
100	0.10	PP stoppers	1	7.018 560
200	0.15	PP stoppers	1	7.018 561
250	0.15	PP stoppers	1	7.018 562 2
500	0.25	PP stoppers	1	7.018 563
1000	0.4	PP stoppers	1	7.018 564
5 *	0.04	Glass stoppers	1	7.018 565
10*	0.04	Glass stoppers	1	7.018 566
20	0.04	Glass stoppers	1	7.018 568
25	0.04	Glass stoppers	1	7.018 569
50	0.06	Glass stoppers	1	7.018 570
50*	0.08	Glass stoppers	1	7.018 567
100	0.10	Glass stoppers	1	7.018 571
200	0.15	Glass stoppers	1	7.018 572
250	0.15	Glass stoppers	1	7.018 573 3
500	0.25	Glass stoppers	1	7.018 574
1000	0.4	Glass stoppers	1	7.018 575

*Wide mouth



7.018 573

1



1

Volumetric flasks, DURAN® amber glass, class A, with PE stopper

IN (TD) calibrated. Amber glass. With dated batch identification. Declaration of conformity acc. to DIN 12600. With NS and polystopper. Ring mark and graduation in durable white enamel, acc. to DIN EN ISO 1042.

Hirschmann

For these products batch calibration reports, which are free of charge, can be generated and printed on www.hirschmannlab.com. Additional single calibration reports or DAkkS certificates (former DKD calibration reports) are available.

Capacity ml	Tolerance ± ml	Height mm	Joint size (NS)	PK	Cat. No.
5	0.025	70	7/16	1	9.276 699
5*	0.04	70	10/19	1	9.276 700
10	0.025	90	7/16	1	9.276 701
10*	0.04	90	10/19	1	9.276 702
20	0.04	110	10/19	1	9.276 703
25	0.04	110	10/19	1	9.276 704
25*	0.06	110	12/21	1	9.276 710
50	0.06	140	12/21	1	9.276 705
50*	0.08	140	14/23	1	9.276 713
100	0.1	170	12/21	1	9.276 706
100	0.1	170	14/23	1	9.276 714
200	0.15	210	14/23	1	9.276 707
250	0.15	220	14/23	1	9.276 708
500	0.25	260	19/26	1	9.276 709
1000	0.4	300	24/29	1	9.276 711
2000	0.6	370	29/32	1	9.276 712

* Wide neck.

Also available with dated batch identification acc. to USP (US Pharmacopeia).

2



2

Volumetric flasks, DURAN® amber glass, class A, white graduation, with amber glass stopper

IN (TD) calibrated. With dated batch identification. Declaration of conformity acc. to DIN 12600. With hollow amber glass stopper. Ring mark and graduation in white enamel. According to DIN EN ISO 1042.

Hirschmann

For these products batch calibration reports, which are free of charge, can be generated and printed on www.hirschmannlab.com. Additional single calibration reports or DAkkS certificates (former DKD calibration reports) are available.

Capacity ml	Tolerance ± ml	Height mm	Joint size (NS)	PK	Cat. No.
5	0.025	70	7/16	1	9.276 500
5*	0.04	70	10/19	1	9.276 501
10	0.025	90	7/16	1	9.276 502
10*	0.04	90	10/19	1	9.276 503
20	0.04	110	10/19	1	9.276 504
25	0.04	110	10/19	1	9.276 505
50	0.06	140	12/21	1	9.276 506
50*	0.08	140	14/23	1	9.276 507
100	0.1	170	12/21	1	9.276 508
100	0.1	170	14/23	1	9.276 509
200	0.15	210	14/23	1	9.276 510
250	0.15	220	14/23	1	9.276 511
500	0.25	260	19/26	1	9.276 512
1000	0.4	300	24/29	1	9.276 513
2000	0.6	370	29/32	1	9.276 514

* Wide neck.

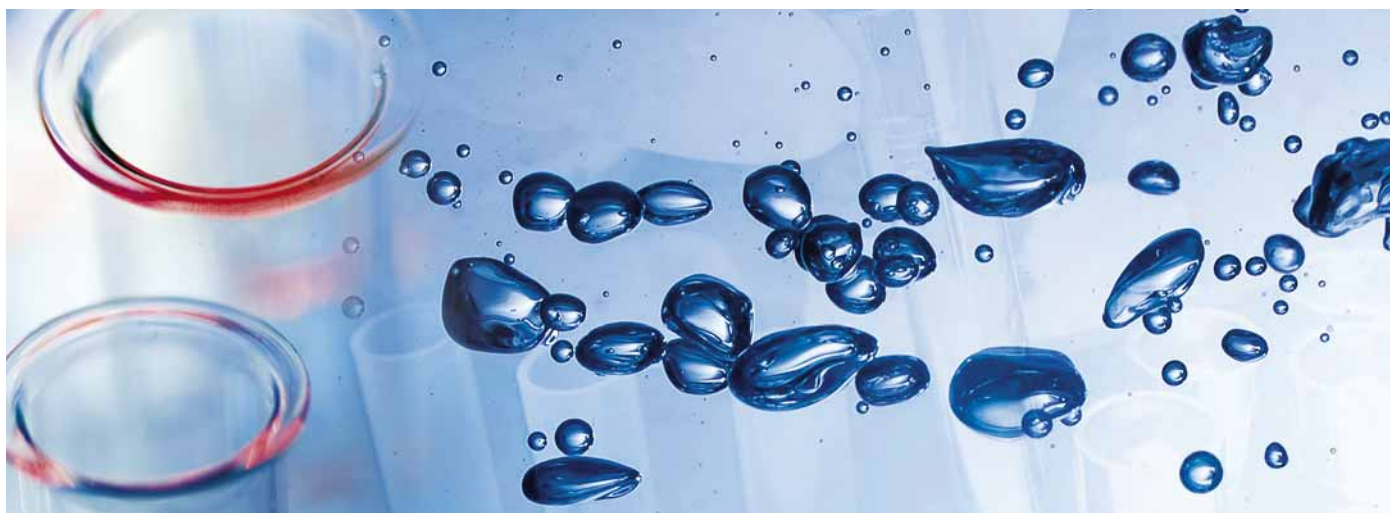

1 Volumetric flasks for determination of oil content, SILBERBRAND, Borosilicate glass 3.3

DIN 51 368. For determination of oil content in aqueous oil emulsions (e.g. drilling oil). With NS19/26, hollow glass stoppers. Graduations and inscriptions in highly contrasting white enamel. Capacity 100 ml, tolerance ± 0.2 ml. Calibrated to contain (IN).

BRAND

Subdivisions: 0 to 5 ml : 0.1 ml, tolerance: ± 0.1 ml.
Subdivisions: 5 to 30 ml : 0.5 ml, tolerance: ± 0.5 ml.

Sample volume ml	PK	Cat. No.
100	1	9.276 880



2 Volumetric flasks for sugar tests, Borosilicate glass 3.3, class B, white graduated

For sugar tests in the style of Kohlrausch. SILBERBRAND. Tolerance equivalent to class B. Ring marks and inscriptions in highly contrasting white enamel. Calibrated to contain (IN).

BRAND

Capacity ml	Tolerance \pm ml	PK	Cat. No.
100	0.2	1	9.276 885
200	0.3	1	9.276 887

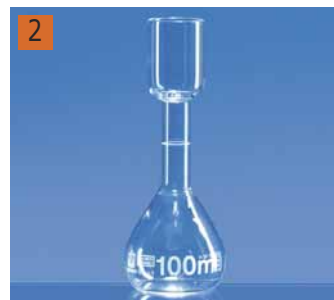

3 Volumetric flasks, PMP, class A



VITLAB

With NS stoppers, PP. Highly transparent. With ring mark individually calibrated to (IN). Class A tolerances according to DIN EN ISO 1042. With printed lot number and batch certificate. Thermal stress up to 121°C (autoclaving) does not permanently exceed the tolerance limit. To preserve markings, do not clean at temperatures exceeding 60°C. On request also with DAKKS calibration certificate or single certificate.

Capacity ml	Tolerance \pm ml	Height mm	Stopper NS	PK	Cat. No.
10	0.04	90	10/19	1	9.276 949
25	0.04	115	10/19	1	9.276 950
50	0.06	150	12/21	1	9.276 951
100	0.10	180	14/23	1	9.276 952
250	0.15	235	19/26	1	9.276 953
500	0.25	270	19/26	1	9.276 954
1000	0.40	310	24/29	1	9.276 955



4 Volumetric Flasks, PMP, Class B, with PP Screw Cap



VITLAB

Volumetric flasks made of polymethylpentene. Highly transparent. Calibrated to contain (IN). DIN EN ISO 1042. Thermal stress up to 121°C (autoclaving) does not permanently exceed the tolerance limit. To preserve markings, do not clean at temperatures exceeding 60°C.

Capacity ml	Tolerance \pm ml	Thread GL	Height mm	PK	Cat. No.
100	0.20	18	180	1	7.009 038



8. Liquid Handling

Volumetric apparatus/Graduated flasks



9.276 973

Volumetric flasks VITLAB® UV-protect, PMP, Class A with NS stoppers, PP

VITLAB



UV-absorbing, highly transparent. For storage of light-sensitive substances.
 With ring mark individually calibrated to In'. Class A tolerances according to DIN EN ISO 1042.
 With printed lot number and batch certificate.
 Thermal stress up to 121°C (autoclaving) does not permanently exceed the tolerance limit.
 To preserve markings, do not clean at temperatures exceeding 60°C

Capacity ml	Tolerance ± ml	Height mm	NS	PK	Cat. No.
10	0.04	90	10/19	1	9.276 970
25	0.04	115	10/19	1	9.276 971
50	0.06	150	12/21	1	9.276 972
100	0.10	180	14/23	1	9.276 973 I
250	0.15	235	19/26	1	9.276 974
500	0.25	270	19/26	1	9.276 975
1000	0.40	310	24/29	1	9.276 976



2 Volumetric flasks, plastic, class B, PE NS-stoppers

To DIN EN ISO 1042, adjusted to IN, with PE standard ground joint stoppers.

ISOLAB

Capacity ml	Tolerance ± ml	Joint size (NS)	PK	Cat. No.
25	0,08	10/19	1	9.276 590
50	0,12	12/21	1	9.276 591
100	0,20	14/23	1	9.276 592
250	0,30	14/23	1	9.276 593
500	0,50	19/26	1	9.276 594
1000	0,80	24/29	1	9.276 595

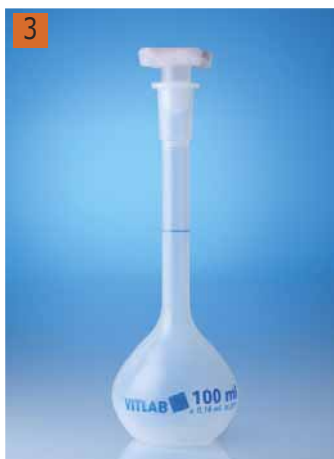

3 Volumetric flasks, PP, Class B, NS-stoppers, PP

VITLAB



Adjusted to IN. Highly transparent. Class B tolerances according to DIN EN ISO 1042.
 Thermal stress up to 60 °C does not permanently exceed the tolerance limits.
 To preserve markings, do not clean at temperatures exceeding 60 °C.

Capacity ml	Tolerance ± ml	Height mm	Joint size (NS)	PK	Cat. No.
10	0.08	90	10/19	1	9.276 818
25	0.08	115	10/19	1	9.276 820
50	0.12	150	12/21	1	9.276 828
100	0.20	180	14/23	1	9.276 838
250	0.30	235	19/26	1	9.276 848
500	0.50	270	19/26	1	9.276 854
1000	0.80	310	24/29	1	9.276 862



4 Volumetric Flasks, PP, Class B, with Screw Cap, PP

VITLAB



Highly transparent. Class B tolerances according to DIN EN ISO 1042. Calibrated to IN.
 Do not clean at temperatures exceeding 60 °C.
 Thermal stress up to 60 °C cause no permanently exceed of the tolerance limit.

Capacity ml	Tolerance ± ml	Height mm	Neck thread GL	PK	Cat. No.
25	0.08	115	18	1	7.009 032
50	0.12	150	6	1	7.009 035
100	0.20	180	18	1	7.009 037
250	0.30	235	25	1	7.009 039
500	0.50	270	25	1	7.009 041
1000	0.80	310	32	1	7.009 043

1 LLG-Volumetric pipettes, soda glass, class AS, 1 mark, blue graduated **NEW**

- DIN EN ISO 648, DIN 12687
- Conformity-certified
- With batch date identification
- Calibrated to deliver (EX)
- Ring mark and inscriptions in permanent blue enamel

Nominal capacity ml	Tolerance ± ml	Length mm	PK	Cat. No.
1	0.007	310	10	6.272 207
2	0.010	330	10	6.272 208
3	0.010	360	10	6.272 209
4	0.015	360	10	6.272 210
5	0.015	400	10	6.272 211
10	0.020	440	10	6.272 212
15	0.030	455	10	6.272 213
20	0.030	510	10	6.272 214
25	0.030	520	10	6.272 215
50	0.050	540	10	6.272 216



2 Volumetric pipettes, soda glass, class AS, 1 mark, blue graduated

Soda glass. Conformity-certified. With batch date identification. ISOLAB
 DIN EN ISO 648, DIN 12687. Calibrated to deliver (EX).
 Ring mark and inscriptions in permanent blue enamel.

Volume ml	Tolerance ± ml	Length mm	PK	Cat. No.
1	0,008	315 ± 5	1	9.272 260
2	0,010	340 ± 5	1	9.272 261
3	0,010	360 ± 5	1	9.272 262
4	0,015	360 ± 5	1	9.272 263
5	0,015	390 ± 5	1	9.272 264
10	0,020	445 ± 5	1	9.272 265
11	0,020	445 ± 5	1	9.272 266
15	0,030	445 ± 5	1	9.272 267
20	0,030	515 ± 5	1	9.272 268
25	0,030	520 ± 5	1	9.272 269
50	0,050	530 ± 5	1	9.272 270



3 Volumetric pipettes, Soda-lime glass, class AS, 1 mark, blue graduation

EX (TD) calibrated. With dated batch identification. Declaration of conformity Hirschmann
 acc. to DIN 12600. One mark pipettes, graduation in high-contrast blue colour.
 Acc. to DIN EN ISO 648.
 For those products, batch calibration reports, which are free of charge, can be generated and printed on
www.hirschmannlab.com. Additional single calibration reports or DAkkS certificates (former DKD calibration reports)
 are available.

Volume ml	Tolerance ± ml	Overall length ± 10 mm	PK	Cat. No.
1	0.008	325	1	9.273 270
2	0.01	350	1	9.273 271
2.5*	0.01	350	1	9.273 272
3*	0.01	350	1	9.273 273
5	0.015	410	1	9.273 276
10	0.02	450	1	9.273 280
15*	0.03	520	1	9.273 281
20	0.03	520	1	9.273 282
25	0.03	530	1	9.273 284
50	0.05	550	1	9.273 286
100	0.08	600	1	9.273 288

* Supplementary to DIN.





1 Volumetric pipettes, class AS, AR-glass®, 1 marking, blue graduation

All BLAUBRAND® volumetric pipettes are supplied with batch number and one batch certificate per manufacturer's outer pack (up to 2ml: 12 cylinders, above 2.5ml: 6 cylinders per pack). Also available with individual certificate or DAkkS (former DKD) calibration certificate, please enquire.

BRAND

- DIN EN ISO 648
- DE-M marking
- Graduations and inscriptions in highly contrasting blue enamel
- Calibrated to deliver (EX)

Nominal capacity ml	Tolerance ± ml	Overall length ± 10 mm	Description	PK	Cat. No.
0.5	0.005	300	Incl. one batch certificate	1	9.273 101
1.0	0.008	300	Incl. one batch certificate	1	9.273 102
2.0	0.010	330	Incl. one batch certificate	1	9.273 103
2.5	0.010	2,5	Incl. USP certificate	1	7.910 025
2.5	0.010	330	Incl. one batch certificate	1	9.273 104
3.0	0.010	330	Incl. one batch certificate	1	9.273 105
4.0	0.015	400	Incl. one batch certificate	1	9.273 106
5.0	0.015	400	Incl. one batch certificate	1	9.273 107
6.0	0.015	400	Incl. one batch certificate	1	9.273 108
7.0	0.015	400	Incl. one batch certificate	1	9.273 109
8.0	0.02	440	Incl. one batch certificate	1	9.273 110
9.0	0.02	440	Incl. one batch certificate	1	9.273 111
10.0	0.02	440	Incl. one batch certificate	1	9.273 112
15.0	0.03	510	Incl. one batch certificate	1	9.273 113
20.0	0.03	510	Incl. one batch certificate	1	9.273 114
25.0	0.03	520	Incl. one batch certificate	1	9.273 115
30.0	0.03	520	Incl. one batch certificate	1	9.273 116
40.0	0.05	540	Incl. one batch certificate	1	9.273 117
50.0	0.05	540	Incl. one batch certificate	1	9.273 118
100.0	0.08	585*	Incl. one batch certificate	1	9.273 119

* ±15 mm



2 Volumetric pipettes, USP, class AS, AR-glass®, blue graduation

BLAUBRAND®, DE-M marking. DIN EN ISO 648. Calibrated to deliver (TD, EX). Marks and inscriptions in high contrast blue enamel. Incl. one USP batch certificate. On request, also available with USP individual certificate or DAkkS certificate.

BRAND

The batch certificate or individual certificate is also available to download from the manufacturer's website.

Volume ml	Tolerance ± ml	Overall length ± 10 mm	PK	Cat. No.
0,5*	0.005	300	1	6.262 520
1	0.006	300	1	7.659 228
2	0.006	330	1	6.262 521
3	0.01	330	1	6.262 522
4	0.01	400	1	6.262 523
5	0.01	400	1	7.659 239
6	0.01	400	1	6.262 524
7	0.01	400	1	6.262 525
8	0.02	440	1	6.262 526
9	0.02	440	1	6.262 527
10	0.02	440	1	7.659 240
15	0.03	510	1	6.262 528
20	0.03	510	1	6.262 529
25	0.03	520	1	6.262 530
30	0.03	520	1	7.659 241
40	0.05	540	1	6.262 531
50	0.05	540	1	6.262 532
100	0.8	585 (±15mm)	1	7.659 242

* Error limit USP ±0.006ml

1 Volumetric pipettes, Soda-lime glass, class AS, 1 mark, amber stain graduation

EX (TD) calibrated. With dated batch identification. Declaration of conformity acc. to DIN 12600. With durable amber stain graduation, acc. to DIN EN ISO 648. *Hirschmann*

For those products, batch calibration reports, which are free of charge, can be generated and printed on www.hirschmannlab.com. Additional single calibration reports or DAkkS certificates (former DKD calibration reports) are available.

Volume ml	Tolerance ± ml	Overall length ± 10 mm	PK	Cat. No.
0,5	0.005	300	1	6.200 955
1	0.008	325	1	6.052 959
1,5*	0.01	350	1	7.200 075
2	0.01	350	1	6.092 721
2,5*	0.01	350	1	6.079 397
3*	0.01	350	1	6.303 738
4*	0.015	410	1	6.300 028
5	0.015	410	1	6.081 798
6*	0.015	410	1	6.300 025
7*	0.015	410	1	6.300 026
8*	0.02	450	1	6.077 361
9*	0.02	450	1	6.300 299
10	0.02	450	1	6.050 827
15*	0.03	520	1	6.057 100
20	0.03	520	1	6.084 029
25	0.03	530	1	6.084 072
30*	0.03	530	1	6.057 101
40*	0.05	550	1	6.077 366
50	0.05	550	1	6.054 343
100	0.08	600	1	6.055 472

* Supplementary to DIN.

Also available with dated batch identification acc. to USP (US Pharmacopeia).

2 Volumetric pipettes, AR-glas®, class AS, 1 mark, amber graduation

BLAUBRAND® Eterna. DIN EN ISO 648. Calibrated to deliver (TD, EX). DE-M marking. *BRAND*

Graduations and inscriptions in Eterna amber stain (particularly resistant to aggressive cleaning methods). All BLAUBRAND® bulb pipettes are supplied with a batch number and one batch certificate per manufacturer's outer pack. Also available with an individual works, USP, or DAkkS (former DKD) calibration certificate on request.

The batch certificate is also available to download from the supplier's website.

Volume ml	Tolerance ± ml	Overall length ± 10 mm	PK	Cat. No.
1	0.008	300	1	9.273 220
2	0.010	330	1	9.273 221
5	0.015	400	1	9.273 222
10	0.02	440	1	9.273 223
20	0.03	510	1	9.273 224
25	0.03	520	1	9.273 225
50	0.05	540	1	9.273 226

3 Volumetric pipettes, Soda-lime glass, class AS, 2 marks, amber stain graduation

EX (TD) calibrated. Volume between two marks (partial delivery). *Hirschmann*

With dated batch identification. Declaration of conformity acc. to DIN 12600.

Volume mark, ringmark and graduation in durable amber stain graduation, acc. to DIN EN ISO 648.

For those products, batch calibration reports, which are free of charge, can be generated and printed on www.hirschmannlab.com. Additional single calibration reports or DAkkS certificates (former DKD calibration reports) are available.

Volume ml	Tolerance ± ml	Overall length mm	PK	Cat. No.
0.5	0.005	300	1	6.801 018
1	0.008	325	1	6.801 019
2	0.01	350	1	6.801 020
3*	0.01	350	1	6.056 820
5	0.015	410	1	6.801 021
10	0.02	450	1	6.071 748
15*	0.03	520	1	6.225 909
20	0.03	520	1	6.801 022
25	0.03	530	1	6.801 023
50	0.05	550	1	6.801 024
100	0.08	600	1	6.800 124

* Supplementary to DIN.





1 Volumetric pipettes, AR-glas®, class AS, 2 marks, blue graduation

BLAUBRAND®. DE-M marking. DIN EN ISO 648. Adjusted to EX. Graduations and inscriptions in highly contrasting blue enamel. All BLAUBRAND® volumetric pipettes are supplied with batch number and one works batch certificate per manufacturer's outer pack. Also available with individual works or DAkkS (former DKD) calibration certificate on request.

BRAND

The batch certificate is also available to download from the supplier's website.

Volume ml	Tolerance ± ml	Overall length ± 10 mm	PK	Cat. No.
0.5	0.005	300	1	9.273 121
1.0	0.008	300	1	9.273 122
2.0	0.010	330	1	9.273 123
3.0	0.010	330	1	9.273 125
5.0	0.015	400	1	9.273 127
10.0	0.02	440	1	9.273 132
15.0	0.03	510	1	9.273 133
20.0	0.03	510	1	9.273 134
25.0	0.03	520	1	9.273 135
50.0	0.05	540	1	9.273 138



2 Volumetric pipettes, Soda-lime glass, 1 mark, class B, amber stain graduation

EX (TD) calibrated. Tolerances better than class B requirements. With durable amber stain graduation, acc. to DIN EN ISO 648.

Hirschmann

Volume ml	Tolerance ± ml	Overall length ± 10 mm	PK	Cat. No.
0.5	0.008	300	1	9.273 258
1	0.012	325	1	9.273 259
2	0.015	350	1	9.273 260
3*	0.015	350	1	9.273 261
4*	0.023	410	1	9.273 257
5	0.023	410	1	9.273 262
10	0.03	450	1	9.273 263
15*	0.045	520	1	9.273 264
20	0.045	520	1	9.273 265
25	0.045	530	1	9.273 266
50	0.075	550	1	9.273 268
100	0.12	600	1	9.273 269

* Supplementary to DIN.



3 Volumetric pipettes, Class B, AR-glass®, amber graduation

SILBERBRAND Eterna. DIN EN ISO 648. Graduations and inscriptions in Eterna permanent amber diffusion stain. Adjusted to EX.

BRAND

Volume ml	Tolerance ± ml	Overall length ± 10 mm	PK	Cat. No.
0.5	0.007	300**	1	6.254 546
0.5	0.007	300	1	9.273 001
1	0.010	300	1	9.273 002
2	0.015	330	1	9.273 003
5	0.025	400	1	9.273 007
10	0.03	440	1	9.273 012
20	0.04	510	1	9.273 014
25	0.04	520	1	9.273 015
50	0.07	540	1	9.273 018
100	0.12	585*	1	9.273 019

* ±15 mm

**Incl. DAkkS calibration certificate



4 Volumetric pipettes, PP, 1 mark

Highly translucent. Streak-resistant, blue-printed graduations and inscriptions. Adjusted to EX. Exposure to temperatures up to 60°C will not affect tolerances.

BRAND

Cleaning at temperatures below 60°C is recommended to preserve graduations and inscriptions.

Volume ml	Tolerance ± ml	Overall length ± 10 mm	PK	Cat. No.
1	0.02	300	1	9.273 232
2	0.02	300	1	9.273 233
5	0.03	300	1	9.273 235
10	0.04	440	1	9.273 236
25	0.06	450	1	9.273 238
50	0.1	460	1	9.273 239

1 LLG-Graduated pipettes, soda glass, class AS, type 3



- DIN EN ISO 835, DIN 12699
- Conformity-certified
- With batch date identification
- Calibrated to deliver (EX)
- Ring marks and graduations in permanent blue enamel

Nominal capacity ml	Graduations ml	Tolerance ± ml	Length mm	PK	Cat. No.
1	0.01	0.007	360	10	6.272 200
2	0.02	0.01	360	10	6.272 201
5	0.05	0.03	360	10	6.272 202
10	0.1	0.05	360	10	6.272 203
20	0.1	0.1	450	10	6.272 204
25	0.1	0.1	450	10	6.272 205
50	0.1	0.2	720	10	6.272 206



2 Graduated pipettes, soda glass, class AS, type 3

Soda glass. Conformity-certified. With batch date identification.
DIN EN ISO 835, DIN 12699. Calibrated to deliver (EX).
Ring marks and graduations in permanent blue enamel.

ISOLAB

Volume ml	Graduations ml	Tolerance ± ml	Length mm	PK	Cat. No.
1	0.01	0.007	360 ± 5	10	4.672 377
2	0.02	0.010	360 ± 5	10	4.672 378
5	0.05	0.030	360 ± 5	10	4.672 379
10	0.1	0.050	360 ± 5	10	4.672 380
20	0.1	0.100	450 ± 5	10	4.672 381
25	0.1	0.100	450 ± 5	10	4.672 382
50	0.1	0.200	720 ± 5	10	4.672 383

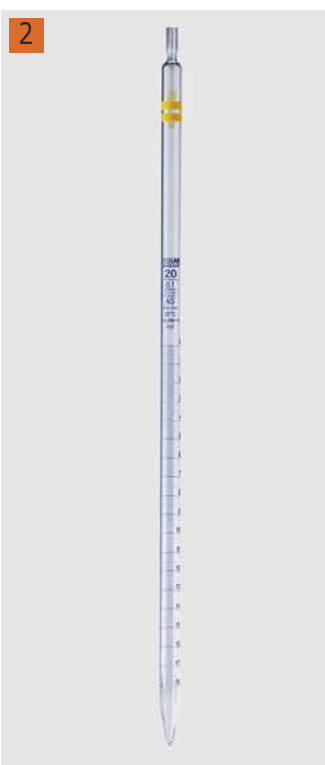

3 Graduated pipettes, Soda-lime glass, class AS , blue graduation, type 3

EX (TD) calibrated. Main point ring graduation. With dated batch identification. *Hirschmann*
Declaration of conformity acc. to DIN 12600. Main point ring graduation.
High-contrast blue graduation. Graduated to the tip, zero on top. Type 3, acc. to DIN EN ISO 835.
From 5ml with cotton plug end as standard.
For those products batch calibration reports, which are free of charge, can be generated and printed on www.hirschmannlab.com. Additional single calibration reports or DAkkS certificates (former DKD calibration reports) are available.

Volume ml	Grad. ml	Tolerance ± ml	Overall length ± 5 mm	PK	Cat. No.
0.5	0.01	0.006	360	1	9.272 380
1	0.01	0.007	360	1	9.272 381
1	0.10	0.007	360	1	9.272 382
2*	0.01	0.01	360	1	9.272 383
2	0.02	0.01	360	1	9.272 384
2	0.10	0.01	360	1	9.272 385
5	0.05	0.03	360	1	9.272 387
5	0.10	0.03	360	1	9.272 388
10	0.10	0.05	360	1	9.272 389
20	0.10	0.1	360	1	9.272 390
25	0.10	0.1	450	1	9.272 391
50*	0.20	0.2	450	1	9.272 392

* Supplementary to DIN



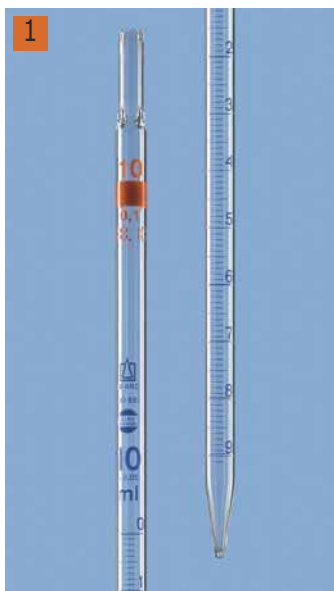

1 Graduated pipettes, AR-GLAS®, class AS, blue graduation

All BLAUBRAND® graduated pipettes are supplied with batch number and one batch certificate per packing unit. On request, they are also available with an individual certificate, USP individual certificate or DAkkS calibration certificate. Batch and individual certificates can also be downloaded at the supplier's website.

BRAND

- BLAUBRAND®
- Type 3 (zero at top)
- DIN EN ISO 835
- DE-M marking
- Ring mark and inscriptions in high contrast, blue enamel
- Calibrated to deliver (Ex)
- Waiting time 5 sec.

Volume ml	Grad. ml	Tolerance ± ml	Length (± 10mm) mm	PK	Cat. No.
0.5	0.01	0.006	360	1	9.272 105
1	0.01	0.007	360	1	9.272 106
1***	0.01	0.007	360	1	9.272 117
1	0.1	0.007	360	1	9.272 107
2**	0.01	0.010	360	1	9.272 108
2	0.02	0.010	360	1	9.272 109
2***	0.02	0.010	360	1	9.272 118
2	0.1	0.010	360	1	9.272 110
5***	0.05	0.030	360	1	9.272 111
5***	0.1	0.030	360	1	9.272 112
10***	0.1	0.05	360	1	9.272 113
20***	0.1	0.10	360	1	9.272 114
25***	0.1	0.10	450	1	9.272 115
50* ***	0.5	0.2	450	1	9.272 116
5	0.05	0.030	360	1	6.251 046

* Supplementary to ISO.

**Supplementary to ISO, not DE-M marked.

***Cotton plugged

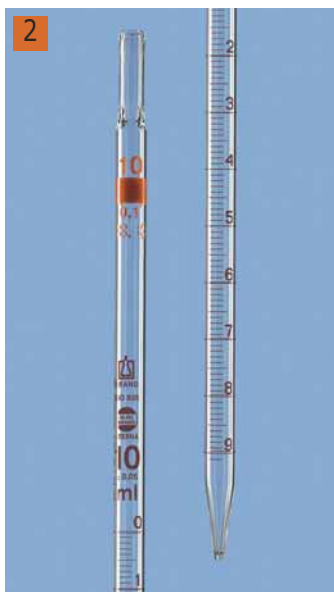

2 Graduated pipettes, AR-glass®, Class AS, amber graduations, type 3

BLAUBRAND® ETERNA, DE-M marking, AR-glass®, DIN EN ISO 835. Type 3 (Zero point at the top), total delivery. Calibrated to deliver (TD, Ex). Waiting time 5 seconds. Ring mark and inscription in ETERNA amber stain.

BRAND

All BLAUBRAND® graduated pipettes are supplied with a batch number and an accompanying batch certificate in the original packaging. On request, they are also available with an individual certificate, USP individual certificate or DAkkS (former DKD) calibration certificate.

Volume ml	Graduations ml	Tolerance ± ml	Suitable for cotton plugs	PK	Cat. No.
0.5	0.01	0.006	-	1	9.272 031
1	0.01	0.007	-	1	9.272 032
1	0.01	0.007	+	1	7.018 397
2	0.02	0.010	-	1	9.272 033
2	0.02	0.010	+	1	7.018 398
5	0.05	0.030	+	1	7.060 678
5	0.1	0.030	+	1	9.272 034
10	0.1	0.05	+	1	9.272 036
20	0.1	0.10	+	1	7.018 413
25	0.1	0.10	+	1	9.272 037



1 Graduated pipettes, Soda-lime glass, class AS, amber stain graduation, type 3

EX (TD) calibrated. Main point ring graduation. With dated batch identification. *Hirschmann*
 Declaration of conformity acc. to DIN 12600. With durable amber stain graduation.
 Graduated to the tip, zero on top. Type 3, acc. to DIN EN ISO 835.
 From 5ml with cotton plug end as standard.
 For those products, batch calibration reports, which are free of charge, can be generated and printed on www.hirschmannlab.com. Additional single calibration reports or DAkkS certificates (former DKD calibration reports) are available.

Volume	Grad.	Tolerance	Overall length	PK	Cat. No.
ml	ml	± ml	± 5 mm		
0.5	0.01	0.006	360	1	6.059 364
1	0.01	0.007	360	1	6.301 732
1	0.1	0.007	360	1	6.303 032
2*	0.01	0.01	360	1	6.305 430
2	0.02	0.01	360	1	6.059 699
2	0.1	0.01	360	1	6.202 868
5	0.05	0.03	360	1	6.081 209
5	0.1	0.03	360	1	6.059 800
10	0.1	0.05	360	1	6.058 191
20	0.1	0.1	360	1	6.200 448
25	0.1	0.1	450	1	6.303 743
50*	0.2	0.2	450	1	6.234 515

* in addition to DIN.

Available also with dated batch USP (U.S. Pharmacopeia).

2 Graduated pipettes, Soda-lime glass, class AS, amber stain graduation, type 2

EX (TD) calibrated. Main point ring graduation. With dated batch identification. *Hirschmann*
 Declaration of conformity acc. to DIN 12600. With durable amber stain graduation.
 Graduated to the tip, zero in tip. Type 2, acc. to DIN EN ISO 835.
 From 5ml with cotton plug end as standard.
 For those products, batch calibration reports, which are free of charge, can be generated and printed on www.hirschmannlab.com. Additional single calibration reports or DAkkS certificates (former DKD calibration reports) are available.

Volume	Grad.	Tolerance	Overall length	PK	Cat. No.
ml	ml	± ml	± 5 mm		
0.5	0.01	0.006	360	1	9.272 350
1	0.01	0.007	360	1	9.272 351
1	0.1	0.007	360	1	9.272 352
2	0.02	0.01	360	1	9.272 353
2	0.1	0.01	360	1	9.272 354
5	0.05	0.03	360	1	9.272 355
5	0.1	0.03	360	1	6.202 713
10	0.1	0.05	360	1	6.202 714
20	0.1	0.1	360	1	9.272 358
25	0.1	0.1	450	1	9.272 359

3 Graduated pipettes, Class AS, AR-glas®, blue graduation, type 2

BLAUBRAND®, DIN EN ISO 835, DE-M marking. Type 2 (nominal volume at top), *BRAND*
 total delivery. Calibrated to deliver (TD, EX). Waiting time 5 seconds.
 Marks and inscriptions in high contrast blue enamel.
 All BLAUBRAND® graduated pipettes are supplied with batch number and one batch certificate per manufacturer's outer pack. Also available with individual works, USP, or DKD calibration certificate on request.
 The batch certificate is also available to download from the supplier's website.

Volume	Grad.	Tolerance	Overall length	PK	Cat. No.
ml	ml	± ml	± 10 mm		
0,5	0.01	0.006	360	1	9.272 016
1	0.01	0.007	360	1	9.272 017
1	0.1	0.007	360	1	9.272 018
1***	0.01	0.007	360	1	9.272 027
2**	0.01	0.010	360	1	9.272 029
2	0.02	0.010	360	1	9.272 019
2	0.1	0.010	360	1	9.272 020
2***	0.02	0.010	360	1	9.272 028
5***	0.05	0.030	360	1	9.272 021
5***	0.1	0.030	360	1	9.272 022
10***	0.1	0.05	360	1	9.272 023
20***	0.1	0.10	360	1	9.272 024
25***	0.1	0.10	450	1	9.272 025
50* ***	0.5	0.2	450	1	9.272 026

* Supplementary to ISO.

**Supplementary to ISO, not DE-M marked

***Cotton plugged



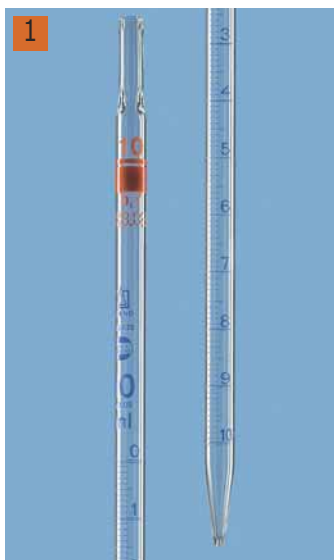

1 Graduated pipettes, BLAUBRAND®, partial delivery, blue graduations, type 1

AR-glas®. DE-M marking. DIN EN ISO 835. Type 1 (Zero at top).

BRAND

Calibrated to deliver (TD, EX). Waiting time 5 seconds.

Ring mark and inscriptions in high contrast blue enamel.

All BLAUBRAND® graduated pipettes are supplied with batch number and one batch certificate per manufacturer's outer pack (up to 10ml: 12 pipettes, 25 ml: 6 pipettes). Also available with individual works, USP, or DAkkS (former DKD) calibration certificate on request.

The batch certificate is also available to download from the supplier's website.

Volume ml	Graduations ml	Tolerance ± ml	Overall length ± 10 mm	PK	Cat. No.
0,5	0.01	0.006	360	1	9.272 121
1	0.01	0.007	360	1	9.272 122
2*	0.01	0.010	360	1	9.272 124
2	0.02	0.010	360	1	9.272 125
5**	0.05	0.030	360	1	9.272 127
10**	0.1	0.050	360	1	9.272 129
25**	0.1	0.100	450	1	9.272 131

* in completion to ISO, not with conformity certificate

**Cotton plugged



2 Graduated pipettes AR-GLAS®, class A, type graduated to contain, blue graduations

All BLAUBRAND® bulb pipettes are supplied with batch number and one batch certificate per packing unit. On request, they are also available with an individual certificate, USP individual certificate or DAkkS calibration certificate. Batch and individual certificates can also be downloaded at the supplier's website.

BRAND

- BLAUBRAND®
- DIN 12689
- DE-M marking
- Graduations and inscriptions in high contrast blue enamel
- Calibrated to contain (TC, IN)

Volume ml	Type	Graduations ml	Tolerance ± ml	Overall length ± 10 mm	PK	Cat. No.
0.1	Incl. individual certificate	0.001	0.001	360	1	6.281 967
0.1	Incl. DAkkS calibration certificate	0.001	0.001	360	1	6.281 968
0.1	Incl. batch certificate	0.001	0.001	360	1	9.272 102
0.2	Incl. batch certificate	0.002	0.002	360	1	9.272 104

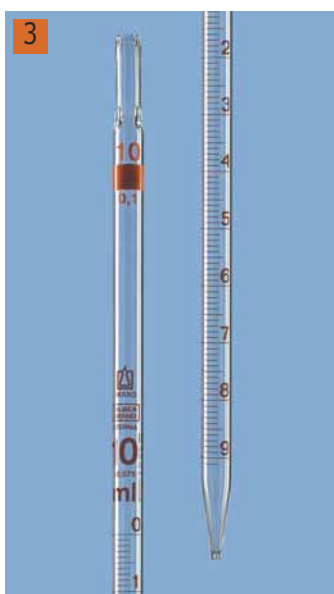

3 Graduated pipettes, Class B, AR-glass®, amber graduations, type 3

SILBERBRAND Eterna. DIN EN ISO 835. Type 3 (zero at top).

BRAND

Graduations and inscriptions in Eterna permanent amber diffusion stain.

Adjusted to EX.

Volume ml	Grad. ml	Tolerance ± ml	Overall length ± 10 mm	PK	Cat. No.
1	0.01	0.010	360	1	9.272 070
1	0.1	0.010	360	1	9.272 071
2*	0.01	0.015	360	1	9.272 072
2	0.02	0.015	360	1	9.272 073
5**	0.05	0.05	360	1	9.272 075
5**	0.1	0.05	360	1	9.272 076
10**	0.1	0.08	360	1	9.272 077
20**	0.1	0.150	360	1	9.272 078
25**	0.1	0.150	450	1	9.272 079

* Supplementary to ISO.

**Cotton plugged

1 Graduated pipettes, Soda-lime glass, class B, amber stain graduation, type 3

EX (TD) calibrated. Tolerances better than class B requirements.
With durable amber stain graduation, short line, graduated to tip,
zero on top, type 3, acc. to DIN EN ISO 835.
From 5ml with cotton plug end as standard.

Hirschmann

Volume ml	Grad. ml	Tolerance ± ml	Overall length ± 5 mm	PK	Cat. No.
0.5	0.01	0.0075	360	1	9.272 366
1	0.01	0.01	360	1	9.272 367
1	0.1	0.01	360	1	9.272 368
2*	0.01	0.015	360	1	9.272 376
2	0.02	0.015	360	1	9.272 369
2	0.1	0.015	360	1	9.272 370
5	0.05	0.045	360	1	9.272 371
5	0.1	0.045	360	1	9.272 372
10	0.1	0.075	360	1	9.272 373
20	0.1	0.15	360	1	9.272 374
25	0.1	0.15	450	1	9.272 375
50*	0.2	0.3	450	1	9.272 377

* Supplementary to DIN.

1



2 Graduated pipettes FORTUNA®, with suction piston, AR-Glass, similar to class A

With permanent, blue or amber enamelled graduations.
Tolerances similar to class A.

Poulsen & Graf

Capacity ml	Grad. ml	Graduations	PK	Cat. No.
1	0,01	blue	1	6.205 081
2	0,02	blue	1	6.235 819
5	0,1	blue	1	6.072 024
5	0,05	blue	1	7.510 539
10	0,1	blue	1	6.071 992
20	0,1	blue	1	6.262 718
25	0,1	blue	1	6.801 187
1	0,01	amber	1	9.273 301
2	0,02	amber	1	9.273 302
5	0,1	amber	1	6.252 857
5	0,05	amber	1	9.273 305
10	0,1	amber	1	9.273 310
20	0,1	amber	1	9.273 320
25	0,1	amber	1	9.273 325

2



3 Graduated pipettes, PP, blue graduations



BRAND

Transparent. Particularly suitable for education and for applications where glass pipettes should not be used.
Exposure to temperatures up to 60°C will not cause permanent exceeding of tolerance limits.
Cleaning below 60°C is recommended to preserve graduations and inscriptions.

- Type 3 (Zero point at the top)
- Streak resistant
- Suction tube outer Ø max. 8 mm
- Calibrated to deliver (EX)

Capacity ml	Graduations ml	Tolerance ± ml	Overall length ± 10 mm	PK	Cat. No.
1	0.1	0.02	300	1	9.272 507
2	0.1	0.02	300	1	9.272 510
5	0.1	0.05	330	1	9.272 512
10	0.1	0.1	320	1	7.200 375
10*	0.1	0.1	330	1	9.272 513

* Suction tube outer Ø 10 mm

3

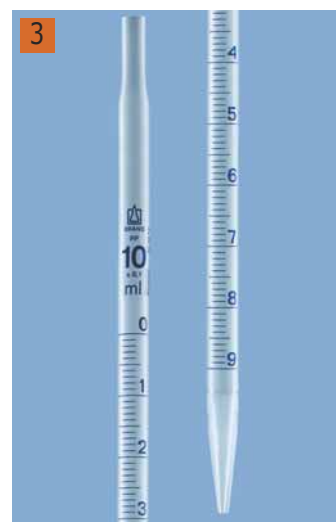



1 LLG-Pasteur pipettes, Soda-lime-glass

Single use. With uniform shape and length. With long drawn, 1.1mm diameter fine tip, 20mm suction tube and constriction for tight fitting of cotton wool plugs. External diameter: 7.1mm. Please order Pipette teats separately.

Length mm	Acc. to	PK	Cat. No.
150	ISO 7712	1000	9.411 015
230	ISO 7712	1000	9.411 020



2 Pasteur pipettes, Soda-lime-glass

ISO 7712. Long drawn-out capillary tip. Suction end with constriction for a cotton plug.

BRAND

Nominal capacity ml	Length mm	PK	Cat. No.
1.5	145	250	7.020 294
1.5	225	250	7.020 295
1.5	270	1000	4.665 820
1.5	310	1000	4.665 821



3 Pasteur pipettes, soda glass

Extra long tip, optimal for NMR applications. With constriction, without cotton wool.

NEW
Hilgenberg

Length mm	PK	Cat. No.
300	1000	4.672 077
350	1000	4.672 078

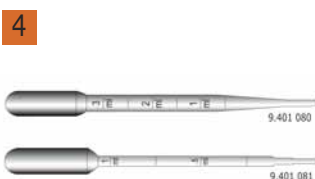

4 LLG-Pasteur Pipettes, PE

Manufactured from transparent PE. Sterile or non-sterile. Graduated.

Type	Capacity ml	Length mm	PK	Cat. No.
non-sterile	1	150	500	4.672 670
non-sterile	3	150	500	4.672 671
sterile, single wrapped	1	150	1000	9.401 085
sterile, single wrapped	3	150	1000	9.401 084

5 6 Pipettes, Pasteur, PE

For transfer of liquids. Resistant against almost all acids. Soft and elastic bulb.

Type	Capacity ml	Length mm	Sterile	Graduations	PK	Cat. No.
Standard	1.0	138	-	+	500	6.204 264
Standard	1.0	150	-	+	500	9.411 031
Standard, single wrapped*	1.0	150	+	+	500	9.411 038
Capillary, single wrapped*	1.0	144	+	+	500	9.411 039
Standard	1.5	230	-	+	400	7.200 111
Standard	2.0	153	-	+	500	7.631 961
Standard	2.5	150	-	+	500	6.229 723
Macro	3.0	155	-	+	500	9.411 030
Macro, single wrapped	3.0	150	+	+	500	9.411 035
Micro*	3.0	152	-	-	500	9.411 032
Standard, with ring mark	10.0	170	-	-	200	9.411 033
Standard	10.0	300	-	-	100	6.203 402
Mini Pastette®	1.0	104	-	-	400	9.271 985
Ultra Pastette®	1.0	63	-	-	500	9.271 986
Jumbo Pastette®	7.3	300	-	-	100	9.271 980

* Total volume

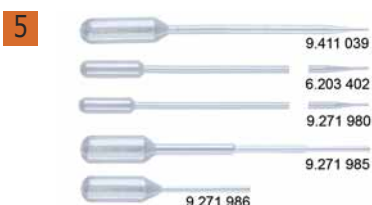

1 Transfer pipettes Samco™, PE

Repeatable Results

- Inert, non-toxic Polyethylene
- Manufactured without mold release agents that could interfere with test results

Confidence

- Precision-cut tips deliver a uniform drop size
- Controlled processes produce a uniform bulb with uncompromised integrity
- Certified ISO 13485:2003

Design

- Grips easily with latex gloves 13 no slipping
- Fine tip accuracy
- Packaging materials greatly reduce airborne mold spores from entering testing areas

Thermo Scientific



Pipettes Samco™, PE, general purpose and B/B Pet™

For tissue cultures and applications, sample transfer of serum and plasma, blood culture, urine analysis.

Thermo Scientific

Description	Length	Capacity	Sterile	Stem diam.	PK	Cat. No.
	mm	ml		mm		
General Purpose, extra small bulb	72	0.6	-	3.3	500	4.654 058
General Purpose, 3"	87	1.8	-	4.8	500	4.654 047
General Purpose, 3"	87	1.8	+	4.8	500	4.654 048
General Purpose, 4" B/B Pet (Blood Bank)	103	3.1	-	2.5	400	4.654 071
General Purpose, 4" B/B Pet (Blood Bank)	103	3.1	-	2.5	400	4.654 072
General Purpose, small bulb	127	13.7	-	2.5	500	4.654 070
62 µL Large Aperture Pipette	137	9.5	-	6.1	250	4.654 083
General Purpose, 62 µL Large Aperture Pipette	137	9.5	+	6.1	250	4.654 084
General Purpose, 62 µL Large Aperture Pipette	137	9.5	-	6.1	250	4.654 086
General Purpose, 62 µL Large Aperture Pipette	137	9.5	+	6.1	250	4.654 087
General Purpose, Beral	145	5.5	-	2.8	500	4.654 107
General Purpose, large bulb	151	8.6	-	6.1	400	4.653 958
General Purpose, large bulb	151	8.6	+	6.1	400	4.653 959
General Purpose, large bulb	151	8.6	-	6.1	400	4.653 961
General Purpose, large bulb	151	8.6	+	6.1	400	4.653 962
6" B/B Pet (Blood Bank)	154	4.9	-	6.6	500	4.654 076
General Purpose, 6" B/B Pet (Blood Bank)	154	4.9	+	6.6	500	4.654 078
General Purpose, standard bulb	156	7.7	-	7.9	500	4.653 952
General Purpose, standard bulb	156	7.7	+	7.9	500	4.653 953
General Purpose, standard bulb	156	7.7	-	7.9	500	4.653 955
General Purpose, standard bulb	156	7.7	+	7.9	500	4.653 956

Further models can be found in our online shop.

2 Aspiration pipettes, PS



Transfer pipets without graduation, ideal for liquid transfer.

- Available in sterile or non-sterile version
- Colourless and transparent
- Pyrogen-free
- Bulk package in easy-to-open plastic bags

Capacity ml	Sterile	PK	Cat. No.
1	+	1000	4.672 564
2	+	1000	4.672 565
5	+	400	4.672 566
10	+	400	4.672 567
25	+	150	4.672 568
50	+	100	4.672 569
2	-	1000	4.672 570
5	-	400	4.672 571
10	-	400	4.672 572
25	-	150	4.672 573
50	-	100	4.672 574



8. Liquid Handling

Pipettes/Serological pipettes

1 LLG-Serological pipettes, PS, sterile

Serological pipettes from LLG are ideally suited for sterile serological and cell culture applications. Easy to read graduation scales facilitate volume measurement and dosing. All LLG serological pipettes are plugged, sterile, pyrogen-free and have an increased volume capacity through extra graduations.

- Also available as short-pipettes (5 ml, 10 ml and 25 ml) or wide-mouth pipette (10 ml)
- 1 ml, 5 ml, 10 ml, 25 ml and 50 ml pipettes contain a bi-directional secondary graduation scale for precise dosing
- Colour coded ringmark for easy volume identification
- Single packed in easy-to-open plastic/paper packaging

Volume ml	Grad. ml	Colour code	Negative graduations	PK	Cat. No.
1	1/100	yellow	0,3	500	9.380 440
2	1/50	green	0,6	500	9.380 441
5	1/10	blue	3	200	7.930 401
10	1/10	orange	3	200	6.268 240
10	1/10	orange (wide mouth)	3	200	9.380 442
25	2/10	red	8	150	7.930 403
50	5/10	purple	10	100	9.380 443
5	1/10	blue (short form)	3	200	6.265 881
10	2/10	orange (short form)	10	150	6.265 882
25	5/10	red (short form)	9	100	6.265 883



2 Serological pipettes, PS, bulk package, sterile

- Single packed in bulk package
- Increased volume capacity through extra graduations
- Colour coded for easy volume identification
- Plugged, filters/plugs made of PET
- Pyrogen-free
- DNase-/RNase-free
- Free of human DNA
- Sterile

Thermo Scientific

Plastic/Plastic-Peel packaging

Capacity ml	Grad. ml	additional scale ml	Tolerance ± ml	Colour code	PK	Cat. No.
1	1/100	0.3	0.02	yellow	1000	9.380 464
2	1/100	0.3	0.04	black	500	9.380 465
5	1/10	2	0.10	blue	200	9.380 466
10	1/10	3	0.20	orange	200	9.380 467
25	2/10	10	0.50	green	200	9.380 468
50	2/10	10	0.75	purple	100	9.380 469



1 2 LLG-Electrical pipette *Plus*



Ergonomic and precise - the cordless and lightweight LLG-Electrical pipette *Plus* enables fast and exact pipetting with glass and plastic pipettes.

- UV resistant housing
- Fatigue-proof pipetting due to ergonomically shaped handle
- Suitable for left and right handers
- Exchangeable filters protect the device mechanism from contamination
- LED display with speed display: High, Low or Gravity mode (for free liquid flow without drive operation)
- 5 different coloured autoclavable nose pieces and labelling area enables customisation of the pipette
- Extremely quiet and powerful drive
- Low-Battery LED indicator

Scope of supply: Charger (5 V micro USB), Li-Ion battery, 5 coloured nose pieces, 3 membrane filters, adapter for 1 ml pipettes, benchtop rack, magnetic wall mounting

Specifications

Membrane filters:	PTFE/Ø 25 mm /0.45 µm
Capacity:	1 to 100 ml, glass and plastic pipettes
Pipette attachment:	Polypropylene, autoclavable
Dimensions:	15 x 152 x 41 mm
Weight:	approx. 200 g
Power supply:	rechargeable Li-Ion battery, 8 h continuous operation
Warranty:	1 year

Description	PK	Cat. No.
LLG-Electrical pipette <i>Plus</i>	1	9.281 041
Membrane filter, 0.45µm, PTFE, non-sterile	5	9.281 005
Replacement accu	1	6.267 647



3 Pipette Fillers Profiller™ 447

Electronic pipette filler which allows longer and fatigue-free pipetting due to comfortable hand adjustment. Shape is ideal for working with glass or plastic pipettes. A powerful, quiet motor and a switch to set both aspiration and dispensing speeds enable maximal working efficiency even with large pipetting volumes.

Socorex

- Powerful pump (fills 25 mL in 3 seconds)
- Comfortable finger triggers
- Low battery light
- NiMH battery rechargeable during use
- Interchangeable protection membrane filter

Scope of delivery: Pipette filler Profiller™ 447, power supply, four plug adaptors (EU, US/JP, GB, AUS/NZ), two spare hydrophobic filters (0.45 µm and 0.2 µm), bench and wall stands and instruction manual.

Type	PK	Cat. No.
Profiler™ 447	1	4.665 542





1 Pipette Filler, pipetus®

The pipetus® is ergonomically sophisticated in every detail despite most modern technology, powerful and light-weight. Fits graduated, volumetric and Pasteur pipettes from 0.1 ml to 200 ml. Without reloading it can be operated up to one week. The colour display shows the selected defaults (speed) and the current battery capacity

Hirschmann

- Automatic inductive charge in the park station guarantees constant readiness
- Controlled pipetting by a simple push of a button
- EX/Blow out switch for precise operating
- Speed key for 5 operating speeds
- No memory effect by inserted microcontroller
- Clear colour display with permanent display
- Optimal meniscus adjustment by sensitive valve technique
- Standard relief valve against penetration of liquid
- Ergonomic design for fatigue-free serial pipetting
- Power supply 100-240 V, with EU, UK, US plugs

Supplied with:

pipetus® complete with mains operated charging unit and inductive charging stand, color display with battery level indicator, 2 additional round PTFE filters, additional safety valve and wall mount.

Type	PK	Cat. No.
pipetus®	1	9.283 958



Pipette controllers, pipetus®, accessories

Hirschmann

Type	PK	Cat. No.
Pipette holder, complete	1	9.283 970 2
Round filter set with one-sided connection	5	9.283 965
Spare silicone adapter	1	9.283 961
Spare safety valve	1	9.283 962
Charging set 230 V including inductive charging station, EU, UK, US plug	1	9.283 966
Mounting bracket	1	9.283 967
Retainer Ring, chrome	1	9.283 968 3
Pipette holder housing	1	9.283 969
Table Stand	1	9.287 859



4 Pipette controller accu-jet® pro

BRAND

- Additional battery compartment cover (included) allows instrument to be inverted on the bench to avoid contamination of the pipette adapter
- Corrosion protection by direct exhaust of liquid vapours
- Safety valve/membrane filter for protection against fluid penetration
- One-hand operation
- Stepless regulation of the maximum pipetting speed
- Powerful motor for fast filling times (50ml in 10 seconds)
- Liquid discharge optionally in gravity-delivery or motorised blow-out
- Engine speed variable
- A flashing LED light will alert you approx. two hours in advance
- 8 hours of continuous pipetting with a 10 ml pipette without recharging
- For glass and plastic pipettes from 0.1 to 200 ml

Scope of delivery: accu-jet® pro, incl. wall support, 2 membrane filters 0.2µm sterile, NiMH battery pack, 2 battery compartment covers, instruction manual and power supply unit (100 - 240 V, 50/60 Hz).

Specifications:

Operating and charging temperature: 10 ... 35 °C
 Pipetting speed: 50 ml in less than 10 seconds
 Weight: 190 g
 Battery pack: NiMH battery 2.4 V/700 mAh

Type	Colour	PK	Cat. No.
With AC adapter for Europe (continental)	dark blue	1	9.281 090
With AC adapter for Europe (continental)	magenta	1	9.281 086
With AC adapter for Europe (continental)	green	1	9.281 087
With AC adapter for Europe (continental)	royal blue	1	9.281 088
With AC adapter for UK / Ireland	dark blue	1	4.000 031
With AC adapter for UK / Ireland	magenta	1	4.000 032
With AC adapter for UK / Ireland	green	1	4.000 033
With AC adapter for UK / Ireland	royal blue	1	4.000 034
Without AC adapter	dark blue	1	4.000 030

Accessories for accu-jet® controller

BRAND

Description	PK	Cat. No.
NiMh-Akku battery pack only	1	9.281 096
Silicone adapter, with non-return valve (PTFE)	1	9.281 094
Membrane filter, 0.2 µm, in blister pack, sterile*	1	9.281 092
Membrane filter, 0.2 µm, in PE bag, non-sterile	10	9.281 091 1
Membrane filter, 3 µm in blister pack, non-sterile	1	9.273 868
Membrane filter, 3 µm, in PE bag, non-sterile	10	9.281 095
Recharger for accu-jet® pro, Europe	1	6.224 985
Recharger for accu-jet® pro, UK / Ireland	1	4.000 047
Adapter support for accu-jet® pro, PP, dark blue	1	7.082 717 2
Adapter support for accu-jet® pro, PP, magenta	1	4.000 051
Adapter support for accu-jet® pro, PP, green	1	4.000 052
Adapter support for accu-jet® pro, PP, royal blue	1	4.000 053
Wall support for accu-jet® pro	1	7.018 383
Snap tapes for accu-jet® pro	1	7.018 384

* Sterilized with ethylene oxide (ETO), SAL of 10⁻⁶, with red colour code



9.281 091



7.082 717

3 Macropipette controllers

The handwheel allows precise suction of the liquid into the pipette with one hand. When the wheel stops, the piston remains in the desired position. The liquid can be blown out by pressing the piston back or allowed to flow out by setting the lateral switch to "Ex".

ISOLAB

For	PK	Cat. No.
Pipette volume up to 2ml	1	4.008 322
Pipette volume up to 10ml	1	4.008 323
Pipette volume up to 25ml	1	4.008 324



4 Pipette filler Pi-pump

Pipette filler Pi-pump made of acid-proof plastic, suitable for all pipettes. By turning the knurled wheel, a piston is moved and liquids can be sucked up or released from the pipette. This technique allows for safe and precise pipetting by hand. Releasing the liquids precisely, i.e. line by line, is easily possible. Sizes 2, 10 and 25 are additionally equipped with a fast release valve which allows for free release of liquids instantly.

Glasfirn Gießen

For pipettes up to ml	Colour	PK	Cat. No.
0,2	yellow	1	9.273 872
2,0	blue	1	9.273 873
10,0	green	1	9.273 874
25,0	red	1	9.273 875



5 Maxi pipette filler, 1 to 100ml

Large capacity bulb which works perfectly with all pipette sizes from 1ml up to 100ml. First squeeze the silicone bulb and the thumb lever controls both the aspirate and dispense modes. Incorporates central button to blow out the residual liquid into the pipettes

ISOLAB

Type	PK	Cat. No.
Maxi pipette filler	1	6.238 525



5

Pipettes/Pipette controllers-Pipette balls



1 Pipette controllers macro 0.1 to 200ml

BRAND



One single macro pipette controller covers the entire range of bulb and graduated pipettes from 0.1 to 200 ml. The conical silicone adapter offers a secure fit for the different diameters. The unique valve system allows for easy compression of the newly designed bellows. The spring loaded lever enables an even more sensitive filling and delivery of liquids. The meniscus is easily adjustable. The unit is fully autoclavable at 121 °C (2 bar) according to DIN EN 285. A hydrophobic membrane filter protects the system from liquid penetration.

Supplied with: pipette controller incl. 3 µm spare membrane filter.

Type	PK	Cat. No.
Pipette controller macro, grey	1	9.273 850
Pipette controller macro, magenta	1	9.273 853
Pipette controller macro, green	1	9.273 851
Pipette controller macro, blue	1	9.273 852
Spare hydrophobic membrane filter	1	9.273 868
Valve assembly	1	9.273 860
Spare adapter, silicone	1	9.273 861



2 Pipette teats

Natural rubber(NR)/Latex or Silicone (VMQ)

Deutsch & Neumann

Capacity ml	Colour	Material	PK	Cat. No.
2	red	NR/Latex	100	4.661 160
2	transparent/white	VMQ	10	9.072 682



3 Pipette teats, silicone

NEW

Hilgenberg

The pipette teats are available in different colours and are suitable for pasteur pipettes with Ø 7 mm.

- With roll-away lock
- Slightly flattened shape with structured, nonskid grip area
- Extra large volume of over 2 ml
- Oval body for better handling

Colour	PK	Cat. No.
Transparent turquoise	100	4.672 074
Transparent anthracite	100	4.672 075
Transparent red	100	4.672 076



4 Pipette bulbs

Rubber. For quick and easy pipetting. Colour coding to prevent confusion.

Colour	Capacity ml	PK	Cat. No.
Grey	2	1	9.115 502

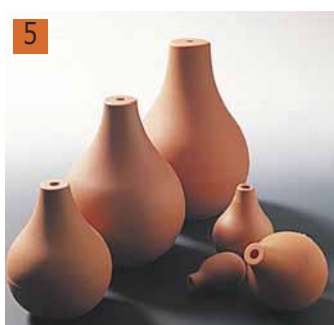

5 Rubber blowballs

Non-rigid PVC. Red-brown, smooth. With 6mm i.d. outlet hole.

Deutsch & Neumann

Type	Capacity ml	Diam. mm	PK	Cat. No.
B oval	5	30	1	9.115 404
0	10	30	1	9.115 411
2	28	42	1	9.115 430
3	42	48	1	9.115 450
5	90	62	1	9.115 480
7	145	72	1	9.115 485
9	225	84	1	9.115 487

1 LLG-Safety pipette bulb, rubber, red

Chemically resistant rubber. With valves for suction, emptying and air release, controlled by thumb and finger pressure.

Type	Figure	PK	Cat. No.
LLG-Safety pipette bulb, normal	A	1	6.270 265
LLG-Safety pipette bulb, universal	B	1	6.270 266
LLG-Safety pipette bulb, "Flip"	C	1	6.270 267

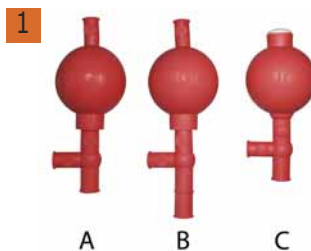

2 Safety pipette bulb Howorka-Ball®

- no rigid connection with tube
- no valves or side vent on tubes
- suitable for all standard tube diameters, including pipettes, burettes, filter tubes etc.
- no unstable air pockets
- long operational life due to durable components
- Easily cleaned and steam sterilized if contaminated with liquids

Capacity ml	PK	Cat. No.
20	1	9.273 826
50	1	9.273 827



3 Pipette stand, horizontal, PP

Pipette stand for 12 pipettes, horizontal is made from moulded polypropylene which is autoclavable. On each side, 6 pipettes (longer than 22 cm) can be stored horizontally. Easy to clean. ISOLAB

Dimensions mm	PK	Cat. No.
210 x 155 x 230	1	9.273 896



4 Pipette stand, vertical, PP

The pipette carousel can be rotated 360° and can hold up to 94 pipettes. The pipettes are placed vertically in the stand. The base plate has a raised edge which catches dripping liquids. ISOLAB

Type	PK	Cat. No.
Pipette stand, vertical	1	9.273 895



5 Pipettes stand, PP, chrome-plated steel

Frame for pipettes with two rotating perforated plates and drip pan. For drying and space-saving storage of pipettes, thermometers and test tubes. The holders are suitable for up to 40 pipettes up to a max. diameter of 18 mm. **NEW**
Bürkle

- Rotatable
- Very sturdy pedestal
- Magnetic concept, no clamping screws necessary
- Adjustable height up to 450 mm

Type	PK	Cat. No.
Pipettes stand	1	6.079 517



6 Pipette stand, PS

Manufactured from polystyrene for easy organisation of all kinds of pipettes. Cranated design enables safe holding of large size pipettes in longitudinal direction and short size pipettes in transverse direction. Can also be used in drawers as well as on bench tops. ISOLAB

Width mm	Length mm	Height mm	PK	Cat. No.
216	283	40	1	6.286 606

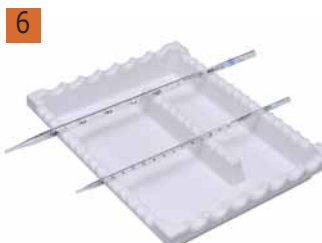



1 Pipette tray, PVC

PVC. For pipettes of all sizes. Can accommodate 7 pipettes with overall stem diameter not exceeding 20mm longitudinally or 16 pipettes with stem diameter not exceeding 10mm laterally.

Kartell

Width mm	Length mm	Height mm	PK	Cat. No.
216	283	40	1	9.200 392



2 Pipette tray, PVC

PVC. Tidy tray. With 4 long compartments for approx. 30 graduated pipettes (1ml to 20ml).

Kartell

Width mm	Length mm	Height mm	PK	Cat. No.
300	426	30	1	9.200 394



3 Pipette storage container

With lid. Suitable for dust-proof storage of pipettes up to 400 mm long.

Kartell

Type	Dimensions (dia. x H) mm	PK	Cat. No.
With lid (PP container, HDPE lid)	82 x 426	1	9.273 900



9.273 985

Pipette rinser system

For easy and gentle cleaning of pipettes according to the suction lifter principle.

Kartell

A complete rinsing system consists of pipette washer, pipette soaking jar and pipette basket, please order separately. Heat resistant up to 105 °C, good chemical resistance.

Pipette basket: For holding pipettes up to 600 mm or burettes acc. to Mohr. The basket is equipped with a handle and a height-adjustable ring. The bottom of elastic PE reduces the risk of damage to the pipettes.

Pipette soaking jar: For pre-cleaning of the pipettes

Pipette rinser: For rinsing the pre-cleaned pipettes. The emptying siphon permits constant water exchange. The water inlet should be approx. 2 l/min.

Type	Diam. mm	Height Insert mm	Height mm	PK	Cat. No.
Pipette baskets	145	280	495*	1	9.273 980
Pipette baskets	145	280	645*	1	9.273 985 4
Pipette baskets	145	280	870*	1	9.273 990
Pipette soaking jar	125	-	250	1	9.273 928
Pipette soaking jar	165	-	503	1	9.273 920
Pipette soaking jar	165	-	650	1	9.273 925
Pipette rinser	170	-	734	1	9.409 238
Pipette rinser	173	-	980	1	9.409 239

*with handle

➔ Further pipette cleaning devices please see chapter 11

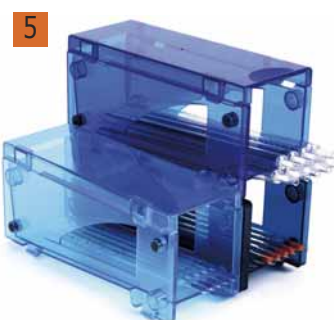

5 Rack for serological pipettes

Ideal for your serological pipettes. Use as individual units, or click together horizontally or vertically. Magnets on both sides of units connect safely to metal surface such as file cabinets, fume hoods, refrigerators, and freezers. Angled shelves store your 0.1ml to 50ml pipettes within arm's reach for use. Protective lid encloses the unit to prevent dust build up. Colour: 3 different shades of blue. Dimensions (L x W x H): 301mm x 100mm x 127.5mm each.

Heathrow Scientific

Type	PK	Cat. No.
Cargo Manual Pipette Rack	3	9.273 930

1 Variable pipette boxes

Comprising two, sliding aluminium sections which can be gently pressed together in a telescopic fashion to fit the length of the pipettes to be sterilized. This means that only one container size for 280 to 420 mm long standard pipettes and one for 145 to 235 mm long short or pasteur pipettes are required. 2 mm thick silicone rubber pad prevents damage to pipettes when loading and transporting.

ISOLAB

Type	Int. diam. mm	Variable length mm	PK	Cat. No.
Pipette box	60	145-235	1	9.010 801
Pipette box	60	280-420	1	9.010 800
Silicone pad	58		1	9.010 770

2 Pipette sterilizing boxes

Cylindrical. 18/10 stainless steel. With silicone pad in base and lid. Rotating the lid exposes or hides the lid perforations. Sterilizable up to 205 °C.

Bochem

Diam. mm	Height mm	Effective length mm	PK	Cat. No.
50	390	382	1	9.010 790
50	425	417	1	9.010 791
65	380	372	1	9.010 792
65	450	442	1	9.010 793
80	380	372	1	9.010 794
80	500	492	1	9.010 795

3 Pipette sterilizing boxes, square

Square section. Stackable. 18/10 stainless steel. With silicone pad in base and lid. Box W x D: 70 x 70 mm. Sterilizable up to 205 °C.

Bochem

Diam. mm	Length mm	Effective length mm	PK	Cat. No.
70 x 70	210	202	1	9.010 781
70 x 70	290	282	1	9.010 782
70 x 70	340	332	1	9.010 783
70 x 70	435	427	1	9.010 784
70 x 70	490	482	1	9.010 785

4 Pipette container, Aluminium

Pipette boxes with optimized easy handling in everyday work. The cylindrical pipette boxes are the best option for autoclaving various glass items with a length from 150 to 480mm like mixing rods, pasteur, volumetric and graduated pipettes.

Ratiolab

- autoclaving: the new construction guarantees the entrance of steam into the container and optimizes the process of autoclaving
- opening and closing: soft sliding performance of top section onto the base section makes working easy
- base and top section are filled with a silicon layer at the bottom as a shock absorber to protect the glass items from splintering

Description	Length mm	PK	Cat. No.
Pipet box aluminium	160 ... 200	1	6.266 679
Pipet box aluminium	235 ... 305	1	6.266 680
Pipet box aluminium	315 ... 385	1	6.266 681
Pipet box aluminium	315 ... 485	1	6.266 682

5 Stainless steel rack for 4 pipette containers

For space-saving and safe storage of up to 4 pipette containers.

NEW
Ratiolab

Type	Dimensions (W x D x H) mm	PK	Cat. No.
Stainless steel rack	250 x 265 x 120	1	6.312 262





9.411 333

Disposable micropipettes ring marked, intraMARK

BLAUBRAND®. DIN ISO 7550.

BRAND

DE-M marking from 5µl upwards, in accordance with German Weights and Measure Regulations. Calibrated to contain (IN). Colour code according to ISO for clear identification.

Length 125 mm

Accuracy ±0.25 %

Precision ≤ 0.5 %

(Capacity 5 µl: Accuracy ±0.3 %, precision ≤ 0.6 %)

Marks at	Colour	PK	Cat. No.
µl			
1/2/3/4/5*	White	250	9.411 307
10	Orange	250	9.411 309
20	Black	250	9.411 318
25*	White - white	250	9.411 322
40*	Red - red	250	9.411 327
20 + 40*	Red - red	250	9.411 328
50	Green	250	9.411 333 1
100	Blue	250	9.411 344
50 + 100	Blue	250	9.411 345
200	Red	200	9.411 357

* DE-M marking for 5 µl division only.



2 Pipetting aid, intraEnd

For BLAUBRAND® intraEnd micropipettes.

BRAND

Consists of the PET plastic tube, silicone adapter, and TPE suction bellows with venting hole.

Type	PK	Cat. No.
Pipetting aid, intraEnd	10	9.411 440

3 Capillary pipettes, ringcaps®

Disposable capillary pipettes with ring marks. ringcaps® are exclusively made out of DURAN® glass.

Hirschmann

The accurately designed ring mark guarantees precise determination of volume, the international color code on every single micropipette prevents the risk of confusion.

Unit = 1 box of 250 pieces.

Version 100 + 200 = 1 box of 100 pieces.

Advantages:

- No risk of cross contamination owing to single use
- DURAN® glass
- Handy length of 125mm
- Declaration of conformity acc. to DIN 12600

Type	Capacity µl	Accuracy max. vol. (± R%)	Precision max. vol. (≤ CV%)	PK	Cat. No.
5 marks	1 + 2 + 3 + 4 + 5	0.30	0.6	250	9.600 105
1 mark	10	0.25	0.5	250	9.600 110
1 mark	20	0.25	0.5	250	9.600 120
1 mark	25	0.25	0.5	250	9.600 125
1 mark	40	0.25	0.5	250	9.600 140
1 mark	50	0.25	0.5	250	9.600 150
1 mark	100	0.25	0.5	250	9.600 199
1 mark	200	0.25	0.5	100	9.600 122
2 marks	5 + 10	0.25	0.5	250	9.600 210
2 marks	20 + 40	0.25	0.5	250	9.600 240
2 marks	50 + 100	0.25	0.5	250	9.600 299
2 marks	100 + 200	0.25	0.5	100	9.600 222

3



1 Disposable Capillary pipettes, DURAN®, minicaps® end-to-end

Non-heparinized. Declaration of conformity acc. to DIN 12600, ISO 7550.

Hirschmann

Capacity µl	Length mm	Accuracy max. vol. (± R%)	Precision max. vol. (≤ CV%)	PK	Cat. No.
0.5	30 - 32	0.5	1.0	100	9.411 265
1	30 - 32	0.5	1.0	100	9.411 266
2	30 - 32	0.5	1.0	100	9.411 267
3	30 - 32	0.5	1.0	100	9.411 268
4	30 - 32	0.5	1.0	100	9.411 270
5	30 - 32	0.5	1.0	100	9.411 271
10	30 - 32	0.5	1.0	100	9.411 273
20	30 ± 0.5	0.5	1.0	100	9.411 274
25	30 - 32	0.5	1.0	100	9.411 275
30	30 - 32	0.5	1.0	100	9.411 276
40	30 ± 0.5	0.5	1.0	100	9.411 277
50	30 ± 0.5	0.5	1.0	100	9.411 279
100	100	0.5	1.0	100	9.411 280

1



2 Haematocrit capillary tubes

Disposable capillaries for blood centrifugation tests, length 75mm, with heavy wall thickness and color-coded acc. to DIN 12 772.

Hirschmann

Type	Capacity µl	Outer diam. mm	Int. diam. mm	PK	Cat. No.
Sodium-heparinized	60	1.3 ... 1.4	0.9 ... 1.0	1000	6.078 500
Sodium-heparinized	75	1.42 ... 1.68	1.07 ... 1.23	1000	7.200 409
Sodium-heparinized	100	1.5 ... 1.6	1.1 ... 1.2	1000	7.602 312
Plain	75	1.42 ... 1.68	1.07 ... 1.23	1000	6.200 639
Plain	60	1.3 ... 1.4	0.9 ... 1.0	1000	6.200 957

2



3 Micro-haematocrit capillary tubes

Comply with BS 4316-68 and DIN ISO 12 772 specifications. For use in microhaematocrit centrifuges. Without calibration marks.

BRAND

Heparinised: For capillary blood sampling. The entire inner surface is coated with sodium-heparinate. Code: red.

Non-heparinised: To determine heparinised venous blood. Code: blue.

Length: 75 mm ±0.5 mm
 Wall thickness: approx. 0.2 mm
 Internal diameter: 1.1 to 1.2 mm
 External diameter: 1.5 to 1.6 mm

Type	PK	Cat. No.
Heparinised	100	9.411 215
Non-heparinised	100	9.411 220

3



4 Micro capillaries

These disposable micro capillaries fill automatically from end to end. Their accuracy is better than 1%. A capillary tube holder is supplied with each pack. Also contains a small bulb with aperture which can be inserted into capillary and used as an effective support for filling and emptying tubes.

Capacity µl	PK	Cat. No.
0.5	100	9.020 192
1.0	100	9.020 193
2.0	100	9.020 194
5.0	100	9.020 195
10.0	100	9.020 196

4





1 Haematocrit sealing compound

Non-drying vinyl plastic compound on a plastic plate.
For rapid and safe sealing of micro-haematocrit capillaries.
24 capillaries can be placed upright in the numbered storage places on each side of the plate.
CE marked.

BRAND

Type	PK	Cat. No.
Haematocrit sealing compound	10	9.411 240



2 Micropipette controller



For disposable pipettes with micro ring mark and many other small glass pipettes up to 1ml.
Autoclavable (121 °C). The micropipette controller reduces risk of infection.
Contaminated disposable micropipettes can be removed using the integral ejection button.

BRAND

Type	PK	Cat. No.
Micropipette controller	1	9.288 200
Spare suction system	3	9.288 201



3 Pipette controllers, micro-classic



Comfortable and reliable. Thanks to its ergonomic design and easy handling, the micro-classic pipette controller provides the comfort needed for difficult work under the microscope. Suitable for disposable micropipettes with ring marks and other microlitre volume pipettes with a capacity up to 1ml. Suitable for left, or right-handed operation. The adapter and suction tube are autoclavable at 121 °C.

BRAND

Description	PK	Cat. No.
Micro-classic, complete, with 2 spare tubes	1	9.281 080
Spare adapter with suction tube	3	9.281 085



1 2 3 4 5 6 LLG single channel microliter pipettes



Available with fixed or adjustable volume.

Ergonomic shape for a very comfortable handling

The rounded shape and the unique soft grip of the LLG pipette ensures a safe and comfortable handling. A minimal effort is required for pipetting so that the risk of repetitive strain injuries (RSI) is reduced.

Maximum Precision and Accuracy

Thermal insulation of the internal components, using the innovative soft grip, improves the accuracy.

Universal Blow-out System

The two-step plunger operation allows reverse pipetting. This also facilitates last drop dispensing by soft plunger movements. High accuracy and precision are guaranteed.

Colour-coded push-button for quick operation

The colour code enables a quick choice of the right pipette depending of the volume to be pipetted (see corresponding column in the table below).

Easy Maintenance and Adjustment

The volume setting is easy and precise, using the push-button, even when wearing gloves. Maintenance and adjustment take only a few minutes with just one tool. (Included in delivery)

Contamination-free Pipetting

The pipette is fully autoclavable, ideal for applications where sterility is important.

Satisfaction Guaranteed

Each pipette is individually tested and calibrated twice, conforming to EN ISO 8655 and DIN 12600 Standards. A certificate is included.

Made in Germany, CE certified.

LLG single channel microliter pipettes, fix

Capacity µl	Accuracy max. vol. (± R%)	Precision max. vol. (≤ CV%)	Colour code	PK	Cat. No.
5	1.0	0.5	grey	1	9.277 515
10	1.0	0.5	grey	1	9.277 516
20	4.5	1.0	grey	1	9.277 517
25	2.5	0.6	yellow	1	9.277 518
50	2.5	0.6	yellow	1	9.277 519
250	2.9	0.6	blue	1	9.277 522
2500	2.4	0.6	violet	1	9.277 526



LLG single channel microliter pipettes, variable

Capacity µl	Increments µl	Accuracy max. vol. (± R%)	Precision max. vol. (≤ CV%)	Colour code	PK	Cat. No.
0.1 - 2.5	0.05	2.50	1.60	grey	1	9.280 000
0.5 - 10	0.1	1.00	0.80	grey	1	9.280 001
2 - 20	0.5	0.90	0.40	grey	1	9.280 002
10 - 100*	1.0	0.80	0.15	yellow	1	9.280 003
20 - 200	1.0	0.60	0.15	yellow	1	9.280 004
100 - 1000*	5.0	0.60	0.20	blue	1	9.280 005
500 - 5000*	50.0	0.50	0.15	purple	1	9.280 006
1000 - 10000**	100.0	0.60	0.20	turquoise	1	9.280 007

*Filters for pipettes available on request.

1 LLG-Digital single channel microliter pipettes, Packages, variable

Package 1 Micro contains:

- a) 3 Microlitre pipettes with the volumes
 - LLG-microlitre pipette 0.5 to 10µl
 - LLG-microlitre pipette 10 to 100µl
 - LLG-microlitre pipette 100 to 1000µl
- b) for each pipette one bag of tips
 - crystal (0.1 to 10µl) 1000 tips
 - yellow (10 to 100µl), 1000 tips
 - blue (100 to 1000µl), 1000 tips

Package 2 Macro contains:

- a) 3 Microliter pipettes with the volumes
 - LLG-microlitre pipette 100 to 1000µl
 - LLG-microlitre pipette 500 to 5000µl
 - LLG-microlitre pipette 1000 to 10000µl
- b) for each pipette one bag of tips
 - blue (100 to 1000µl), 1000 tips
 - clear (100 to 5000µl), 250 tips
 - clear (1000 to 10000µl), 100 tips

Package 1 Micro and 2 Macro are also available as packages with 4-place or 6-place pipette stand, made of PMMA.

Type	PK	Cat. No.
Package 1 Micro	1	9.280 008
Package 2 Macro	1	9.280 009
Package 1 Micro + 4-place-pipette stand	1	6.237 000
Package 1 Micro + 6-place-pipette stand	1	6.237 001
Package 2 Macro + 4-place-pipette stand	1	6.237 002
Package 2 Macro + 6-place-pipette stand	1	6.237 003

1



2



2 LLG-Pipette stands for single channel microliter pipettes, PMMA

White, stable plastic (PMMA), industrial grade. Pipettes are held in an ergonomic position for easy withdrawal and replacement. Adjustable heights. Suitable for all kind of pipettes.

Description	PK	Cat. No.
for 4 pipettes	1	9.280 014
for 6 pipettes	1	9.280 011

3

Pipette stand Universal for single and multi-channel microliter pipettes

- Holds up to 8 single-channel, 4 multi-channel, or a combination of both pipettes. *Heathrow Scientific*
- For all pipette brands
- Inserts on the upper holders can be added or removed to accommodate the fit of different pipette widths
- Weighted base allows for easy one-handed removal or replacement of pipettes
- Pipettes are held in a vertical position to help prevent contamination
- Assorted color options allow for color coding pipette location
- Dimensions (W x H): 229 x 408 mm



6.290 241

4



6.290 247

Colour	Lower Holder	Upper Holder	PK	Cat. No.
Assorted*/clear	8 x clear	8 x clear / 8 x assorted*	1	6.290 241 3
Purple/clear	8 x purple	8 x purple / 8 x clear	1	6.290 246
Blue/green	8 x blue	8 x blue / 8 x green	1	6.290 247 4

*purple, yellow, red, orange, green, grey, clear, blue

1 2 3 Single channel microliter pipettes LLG-proMLP



The LLG-proMLP single channel microliter pipettes combine high accuracy and reliability with ergonomic and extremely low force pipetting relieving stress from your hand and thumb. This high precision instrument has been built to maintain accuracy for many years making it the ideal choice for all scientific work requiring exact and reproducible pipetting. The LLG-proMLP pipettes are equipped with an adjustable eject button allowing right and left handed users to set the button*according to their preferences. The built in volume locking mechanism and competitive pricing complete these high quality precision pipettes. Available volume ranges from 0.2 µl to 10 ml.

- High quality **Made in France**
- High accuracy, reliability and reproducibility
- Extremely light weight while the robustness still remains
- Perfect ergonomics for highest comfort
- Colour-coded push-button for quick operation
- Extremely low pipetting forces
- **Built-in volume locking** for error-free results
- **Tip ejector button***, adjustable for right- and left-handed users
- Completely autoclavable at 121°C
- Including individual calibration certificate (according to EN ISO 8655)

*not available for 5 ml and 10 ml pipettes

Scope of supply: microliter pipette, calibration tool

Capacity µl	Increments µl	Accuracy max. vol. (± R%)	Precision max. vol. (≤ CV%)	Colour code	PK	Cat. No.
0.2-2	0.002	1.65	0.75	dark orange	1	6.270 420
0.5-10	0.02	1.10	0.44	red	1	6.270 421
2-20	0.02	1.00	0.33	light yellow	1	6.270 422
10-100	0.2	0.80	0.17	light orange	1	6.270 423
20-200	0.2	0.80	0.17	dark yellow	1	6.270 424
100-1000	2	0.80	0.17	dark blue	1	6.270 425
500-5000	2	0.66	0.18	purple	1	6.270 426
1000-10000	20	0.60	0.18	light blue	1	6.270 427

1



2



3



Accessories for Single channel microliter pipettes LLG-proMLP

Description	PK	Cat. No.
Filters for Single channel microliter pipettes LLG-proMLP 5K und 10K	10	6.288 219
Piston grease for Single channel microliter pipettes LLG-proMLP 5K und 10K	5	6.290 477

7 Pipette stands Flip & Grip™ for single and multi-channel microliter pipettes

Unique pipette holder that gives you the option of using on the bench top, or hanging under shelf holder to help maximize your working space available.

Heathrow Scientific

- Will hold up to 12 single channel pipette, or a combo of 3 single and 3 multichannel
- Holds most common brands. Rubber grips prevent scratching pipette
- Holder rotates for easy pipette selection and storage
- Weighted base. Fixing screw provided for under shelf option
- Dimensions (W x H): 193 x 332mm (bench top style); 193 x 187mm (under shelf style)

Colour	PK	Cat. No.
Blue	1	9.194 002 4
Lime	1	9.194 003 5
Magenta	1	9.194 004 6

4



9.194 002

5



9.194 003

6



9.194 004

7



Microliter pipettes, Transferpette® S



BRAND

The Transferpette® S is available with fixed or adjustable volume. Low operating forces and a short stroke ensure relaxed pipetting, even during long pipetting series.

- One-hand operation for right- and left-handed users
- Volume-change protection
- Easy Calibration technology: Calibration without tools
- Universal tip cone
- Completely autoclavable at 121 °C
- Color code on volume adjustment wheel, shaft and volume-change protection
- DE-M marking

1



1

Single channel microliter pipettes, Transferpette® S, fixed



BRAND

Volume range from 10 µl to 2000 µl.

Scope of supply: Transferpette® S type fixed volume, with performance certificate, shelf/rack mount, labeling foil, silicone grease

Capacity µl	Accuracy max. vol. (± R%)	Precision max. vol. (≤ CV%)	Tip µl	PK	Cat. No.
10	1,0	0,5	0,5 ... 20	1	9.280 150
20	0,8	0,4	2 ... 200	1	9.280 151
25	0,8	0,4	2 ... 200	1	9.280 152
50	0,8	0,4	2 ... 200	1	9.280 153
100	0,6	0,2	2 ... 200	1	9.280 154
200	0,6	0,2	2 ... 200	1	9.280 155
500	0,6	0,2	50 ... 1000	1	9.280 156
1000	0,6	0,2	50 ... 1000	1	9.280 157
2000	0,8	0,3	500 ... 5000	1	9.280 158

2



2

Single channel microliter pipettes, Transferpette® S, variable



BRAND

Volume range from 0.1 µl to 10000 µl.

Scope of supply: Transferpette® S type adjustable volume, with performance certificate, shelf/rack mount, labeling foil, silicone grease

Capacity µl	Accuracy max. vol. (± R%)	Precision max. vol. (≤ CV%)	Tip µl	PK	Cat. No.
0.1 ... 1	2	1.2	0.1 ... 20	1	9.280 140
0.1 ... 2.5	1.4	0.7	0.5 ... 20	1	9.280 141
0.5 ... 10	1.0	0.5	0.5 ... 20	1	9.280 142
2 ... 20	0.8	0.4	2 ... 200	1	9.280 143
5 ... 50	0.8	0.3	2 ... 200	1	9.280 144
10 ... 100	0.6	0.2	2 ... 200	1	9.280 145
20 ... 200	0.6	0.2	2 ... 200	1	9.280 146
100 ... 1000	0.6	0.2	50 ... 1000	1	9.280 147
500 ... 5000	0.6	0.2	500 ... 5000	1	9.280 148
1000 ... 10000	0.6	0.2	1000 ... 10000	1	9.280 149

1 Single channel pipettes Transferpette® S, variable, Starter-kits NEW

Starter kit micro: 3 x pipettes (0.1 - 2.5 µl, 0.5 - 10 µl, 10 - 100 µl), 3 x TipBox pipette tips (2 x 0.5 - 20 µl, 2 - 200 µl), 3 shelf mounts
Starter kit standard: 3 x pipettes (0.5 - 10 µl, 10 - 100 µl, 100 - 1000 µl), 3 x TipBox pipette tips (0.5 - 20 µl, 2 - 200 µl, 50 - 1000 µl), 3 shelf mounts
Starter kit midi: 3 x pipettes (2 - 20 µl, 20 - 200 µl, 100 - 1000 µl), 3 x TipBox pipette tips (2 x 2 - 200 µl, 50 - 1000 µl), 3 shelf mounts
Starter kit macro: 3 x pipettes (100 - 1000 µl, 500 - 5000 µl, 1000 - 10000 µl), 3 x TipBox pipette tips (50 - 1000 µl, 0.5 - 5 ml, 1 - 10 ml), 3 shelf mounts
Pipette package 1: 5 x pipettes (0.1 - 2.5 µl, 0.5 - 10 µl, 2 - 20 µl, 20 - 200 µl, 100 - 1000 µl), 3 x TipBox pipette tips (0.5 - 20 µl, 2 - 200 µl, 50 - 1000 µl), table stand for 6 pipettes
Pipette package 2: 5 x pipettes (0.5 - 10 µl, 10 - 100 µl, 20 - 200 µl, 100 - 1000 µl, 500 - 5000 µl), 4x TipBox pipette tips (0.5 - 20 µl, 2 - 200 µl, 50 - 1000 µl, 0.5 - 5 ml), table stand for 6 pipettes

BRAND



Type	PK	Cat. No.
Starter kit micro	1	9.280 160
Starter kit standard	1	9.280 163
Starter kit midi	1	9.280 161
Starter kit macro	1	9.280 162
Pipette package 1	1	9.280 164
Pipette package 2	1	9.280 165

2 Accessories for Single and Multichannel Microliter Pipettes Transferpette® S

BRAND

Description	PK	Cat. No.
Bench stand for 1 multi channel pipette	1	7.510 391
Bench stand for 6 single and multi channel pipettes	1	6.312 381
Filter for all Transferpette® S single channel pipettes 0.5-5 ml	25	6.230 119
Filter for Transferpette® S 1-10 ml pipettes	25	6.230 120
Wall mount for Transferpette® S, S-8, S-12	1	4.674 938



3 Single channel microliter pipettes, Transferpette® electronic, variable

BRAND

The optimal design, the arrangement of the operating keys and the adjustable finger rest allow the motorized Transferpette® electronic to be tailored to the shape of your hand.

- Motor-driven, to reduce the risk of RSI and imprecision/inaccuracy caused by operator variability
- Five operating modes: Pipetting mode, Reverse pipetting, Mixing, Dispensing, Gel-electrophoresis modes
- Easy Calibration function for rapid adjustment of the unit without tools
- Extremely fast pipetting speed
- NiMH rechargeable battery pack and battery regeneration-mode
- Optionally, the Transferpette® can also be charged via the 3-fold charging stand

Items supplied: Transferpette® electronic, DE-M marking, with performance certificate, battery, power supply, silicone grease.



Capacity	Increments	Tip	Accuracy max. vol.	Precision max. vol.	Connector	PK	Cat. No.	
µl	µl	µl	(± R%)	(≤ CV%)				
0.5 - 10	0.01	0.1 - 20, 0.5 - 20, 1 - 50, 0.1 - 1*, 0.5 - 10*, 1 - 20*	1.0	0.4	EU	1	9.280 113	
0.5 - 10	**	0.01	0.1 - 20, 0.5 - 20, 1 - 50, 0.1 - 1*, 0.5 - 10*, 1 - 20*	1.0	0.4	EU	1 9.280 115	
2 - 20	0.02	0.1 - 20, 0.5 - 20, 1 - 50, 0.5 - 10*, 1 - 20*	1.0	0.4	EU	1	9.280 100	
2 - 20	**	0.02	0.1 - 20, 0.5 - 20, 1 - 50, 0.5 - 10*, 1 - 20*	1.0	0.4	-	1	9.280 103
10 - 200	0.2	2 - 200, 5 - 300, 2 - 20*, 5 - 100*, 5 - 200*	0.8	0.2	EU	1	9.280 101	
10 - 200	**	0.2	2 - 200, 5 - 300, 2 - 20*, 5 - 100*, 5 - 200*	0.8	0.2	-	1	9.280 104
10 - 200	***	0.2	2 - 200, 5 - 300, 2 - 20*, 5 - 100*, 5 - 200*	0.8	0.2	-	1	6.241 958
50 - 1000	1.0	50 - 1000, 50 - 1000*	0.6	0.2	EU	1	9.280 102	
50 - 1000	**	1.0	50 - 1000, 50 - 1000*	0.6	0.2	-	1	9.280 105
50 - 1000	***	1.0	50 - 1000, 50 - 1000*	0.6	0.2	-	1	6.241 959
250 - 5000	5.0	500 - 5000	0.6	0.2	EU	1	9.280 114	
250 - 5000**	5.0	500 - 5000	0.6	0.2	-	1	9.280 116	
250 - 5000***	5.0	500 - 5000	0.6	0.2	-	1	6.241 960	

* Filter tips

**without a. c. adapter, please order with 3-device charging stand 9.280 106

***incl. DAKS calibration certificates

You can find suitable pipette stands online.

1



1

Multichannel microliter pipettes Transferpette® S-8/S-12, variable

NEW

BRAND

Transferpette® S -8/-12 pipettes are available in 5 different models and cover the volume range from 0.5 µl to 300 µl.

Scope of supply: Transferpette® S -8/-12, supplied with performance certificate, 2 x TipBox filled with pipette tips from BRAND, shelf mount, reagent reservoir, mounting tool, labeling foil, silicone grease and 1 set of sealing rings

Type	Capacity µl	Accuracy max. vol. (± R%)	Precision max. vol. (≤ CV%)	Tip max. vol. µl	PK	Cat. No.
S-8	0,5 ... 10	1,6	1,0	0,5 ... 20	1	9.280 170
S-8	5 ... 50	0,8	0,4	2 ... 200	1	9.280 171
S-8	10 ... 100	0,8	0,3	2 ... 200	1	9.280 172
S-8	20 ... 200	0,8	0,3	2 ... 200	1	9.280 173
S-8	30 ... 300	0,6	0,3	5 ... 300	1	9.280 174
S-12	0,5 ... 10	1,6	1,0	0,5 ... 20	1	9.280 175
S-12	5 ... 50	0,8	0,4	2 ... 200	1	9.280 176
S-12	10 ... 100	0,8	0,3	2 ... 200	1	9.280 177
S-12	20 ... 200	0,8	0,3	2 ... 200	1	9.280 178
S-12	30 ... 300	0,6	0,3	5 ... 300	1	9.280 179

2



2

Multichannel microliter pipettes Transferpette® -8/-12 electronic, variable

BRAND



The effortless ease of operation and its unique ergonomic shape make working with the Transferpette® -8/-12 piston-operated pipette so comfortable. The use of high-quality materials makes it exceptionally light in weight, while special FKM V-rings and the stepped shape of the ejector significantly reduces the ejection force needed. Your hand remains relaxed and loose, even during a prolonged pipetting operation.

- Individual shafts and seals can easily be replaced in the laboratory, for long instrument life
- Easy Calibration Technique: Calibration and adjustments are done in seconds without tools
- Autoclavable lower housing (121°C), freely rotatable over 360°
- Separate tip ejector: minimal tip ejection force needed
- Colored tip ejector caps indicate appropriate tips to use
- Corrosion resistant design
- CE-marked according to IVD-Directive 98/79 EC.

Items supplied: Transferpette® electronic 8 or 12 channel, DE-M marking, with performance certificate, battery, power supply, TipBox refill, 1 stand, 1 reagent reservoir, silicone grease, 1 extra set of sealing rings made of FKM and assembling aid

Channels	Capacity µl	Increments µl	Accuracy max. vol. (± R%)	Precision max. vol. (≤ CV%)	Tip max. vol. µl	Connector	PK	Cat. No.
8	0,5 - 10	0,01	1,2	0,8	0,1 - 20, 0,5 - 20, 0,1 - 1*, 0,5 - 10*, 1 - 50, 1 - 20*	EU	1	9.280 117
8	1 - 20	0,02	1,0	0,5	0,1 - 20, 0,5 - 20, 0,5 - 10*, 1 - 50, 1 - 20*	EU	1	9.280 107
8	5 - 100	0,1	0,8	0,25	2 - 200, 5 - 300, 2 - 20*, 5 - 100*, 5 - 200*	EU	1	9.280 108
8	10 - 200	0,2	0,8	0,25	2 - 200, 5 - 300, 2 - 20*, 5 - 100*, 5 - 200*	EU	1	9.280 118
8	15 - 300	0,5	0,6	0,25	2 - 200, 5 - 300, 5 - 100*, 5 - 200*	EU	1	9.280 109
12	0,5 - 10	0,01	1,2	0,8	0,1 - 20, 0,5 - 20, 0,1 - 1*, 0,5 - 10*, 1 - 50, 1 - 20*	EU	1	9.280 119
12	1 - 20	0,02	1,0	0,5	0,1 - 20, 0,5 - 20, 0,5 - 10*, 1 - 50, 1 - 20*	EU	1	9.280 110
12	5 - 100	0,1	0,8	0,25	2 - 200, 5 - 300, 2 - 20*, 5 - 100*, 5 - 200*	EU	1	9.280 111
12	10 - 200	0,2	0,8	0,25	2 - 200, 5 - 300, 2 - 20*, 5 - 100*, 5 - 200*	EU	1	9.280 128
12	15 - 300	0,5	0,6	0,25	2 - 200, 5 - 300, 5 - 100*, 5 - 200*	EU	1	9.280 112

* Filter tips

1 Single channel microliter pipettes Acura® manual 825/835



Available with fixed or adjustable volume. The latest Acura® manual pipette line was built with the same attention to detail that made the brand famous over several instrument generations. Introducing a smooth, modern design with easy volume reading. It also features a number of innovations enabling safe and easy, high performance pipetting.

- Effortless activation
- Smart and reliable volume adjustment
- Precision digital display visible at all times
- Justip™ adjustable tip ejector fitting most tips
- Swift-set user calibration system
- Shock, UV-light and autoclaving resistance
- Three-year warranty

1



Single channel microliter pipettes Acura® manual 835, fix

Socorex

Type	Capacity µl	Accuracy max. vol. (± R%)	Precision max. vol. (≤ CV%)	PK	Cat. No.
835	2000	0.8	0.5	1	6.235 043
835	2500	0.8	0.5	1	6.258 006
835	5000	0.7	0.3	1	6.205 429
835	10000	0.5	0.2	1	6.205 430

Single channel microliter pipettes Acura® manual 825/835, variable

Socorex

Type	Capacity µl	Increments µl	Accuracy max. vol. (± R%)	Precision max. vol. (≤ CV%)	PK	Cat. No.
825	0,1 - 2	0.002	2.0	1.5	1	9.411 590
825	0,5 - 10	0.01	1.0	0.5	1	9.411 591
825	1 - 10	0.01	1.0	0.7	1	9.411 592
825	2 - 20	0.02	1.0	0.5	1	9.411 593
825	5 - 50	0.1	1.0	0.4	1	9.411 594
825	10 - 100	0.1	0.8	0.2	1	9.411 595
825	20 - 200	0.2	0.6	0.2	1	9.411 596
825	100 - 1000	1	0.5	0.2	1	9.411 597
835	200 - 2000	0.002	0.5	0.2	1	6.230 186
835	500 - 5000	0.01	0.6	0.3	1	9.411 598
835	1000 - 10000	0.01	0.5	0.2	1	9.411 599

2 Single channel microliter pipettes Acura® manual 825/835 Triopack™, variable

2

Set with 3 pipettes. Nine different packs up to 10ml, each containing three adjustable micropipettes to cover all individual requirements in any research or routine application. Available at attractive saver prices.

Socorex



Type	Capacity µl	PK	Cat. No.
Acura 825 Triopack.C	0.1 - 2, 0.5 - 10, 5 - 50	3	9.411 620
Acura 825 Triopack.J	0.1 - 2, 2 - 20, 20 - 200	3	9.411 621
Acura 825 Triopack.M	1 - 10Y*, 5 - 50, 20 - 200	3	9.411 622
Acura 825 Triopack.O	0.5 - 10, 10 - 100, 100 - 1000	3	9.411 628
Acura 825 Triopack.P	1 - 10Y*, 10 - 100, 100 - 1000	3	9.411 623
Acura 825 Triopack.S	2 - 20, 20 - 200, 100 - 1000	3	9.411 624
Acura 825 Triopack.T	5 - 50, 20 - 200, 100 - 1000	3	9.411 625
Acura 825 Triopack.V	10 - 100, 100 - 1000, 500 - 5000	3	9.411 626
Acura 825 Triopack.Y	100 - 1000, 500 - 5000, 1000 - 10000	3	9.411 627

*10µl pipette for use with 200 µl tips

1

1 Single channel microliter pipettes, Calibra® digital 822/832

Socorex



- Instant, volume adjustment
- Unsurpassed performance and calibration stability
- Shock, heat, chemicals and UV light resistance
- Reliable user calibration
- Macro models accommodate interchangeable nozzle filters
- Autoclavable at 121°C/250°F
- Three-year warranty

Type	Capacity	Increments	Tip	Accuracy max. vol.	Precision max. vol.	PK	Cat. No.
	µl	µl	µl	(± R%)	(≤ CV%)		
822	20 - 200	1	200	0.6	0.2	1	9.411 478
822	100 - 1000	5	1000	0.5	0.2	1	9.411 479
832	200 - 2000	10	2000	0.5	0.2	1	9.411 480
832	1000 - 10000	100	10000	0.5	0.15	1	9.411 481

2

2 Accessories for Single Channel Microliter Pipettes Calibra® digital 832

Socorex

Description	PK	Cat. No.
Protection Filter for 2ml model	250	9.411 482
Glass Pasteur Pipette for 2ml model	250	9.411 731
Protection Filter for 10ml model	100	9.411 484

3

3 Microliter pipettes TwiXS Pack Acura® manual XS 826, variable

Socorex

Six different pipette packs up to 1.000 µl. For all individual requirements in any research application. Available at attractive saver prices.

Ready-to-use set includes:

- Two Acura® manual XS pipettes
- Shelf pipette holder for two pipettes
- Qualitix® samples
- QC certificate
- Operating instructions

Type	Capacity	Tip	PK	Cat. No.
	µl	µl		
Pack E	0,1 - 2 + 2 - 20	Ultra 10 - 200	2	9.411 650
Pack G	0,5 - 10 + 10 - 100	Ultra 10 - 200	2	9.411 651
Pack H	2 - 20 + 20 - 200	200 - 200	2	9.411 654
Pack K	5 - 50 + 20 - 200	200 - 200	2	9.411 652
Pack N	10 - 100 + 100 - 1000	200 - 1000	2	9.411 653
Pack Q	20 - 200 + 100 - 1000	200 - 1000	2	9.411 655

4

4 Dilution microliter pipette Acura® manual 810, fix

Socorex

This air displacement micropipette allows subsequent pipetting of 1 and 0.1mL of same liquid. The two pre-calibrated fixed volumes eliminate any setting. A universal metal nozzle accommodates straw tips (length 190mm, diameter 4 mm), most adequate to aspirate from deep, narrow vials or Stomacher bags. Ideal alternative to conventional graduated glass pipettes when performing serial 1:10 dilutions in bacteriology.

Volume	Increments	Accuracy max. vol.	Precision max. vol.	PK	Cat. No.
ml	µl	(± R%)	(≤ CV%)		
1/ 0.1	-	0.5	0.4	1	6.203 235

5

5 Straw tips, PP, for Dilution pipette Acura® manual 810

Socorex

Colourless Polypropylene straw tips with a diameter of 4mm are specially designed for easy reach deep into narrow vials and Stomacher bags. Their large diameter allows pick up of particle containing liquids. Qualitix® straw tips can be used directly in microbiological tests. They are supplied sterilized, in sealed bags.

Capacity	Length	PK	Cat. No.
ml	mm		
1.1	190	1000	6.210 059

1 Single channel microliter pipettes Acura® *electro* XS 926/936, variable

Microprocessor-controlled instrument line featuring intuitive software avoiding any complicated programming steps. No particular skills are required to get quick access to six working modes and many volumes to select from. Unsurpassed metrological performance and stability.

Socorex

Pipetting modes:

- Forward: aspiration and pipetting of set volume
- Reverse: aspiration in excess, followed by dosing of set volume
- Stepper: tip filling and step-by-step distribution
- Dilution: aspiration of 2 or 3 different volumes for restitution in one shot
- Tactile: "start-stop-start" slow liquid measurement, titration and gel loading
- Mixing: "Up and down" liquid flow

The Acura® *electro* features:

- Optimal ergonomics, light weight
- Easy, intuitive, self-teaching programme
- Large display, reversible right/left reading
- Swift-interchange battery pack
- Fast charge, long working autonomy
- Adjustable tip ejector fitting most tips
- Pipetting cycle counter
- Interchangeable volumetric modules
- Two years warranty

Supplied with: Electronic pipette with 4.8V battery, operating instructions and QC certificate, Qualitix® pipette tips samples, silicone grease



Type	Capacity	Increments	Tip	Accuracy max. vol.	Precision max. vol.	PK	Cat. No.
	µl	µl	µl	(± R%)	(≤ CV%)		
Acura® <i>electro</i> XS 926	0.1 - 2	0.01	Ultra 10	0.9	0.8	1	9.411 660
Acura® <i>electro</i> XS 926	0.5 - 10	0.05	Ultra 10	0.6	0.35	1	9.411 661
Acura® <i>electro</i> XS 926	0.5 - 10	0.05	200	0.6	0.4	1	9.411 662
Acura® <i>electro</i> XS 926	1 - 20	0.1	200	0.5	0.3	1	9.411 663
Acura® <i>electro</i> XS 926	2.5 - 50	0.25	200	0.5	0.25	1	9.411 664
Acura® <i>electro</i> XS 926	5 - 100	0.5	200	0.5	0.2	1	9.411 665
Acura® <i>electro</i> XS 926	10 - 200	1.0	200	0.4	0.15	1	9.411 666
Acura® <i>electro</i> XS 926	50 - 1000	5.0	1000	0.4	0.1	1	9.411 667
Acura® <i>electro</i> 936	100 - 2000	10	2000	0.5	0.15	1	9.411 680
Acura® <i>electro</i> 936	250 - 5000	50	5000	0.5	0.15	1	9.411 681
Acura® <i>electro</i> 936	500 - 10000	50	10000	0.5	0.15	1	9.411 682

We can supply this
manufacturer's
whole
product range !



1 Single channel microliter pipettes Initial package Acura® *electro* XS 926/electro 936, variable

Initial package is recommended when purchasing an Acura® *electro* for the first time. Each initial package contains one electronic pipette, QC certificate and operating instructions, charging stand, power supply, additional battery pack, Qualitix® pipette tips samples. Thereafter, additional pipettes can be purchased alone and charged on existing stand.

Socorex

Initial package supplied with:
 electronic pipette with 4.8V battery, additional battery pack, charging stand, power supply, operating instructions and QC certificate, Qualitix® pipette tips samples, silicone grease

Type	Capacity	Increments	Tip	Accuracy max. vol.	Precision max. vol.	PK	Cat. No.
	μl	μl	μl	(\pm R%)	(\leq CV%)		
Initial package Acura® <i>electro</i> XS 926	0.1 - 2	0.01	Ultra 10	0.9	0.8	1	9.411 668
Initial package Acura® <i>electro</i> XS 926	0.5 - 10	0.05	Ultra 10	0.6	0.35	1	9.411 669
Initial package Acura® <i>electro</i> XS 926	0.5 - 10	0.05	200	0.6	0.4	1	9.411 670
Initial package Acura® <i>electro</i> XS 926	1 - 20	0.1	200	0.5	0.3	1	9.411 671
Initial package Acura® <i>electro</i> XS 926	2.5 - 50	0.25	200	0.5	0.25	1	9.411 672
Initial package Acura® <i>electro</i> XS 926	5 - 100	0.5	200	0.5	0.2	1	9.411 673
Initial package Acura® <i>electro</i> XS 926	10 - 200	1.0	200	0.4	0.15	1	9.411 674
Initial package Acura® <i>electro</i> XS 926	50 - 1000	5.0	1000	0.4	0.1	1	9.411 675
Initial package Acura® <i>electro</i> 936	100 - 2000	10	2000	0.5	0.15	1	9.411 683
Initial package Acura® <i>electro</i> 936	250 - 5000	50	5000	0.5	0.15	1	9.411 684
Initial package Acura® <i>electro</i> 936	500 - 10000	50	10000	0.5	0.15	1	9.411 685

2 Multichannel microlitre pipettes Acura® *manual* 855, variable

Socorex



- 8- and 12-channel models up to 350 μl
- Light weight and perfect hand fitting
- Easy to handle
- Precision digital display visible at all times
- 360° rotation of volumetric module
- Adjustable tip ejector fitting most tips
- Integrated user calibration system
- Autoclavable at 121 °C/250 °F
- Three-year warranty

Capacity	Increments	Tip	Accuracy max. vol.	Precision max. vol.	Channels	PK	Cat. No.
μl	μl	μl	(\pm R%)	(\leq CV%)			
0.5 - 10	0.01	10	1.5	1.0	8	1	9.411 630
5 - 50	0.1	200	0.8	0.4	8	1	9.411 631
10 - 100	0.1	200	0.8	0.4	8	1	6.286 775
20 - 200	0.2	200	0.7	0.3	8	1	9.411 632
40 - 350	0.4	350	0.8	0.3	8	1	9.411 633
0.5 - 10	0.01	10	1.5	1.0	12	1	9.411 634
5 - 50	0.1	200	0.8	0.4	12	1	9.411 635
20 - 200	0.2	200	0.7	0.3	12	1	9.411 636
40 - 350	0.4	350	0.8	0.3	12	1	9.411 637

1



2



1 Multichannel microliter pipettes Acura® electro 956, variable

Microprocessor-controlled instrument line featuring intuitive software avoiding any complicated programming steps. No particular skills are required to get quick access to six working modes and many volumes to select from. Unsurpassed metrological performance and stability.

Socorex

Pipetting modes:

- Forward: aspiration and pipetting of set volume
- Reverse: aspiration in excess, followed by dosing of set volume
- Stepper: tip filling and step-by-step distribution
- Dilution: aspiration of 2 or 3 different volumes for restitution in one shot
- Tactile: "start-stop-start" slow liquid measurement, titration and gel loading
- Mixing: "Up and down" liquid flow

The Acura® electro features:

- Optimal ergonomics, light weight
- Easy, intuitive, self-teaching programme
- Large display, reversible right/left reading
- Swift-interchange battery pack
- Fast charge, long working autonomy
- Adjustable tip ejector fitting most tips
- Pipetting cycle counter
- Interchangeable volumetric modules
- Two years warranty

Supplied with: Electronic pipette with 4.8V battery, operating instructions and QC certificate, Qualitix® pipette tips samples, silicone grease



Capacity	Increments	Tip	Accuracy max. vol.	Precision max. vol.	Channels	PK	Cat. No.
µl	µl	µl	(± R%)	(≤ CV%)			
0.5 - 10	0.05	Ultra 10	1.0	0.7	8	1	9.411 690
2.5 - 50	0.25	200	0.8	0.4	8	1	9.411 691
10 - 200	1.0	200	0.6	0.25	8	1	9.411 692
20 - 350	5.0	350	0.6	0.25	8	1	9.411 693
0.5 - 10	0.05	Ultra 10	1.0	0.7	12	1	9.411 694
2.5 - 50	0.25	200	0.8	0.4	12	1	9.411 695
10 - 200	1.0	200	0.6	0.25	12	1	9.411 696
20 - 350	5.0	350	0.6	0.25	12	1	9.411 697

2 Shelf pipette holder for Single and Multi channel microliter pipettes, Type 332

Socorex



For two Acura® and Calibra® micro and/or multichannel pipettes.
Material: polycarbonate (PC). Maintenance: clean with mild detergent.
Not autoclavable.

Type	PK	Cat. No.
Shelf pipette holder 332	1	6.235 370



3 Pipette stands Twister™ universal 336 for single channel microliter pipettes

Socorex

Unique design 6-position pipette work station with great characteristics.
Model fits six pipettes of most brands providing for an ideal storage solution in any laboratory.
Rotation enables quick instrument selection. Easy disassembling for simple maintenance.
Available in seven translucent colours. Discs are exchangeable.

Colour	PK	Cat. No.
Sapphire blue	1	6.253 916
Emerald green	1	6.253 917
Topaz orange	1	6.253 918
Quartz grey	1	6.253 919
Ruby red	1	6.253 920
Diamond white	1	6.253 921
Citrine yellow	1	6.253 922



1



1 Pipette stand for Single and Multichannel microliter pipettes, for Calibra® and Acura® models

Innovative design fits all Calibra® and Acura® models. Easy reach of each instrument. Heavy base plate and anti-slip pads guarantee high stability. Polyamide construction.

Socorex

Description	PK	Cat. No.
Pipette stand 340 for 3 pipettes	1	9.411 505

2



2 Pipette stands for Single channel microliter pipettes, Type 337

- Holds up to 7 single-channel pipettes of most brands
- Available in 5 attractive colours
- Space-saving table-mounted models
- Polyacrylamide (PA) material is easy to clean

Socorex

Colour	PK	Cat. No.
Light grey	1	9.411 491
Pink	1	9.411 504
Ice blue	1	9.411 492
Mint green	1	9.411 493
Vanilla yellow	1	9.411 494

3

3 Microliter Pipette Tacta

Sartorius Lab Instruments



Tacta is a premium mechanical pipette available in volume range from 0.1 to 10 000 µl in single channel models, and from 0.5 to 300 µl in multichannel models.



- Low pipetting cycle forces reduce the risk of WRULD (Work Related Upper Limb Disorder)
- Ergonomic design for comfortable pipetting
- Optiload feature in both single and multichannel models for easy and light tip loading with perfect tip sealing
- Optiject soft tip ejection feature detaches the tip in a smooth, controlled manner
- Optilock's dual-function volume locking prevents accidental volume changes
- Easy-to-read, four-digit volume display helps to set exact volumes
- Color-coding of volumes to ease the selection of corresponding pipette tips
- Safe-Cone Filters available for models above 10 µl with convenient built-in filter ejection mechanism
- Fully autoclavable without disassembling
- Simple to clean and maintain with only three parts to disassemble
- Easy calibration adjustment with adjustment scale ensures accurate results, also in cases where factory calibration does not apply, for example when pipetting viscous liquids
- Materials have high chemical and UV-resistance to ensure a long life span for the pipette

4

4 Single channel pipette Tacta

Sartorius Lab Instruments



Capacity µl	Increments µl	Accuracy max. vol. (± R%)	Precision max. vol. (≤ CV%)	PK	Cat. No.
0.1 - 3	0.002	1.30	0.80	1	6.284 794
0.5 - 10	0.01	1.00	0.60	1	6.282 658
2 - 20	0.02	0.90	0.40	1	7.645 491
10 - 100	0.10	0.80	0.15	1	6.282 657
20 - 200	0.20	0.60	0.15	1	7.645 492
100 - 1000	1.00	0.70	0.20	1	6.282 656
500 - 5000	10.0	0.50	0.20	1	6.285 006
1000 - 10000	20.0	0.60	0.20	1	7.645 568

Single Channel Pipette Tacta, Multipacks

1

Three different multipacks:

Sartorius Lab Instruments

- Tacta® pipette 3-pack 20, incl. linear stand and Tacta® pipettes 2 - 20 µl, 20 - 200 µl, 100 - 1000 µl and Sartorius Optifit Tip tray Box
- Tacta® pipette 4-pack 20, incl. linear stand and Tacta® pipettes 0.5 - 10 µl, 2 - 20 µl, 20 - 200 µl, 100 - 1000 µl and Sartorius Optifit Tip tray Box
- Tacta® pipette 5-pack 20, incl. linear stand and Tacta® pipettes 2 - 20 µl, 10 - 100 µl, 20 - 200 µl, 100 - 1000 µl, 500 - 5000 µl and Sartorius Optifit Tip tray Box



6.310 494

Description	PK	Cat. No.
Tacta® Pipette 3-pack 20	1	6.310 494 1
Tacta® Pipette 4-pack 20	1	6.273 255
Tacta® Pipette 5-pack 20	1	7.982 708

2 Multichannel microliter pipette Tacta

2

Sartorius Lab Instruments

Channels	Capacity µl	Increments µl	Accuracy max. vol. (± R%)	Precision max. vol. (≤ CV%)	PK	Cat. No.
8	0.5-10	0.01	1.50	1.00	1	6.284 614
8	5-100	0.10	0.70	0.25	1	4.658 723
8	30-300	0.20	0.60	0.25	1	4.658 724
12	0.5-10	0.01	1.50	1.00	1	4.658 725
12	5-100	0.10	0.70	0.25	1	4.658 726
12	30-300	0.20	0.60	0.25	1	4.658 727

Suitable accessories can be found in our online shop.



3 Single channel pipette mLine®, mechanical, variabel

3

The mechanical pipettes of Sartorius are known for their ergonomic, user-friendly design and reliability. mLINE® pipettes represent an ergonomic choice for quality-conscious users who perform long lasting and repetitive manual pipetting. These pipettes are used in (bio)pharmaceutical laboratories, research institutes, universities, health care and industrial laboratories for various liquid handling tasks

Sartorius Lab Instruments

Capacity µl	Increments µl	Optifit Tips µl	Accuracy max. vol. (± R%)	Precision max. vol. (≤ CV%)	PK	Cat. No.
0.1 - 3	0.002	10	1.30	0.80	1	6.234 095
0.5 - 10	0.01	10	1.00	0.60	1	6.234 096
2 - 20	0.02	200	0.90	0.40	1	6.237 371
10 - 100	0.10	200, 350	0.80	0.15	1	6.228 993
20 - 200	0.20	200, 350	0.60	0.15	1	6.228 995
100 - 1000	1.00	1000	0.60	0.20	1	6.206 379
500 - 5000	10.0	5000	0.50	0.20	1	6.237 372
1000 - 10000	20.0	10000	0.60	0.20	1	6.239 043



Accessories for Picus and eLINE® electronic micropipettors

4

Sartorius Lab Instruments

Type	PK	Cat. No.
Charging stand for 1 pipette	1	6.254 913
Charging carousel for 4 pipettes	1	6.238 584 4
replacement battery eLINE®	1	6.240 793



6.238 584

1



1 Electronic Microliter pipettes Picus®/Picus® NxT

Sartorius Lab Instruments

Picus®/Picus® NxT are compact and lightweight pipettes. Fully electronic operation assures high accuracy and precision of results. Picus® NxT provides distinct advantages for highly regulated laboratories. Fully electronic liquid handling in the volume range of 0.2 µl to 10 ml.

- Highest level of ergonomics provided by low weight, light electronic tip ejection and comfortable handle design
- Extensive range of pipetting modes reduces the needed pipetting steps and speeds up work
- Electronic brake and piston control system provide outstanding accuracy and repeatability of pipetting results, independent of the user
- Intuitive user interface in four language options: English, French, German, Russian
- Adjustment wheel offers fast volume setting and menu navigation
- Optiload enables perfect tip sealing for accurate delivery from each channel
- Safe-Cone Filters prevent the risk of contamination cost-effectively
- Microwell plate tracker guides the user to pipette into the correct wells
- Calibration adjustment in 1, 2 or 3 points

Picus® NxT

- Certificate of accredited 3-point calibration (per ISO 17025 and ISO 8655)
- User programmable pipetting protocols enable the storage of three frequently needed pipetting workflows
- 2-level password protection for stored programs to prevent unauthorized changes (optional)
- Pipette locking, e.g. in case of contamination, increases lab safety by disabling the pipette from use.
- Service and calibration reminders help the users to remember important service dates.
- Repeated blow-out helps to dispense the last droplets of e.g. viscous liquids

2



2 Electronic single channel pipette Picus®/Picus® NxT

Sartorius Lab Instruments

Type	Capacity	Increments	Accuracy max. vol.	Precision max. vol.	Optifit Tips	PK	Cat. No.
	µl	µl	(± R%)	(≤ CV%)	µl		
Picus®	0.2-10	0.01	0.90	0.40	10	1	6.266 285
Picus®	5-120	0.10	0.40	0.15	200, 350	1	7.657 874
Picus®	10-300	0.20	0.40	0.15	350	1	7.657 739
Picus®	50-1000	1.00	0.40	0.15	1000	1	6.257 443
Picus®	100-5000	5.00	0.50	0.15	5000	1	6.261 420
Picus®	500-10000	10.00	0.60	0.20	10000	1	6.261 421
Picus® NxT	0.2-10	0.01	0.90	0.40	10	1	4.658 709
Picus® NxT	5-120	0.10	0.40	0.15	200, 350	1	4.658 710
Picus® NxT	10-300	0.20	0.40	0.15	350	1	4.658 711
Picus® NxT	50-1000	1.00	0.40	0.15	1000	1	4.658 712
Picus® NxT	100-5000	5.00	0.50	0.15	5000	1	4.658 713
Picus® NxT	500-10000	10.00	0.60	0.20	10000	1	4.658 714

3



3 Electronic multichannel microliter pipettes Picus®/Picus® NxT

Sartorius Lab Instruments

Type	Channels	Capacity	Increments	Accuracy max. vol.	Precision max. vol.	Optifit Tips	PK	Cat. No.
		µl	µl	(± R%)	(≤ CV%)	µl		
Picus®	8	0.2-10	0.01	0.90	0.50	10	1	6.284 894
Picus®	8	5-120	0.10	0.50	0.20	200, 350	1	7.910 253
Picus®	8	10-300	0.20	0.50	0.20	350	1	4.658 704
Picus®	8	50-1200	1.00	0.50	0.20	1200	1	4.652 483
Picus® NxT	8	0.2-10	0.01	0.90	0.50	10	1	4.658 715
Picus® NxT	8	5-120	0.10	0.50	0.20	200, 350	1	4.658 716
Picus® NxT	8	10-300	0.20	0.50	0.20	350	1	4.658 717
Picus® NxT	8	50-1200	1.00	0.50	0.20	1200	1	4.658 718
Picus®	12	0.2-10	0.01	0.90	0.50	10	1	4.658 705
Picus®	12	5-120	0.10	0.50	0.20	200, 350	1	4.658 706
Picus®	12	10-300	0.20	0.50	0.20	350	1	4.658 707
Picus®	12	50-1200	1.00	0.50	0.20	1200	1	4.658 708
Picus® NxT	12	0.2-10	0.01	0.90	0.50	10	1	4.658 719
Picus® NxT	12	5-120	0.10	0.50	0.20	200, 350	1	4.658 720
Picus® NxT	12	10-300	0.20	0.50	0.20	350	1	4.658 721
Picus® NxT	12	50-1200	1.00	0.50	0.20	1200	1	4.658 722

1 2 Single channel/Multichannel microliter pipettes F1-ClipTip™

Available with fixed or adjustable volume.

The innovative ClipTip™ interlocking technology ensures a complete seal with minimal tip attachment and ejection force. Achieve newfound confidence knowing that once attached, your tips are locked firmly in place, and will not loosen or fall off regardless of application pressure. The innovative three interlocking clip design ensures the tip is held securely on the F1-ClipTip™ pipette only until it is released.

- Tip is locked and sealed in place until ejected, no dropped tips that waste valuable samples
- Complete seal to secure the sample volume in the tip, enhanced accuracy and precision
- Tips are attached and ejected with a light touch, which eliminates the frustration of banging tips on the pipette
- Ergonomic design and Soft-touch tip ejection: Offering low attachment, ejection and plunger forces for safe and comfortable use
- Remarkably lightweight: Modern design protects user from the risk of Repetitive Strain Injuries (RSI)
- Adjustable comfort: The 120° adjustable finger rest for both right- and left-handed operator comfort, allows the hand to relax during pipetting cycles
- Super blow-out: 150% increase in air boost to ensure efficient delivery of micro-volumes and prevent capillary action (Available for models up to 50µl)
- Silent, effortless volume adjustment with over 50% lower forces compared to earlier models. Improved grip on the volume adjustment knob ensures precise adjustment.
- Secure volume lock prevents undesirable volume drift during operation.
- Industry-leading lifetime warranty: With convenient online registration
- Certifications: Manufactured according to ISO 9001, ISO 14001 and ISO 13485.
- "Snap and Seal" technology uses small incorporated protrusions inside the tip that snap on the tip fitting collar. The flexible plastic lip design seals the tip against the tip fitting.



Single channel microliter pipettes F1-ClipTip, variable

Thermo Scientific

Capacity µl	Increments µl	Accuracy max. vol. (± R%)	Precision max. vol. (≤ CV%)	Colour code	Tip	PK	Cat. No.
0.1 - 2 *	0.002	33.0	25.0	pink	ClipTip™ 12.5 Ext	1	4.665 072
1 - 10	0.02	2.5	2.0	pink	ClipTip™ 20	1	6.284 607
1 - 10 *	0.02	2.5	2.0	pink	ClipTip™ 12.5 Ext	1	4.665 073
2 - 20	0.02	3.0	2.5	pink	ClipTip™ 20	1	4.658 828
5 - 50	0.1	3.0	2.5	violet	ClipTip™ 50	1	4.658 829
10 - 100	0.2	3.0	1.0	yellow	ClipTip™ 200	1	4.658 830
20 - 200	0.2	1.8	0.7	yellow	ClipTip™ 200	1	4.658 831
30 - 300	1.0	1.5	0.6	orange	ClipTip™ 300	1	4.658 832
100 - 1000	1.0	1.0	0.6	blue	ClipTip™ 1000	1	4.658 833

* With "Snap and Seal" technology

Single channel microliter pipettes F1-ClipTip™, fix

Thermo Scientific

Capacity µl	Accuracy max. vol. (± R%)	Precision max. vol. (≤ CV%)	Tip	PK	Cat. No.
10	0.9	0.8	ClipTip™ 20	1	4.658 834
10	0.9*	0.8	ClipTip™ 12.5 Ext	1	4.665 074
20	0.7	0.5	ClipTip™ 20	1	4.658 835
25	0.6	0.5	ClipTip™ 50	1	4.658 836
50	0.6	0.4	ClipTip™ 50	1	4.658 837
100	0.4	0.3	ClipTip™ 200	1	4.658 838
200	0.4	0.3	ClipTip™ 200	1	4.658 839
250	0.4	0.3	ClipTip™ 300	1	4.658 840
500	0.3	0.3	ClipTip™ 1000	1	4.658 841
1000	0.3	0.3	ClipTip™ 1000	1	4.658 842

* With "Snap and Seal" technology

Multichannel microliter pipettes F1-ClipTip™, variable

Thermo Scientific

Capacity µl	Increments µl	Accuracy max. vol. (± R%)	Precision max. vol. (≤ CV%)	Channels	Colour code	Tip	PK	Cat. No.
1 - 10 *	0.02	12.0	8.0	8	pink	ClipTip™ 12.5 Ext	1	4.665 075
5 - 50	0.1	5.0	2.0	8	violet	ClipTip™ 50	1	4.658 844
10 - 100	0.2	5.0	2.0	8	yellow	ClipTip™ 200	1	4.658 845
30 - 300	1.0	5.0	2.0	8	orange	ClipTip™ 300	1	4.658 846
1 - 10 *	0.02	12.0	8.0	12	pink	ClipTip™ 12.5 Ext	1	4.665 076
5 - 50	0.1	5.0	2.0	12	violet	ClipTip™ 50	1	4.658 848
10 - 100	0.2	5.0	2.0	12	yellow	ClipTip™ 200	1	4.658 849
30 - 300	1.0	5.0	2.0	12	orange	ClipTip™ 300	1	4.658 850

* With "Snap and Seal" technology

Electronic single channel microliter pipettes E1-ClipTip™, variable

Thermo Scientific

Capacity	Increments	Accuracy max. vol. (± R%)	Precision max. vol. (≤ CV%)	Colour code	Tip	PK	Cat. No.
µl	µl						
0.5 - 12.5	0.01	1.0 - 4.0	0.4 - 4.0	Pink	ClipTip™ 12.5	1	9.282 694
2 - 125	0.1	0.6 - 2.4	0.2 - 0.8	Yellow	ClipTip™ 200	1	9.282 695
10 - 300	0.1	0.6 - 1.7	0.2 - 0.5	Orange	ClipTip™ 300	1	9.282 696
50 - 1250	1.0	0.5 - 2.4	0.1 - 0.5	Turquoise	ClipTip™ 1250	1	9.282 697

Electronic multichannel microliter pipettes E1-ClipTip™, variable

Thermo Scientific

Capacity	Increments	Accuracy max. vol. (± R%)	Precision max. vol. (≤ CV%)	Channels	Colour code	Tip	PK	Cat. No.
µl	µl							
0.5 - 12.5	0.01	2.5 - 12.0	1.6 - 12.0	8	Pink	ClipTip™ 12.5	1	9.282 698
2 - 125	0.1	2.0 - 8.0	0.6 - 4.0	8	Yellow	ClipTip™ 200	1	9.282 699
10 - 300	0.1	2.0 - 5.0	0.6 - 2.0	8	Orange	ClipTip™ 300	1	9.282 700
50 - 1250	1	1.4 - 4.0	0.6 - 1.5	8	Turquoise	ClipTip™ 1250	1	9.282 701
0.5 - 12.5	0.01	2.5 - 12.0	1.6 - 12.0	12	Pink	ClipTip™ 12.5	1	9.282 702
2 - 125	0.1	2.0 - 8.0	0.6 - 4.0	12	Yellow	ClipTip™ 200	1	9.282 703
10 - 300	0.1	2.0 - 5.0	0.6 - 2.0	12	Orange	ClipTip™ 300	1	9.282 704
30 - 850	1	1.5 - 4.7	0.6 - 2.0	12	Blue	ClipTip™ 1000	1	9.282 705
0.5 - 12.5	0.01	2.5 - 12.0	1.6 - 12.0	16	Pink	ClipTip™ 384 12.5	1	9.282 706
1 - 30	0.01	2.0 - 10.0	0.9 - 7.0	16	Violet	ClipTip™ 384 30	1	9.282 707
2 - 125	0.1	2.0 - 8.0	0.6 - 4.0	16	Yellow	ClipTip™ 384 125	1	9.282 708

1



1 Pipette Tips ClipTip™

Thermo Scientific ClipTip™ pipette tips provide security with a unique and innovative interlocking technology that ensures a complete seal on every channel with minimal tip attachment and ejection force. Achieve newfound confidence knowing that once attached, your tips are locked firmly in place, and will not loosen or fall off.

- Low retention: Special technology to enable maximum sample recovery
- Versatile Tip Range: Choose from five sizes: 20, 50, 200, 300 and 1000µL
- Immediate traceability
- Compliance: The F1-ClipTip™ pipetting system is CE-marked in accordance with IVD Directive in Europe.
- Certifications: Manufactured according to ISO 9001, ISO 14001, ISO 13485 and free of RNase, DNase, DNA, ATP and endotoxin contamination

Pipette Tips ClipTip™ 20 for 96

Length 4.6cm, volume range 1-20µl, colour code pink.

Thermo Scientific

Suitable for F1-ClipTip™ Cat. No. 9.282 631, 9.282 632, 9.282 638, 9.282 639, 9.282 640, 9.282 641, 9.282 651 and 9.282 655.

Description	Capacity	Package contents	PK	Cat. No.
	µl			
non sterile	1 - 20	10 racks of 96	960	9.282 661
sterile	1 - 20	10 racks of 96	960	9.282 662
non sterile	1 - 20	10 refill packs of 96	960	9.282 663
sterile	1 - 20	10 refill packs of 96	960	9.282 664
Filter tips, sterile	1 - 20	10 racks of 96	960	9.282 665
Filter tips, sterile	1 - 20	10 refill packs of 96	960	9.282 666

Pipette Tips ClipTip™ 200 for 96

Length 5.6cm, volume range 10-200µl, colour code yellow.

Thermo Scientific

Suitable for F1-ClipTip™ Cat. No. 9.282 634, 9.282 635, 9.282 644, 9.282 645, 9.282 653 and 9.282 657.

Description	Capacity	Package contents	PK	Cat. No.
	µl			
non sterile	10 - 200	10 racks of 96	960	9.282 673
sterile	10 - 200	10 racks of 96	960	9.282 674
non sterile	10 - 200	10 refill packs of 96	960	9.282 675
sterile	10 - 200	10 refill packs of 96	960	9.282 676
Filter tips, sterile	10 - 200	10 racks of 96	960	9.282 677
Filter tips, sterile	10 - 200	10 refill packs of 96	960	9.282 678

Pipette Tips ClipTip™ 300 for 96

Length 6.3cm/Extended Version 10.0 cm (with long, narrow tip, ideal for pipetting in narrow vessels), volume range 30-300µl, colour code orange.

Thermo Scientific

Suitable for F1-ClipTip™ Cat. No. 9.282 636, 9.282 646, 9.282 654 and 9.282 658.

Description	Capacity µl	Package contents	PK	Cat. No.
non sterile	30 ... 300	10 racks of 96	960	9.282 679
sterile	30 ... 300	10 racks of 96	960	9.282 680
non sterile	30 ... 300	10 inserts of 96	960	9.282 681
sterile	30 ... 300	10 inserts of 96	960	9.282 682
Filter tips, sterile	30 ... 300	10 racks of 96	960	9.282 683
Filter tips, sterile	30 ... 300	10 inserts of 96	960	9.282 684
Extended, non sterile	30 ... 300	10 racks of 96	768	4.672 131
Extended, sterile	30 ... 300	10 racks of 96	768	4.672 132
Extended, filter tips, sterile	30 ... 300	10 racks of 96	768	4.672 133
Extended, reload tower, non sterile	30 ... 300	10 inserts of 96	960	4.672 134

Pipette Tips ClipTip™ 1000 for 96

Length 9.5cm, volume range 100-1000µl, colour code blue.

Thermo Scientific

Suitable for F1-ClipTip™ Cat. No. 9.282 637, 9.282 647 and 9.282 648.

Description	Capacity µl	Package contents	PK	Cat. No.
non sterile	100 - 1000	8 racks of 96	768	9.282 685
sterile	100 - 1000	8 racks of 96	768	9.282 686
non sterile	100 - 1000	8 refill packs of 96	768	9.282 687
sterile	100 - 1000	8 refill packs of 96	768	9.282 688
Filter tips, sterile	100 - 1000	8 racks of 96	768	9.282 689
Filter tips, sterile	100 - 1000	8 refill packs of 96	768	9.282 690

Further models can be found in our online shop.

1 Single Channel Microliter Pipettes FinnpiPETTE™ Digital, variabel

The Thermo Scientific FinnpiPETTE Digital combines robust durability and consistent performance. The lightweight design and the finger rest reduce hand fatigue to make pipetting comfortable.

Thermo Scientific

- Completely autoclavable for use in sterile lab environments
- Durable and reliable
- Precise pipetting even with low volumes
- With the improved super blow-out system
- Clearly read selected volumes while securing plunger into place to avoid volume drift
- Release tips using minimal effort with the geared tip ejector



Capacity µl	Increments µl	Accuracy max. vol. (± R%)	Precision max. vol. (≤ CV%)	Colour code	Suitable FinnTip Tips	PK	Cat. No.
0.2 - 2*	0.01	2.5	2.0	Pink	Finntip 10, Flex 10, 20 micro, 50 micro	1	6.224 244
0.5 - 10*	0.1	1.0	0.5	Grey	Finntip 10, Flex 10, 20 micro, 50 micro	1	6.084 360
0.5 - 10	0.1	1.0	0.8	Grey	Finntip 300, Flex 200, 200 Ext, 250 Univ, Flex 300	1	6.083 925
2 - 20	0.1	1.0	0.4	Orange	Finntip 300, Flex 200, 200 Ext, 250 Univ, Flex 300	1	6.084 361
5 - 50	0.5	0.6	0.3	Orange	Finntip 300, Flex 200, 200 Ext, 250 Univ, Flex 300	1	9.283 752
10 - 100	1	0.8	0.2	Yellow	Finntip 300, Flex 200, 200 Ext, 250 Univ, Flex 300	1	6.056 307
20 - 200	1	0.6	0.2	Yellow	Finntip 300, Flex 200, 200 Ext, 250 Univ, Flex 300	1	9.283 753
100 - 1000	5	0.6	0.2	Blue	Finntip 1000, Flex 1000, 1000 Ext, Flex 1200	1	6.084 365
1000 - 5000	50	0.5	0.2	Green	Finntip 5 ml	1	9.283 755
2000 - 10000	100	0.5	0.2	Red	Finntip 10 ml, Flex 10 ml Ext	1	6.051 306

*Microtip

1

1 Single channel microliter pipettes Finn timer™ F1

The Thermo Scientific™ Finn timer™ F1 system delivers performance with precision, all in a lightweight design that maximizes user comfort and reduces strain. It's the ideal system for applications using expensive reagents and valuable samples. The Finn timer F1 now takes pipetting to a whole new level with significant new enhancements:

- Volume adjustment is virtually effortless and silent, also enabling one-handed volume changes for convenience.
- Textured adjustment knob provides a feel of confidence when setting volumes. Optional handle strips also enable a firmer grip.
- Lower pipetting forces now reduce Repetitive Stress Injury (RSI) even further without compromising results
- 120° adjustable finger rest - for both right- and left-handed operator comfort
- Soft touch tip ejection combined with the softer collar of Finntip Flex tips reduces ejection forces
- Super blow-out: 150% increase in air boost ensures efficient delivery of micro-volumes and prevents capillary action in 50 µL models and below
- Convenient Color-coding: Finn timers and Finntips are color-coded by volume to make it easy to select the right pipette and tips
- F1 Finn timer are certified to meet standards - ISO 9001, ISO 14001 and ISO 13485.
- 5-year warranty with online registration

Single channel microliter pipettes Finn timer™ F1, fix

Thermo Scientific

Capacity µl	Accuracy max. vol. (± R%)	Precision max. vol. (≤ CV%)	Suitable Finntip Tips	PK	Cat. No.
10	0.9	0.8	Finntip 250, Filter 10, Flex 200, Flex Filter 10, 200 Ext	1	4.658 801
25	0.6	0.5	Finntip 250, Filter 10, Flex 200, Flex Filter 10, 200 Ext	1	4.658 802
50	0.6	0.4	Finntip 250, Filter 10, Flex 200, Flex Filter 10, 200 Ext	1	4.658 803
100	0.4	0.3	Finntip 250, Filter 10, Flex 200, Flex Filter 10, 200 Ext	1	4.658 804
250	0.4	0.3	Finntip 1000, Filter 1000, Flex 1000, Flex Filter 1000, 1000 Ext, Filter 1000 Ext	1	4.658 805
500	0.3	0.3	Finntip 1000, Filter 1000, Flex 1000, Flex Filter 1000, 1000 Ext, Filter 1000 Ext	1	4.658 806
1000	0.3	0.3	Finntip 5 ml, Filter 5 ml	1	4.658 807
2000	0.3	0.2	Finntip 5 ml, Filter 5 ml	1	4.658 808
3000	0.3	0.2	Finntip 5 ml, Filter 5 ml	1	4.658 809
5000	0.3	0.2	Finntip 5 ml, Filter 5 ml	1	4.658 810
10000	0.3	0.2	Finntip 10 ml, Filter 10 ml, Flex 10 ml Ext	1	4.658 811
20	0.7	0.5	Finntip 250, Filter 10, Flex 200, Flex Filter 10, 200 Ext	1	4.658 812
200	0.4	0.3	Finntip 250, Filter 10, Flex 200, Flex Filter 10, 200 Ext	1	4.658 813

Single channel microliter pipettes Finn timer™ F1, variable

Thermo Scientific

Capacity µl	Increments µl	Accuracy max. vol. (± R%)	Precision max. vol. (≤ CV%)	Colour code	Suitable Finntip Tips	PK	Cat. No.
0.2 - 2*	0.002	12.0	2.0	pink	Finntip 10, Filter 10, Flex 10, Flex Filter 10	1	4.658 787
0.5 - 5*	0.01	6.0	1.0	pink	Finntip 10, Filter 10, Flex 10, Flex Filter 10	1	4.658 788
1 - 10*	0.02	2.5	0.5	pink	Finntip 10, Filter 10, Flex 10, Flex Filter 10	1	4.658 789
1 - 10	0.02	3.5	0.8	yellow	Finntip 250, Filter 10, Flex 200, Flex Filter 10, 200 Ext	1	4.658 790
2 - 20*	0.02	3.0	0.4	turquoise	Finntip 50, Filter 50	1	4.658 791
2 - 20	0.02	3.0	0.4	yellow	Finntip 250, Filter 20, Flex 200, Flex Filter 30, 200 Ext	1	4.658 792
5 - 50*	0.2	3.0	3.0	turquoise	Finntip 50, Filter 50	1	4.658 799
5 - 50	0.2	3.0	3.0	yellow	Flex 200, 250 Univ., 300, 200 Ext	1	4.658 800
10 - 100	0.2	3.0	0.2	yellow	Finntip 250, Filter 100, Flex 200, Flex Filter 100, 200 Ext, Filter 100 Ext	1	4.658 793
20 - 200	0.2	1.8	0.2	yellow	Finntip 250, Filter 200, Flex 200, Flex Filter 200, 200 Ext, Filter 200 Ext	1	4.658 794
30 - 300	1.0	1.5	0.2	orange	Finntip 300, Filter 300, Flex 300, Flex Filter 300	1	4.658 795
100 - 1000	1.0	1.0	0.2	blue	Finntip 1000, Filter 1000, Flex 1000, Flex Filter 1000, 1000 Ext, Filter 1000 Ext	1	4.658 796
500 - 5000	10.0	2.0	0.2	green	Finntip 5 ml, Filter 5 ml	1	4.658 797
1000 - 10000	20.0	2.0	0.2	red	Finntip 10 ml, Filter 10 ml, Flex 10 ml Ext	1	4.658 798

*Microtip

1 Single channel microliter pipettes FinnpiPETTE™ F2

1



Introducing the new Thermo Scientific FinnpiPETTE™ F2, a pipette that has all the right qualities. It has a light pipetting action, it is easy to use, and it is fully autoclavable. Furthermore, the FinnpiPETTE™ F2 offers outstanding reliability, which we guarantee with a 5 year warranty. Add to this great accuracy and precision, and you know the FinnpiPETTE™ F2 is a winner.

- Advanced Volume Gearing (AVG) mechanism - increased accuracy, precision and durability
- Light pipetting forces - improved ergonomics to minimise the risk of RSI
- Double-action pipetting button - prevents accidental volume alteration during pipetting
- Very large Ergovisio display - very big and clear display
- Both single channel and multichannel pipettes are fully autoclavable
- 5 year warranty



Single channel microliter pipettes FinnpiPETTE™ F2, fix

Thermo Scientific

Capacity µl	Accuracy max. vol. (± R%)	Precision max. vol. (≤ CV%)	Suitable Finntip Tips	PK	Cat. No.
1	4.0	4.0	Finntip 10, Filter 10, Flex 10, Flex Filter 10	1	9.282 450
5	1.4	1.4	Finntip 10, Filter 10, Flex 10, Flex Filter 10	1	9.282 451
10	0.9	0.8	Finntip 250, Filter 10, Flex 200, Flex Filter 10, 200 Ext	1	9.282 452
25	0.6	0.5	Finntip 250, Filter 10, Flex 200, Flex Filter 10, 200 Ext	1	9.282 453
20	0.6	0.5	Finntip 250, Filter 10, Flex 200, Flex Filter 10, 200 Ext	1	9.282 463
50	0.6	0.4	Finntip 250, Filter 10, Flex 200, Flex Filter 10, 200 Ext	1	9.282 454
100	0.4	0.3	Finntip 250, Filter 10, Flex 200, Flex Filter 10, 200 Ext	1	9.282 455
200	0.4	0.3	Finntip 250, Filter 10, Flex 200, Flex Filter 10, 200 Ext	1	9.282 464
250	0.4	0.3	Finntip 1000, Filter 1000, Flex 1000, Flex Filter 1000, 1000 Ext, Filter 1000 Ext	1	9.282 456
500	0.3	0.3	Finntip 1000, Filter 1000, Flex 1000, Flex Filter 1000, 1000 Ext, Filter 1000 Ext	1	9.282 457
1000	0.3	0.3	Finntip 5 ml, Filter 5 ml	1	9.282 458
2000	0.3	0.2	Finntip 5 ml, Filter 5 ml	1	9.282 459
3000	0.3	0.2	Finntip 5 ml, Filter 5 ml	1	9.282 460
5000	0.3	0.2	Finntip 5 ml, Filter 5 ml	1	9.282 461
10000	0.3	0.2	Finntip 10 ml, Filter 10 ml, Flex 10 ml Ext	1	9.282 462

Single channel microliter pipettes FinnpiPETTE™ F2, variable

Thermo Scientific

Capacity µl	Increments µl	Accuracy max. vol. (± R%)	Precision max. vol. (≤ CV%)	Colour code	Suitable Finntip Tips	PK	Cat. No.
0,2 - 2*	0.002	12.0	2.0	Pink	Finntip 10, Filter 10, Flex 10, Flex Filter 10	1	6.240 102
0,5 - 5*	0.01	6.0	1.0	Pink	Finntip 10, Filter 10, Flex 10, Flex Filter 10	1	6.233 742
1 - 10*	0.02	2.5	0.5	Pink	Finntip 10, Filter 10, Flex 10, Flex Filter 10	1	9.282 465
1 - 10	0.02	3.5	0.8	Yellow	Finntip 250, Filter 10, Flex 200, Flex Filter 10, 200 Ext	1	6.240 360
2 - 20*	0.02	3.0	0.4	Turquoise	Finntip 50, Filter 50	1	9.282 466
2 - 20	0.02	3.0	0.4	Yellow	Finntip 250, Filter 20, Flex 200, Flex Filter 30, 200 Ext	1	6.233 743
5 - 50*	0.1	0.3	0.3	Turquoise	Finntip 50, Filter 50	1	6.251 900
5 - 50	0.1	0.3	0.3	Yellow	Finntip 250, Filter 100, Flex 200, Flex Filter 100, 200 Ext, Filter 100 Ext	1	6.239 178
10 - 100	0.2	3.0	0.2	Yellow	Finntip 250, Filter 100, Flex 200, Flex Filter 100, 200 Ext, Filter 100 Ext	1	9.282 467
20 - 200	0.2	1.8	0.2	Yellow	Finntip 250, Filter 200, Flex 200, Flex Filter 200, 200 Ext, Filter 200 Ext	1	6.233 744
100 - 1000	1.0	1.0	0.2	Blue	Finntip 1000, Filter 1000, Flex 1000, Flex Filter 1000, 1000 Ext, Filter 1000 Ext	1	6.233 745
500 - 5000	10.0	2.0	0.2	Green	Finntip 5 ml, Filter 5 ml	1	6.238 106
1000 - 10000	20.0	2.0	0.2	Red	Finntip 10 ml, Filter 10 ml, Flex 10 ml Ext	1	6.239 136

*Microtip

1



1 Single channel microliter pipettes FinnpiPETTE™ F3

Ergonomic comfort, high accuracy and precision, reliability and easy maintenance in one of the lightest pipettes. With AVG - Advanced Volume Gearing - a self-supportive modular mechanism for light movement and smaller steps in volume adjustment.

Thermo Scientific

- Colour-coded for easy volume identification
- Large display with white digits on black background
- Built-in supporting finger rest to relax the hand and avoid RSI symptoms
- Dual-function pipetting knob with rotatable top prevents accidental volume alteration
- High-quality blow-out piston for volumes of 50 µl and below enables the safe dispensing of microdroplets
- Autoclavable (tip cone and tip ejector)

Single Chanel Microliter Pipettes FinnpiPETTE™ F3, variable

Thermo Scientific

Capacity µl	Accuracy max. vol. (± R%)	Precision max. vol. (≤ CV%)	Colour code	Suitable Finntip Tips	PK	Cat. No.
1 - 10*	2.5	2.0	pink	Finntip 10, Flex 10	1	4.665 771
1 - 10	3.5	3.0	yellow	Finntip 250 Universal, 200 Ext, Flex 300	1	7.920 376
2 - 20*	3.0	2.5	turquoise	Finntip 50	1	4.665 773
2 - 20	3.0	2.5	yellow	Finntip 250 Universal, 200 Ext, Flex 200	1	4.665 774
5 - 50*	3.0	2.5	turquoise	Finntip 50	1	4.665 775
5 - 50	3.0	2.5	yellow	Finntip 250 Universal, Flex 200	1	6.274 836
500 - 5000	2.0	0.8	green	Finntip 5 ml	1	6.266 423
10 - 100	3.0	1.0	yellow	Finntip 250 Universal, 200 Ext, Flex 300	1	6.265 747
20 - 200	3.0	1.5	yellow	Finntip 250 Universal, 200 Ext, Flex 200	1	6.255 795
100 - 1000	1.5	0.6	blue	Finntip 1000, Flex 1000	1	6.236 331
1000 - 10000	2.0	0.8	red	Finntip 10 ml, Flex 10 ml Ext	1	6.264 795

*Microtip

2



2 Pipette stand for single and multichannel microliter pipettes F1/F2

Provide safe and convenient storage for manual and electronic pipettes using.

Thermo Scientific

Description	PK	Cat. No.
With 6 slots	1	9.282 440

3



6.224 912

Pipette stands for Single channel microliter pipettes

3-, 4-, and 6-place pipette stands are designed to hold most major pipette brands.

Heathrow Scientific

4



6.236 495

Array	Material	Colour	PK	Cat. No.
3	Acrylic	Transparent	1	6.224 912 3
4	Acrylic	Transparent	1	6.242 001
6	Acrylic	Transparent	1	6.243 244
6	Acrylic	Blue, transparent	1	6.236 495 4
6	ABS	Blue	1	9.283 171

1 Electronic single channel microliter pipettes Finnpi[™] Novus, variable

1



Thermo Scientific

Thermo Scientific Finnpi[™] Novus Single Channel Electronic Pipettors offer performance with simple operation and reduced stress for comfortable, productive pipetting.

- Easy to use simple text guided user interface and operator button layout.
- Large display shows all the names of the functions without abbreviations.
- Ergonomic and lightweight design with balanced weight distribution enables longer work periods without fatigue.
- Finger rest is adjustable by 120 degrees to find the optimal pipetting position for both left hand and right hand users.
- Adjustable finger rest leaves your index finger free to control pipetting with minimum effort using the trigger action pipetting button.
- Light-touch tip ejector minimizes strain on your thumb with the very low tip ejection force and can be used with both right and left-hand.
- Finnpi[™] Novus has 10 different pipetting functions to cover most pipetting applications in the laboratory.
- 9 different speeds which can be separately adjusted for dispensing and aspirating, to optimize pipetting with different reagents.
- 9 built-in memory slots to store your own combination of the 10 different pipetting functions.
- Intuitive menu ensures easy access to pipetting functions for all laboratory pipetting applications.
- Light, long lasting battery allowing over 4000 pipetting actions.
- Fast recharge battery, fully recharged within 1 hour and the pipette is fully operational while recharging.
- Finnpi[™] Novus designed for easy in-lab calibration and service.
- The tip cone is fully autoclavable.
- Color coded buttons and color coded ring help identify the matching Finntip model.



Capacity µl	Increments µl	Accuracy max. vol. (± R%)	Precision max. vol. (≤ CV%)	Colour code	Suitable Finntip Tips	PK	Cat. No.
1 - 10*	0.01	3.5	3.0	pink	Finntip 10, Filter 10, Flex 10, Flex Filter 10	1	6.228 698
1 - 10	0.01	7.0	6.0	yellow	Finntip 250, Filter 10, Flex 200, Flex Filter 10, 200 Ext	1	9.282 480
5 - 50*	0.1	3.0	2.5	turquoise	Finntip 50, Filter 50	1	6.228 699
5 - 50	0.1	3.0	2.5	yellow	Finntip 250 Univ, Filter 100, Flex 200, Flex Filter 100, 200 Ext, Filter 100 Ext	1	6.228 700
10 - 100	0.1	3.0	1.0	yellow	Finntip 250 Univ, Filter 100, Flex 200, Flex Filter 100, 200 Ext, Filter 100 Ext	1	6.228 701
30 - 300	1.0	3.0	0.7	orange	Finntip 300, Filter 300, Flex 300, Flex Filter 300	1	6.228 702
100 - 1000	1.0	3.0	0.6	blue	Finntip 1000, Filter 1000, Flex 1000, Flex Filter 1000, 1000 Ext, Filter 1000 Ext	1	6.228 703
500 - 5000	10.0	3.0	0.8	green	Finntip 5 ml, Filter 5 ml	1	6.228 704
1000 - 10000	10.0	3.0	0.8	red	Finntip 10 ml, Filter 10 ml, Flex 10 ml Ext	1	6.228 705

*Microtip

We can **supply** this
manufacturer's
whole
product range !



1 Multichannel microliter pipettes FinnpiPETTE™ F1, variable

FinnpiPETTE™ F1 multichannel pipettes are available in 8-, 12- and 16-channel models with a wide selection of volume ranges. As with the single channel FinnpiPETTE™ F1 pipettes, the AVG mechanism ensures a high level of accuracy and precision. The soft-touch tip ejection is especially useful on multichannel models, significantly reducing the effort needed to eject multiple tips. In addition, in the low volume models the super blow-out function ensures accurate dispensing for even the lowest volumes.

Thermo Scientific

Capacity µl	Increments µl	Accuracy max. vol. (± R%)	Precision max. vol. (≤ CV%)	Channels	Colour code	Suitable Finntip Tips	PK	Cat. No.
1 - 10	0,02	12,0	8,0	8	pink	Finntip 10, Filter 10, Flex 10, Flex Filter 10	1	4.658 814
5 - 50	0,1	5,0	2,0	8	yellow	Finntip 250, Filter 100, Flex 200, Flex Filter 100, 200 Ext, Filter 100 Ext	1	4.658 815
10 - 100	0,2	5,0	2,0	8	yellow	Finntip 250, Filter 100, Flex 200, Flex Filter 100, 200 Ext, Filter 100 Ext	1	4.658 816
30 - 300	1,0	5,0	2,0	8	orange	Finntip 300, Filter 300, Flex 300, Flex Filter 300	1	4.658 817
1 - 10	0,02	12,0	8,0	12	pink	Finntip 10, Filter 10, Flex 10, Flex Filter 10	1	4.658 818
5 - 50	0,1	5,0	2,0	12	yellow	Finntip 250, Filter 100, Flex 200, Flex Filter 100, 200 Ext, Filter 100 Ext	1	4.658 819
10 - 100	0,2	5,0	2,0	12	yellow	Finntip 250, Filter 100, Flex 200, Flex Filter 100, 200 Ext, Filter 100 Ext	1	4.658 820
30 - 300	1,0	5,0	2,0	12	orange	Finntip 300, Filter 300, Flex 300, Flex Filter 300	1	4.658 821
1 - 10	0,02	12,0	8,0	16	violet	Finntip 20, Filter 20	1	4.658 822
5 - 50	0,1	5,0	2,0	16	turquoise	Finntip 50, Filter 50	1	4.658 823

2 Multichannel microliter pipettes FinnpiPETTE™ F2, variable

The FinnpiPETTE™ F2 multichannel pipettes are available in 8-, 12- and 16-channel models with a selection of volume ranges. As with the single channel FinnpiPETTE™ F2 pipettes, the AVG mechanism ensures a high level of accuracy and precision. In addition, in the low volume models the super blow-out function ensures accurate dispensing for even the lowest volumes.

Thermo Scientific

Capacity µl	Increments µl	Accuracy max. vol. (± R%)	Precision max. vol. (≤ CV%)	Channels	Colour code	Suitable Finntip Tips	PK	Cat. No.
1 - 10	0.02	0.24	8.0	8	pink	Finntip 10, Filter 10, Flex 10, Flex Filter 10	1	9.282 470
5 - 50	0.1	0.75	2.0	8	yellow	Finntip 250, Filter 100, Flex 200, Flex Filter 100, 200 Ext, Filter 100 Ext	1	9.282 471
10 - 100	0.2	1.3	2.0	8	yellow	Finntip 250, Filter 100, Flex 200, Flex Filter 100, 200 Ext, Filter 100 Ext	1	9.282 472
30 - 300	1.0	3.0	2.0	8	orange	Finntip 300, Filter 300, Flex 300, Flex Filter 300	1	9.282 473
1 - 10	0.02	0.24	8.0	12	pink	Finntip 10, Filter 10, Flex 10, Flex Filter 10	1	9.282 474
5 - 50	0.1	0.75	2.0	12	yellow	Finntip 250, Filter 100, Flex 200, Flex Filter 100, 200 Ext, Filter 100 Ext	1	9.282 475
10 - 100	0.2	1.3	2.0	12	yellow	Finntip 250, Filter 100, Flex 200, Flex Filter 100, 200 Ext, Filter 100 Ext	1	9.282 476
30 - 300	1.0	3.0	2.0	12	orange	Finntip 300, Filter 300, Flex 300, Flex Filter 300	1	9.282 477
1 - 10	0.02	0.24	8.0	16	violet	Finntip 20, Filter 20	1	9.282 478
5 - 50	0.1	0.75	2.0	16	turquoise	Finntip 50, Filter 50	1	9.282 479

1



2



1 Electronic multichannel microliter pipettes FinnpiPETTE™ Novus, variable



Thermo Scientific

Thermo Scientific FinnpiPETTE™ Novus Multichannel Pipettors offer superior performance for microplate applications.

- Easy to use simple text guided user interface and operator button layout.
- Large display shows all the names of the functions without abbreviations.
- Features multi-language programming: English, French, German, Italian, Japanese, Spanish, and Swedish.
- Ergonomic and lightweight design with balanced weight distribution enables longer work periods without fatigue.
- Finger rest is adjustable by 120 degrees to find the optimal pipetting position for both left hand and right hand users.
- Adjustable finger rest leaves your index finger free to control pipetting with minimum effort using the trigger action pipetting button.
- Light-touch tip ejector minimizes strain on your thumb with the very low tip ejection force and can be used with both right and left-hand.
- FinnpiPETTE™ Novus has 10 different pipetting functions to cover most pipetting applications in the laboratory.
- 9 different speeds which can be separately adjusted for dispensing and aspirating, to optimize pipetting with different reagents.
- 9 built-in memory slots to store your own combinations of the 10 different pipetting functions.
- Intuitive menu ensures easy access to pipetting functions for all laboratory pipetting applications.
- Light, long lasting battery allowing over 4000 pipetting actions.
- Fast recharge battery, can be fully recharged within 1 hour and the pipette is fully operational while recharging.
- FinnpiPETTE™ Novus designed for easy in-lab calibration and service.
- The module is fully autoclavable.
- Color coded buttons to help identify the matching Finntip model.
- Wide range of multichannel models for demanding laboratory tasks.
- Lightweight handle and module has a balanced weight distribution preventing muscle stress and strain.

1



Capacity µl	Increments µl	Accuracy max. vol. (± R%)	Precision max. vol. (≤ CV%)	Channels	Colour code	Suitable Finntip Tips	PK	Cat. No.
1 - 10	0.01	12.0	8.0	8	pink	Finntip 10, Filter 10, Flex 10, Flex Filter 10	1	6.228 706
5 - 50	0.1	5.0	2.0	8	yellow	Finntip 250, Filter 100, Flex 200, Flex Filter 100, 200 Ext, Filter 100 Ext	1	6.228 707
30 - 300	1.0	3.0	0.9	8	orange	Finntip 300, Filter 300, Flex 300, Flex Filter 300	1	6.228 708
100 - 1200	1.0	3.0	0.9	8	turquoise	Flex 1200, Flex Filter 1200	1	6.228 709
1 - 10	0.01	12.0	8.0	12	pink	Finntip 10, Filter 10, Flex 10, Flex Filter 10	1	9.282 481
5 - 50	0.1	5.0	2.0	12	yellow	Finntip 250, Filter 100, Flex 200, Flex Filter 100, 200 Ext, Filter 100 Ext	1	9.282 482
30 - 300	1.0	3.0	1.0	12	orange	Finntip 300, Filter 300, Flex 300, Flex Filter 300	1	9.282 483
5 - 50	0.1	5.0	2.0	16	turquoise	Finntip 50, Filter 50	1	9.282 484

2 Electronic multichannel microliter pipettes E1-ClipTip™ Equalizer, variable

Perform sample transfers between virtually any tube, rack, microplate or horizontal gel box quickly and efficiently with the Thermo Scientific™ E1-ClipTip™ Equalizer Pipette.

Thermo Scientific

Adjustable tip spacing allows you to set the distance between tips by simply sliding the scale to expand or contract to the desired labware format. Feel the difference.

An ideal choice for sample transfers: Reduce repetition and save time between labware formats with adjustable tip spacing in Equalizer models.

2



Capacity µl	Increments µl	Accuracy max. vol. (± R%)	Precision max. vol. (≤ CV%)	Channels	Colour code	Tip	Adjustable Tip spacing mm	PK	Cat. No.
50 - 1250	1	1.4 - 4.0	0.6 - 1.5	6	Turquoise	ClipTip™ 1250	9.0 - 19.8	1	9.282 709
2 - 125	0.1	2.0 - 8.0	0.6 - 4.0	8	Yellow	ClipTip™ 200	9.0 - 14.2	1	9.282 710
10 - 300	0.1	2.0 - 5.0	0.6 - 2.0	8	Orange	ClipTip™ 300	9.0 - 14.2	1	9.282 711
50 - 1250	1	1.4 - 4.0	0.6 - 1.5	8	Turquoise	ClipTip™ 1250	9.0 - 14.2	1	9.282 712
0.5 - 12.5	0.01	2.5 - 12.0	1.6 - 12.0	8	Pink	ClipTip™ 384 12.5	4.5 - 14.2	1	9.282 713
1 - 30	0.01	2.0 - 10.0	0.9 - 7.0	8	Violet	ClipTip™ 384 30	4.5 - 14.2	1	9.282 714
2 - 125	0.1	2.0 - 8.0	0.6 - 4.0	8	Yellow	ClipTip™ 384 125	4.5 - 14.2	1	9.282 715
0.5 - 12.5	0.01	2.5 - 12.0	1.6 - 12.0	12	Pink	ClipTip™ 384 12.5	4.5 - 9.0	1	9.282 716
1 - 30	0.01	2.0 - 10.0	0.9 - 7.0	12	Violet	ClipTip™ 384 30	4.5 - 9.0	1	9.282 717
2 - 125	0.1	2.0 - 8.0	0.6 - 4.0	12	Yellow	ClipTip™ 384 125	4.5 - 9.0	1	9.282 718

Further models can be found in our online shop.

Single channel microliter pipettes Eppendorf Research® plus (General Lab Product)



Eppendorf AG

Available with fixed or adjustable volume. The ultra light Eppendorf Research plus pipettor meets the highest requirements in precision and accuracy.

Ergonomic:

- Color-coded control buttons for volume detection
- Four-digit volume display with magnifying display
- Just a few turns to set the desired volume
- Very low operating forces (control knob, ejector)
- Spring-loaded tip cone for optimum tip fit with minimal attachment force

Flexible:

- Selection between single-channel, multi-channel and fixed volume pipettes in different sizes
- Adjustment possibilities for liquids of different density than water

Robust:

- High resistance to chemicals and mechanical stress
- Fully autoclavable

This pipette is a General Lab Product for research purposes.

Online also available as IVD version.

1

1 Single channel microliter pipettes Eppendorf Research® plus (General Lab Product), fix

- Eppendorf PerfectPiston™: ultra-light piston made of Fortron® (except 10µl pipettors)
- quick connection clip: remove lower housing easily

Eppendorf AG

Capacity µl	Increments µl	Accuracy max. vol. (± R%)	Precision max. vol. (≤ CV%)	Colour code	PK	Cat. No.
10	-	1.2	0.6	mid grey	1	4.661 842
10	-	1.2	0.3	yellow	1	4.661 843
20	-	0.8	0.6	light grey	1	4.661 844
20	-	1.0	0.3	yellow	1	4.661 845
25	-	1.0	0.3	yellow	1	4.661 846
50	-	0.7	0.3	yellow	1	4.661 847
100	-	0.6	0.2	yellow	1	4.661 848
200	-	0.6	0.2	yellow	1	4.661 849
200	-	0.6	0.2	blue	1	4.661 850
250	-	0.6	0.2	blue	1	4.661 851
500	-	0.6	0.2	blue	1	4.661 852
1000	-	0.6	0.2	blue	1	4.661 853

2

2 Single channel microliter pipettes Eppendorf Research® plus (General Lab Product), variable



Eppendorf AG

- Manual pipetting with lateral tip ejector for the volume range from 0.1 µl up to 10 ml
- Low weight, low operating forces (PhysioCare concept)
- 4-digit volume display
- Adjustment opening for reversible readjustment of the pipette when using non-aqueous solutions
- Completely autoclavable

Capacity µl	Increments µl	Accuracy max. vol. (± R%)	Precision max. vol. (≤ CV%)	Colour code	PK	Cat. No.
0.1 - 2.5	0.002	1.4	0.7	dark grey	1	6.291 700
0.5 - 10	0.01	1.0	0.4	mid grey	1	6.310 668
2 - 20	0.02	1.0	0.3	yellow	1	6.291 701
2 - 20	0.02	1.0	0.2	light grey	1	6.291 704
10 - 100	0.01	0.8	0.2	yellow	1	6.291 702
20 - 200	0.02	0.6	0.2	yellow	1	6.291 703
30 - 300	0.02	0.6	0.2	orange	1	6.291 705
100 - 1000	1.0	0.6	0.2	blue	1	7.648 488
500 - 5000	2.0	0.6	0.15	purple	1	6.290 013
1000 - 10000	10.0	0.6	0.15	turquoise	1	7.649 105

1 Single channel microliter pipettes Eppendorf Research plus 3-Packs (General Lab Product), variable

3 adjustable Eppendorf Research® plus pipettes per pack, choice of 3 packs. Special "mL" large-volume pack with up to 10ml nominal volume, ideal for pipetting cell culture media. Ready-to-use: delivered with matching Eppendorf pipette tips for ultimate user comfort and precision!

Eppendorf AG



- Option 1:** 0.5-10µl, 10-100µl, 100-1.000µl + 3 reusable epT.I.P.S.® boxes with 96 pipette tips each.
- Option 2:** 2-20µl, 20-200µl, 100-1.000µl + 3 reusable epT.I.P.S.® boxes with 96 pipette tips each.
- Option 3:** 100-1.000µl, 0.5-5ml, 1-10ml with samples of matching pipette tips.

Type	PK	Cat. No.
Research® plus 3-Packs, Option 1	3	6.291 172
Research® plus 3-Packs, Option 2	3	6.310 667
Research® plus 3-Packs, Option 3	3	6.291 706

Single channel microliter pipettes Eppendorf Reference® 2 (General Lab Product)



The Reference® 2 is the successor to the highly successful Reference pipette, and enhances the range's already high standards with a new design, reduced weight and operating forces and multi-channel versions. As the premium product in Eppendorf's pipette portfolio, the Reference® 2 provides the most accurate results possible alongside robust, reliable handling and optimum user safety.

New features: An embedded RFID chip contains all relevant data regarding the pipette and offers with Eppendorf TrackIT a simple identification and documentation. The range of the variable single channel pipettes have been extended by the volume sizes up to 5000µl and 10.000µl.

- Color coded and volume labeled for quick identification of the volume size/ tip size
- Round upper part makes it possible to work in every position
- 4-digit display for exact volume setting (clearly visible from every angle)
- Quick and secure volume setting, include volume lock
- Fully autoclavable
- Movable parts and external edges made from stainless steel equip the pipette with outstanding robustness at potential impact sites and for internal components

This pipette is a General Lab Product for research purposes.

Online also available as IVD version.

2 Single channel microliter pipettes Reference® 2 (General Lab Product), fix

Eppendorf AG



Capacity	Increments	Accuracy max. vol.	Precision max. vol.	Control button	PK	Cat. No.
µl	µl	(± R%)	(≤ CV%)	colour		
1	-	2,5	1,8	dark grey	1	4.662 393
2	-	2,0	1,2	dark grey	1	4.662 394
5	-	1,5	0,8	mid grey	1	4.662 395
10	-	1,0	0,5	mid grey	1	4.662 396
10	-	1,0	0,5	yellow	1	4.662 397
20	-	0,8	0,3	light grey	1	4.662 398
20	-	0,8	0,3	yellow	1	4.662 399
25	-	0,8	0,3	yellow	1	4.662 400
50	-	0,7	0,3	yellow	1	4.662 401
100	-	0,6	0,2	yellow	1	4.662 402
200	-	0,6	0,2	yellow	1	4.662 403
200	-	0,6	0,2	blue	1	4.662 404
250	-	0,6	0,2	blue	1	4.662 405
500	-	0,6	0,2	blue	1	4.662 406
1000	-	0,6	0,2	blue	1	4.661 941
2000	-	0,6	0,2	red	1	4.662 407
2500	-	0,6	0,15	red	1	4.662 408



1 Single channel microliter pipettes Eppendorf Reference® 2 (General Lab Product), variable

Eppendorf AG

Capacity	Increments	Accuracy max. vol.	Precision max. vol.	Control button	PK	Cat. No.
μl	μl	(\pm R%)	(\leq CV%)	colour		
0.1 - 2.5	0.002	1.4	0.7	dark grey *	1	4.662 385
0.5 - 10	0.01	1.0	0.4	medium grey	1	6.273 363
0.5 - 10	0.01	1.0	0.4	medium grey *	1	4.662 386
2 - 20	0.02	1.0	0.3	light grey *	1	6.272 839
2 - 20	0.02	1.0	0.3	yellow *	1	6.290 331
10 - 100	0.1	0.8	0.2	yellow *	1	6.272 840
20 - 200	0.2	0.6	0.2	yellow	1	6.273 365
20 - 200	0.2	0.6	0.2	yellow *	1	4.662 387
30 - 300	0.2	0.6	0.2	orange *	1	4.662 388
100 - 1000	1.0	0.6	0.2	blue *	1	6.272 841
250 - 2500	2.0	0.6	0.2	red **	1	7.648 598
500 - 5000	5.0	0.6	0.15	violet **	1	4.662 389
1000 - 10000	10.0	0.6	0.15	turquoise **	1	4.662 234

* incl. epT.I.P.S.® Box

***incl. epT.I.P.S.® Sample bag

2 Single channel microliter pipettes epReference® 2 (General Lab Product), 3-Pack

Economic package containing three variable single channel pipettes and suitable tips for each pipette.

Eppendorf AG

Option 1: 0.5-10 μl , 10-100 μl , 100-1000 μl + 3 reusable epT.I.P.S.® boxes with 96 pipette tips each.

Option 2: 2-20 μl , 20-200 μl , 100-1000 μl + 3 reusable epT.I.P.S.® boxes with 96 pipette tips each.

Option 3: 100-1000 μl , 0.5-5ml, 1-10ml with musters of the fitting pipette tips.

Type	PK	Cat. No.
Option 1: 0.5-10 μl , 10-100 μl , 100-1000 μl	1	4.662 390
Option 2: 2-20 μl , 20-200 μl , 100-1000 μl	1	4.662 391
Option 3: 100-1000 μl , 0.5-5ml, 1-10ml	1	4.662 392



3 4 Electronic single channel microliter pipettes Eppendorf Xplorer®, variable

The new electronic pipette Eppendorf Xplorer® sets new standards in terms of simplicity, precision and reproducibility.

Eppendorf AG

- Multifunctional rocker: "Up is up and down is down"™ principle
- Easy selection of all functions with the practical selection dial
- Operate in the language of your choice
- Clearly arranged colour display
- No sub-menus
- Help function
- Innovative rocker: When the tip is ejected, the piston automatically returns to zero position
- Tips always rest in the same position
- Volume & speed precisely and reproducibly adjustable
- Adjustable to your work environment and requirements
- Incl. 230V/50Hz charging adapter. The pipette can be charged directly with the charging adapter. Additionally the charging adapter can also be used with the optional charging stand (Cat. No. 9.283 254) which holds the pipette safely whilst charging.

Capacity	Increments	Accuracy max. vol.	Precision max. vol.	Control button	PK	Cat. No.
μl	μl	(\pm R%)	(\leq CV%)	colour		
0.5 - 10	0.01	1.0	0.4	medium grey	1	9.283 240
5 - 100	0.1	0.8	0.2	yellow	1	9.283 241
15 - 300	0.2	0.6	0.2	orange	1	9.283 242
50 - 1000	1.0	0.6	0.2	blue	1	9.283 243
250 - 5000	5.0	0.6	0.15	purple	1	9.283 244
500 - 10000	10.0	0.6	0.15	turquoise	1	9.283 245



1 Electronic single channel microliter pipettes Eppendorf Xplorer® plus, variable

The electronic pipettes Eppendorf Xplorer plus were specially designed for high professional standards to provide optimal support for you in your work, with a new intuitive operating concept and design based on the proven Eppendorf PhysioCare® Concept.

Eppendorf AG

- Autodispense
- Manual pipetting, multi-aspirate, dilution, sequential pipetting, sequential dispensing, reverse pipetting
- Programming of multiple modes in a sequence
- Setting of fixed volumes
- Password protection
- History function
- Service interval warning

1



Capacity	Increments	Accuracy max. vol.	Precision max. vol.	Control button	PK	Cat. No.
μl	μl	(\pm R%)	(\leq CV%)	colour		
0.5 - 10	0.01	1.0	0.4	medium grey	1	9.283 181
5 - 100	0.1	0.8	0.2	yellow	1	9.283 182
15 - 300	0.2	0.6	0.2	orange	1	9.283 183
50 - 1000	1.0	0.6	0.2	blue	1	9.283 184
250 - 5000	5.0	0.6	0.15	purple	1	9.283 185
500 - 10000	10.0	0.6	0.15	turquoise	1	9.283 186

2 Multichannel microliter pipettes Eppendorf Research® plus (General Lab Product), variable

Eppendorf AG



The ultra light Eppendorf Research plus pipettor meets the highest requirements in precision and accuracy - combined with ultimate ergonomics and increased flexibility. A spring loaded tip cone, a secondary calibration option, an improved volume display - and all this within a fully autoclavable pipette.

- volume adjustment: Only a few turns needed to reach your desired volume
- control button: Requires minimal operating force, colour indicates volume, ergonomically positioned for comfort
- ejector: requires minimal operating force, ergonomically positioned for comfort
- volume display: 4 digits, magnifying window
- calibration display & adjustment opening: Calibrate your pipettor to a specific liquid and volume.
- channel indicator: - use the pipette the same way round - all the time
- remove individual channels: gain flexibility for individual needs
- Eppendorf PerfectPiston™: ultra-light piston made of Fortron® (except 10 μl pipettors)
- quick connection clip: Easily removable lower housing
- spring loaded tip cone: improved ergonomics, tight fit to the tip

This pipette is a General Lab Product for research purposes.

2



Capacity	Increments	Accuracy max. vol.	Precision max. vol.	Channels	Control button	PK	Cat. No.
μl	μl	(\pm R%)	(\leq CV%)		colour		
0.5 - 10	0,01	1,0	0,4	8	mid grey	1	4.661 854
10 - 100	0,1	0,8	0,2	8	yellow	1	4.661 855
30 - 300	0,2	0,6	0,2	8	orange	1	4.661 856
0.5 - 10	0,01	1,0	0,4	12	mid grey	1	4.661 857
10 - 100	0,1	0,8	0,2	12	yellow	1	4.661 858
30 - 300	0,2	0,6	0,2	12	orange	1	4.661 859

Online also available as IVD version.

Pipette stands Eppendorf

Eppendorf AG

Description	PK	Cat. No.
Pipette carousel 2, for 6 Eppendorf Research® / plus, Eppendorf Reference® / 2, Biomaster®	1	6.288 689 1
Pipette stand 2, for 1 Eppendorf Multipipette® M4	1	6.288 693
Pipette holder 2, for 1 Eppendorf Research® / plus, Eppendorf Reference® / 2, Biomaster®, for	1	6.288 694
Pipette carousel 2 and Charging carousel 2 or wall mounting, incl. adhesive tape, without charging function	1	6.288 695 2
Pipette holder 2, for 1 Eppendorf Xplorer® / plus, for Pipette carousel 2 or wall mounting, incl. adhesive tape, without charging function	1	6.288 696
Pipette holder 2, for 1 Eppendorf Multipipette® E3/E3x / stream/Xstream, for Pipette carousel 2 or wall mounting, incl. adhesive tape, without charging function	1	6.288 697
Pipette holder 2, for 1 Eppendorf Multipipette® M4, for Pipette carousel 2 and Charging carousel 2 or wall mounting, incl. adhesive tape, without charging function	1	6.288 698
Charging carousel 2, for 6 Eppendorf Xplorer® / plus, incl. power supply with magnetic contact	1	6.288 690 3
Charging stand 2, for 1 Eppendorf Xplorer® / plus, to use with the power supply included in the delivery of the Eppendorf Xplorer® / plus	1	6.288 691
Charging stand 2, for 1 Eppendorf Multipipette® E3/E3x / stream/Xstream, to use with the power supply included in the delivery of the Multipipette® E3/E3x / stream/Xstream	1	6.288 692 4
Charging cradle 2, for 1 Eppendorf Xplorer® / plus, for Charging carousel 2, with charging function	1	6.288 698
Charging cradle 2, for 1 Eppendorf Multipipette® E3/E3x / stream/Xstream, for Charging carousel 2, with charging function	1	6.288 699

1



6.288 689

2



6.288 695

3



6.288 690

4



6.288 692

Accessories for pipette stands

Eppendorf AG

Type	PK	Cat. No.
Power adapter for charger carousel 2, with magnetic power connector	1	6.288 700

We can **supply** this
manufacturer's
whole
product range !



1 Multichannel microliter pipettes Eppendorf Reference® 2 (General Lab Product), variable



Eppendorf AG

1



The Reference® 2 is the successor to the highly successful Reference pipette, and enhances the range's already high standards with a new design, reduced weight and operating forces and multi-channel versions. As the premium product in Eppendorf's pipette portfolio, the Reference® 2 provides the most accurate results possible alongside robust, reliable handling and optimum user safety.

New features: An embedded RFID chip contains all relevant data regarding the pipette and offers with Eppendorf TrackIT simple identification and documentation. The new Reference 2 multi channel offers a channel indicator and a spring-loaded tip cone for optimum tip fit and reduced effort. The range of the variable single channel pipettes have been extended by the volume sizes up to 5000µl and 10.000µl.

- Color coded and volume labeled for quick identification of the volume size/ tip size
- Round upper part makes it possible to work in every position
- 4-digit display for exact volume setting (clearly visible from every angle)
- Quick and secure volume setting, include volume lock
- Fully autoclavable
- Movable parts and external edges made from stainless steel equip the pipette with outstanding robustness at potential impact sites and for internal components
- Channel indicator guarantees a continuously identical pipette alignment during the work process
- Spring-loaded tip cone for reproducible tip fit and reduced effort (to be switched on/off optionally)
- High flexibility and simple maintenance with the ability to remove single cones

This pipette is a General Lab Product for research purposes.

Capacity	Increments	Accuracy max. vol.	Precision max. vol.	Channels	Control button	PK	Cat. No.
µl	µl	(± R%)	(≤ CV%)		colour		
0,5 - 10	0,01	2,0	1,0	8	medium grey	1	4.662 409
10 - 100	0,1	0,8	0,3	8	yellow	1	4.662 411
30 - 300	0,2	0,6	0,3	8	orange	1	4.662 413
0,5 - 10	0,01	2,0	1,0	12	medium grey	1	4.662 410
10 - 100	0,1	0,8	0,3	12	yellow	1	4.662 412
30 - 300	0,2	0,6	0,3	12	orange	1	4.662 414

Online also available as IVD version.

2 Electronic multichannel microliter pipettes Eppendorf Xplorer®, variable

The new electronic pipette Eppendorf Xplorer® sets new standards in terms of simplicity, precision and reproducibility.

Eppendorf AG

2



- Multifunctional rocker: "Up is up and down is down"™ principle
- Easy selection of all functions with the practical selection dial
- Operate in the language of your choice
- Clearly arranged colour display
- No sub-menus
- Help function
- Innovative rocker: When the tip is ejected, the piston automatically returns to zero position
- Tips always rest in the same position
- Volume & speed precisely and reproducibly adjustable
- Adjustable to your work environment and requirements
- Incl. 230V/50Hz charging adapter. The pipette can be charged directly with the charging adapter. Additionally the charging adapter can also be used with the optional charging stand (Cat. No. 9.283 254) which holds the pipette safely whilst charging.

Capacity	Increments	Accuracy max. vol.	Precision max. vol.	Channels	Control button	PK	Cat. No.
µl	µl	(± R%)	(≤ CV%)		colour		
0,5 - 10	0.01	2.0	0.8	8	medium grey	1	9.283 246
5 - 100	0.1	0.8	0.25	8	yellow	1	9.283 248
15 - 300	0.2	0.6	0.25	8	orange	1	9.283 250
50 - 1200	1.0	1.2	0.3	8	green	1	9.283 252
0,5 - 10	0.01	2.0	0.8	12	medium grey	1	9.283 247
5 - 100	0.1	0.8	0.25	12	yellow	1	9.283 249
15 - 300	0.2	0.6	0.25	12	orange	1	9.283 251
50 - 1200	1.0	1.2	0.3	12	green	1	9.283 257

1



1

Electronic multichannel microliter pipettes Eppendorf Xplorer® plus, variable

Eppendorf AG

The electronic pipettes Eppendorf Xplorer plus were specially designed for high professional standards to provide optimal support for you in your work, with a new intuitive operating concept and design based on the proven Eppendorf PhysioCare® Concept.

- Autodispense
- Manual pipetting, multi-aspirate, dilution, sequential pipetting, sequential dispensing, reverse pipetting
- Programming of multiple modes in a sequence
- Setting of fixed volumes
- Password protection
- History function
- Service interval warning

Capacity	Increments	Accuracy max. vol.	Precision max. vol.	Channels	Control button	PK	Cat. No.
µl	µl	(± R%)	(≤ CV%)		colour		
0.5 - 10	0.01	2.0	0.8	8	medium grey	1	9.283 187
5 - 100	0.1	0.8	0.25	8	yellow	1	9.283 189
15 - 300	0.2	0.6	0.25	8	orange	1	9.283 191
50 - 1200	1.0	1.2	0.3	8	green	1	9.283 193
0.5 - 10	0.01	2.0	0.8	12	medium grey	1	9.283 188
5 - 100	0.1	0.8	0.25	12	yellow	1	9.283 190
15 - 300	0.2	0.6	0.25	12	orange	1	9.283 192
50 - 1200	1.0	1.2	0.3	12	green	1	9.283 194

2



2

Pipette Leak Testing Unit (PLT unit)

BRAND

Improved process reliability with functional validation of air-displacement pipettes. The most frequent cause of inaccuracy in piston-operated pipettes is leakage. This arises from damage either to the seals, pistons or tip cones. Often not detectable by the naked eye, leaks lead to significant volume errors. The BRAND pipette leak tester (PLT unit) for air displacement pipettes finds even the smallest leaks within seconds.

- Limit values for the commercially available single- and multichannel pipettes in the volume range 1µl to 10ml are pre-programmed.
- Testing with and without tips
- Test results in seconds
- Patent pending

According to monitoring of measuring instruments, air-displacement pipettes must be checked at regular intervals and the results must be compared with the ISO 8655-2 error limits. However, a calibration certificate only reflects the results at the time of testing. The time between these calibrations is crucial, since leaks can occur at any time. Well over 80% of pipettes sent in for repair have leaks and are outside their volume tolerances, even if they don't drip.

While the PLT unit cannot replace regular gravimetric testing, daily pipette checks can provide a safeguard during the periods between calibrations. Even the smallest leaks are detected. Process reliability for the pipettes is thus significantly improved.

Items supplied:

PLT unit (Pipette Leak Testing Unit) including one adapter each for testing air-displacement pipettes with tip (mounted) and without tip, 2 plugs, 3 replacement PE filters for the pipette adapters, universal AC adapter, quality certificate and operating manual.

Type	PK	Cat. No.
Pipette Leak Testing Unit	1	4.007 886

Further accessories can be found in our online shop.

1 Positive displacement pipettes, Transferpettor

For easy, clean pipetting of problematic media.
Transferpettor operates by positive displacement, which makes it ideal for pipetting:

- Highly viscous media such as oils, resins and fats up to a viscosity of 140.000mm²/sec. (dependent on instrument size)
- Media with high vapour pressure up to 500mbar (Alcohols, ethers, hydrocarbons etc.)
- Media with a high density up to 13.6g/cm³ (e.g. mercury and sulphuric acid)
- Media that tend to foam (surfactant solutions).
- Working temperature range: 15°C to 40°C

Capillary tubes and tips can be used over and over again, since residual wetting is negligible and generally has no influence on the overall result. This leads to lower material costs and reduced waste.

But: In cases, where no contamination is permitted, e.g. with infectious or radioactive media, the Brand Transferpette® is recommended, an air displacement pipettor for comfortable working with disposable tips.

Items supplied: Transferpettor, DE-M marking, with quality certificate.



Single channel pipettes Transferpettor Fixed-volume

With pipette caps and seals.

BRAND

Capacity µl	Increments µl	Accuracy max. vol. (± R%)	Precision max. vol. (≤ CV%)	Seal material	Cap material	PK	Cat. No.
1	-	4.0	4.0	-	glass	1	9.280 696
50	-	0.6	0.4	PTFE	glass	1	9.280 705
100	-	0.6	0.4	PTFE	glass	1	9.280 710
200	-	0.5	0.2	PTFE	glass	1	9.280 720

Single channel pipettes Transferpettor Digital-adjustable

BRAND

Capacity µl	Increments µl	Colour coding	Accuracy max. vol. (± R%)	Precision max. vol. (≤ CV%)	Cap material	PK	Cat. No.
2.5 - 10	0.01	orange	1.0	0.8	glass*	1	9.280 602
5 - 25	0.1	2 x white	0.8	0.5	glass*	1	9.280 605
10 - 50	0.1	green	0.6	0.4	glass*	1	9.280 610
20 - 100	0.1	blue	0.6	0.4	glass*	1	9.280 620
100 - 500	1.0	green	0.5	0.2	PP**	1	9.280 724
200 - 1000	1.0	yellow	0.5	0.2	PP**	1	9.280 726
1000 - 5000	10.0	red	0.5	0.2	PP**	1	9.280 730
2000 - 10000	10.0	orange	0.5	0.2	PP**	1	9.280 732

* PTFE-Seals
**PE-Seals

2 3 Caps for single channel pipettes Transferpettor

BRAND

Capacity µl	Material	PK	Cat. No.
1, 2, 5	glass	100	9.280 800
10	glass	100	9.280 801
20	glass	100	9.280 802
25	glass	100	9.280 803
50	glass	100	9.280 805
100 / 200	glass	50	9.280 810
100 to 500	PP	10	9.280 741
200 to 1000	PP	10	9.280 742
1000 to 5000	PP	10	9.280 743
2000 to 10000	PP	10	9.280 745



4 Seals for pipettes Transferpettor

BRAND

Capacity µl	Material	PK	Cat. No.
20 / 25	PTFE	3	9.280 901
50	PTFE	3	9.280 903
100 / 200	PTFE	3	9.280 905
100 to 500	PE	10	9.280 751
200 to 1000	PE	10	9.280 752
1000 to 5000	PE	10	9.280 753
2000 to 10000	PE	10	9.280 755



Pipettes/Positive displacement pipettes

1



1 Stands for single channel pipettes Transferpettor

Transferpettor stations. For storage of 4 instruments up to 200 µl with accessories or 2 instruments from 0.5 to 10 ml with accessories.

BRAND

Type	PK	Cat. No.
For 2 pipettes with accessories	1	9.280 581
For 4 pipettes with accessories	1	9.280 850

2



2 Positive displacement micropipettes Acura® capillar 846

High performance positive displacement micropipettes with interchangeable glass capillary tube and ETFE tipped plunger. The soft shaped handle and smooth plunger activation provides for enhanced hand comfort while handling viscous liquids, foaming solutions or volatile solvents.

Socorex

- Five models cover a range from 1 to 200 µL.
- Slim body shape, comfortable finger rest
 - Smooth plunger activation
 - Reliable, step-wise volume adjustment
 - Colour codes matching on pipettes, plungers and capillaries
 - Stainless steel, ETFE tipped plunger
 - Three-year warranty

Capacity µl	Increments µl	Accuracy max. vol. (± R%)	Precision max. vol. (≤ CV%)	Cap material	PK	Cat. No.
1 - 5	1	2.0	1.2	ETFE	1	6.263 911
5 - 25	5	0.8	0.6	ETFE	1	6.263 912
10 - 50	10	0.7	0.4	ETFE	1	6.263 913
60 - 100	10	0.7	0.3	ETFE	1	6.263 914
100 - 200	25	0.7	0.3	ETFE	1	6.263 915

3



3 Accessories for Positive displacement micropipettes Acura® capillary 846

Socorex

Description	PK	Cat. No.
Spare glass capillary, white	200	6.308 832
Spare glass capillary, 2 x white	200	6.225 698
Spare glass capillary, green	200	6.307 233
Spare glass capillary, blue	200	6.803 126
Spare glass capillary, red	100	6.210 150
Spare plunger, steel	5	6.308 831
Spare plunger, white	5	6.304 882
Spare plunger, green	5	6.210 135
Spare plunger, blue	5	6.803 127
Spare plunger, red	5	6.320 887



All pipette tips made of PP are autoclavable.



1 LLG-Labware pipette tips, economy 2.0, PP NEW

The new generation of LLG Labware Pipette tips economy.

Available in bulk quantities in bags or in easy-to-open boxes with color coded racks. Racked-tip boxes are delivered in a dispenser, which can be opened from two sides facilitating the use of the product on two work spaces.

Compatible with all common pipette brands. You can find the appropriate compatibility list on www.llg-labware.com in the Downloads section.

- Improved optical clarity and pipette fit
- Colored coded rack inserts for easy identification
- Graduated (5 and 10 ml tips without graduation)
- Autoclavable
- DNase and RNase free

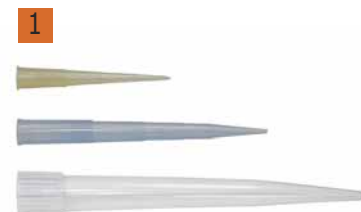

Capacity µl	Colour	Package contents	PK	Cat. No.
0.1 ... 10	transparent	1000 tips in bag	1000	4.668 775
0.1 ... 10	transparent	10 x 96 tips in rack	960	4.668 776
1 ... 200	transparent	10 x 96 tips in rack	960	4.668 778
1 ... 200	yellow	1000 tips in bag	1000	4.668 777
1 ... 200	yellow	10 x 96 tips in rack	960	4.668 779
100 ... 1000	transparent	1000 tips in bag	1000	4.668 780
100 ... 1000	transparent	8 x 96 tips in rack	768	4.668 782
100 ... 1000	blue	1000 tips in bag	1000	4.668 781
100 ... 1000	blue	8 x 96 tips in rack	768	4.668 783
100 - 5000*	clear	1 bag of 250	250	9.409 097
100 - 5000**	clear	1 bag of 250	250	6.254 364
1000 - 10000	clear	1 bag of 100	100	9.409 098

*for manual pipettors

**for electronic pipettors

2 LLG-Filter tips 2.0 Low Retention, PP NEW

The new generation of LLG Labware filter tips with low liquid retention. Available in easy-to-open boxes with color coded racks. Compatible with all common pipette brands. You can find the appropriate compatibility list on www.llg-labware.com in the Downloads section.

- Improved optical clarity and pipette fit
- Colored coded rack inserts for easy identification
- Graduated
- Sterile
- DNase and RNase free

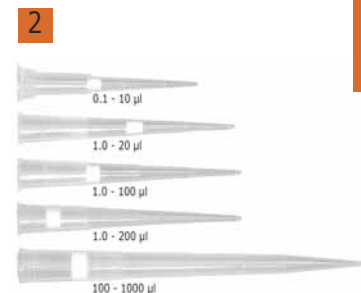

Colour	Capacity µl	Package contents	PK	Cat. No.
Clear	0,1 ... 10	10 x 96	960	4.668 784
Clear	0,1 ... 10 *	10 x 96	960	4.668 785
Clear	1 ... 20	10 x 96	960	4.668 786
Clear	1 ... 100	10 x 96	960	4.668 787
Clear	1 ... 200	10 x 96	960	4.668 788
Clear	100 ... 1000	8 x 96	768	4.668 789

* Tip XL

3 LLG-Pipette Tips *ULTRALOW*, bulk, non-sterile NEW

All LLG-Pipette tips *ULTRALOW* feature an extremely low liquid retention compared to standard tips due to their hydrophobic inner side. This enables accurate, more complete and more precise dispensing of fluids, even of viscous ones. LLG-Pipette tips *ULTRALOW* is compatible with all major pipette brands such as LLG-proMPL, Gilson, Eppendorf, Brand, Sartorius, Socorex and others. You can find the appropriate compatibility list on www.llg-labware.com in the Downloads section.

- With easy visible volume graduations
- Universal fit tips, compatible with common pipette brands



Capacity µl	PK	Cat. No.
10	960	6.291 866
200	960	6.291 867
1250	960	6.291 868

1



1 LLG-Pipette tip Refill system *ULTRALOW*



The new LLG-Pipette tip Refill system *ULTRALOW* consists of racked tips and easy-to-use, environmentally friendly pipette tip refills.

All LLG-Pipette tips *ULTRALOW* feature an extremely low liquid retention compared to standard tips due to their hydrophobic inner side. This enables accurate, more complete and more precise dispensing of fluids, even of viscous ones!

LLG refills are easy to use allowing a quick filling of empty racks. Its packaging is made out of recyclable paperboard which reduces the overall waste production and thus is absolutely environmentally friendly!

LLG-Pipette tip Refill system *ULTRALOW* is compatible with all major pipette brands such as LLG-proMLP, Gilson, Eppendorf, Brand, Sartorius, Socorex and others. You can find the appropriate compatibility list on www.llg-labware.com in the Downloads section.

Features:

- Ultralow retention tips with easy visible volume graduations
- Universal fit tips, compatible with common pipette brands
- Easy-to-use lift-and-load refill system
- Refill inserts are imprinted with volume and LOT No. for easy identification
- 50 % less storage space than full racks
- 70 % reduction in total materials compared to other refill systems
- environmentally friendly and recyclable packing materials made out of paperboard
- Rack footprint is compatible with automation and facilitates stacking, autoclavable

2



2 LLG-Pipette Tips *ULTRALOW*, Refill System

Capacity µl	Package contents	PK	Cat. No.
10	10 x 96	960	6.283 565
200	10 x 96	960	6.283 568
1250	8 x 96	768	6.283 570

3



3 Racks for LLG-Pipette Tips *ULTRALOW*, empty

Description	PK	Cat. No.
for 10 µl XL and 200 µl LLG- Pipette Tips <i>ULTRALOW</i> Refill System	5	6.283 566
for 1250 µl LLG- Pipette Tips <i>ULTRALOW</i> Refill System	5	6.283 571

4



4 LLG-Pipette Tips *ULTRALOW*, Rack

Capacity µl	Package contents	PK	Cat. No.
10	10 racks of 96 tips	960	6.283 567
200	10 racks of 96 tips	960	6.283 569
1250	8 racks of 96 tips	768	6.283 572

1 Pipette tips, non-sterile



- Precise design and manufacture ensures highest quality tips.
- Moulded with high quality polypropylene
 - Firm fit on pipettor cones
 - Optimum handling due to straight shape
 - Special ionization process guarantees dust free tip production
 - Excellent transparency due to optimum surface quality
 - Minimum fluid retention due to controlled raw material quality
 - Excellent volumetric accuracy due to precisely moulded tip orifices
 - Most practical tip volumes
 - Non-sterile
 - Autoclavable

- A:** all pipettes, ratiopetta®
- B:** Gilson Pipetman®/Neo®
- C:** Oxford®
- D:** Dr. Lange®
- E:** Thermo-Scientific Finnpiquette® F1/F2
- F:** Biohit® Proline
- G:** Biohit mLINE®
- H:** Brand®
- I:** Eppendorf Reference®
- J:** Socorex Calibra®

Ratiolab

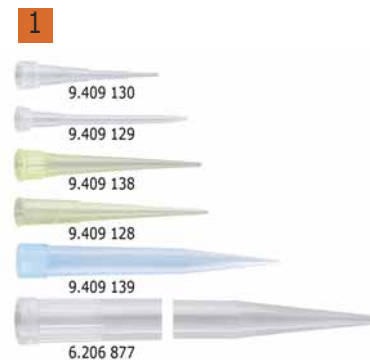

9.409 140

Fits	Colour	Capacity	Package contents	PK	Cat. No.
		µl			
B	Crystal	0,1 - 10	1 bag of 1000	1000	9.409 130
A	Crystal	0,5 - 20	1 bag of 1000	1000	9.409 129
A	Yellow	1 - 200	1 bag of 1000	1000	9.409 138
A	Transparent	1 - 200	1 bag of 1000	1000	6.070 440
A	Yellow	1 - 250	1 bag of 1000	1000	9.409 128
A	Blue	100 - 1200	1 bag of 1000	1000	9.409 139
F, I	Transparent	1000 - 5000	1 bag of 300	300	6.308 744
D, E	Transparent	1000 - 5000	1 collapsible box of 75	75	9.409 140

3 Filter tips, HDPE

Pipette tips with special filters, to effectively prevent the inner pipettor shaft from contamination with aerosols and liquids to be drawn into the pipettor.

Ratiolab

- Sterile
- Free of DNA, DNase, pyrogens and ATP
- Pipette tips and aerosol filters made of ultra-hydrophobic HDPE
- Minimized retention due to special surface treatment
- Perfect and close fit on all major pipettor brands
- Packed in plastic racks with hinge lids
- *aeroject® ultra with extended length for operation with narrow vessels and reduced risk of cross-contamination

Fits pipettors: ratiopetta®, Biohit® Proline, Biohit® m-Line, Brand® Transferpette®, CappAero, Eppendorf® Research®, Eppendorf® Reference®, Finnpiquette® Digital, Finnpiquette® Focus, Gilson® Pipetman®, Gilson® Ultra, Labmate® and Socorex® Calibra, Labpipetten



Capacity	Package contents	PK	Cat. No.
µl			
0,1 - 10*	10 racks of 96	960	6.262 343
1 - 20	10 racks of 96	960	6.262 867
1 - 100	10 racks of 96	960	6.262 868
1 - 200	10 racks of 96	960	6.262 869
100 - 1000	10 racks of 60	600	6.262 275



1 2 Pipette tips and filter tips



Pipette tips and filter tips are manufactured by BRAND in a cleanroom under the most modern production conditions, and are automatically rack packed and packaged to ensure that the tips are of consistently high quality.

Quality features:

- High-purity polypropylene, free from DiHEMA and oleamide
- Manufactured without lubricants
- Graduation for a quick volume check
- All tips and filter tips up to 1000 µl are free of DNA (<40 fg), RNase (<8.6 fg), endotoxins (<1 pg) and ATP (<1 fg)
- All sterile products in BIO-CERT® Quality: sterile acc. ISO 11 137 and AAMI guidelines, a SAL of 10⁻⁶ is obtained.
- Autoclavable at 121°C (2 bar), acc. DIN EN 285
- Environmentally friendly packaging systems
- Pipette and filter tips from BRAND are tested for BRAND pipettes and most of the pipette types of Gilson®, Thermo Fisher Scientific Finnpiptette®, Eppendorf® and Biohit.

The 5 ml tip is exclusively tested for BRAND pipettes and Thermo Fisher Scientific Finnpiptette®. The 10 ml tip is suitable for BRAND, Eppendorf® and Gilson®.

Ultra Low Retention-tips

The surfaces of the Ultra Low Retention tips are produced through a physicochemical process.

Filter Tips

Non-self-sealing filter tips from BRAND have a PE filter that is free from chemical additives. Permeability is controlled by the combination of pore size and filter length, so that no aerosols can reach the pipette shaft.

Bulk packed in reclosable bags.

The batch number is printed on every bag.

TipBox, sterile and non sterile, BIO-CERT®

PP. Two different sizes. Stackable and repeatedly autoclavable at 121 °C (2 bar), acc. DIN EN 285.

TipStack™, non sterile and sterile, BIO-CERT®

A tip tower containing 5 filled tip-trays and a TipBox constitute the new, space-saving refill system for 20 µl, 200 µl and 1000 µl tips.

TipRack, sterile and non sterile, BIO-CERT®

Refill unit for TipBox. Compared to the filled TipBoxes, the amount of waste with the new refill units is reduced by over 20%.

TipBox 5/10 ml, non sterile

The 5 ml and 10 ml tips are only available as a racked tip version in these specially corresponding TipBox.

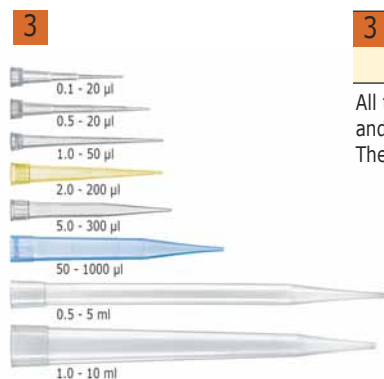
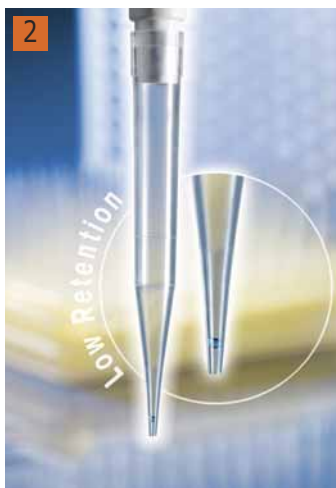

3 Pipette tips, bulk, in reclosable bags, non-sterile

All tips and filter tips are produced under supervised state-of-the-art Cleanroom conditions and automatically shrink-wrapped in reclosable bags and packaged in cardboard boxes. The batch number is printed on every bag.

BRAND

Colour	Capacity µl	Package contents	PK	Cat. No.
natural	0,1 - 20	2 bags of 1000	2000	9.409 669
natural	0,5 - 20	2 bags of 1000	2000	9.409 670
natural	1 - 50	2 bags of 1000	2000	9.409 671
yellow	2 - 200	1 bag of 1000	1000	9.409 672
natural	5 - 300	1 bag of 1000	1000	9.409 673
blue	50 - 1000	2 bags of 500	1000	9.409 674
natural	500 - 5000	1 bag 200	200	9.409 223
natural	1000 - 10000	2 bags of 100	200	9.409 191
natural	0,1 - 20	10 bags of 1000 (XXL)	10000	9.409 675
natural	0,5 - 20	10 bags of 1000 (XXL)	10000	9.409 676
natural	1- 50	10 bags of 1000 (XXL)	10000	9.409 677
yellow	2 - 200	10 bags of 1000 (XXL)	10000	9.409 678
natural	5 - 300	10 bags of 1000 (XXL)	10000	9.409 679
blue	50 - 1000	10 bags of 500 (XXL)	5000	9.409 680
natural	500 - 5000	5 bags of 200 (XXL)	1000	9.409 199
natural	1000 - 10000	10 bags of 100 (XXL)	1000	9.409 192

1 Filter pipette tips, in reclosable bags, non-sterile

All tips and filter tips are produced under supervised state-of-the-art Cleanroom conditions and automatically shrink-wrapped in reclosable bags and packaged in cardboard boxes. The batch number is printed on every bag.

BRAND

Capacity	Package contents	PK	Cat. No.
μl			
0.1 - 1	1 bag of 960	960	9.409 681
0.5 - 10	1 bag of 960	960	9.409 682
1.0 - 20	1 bag of 960	960	9.409 683
2 - 20	1 bag of 960	960	9.409 684
5 - 100	1 bag of 960	960	9.409 685
5 - 200	1 bag of 960	960	9.409 686
50 - 1000	1 bag of 960	960	9.409 687



2 Pipette tips, racked in TipRack, non-sterile

For TipBox. Refill unit, protected in an environmentally compatible packaging of recyclable PET.

BRAND

Capacity	Package contents	PK	Cat. No.
μl			
0.1 - 20	10 TipRacks of 96	960	9.409 757
0.5 - 20	10 TipRacks of 96	960	9.409 758
1 - 50	10 TipRacks of 96	960	9.409 759
2 - 200	10 TipRacks of 96	960	9.409 760
5 - 300	10 TipRacks of 96	960	9.409 761
50 - 1000	10 TipRacks of 96	960	9.409 762



3 Filter tips racked in TipRack, non-sterile

For TipBox. Refill unit, protected in an environmentally compatible packaging of recyclable PET.

BRAND

Capacity	Package contents	PK	Cat. No.
μl			
0.1 - 1	10 TipRacks of 96	960	9.409 769
0.5 - 10	10 TipRacks of 96	960	9.409 770
1.0 - 20	10 TipRacks of 96	960	9.409 771
2 - 20	10 TipRacks of 96	960	9.409 772
5 - 100	10 TipRacks of 96	960	9.409 773
5 - 200	10 TipRacks of 96	960	9.409 774
50 - 1000	10 TipRacks of 96	960	9.409 775



4 Pipette tips racked in TipRack, sterile, BIO-CERT®

For TipBox. Refill unit, protected in an environmentally compatible packaging of recyclable PET. Sterile TipRacks are supplied with a transfer aid so that the rack can be put into a previously autoclaved box without hand contact.

BRAND

Capacity	Package contents	PK	Cat. No.
μl			
0.1 - 20	10 TipRacks à 96	960	9.409 763
0.5 - 20	10 TipRacks à 96	960	9.409 764
1 - 50	10 TipRacks à 96	960	9.409 765
2 - 200	10 TipRacks à 96	960	9.409 766
5 - 300	10 TipRacks à 96	960	9.409 767
50 - 1000	10 TipRacks à 96	960	9.409 768



5 Filter tips racked in TipRack, sterile, BIO-CERT®

For TipBox. Refill unit, protected in an environmentally compatible packaging of recyclable PET. Sterile TipRacks are supplied with a transfer aid so that the rack can be put into a previously autoclaved box without hand contact.

BRAND

Capacity	Package contents	PK	Cat. No.
μl			
0.1 - 1	10 TipRacks à 96	960	9.409 776
0.5 - 10	10 TipRacks à 96	960	9.409 777
1.0 - 20	10 TipRacks à 96	960	9.409 778
2 - 20	10 TipRacks à 96	960	9.409 779
5 - 100	10 TipRacks à 96	960	9.409 780
5 - 200	10 TipRacks à 96	960	9.409 781
50 - 1000	10 TipRacks à 96	960	9.409 782



1



1 2 Filter tips, racked in TipBox, PP, non-sterile

PP. With hinged lid/push-on lid. Simply rotate 180° to change closure method. Usable with a partially loaded multichannel pipette. Two different sizes. Stackable and repeatedly autoclavable at 121 °C (2 bar), acc. DIN EN 285.

BRAND

Description	Capacity µl	Package contents	PK	Cat. No.
Standard	0.1 - 1	5 boxes of 96	480	9.409 700
Standard	0.5 - 10	5 boxes of 96	480	9.409 701
Standard	1.0 - 20	5 boxes of 96	480	9.409 702
Standard	2 - 20	5 boxes of 96	480	9.409 703
Standard	5 - 100	5 boxes of 96	480	9.409 704
Standard	5 - 200	5 boxes of 96	480	9.409 705
Standard	50 - 1000	5 boxes of 96	480	9.409 706
Low Retention	0.1 - 1	5 boxes of 96	480	9.409 707
Low Retention	0.5 - 10	5 boxes of 96	480	9.409 708
Low Retention	1.0 - 20	5 boxes of 96	480	9.409 709
Low Retention	2 - 20	5 boxes of 96	480	9.409 712
Low Retention	5 - 100	5 boxes of 96	480	9.409 713
Low Retention	5 - 200	5 boxes of 96	480	9.409 714
Low Retention	50 - 1000	5 boxes of 96	480	9.409 715

2



3



3 Pipette tips, racked in TipBox, PP, non-sterile

PP. With hinged lid/push-on lid. Simply rotate 180° to change closure method. Usable with a partially loaded multichannel pipette. Two different sizes. Stackable and repeatedly autoclavable at 121 °C (2 bar), acc. DIN EN 285.

BRAND

Description	Capacity µl	Package contents	PK	Cat. No.
Standard	0.1 - 20	5 Boxes of 96	480	9.409 688
Standard	0.5 - 20	5 Boxes of 96	480	9.409 689
Standard	1 - 50	5 Boxes of 96	480	9.409 690
Standard	2 - 200	5 Boxes of 96	480	9.409 691
Standard	5 - 300	5 Boxes of 96	480	9.409 692
Standard	50 - 1000	5 Boxes of 96	480	9.409 693
Low Retention	0.1 - 20	5 Boxes of 96	480	9.409 694
Low Retention	0.5 - 20	5 Boxes of 96	480	9.409 695
Low Retention	1 - 50	5 Boxes of 96	480	9.409 696
Low Retention	2 - 200	5 Boxes of 96	480	9.409 697
Low Retention	5 - 300	5 Boxes of 96	480	9.409 698
Low Retention	50 - 1000	5 Boxes of 96	480	9.409 699

4



4 Pipette tips, racked in Tip-Box, sterile, Bio-Cert®

PP. With hinged lid/push-on lid. Simply rotate 180° to change closure method. Usable with a partially loaded multichannel pipette. Two different sizes. Stackable and repeatedly autoclavable at 121 °C (2 bar), acc. DIN EN 285.

BRAND

Description	Capacity µl	Package contents	PK	Cat. No.
Standard	0.1 - 20	10 boxes of 96	960	9.409 716
Standard	0.5 - 20	10 boxes of 96	960	9.409 717
Standard	1 - 50	10 boxes of 96	960	9.409 718
Standard	2 - 200	10 boxes of 96	960	9.409 719
Standard	5 - 300	10 boxes of 96	960	9.409 721
Standard	50 - 1000	10 boxes of 96	960	9.409 722
Low Retention	0.1 - 20	10 boxes of 96	960	9.409 730
Low Retention	0.5 - 20	10 boxes of 96	960	9.409 733
Low Retention	1 - 50	10 boxes of 96	960	9.409 734
Low Retention	2 - 200	10 boxes of 96	960	9.409 735
Low Retention	5 - 300	10 boxes of 96	960	9.409 736
Low Retention	50 - 1000	10 boxes of 96	960	9.409 737

1 Filter tips, racked in TipBox, sterile, Bio-Cert®

PP. With hinged lid/push-on lid. Simply rotate 180° to change closure method.
Usable with a partially loaded multichannel pipette. Two different sizes.
Stackable and repeatedly autoclavable at 121 °C (2 bar), acc. DIN EN 285.

BRAND

Description	Capacity	Package contents	PK	Cat. No.
	µl			
Standard	0.1 - 1	10 boxes of 96	960	9.409 723
Standard	0.5 - 10	10 boxes of 96	960	9.409 724
Standard	1.0 - 20	10 boxes of 96	960	9.409 725
Standard	2 - 20	10 boxes of 96	960	9.409 726
Standard	5 - 100	10 boxes of 96	960	9.409 727
Standard	5 - 200	10 boxes of 96	960	9.409 728
Standard	50 - 1000	10 boxes of 96	960	9.409 729
Low Retention	0.1 - 1	10 boxes of 96	960	9.409 738
Low Retention	0.5 - 10	10 boxes of 96	960	9.409 739
Low Retention	1.0 - 20	10 boxes of 96	960	9.409 740
Low Retention	2 - 20	10 boxes of 96	960	9.409 741
Low Retention	5 - 100	10 boxes of 96	960	9.409 742
Low Retention	5 - 200	10 boxes of 96	960	9.409 743
Low Retention	50 - 1000	10 boxes of 96	960	9.409 744

**2 Pipette tips refill TipStack™, non-sterile**

Space-saving, environmentally compatible refill system for TipBox.
5 racks, each having 96 tips incl. 1 TipBox.
Each packaging unit contains 2 TipStacks.

BRAND

Description	Capacity	Package contents	PK	Cat. No.
	µl			
Standard	0.5 - 20	2 x 5 TipRacks à 96	960	9.409 745
Standard	2 - 200	2 x 5 TipRacks à 96	960	9.409 746
Standard	50 - 1000	2 x 5 TipRacks à 96	960	9.409 747
Low Retention	0.5 - 20	2 x 5 TipRacks à 96	960	9.409 751
Low Retention	2 - 200	2 x 5 TipRacks à 96	960	9.409 752
Low Retention	50 - 1000	2 x 5 TipRacks à 96	960	9.409 753

**3 Pipette tips refill TipStack™, sterile, BIO-CERT®**

Space-saving, environmentally compatible refill system for TipBox.
5 racks, each having 96 tips incl. 1 TipBox. Sterile TipStacks are supplied with a transfer aid so that the rack can be put into a previously autoclaved box without hand contact.
Each packaging unit contains 2 TipStacks.

BRAND

Description	Capacity	Package contents	PK	Cat. No.
	µl			
Standard	0.5 - 20	2 x 5 racks of 96	960	9.409 748
Standard	2 - 200	2 x 5 racks of 96	960	9.409 749
Standard	50 - 1000	2 x 5 racks of 96	960	9.409 750
Low Retention	0.5 - 20	2 x 5 racks of 96	960	9.409 754
Low Retention	2 - 200	2 x 5 racks of 96	960	9.409 755
Low Retention	50 - 1000	2 x 5 racks of 96	960	9.409 756

**4 TipBox 5/10 ml, non-sterile**

The 5 ml and 10 ml tips are only available as a racked tip version in these specially corresponding TipBox.

BRAND

Description	Volume	Package contents	PK	Cat. No.
	ml			
Standard	0.5 - 5	1 TipBox of 28	28	9.408 905
Standard	1 - 10	1 TipBox of 18	18	9.408 909

**5 TipBox, PP, with Tip-Tray, empty**

PP. With hinged lid/push-on lid. Two different sizes. Stackable and repeatedly autoclavable at 121 °C (2 bar), acc. DIN EN 285. This box can be refilled with TipRack (non-sterile) and TipStack (sterile).

BRAND

Description	Capacity	PK	Cat. No.
	µl		
TipBox, empty	up to 50	1	9.409 783
TipBox, empty	up to 200	1	9.409 784
TipBox, empty	up to 300	1	9.409 785
TipBox, empty	up to 1000	1	9.409 786



8. Liquid Handling

Pipettes/Pipette tips

1

1 Pipette tips Qualitix®

Socorex



The Socorex Qualitix® are exclusively made from high grade, virgin, metal-free polypropylene. Precision injection moulding care for air-tight fit. Stringent quality procedures ensure lot by lot consistency.

- Wide selection, superior quality
- High density filter prevents aerosol contamination
- DNase, RNase, ATP and pyrogen-free tips
- Compatibility with various pipette brands



Pipette tips Qualitix®, natural, thin, 10 µl

Socorex

Description	Capacity	Length	Package contents	PK	Cat. No.
	µl	mm			
Ultra-microtips, graduated, autoclavable	10	31.4	1 bag of 1000	1000	6.289 204 2
Ultra-microtips, graduated, autoclavable	10	31.4	12 racks of 96	1152	6.289 205
Ultra-microtips, graduated, sterile	10	31.4	12 racks of 96	1152	6.289 208
Ultra-microtips, graduated, low protein binding, autoclavable	10	31.4	12 racks of 96	1152	6.289 210 3
Ultra-microtips, graduated, low protein binding, sterile	10	31.4	12 racks of 96	1152	6.289 211
Microtips, long, autoclavable	10	38.1	1 bag of 1000	1000	6.289 212 4
Microtips, long, autoclavable	10	38.1	10 racks of 96	960	6.289 213
Microtips, long, low protein binding, autoclavable	10	38.1	10 racks of 96	960	6.289 215 5
Microtips, long, low protein binding, sterile	10	38.1	10 racks of 96	960	6.289 216
Natural microtip for gel, autoclavable	10	70.9	4 racks of 204	816	9.282 104

2

3

4

5



6.289 204



6.289 210



6.289 212



6.289 215

Pipette tips Qualitix®, oblique graduated, 200 µl

Socorex

Description	Capacity	Length	Package contents	PK	Cat. No.
	µl	mm			
Natural universal tips, autoclavable	200	49.6	1 bag of 1000	1000	6.289 219 6
Natural universal tips, autoclavable	200	49.6	10 racks of 96	960	6.289 220
Natural universal tips, sterile	200	49.6	10 racks of 96	960	6.289 223
Natural ultra-microtips, low protein binding,	200	49.6	10 racks of 96	960	6.289 225 7
Natural universal tips, low protein binding, sterile	200	49.6	10 racks of 96	960	6.289 226
Yellow tips, autoclavable	200	49.6	1 bag of 1000	1000	6.289 227 8
Yellow tips, autoclavable	200	49.6	10 racks of 96	960	6.289 228
Yellow tips, sterile	200	49.6	10 racks of 96	960	6.289 229
Natural capillary tips for gel, autoclavable	200	82.5	6 racks of 96	576	6.289 230 9
Yellow tips for Calibra® pipettes, autoclavable	200	49.6	2 bags of 500	1000	9.282 114
Yellow tips for Calibra® pipettes, autoclavable	200	49.6	10 racks of 96	960	9.282 115

6

7

8

9



6.289 219



6.289 225



6.289 227



6.289 230

Pipette tips Qualitix®, 350 µl

Socorex

Description	Capacity	Length	Package contents	PK	Cat. No.
	µl	mm			
Pipette tips, natural	350	58.8	1 bag of 1000	1000	9.282 116
Pipette tips, natural	350	58.8	10 racks of 96	960	9.282 117

Pipette tips Qualitix®, 1000 µl

Socorex

Description	Capacity	Length	Package contents	PK	Cat. No.
	µl	mm			
Natural universal tips, thin, autoclavable	1000	88.9	1 bag of 1000	1000	6.289 232 1
Natural universal tips, thin, autoclavable	1000	88.9	6 racks of 96	576	6.289 233
Natural universal tips, thin, sterile	1000	88.9	6 racks of 96	576	6.289 236
Natural ultra-microtips, thin, low protein binding, autoclavable	1000	88.9	6 racks of 96	576	6.289 238 2
Natural universal tips, thin, low protein binding, sterile	1000	88.9	6 racks of 96	576	6.289 239
Natural tips, oblique, autoclavable	1000	75.9	1 bag of 1000	1000	6.289 243
Natural tips, oblique, graduated, autoclavable	1000	75.9	6 racks of 96	576	6.289 244
Blue universal tips	1000	72.0	4 bags of 250	1000	9.282 122
Blue universal tips	1000	72.0	8 racks of 60	480	9.282 123
Blue tips, oblique, autoclavable	1000	75.9	1 bag of 1000	1000	6.289 240 3
Blue tips, oblique, autoclavable	1000	75.9	6 racks of 96	576	6.289 241
Blue tips, oblique, sterile	1000	75.9	6 racks of 96	576	6.289 242

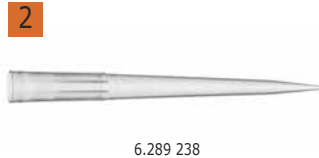

Pipette tips Qualitix®, natural, autoclavable

Socorex

Description	Capacity	Length	Package contents	PK	Cat. No.
	ml	mm			
Macro tips	2	115.5	2 bags of 250	500	9.411 501
Macro tips	2	115.5	30 bags of 250	7500	6.289 245
Macro tips, graduated	5	123.2	2 bags of 250	500	9.411 449 5
Macro tips, graduated	5	123.2	25 bags of 250	6250	6.289 246
Macro tips, graduated	5	123.2	2 racks of 50	100	6.224 893
Macro tips	10	150.0	3 bags of 100	300	9.411 502 4
Macro tips	10	150.0	40 bags of 100	4000	6.289 247



6 Refill system Tipfill, autoclavable

Socorex



Description	Capacity	Package contents	PK	Cat. No.
	µl			
Ultra-microtips, natural, thin, graduated	10	13 inserts of 96	1248	6.289 206
Universal-tips, natural, oblique, graduated	200	10 inserts of 96	960	6.289 221
Universal-tips, natural, thin	1000	5 inserts of 96	480	6.289 234
Empty racks for refill system Tipfill	10 / 200		10	6.289 207
Empty racks for refill system Tipfill	1000		6	6.289 235

Filter tips Qualitix®, natural, sterile

Socorex

Description	Capacity	Length	Package contents	PK	Cat. No.
	µl	mm			
Ultra microtips, thin, graduated	10	31.4	12 racks of 96	1152	6.289 209 7
Microtips, long, thin	10	38.1	10 racks of 96	960	6.289 214 8
Tips, oblique	20	49.6	10 racks of 96	960	6.289 217 9
Tips, oblique	100	49.6	10 racks of 96	960	6.289 218
Universal tips, oblique	200	52.1	10 racks of 96	960	6.289 224
Tips, extra long, thin	200	83.8	6 racks of 96	576	6.289 231 10
Universal tips, thin	1000	88.9	6 racks of 96	576	6.289 237

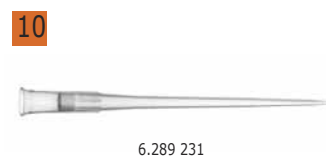

1

1 Pipette tips Optifit

Sartorius Lab Instruments

Optifit tips are designed for best possible fitting and sealing to secure the highest possible accuracy and precision. These pipette tips enable ergonomic and light tip attachment by being compatible with the Optiload feature in Sartorius Picus® NxT, Picus®, eLINE®, mLINE® and Proline® Plus pipettes. While Optifit Tip trays are colour coded for easy matching with a corresponding, colour coded Sartorius pipette, they do also match with most other pipettes due to their universal design. Optifit tips are manufactured in an ISO 8 certified cleanroom environment and are available in various packaging types.

Description	Capacity µl	Length mm	Package contents	PK	Cat. No.
non-sterile	100 - 5000	150,0	1 rack of 50	50	6.206 247
pre-sterilised	100 - 5000	150,0	1 rack of 50	50	6.238 066
non-sterile*	0,5 - 10	242,0	1 box of 100	100	6.205 144
non-sterile	0,5 - 200	51,0	10 racks of 96	960	6.902 461
non-sterile	50 - 1200	71,5	10 racks of 96	960	6.204 651
pre-sterilised	50 - 1200	71,5	10 racks of 96	960	6.251 705
non-sterile	50 - 1200	71,5	Refill Pack, 10 racks of 96	960	6.224 347
pre-sterilised	50 - 1200	71,5	Refill Pack, 10 racks of 96	960	7.658 803
non-sterile	10 - 1000	71,5	10 racks of 96	960	6.226 809
pre-sterilised	10 - 1000	71,5	10 racks of 96	960	6.234 568
non-sterile	10 - 1000	71,5	10 racks of 96	960	6.226 833
pre-sterilised	10 - 1000	71,5	Refill Pack, 10 racks of 96	960	6.259 767
pre-sterilised	10 - 1000	68,5	10 racks of 96	960	6.233 869
non-sterile	50 - 1200	90,0	10 racks of 96	960	6.206 521
non-sterile	5 - 350	54,0	10 racks of 96	960	6.225 217
pre-sterilised	5 - 350	54,0	10 racks of 96	960	6.234 567
non-sterile	5 - 350	54,0	Refill Tower, 10 racks of 96	960	6.239 400
non-sterile	0,1 - 10	31,5	10 racks of 96	960	6.241 795
pre-sterilised	0,1 - 10	31,5	10 racks of 96	960	6.238 320
non-sterile	0,1 - 10	31,5	Refill Tower, 10 racks of 96	960	7.970 516
pre-sterilised	0,1 - 10	31,5	Refill Pack, 20 racks of 96	1920	7.970 541
pre-sterilised	0,5 - 200	51,0	10 racks of 96	960	6.238 319
non-sterile	0,5 - 200	51,0	Refill Tower, 10 racks of 96	960	6.235 565

* Extra long Tip for MidiPlus

2

2 Filter Tips SafetySpace™
Sartorius Lab Instruments

SafetySpace™ Filter Tips leave more space between the sample and the filter than conventional filter tips. This allows pipetting any type of liquid or using any pipetting technique without the risk of the precious sample absorbing into the filter. In effect, this secures 100% sample recovery and thus greater accuracy. Particularly suitable for pipetting foaming liquids such as buffers and proteins, pipetting solvents, multiple dispensing functions of electronic pipettes, reverse pipetting. Certified DNase, RNase and endotoxin free.

Capacity µl	Description	Package contents	Length mm	PK	Cat. No.
0,1 - 10	pre-sterilised	10 racks of 96	31.5	960	6.230 410
0,1 - 10 Extended*	pre-sterilised	10 racks of 96	46	960	6.901 776
0,5 - 20	pre-sterilised	10 racks of 96	51	960	6.227 887
2 - 120	pre-sterilised	10 racks of 96	51	960	6.240 886
5 - 200	pre-sterilised	10 racks of 96	52.5	960	6.233 695
5 - 300	pre-sterilised	10 racks of 96	52.5	960	6.230 069
50 - 1000	pre-sterilised	10 racks of 96	78	960	6.232 435
50 - 1200	pre-sterilised	10 racks of 96	90	960	6.228 053

*with regular air gap



1 Optifit Tips in FlexiBulk Pack

The tips in FlexiBulk packs are of the same high quality as the other Sartorius Optifit Tips available in tip racks and refill packages. Optifit Tips provide the following advantages: *Sartorius Lab Instruments*

- Perfect fit and seal with Sartorius pipettes to ensure the highest possible accuracy and precision
- Ergonomic and light tip attachment and ejection enabled by the Optoload feature in Sartorius Picus® NXT, Picus®, eLINE®, mLINE® and Proline® Plus pipettes
- Compatibility with most other pipette brands
- Materials, including the FlexiBulk PET pack, 100% suitable to be used as energy waste
- Compliance with ISO 9001, ISO 14001 and ISO 13485 quality standards



Description	Capacity	Length	Pack size	PK	Cat. No.
	µl	mm			
Free of RNase, DNase and endotoxins	0.5 - 200	51	1 box of 960	960	7.661 472
Free of RNase, DNase and endotoxins	5 - 350	54	1 box of 960	960	6.288 468
Free of RNase, DNase and endotoxins	10 - 1000	71,5	1 box of 480	480	6.269 234
Free of RNase, DNase and endotoxins	50 - 1200	71,5	1 box of 480	480	6.272 394
non-sterile	0.1 - 10	31,5	1 box of 1000	1000	6.225 481
non-sterile	100 - 5000	150,0	1 box of 100	100	7.607 378
non-sterile	100 - 5000	150,0	1 box of 1000	1000	6.203 851
non-sterile	1000 - 10000	161,0	1 box of 250	250	6.251 309

2 Pipette tips Finntip 10

This tip is specially designed for pipetting micro-sized drops. It is ideal for use with micro volume Finnpiettes. *Thermo Scientific*

Description	Capacity	Package contents	PK	Cat. No.
	µl			
non sterile	0.2 - 10	1 bag of 1000	1000	6.080 908
non sterile	0.2 - 10	10 racks of 96	960	6.084 681
sterile	0.2 - 10	10 racks of 96	960	6.224 231
non sterile	0.2 - 10	4 racks of 192 + 10 refill packs of 192	2688	6.228 718
non sterile	0.2 - 10	20 refill packs of 196	3840	6.228 719



3 Pipette tips Finntip 50

For use with 16-channel pipettes. Will also fit micro volume single channel pipettes, volume 50 µl length 43 mm. *Thermo Scientific*

Description	Capacity	Package contents	PK	Cat. No.
	µl			
non sterile	0.5 - 50	1 bag of 1000	1000	6.301 604
non sterile	0.5 - 50	10 racks of 384	3840	6.301 538
sterile	0.5 - 50	10 racks of 384	3840	9.282 501



4 Pipette tips Finntip 250 Universal

This quality product is ideal for single channel and multichannel Finnpiettes. It was also designed to be used with pipettes from other manufacturers. Finntip universals are also available in refill packs. *Thermo Scientific*

Description	Capacity	Package contents	PK	Cat. No.
	µl			
non sterile	0.5 - 250	1 box of 500	500	6.070 424
non sterile	0.5 - 250	1 bag of 1000	1000	6.092 728
non sterile	0.5 - 250	1 bag of 20,000	20000	6.228 715
non sterile	0.5 - 250	10 racks of 96	960	6.082 633
sterile	0.5 - 250	10 racks of 96	960	6.510 864
non sterile	0.5 - 250	4 racks of 96 + 10 refill packs of 96	1344	6.228 716
non sterile	0.5 - 250	20 refill packs of 96	1920	6.803 185



1

1 Pipette tips Finntip 300

These tips were specially designed for the FinnpiPETTE multichannels (reverse pipetting is possible with the 300µl). The Finntip 300µl is also suitable for single channel pipettes in the 5-300µl range. The packaging options include refill packs.

Thermo Scientific

Description	Capacity µl	Package contents	PK	Cat. No.
non sterile	5 - 300	1000/Bag	1000	6.057 011
non sterile	5 - 300	20.000/Bulk	20000	6.224 235
non sterile	5 - 300	10x96/Rack	960	6.056 947
sterile	5 - 300	10x96/Rack	960	6.084 976
non sterile	5 - 300	10x192/Refill	1920	6.204 184

Further models can be found in our online shop.

2

2 Pipette tips Finntip Flex

The Thermo Scientific Finntip Flex system offers flexible, soft and sophisticated high-end tips for discerning users. Finntip Flex system consisting new-generation tips and easy-to-use operation rack and space-saving refill kit. All elements in the system have been designed to fulfill the most demanding requirements for ergonomics and flexibility in pipetting tasks for today's fast-paced laboratories.

- Low attachment and ejection forces
- High precision molding with virgin polypropylene
- Smooth surface for low liquid retention
- Non-slip rack with hinged cover
- Easy to use and economical refill system

3

3 Pipette tips Finntip Flex 10

Thermo Scientific

Description	Capacity µl	Package contents	PK	Cat. No.
non sterile	0.2 - 10	1 bag of 1000	1000	9.282 510
non sterile	0.2 - 10	10 racks of 96	960	9.282 511
sterile	0.2 - 10	10 racks of 96	960	9.282 512
non sterile	0.2 - 10	1 rack of 96 + 20 refill packs of 96	2016	9.282 513
non sterile	0.2 - 10	20 refill packs of 96	1920	9.282 514

4

9.282 516

Pipette tips Finntip Flex 200

Thermo Scientific

Description	Capacity µl	Package contents	PK	Cat. No.
non sterile	1 - 200	1 bag of 1000	1000	9.282 515
non sterile	1 - 200	10 racks of 96	960	9.282 516 ⁴
sterile	1 - 200	10 racks of 96	960	9.282 517
non sterile	1 - 200	1 rack of 96 + 20 refill packs of 96	2016	9.282 518
non sterile	1 - 200	20 refill packs of 96	1920	9.282 519

5

5 Pipette tips Finntip Flex 300

Thermo Scientific

Description	Capacity µl	Package contents	PK	Cat. No.
non sterile	5 - 300	1 bag of 1000	1000	6.228 755
non sterile	5 - 300	10 racks of 96	960	6.224 234
sterile	5 - 300	10 racks of 96	960	6.228 752
non sterile	5 - 300	1 rack of 96 + 20 refill packs of 96	2016	6.228 753
non sterile	5 - 300	20 refill packs of 96	1920	6.228 754

Pipette tips Finntip Flex 1000

Thermo Scientific

Description	Capacity µl	Package contents	PK	Cat. No.	
non sterile	100 - 1000	1 bag of 1000	1000	6.235 571	
non sterile	100 - 1000	10 racks of 96	960	6.230 775	1
sterile	100 - 1000	10 racks of 96	960	9.282 520	
non sterile	100 - 1000	1 rack of 96 + 16 refill packs of 96	1632	9.282 521	
non sterile	100 - 1000	16 refill packs of 96	1536	9.282 522	

1



6.230 775

Pipette tips Finntip Flex 1200

Thermo Scientific

Description	Capacity µl	Package contents	PK	Cat. No.	
non sterile	50 - 1200	1 bag of 1000	1000	6.228 758	
non sterile	50 - 1200	10 racks of 96	960	6.228 756	2
sterile	50 - 1200	10 racks of 96	960	6.228 757	
non sterile	50 - 1200	1 rack of 96 + 16 refill packs of 96	1632	9.282 523	
non sterile	50 - 1200	16 refill packs of 96	1536	9.282 524	

2



6.228 756

3 Pipette tips Finntip Flex Filter, sterile

Thermo Scientific

Description	Capacity µl	Package contents	PK	Cat. No.	
sterile	0.2 - 10	10 racks of 96	960	9.282 526	
sterile	1 - 30	10 racks of 96	960	9.282 527	
sterile	1 - 100	10 racks of 96	960	9.282 528	
sterile	1 - 200	10 racks of 96	960	9.282 529	
sterile	5 - 300	10 racks of 96	960	9.282 530	
sterile	100 - 1000	10 racks of 96	960	9.282 531	
sterile	50 - 1200	10 racks of 96	960	9.282 532	
sterile	1000 - 10000	1 bag of 50	50	9.282 533	

3



4 Pipette tips Finntip 1000

This mid-size tip comes in several pack sizes. The 10 x 96 rack is available sterile.

Thermo Scientific

Description	Capacity µl	Package contents	PK	Cat. No.	
non sterile	100 - 1000	1 box of 200	200	6.085 561	
non sterile	100 - 1000	1 bag of 1000	1000	6.085 852	
non sterile	100 - 1000	1 bag of 10,000	10000	6.076 481	
non sterile	100 - 1000	10 racks of 96	960	6.802 498	
sterile	100 - 1000	10 racks of 96	960	6.206 884	
non sterile	100 - 1000	5 refill packs of 192	960	6.228 679	

4



5 Pipette tips Finntip 1000 Extended

Tapered to 105mm in length the Finntip 1000 extended allows access to the narrowest container.

Thermo Scientific

Description	Capacity µl	Package contents	PK	Cat. No.	
non sterile	100 - 1000	1 bag of 1000	1000	7.200 433	
non sterile	100 - 1000	5 racks of 96	480	6.224 236	
sterile	100 - 1000	5 racks of 96	480	6.228 676	

5



1

1 Pipette tips Finntip 5ml

Designed to prevent foaming and vortexing, this tip fits into all common sizes of laboratory vessels.

Thermo Scientific

Description	Capacity µl	Package contents	PK	Cat. No.
non sterile	1000 - 5000	1 box of 75	75	6.076 989
non sterile	1000 - 5000	1 bag of 500	500	6.510 003
non sterile	1000 - 5000	1 bag of 3000	3000	6.058 016
non sterile	1000 - 5000	5 racks of 54	270	6.053 602
sterile	1000 - 5000	5 racks of 54	270	6.900 937

2

2 Pipette tips Finntip 10 ml

The Finntip 10 ml was designed to eliminate vortexing and prevent foaming in the sample liquid.

Thermo Scientific

Description	Capacity µl	Package contents	PK	Cat. No.
non sterile	2000 - 10000	1 bag of 40	40	6.051 993
non sterile	2000 - 10000	1 bag of 100	100	6.051 307
non sterile	2000 - 10000	5 racks of 24	120	6.051 881
sterile	2000 - 10000	5 racks of 24	120	6.228 721

3

3 Pipette tips Finntip with Filter Tips

- Volume range 0.2µl-10ml
- Thirteen different models including extended versions
- Filters made from polyethylene, cannot be autoclaved
- Supplied in vacuum sealed sterilized tip racks
- Ideal for PCR and other amplification methods
- Pipetting of radioactive and infectious samples
- Certified free from endotoxin, DNA, DNase, RNase Type

Thermo Scientific

Description	Capacity µl	Length mm	Package contents	PK	Cat. No.
sterile	0.2 - 10	32	10 racks of 96	960	6.224 227
sterile	0.2 - 20	33	10 racks of 384	3840	9.282 544
sterile	0.2 - 50	48	10 racks of 384	3840	6.228 742
sterile	0.5 - 10	52	10 racks of 96	960	6.224 228
sterile	0.5 - 20	52	10 racks of 96	960	6.228 743
sterile	0.5 - 30	52	10 racks of 96	960	6.228 744
sterile	0.5 - 100	52	10 racks of 96	960	6.076 896
sterile	5 - 100	78	10 racks of 96	960	6.228 745
sterile	0.5 - 200	52	10 racks of 96	960	6.224 229
sterile	5 - 200	78	10 racks of 96	960	6.228 746
sterile	5 - 300	52	10 racks of 96	960	6.228 747
sterile	100 - 1000	71	10 racks of 96	960	6.085 289
sterile	100 - 1000	105	5 racks of 96	480	6.228 748
sterile	500 - 5000	147	5 racks of 54	270	6.224 230
sterile	1000 - 10000	15	5 racks of 24	120	6.228 750

4

4 Pipette tips Finntip Wide

With its wide orifice tip, the Finntip Wide was designed especially for pipetting fragile cell suspensions and macromolecules like genomic DNA. This tip eliminates the mechanical shearing that causes cell fragmentation.

Thermo Scientific

Description	Capacity µl	Package contents	PK	Cat. No.
non sterile	10 - 250	1 bag of 1000	1000	9.282 552
non sterile	10 - 250	10 racks of 96	960	9.282 554
sterile	10 - 250	10 racks of 96	960	9.282 555
non sterile	100 - 1000	1 bag of 400	400	6.206 960
non sterile	100 - 1000	1 bag of 6500	6500	6.228 740
non sterile	100 - 1000	10 racks of 96	960	6.089 601
sterile	100 - 1000	10 racks of 96	960	9.282 556

1 MBP Filter Tips, ART™

Manufactured using a special process, tips are furnished with a unique ART™ filter to eliminate any risk of cross-contamination between samples, which is particularly important in molecular biology. They are suitable for applications involving the use of DNA or RNA, as well as radioactive and infectious samples.

Thermo Scientific



- Certified free of RNase, DNase, DNA and pyrogens
- Sterile tips: Sterilised by gamma radiation
- Low Retention tips: Extremely hydrophobic surface for lower retention, superior precision and reproducibility of measurements

Type	Capacity µl	Package contents	Sterile	PK	Cat. No.
Standard	0,1-10	10 racks, 96 each	+	960	6.900 171
ART 10 REACH, extended	0,1-10	10 racks, 96 each	+	960	6.900 172
ART 10, MicroPoint, extended	0,5-10	10 racks, 96 each	+	960	6.801 103
ART 100E, MicroPoint	1-100	10 racks, 96 each	+	960	7.631 281
ART 100, MicroPoint	1-100	10 racks, 96 each	+	960	6.239 836
ART 200, Universal Fit	1-200	10 racks, 96 each	+	960	6.238 196
ART XLP 200, wide bore, REACH, extended	1-200	8 racks, 96 each	+	768	6.238 199
ART XLG, REACH, extended	1-200	8 racks, 96 each	+	768	6.269 284
ART 300, MicroPoint	1-300	10 racks, 96 each	+	960	6.256 423
ART 1000E, Universal Fit	1-1000	8 racks, 100 each	+	800	6.238 197
ART 1000 REACH, wide bore	1-1000	8 racks, 100 each	+	800	7.615 698
ART 1000G, SoftFit, wide bore	1-1000	8 racks, 100 each	+	800	7.658 822
ART 1000, Ergonomie, extended	100-1000	8 racks, 100 each	+	800	7.631 211

2 epT.I.P.S. Set (General Lab Product)



Eppendorf AG

Starter kit, consisting of one epT.I.P.S box filled with tips and 4 reload trays.

This pipette tips are General Lab Products for research purposes.



Colour	Capacity µl	Length mm	Package contents	PK	Cat. No.
anthracite	0.1 - 10	34	1 box with 5 trays of 96	480	6.273 879
grey	0.1 - 20	40	1 box with 5 trays of 96	480	6.273 880
light grey	0.5 - 20	46	1 box with 5 trays of 96	480	4.662 347
yellow	2 - 200	53	1 box with 5 trays of 96	480	6.273 881
orange	20 - 300	55	1 box with 5 trays of 96	480	4.662 348
green	50 - 1250	76	1 box with 5 trays of 96	480	4.662 350
red	500 - 2500	115	1 box with 5 trays of 48	240	4.662 351
blue	50 - 1000	71	1 box with 5 trays of 96	480	4.663 193

Online also available as IVD version.

3 Pipette tips epT.I.P.S. Box (General Lab Product)



Eppendorf AG

- Work box, filled with tips
- autoclavable
- contamination-free refilling system suitable for loading epT.I.P.S reloads

This pipette tips are General Lab Products for research purposes.



Colour	Capacity µl	Length mm	Package contents	PK	Cat. No.
anthracite	0,1 - 10	34	1 box of 96	96	4.662 338
grey	0,1 - 20	40	1 box of 96	96	4.662 339
light grey	0,5 - 20	46	1 box of 96	96	4.662 340
yellow	2 - 200	53	1 box of 96	96	4.662 341
orange	20 - 300	55	1 box of 96	96	4.662 342
blue	50 - 1000	71	1 box of 96	96	4.662 343
green	50 - 1250	76	1 box of 96	96	4.662 344
red	250 - 2500	115	1 box of 48	48	4.662 345
purple	100 - 5000	120	1 box of 24	24	4.662 346

Online also available as IVD version.

1

1 Pipette tips epT.I.P.S. Standard

Eppendorf AG



Original Eppendorf, high quality, pipette tips at an attractive price.

- packed in multi sealable bag
- tips available in various sizes from 10 µl up to 10.000 µl

Colour	Capacity µl	Length mm	Package contents	PK	Cat. No.
anthracite	0.1 - 10	34	2 bags of 500	1000	9.409 410
grey	0.1 - 20	40	2 bags of 500	1000	9.409 411
light grey	0.5 - 20	46	2 bags of 500	1000	9.409 412
yellow	2 - 200	53	2 bags of 500	1000	9.409 413
orange	20 - 300	55	2 bags of 500	1000	9.409 414
blue	50 - 1000	71	2 bags of 500	1000	9.409 415
green	50 - 1250	76	2 bags of 500	1000	9.409 416
dark green	50 - 1250	103	2 bags of 500	1000	6.238 121
red	250 - 2500	115	5 bags of 100	500	9.409 417
purple	100 - 5000	120	5 bags of 100	500	9.409 418
purple	200 - 5000	175	3 bags of 100	300	6.284 714
turquoise	500 - 10000	165	2 bags of 100	200	9.409 403
turquoise	500 - 10000	243	2 bags of 100	200	9.409 404

2

2 epT.I.P.S. Standard, clear

Eppendorf AG



Colour	Capacity µl	Length mm	Package contents	PK	Cat. No.
clear	2 - 200	53	1 pack of 1000	1000	9.409 407
clear	20 - 300	55	1 pack of 1000	1000	9.409 408
clear	50 - 1000	71	1 pack of 1000	1000	9.409 409

3

3 epT.I.P.S. Reloads (General Lab Product)

Eppendorf AG



- Practical refilling system for epT.I.P.S box
- Trays supplied either double-sided or as stack packs, depending on tip size
- Contamination-free transfer to the trays into the work box
- Autoclavable trays are available
- Colour-coded trays for simple identification of the tips.

This pipette tips are General Lab Products for research purposes.

Colour	Capacity µl	Length mm	Package contents	PK	Cat. No.
anthracite	0,1 - 10	34	10 trays of 96	960	4.662 352
grey	0,1 - 20	40	10 trays of 96	960	4.662 353
light grey	0,5 - 20	46	10 trays of 96	960	4.662 354
yellow	2 - 200	53	10 trays of 96	960	4.662 355
orange	20 - 300	55	10 trays of 96	960	4.662 356
blue	50 - 1000	71	10 trays of 96	960	4.662 357
green	50 - 1250	76	10 trays of 96	960	4.662 358
red	500 - 2000	115	10 trays of 96	480	4.662 359

Online also available as IVD version.

1 epT.I.P.S. Reloads (General Lab Product)



Eppendorf AG

- practical refilling system for epT.I.P.S. Box
- workbox with tips
- autoclavable
- PCR quality
- certified free from human DNA, DNase, RNase and PCR inhibitor



This pipette tips are General Lab Products for research purposes.

Colour	Capacity µl	Length mm	Package contents	PK	Cat. No.
anthracite	0,1 - 10	34	10 trays of 96	960	4.662 363
grey	0,1 - 20	40	10 trays of 96	960	4.662 364
light grey	0,5 - 20	46	10 trays of 96	960	4.662 365
yellow	2 - 200	53	10 trays of 96	960	4.662 366
orange	20 - 300	55	10 trays of 96	960	4.662 367
blue	50 - 1000	71	10 trays of 96	960	4.662 368
green	50 - 1250	76	10 trays of 96	960	4.662 369
dark green	50 - 1250	103	10 trays of 96	960	4.662 361
red	500 - 2500	115	10 trays of 48	480	4.662 370

Online also available as IVD version.

2 epT.I.P.S. Racks, Biopur® (General Lab Product)

Highest biological purity Eppendorf Biopur pipette tips (sterile, pyrogen-, RNase-, DNA-, ATP-free)

Eppendorf AG

- Batch controlled
- Batch specific certificate available on request
- Individually boxed racks, 5 Boxes per pack

This pipette tips are General Lab Products for research purposes.

Colour	Capacity µl	Length mm	Package contents	PK	Cat. No.
yellow	2 - 200	53	5 racks of 96	480	4.671 448
orange	20 - 300	55	5 racks of 96	480	4.662 373
violet	100 - 5000	120	5 racks of 24	120	4.671 454
violet	200 - 5000	175	5 racks of 24	120	4.662 380
turquoise	500 - 10000	165	5 racks of 24	120	4.671 456

Online also available as IVD version.



3 4 epT.I.P.S. Dualfilter tips

- Pipette tips boxed in racks with integral, twin-layer ep Dualfilter made from hydrophobic polyethylene without additives. One layer protects the user against aerosols, the other against airborne microbes

Eppendorf AG

- All tips are **sterile, pyrogen-free** and **PCR clean** (free from human DNA, DNase, RNase, PCR Inhibitors)
- Batch specific certificate available on request
- The filter doesn't retain liquid when accidentally wetted during aspiration, the whole sample can be recovered easily

Colour	Capacity µl	Length mm	Package contents	PK	Cat. No.
anthracite	0.1 - 10	34	10 racks of 96	960	6.315 154
mid grey	0.1 - 10	40	10 racks of 96	960	6.314 721
light grey	0.5 - 20	46	10 racks of 96	960	6.315 065
yellow	2 - 20	53	10 racks of 96	960	6.315 155
yellow	2 - 100	53	10 racks of 96	960	6.314 988
yellow	2 - 200	55	10 racks of 96	960	6.314 811
orange	20 - 300	55	10 racks of 96	960	6.315 156
blue	50 - 1000	76	10 racks of 96	960	4.678 130
dark green	50 - 1250	103	5 racks of 96	480	6.314 733
purple	100 - 5000	120	5 racks of 24	120	4.674 945
purple	200 - 5000	175	5 racks of 24	120	6.314 551
turquoise	1000 - 10000	243	100 tips, single packed	100	9.409 406



1

2

1 2 Pipette tips epT.I.P.S. LoRetention



Eppendorf AG

Ideally suited for all applications with samples that contain detergents:

- PCR and real-time PCR preparation of enzyme solutions and master mixes
- Isolation, purification and denaturation of proteins
- Restriction digestions and ligations
- Pipetting DNA ladders during gel electrophoresis

Features:

- Ultrahomogeneous surface for maximum reproducibility
- Ultrahydrophobic surface for minimum loss of sample
- Air bubbles and foaming are significantly reduced during pipetting
- Autoclavable, high chemical resistance - 5 year shelf life

Simple differentiation of racks and reloads through a new, clear lid with a white seal. When open, the text **LoRetention** can be seen from the inside. The reusable seal makes it also possible to label existing ep T.I.P.S. boxes.

Pipette tips epT.I.P.S. LoRetention Dual Filter, racks

PCR clean, sterile, pyrogen-free.

Eppendorf AG

Capacity µl	Length mm	Package contents	PK	Cat. No.
2 - 100	53	10 racks of 96	960	4.671 478
20 - 300	55	10 racks of 96	960	4.671 480
50 - 1000	76	10 racks of 96	960	9.409 429

3

3 Pipette Tips epT.I.P.S.® LoRetention, Set

Sets, consisting of one epT.I.P.S box filled with tips and 4 reload trays.

Eppendorf AG

Colour	Capacity µl	Length mm	Package contents	PK	Cat. No.
dark grey	0.1 - 10	34	1 box with 5 trays of 96	480	9.409 520
light grey	0.5 - 20	46	1 box with 5 trays of 96	480	9.409 521
yellow	2 - 200	53	1 box with 5 trays of 96	480	9.409 522
blue	50 - 1000	71	1 box with 5 trays of 96	480	9.409 523

Pipette tips epT.I.P.S. LoRetention, Reloads

10 x 96 tips.

Eppendorf AG

Type	Length mm	Package contents	PK	Cat. No.
0.1 - 10	34	10 trays of 96	960	9.409 495
0.5 - 20	46	10 trays of 96	960	9.409 496
2 - 200	59	10 trays of 96	960	9.409 497
50 - 1000	76	10 trays of 96	960	9.409 498

Pipette tips epT.I.P.S. LoRetention, Reloads PCR clean

PCR clean, sterile, pyrogen-free. 10 x 96 tips.

Eppendorf AG

Capacity µl	Length mm	Package contents	PK	Cat. No.
0.1 - 10	34	10 trays of 96	960	9.409 490
0.5 - 20	46	10 trays of 96	960	9.409 491
2 - 200	59	10 trays of 96	960	9.409 492
50 - 1000	76	10 trays of 96	960	9.409 493

Robotic Tips blackKnights

Due to an increased level of automation within pipetting processes there is a growing demand for high-quality consumables. With blackKnights robotic tips even smallest volumes can be pipetted precisely and without contamination. Conductive robotic tips are used to recognize the liquid level automatically, therefore the tips dip into the liquid only as far as necessary for a secure pipetting and dispensing.

- Material: virgin polypropylene
- Packed in racks, blister packs or in a PE-bag
- Volumes: 10, 50, 200, 300, 1000, 1100, 1200 and 1300 µl
- High compatibility

Depending on the type of robotic tips, they are compatible with the following robotic systems:

Type Tecan®: Tecan: Genesis, Freedom EVO, MiniPrep, Cavo/Qiagen/Corbett: CAS1200/4200/4800, QIAgility/PerkinElmer: Multiprobe II, Janus (with Multiprobe-head), only tips without filter/Abbott Diagnostic: m2000#
Type Qiagen®: Abbott Diagnostic: en4lisa/bioMerieux: DaVinci/Bio-Rad: Evolis/Biotest: QuickStep/Dade Behring (Siemens): BEP 2000 Advance/DiaSorin: ETI-Max 3000/Diffchamb: T4U/Euroimmun: Euroimmun Analyzer/Grifols: Triturus/Human: Elisys Quattro/Qiagen: Biorobot 3000, 8000, 9600, 9604, Biorobot universal/Stratec: Gemini/Virion: Immunomat TWINsystem

Typ Hamilton®: Hamilton Microlab Star™, Nimbus®, Vantage™

Typ Dynex®: Dynex DSX, Dynex DS2

Typ Olympus®: Beckman Coulter: AutoMate 1250/2550/Olympus: OLA 2500

Ritter

1



6.283 762

2



6.283 784

Capacity µl	Package contents	Description	For	PK	Cat. No.
10	180 racks of 96	in Dual-Pack	Tecan®	17280	6.283 766
10	24 racks of 96	in blister-2	Tecan®	2304	6.285 843
50	180 racks of 96	in Dual-Pack	Tecan®	17280	6.283 768
50	24 racks of 96	in blister-2	Tecan®	2304	6.285 844
50	24 racks of 96	in blister-2, sterile with filter	Tecan®	2304	6.290 645
200	180 racks of 96	in Dual-Pack	Tecan®	17280	6.283 770
200	24 racks of 96	in blister-2, sterile with filter	Tecan®	2304	6.290 651
1000	100 racks of 96	in Dual-Pack	Tecan®	9600	6.283 773
300	180 racks of 96	in Dual-Pack	Qiagen®	17280	6.283 762 1
300	10 bags of 960	in PE bag	Qiagen®	9600	6.283 763
1100	100 racks of 96	in Dual-Pack	Qiagen®	9600	6.283 764
1100	5 bags of 960	in PE bag	Qiagen®	4800	6.283 765
10	80 racks of 96	in blister-5	Hamilton®	7680	6.283 775
50	80 racks of 96	in blister-5	Hamilton®	7680	6.283 777
50	80 racks of 96	in blister-5, with filter	Hamilton®	7680	6.290 652
300	80 racks of 96	in blister-5, with filter	Hamilton®	7680	6.290 653
300	80 racks of 96	in blister-5	Hamilton®	7680	6.283 779
1000	80 racks of 96	in blister-5	Hamilton®	4800	6.283 781
1000	80 racks of 96	in blister-5, with filter	Hamilton®	4800	6.290 654
300	72 racks of 108	blue Sample Tips in rack*	Dynex®	7776	6.283 783
1300	72 racks of 108	clear Reagent Tips in rack*	Dynex®	7776	6.283 784 2
1200	8 racks of 140	in rack	Olympus®	1120	9.409 558

*non-conductive

Tecan is a registered trademark of Tecan AG.

Qiagen is a registered trademark of Qiagen GmbH.

Olympus is a registered trademark of Olympus GmbH.

DSX and DS2 are registered trademarks of Dynex Technologies.

MagNA Pure is a registered trademark of Roche.

Microlab Star, Nimbus and Vantage are registered trademarks of Hamilton AG.

3 Storage system "MultiStore"

- White, made of highly impact resistant plastic. Tilt bins made of crystal clear PS.
- for small components and accessories e.g. in industries, hospitals and laboratories
 - dust-free and clean storage of contents
 - multifunctional for individual storage solutions

3



Description	External dimensions (W x D x H) mm	Dimensions* (W x D x H) mm	PK	Cat. No.
4 tilt bins	601 x 171,5 x 206	125,5 x 128 x 133,5	1	9.301 553
3 tilt bins	601 x 198 x 238	176 x 149 x 161	1	9.301 554
2 tilt bins	601 x 310,5 x 353	265 x 221 x 241	1	9.301 555

*Dimensions of each single tilt bin

Pipettes/Pipette tips-Reagent Reservoirs

1

1 Workstation Dispensing Bin for Pipette tips

Crystal-clear bins let you see your small items inventory. See inventory levels of pipette tips, tubes, fittings, finger cots, and other bulk small items at a glance. Flip-top covers on generous openings make filling and dispensing easy and keep products dust-free. 4 sizes available to cater to a wide variety of storage needs. With non-skid rubber feet.

Heathrow Scientific

Description	External dimensions (W x D x H) mm	PK	Cat. No.
1 compartment	180 x 175 x 235	1	6.243 164
2 compartments	139 x 160 x 368	1	6.224 367
3 compartments	210 x 155 x 212	1	6.224 368
4 compartments	278 x 158 x 217	1	6.243 165

2

2 Dispensing bins

- Nonskid rubber feet
- Pre-drilled holes for wall mounting
- Mounting screws included
- Green bin includes a removable divider

Heathrow Scientific

Colour	Dimensions (W x D x H) mm	PK	Cat. No.
Neon green	180 x 155 x 165	1	6.243 700
Neon blue	155 x 155 x 170	1	6.290 709

3

3 LLG-Disposable Reagent reservoirs economy, PS

Made from polystyrol. Designed for use with multi-channel pipettes and can accommodate up to 12-channel standard pipettes. Angled sides and a V-shaped bottom allow maximum recovery of reagents. All reservoirs have internal graduated volume lines and pour-spouts on the corners. 25 ml or 50 ml versions. Available as sterile and non-sterile versions.

- DNase-, RNase- and pyrogen-free certified

Description	Capacity ml	PK	Cat. No.
non-sterile, bulk	25	100	6.282 144
sterile, single packed	25	100	6.282 145
non-sterile, bulk	50	100	6.282 146
sterile, single packed	50	100	6.282 147

4

4 Reagent Reservoirs

Disposable Reagent Reservoirs with a V-shaped bottom to ensure that all the reagent is accessible and can be easily aspirated. Thick wall construction and wide base adds stability and durability making the reservoir easy to handle without product deformation.

Heathrow Scientific

- Graduation markings allow for measurement of the liquid
- With pour-off spouts on all corners
- Stackable, with nesting system for easy separation
- Sterile versions are sealed in bags, electron beam sterilised and Dnase, Rnase and pyrogen-free
- Quality certificate available on request

Capacity ml	Description	Package contents	PK	Cat. No.
5	PS, white, sterile	50 bags of 1	50	4.666 436
10	PS, white, non-sterile	1 bag of 100	100	4.666 437
10	PS, white, sterile	100 bags of 1	100	4.666 438
25	PS, white, sterile	40 bags of 5	200	4.666 439
25	PS, white, sterile	100 bags of 1	100	4.666 440
25	PS, white, non-sterile	1 bag of 100	100	4.666 441
50	PS, white, sterile	40 bags of 5	200	4.666 442
50	PS, white, sterile	100 bags of 1	100	4.666 443
50	PS, white, non-sterile	1 bag of 100	100	4.666 444
55	PS, white, sterile	100 bags of 1	100	4.667 980
55	PS, white, non-sterile	1 bag of 100	100	4.667 915
100	PS, white, sterile	40 bags of 5	200	4.666 447
100	PS, white, sterile	100 bags of 1	100	4.666 448
100	PS, white, non-sterile	1 bag of 100	100	4.666 449
50	PVC, transparent, sterile	20 bags of 5	100	4.666 445
50	PVC, transparent, non-sterile	1 bag of 100	100	4.666 446
55	PVC, transparent, non-sterile	1 bag of 100	100	4.667 913
100	PVC, transparent, non-sterile	1 bag of 100	100	4.666 450
25	PS, white, sterile, divided in 10 and 15 ml	40 bags of 5	200	4.666 451
25	PS, white, sterile, divided in 10 and 15 ml	100 bags of 1	100	4.666 452

1 Reagent Reservoir Coolers

Ice-free, non-toxic way to extend working period for temperature sensitive reagents. Suitable for Heathrow Scientific 50, 55 or 100 ml reservoirs.

Heathrow Scientific

- Reagents are kept at less than 5 °C for approximately 3 hours
- Ice-free solution eliminates the risk of contamination from ice baths
- Non-toxic blend of water and bacteriostatic agent chills and freezes quickly
- Leak-free due to sonic welded polypropylene
- Not intended for autoclave, do not use with liquid nitrogen
- Stackable
- 2 year warranty

Capacity ml	Colour	PK	Cat. No.
55	purple	2	6.292 150
55	blue	2	6.292 151
55	1 x purple + 1 x blue	2	6.292 152
100	purple	2	6.292 153
100	blue	2	6.292 154
100	1 x purple + 1 x blue	2	6.292 155

1



2 Reagent Reservoirs Matrix™, PS, sterile

Sterile trough-shaped reservoirs with pour-off spouts on all 4 corners. With graduations on inside wall.

Thermo Scientific

Capacity ml	Description	PK	Cat. No.
25	without divider, in bags of 10	100	6.254 234
25	without divider, single packed	50	6.255 755
25	with divider, in bags of 10	100	6.254 233
25	with divider, single packed	50	6.253 543
100	without divider, single packed	50	6.255 754

2



3 Multichannel pipette reservoir



BRAND

PP. Translucent. Maximum filling volume 60ml. Suitable for multichannel pipettes with 8 or 12 channels. Autoclavable (121 °C).

Description	PK	Cat. No.
non-sterile, with lid	10	9.280 131
sterile, without lid (single packed)	100	9.280 132
sterile, without lid (in bags with 5 pieces)	200	9.280 133

3



1



1 Manual Serial Dispenser LLG-uniDISPENS pro

The **ergonomically designed** manual dispenser LLG-uniDISPENS pro enables single-handed volume selection, loading and dispensing. Due to its lightweight design, it is ideally suited for serial dosing. You can flexibly select your desired dosing volume from **120 dosing programs** for 12 tip sizes and with 10 stroke adjustments. You can view all settings and volumes at a single glance through the viewing window of the manual dispenser. The dispenser is **compatible with Ritips® from Ritter, PD-Tips® from Brand, Combitips® and Combitips advanced® from Eppendorf™**. Thanks to a purely mechanical, maintenance-free construction, the manual dispenser is a practical and convenient device for daily laboratory use. **Dosing volume 1 µl to 5500 µl.**

Scope of supply: Dispenser, adapter for 25 ml tips, 3 years warranty

Description	PK	Cat. No.
LLG-uniDISPENS pro	1	9.284 239

Accessories for manual serial dispenser

Spare adapter for 25 and 50 ml Tips, for LLG-uniDISPENS, LLG-uniDISPENS pro, manual step dispenser ripette®, dispenser tips Ritips®, dispenser tips Ritips® evolution.

Description	PK	Cat. No.
Spare adapter for 50 ml	1	6.310 548

2



2 Manual step dispenser, ripette®

Ritter ripette® is a very comfortable device for hand dispensing of long series. Ritter

A special technical mechanism guarantees the precision of all selected dosage volumes: 1 to 5000µl.

Product advantages:

- Chart with dosage setting volumes incorporated into each dispenser.
- Lightweight (approx. 100g)
- Easy-to-use adjustment dial for the selection of dosage volume and the number of steps
- No mechanical parts that wear out, no maintenance

Dispenser tips ritips® 25ml and 50ml cannot be used without adapter (Adapter included in delivery).

Description	PK	Cat. No.
ripette® with 25/50 ml adapter	1	9.284 190

We can **supply** this
manufacturer's
whole
product range !



1 Dispenser Tips Ritips® Evolution

Universal dispenser tips for a variety of steppers. The nine tip sizes are equipped with colour-coded adapters for faster identification.

- Easy, high-precision work even in the low µl range
- Suitable for viscous, infectious and volatile liquids due to direct displacement method
- Tips individually and mechanically tested for safe and repeatable application
- Available in standard and bioclean® quality (individually wrapped and sterile)
- bioclean® label is certified by accredited laboratories and means sterilized, pyrogen-, ATP-, RNase- and DNA-free
- A batch certificate is available on request
- Lot number on each box

Suitable for Ripette®, Ripette® pro, Ripette® genX (Ritter), eLine™ Dispenser (Sartorius), Multipette® 4780, Multipette® plus (Eppendorf), Minilab 100, Minilab 101, Minilab 201, Distriman®(Gilson), StepMate, EasyStep, EasyStep electronic, RepeatOne®(Starlab), Handrop, HandyStep®, HandyStep® S, HandyStep® electronic (Brand).

**Please note: Dispenser tips 25 ml and 50 ml cannot be used without adapter.
If necessary, please order Cat. No. 6.310 203 or 6.310 548 separately.**

Type	PK	Cat. No.
0.1 ml / standard	100	6.291 326
0.2 ml / standard	100	6.291 327
0.5 ml / standard	100	6.291 328
1.0 ml / standard	100	6.291 329
2.5 ml / standard	100	6.291 330
5.0 ml / standard	100	6.291 331
10.0 ml / standard	100	6.291 332
25.0 ml / standard	25	6.291 333
50.0 ml / standard	25	6.291 334
0.1 ml / bioclean® sterile	100	6.291 335
0.2 ml / bioclean® sterile	100	6.291 336
0.5 ml / bioclean® sterile	100	6.291 337
1.0 ml / bioclean® sterile	100	6.291 338
2.5 ml / bioclean® sterile	100	6.291 339
5.0 ml / bioclean® sterile	100	6.291 340
10.0 ml / bioclean® sterile	100	6.291 341
25.0 ml / bioclean® sterile	25	6.291 342
50.0 ml / bioclean® sterile	25	6.291 343



Dispenser tips, Ritips®

- 8 sizes, standard and bioclean® (sterile).
- Maximum of safety and repeatability as all tips are individually and mechanically tested.
- Guaranteed purity under the logo bioclean® is tested and confirmed by independent testing laboratories. Ritter bioclean® stands for sterile, pyrogen-free, DNA-, RNase- and ATP-free.
- A quality certificate per lot can be obtained upon request.

Suitable for use together with Ritter ripette®, Multipette® 4780, HandyStep®, Minilab 100/101, Stepmate, EasyStep, Distriman® and HandyStep® electronic.

**Please note: Dispenser tips Ritips® 25 ml and 50 ml cannot be used without adapter.
If necessary, please order Cat.-No. 6.310 203 or 6.310 548 separately.**

Type	PK	Cat. No.
0.05 ml / standard	100	6.265 688 2
0.5 ml / standard	100	4.663 307
1.25 ml / standard	100	6.265 689 3
2.5 ml / standard	100	4.663 308
5.0 ml / standard	100	4.663 309
12.5 ml / standard	100	9.284 225 4
25.0 ml / standard	25	6.310 204
50.0 ml / standard	25	4.663 310
0.05 ml / bioclean® sterile	100	6.290 742
0,5 ml / bioclean® steril	100	6.310 600
1.25 ml / bioclean® sterile	100	6.265 691
2.5 ml / bioclean® steril	100	4.663 311
5.0 ml / bioclean® steril	100	4.663 312
12.5 ml / bioclean® sterile	100	6.288 768
25.0 ml / bioclean® steril	25	4.663 313
50.0 ml / bioclean® steril	25	4.663 314

Ritter

2



6.265 688

3



6.265 689

4



9.284 225



1

1 Manual repetitive pipette HandyStep® S

HandyStep® S - the repetitive pipette for any occasion!

BRAND

Ideal for routine or research applications in diagnostics, molecular biology, environmental analysis, and many more. HandyStep® S and PD-tips work on the direct displacement principle. This offers the highest-precision dispensing of liquid media with high viscosity, high density, or high vapor pressure. Direct displacement permits contamination-free operation, since no aerosols are formed.

More data and facts:

- increased chemical resistance through innovative plastic materials
- easy tip mounting - PD-tip is now simply inserted from below
- dispensed volume range from 2 µl to 5ml
- up to 49 dispensing steps
- weighs only 108g
- suitable for use with BRAND PD-tips, Encode™ tips, Repet tips, Combitips®, Combitips® plus and other compatible dispenser tips
- CE- IVD -compliant

Items supplied

HandyStep® S, DE-M marking, with serial number, performance certificate, operating manual, shelf/rack mount, 3 PD-Tips: 0.1ml, 1ml and 10ml.

Type	PK	Cat. No.
HandyStep® S incl. rack holder	1	9.280 944
Rack holder for HandyStep® S	1	9.280 945



2

Repetitive pipette HandyStep® touch/HandyStep® touch S

Repetitive pipette with colour touch display and automatic tip size recognition.

BRAND

The automatic tip size recognition of the PD-Tips II, with patented coding on the piston, automatically displays the tip size after inserting the tip. By inserting a new PD-tip of the same size, all instrument settings are maintained.

HandyStep® touch with the standard modes Multi-Dispensing, Auto-Dispensing, Pipetting and Favorites
HandyStep® touch S with the additional functions Sequential Dispensing, Multi-Aspiration and Titration

- Touchscreen operation with intuitive menu navigation and integrated help function
- Important functions and parameters visible at a glance
- Automatic tip ejection by the press of a button
- Ergonomically arranged STEP button
- Variable volume adjustment from 1.0 µl to 50 ml
- USB-C connection for quick charging by cable
- Inductive charging with optional charging stand
- Compatible third party tips can also be used

9.284 015



3

Scope of supply: Repetitive pipette, includes universal AC adapter (for Europe, UK, USA, Japan, Australia and New Zealand), shelf/rack mount, sample PD-Tips II, operating manual, performance certificate

9.284 016

Type	PK	Cat. No.
HandyStep® touch	1	9.284 015 2
HandyStep® touch S	1	9.284 016 3



4

Accessories for repetitive pipette HandyStep® touch/HandyStep® touch S

BRAND

9.284 065

Description	PK	Cat. No.
Charging stand without universal AC adapter	1	9.284 065 4
Support stand	1	9.284 066
Universal AC adapter	1	9.284 067
Shelf / rack mount	1	9.284 068
Spare battery	1	9.284 069

1 Dispenser tips, PD-Tips II

Thanks to patented size coding, HandyStep® touch, HandyStep® touch S, HandyStep® electronic, Gilson® Repetman® and Rainin AutoRep™ E automatically detect the tip volume. The tips are also compatible with all other instruments of the HandyStep® family and with repetitive pipettes from other manufacturers.

BRAND

- Cylinder: PP/piston: HDPE, 0.1 ml piston: LCP
- Volumes from 0.1 ml to 50 ml
- Available in BIO-CERT® quality (free of DNA, RNase, endotoxins and ATP)
- Comply with the requirements of ISO 8655
- Supplied with batch certificate
- Adapter for sizes 25 ml and 50 ml included
- PD-Tips II cannot be autoclaved; the adapters are autoclavable



Nominal capacity ml	Description	Sterile	PK	Cat. No.
0.10	bulk	-	100	9.280 950
0.50	bulk	-	100	9.280 951
1.00	bulk	-	100	9.280 952
1.25	bulk	-	100	9.280 953
2.50	bulk	-	100	9.280 954
5.00	bulk	-	100	9.280 955
10.00	bulk	-	100	9.280 956
12.50	bulk	-	100	9.280 957
25.00	bulk	-	50	9.280 958
50.00	bulk	-	25	9.280 959
0.10	BIO-CERT®, individually wrapped	+	100	9.280 960
0.50	BIO-CERT®, individually wrapped	+	100	9.280 961
1.00	BIO-CERT®, individually wrapped	+	100	9.280 962
1.25	BIO-CERT®, individually wrapped	+	100	9.280 963
2.50	BIO-CERT®, individually wrapped	+	100	9.280 964
5.00	BIO-CERT®, individually wrapped	+	100	9.280 965
10.00	BIO-CERT®, individually wrapped	+	100	9.280 966
12.50	BIO-CERT®, individually wrapped	+	100	9.280 967
25.00	BIO-CERT®, individually wrapped, incl. adapter	+	25	9.280 968
50.00	BIO-CERT®, individually wrapped, incl. adapter	+	25	9.280 969
	Set PD-Tips II, 20 pcs. of each size 0,5, 1, 1,25, 2,5, 5, 10 and 12,5 ml, bulk	-	140	9.280 949

2 Pipettors, positive displacement, variable, repeating, Stepper™ 416

NEW

Highly comfortable pipette, intended for reliable repeat dispensing from 10 to 5000 µl. Unique trigger action mechanism eliminates thumb fatigue. Selected materials ensure reliability in use, day after day. Compact shape greatly limits internal instrument contamination. Wide selection between 53 different volumes; up to 73 doses per filling. Two-year warranty.

Socorex

- 4-finger activation
- Setting knobs bear clear indication of volumes and number of aliquots
- Three positive displacement syringes, colour coded
- Self-locking mechanism
- Clear setting indication



Description	PK	Cat. No.
Stepper™ 416 supplied with colour-coded adjustment knobs, adapter, samples of Ecostep syringes	1	4.678 370

3 Syringe tips, Ecostep for Stepper™ 411/416

Individually wrapped sterile, or loose-packed non-sterile.

Socorex

Bioproof: Sterilized syringes are DNase-, RNase- and pyrogen-free certified.

Type	Capacity µl	Capacity	PK	Cat. No.
Non-sterile	10 - 100	0.75	100	9.411 509
Non-sterile	50 - 500	3.75	100	9.411 511
Non-sterile	500 - 5000	37.5	100	9.411 513
Sterile	10 - 100	0.75	50	9.411 578
Sterile	50 - 500	3.75	50	9.411 579
Sterile	500 - 5000	37.5	50	9.411 580



1

1 Dispensers Multipette® M4

On the Multipette®/Combitip system, volumes are dispensed using the positive displacement principle. The liquid is directly dispensed without an air cushion, ensuring the correct volume is always dispensed regardless of the density and viscosity of the liquid. In addition to serial dispensing, the Multipette is also the perfect instrument that is able to go beyond the limitations of a standard pipette.

Eppendorf AG

- Light and ergonomic
- Stress-free work via integrated step counter: dispensing procedures can be continued error-free after an interruption or distraction
- Central Combitip ejector: fully emptied Combitip can be easily ejected with one hand using the operating lever
- Step counter: Displays the number of executed dispensing steps
- Only suitable with Eppendorf Combitips advanced
- Combitip sensor: Automatic Combitip recognition and volume display

Applications

- Repetitive Dispensing of volumes in long series such as plate filling or when aliquoting
- Contamination-free dispensing of toxic, radioactive and or other hazardous liquids
- Precise and accurate dispensing of viscous solutions (e.g. glycerol) or liquids with high vapor pressure (e.g. ethanol)

Type	PK	Cat. No.
Multipette® M4 incl. holder	1	9.283 604
Multipette® M4 Starter Kit, incl. Combitip Rack and Combitip Assortmentpack 1µl - 10ml	1	9.283 681

2

2 Dispensers Multipette® E3 and Multipette® E3x

The new generation of Multipette®, E3 and E3x, exhibit an enlarged color-display and have an intuitive and user-friendly software. No multiple assignment of keys. The Multipette® E3x has a new aspirate and dispensing feature which allows uptake and volume calculation of an unknown volume with immediate dispense in desired partial volumes. In addition to this, up to 225 different parameter settings can be stored saving programming time for routine applications. A new sleep mode saves energy when the Multipette® E3x is not used.

Eppendorf AG

Applications

- Dispensing volumes in long series
- Electronic dispensing with memory functions
- Contamination-free dispensing using positive displacement principle
- Ideal for viscous solutions (e.g. glycerol, oil) or liquids with high vapour pressure (e.g. acetone, ethanol)

Product features, Multipette® E3 and E3x

- Dispensing and pipetting according to positive displacement principle
- Automatic dispensing
- Eight different speed levels for different applications
- One-button tip ejector
- Li-Ion battery
- Selection wheel
- Automatic Combitip® plus tip recognition
- Volume range from 1µl to 50ml
- Charging possible whilst in use
- incl. charging adapter (100-240V), Multipette® E3/E3x Bundle, additionally with charge stand

Additional Multipette® E3x features:

- Aspirate (pipetting of supernatants)
- Titrate
- Sequential dispensing
- Combined aspiration and dispensing mode

E3 Basic and E3x Basic: only available in exchange for a defective electronic hand dispenser.

Type	PK	Cat. No.
Multipette® E3*	1	9.283 687
Multipette® E3x*	1	9.283 688
Multipette® E3 Bundle*	1	9.283 691
Multipette® E3x Bundle*	1	9.283 692

incl. 2 Combitips advanced assortment packs

1 Pipette tips, Eppendorf Combitips advanced®

For viscous liquids up to 200 mPa*s and high vapour pressure, e.g. ethanol and acetone.

Eppendorf AG

- Colour coded with 1 colour ring
- Continuous volume scale
- Automatic tip recognition in Multipette® 4780, Multipette® plus, Multipette® stream and Xstream



Type	Capacity ml	Colour code	PK	Cat. No.
Combitips advanced®	0.1	white	100	9.283 135
Combitips advanced®	0.2	light blue	100	9.283 136
Combitips advanced®	0.5	purple	100	9.283 137
Combitips advanced®	1.0	yellow	100	9.283 138
Combitips advanced®	2.5	green	100	9.283 139
Combitips advanced®	5.0	blue	100	9.283 140
Combitips advanced®	10.0	orange	100	9.283 141
Combitips advanced®	25.0	red	100	9.283 142
Combitips advanced®	50.0	light grey	100	9.283 143
Combitips advanced®, PCR clean	0.1	white	100	9.283 144
Combitips advanced®, PCR clean	0.2	light blue	100	9.283 145
Combitips advanced®, PCR clean	0.5	purple	100	9.283 146
Combitips advanced®, PCR clean	1.0	yellow	100	9.283 147
Combitips advanced®, PCR clean	2.5	green	100	9.283 148
Combitips advanced®, PCR clean	5.0	blue	100	9.283 149
Combitips advanced®, PCR clean	10.0	orange	100	9.283 150
Combitips advanced®, PCR clean	25.0	red	100	9.283 151
Combitips advanced®, PCR clean	50.0	light grey	100	9.283 152
Combitips advanced® Biopur®	0.1	white	100	9.283 153
Combitips advanced® Biopur®	0.2	light blue	100	9.283 154
Combitips advanced® Biopur®	0.5	purple	100	9.283 155
Combitips advanced® Biopur®	1.0	yellow	100	9.283 156
Combitips advanced® Biopur®	2.5	green	100	9.283 157
Combitips advanced® Biopur®	5.0	blue	100	9.283 158
Combitips advanced® Biopur®	10.0	orange	100	9.283 159
Combitips advanced® Biopur®	25.0	red	100	9.283 160
Combitips advanced® Biopur®	50.0	light grey	100	9.283 161
Combitips advanced® Forensic DNA Grade	1.0	yellow	100	6.287 822
Combitips advanced® Forensic DNA Grade	2.5	green	100	6.287 823
Combitips advanced® Forensic DNA Grade	5.0	blue	100	6.287 824
Combitips advanced® Assortment pack			1	9.283 167

(1pc. of each size plus each 1pc. 25ml and 50ml adapter)

2 Accessories for Pipette tips, Eppendorf Combitips advanced®

Eppendorf AG

Type	Capacity ml	Colour code	PK	Cat. No.
advanced® Adapter	25	red	1	9.283 162
advanced® Adapter	50	light grey	1	9.283 163
advanced® Adapter biopur®	25	red	7	9.283 164
advanced® Adapter biopur®	50	light grey	7	9.283 165
advanced® Rack for 8 Combitips			1	9.283 166



3 Pipette Tips, Eppendorf ViscoTip®

For highly viscous liquids from 200 to 14.000 mPa*s, e.g. glycerol, Tween 20, honey or oils.

Eppendorf AG

- 2 colour coded rings
- Continuous volume scale
- Automatic tip recognition in Multipette M4/E3(x)



Type	Capacity ml	Colour code	PK	Cat. No.
ViscoTip®	10	orange	100	9.283 134

1



1 Self-filling laboratory syringes Dosys™

Socorex



- Optimal hand balance and ergonomics
- Fast and reliable volume setting
- Excellent reproducibility
- Plunger tightness without O-ring
- High chemical resistance
- Fully autoclavable at 121°C/250°F
- Self-refilling automatic

Dosys™ basic 162/172

- Fill-by-fill (automatic) through needle or cannula
- Supplied without valve system
- Luer Lock nozzle

Package includes syringe, PVC protection sleeve and operating instructions.

Dosys™ classic 163/173

- Integrated valve system
- Luer Lock nozzle

Package includes syringe, one meter silicone feed tube, sinker, PVC protection sleeve, aspiration and vent cannulas, set of spare for valve, operating instructions.

Dosys™ premium 164/174

- Detachable valve system
- Enhanced corrosion resistance
- Luer Lock nozzle

Package includes syringe, one meter silicone feed tube, sinker, PVC protection sleeve, aspiration, vent and dosing cannulas, set of spare for valve, operating instructions.

Further Self-filling syringes available on request.

Type	Volume ml	Valve	With	PK	Cat. No.
Dosys™ basic 162	0,5 - 5	without	2-ring handle	1	6.229 740
Dosys™ classic 163	0,3 - 2	integrated	2-ring handle	1	6.206 201
Dosys™ premium 164	0,3 - 2	detachable	2-ring handle	1	6.204 472
Dosys™ premium 164	1 - 10	detachable	2-ring handle	1	6.224 207
Dosys™ basic 172	0,1 - 1	without	pistol grip	1	9.411 524
Dosys™ basic 172	0,3 - 2	without	pistol grip	1	9.411 525
Dosys™ basic 172	0,5 - 5	without	pistol grip	1	9.411 526
Dosys™ basic 172	1 - 10	without	pistol grip	1	9.411 527
Dosys™ classic 173	0,025 - 0,3	integrated	pistol grip	1	7.981 548
Dosys™ classic 173	0,1 - 0,5	integrated	pistol grip	1	6.266 515
Dosys™ classic 173	0,1 - 1	integrated	pistol grip	1	6.205 165
Dosys™ classic 173	0,5 - 5	integrated	pistol grip	1	6.231 686
Dosys™ classic 173	1 - 10	integrated	pistol grip	1	6.230 535
Dosys™ classic 173	5 - 20	integrated	pistol grip	1	7.630 775
Dosys™ premium 174	0,1 - 1	detachable	pistol grip	1	9.411 520
Dosys™ premium 174	0,3 - 2	detachable	pistol grip	1	9.411 521
Dosys™ premium 174	0,5 - 5	detachable	pistol grip	1	9.411 522
Dosys™ premium 174	1 - 10	detachable	pistol grip	1	9.411 523



1 Bottletop dispenser LLG-uniTOPDISPENS 2



The combination of a springless PTFE valve and **PTFE piston** with chemically resistant ETP O-ring enables dispensing of both organic reagents as well as bases, thus, eliminating the need to buy different dispensers for different applications. The improved design of the uniTOPDISPENS 2 bottle top dispenser including a **re-circulation valve** allows a smooth, precise and reliable bubble free dispensing without any loss of reagent. The specially designed bottle adaptor which permits a 360° rotation of the unit, the easy volume setting as well as the flexible delivery nozzle underline the user friendliness of this bottletop dispenser. Available in six volume ranges.

- Springless PTFE valve, PTFE piston with chemically resistant ETP O-ring enables **high chemical compatibility**
- Glass cylinder from borosilicate glass 3.3
- Re-circulation valve enables easy priming and bubble free dispensing
- Smooth, reproducible and effortless dispensing
- 360° rotation possible due to specially designed bottle adapter
- Flexible and adjustable delivery nozzle provides **dispensing angle flexibility** to the user
- Specially designed volume adjustment knob for quick and easy volume setting
- **The telescopic extractable intake tube can be easily adjusted to varying bottle heights**
- Nozzle cap reduces contact with air and prevents drying and dripping if the tip cover is attached
- Five bottle adaptors included (28 mm, 32 mm, 37 mm, 40 mm and 45 mm). Standard thread: 30 mm.
- Fully autoclavable at 121 °C, 15 psi for 10 to 15 min
- Individually calibrated in accordance with ISO 8655 standards and each unit is supplied with an individual calibration certificate
- You can find the appropriate compatibility list on www.llg-labware.com in the Downloads section.
- 3 years warranty



Description	Volume ml	Graduations ml	Accuracy max. vol. (± R%)	Precision max. vol. (≤ CV%)	PK	Cat. No.
LLG-uniTOPDISPENS 2	0.25 - 2.5	0.05	0.6	0.2	1	6.282 275
LLG-uniTOPDISPENS 2	0.5 - 5	0.1	0.6	0.2	1	6.282 276
LLG-uniTOPDISPENS 2	1 - 10	0.2	0.6	0.2	1	6.282 277
LLG-uniTOPDISPENS 2	2.5 - 30	0.5	0.6	0.2	1	6.282 278
LLG-uniTOPDISPENS 2	5 - 60	1.0	0.6	0.2	1	6.282 279
LLG-uniTOPDISPENS 2	10 - 100	2.0	0.6	0.2	1	6.282 280

2 Bottletop dispenser LLG-uniTOPDISPENS with glass piston and clear glass cylinder

The LLG-uniTOPDISPENS is a **reasonably priced** bottle-top dispenser with **glass piston**. Available in 2 sizes (2-10 and 10-50 ml). Precise, reliable and robust. The high quality of the material used and the precision of the grinding ensures the perfect seal of the complete dispensing system. 3 years warranty.

- Precise and reliable volume setting
- Visible dosing procedure
- Valve block made of PP gives optimised protection of the glass made dosing cylinder
- Precise grinding of the glass piston into the glass cylinder forms a perfect seal
- Ergonomic finger guard
- Delivered with 2 PP-adapters GL 40 and 45
- With glass piston and clear glass cylinder
- You can find the appropriate compatibility list on www.llg-labware.com in the Downloads section.

Scope of supply: dispenser, 1 bottle adapter each 28 mm, 32 mm, 37 mm, 40 mm, 45 mm

Description	Volume ml	Graduations ml	Accuracy max. vol. (± R%)	Precision max. vol. (≤ CV%)	PK	Cat. No.
LLG-uniTOPDISPENS	2 - 10	0.2	0.6	0.2	1	9.283 806
LLG-uniTOPDISPENS	10 - 50	1.0	0.6	0.2	1	9.283 808





1 Dispensers, VITLAB® SIMPLEX²



VITLAB

With variable volume and calibration mechanism.

- quick, easy and precise volume adjustment due to interior scalloped track and practical screw mechanism
- no drips after tube has been capped
- easy calibration adjustment
- high-quality materials (PTFE, PFA, FEP, borosilicate glass, platinum-iridium) ensure high chemical resistance against most acids, solvents and bases
- a positive displacement plunger with a PFA seal minimizes the crystallization of liquids and thus the clogging of the plunger
- easy to dismantle for cleaning, no tools necessary
- completely autoclavable at 121°C
- device can be rotated 360° on bottle
- DE-M marked
- with GL 45 thread
- with screwable discharge valve

Scope of supply: 3 respectively 5 threaded adapters*made of PP, 1 telescopic filling tube, 1 mounting tool, operation manual, quality certificate

Volume ml	Graduations ml	Accuracy max. vol. (± R%)	Precision max. vol. (≤ CV%)	Neck thread GL	PK	Cat. No.
0.2 ... 2.0	0.05	0.5**	0.1	45	1	6.283 967
0.5 ... 5.0	0.10	0.5**	0.1	45	1	6.283 968
1.0 ... 10.0	0.20	0.5**	0.1	45	1	6.283 969
2.5 ... 25.0	0.50	0.5**	0.1	45	1	6.283 970
5.0 ... 50.0	1.00	0.5**	0.1	45	1	6.283 971
10.0 ... 100.0	1.00	0.5**	0.1	45	1	6.283 972

* Nominal volume 2 - 10 ml: with adapters GL 25, GL 28, GL 32, GL 38, S 40 and telescopic intake tube (length 125 - 240 mm).

Nominal volume 25 - 100 ml: with adapters GL 32, GL 38, S 40 and telescopic intake tube (length 170 - 330 mm).

**Accuracy and Coefficient of variation according to DIN EN ISO 8655-5.



2 Bottle top dispenser VITLAB® genius²



VITLAB

With recirculation valve and calibration mechanism.

- Quick, easy and precise volume adjustment due to interior scalloped track and practical screw mechanism
- Innovative recirculation valve avoids reagent waste
- No drips after tube has been capped
- Easy calibration adjustment
- High-quality materials (PTFE, PFA, FEP, borosilicate glass, platinum-iridium) ensure good chemical resistance to most acids, solvents and bases
- A positive displacement plunger with PFA seal minimizes the crystallization of liquids and therefore the possibility of the plunger jamming
- Easy to dismantle for cleaning, no tools necessary
- Completely autoclavable at 121 °C
- Can be rotated 360° on bottle
- Certificate of conformity according to DIN 12600 DE-M marked
- Margin of error according to DIN EN ISO 8655-5
- With recirculation valve and calibration mechanism
- With GL 45 thread
- With screwable discharge valve

Items supplied: 3 respectively 5 threaded adapters*made of PP (see chart), 1 telescopic filling tube, 1 mounting tool, operation manual, quality certificate stating all test values

Volume ml	Grad. ml	Accuracy max. vol. (± R%)	Precision max. vol. (≤ CV%)	PK	Cat. No.
0.2 - 2	0.05	0.5**	0.1	1	6.283 976
0.5 - 5	0.10	0.5**	0.1	1	6.283 977
1 - 10	0.20	0.5**	0.1	1	6.283 978
2.5 - 25	0.50	0.5**	0.1	1	6.283 979
5 - 50	1	0.5**	0.1	1	6.283 980
10 - 100	1	0.5**	0.1	1	6.283 981

* Nominal volume 2 - 10 ml: with adapters GL 25, GL 28, GL 32, GL 38, S 40 and telescopic intake tube (length 125 - 240 mm).

Nominal volume 25 - 100 ml: with adapters GL 32, GL 38, S 40 and telescopic intake tube (length 170 - 330 mm).

**Accuracy and Coefficient of variation according to DIN EN ISO 8655-5

Dispensers, bottle-top, POLYFIX®

1

For dispensing of all chemicals, where polypropylene is resistant. With glass dispensing barrel. Valve block not detachable for safety reasons.

Poulten & Graf

- conformity-certified
- ergonomically designed plunger handle for comfortable operation
- user-friendly, volume setting with easy movement and rotatable fine adjustment
- PP valve block (GL32) with FIX adapter which aligns the dispenser on the bottle.

Supplied with 2 x PP bottle adapters (GL40 and GL45).



9.283 804

Description	Volume	Graduations	Accuracy	Precision	PK	Cat. No.
	ml	ml	max. vol. (± R%)	max. vol. (≤ CV%)		
with glass piston and clear glass cylinder*	2 - 10	0.2	0.6	0.2	1	9.283 800
with glass piston and clear glass cylinder*	10 - 50	1.0	0.6	0.2	1	9.283 810
with PTFE-coated piston and clear glass cylinder**	2 - 10	0.2	0.6	0.2	1	9.283 801
with PTFE-coated piston and clear glass cylinder**	10 - 50	1.0	0.6	0.2	1	9.283 802
with glass piston and amber dosing cylinder***	2 - 10	0.2	0.6	0.2	1	9.283 803
with glass piston and amber dosing cylinder***	10 - 50	1.0	0.6	0.2	1	9.283 804 1

* For dosing of aqueous media

**For dosing of weak acids and bases

***For dispensing light sensitive liquids

2 Dispensers, bottle-top, FORTUNA® OPTIFIX® BASIC

2



Poulten & Graf

For problem-free dispensing of aqueous media and acids as well as solutions subject to crystallization. With solid, PTFE-sleeved dispensing piston, highly polished, 100 % corrosion-free, plastic-coated, precision glass cylinder (visible dispensing process). Black-graduated, dispensing cylinder. PTFE valve block (no metal springs to contaminate the dispensed liquid). With colour-coded handle inscriptions. Sizes 2 to 100 ml autoclavable (Please read the autoclaving instructions carefully before proceeding). Sizes 200 to 500 ml in autoclavable version only available on request.

Items supplied: Dispenser without reservoir bottle, PTFE suction and discharge tube and two PP bottle adapters (GL40 and GL45). Conformity-certified, with precision certificate.

Type	Volume	Graduations	Accuracy	Precision	PK	Cat. No.
	ml	ml	max. vol. (± R%)	max. vol. (≤ CV%)		
BASIC-27	0,5 - 2	0,1	0,6	0,2	1	9.287 902
BASIC-33	1 - 5	0,1	0,6	0,2	1	9.287 903
BASIC-38	2 - 10	0,2	0,6	0,2	1	9.287 904
BASIC-44	5 - 30	0,5	0,6	0,2	1	9.287 905
BASIC-48	10 - 50	1,0	0,6	0,2	1	9.287 906
BASIC-51	20 - 100	2,0	0,6	0,2	1	9.287 907
BASIC-53	40 - 200	5,0	0,6	0,2	1	9.287 908
BASIC-56*	60 - 300	5,0	0,6	0,2	1	9.287 909
BASIC-56**	60 - 300	5,0	0,6	0,2	1	6.237 320
BASIC-58*	100 - 500	5,0	0,6	0,2	1	9.287 951

* not included in ISO 8655/5

**autoclavable

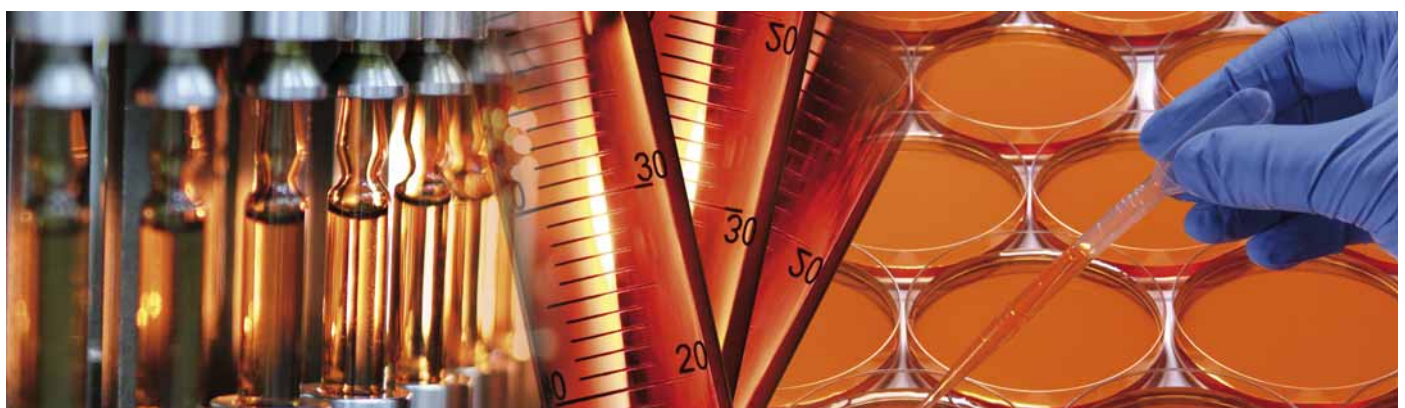

1



1 Dispensers, bottle-top, FORTUNA® OPTIFIX® SOLVENT



Poulsen & Graf

For organic solvents and liquid compounds that may swell PTFE. With glass dispensing barrel and precision glass piston. Barrel graduated in black. Visible dispensing. PTFE valve block (GL32). With colour-coded plunger handles. Autoclavable (Please read the autoclaving instructions carefully before proceeding).

Items supplied: Dispenser without reservoir bottle, PTFE suction and discharge tube and two PP bottle adapters (GL40 and GL45). Conformity-certified, with precision certificate.

Type	Volume ml	Graduations ml	Accuracy max. vol. (± R%)	Precision max. vol. (≤ CV%)	PK	Cat. No.
SOLVENT-27	0,5 - 2	0,1	0,6	0,2	1	9.287 953
SOLVENT-33	1 - 5	0,1	0,6	0,2	1	9.287 954
SOLVENT-38	2 - 10	0,2	0,6	0,2	1	9.287 955
SOLVENT-44	5 - 30	0,5	0,6	0,2	1	9.287 956
SOLVENT-48	10 - 50	1,0	0,6	0,2	1	9.287 957
SOLVENT-51	20 - 100	2,0	0,6	0,2	1	9.287 958
SOLVENT-53	40 - 200	5,0	0,6	0,2	1	9.287 959
SOLVENT-56*	60 - 300	5,0	0,6	0,2	1	9.287 960
SOLVENT-58*	100 - 500	5,0	0,6	0,2	1	9.287 961

* in addition to ISO 8655

2



2 Dispensers, bottle-top, FORTUNA® OPTIFIX® SAFETY

Poulsen & Graf

For strong acids (excl. HF) and aggressive chemicals. Visible dispensing process, dispensing piston made of PTFE-sleeved, solid glass, with additional sealing lip at the end of the piston to prevent acid fumes and odours from escaping. No metal springs in the valve block (no contamination of the dispensed liquid). With colour-coded handle inscriptions.

Items supplied: Dispenser without reservoir bottle, 1 discharge tube, incl. 2 PTFE-adapters (GL 40+45), 1 PTFE suction tube.

Type	Volume ml	Grad. ml	Accuracy max. vol. (± R%)	Precision max. vol. (≤ CV%)	PK	Cat. No.
Safety-27	0.5 - 2	0.1	0.6	0.2	1	9.287 962
Safety-33	1 - 5	0.1	0.6	0.2	1	9.287 963
Safety-38	2 - 10	0.2	0.6	0.2	1	9.287 964
Safety-44	5 - 30	0.5	0.6	0.2	1	9.287 965
Safety-48	10 - 50	1.0	0.6	0.2	1	9.287 966
Safety-51	20 - 100	2.0	0.6	0.2	1	9.287 967

3



3 Dispensers, bottle-top, FORTUNA® OPTIFIX® SAFETY S

Poulsen & Graf

Bottle-top dispensers for dispensing strong fuming acids and very aggressive liquids, with safety stopcock and additional safety valve in the ventilation tube, with PTFE-encased dispensing piston with sealing lip, FIX adaptor made of solid PTFE, no metal springs in the valve block (no contamination), comes with 2 x PTFE GL40/GL45 adapters and PTFE inlet tube.

Type	Volume ml	Grad. ml	Accuracy max. vol. (± R%)	Precision max. vol. (≤ CV%)	PK	Cat. No.
Safety S-27	0.5 - 2	0.1	0.6	0.2	1	6.206 600
Safety S-33	1 - 5	0.1	0.6	0.2	1	6.227 942
Safety S-38	2 - 10	0.2	0.6	0.2	1	9.287 995
Safety S-44	5 - 30	0.5	0.6	0.2	1	9.287 996
Safety S-48	10 - 50	1.0	0.6	0.2	1	9.287 997
Safety S-51	20 - 100	2.0	0.6	0.2	1	9.287 998

4



4 Dispensers, bottle-top, FORTUNA UNIVERSAL® OPTIFIX® HF

Poulsen & Graf

With solid PTFE dispensing barrel and glass-cored, PTFE coated plunger with seal (prevents acid vapours escaping from the storage bottle). No metal springs in the valve block (no contamination).

Items supplied: Hydrofluoric acid dispenser without reservoir bottle, with PTFE valve block (GL32), PTFE suction and discharge tubes and two PTFE bottle adapters (GL40 and GL45).

Type	Volume ml	Graduations ml	Accuracy max. vol. (± R%)	Precision max. vol. (≤ CV%)	PK	Cat. No.
HF-33	1 - 5	0.1	0.6	0.2	1	9.287 970
HF-38	2 - 10	0.2	0.6	0.2	1	9.287 968
HF-44	5 - 30	0.5	0.6	0.2	1	9.287 969
HF-48	10 - 50	1.0	0.6	0.2	1	6.241 198

1 Bottle-top dispensers Calibrex™ organo 525/Calibrex™ solutae 530

Calibrex organo 525 models include a ground glass plunger, best suited for organics, non-crystallizing acid and base solutions. Calibrex solutae 530 dispensers have a PFA coated plunger preventing plunger and barrel from seizing together. This enables trouble free distribution of salt solutions, weak and strong acids, as well as bases.

Socorex

- 45 mm base thread
- Integrated calibration system
- Autoclavable at 121°C fully assembled

Scope of delivery: Delivery jet and stopper, feed tube, 3 alternative adapters (25, 28, 32 mm for 1 and 2.5 ml versions; 28, 32, 40 mm for 5 and 10 ml version; 32, 38, 40 mm from 25 ml onwards), QC certificate and operating instructions

1



Type	Volume ml	Grad. ml	Accuracy max. vol. (± R%)	Precision max. vol. (≤ CV%)	Recycle valve	PK	Cat. No.
Calibrex™ solutae 530	0,1 - 1	0.02	0.6	0.17	without	1	6.281 543
Calibrex™ solutae 530	0.25 - 2.	0.05	0.6	0.17	without	1	6.281 544
Calibrex™ solutae 530	0.5 - 5	0.1	0.6	0.1	without	1	6.281 545
Calibrex™ solutae 530	1 - 10	0.2	0.6	0.1	without	1	6.281 546
Calibrex™ solutae 530	2.5 - 25	0.5	0.6	0.1	without	1	9.411 565
Calibrex™ solutae 530	5 - 50	1.0	0.6	0.1	without	1	9.411 566
Calibrex™ solutae 530	10 - 100	1.0	0.6	0.1	without	1	6.258 446
Calibrex™ solutae 530	0.1 - 1	0.02	0.6	0.17	with	1	6.281 547
Calibrex™ solutae 530	0.25 - 2.5	0.05	0.6	0.17	with	1	6.281 548
Calibrex™ solutae 530	0.5 - 5	0.1	0.6	0.1	with	1	6.281 549
Calibrex™ solutae 530	1 - 10	0.2	0.6	0.1	with	1	6.281 550
Calibrex™ solutae 530	2.5 - 25	0.5	0.6	0.1	with	1	6.261 221
Calibrex™ solutae 530	5 - 50	1.0	0.6	0.1	with	1	6.261 222
Calibrex™ solutae 530	10 - 100	1.0	0.6	0.1	with	1	6.261 223
Calibrex™ organo 525	0,1 - 1	0.02	0.6	0.17	without	1	6.281 538
Calibrex™ organo 525	0.25 - 2.5	0.05	0.6	0.17	without	1	6.270 246
Calibrex™ organo 525	0.5 - 5	0.1	0.6	0.1	without	1	6.270 247
Calibrex™ organo 525	1 - 10	0.2	0.6	0.1	without	1	6.270 248
Calibrex™ organo 525	2.5 - 25	0.5	0.6	0.1	without	1	9.411 562
Calibrex™ organo 525	5 - 50	1.0	0.6	0.1	without	1	9.411 563
Calibrex™ organo 525	10 - 100	1.0	0.6	0.1	without	1	9.411 564
Calibrex™ organo 525	0.1 - 1	0.02	0.6	0.17	with	1	6.281 539
Calibrex™ organo 525	0.25 - 2.5	0.05	0.6	0.17	with	1	6.281 540
Calibrex™ organo 525	0.5 - 5	0.1	0.6	0.1	with	1	6.281 541
Calibrex™ organo 525	1 - 10	0.2	0.6	0.1	with	1	6.281 542
Calibrex™ organo 525	2.5 - 25	0.5	0.6	0.1	with	1	6.261 218
Calibrex™ organo 525	5 - 50	1.0	0.6	0.1	with	1	6.261 219
Calibrex™ organo 525	10 - 100	1.0	0.6	0.1	with	1	6.261 220
Calibrex™ digital 520	0.25 - 2.0					1	9.411 529
Calibrex™ digital 520	1 - 5					1	9.411 530
Calibrex™ digital 520	1 - 10					1	9.411 531



1

1 Dispensers, bottle-top, ceramus® classic

Hirschmann

With ceramic pistons. High precision, bottle-top dispensers adjustable in fixed steps for the reproducible dispensing of liquids. Declaration of conformity acc. to DIN 12600. With patented, high-purity, alumino-ceramic pistons and highly polished, DURAN® glass cylinders, guaranteeing continual durability and precision.

- no surface abrasion
- no sticking due to plastic swelling
- no thermal expansion problems

Ratchet adjustment mechanism prevents accidental adjustment of the set volume. When not in use the pistons can be locked and the delivery tubes capped to prevent loss of reagent. The glass cylinders are encased in plastic for added safety and have a window for viewing the contents. Autoclavable up to max. 121°C/2 bar.

- inlet and outlet valves are easily replaced
- fully supported delivery jet prevents 'side fling' of reagent
- screw-fixed, inlet suction tube
- High-grade materials (ECTFE, DURAN® glass, FEP) are used throughout.
- Discharge valves and valve seats consisting of high-purity aluminium oxide ceramic

Supplied with: complete with thread A 32 mm, 3 thread adapters (A 28, A 45, S 40), 1 screw-coupled suction tube, 1 discharge tube unit, one spanner for valve, with individual serial number and Single Calibration Report.

Volume ml	Grad. ml	Accuracy max. vol. (± R%)	Precision max. vol. (≤ CV%)	PK	Cat. No.
0.2 - 1	0.05	0.6	0.2	1	9.287 831
0.4 - 2	0.05	0.6	0.2	1	9.287 832
1 - 5	0.10	0.6	0.2	1	9.287 833
2 - 10	0.25	0.6	0.2	1	9.287 834
5 - 30	0.50	0.6	0.2	1	9.287 835
10 - 60	1.00	0.6	0.2	1	9.287 836

2

2 Dispensers, bottle-top, ceramus®

Hirschmann

New dispenser technology from Hirschmann laboratory apparatus, with ceramic pistons. ceramus® are a high-precision, bottle-top dispenser range for almost all liquids.

- Environmentally-friendly, reagent-saving, recirculation valves
- Tough, ceramic pistons
- Simple, self-locking volume selection
- When not in use, pistons can be locked and delivery tubes capped to prevent loss of reagent.
- Fixed interval graduations give excellent reproducibility
- 45mm screw neck and adapters supplied allow use with a variety of reservoir bottles
- Smooth-action piston minimises operator fatigue during serial dispensing
- High-grade construction materials provide long operational life
- autoclavable at 121°C

Supplied with: ceramus® complete with thread adapters A 45mm, 3 thread adapters (A 32, S 40 Merck bottles and A 38), 1 screw-coupled suction tube, 1 discharge tube unit complete, 1 spanner for valve, with individual serial number and single calibration report.

Type	Volume ml	Grad. ml	Accuracy max. vol. (± R%)	Precision max. vol. (≤ CV%)	PK	Cat. No.
Variable	0.2 - 1.0	0.05	0.6	0.2	1	9.287 800
Variable	0.4 - 2.0	0.05	0.6	0.2	1	9.287 801
Variable	1.0 - 5.0	0.1	0.6	0.2	1	9.287 802
Variable	2.0 - 10.0	0.25	0.6	0.2	1	9.287 803
Variable	5.0 - 30.0	0.5	0.6	0.2	1	9.287 804
Variable	10.0 - 60.0	1.0	0.6	0.2	1	9.287 805
Fixed	1.0	-	0.6	0.2	1	9.287 806
Fixed	2.0	-	0.6	0.2	1	9.287 807
Fixed	5.0	-	0.6	0.2	1	9.287 808
Fixed	10.0	-	0.6	0.2	1	9.287 809
Fixed	25.0	-	0.6	0.2	1	9.287 815
Fixed	50.0	-	0.6	0.2	1	9.287 816

Further accessories can be found in our online shop.

HIRSCHMANN®

HiClass in the lab – globally!



Titration, dispensing or pipetting,
Hirschmann makes your laboratory work
speedier, safer and more accurate.

Hirschmann – HiClass in the lab.

HIRSCHMANN®

Hirschmann Laborgeräte GmbH & Co. KG
Hauptstraße 7-15 · 74246 Eberstadt Germany
Fon +49 7134 511-0 · Fax +49 7134 511-990
www.hirschmannlab.com · info@hirschmannlab.com





1 Bottle-top dispensers Dispensette® S



The Dispensette® S bottle-top dispenser makes liquid dosing easy and secure.

- Discharge tube, with and without recirculation valve
- Valve system - tight sealing without additional sealing rings
- Fast venting through improved aerodynamics
- Minimal force needed to operate - especially with high-volume devices
- Secure volume fixing with analog slide
- 1 ml dispenser - available as digital and analog version
- Autoclavable (121 °C)
- Easy to calibrate and adjust in order to comply with ISO 9001 and GLP guidelines
- Easy to disassemble for cleaning
- Removable filling and exhaust valve with safety bulb (closes when discharge tube is not mounted)
- To allow the bottle label to face the user, the valve block can be rotated by 360 °
- Telescope filling tube easily adjusts to different bottle sizes
- DE-M marking
- Analog volume display
- Quickly adjustable dosing volume

Included items:

Bottletop dispensers Dispensette® S, DE-M marked and supplied with performance certificate, telescope filling tube, recirculation valve (optional), mounting tool and adapters made of PP.



2 Bottle-top dispenser Dispensette® Analog S

Red color code. Wide range of applications, ideal for dispensing aggressive reagents, e.g. concentrated bases and acids such as H₃PO₄, H₂SO₄ (except as HCl, HNO₃ and HF), saline solutions and a variety of organic solvents.

BRAND

Volume ml	Grad. ml	Accuracy max. vol. (± R%)	Precision max. vol. (≤ CV%)	Recycle valve	Description	PK	Cat. No.
0.1 - 1	0.02	0.6	0.2	without	Incl. performance certificate	1	9.284 380
0.1 - 1	0.02	0.6	0.2	with	Incl. performance certificate	1	9.284 381
0.2 - 2	0.05	0.5	0.1	without	Incl. performance certificate	1	9.284 459
0.2 - 2	0.05	0.5	0.1	with	Incl. performance certificate	1	9.284 462
0.5 - 5	0.10	0.5	0.1	without	Incl. performance certificate	1	9.284 384
0.5 - 5	0.10	0.5	0.1	with	Incl. performance certificate	1	9.284 385
1 - 10	0.20	0.5	0.1	without	Incl. performance certificate	1	9.284 386
1 - 10	0.20	0.5	0.1	with	Incl. performance certificate	1	9.284 387
1 - 10	0.20	0.5	0.1	with	Incl. DAKK calibration certificate	1	6.285 509
2.5 - 25	0.50	0.5	0.1	without	Incl. performance certificate	1	9.284 388
2.5 - 25	0.50	0.5	0.1	with	Incl. performance certificate	1	9.284 389
5 - 50	1.00	0.5	0.1	without	Incl. performance certificate	1	9.284 390
5 - 50	1.00	0.5	0.1	with	Incl. performance certificate	1	9.284 391
10 - 100	1.00	0.5	0.1	without	Incl. performance certificate	1	9.284 392
10 - 100	1.00	0.5	0.1	with	Incl. performance certificate	1	9.284 393
10 - 100	1.00	0.5	0.1	with	Incl. DAKK calibration certificate	1	6.291 624

1 Bottle-top dispenser Dispensette® S Fix

Red color code (applications see Dispensette® S Analog).
Further fixed volumes are available on request

BRAND



Volume	Accuracy max. vol.	Precision max. vol.	Recycle valve	Description	PK	Cat. No.
ml	(± R%)	(≤ CV%)				
1	0.6	0.2	without	Incl. performance certificate	1	9.284 394
1	0.6	0.2	with	Incl. performance certificate	1	9.284 395
2	0.5	0.1	without	Incl. performance certificate	1	9.284 396
2	0.5	0.1	with	Incl. performance certificate	1	9.284 397
5	0.5	0.1	without	Incl. performance certificate	1	9.284 398
5	0.5	0.1	with	Incl. performance certificate	1	9.284 399
10	0.5	0.1	without	Incl. performance certificate	1	9.284 402
10	0.5	0.1	with	Incl. performance certificate	1	9.284 456
10	0.5	0.1	with	Incl. DAkkS calibration certificate	1	6.285 291

2 Bottle-top dispenser Dispensette® Digital S

Red color code (applications see Dispensette® S Analog).
Especially easy to read digital display.

BRAND



Volume	Grad.	Accuracy max. vol.	Precision max. vol.	Recycle valve	Description	PK	Cat. No.
ml	ml	(± R%)	(≤ CV%)				
0.1 - 1	0.005	0.6	0.2	without	Incl. performance certificate	1	9.284 382
0.1 - 1	0.005	0.6	0.2	with	Incl. performance certificate	1	9.284 383
0.2 - 2	0.01	0.5	0.1	without	Incl. performance certificate	1	9.284 407
0.2 - 2	0.01	0.5	0.1	with	Incl. performance certificate	1	9.284 408
0.5 - 5	0.02	0.5	0.1	without	Incl. performance certificate	1	9.284 409
0.5 - 5	0.02	0.5	0.1	with	Incl. performance certificate	1	9.284 412
1 - 10	0.05	0.5	0.1	without	Incl. performance certificate	1	9.284 413
1 - 10	0.05	0.5	0.1	with	Incl. performance certificate	1	9.284 416
1 - 10	0.05	0.5	0.1	with	Incl. DAkkS calibration certificate	1	6.280 429
2.5 - 25	0.10	0.5	0.1	without	Incl. performance certificate	1	9.284 417
2.5 - 25	0.10	0.5	0.1	with	Incl. performance certificate	1	9.284 419
5 - 50	0.20	0.5	0.1	without	Incl. performance certificate	1	9.284 422
5 - 50	0.20	0.5	0.1	with	Incl. performance certificate	1	9.284 423



1 Bottle-top dispenser Dispensette® Organic Analog S

Yellow color code. Ideal for dispensing organic solvents, e.g., chlorinated and fluorinated hydrocarbons such as trichlorotrifluoroethane and methylene chloride, or concentrated acids such as HCl and HNO₃ (not HF) as well as trifluoroacetic acid (TFA), tetrahydrofuran (THF) and peroxides.

BRAND

Volume ml	Grad. ml	Accuracy max. vol. (± R%)	Precision max. vol. (≤ CV%)	Recycle valve	Description	PK	Cat. No.
0.5 - 5	0.1	0.5	0.1	without	Incl. performance certificate	1	9.284 426
0.5 - 5	0.1	0.5	0.1	with	Incl. performance certificate	1	9.284 427
1 - 10	0.2	0.5	0.1	without	Incl. performance certificate	1	9.284 428
1 - 10	0.2	0.5	0.1	without	Incl. DAkkS calibration certificate	1	6.288 430
1 - 10	0.2	0.5	0.1	with	Incl. performance certificate	1	9.284 429
2.5 - 25	0.5	0.5	0.1	without	Incl. performance certificate	1	9.284 432
2.5 - 25	0.5	0.5	0.1	with	Incl. performance certificate	1	9.284 433
5 - 50	1.0	0.5	0.1	without	Incl. performance certificate	1	9.284 436
5 - 50	1.0	0.5	0.1	with	Incl. performance certificate	1	9.284 437
10 - 100	1.0	0.5	0.1	without	Incl. performance certificate	1	9.284 438
10 - 100	1.0	0.5	0.1	with	Incl. performance certificate	1	9.284 439



2 Bottle-top dispenser Dispensette® Organic Fix S

Color code yellow (applications see Dispensette® S Organic Analog). Further fixed volumes are available on request.

BRAND

Volume ml	Grad. ml	Accuracy max. vol. (± R%)	Precision max. vol. (≤ CV%)	Recycle valve	PK	Cat. No.
5	-	0.5	0.1	without	1	9.284 442
5	-	0.5	0.1	with	1	9.284 443
10	-	0.5	0.1	without	1	9.284 446
10	-	0.5	0.1	with	1	9.284 447



3 Bottle-top dispenser Dispensette® Organic Digital S

Yellow color code (applications see Dispensette® S Organic Analog). Especially easy to read digital display

BRAND

Volume ml	Grad. ml	Accuracy max. vol. (± R%)	Precision max. vol. (≤ CV%)	Recycle valve	PK	Cat. No.
0.5 - 5	0.02	0.5	0.1	without	1	6.269 500
0.5 - 5	0.02	0.5	0.1	with	1	6.269 501
1 - 10	0.05	0.5	0.1	without	1	6.269 502
1 - 10	0.05	0.5	0.1	with	1	6.269 503
2.5 - 25	0.1	0.5	0.1	without	1	6.269 504
2.5 - 25	0.1	0.5	0.1	with	1	6.269 505
5 - 50	0.2	0.5	0.1	without	1	6.269 506
5 - 50	0.2	0.5	0.1	with	1	6.269 507

1 Bottle-top dispenser Dispensette® S Trace Analysis Analog

Dispensette® S Trace Analysis is ideal for precise volume dosing of high purity media for trace analysis. Can be used as hydrofluoric acid dispenser with Pt/Ir valve. BRAND

Included items: Bottle-top dispenser Dispensette® S TA, DE-M marked and supplied with performance certificate, telescope filling tube, recirculation valve (optional), mounting tool and bottle adapters GL 28/S 28 (ETFE), GL 32 (ETFE) and S40 (PTFE), operating manual.

Volume	Grad.	Accuracy max. vol.	Precision max. vol.	Valve spring	Recycle valve	PK	Cat. No.
ml	ml	(± R%)	(≤ CV%)				
1 - 10	0.2	0.5	0.1	Pt / Ir	without	1	9.284 452
1 - 10	0.2	0.5	0.1	Pt / Ir	with	1	9.284 453
1 - 10	0.2	0.5	0.1	Tantalum	without	1	9.284 457
1 - 10	0.2	0.5	0.1	Tantalum	with	1	9.284 458



2 Bottle-top dispensers, seripettor®/seripettor® pro

The economy dispensers for routine dispensing. BRAND

The seripettor® and seripettor® pro are innovative bottle-top dispensers with a special design. A lifting spring provides automatic filling. When the piston seal is worn out, the entire dispensing unit can be exchanged by the user rapidly and easily, without tools. Eliminating expensive repairs!

- low-cost replaceable dispensing cartridge with wiping seal. One spare dispensing cartridge included.
- semi-automatic dispensing. The spring loaded piston refills the cylinder after dispensing.
- volume setting. Toothed setting track allows quick and precise adjustment of desired volume.
- disassembles without tools. All parts can be replaced quickly. The innovative design of seripettor®/seripettor® pro makes cleaning and maintenance easy
- fits most bottles

seripettor®

For dispensing alkaline, buffer and vitamin solutions, as well as culture media, e.g. agar nutrient medium, up to 60 °C.

seripettor® pro

Broader scope of application compared to the seripettor®; for dispensing many acidic, alkaline and saline solutions, and solvents.

Scope of supply: Discharge tube, filling tube, spare dispensing cartridge and adapters, PP (GL 45/32, GL 45/S40 and GL 45/38).



Type	Volume	Grad.	Accuracy max. vol.	Precision max. vol.	PK	Cat. No.
	ml	ml	(± R%)	(≤ CV%)		
seripettor®	0.2 - 2	0.04	1.2	0.2	1	9.284 849
seripettor®	1 - 10	0.2	1.2	0.2	1	9.284 850
seripettor®	2.5 - 25	0.5	1.2	0.2	1	9.284 851
seripettor® pro	0.2 - 2	0.04	1.2	0.2	1	9.284 854
seripettor® pro	1 - 10	0.2	1.2	0.2	1	9.284 852
seripettor® pro	2.5 - 25	0.5	1.2	0.2	1	9.284 853

End test values relate to the nominal values (= max. volume) printed on the dispenser when the temperature (20 °C) of the device, environment and distilled water is uniform, and when operated smoothly.

Suitable accessories can be found in our online shop.



1
1 Bottle-top dispenser opus®

opus® dispenser for motor-powered dispensing directly from the reagent bottle. In conjunction with the "dispenser" touch screen containing the complete electronic control, it represents an extremely sensitive precision dispensing instrument that guarantees excellent degrees of accuracy (e.g. during serial dispensing). With USB interface for linking to a PC. Hirschmann

Outstanding features:

- Simple menu-guided user instructions with tab cards on an external coloured TFT touch screen. Screen legibility is also guaranteed in even strong daylight
- Versatile application options, thanks to superior quality materials (ECTFE, DURAN glass, FEP); media-conveying components are suitable for steam sterilisation (121°C)
- Configuration of up to 9999 dispensing repetitions possible, intervals of up to 9999 seconds can be selected between individual dispensing operations
- Stepper function: Dispensing of several volume dosages (differing volumes possible) from a single cylinder charge (10ml, 20ml or 50ml)
- Individual problem-free calibration options
- Individual adaptation options, e.g. language selection (DE, UK, FR, ES), specification of charging and dispensing velocity in ml/sec (option for coordination with medium viscosity)
- Method memory, capacity for up to 9 different settings (e.g. volume, velocity, cycle duration, etc.).
- Accessories: pedal switch for triggering dispensing, USB interface connection cable 750, 2000 or 5000mm long touch screen connection cable, special lengths available, silicone system platform with bottle holder, batteries available for selective battery operation
- Discharge valves and valve seats consisting of high-purity aluminium oxide ceramic
- Saving of last setting ensures speedy further processing when the instrument is reactivated
- Declaration of conformity acc. to DIN 12600
- Quality assurance in compliance with DIN EN ISO 8655
- Power supply 100-240V, with EU, UK, US plug

Supplied with: opus® dispenser, complete with thread A 45 mm, 3 adapters (A 32, A 38 and S 40 Merck bottles), 1 screw coupled suction tube, 1 dispensing discharge unit and 1 power supply, 1 brown light protection window, touch screen module "dispenser", Data Power Cable 0.75 m, instruction manual, single calibration report.

Description	Accuracy max. vol. (± R%)	Precision max. vol. (≤ CV%)	PK	Cat. No.
Volumen 10 ml	0.6	0.2	1	9.287 874
Volumen 20 ml	0.6	0.2	1	9.287 872
Volumen 50 ml	0.6	0.2	1	9.287 873

Further accessories can be found in our online shop.

2
2 Dispenser/bottle-top flasks, amber soda-lime glass

Available ethylene-acrylate-coated or uncoated. The coating envelops the glass bottle like a protection skin. Should the bottle break, the splintering hazards are reduced considerably. To preserve the coating, do not clean at temperatures exceeding 60 °C. BRAND

- PP screw cap
- LDPE pouring ring
- Space-saving square design
- The maximum operating temperature for coated bottles is 80 °C

Type	Nominal capacity ml	Width mm	Height mm	Neck thread		PK	Cat. No.
					GL		
Ethylene-acrylate coated	100	50	125	32		1	6.073 469
Ethylene-acrylate coated	250	65	160	32		1	6.701 658
Ethylene-acrylate coated	500	80	195	32		1	6.701 659
Ethylene-acrylate coated	1000	95	230	45		1	7.604 011
Ethylene-acrylate coated	2500 *	140	300	45		1	7.510 519
Uncoated	100	50	125	32		1	9.284 541
Uncoated	250	65	160	32		1	9.284 542
Uncoated	500	80	195	32		1	9.284 543
Uncoated	1000	95	230	45		1	9.284 544
Uncoated	2500 *	140	300	45		1	9.284 545

* Cylindrical design

➔ More bottles please see page 62

1 Burettes, with straight stopcock, DURAN®, class AS

Schellbach line for easier reading, declaration of conformity acc. to DIN 12600, with dated batch identification, high-contrast blue graduations, main point ring graduation at major subdivisions, EX (TD) calibrated, acc. to DIN EN ISO 385. Scale length approx. 500mm. *Hirschmann*

For those products batch calibration reports, which are free of charge, can be generated and printed on www.hirschmannlab.de. Additional single calibration reports or DAkkS certificates (former DKD calibration reports) are available.

Capacity	Grad.	Tolerance	Stopcock with	PK	Cat. No.
ml	ml	± ml			
10	0.02	0.02	Glass key	1	9.270 161
25	0.05	0.03	Glass key	1	9.270 162
50	0.1	0.05	Glass key	1	9.270 163
10	0.02	0.02	PTFE spindle	1	9.270 164
25	0.05	0.03	PTFE spindle	1	9.270 165
50	0.1	0.05	PTFE spindle	1	9.270 166
10	0.02	0.02	PTFE key	1	9.270 167
25	0.05	0.03	PTFE key	1	9.270 168
50	0.1	0.05	PTFE key	1	9.270 169



2 Burettes, with straight stopcock, borosilicate glass 3.3, Class AS

All BLAUBRAND® burettes are supplied with batch number and an accompanying batch certificate in the original packaging. On request, they are also available with an individual certificate, USP individual certificate or DAkkS calibration certificate. Batch and individual certificates can also be downloaded at the supplier's website. *BRAND*

- BLAUBRAND®
- DIN EN ISO 385
- DE-M marking
- Marks and inscriptions in high contrast blue enamel
- Ring graduations at major subdivisions
- Schellbach stripe
- Calibrated to deliver (TD, EX)

Nominal capacity	Type	Grad.	Stopcock with	PK	Cat. No.
ml		ml			
10	Incl. batch certificate	0,02	PTFE spindle	1	9.270 115
25	Incl. batch certificate	0,05	PTFE spindle	1	9.270 116
50	Incl. batch certificate	0,1	PTFE spindle	1	9.270 117
10	Incl. DAkkS calibration certificate	0,02	PTFE spindle	1	6.259 806
25	Incl. DAkkS calibration certificate	0,05	PTFE spindle	1	6.253 878
50	Incl. DAkkS calibration certificate	0,1	PTFE spindle	1	6.253 559
25	Incl. individual certificate	0,05	PTFE spindle	1	6.235 293



3 Burettes, with straight stopcock, borosilicate glass 3.3, class AS

With class AS, conformity certified, with batch identification, blue graduations, DIN EN ISO 385. PTFE spindle. *ISOLAB*

Description	Capacity	Grad.	Tolerance	PK	Cat. No.
	ml	ml	± ml		
with Schellbach line	10	0.02	0.020	1	4.008 311
with Schellbach line	25	0.05	0.030	1	9.270 100
with Schellbach line	50	0.10	0.050	1	9.270 101
without Schellbach line	10	0.02	0.020	1	9.270 102
without Schellbach line	25	0.05	0.030	1	9.270 103
without Schellbach line	50	0.10	0.050	1	9.270 104





1 Burette with straight standard ground stopcock, DURAN®, class AS

The original DURAN® burettes are manufactured from chemically highly resistant borosilicate glass 3.3. Thanks to the precise scale, they are ideal for titration. Calibration is based on the released volume ("Ex") at a + 20°C reference temperature. This means the fluid quantity released can be taken exactly from the scale, as the liquid adhesion to the glass is taken into account in the calibration. Volume content tolerances conform to DIN and ISO accuracy limits. From now on the approved DURAN® burettes are also available with PTFE keys. Unlike the glass keys, the PTFE keys need not be greased, which makes work in the laboratory easier.

DWK Life Sciences

- Available in three sizes, the right burette for each application
- Proven DURAN® properties
- With Schellbach stripe and main graduations as circular divisions
- Conforms to ISO 385
- Autoclavable
- Corresponds to USP/EP and JP guidelines

Capacity	Grad.	Tolerance	Height	Stopcock with	PK	Cat. No.
ml	ml	± ml	mm			
10	0.02	0.02	750	Glass key	1	7.022 042
25	0.05	0.03	750	Glass key	1	7.022 043
50	0.1	0.05	750	Glass key	1	7.022 044
100	0.2	0.1	750	Glass key	1	9.270 925
10	0.02	0.02	750	PTFE key	1	9.270 921
25	0.05	0.03	750	PTFE key	1	9.270 922
50	0.1	0.05	750	PTFE key	1	9.270 923
100	0.2	0.1	750	PTFE key	1	9.270 924



2 Burettes, with lateral stopcock, DURAN®, class AS

With Schellbach stripe. EX (TD) calibrated. With dated batch identification. Declaration of conformity acc. to DIN 12600. High-contrast blue graduation for easier reading. Main point ring graduation, lateral stopcock with glass key or with PTFE-Spindle, DIN EN ISO 385. Scale length 500mm. For those products, batch calibration reports, which are free of charge, can be generated and printed on www.hirschmannlab.com. Additional single calibration reports or DAkkS certificates (former DKD calibration reports) are available.

Hirschmann

Capacity	Grad.	Tolerance	Stopcock with	PK	Cat. No.
ml	ml	± ml			
10	0.02	0.02	Glass key	1	9.270 155
25	0.05	0.03	Glass key	1	9.270 156
50	0.1	0.05	Glass key	1	9.270 157
10	0.02	0.02	PTFE spindle	1	9.270 158
25	0.05	0.03	PTFE spindle	1	9.270 159
50	0.1	0.05	PTFE spindle	1	9.270 160

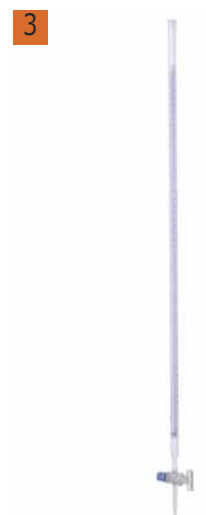

3 Burettes with straight glass stopcock, DURAN®, Class B

Blue graduated, with line graduation and Schellbach stripe. adjusted to EX, according to DIN EN ISO 385, scale length approx. 500 mm.

Hirschmann

Capacity	Grad.	Tolerance	PK	Cat. No.
ml	ml	± ml		
10	0.02	0.03	1	6.224 373
25	0.05	0.045	1	7.511 170
50	0.1	0.075	1	6.803 354

1 Burettes, with lateral stopcock, borosilicate glass 3.3, Class AS

All BLAUBRAND® burettes are supplied with batch number and an accompanying batch certificate in the original packaging. On request, they are also available with an individual certificate, USP individual certificate or DAkkS calibration certificate. Batch and individual certificates can also be downloaded at the supplier's website.

BRAND

- BLAUBRAND®
- DIN EN ISO 385
- DE-M marking
- Graduations and inscriptions in high contrast blue enamel
- With Schellbach stripe
- Calibrated to deliver (EX)

Nominal capacity ml	Type	Grad. ml	Tolerance ± ml	Stopcock with	Length mm	PK	Cat. No.
10	Incl. batch certificate	0.02	0.02	PTFE spindle	800	1	9.270 144
25	Incl. batch certificate	0.05	0.03	PTFE spindle	800	1	9.270 147
50	Incl. batch certificate	0.1	0.05	PTFE spindle	800	1	9.270 148
10	Incl. USP certificate	0.02	0.02	PTFE spindle	800	1	6.272 397
25	Incl. USP certificate	0.05	0.03	PTFE spindle	800	1	7.673 666
50	Incl. USP certificate	0.1	0.05	PTFE spindle	800	1	7.673 667
50	Incl. DAkkS calibration certificate	0.1	0.05	PTFE spindle	800	1	6.254 839

1



2 Compact Burette, Boro 3.3, class AS, DE-M marking

BLAUBRAND®, DE-M marking, removable PTFE stopcock. DIN EN ISO 385. Calibrated to deliver (TD, Ex).

Scope of supply: Burette tube with Schellbach stripe, stopcock with precision tip. Incl. one batch certificate.

Capacity ml	Grad. ml	Length mm	Tolerance ± ml	PK	Cat. No.
10	0.02	795	0.02	1	4.000 014
25	0.05	800	0.03	1	7.617 437
50	0.1	800	0.05	1	4.000 015

2



3 Compact burettes, borosilicate glass 3.3, class AS

NEW

BRAND

BLAUBRAND®, Amber glass. Fast to dismantle and easy to clean. All individual components are replaceable. All BLAUBRAND® burettes are delivered with batch number and enclosed one batch certificate per packing unit of the manufacturer. On demand also available with individual certificate, USP Individual certificate or DAkkS calibration certificate.

- With PTFE stopcock
- DIN EN ISO 385
- DE-M marking
- Schellbach stripe
- Calibrated to deliver (TD, Ex)

Nominal capacity ml	Grad. ml	Tolerance ± ml	PK	Cat. No.
10	0.02		1	4.668 796
25	0.05	0.03	1	4.668 797
50	0.1	0.05	1	4.668 798

3



4 Micro burettes with straight stopcock, Bang pattern, borosilicate glass 3.3, Class AS

BLAUBRAND®, class AS, DE-M marking. Boro 3.3. DIN EN ISO 385. Calibrated to deliver (TD, EX).

BRAND

Schellbach stripe. With needle valve stopcock with PTFE spindle (PTFE key in intermediate stopcock).

All BLAUBRAND® burettes are delivered with batch number and one batch certificate included per manufacturer's pack.

Also available with individual works, USP or DAkkS (former DKD) calibration certificate, please enquire.

The batch certificate is also available to download from the manufacturer's website.

Capacity ml	Grad. ml	Tolerance ± ml	Stopcock with	PK	Cat. No.
2	0.01	0.01	PTFE spindle	1	7.018 361
5	0.01	0.01	PTFE spindle	1	7.018 362
10	0.02	0.02	PTFE spindle	1	7.018 363
2	0.01	0.01	PTFE spindle *	1	9.271 235
5	0.01	0.01	PTFE spindle *	1	9.271 237
10	0.02	0.02	PTFE spindle *	1	7.018 365

* with lateral stopcock

4

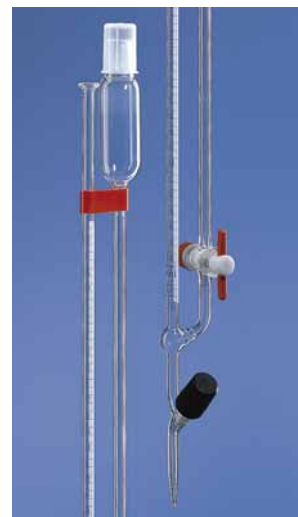

1

1 Automatic burettes with splinter protection, Schilling pattern, borosilicate glass 3.3

Burette according to Dr. Schilling with splinter protection, with Schellbach stripes, automatic zero point extraction and Bürkle dosing device. The glass burette is covered with a plastic sheet which increases the tensile strength and serves as splinter protection. The probability that the burette breaks is reduced compared to conventional burettes and even in case the burette breaks, no dangerous splinters will be produced. The dosing device allows precise dosage via the pushbutton or via the micro-screw as well as precise dispensing via a fine spout tip. *Bürkle*

- With splinter protection
- Adjusted to Ex
- Shatterproof, resistant to chemicals
- Exact spout tip, fine droplet formation
- Parts in contact with the medium: PE, natural rubber, PP, Borosilicate glass

Capacity	Grad.	Tolerance	Height	PK	Cat. No.
ml	ml	± ml	mm		
15	0.1	0.045	520	1	6.280 403
25	0.1	0.045	650	1	6.280 404
50	0.1	0.075	920	1	6.280 405

2

3

2 3 Automatic burettes, schilling pattern, borosilicate glass 3.3/LDPE

- Described as automatic burettes with fast titration and practical usage. *ISOLAB*
- Especially suitable for field analysis where there is a risk of breaking.
- The entire system consists of a burette tubing with automatic zeroing system together with a valve stopcock, a reservoir bottle and a bottle stand.
- Rapid filling by squeezing the bottle and fast titration by valve stopcock
- Inscriptions and graduations are printed either with blue enamel or with white enamel which is specially designed for glass use.
- Clear burettes are manufactured with schellbach stripe.
- Amber burettes are manufactured without schellbach stripe.
- 10ml burette has a polyethylene reservoir bottle of 500ml volume whereas 25 and 50ml burettes are used with bottles of 1000ml volume.

Description	Capacity	Grad.	Tolerance	PK	Cat. No.
	ml	ml	± ml		
clear glass, schellbach, blue graduated	10	0,05	0,030	1	4.008 314
clear glass, schellbach, blue graduated	25	0,10	0,050	1	6.241 904
clear glass, schellbach, blue graduated	50	0,10	0,050	1	4.008 315
amber, without schellbach, white graduated	10	0,05	0,030	1	4.008 316
amber, without schellbach, white graduated	25	0,10	0,050	1	4.008 317
amber, without schellbach, white graduated	50	0,10	0,050	1	4.008 318

4

4 Automatic burettes acc. to Schilling pattern, blue graduation, DURAN®

Fast flow burette with 500ml plastic reservoir bottle (up to 10ml) or 1000ml (up to 15ml). *Hirschmann*
Schellbach stripe and graduation in high contrast blue enamel, scale length approx. 330mm.

Capacity	Grad.	Tolerance	Bottle size	Scale length	PK	Cat. No.
ml	ml	± ml	ml	approx. mm		
5	0.05	0.03	500	330	1	6.070 009
10	0.05	0.045	500	330	1	7.510 426
15	0.1	0.045	1000	330	1	6.223 256
25	0.1	0.075	1000	330	1	7.510 427
50	0.1	0.075	1000	550	1	6.070 072

1 Automatic burettes, glass, Schilling pattern, borosilicate glass 3.3/HDPE, class B

SILBERBRAND. Tolerances to class B, DIN EN ISO 385. Borosilicate glass 3.3 burette. BRAND
 PVC filling tube and silicone outlet tubing. HDPE reservoir bottle with HDPE base.
 Brass/PP micrometer screw. Graduations and inscriptions are in highly contrasting black enamel.
 With Schellbach stripes. Squeezing of bottle allows rapid filling. Fine titration is easy using the micrometer screw.
 Coarse titration is achieved by removal of the micrometer screw and using the push button. Calibrated to deliver (EX).

Capacity	Grad.	Tolerance	Capacity	Height	PK	Cat. No.
ml	ml	± ml	ml	mm		
10*	0.05	0.05	500	530	1	9.271 053
15*	0.1	0.08	500	510	1	9.271 055
25*	0.1	0.08	1000	620	1	9.271 056
50*	0.1	0.1	1000	830	1	9.271 058
25* **	0.1	0.10	100	650	1	7.981 360
50**	0.1	0.1	1000	900	1	6.239 724

* Narrower divisions

**amber, borosilicate glass 5.4



2 Automatic burettes, Schilling pattern, borosilicate glass 3.3, class B

Conformity with DIN ISO 384. Class B. With easily readable, black scaling. Calibrated to deliver, EX. VITLAB
 Automatic zeroing. The burette stopcock is made of high quality plastic. Its PTFE key turns easily and allows fine titration. Special protection against breakage if the apparatus gets knocked over: A small bumper has been attached to the upper end of the upright measuring tube. This feature reduces the chance of breakage.

Materials: burette of borosilicate glass 3.3, burette made of amber glass for light sensitive substances, PP filling tube, PTFE burette stopcock, PMP titration tip, LDPE reservoir bottle.

Type

[1] With plastic coating, with Schellbach stripes (blue/white)

[2] Without plastic coating, with Schellbach stripes (blue/white)

[3] Amber glass, without plastic coating, without Schellbach stripes

Bottle capacity: 1000 ml
 Height: 900 mm

Type	Burette capacity	Grad.	Tolerance	PK	Cat. No.
	ml	ml	± ml		
[1]	25	0.05	0.05	1	9.271 082
[1]	50	0.10	0.10	1	9.271 084
[2]	25	0.05	0.05	1	9.271 085
[2]	50	0.10	0.10	1	9.271 086
[3]	25	0.05	0.05	1	9.271 087
[3]	50	0.10	0.10	1	9.271 088



3 4 Automatic burettes, borosilicate glass 3.3, class AS

- Manufactured from pre-vacuum calibrated borosilicate glass. They meet the highest quality standards according to DIN EN ISO 385 ISOLAB
- Permanent quality control through all steps eliminates possible deviations from nominal values
- Calibrated to deliver (Ex) and the tolerances are according to DIN/ISO Class "AS" standards
- Conformity ("DE-M") certified, with a batch number printed on the body. Batch certificate can be downloaded from the suppliers website
- Supplied with an automatic zeroing system, VALVE stopcock and also an intermediate PTFE stopcock to recirculate the remaining liquid
- Clear burettes are manufactured with schellbach stripe
- Inscriptions and graduations are printed with special blue enamel. For amber burettes, white enamel is used to maximise visibility and durability

Glass bottle - Please order separately.

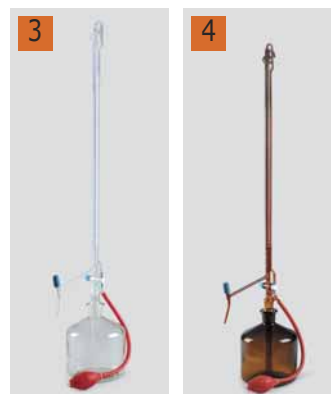

Description	Capacity	Grad.	Tolerance	Glass	Graduations	PK	Cat. No.
	ml	ml	± ml				
schellbach	10	0.02	0.020	clear	blue graduated	1	4.008 312
schellbach	25	0.05	0.030	clear	blue graduated	1	6.241 216
schellbach	50	0.10	0.050	clear	blue graduated	1	6.237 627
without schellbach	10	0.02	0.020	amber	white graduated	1	6.238 473
without schellbach	25	0.05	0.030	amber	white graduated	1	6.242 463
without schellbach	50	0.10	0.050	amber	white graduated	1	6.241 116



4.668 800

Compact-Automatic burette, amber glass with bottle, class AS, BLAUBRAND®



Fast to dismantle and easy to clean. All individual components are replaceable.
 All BLAUBRAND® automatic burettes are supplied with a batch number and an accompanying batch certificate in the original packaging. On request, they are also available with an individual certificate, USP individual certificate or DAKKS calibration certificate.

BRAND

- With PTFE stopcock
- DIN EN ISO 385
- DE-M marking
- Calibrated to deliver (TD, Ex)

Nominal capacity ml	Grad. ml	Tolerance ± ml	Description	PK	Cat. No.
10	0.02	0.02	With PE bottle	1	4.668 800 1
50	0.1	0.05	With PE bottle	1	4.668 802
10	0.02	0.02	With glass bottle	1	4.668 803
25	0.05	0.03	With glass bottle	1	4.668 804
50	0.1	0.05	With glass bottle	1	4.668 805

2



2 Automatic burettes acc. Pellet, without intermediate stopcock, class AS, DURAN®

Lateral PTFE-spindle without intermediate stopcock. Main point ring graduation. Schellbach stripe. With dated batch identification. Declaration of conformity acc. to DIN 12600. Graduation in high-contrast blue enamel, acc. to DIN EN ISO 385. Incl. 2L clear glass bottle. Scale length approx. 500mm.

Hirschmann

For those products, batch calibration reports, which are free of charge, can be generated and printed on www.hirschmannlab.com. Additional single calibration reports or DAKKS certificates (former DKD calibration reports) are available.

Capacity ml	Grad. ml	Tolerance ± ml	PK	Cat. No.
10	0.02	0.02	1	6.079 718
25	0.05	0.03	1	7.630 409
50	0.1	0.05	1	9.270 785

3



3 Automatic burettes acc. Pellet, with stopcock, class AS, DURAN®

Lateral glass stopcock and intermediate stopcock. Scale length approx. 500mm. Main point ring graduation. Schellbach stripe. With dated batch identification. Declaration of conformity acc. to DIN 12600. Graduation in high-contrast blue enamel, acc. to DIN EN ISO 385. Incl. 2 l clear glass bottle. For those products, batch calibration reports, which are free of charge, can be generated and printed on www.hirschmannlab.com. Additional single calibration reports or DAKKS certificates (former DKD calibration reports) are available.

Hirschmann

Capacity ml	Grad. ml	Tolerance ± ml	PK	Cat. No.
10	0.02	0.02	1	6.079 157
25	0.05	0.03	1	6.056 580
50	0.1	0.05	1	6.079 156

4



4 Automatic burettes acc. Pellet, with PTFE-spindle and intermediate stopcock, class AS, DURAN®

Lateral PTFE-spindle and intermediate stopcock. Scale length approx. 500mm. Main point ring graduation. Schellbach stripe. With dated batch identification. Declaration of conformity acc. to DIN 12600. Graduation in high-contrast blue enamel, acc. to DIN EN ISO 385. Incl. 2 l clear glass bottle. For those products, batch calibration reports, which are free of charge, can be generated and printed on www.hirschmannlab.com. Additional single calibration reports or DAKKS certificates (former DKD calibration reports) are available.

Hirschmann

Capacity ml	Grad. ml	Tolerance ± ml	PK	Cat. No.
10	0.02	0.02	1	6.228 424
25	0.05	0.03	1	6.228 425
50	0.1	0.05	1	9.270 780

1 Automatic burettes, Pellet pattern, borosilicate glass 3.3, Class AS, with stopcock

BLAUBRAND®. Class AS, to DIN EN ISO 385. Boro 3.3. With intermediate stopcock. DE-M marking. *BRAND*
 With batch number. Graduations and inscriptions in highly contrasting blue enamel. With Schellbach stripes.
 Intermediate stopcock allows residual reagent in the burette after titration to be recycled into the reservoir.
 Automatic zero point setting. Calibrated to deliver (EX). Choice of models, either with needle-valve stopcock with PTFE spindle (intermediate stopcock with PTFE-key) or with NS glass stopcock (intermediate stopcock with glass key).

Complete with 2 litre, soda-lime glass reservoir (160mm dia. x 200mm height, with 29/32 ground glass neck).
 Overall height with bottle approx. 1m. All BLAUBRAND® burettes are delivered with batch number and one batch certificate included per pack. Also available with individual works, USP or DAkkS (former DKD) calibration certificate, please enquire. The batch certificate is also available to download from the manufacturer's website.

Capacity	Grad.	Tolerance	Stopcock	PK	Cat. No.
ml	ml	± ml			
10	0.02	0.02	PTFE	1	9.270 764
25	0.05	0.03	PTFE	1	9.270 767
50	0.1	0.05	PTFE	1	9.270 768

**2** Automatic burettes, Pellet pattern, borosilicate glass 3.3, with stopcock, Class AS, without bottle

BLAUBRAND®. Class AS, to DIN EN ISO 385. Boro 3.3. With intermediate stopcock. DE-M marking. *BRAND*
 With batch number. Graduations and inscriptions in highly contrasting blue enamel. With Schellbach stripes.
 Intermediate stopcock allows residual reagent in the burette after titration to be recycled into the reservoir.
 Automatic zero point setting. Calibrated to deliver (EX). Choice of models, either with needle-valve stopcock with PTFE spindle (intermediate stopcock with PTFE-key) or with NS glass stopcock (intermediate stopcock with glass key).
 All BLAUBRAND® burettes are delivered with batch number and one batch certificate included per pack. Also available with individual works, USP or DAkkS (former DKD) calibration certificate, please enquire. The batch certificate is also available to download from the manufacturer's website.

Capacity	Grad.	Tolerance	Stopcock	PK	Cat. No.
ml	ml	± ml			
10	0.02	0.02	PTFE	1	7.609 930
25	0.05	0.03	PTFE	1	7.602 941
50	0.1	0.05	PTFE	1	7.631 635

**3** Automatic burettes, Pellet pattern, borosilicate glass 3.3, class B, without stopcock

SILBERBRAND, class B. Boro 3.3. DIN EN ISO 385. Calibrated to deliver (TD, EX). *BRAND*
 Schellbach stripe. With needle-valve stopcock with PTFE spindle. Automatic zeroing.
 Total height approx. 1 m incl. 2000 ml bottle (soda-lime glass).

Description	Capacity	Grad.	Tolerance	PK	Cat. No.
	ml	ml	± ml		
with bottle	10	0.02	0.03	1	7.018 326
with bottle	25	0.05	0.05	1	7.018 327
with bottle	50	0.1	0.08	1	7.018 328
without bottle	10	0.02	0.03	1	7.300 388
without bottle	25	0.05	0.05	1	7.077 524
without bottle	50	0.1	0.08	1	7.076 570





1 Automatic burettes, Pellet pattern, borosilicate glass 5.4 amber, class B, with stopcock

Amber borosilicate glass type 5.4.SILBERBRAND. With intermediate stopcock.
25ml: Class B, Tolerance to DIN EN ISO 385.
50ml: Class B, to DIN EN ISO 385.

BRAND

Automatic zero point setting. Graduations and inscriptions in white enamel. Intermediate stopcock for evacuation of remaining liquid. Calibrated to deliver (EX). Choice of models, either with PTFE or glass key dispensing and intermediate stopcocks. With 2-litre soda-lime glass reservoir (160mm dia. x 200mm height, with 29/32 ground glass neck) as indicated. Overall height with bottle approx. 1m.

Description	Capacity	Grad.	Tolerance	Keys	PK	Cat. No.
	ml	ml	± ml			
with bottle	25*	0.1	0.08	PTFE	1	9.270 540
with bottle	50	0.1	0.1	PTFE	1	9.270 542
without bottle	25*	0.1	0.08	PTFE	1	7.200 776
without bottle	50	0.1	0.1	PTFE	1	7.200 775

* Narrower divisions.

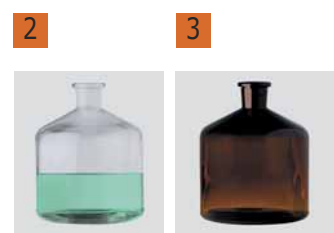

2 3 Burette bottles, borosilicate glass 3.3

Burette bottle for automatic burettes is made from heat resistant glass.
Each bottle has a NS 29/32 neck grinding that fits to burette.

Colour	Capacity	Diam.	Height	PK	Cat. No.
	ml	mm	mm		
clear	1000	110	200	1	9.270 905
clear	2000	160	200	1	6.237 628
brown	2000	160	200	1	6.238 474



4 Spare reservoir bottles, glass

Boro 3.3. Available in clear glass or amber glass or soda-lime glass.
Volume: 2000ml, diameter: 160mm, height: 200mm.

BRAND

Colour	Capacity	Diam.	Height	Material	PK	Cat. No.
	ml	mm	mm			
clear	2000	160	200	Boro 3.3	1	6.018 346
amber	2000	160	200	Boro 3.3	1	6.018 347
clear	2000	160	200	Soda-lime glass	1	7.059 541
amber	2000	160	200	Soda-lime glass	1	7.400 768



5 Orsat blowball

Natural rubber. Translucent.

Deutsch & Neumann

Type	PK	Cat. No.
Orsat blowball	1	9.115 510



6 Hand bellows

Single spray. Without net.
Size 3.

Deutsch & Neumann

Type	PK	Cat. No.
Hand bellows	1	9.270 995



7 Hand bellows

Double spray. With net.
Size 5.

Deutsch & Neumann

Type	PK	Cat. No.
Hand bellows	1	9.270 990

1 2 Digital Burettes, VITLAB® continuous

The pulse-free, dispensing operation of the Continuous burettes makes titration safer at high-level precision. The Continuous series can be used for titration agents up to a concentration of 1 Mol/l. The patented dual pistons pump provides permanent and pulse-free the liquid requested. Refills are not necessary. The Continuous burette series undercuts the margins of error defined by DIN EN ISO 8655-3 especially in partial volumes. All operation controls and the digital display have an ergonomic and functional design and are arranged clearly.

VITLAB

- Pulse-free dispensing technique for continuous and quick titration
- patented recirculation valve avoids reagent waste
- Clear and precise display of titrated volume
- Battery-operated, easily replaceable micro-batteries (1.5V)
- Dispensing volume per hand wheel revolution: 2.5ml (Continuous E), 5.0ml (Continuous RS)
- Device can be rotated on the bottle 360°
- Telescopic discharge tube extendible from 140 to 220mm
- Telescopic filling tube extendible from 200 to 350mm
- Adapters for drying tube and filter
- Certificate of conformity according to DIN 12600

Supplied with: Burette continuous, 3 PP adapter (GL 32, GL 38, S 40), 1 telescopic suction tube, 1 telescopic discharge tube, 2 micro batteries 1.5 V (LR 03/AAA), manual, quality certificate.

1



2



Type	Capacity ml	Capacity/U ml	Neck thread GL	Accuracy max. vol. (± R%)	Precision max. vol. (≤ CV%)	PK	Cat. No.
E	2.5	2.5	45	0,2*	0,1*	1	9.284 020
RS	5.0	5.0	45	0,2*	0,1*	1	9.284 021

* Accuracy and Coefficient of variation according to DIN EN ISO 8655-3

3 Digital burettes, solarus®

A titration unit with a reagent recirculation system for manual titration directly from the reagent bottle. Power supplied by a solar cell. Available in three volumes (10 ml, 20 ml and 50 ml). The world's first digital burette with integrated solar cell. The power supply for the electronics and display is derived exclusively from an integrated solar cell. Easily replaceable valves. The vivid digital display prevents meniscus reading errors and is always clearly legible, regardless of the viewing angle. The handwheels with soft touch surface are ergonomically optimised for particularly precise control.

Hirschmann

- Power supplied by a solar cell
- Free rotation
- Media recirculating system for simple and rapid venting without reagent loss
- Handwheels with soft touch surface
- Clearly legible display, regardless of the viewing angle
- A light protection window for the valve block is also included in the scope of delivery
- Individual calibration of user-specified adaptations with "Quick-Cal"
- Discharge valves and valve seats consisting of high-purity aluminium oxide ceramic
- Serial bidirectional interface (RS 232 and USB)

Supplied with: solarus® with A 45 mm thread, 3 thread adapters (A 32, A 38 and S 40), discharge tube, 1 suction tube with retainer screw, 1 spanner for valve, brown light protection window, with individual serial number and single calibration report.

3



Description	Accuracy max. vol. (± R%)	Precision max. vol. (≤ CV%)	PK	Cat. No.
Capacity 10 ml	0.3	0.1	1	9.287 779
Capacity 20 ml	0.2	0.1	1	9.287 780
Capacity 50 ml	0.2	0.1	1	9.287 781
Interface cable			1	9.287 756

Suitable accessories can be found in our online shop.



1 Bottle top burette Titrette®

For quickly and reliably titration with highest precision, even in close quarters, with no mains supply needed - in the lab, in production, or in the field! The Titrette® bottle-top burette has an innovative new measuring system which matches the Class A accuracy of glass burettes and, if needed, can offer the precision of 3 decimal places below 20ml. This is an important feature for users who need to work within the Class A error limits as with glass burettes according to DIN EN ISO 385 (e.g., pharmaceutical work). The titrating tube can be adjusted horizontally and vertically. This provides flexibility when positioning the instrument, e.g., when using a magnetic stirrer or different bottle sizes.

BRAND

- High accuracy
- Smooth-running operation for sensitive, drop-wise titration and fast filling of the device
- Compact design
- Light and stable, easy handling
- No switching between fill and titrate
- Simple maintenance
- Cleaning and parts replacement right in the lab
- Titrette® SH to determinate the acid content of milk and liquid dairy according to Soxhlet-Henkel ($4^{\circ}\text{SH} = 1\text{ml}$)

Items supplied: Titrette® bottle-top burette, DE-M marking, performance certificate, telescoping filling tube (170 to 330 mm), recirculation tube, 2 x 1.5V batteries (AAA/UM4/LR03), 4 x PP bottle adapters (GL45/32, GL 45/38, GL 45/S40 and GL32/NS 29/32), 2 coloured light shield inspection windows, operating manual.

Volume ml	Accuracy max. vol. ($\pm R\%$)	Precision max. vol. ($\leq CV\%$)	Interface	Description	PK	Cat. No.
$^{\circ}\text{SH}$ (25)	0.07	0.025	without	Incl. performance certificate	1	4.007 918
10	0.10	0.05	without	Incl. performance certificate	1	6.259 209
25	0.07	0.025	without	Incl. performance certificate	1	9.271 332
25	0.07	0.025	without	Incl. DAkkS calibration certificate	1	7.658 501
50	0.06	0.02	without	Incl. performance certificate	1	9.271 333
50	0.06	0.02	without	Incl. DAkkS calibration certificate	1	6.233 892
10	0.10	0.05	incl.	Incl. performance certificate	1	9.271 338
25	0.07	0.025	incl.	Incl. performance certificate	1	9.271 334
50	0.06	0.02	incl.	Incl. performance certificate	1	9.271 335

Suitable accessories can be found in our online shop.

2

2 Digital-burette, opus®

A titration unit with a reagent recirculation system for motor-powered titration directly from the reagent bottle. Available in three volumes (10 ml, 20 ml and 50 ml). Electronic control of titration enables the achievement of reproducible results and precisely defined dynamics each time. Time-saving rapid titration with subsequent fine titration enhances accuracy and efficiency. The titration impulse triggered by the motor enables the achievement of a droplet break-up with output volumes from 10 μl to 99.999 ml and delivers resolutions up to the third decimal place.

Hirschmann



- Electronic control and dispensing of volumes
- A light protection window for the valve block is also included in the scope of delivery
- Titration impulse triggered by the motor enables the achievement of a droplet break up from 10 μl for precision determination
- Media recirculating system for simple and rapid venting without reagent loss
- Free rotation
- TFT touchscreen with user-friendly menu
- Method memory for nine different titration procedures with storage of all settings
- USB and RS232 interface for PC connection
- Integration in automated procedures possible
- Discharge valves and valve seats consisting of high-purity aluminium oxide ceramic
- Power supply 100-240V, with EU, UK, US plug

Supplied with: opus® titration complete with thread 45 mm, 3 adapters (A 32, A 38 and S 40), 1 screw coupled suction tube, 1 titration discharge unit and 1 power supply, 1 brown light protection window, touch screen module "titration", Data Power Cable 0.75 m, instruction manual, single calibration report.

Description	Accuracy max. vol. ($\pm R\%$)	Precision max. vol. ($\leq CV\%$)	PK	Cat. No.
Volume 10 ml	0.6	0.2	1	9.287 875
Volume 20 ml	0.6	0.2	1	9.287 870
Volume 50 ml	0.6	0.2	1	9.287 871

1 Motor-driven piston burette Titronic® 300

1

Motor-driven piston burette with 20 or 50ml dosing unit. For manual titrations and highly precise dosing tasks. The TITRONIC® 300 can be completely controlled from a PC via the USB- or RS-232-interface. Up to 16 burettes can be connected to one another via the RS232 interface according to the daisy chain principle.

SI Analytics

T 300/20 M1: Basic unit without magnetic stirrer with ready to use assembled 20 ml dosing unit TZ 3130 with hoses, fittings and titration tip, controller TZ 3880, titration clamp Z 305, stand rod TZ 1748 and power supply 100-240 V

T 300/50 M1: as T 300/20 M1, only with ready to use assembled 50 ml dosing unit TZ 3160

T 300/20 M2: as T 300/20 M1, additionally with magnetic stirrer TM 50

T 300/50 M2: as T 300/20 M2, only with ready to use assembled 50 ml dosing unit TZ 3160



Specifications

Interfaces:	USB A and B, 2x RS 232
Stirrer connection:	TM 50 power supply directly through piston burette
Keyboard connection:	The unit is operated using the keys on the device itself, the controller TZ 3880 and optional PC-keyboard (USB)
Display:	graphics-capable TFT display
Volume indicator:	000.005 to 9999.999 ml
Display resolution:	0.005
Dosing speed:	max. 100ml/min (with 50 ml unit)
Fill time:	30secs. to 999secs. adjustable (time depends on cylinder volume)
Dosing units:	20ml or 50ml dosing unit, interchangeable
Burette resolution:	8000
Dispensing accuracy:	0.15% system measurement deviation, 0.05% accidental measurement deviation determined in accordance with EN ISO 8665, Part 3
Supply requirements:	230V, 50/60Hz
Conformity:	ISO 8665, Part 6
CE mark:	EMC: 2004/108/EG; safety EG- Directive 2006/95

Type	Burette attachment ml	PK	Cat. No.
T 300/20 M1	20	1	9.863 180
T 300/50 M1	50	1	9.863 181
T 300/20 M2	20	1	9.863 182
T 300/50 M2	50	1	9.863 183



1 Motor-driven piston burette TITRONIC® 500

Motor-driven piston burette with intelligent exchangeable dosing units with automatic recognition of unit size and reagent data. *SI Analytics*
 Besides manual titration and highly precise dosing tasks the TITRONIC® 500 can also be used for the preparation of solutions by entering the weights. The connection of an analytical balance allows the easy automatization of the solution preparation. The TITRONIC® 500 can completely controlled from a PC via the USB- or RS-232-interface. Up to 16 burettes can be connected to one another via the RS232 interface according to the daisy chain principle.

T 500: TITRONIC® 500 basic unit without magnetic stirrer, with stand rod TZ 1510, titration clamp Z 305, controller TZ 3880, power supply 100 - 240 V

T 500-M1: TITRONIC® 500 basic unit with magnetic stirrer TM 235, with stand rod TZ 1510, titration clamp Z 305, controller TZ 3880, power supply 100 - 240 V

T 500-M2/20: TITRONIC® 500 basic unit with magnetic stirrer TM 235 and exchangeable unit WA 20, with stand rod TZ 1510, titration clamp Z 305, controller TZ 3880, power supply 100 - 240 V

Technical specification

Interfaces:	3x USB (2 x USB A and 1x USB B), 2 x RS-232-C, 1 x LAN
Stirrer connection:	TM 235 or alternative paddle stirrer
Keyboard:	The unit is operated using the keys on the device itself, the controller TZ 3880 and optional PC-keyboard (USB)
Display:	graphics-capable 3.5" TFT display
Volume display:	00.00 to 999.9ml
Display resolution:	0.001ml (depending on exchangeable unit)
Dosing speed:	max. 100ml/min (with 50ml unit)
Filling speed:	min. 20 to 999 sec adjustable (time according to the cylinder volume)
Exchangeable units:	5, 10, 20ml or 50ml exchangeable units with reagent recognition
Burette resolution:	20000 steps
Dosing accuracy:	systematic error 0.15%, random error 0.05% in compliance with EN ISO 8655-6
Power supply:	100-240V; 50/60Hz
Conformity:	ISO 8655, part 6
CE-mark:	EMC: 2004/108/EG; safety EG- Directive 2006/95

Type	Description	PK	Cat. No.
T 500	Basic unit	1	9.863 210
T 500-M1	With magnetic stirrer	1	9.863 211
T 500-M2/20	With magnetic stirrer and 20ml exchangeable unit	1	9.863 212

1



Accessories for TITRONIC® 500 and TitroLine® 7000/7500 KF/7750/7800

SI Analytics

Type	Description	PK	Cat. No.
TM 235	Magnetic stirrer	1	9.863 154
WA 05	5ml exchangeable unit, complete	1	9.863 155
WA 10	10ml exchangeable unit, complete	1	9.863 156
WA 20	20ml exchangeable unit, complete	1	9.863 157
WA 50	50ml exchangeable unit, complete	1	9.863 158
TZ 3835	USB keyboard	1	9.863 159

1 Automatic Titrators TitroLine® 5000

1

Very compact titrator for simple routine titrations. Thanks to the standard methods the creating of methods is no longer required. Just load the method and press the start button. GLP compliant results with titration curve can be documented on a connected printer or USB-memory stick.

SI Analytics

- Following titration modes are possible:
- Titrations to pH, mV and μA endpoint (2 EP)
- Titrations to one equivalence point (pH und mV) with dynamic or linear titration addition
- Manual titrations with the controller
- Dosing tasks
- Number of methods: 5

Typical applications for the TitroLine® 5000 are:

- Salt content in foodstuffs (cheese, soy sauce, ketchup)
- Total acidity in wine and beverages
- Nitrogen according to Kjeldahl
- Chloride in drinking water and other samples
- Alkalinity (p + m-value)
- FOS/TAC

Supplied with:

TL 5000/20 M1: Basic unit without electrode, with ready to use assembled 20 ml dosing unit TZ 3130 with hoses, fittings and titration tip, controller TZ 3880, titration clamp Z 305, stand rod TZ 1748 magnetic stirrer TM 50 and power supply 100-240 V

TL 5000/50 M1: as TL 5000/20 M1, only with ready to use assembled 50 ml dosing unit TZ 3160

TL 5000/20 M2: as TL 5000/20 M1, additionally with pH combination electrode and buffer set

TL 5000/50 M2: as TL 5000/20 M2, only with ready to use assembled 50 ml dosing unit TZ 3160

TL 5000/20 M3: as TL 5000/20 M1 additionally with Ag electrode and electrode cable

**Specifications**

Measuring input electrode	pH/mV-input with DIN or BNC socket
Measuring input Pt 1000/NTC 30:	Temperature sensor connection for resistance probes Pt 1000 or NTC 30 (socket: 2 x 4 mm)
Interfaces:	1 x USB A und 1 x USB-B 2 x RS-232-C
Stirrer connection:	TM 50 power supply directly through piston burette
Keyboard:	The unit is operated using the keys on the device itself, the controller TZ 3880 and optional PC-keyboard (USB)
Display:	graphics-capable TFT display
Dosing units:	20 ml or 50 ml dosing unit, interchangeable
Burette resolution:	8000
Dosing accuracy:	systematic error 0.15 %, random error 0.05 % in compliance with EN ISO 8655-6
Supply requirements:	230V, 50/60Hz
Conformity:	ISO 8655, part 6
CE-mark:	EMC: 2004/108/EG; safety EG- Directive 2006/95

Type	PK	Cat. No.
TL 5000/20 M1	1	9.863 184
TL 5000/50 M1	1	9.863 185
TL 5000/20 M2	1	9.863 186
TL 5000/50 M2	1	9.863 187
TL 5000/20 M3	1	9.863 191

Accessories for Titronic® 300 and TitroLine® 5000

SI Analytics

Type	Description	PK	Cat. No.
TM 50	Magnetic stirrer	1	9.863 188
TZ 3835	USB keyboard	1	9.863 159
TZ 3830	USB-HUB	1	9.863 189
TZ3803	Reagent bottle brown, 1 Litre	1	9.863 190

1 Automatic Titrators, TitroLine® 7000

Compact titrator with intelligent exchangeable units with automatic recognition of unit size and reagent data.

SI Analytics

Thanks to the modern USB- and additional RS232 interfaces, connection of printer, balance and further accessories are possible at the same time.

The brilliant, very high-contrast TFT-display allows the easy parameterisation and tracking of the titration curve.

Supplied with:

TL 7000-M1/10: basic unit with magnetic stirrer TM 235 and 10ml exchangeable unit WA 10, incl. amber glass bottle for titration reagent, GL 45 and S 40-bottle adapter, tubes, drip off tube and titration tip.

TL 7000-M1/20: basic unit with magnetic stirrer TM 235 and 20ml exchangeable unit WA 20, incl. amber glass bottle for titration reagent, GL 45 and S 40-bottle adapter, tubes, drip off tube and titration tip.

TL 7000-M1/50: basic unit with magnetic stirrer TM 235 and 50ml exchangeable unit WA 50, incl. amber glass bottle for titration reagent, GL 45 and S 40-bottle adapter, tubes, drip off tube and titration tip.

TL 7000-M2/20: basic unit with magnetic stirrer TM 235 and 20ml exchangeable unit WA 20, incl. amber glass bottle for titration reagent, GL 45 and S 40-bottle adapter, tubes, drip off tube and titration tip. With pH-combination electrode IL-pHT-A120MF-DIN-N and buffer set.

Technical specification

Measuring input pH/mV:

pH/mV-input with DIN or BNC socket, **TitroLine® 7000 additionally with ID function for automatic detection of electrode**

Measuring input Dead Stop:

µA-input for double platinum electrode (socket 2 x 4mm), pole voltage adjustable

Temperature:

for resistance probes Pt 1000 (socket: 2 x 4mm)

Interfaces:

3 x USB (2 x USB-A und 1 x USB-B), 2 x RS-232-C, 1 x LAN

Stirrer connection:

TM 235 or alternative paddle stirrer

Keyboard:

The unit is operated using the keys on the device itself, the controller TZ 3880

Display:

graphics-capable 3.5" TFT display

Exchangeable units:

5, 10, 20ml or 50ml exchangeable units with reagent recognition

Burette resolution:

20000 steps

Dosing accuracy:

systematic error 0.15%, random error 0.05-0.07% in compliance with EN ISO 8655-6

Supply requirements:

100-240V; 50/60Hz

Conformity:

ISO 8655, part 6

CE-mark:

EMC: 2004/108/EG; safety EG- Directive 2006/95

Type	Description	PK	Cat. No.
TL 7000-M1/10	With 10ml exchangeable unit	1	9.863 160
TL 7000-M1/20	With 20ml exchangeable unit	1	9.863 161
TL 7000-M1/50	With 50ml exchangeable unit	1	9.863 162
TL 7000-M2/20	With 20ml exchangeable unit and pH Electrode	1	9.863 163

1



KF Titrators TitroLine 7500® KF/TitroLine 7500® KF trace

You cannot go wrong with the TitroLine® KF titrators from SI-Analytix. The TitroLine® 7500 KF is the volumetric generalist for a wide range of use and the TitroLine® 7500 KF trace is the specialist for low water contents.

SI Analytix

Both titrators are to be characterized by following features:

- Fast, easy and precise
- With standard methods for different applications (titer determination, blank value...)
- High visible full color display, that can be easily viewed from a distance and extreme angles
- Storage of results via USB and LAN port (PDF and CSV -format)
- with online curve
- With intelligent interchangeable modules (only TitroLine® 7500 KF)

Applications TitroLine 7500® KF: KF volumetry, dead-stop-titrations (SO₂, bromine number)

Applications TitroLine 7500® KF trace: KF coulometry, bromine number

Volumetric KF-Titrators supplied with:

TL 7500 KF 05: titrator unit, interchangeable module WA 05, TM 235 KF titration stand with integrated stirrer and pump, titration vessel TZ 1770, micro-dual platinum electrode KF 1100 and starter kit, power supply 100-240 V

TL 7500 KF 10: titrator unit, interchangeable module WA 10, TM 235 KF titration stand with integrated stirrer and pump, titration vessel TZ 1770, micro-dual platinum electrode KF 1100 and starter kit, power supply 100-240 V

TL 7500 KF 20: titrator unit, interchangeable module WA 20, TM 235 KF titration stand with integrated stirrer and pump, titration vessel TZ 1770, micro-dual platinum electrode KF 1100 and starter kit, power supply 100-240 V

Coulometric KF-titrators supplied with:

TL 7500 KF trace M1: titrator unit, generator electrode TZ 1752 without diaphragm, magnetic stirrer TM 235, titration vessel TZ 1751, micro-dual platinum electrode KF 1150, support rod

TL 7500 KF trace M2: titrator unit, generator electrode TZ 1752 without diaphragm, TM 235 KF titration stand with integrated stirrer and pump, titration vessel TZ 1754, micro-dual platinum electrode KF 1150, support rod

TL 7500 KF trace M3: titrator unit, generator electrode TZ 1753 with diaphragm, magnetic stirrer TM 235, titration vessel TZ 1751, micro-dual platinum electrode KF 1150, support rod

TL 7500 KF trace M4: titrator unit, generator electrode TZ 1753 with diaphragm, TM 235 KF titration stand with integrated stirrer and pump, titration vessel TZ 1754, micro-dual platinum electrode KF 1150, support rod

TL 7500 KF trace M6: titrator unit, generator electrode TZ 1752 without diaphragm, titration stand TM 235 TO, titration vessel TZ 1754, micro-dual platinum electrode KF 1150, connection cable TZ 3094

Specifications

Measuring range TitroLine 7500® KF:	10ppm - 100%
Dosing accuracy:	<0.15%
Measuring range TitroLine 7500® KF trace:	1ppm - 5% (10µg to 100mg)
Accuracy:	0.3% at 1mg water
Number of user methods:	50
Printer:	HP PCL, Seiko DPU S 445, PDF
Interface:	2 x USB-A, 1 x USB-B, 2 x RS 232, 1 x LAN
PC Software:	TitriSoft 3.5

Type	PK	Cat. No.
TL 7500 KF 05	1	9.863 170
TL 7500 KF 10	1	6.255 582 ¹
TL 7500 KF 20	1	9.863 171
TL 7500 KF trace M1	1	9.863 172
TL 7500 KF trace M2	1	9.863 173
TL 7500 KF trace M3	1	9.863 174
TL 7500 KF trace M4	1	9.863 175
TL 7500 KF trace M6	1	6.314 327 ²



6.255 582



6.314 327

1 Titrators TitroLine 7750®

Titroline® 7750 is the all-rounder for both potentiometric titration and volumetric KF titration. The TitroLine® 7750 combines the features of the potentiometric titrator TitroLine® 7000 and the volumetric Karl Fischer titrator TitroLine® 7500.

SI Analytics

The new TitroLine® 7750 is characterized as follows:

- Highly visible full color display, that can be easily viewed from a distance and extreme angles
- With new interchangeable modules which all relevant reagent and unit data can be stored
- Thanks to the 2 x USB-host, 1 x USB-PC and 2 x RS232 ports, very communicable. Connect for example, USB keyboard, USB printer, barcode reader, USB flash drives, balances, PC und further SI Analytics devices such as piston burettes and sample changers
- Storage of results via USB and LAN port (PDF and CSV -format) including method transfer
- With standard methods for potentiometric and KF titration

Supplied with:

TL 7750: Basic unit without magnetic stirrer, with stand rod TZ 1510, titration clamp Z 305, keyboard TZ 3835 and power supply 100-240 V

TL 7750-M1: as TL 7750, additionally with magnetic stirrer TM 235

TL 7750-TitriSoft: as TL 7750-M1, additionally with TitriSoft 3.0 (TZ 3071)

TL 7750 KF 05: Titrator unit, exchange unit WA 05, TM 235 KF titration stand with integrated stirrer and pump, titration vessel TZ 1770, micro double platinum electrode KF 1100 and starter kit, power supply 100-240 V

TL 7750 KF 10: as TL 7750 KF 05, only with exchange unit WA 10

TL 7750 KF 20: as TL 7750 KF 05, only with exchange unit WA 20

Type	PK	Cat. No.
TL 7750	1	9.863 176
TL 7750-M1	1	6.258 235
TL 7750-TitriSoft	1	9.863 177
TL7750 KF 05	1	9.863 178
TL7750 KF 10	1	7.981 381
TL7750 KF 20	1	9.863 179

2 Titrators TitroLine® 7800

The TitroLine® 7800 is the new all-rounder for potentiometric titration with an additional digital measuring input.

SI Analytics

That enable for example the connection and use of pH and conductivity sensors at the same time.

An additional external conductometer is not required anymore. The TitroLine® 7800 can also be used as volumetric KF titrator.

The TitroLine® 7800 is to be characterized by following features:

- High visible full color display, that can be easily viewed from a distance and extreme angles
- With intelligent interchangeable modules and storage of all relevant reagent data
- Includes two USB-A, one USB-B, two RS-232 and one LAN port for expansion and connection of devices such as keyboard, printer, barcode reader, memory sticks, balances, PC an further SI Analytics devices
- Storage of results via USB and LAN port (PDF and CSV -format) including method transfer
- With one analogue and one digital measuring input. The digital input allows the connection of digital (IDS) pH and conductivity sensors.
- With standard methods for potentiometric and KF titration

Supplied with: Basic unit with or without magnetic stirrer, with stand rod TZ 1510, titration clamp Z 305, keyboard TZ 3835 and power supply 100-240 V

Type	PK	Cat. No.
TL 7800 (without magnetic stirrer)	1	9.863 168
TL 7800-M1 (with magnetic stirrer)	1	9.863 169



1 Drum pump Pump-it®

For rapid and clean emptying from cans, drums and small barrels up to 60L.

Bürkle

- Precise dosing, without dripping
- Pump connection suitable for 64mm dia. (BSI) container threads
- stepless length adjustment of immersion tube
- Threaded adapters for most commercially-sold containers available
- Not suitable for HCl



Immersion depth mm	Flow rate L / min.	Material	PK	Cat. No.
1000	8	PP/FKM	1	9.001 110

2 Adapter set for Pump-it® container pump

Adapter set consisting of:

- 2" Coarse thread, Mauser, green
- 2" coarse thread, Tri-Sure®, brown
- 2" Fine thread steel drum, blue
- DIN 60, black
- DIN 51, black

Bürkle



Type	PK	Cat. No.
Adapter set for Pump-it can pump	1	9.001 111

3 Drum Pump PumpMaster

Drum pump PumpMaster with gasket of FKM for acids and chemical liquid. The manual pressure pump is ideally suited for drawing off, decanting and emptying canisters and barrels. The hand pump is used to create excess pressure that forces the liquid out of the container. The stopcock also allows extraction of small quantities of liquid. The PumpMaster container pump is mounted on the container using a flexible stopper with a variable and adjustable diameter. No special thread adapters are required. PumpMaster fits all commercial container openings with a diameter from 46.5 mm to 60 mm. The immersion tube has a length of 95 cm and it can be shortened depending on the size of the container.

Bürkle



Scope of supply: Complete with three bungs in different sizes.

Material	Immersion depth mm	Flow rate l / min.	PK	Cat. No.
PP/PE	95	approx. 8	1	6.259 907

4 Foot pumps OTAL

For jerry cans and balloons up to 120 l capacity. Universal bungs for container openings of 30 to 70 mm diameter.

Bürkle

PP: weak acids, caustic solutions and detergents

PVDF: suitable for acids and alkalis, chlorine bleaching, not for strongly oxidizing acids and caustic solutions

Stainless steel: solvents and liquids of VbF Hazard Class AIII (not easily flammable)



Description	Diam. mm	Immersion depth mm	Flow rate L / min.	Material	PK	Cat. No.
Foot pump with tube and stopcock	12	700	12	PP / PVC dispensing tube	1	9.001 133
Foot pump	15	700	20	PP	1	9.001 015
Foot pump	16	700	20	PVDF	1	9.001 130
Foot pump	18	700	26	PP	1	9.001 018
Foot pump	18	900	26	Stainless steel tubing	1	9.001 132
Foot pump	22	900	30	PP	1	9.001 022



1 Hand pumps OtaI

For jerry cans and ballons up to 60l capacity. Universal bungs for container openings of 30 to 70mm diameter.

PP: weak acids, caustic solutions and detergents

PVDF: suitable for acids and alkalis, chlorine bleaching, not for strongly oxidizing acids and caustic solutions

Stainless steel: solvents and liquids of VbF Hazard Class AIII (not easily flammable)

Bürkle

Diam. mm	Immersion depth mm	Flow rate L / min.	Material	PK	Cat. No.
10	450	4	PP*	1	9.001 210
12	700	14	PP	1	9.001 112
15	700	20	PP	1	9.001 115
18	700	26	PP	1	9.001 118
16	700	20	PVDF	1	9.001 135
18	900	26	Stainless steel tubing	1	9.001 137
12	700	12	PP / PVC dispensing tube	1	9.001 138

*Miniature pump for container openings 20 to 36mm.



4.670 769

OTAL® disposable pumps with PE conveying pipes

Bürkle

Space-saving container pump for single use. The medium to be filled only comes into contact with the conveying pipe. The conveying pipe is made of one piece and can easily be shortened to the respective container height with the supplied cutter for good residual emptying. The disposable conveying pipe can be replaced quickly and easily after use.

Scope of supply: Pump ball, universal plug made of soft PVC for container openings of 30 - 70 mm Ø, cutter and 10 disposable conveying pipes

Type	Diam. mm	Immersion depth mm	Flow rate L / min.	PK	Cat. No.
OTAL® disposable foot pump	12	90	14	1	4.670 768
OTAL® disposable hand pump	12	90	14	1	4.670 769 2



3 Siphons

Transparent with stopcock. Simple to use, suitable for occasional dispensing of non-aggressive liquids from a higher drum to a lower vessel, following the siphoning principle.

Bürkle

Diam. mm	Immersion depth mm	Flow rate L / min.	Material	PK	Cat. No.
15	1000	9	LDPE/PVC	1	9.001 355



4 Barrel pumps, stainless steel

Stainless steel V2A and PTFE.

For safe dispensing of liquids with a low flash point . Electrostatic charge can be dissipated through accessories antistatic set and drum screwthread connection. Not suitable for acetone.

Bürkle

Description	Diam. mm	Immersion depth mm	PK	Cat. No.
rigid dispensing tube	32	570	1	9.001 340
rigid dispensing tube	32	910	1	9.001 341
flexible tubing with stopcock	32	570	1	9.001 362
flexible tubing with stopcock	32	910	1	9.001 363
Removable discharge tube	32	360	1	6.083 463
flexible tubing with stopcock	32	360	1	6.802 513



9.001 345



6.090 497

Barrel pumps, screw joints

Barrel screw joints for stainless steel drum pumps.

Constructed in nickel-plated brass. For containers with R2", internal steel barrel thread.

Bürkle

Description	PK	Cat. No.
Barrel screw joint 2"	1	9.001 345 5
Barrel screw joint, gas-tight 2", hermetic sealing	1	6.090 497 6

1 Barrel pumps, PP

- For decanting acids, caustic solutions and aggressive detergents
- Excellent recovery of residual liquid in the barrel provided by base-sitting, non-return valve and steplessly adjustable immersion tube
- For barrels and tanks from 30 to 1000l.

Bürkle



Type A: With rigid, angled, dispensing nozzle.
Type B: With flexible, PVC dispensing hose and stopcock.

Barrel screw joints and thread adapters for standard containers are available as optional accessories. Please order separately.

Immersion tube diam.: 32mm
Max. pump capacity: up to approx. 12 L/min.

Type	Immersion depth mm	Length mm	PK	Cat. No.
A	500	600	1	9.001 356
B	500	600	1	9.001 366
A	650	740	1	9.001 357
B	650	740	1	9.001 367
A	800	900	1	9.001 358
B	800	900	1	9.001 368
A	1000	1090	1	9.001 359
B	1000	1090	1	9.001 369
A	1250	1340	1	9.001 364
B	1250	1340	1	9.001 370
A	1500	1590	1	9.001 365
B	1500	1590	1	9.001 371

2 Barrel pump, PTFE

- For ultrapure and aggressive liquids
- Made of solid, pure white PTFE, giving an excellent chemical resistance to all media (with the exception of elemental fluorine)
- With stopcock to prevent the escape of harmful or hazardous liquids and unwanted drips
- Barrel screw joints are available as accessories

Bürkle



Description	Tube diam. mm	Immersion depth mm	Flow rate ml / pass	PK	Cat. No.
With discharge tube	32	400	180	1	4.665 336
With discharge tube	32	600	270	1	9.001 260
With discharge tube	32	950	400	1	6.801 515
With discharge hose	32	400	180	1	4.665 337
With discharge hose	32	600	270	1	7.639 613
With discharge hose	32	950	400	1	6.255 584

Screwthread connections for PP and PTFE drum pumps

Bürkle

Type	Material	PK	Cat. No.
Screwthread connection for R2", internal steel barrel thread	PP	1	9.001 335 3
Drum stoppers for drum openings from 40 to 70 mm	PVC	1	9.001 336 4
Screwthread connection for Mauser 2", internal coarse screwthread	PP	1	9.001 337 5
Screwthread connection for Tri-Sure®, internal coarse screwthread	PP	1	9.001 338 6
Screwthread connection R2" with counter nut, for drum openings of 60mm diam.	PP	1	9.001 347 7



8 Thread adapter set

NEW
Bürkle

- Thread adapter set consisting of:
- 3/4" Hünersdorff
 - 3/4" Kautex
 - 3/4" cylindrical R 3/4" barrel thread
 - 3/4" conical R 3/4" barrel thread
 - Hex wrench for threaded adapter

Type	PK	Cat. No.
Thread adapter set complete	1	6.076 152



1

1 Mini solvent pump

The self-closing discharge (with auto-stop function) of the Mini solvent pump ensures absolutely precise filling with no dripping at all. Dosing is even easy in very small containers such as test tubes, which present no problems. A hose can optionally be fastened onto the discharge spout (internal Ø 6 mm), thus making it possible to fill the container from a greater distance.

Bürkle

The Mini solvent pump is especially compact and very well balanced, which makes it possible to fill without tipping, even from very small containers.

Thanks to its sturdy design and high-quality materials, the Mini solvent pump consistently ensures neat and reliable filling throughout its long service life, easily and conveniently.

- Ideal for 1-5 l containers
- Connecting thread GL 45
- Parts in contact with medium made of PTFE and stainless steel (1.4301, 1.4404)
- PTFE hose (6 x 8 mm) 0.4 m
- Including grounding cable 2 m
- Adapters available as accessories for S 40, GL 38 and GL 32

Description	Flow rate l / min.	PK	Cat. No.
Mini solvent pump, GL 45	1.8	1	9.001 351
Adapter, PTFE for S 40		1	9.001 352
Adapter, ETFE for GL 38		1	9.001 353
Adapter, ETFE for GL 32		1	9.001 354

2

9.001 349

2 Solvent pump hand operated

For contamination-free removal of organic solvents and flavouring agents. Can be completely closed off with two ball valves so that no dangerous vapours can escape after dispensing. Electrostatic charge can be dissipated through the accessory antistatic set (please order separately).

Bürkle

- Medium-contacting parts are made of stainless steel (1.4301) and PTFE
- For containers up to 60 litres
- Suitable for containers with R 2" thread
- The solvent pump for tinfoil canisters has a connector thread for pull-out spouts

Description	Immersion depth mm	PK	Cat. No.
Hand pump	600	1	9.001 349 2
Hand pump for tinplate canisters	600	1	6.237 176

3

6.236 800

3 Solvent pump foot operated

For filling off high purity liquids such as solvents. Due to the barrel screw joint and the stopcock, the container and the pump can be hermetically sealed. Electrostatic charge can be dissipated through the accessory antistatic set (please order separately).

Bürkle

- Medium-contacting parts made of stainless steel (1.4301) and PTFE
- For barrels up to 220 litres, immersion tube can be steplessly adjusted to the barrel depth
- Suitable for steel barrels with R 2" thread

Description	Immersion depth mm	Flow rate L / min.	PK	Cat. No.
Foot pump with rigid angled tube	950	30	1	9.001 134
Foot pump with flexible tubing	950	30	1	6.236 800 3

4

4 Drum pumps GLP 25

GLP 25 is your ideal helper for clean and safe liquid transfer from small containers and drums up to 220 litres. Various media such as acids and bases low concentrated, dies, emulsions, dispersions and low-viscosity liquids can be measured out without any problems. Wetted materials are PP, stainless steel and Viton®. The pump is therefore additionally media resistant against aggressive liquids. Driveshaft made from stainless steel. Delivery rates from 1 to 20 l/min adjustable. Pump Set supplied with: motor, pump unit, PP, 3/4" dia. inlet tubing (length 500, 700 or 1000mm), PP discharge tubing, 250mm long and adapter for drum necks of 40 to 58mm.

Grün-Pumpen

Description	Length mm	PK	Cat. No.
Pump set	500	1	9.001 410
Pump set	700	1	9.001 411
Pump set	1000	1	9.001 412

1 2 Accessories for drum pumps GLP 25

Grün-Pumpen

Description	PK	Cat. No.
Motor for all pump units	1	9.001 400
Pump unit with inlet tubing length 500mm, incl. discharge tube	1	9.001 401
Pump unit with inlet tubing length 700mm, incl. discharge tube	1	9.001 402
Pump unit with inlet tubing length 1000mm, incl. discharge tube	1	9.001 403
Discharge tube PP, length 25cm	1	9.001 404
Adapter PP, diam. 65 to 70mm	1	9.001 405
Nozzle PP, reinforced PVC outlet tubing 1.5m, DN19	1	9.001 406



3 4 5 Barrel pumps AccuOne and EnergyOne

The pumps are equipped with two different power supply systems: AccuOne, driven by a high-performance rechargeable battery or EnergyOne, with a power cable for direct connection to mains electricity. Innovative new feature: The power supply units are interchangeable! The rechargeable battery or the power supply unit are fitted with a clip lock and are removable. They can be exchanged quickly and easily. Thus AccuOne can also be operated with the power supply cable unit and EnergyOne can be operated with the rechargeable battery. The Drive can also be disconnected quickly and easily from the pump station with a clip lock. This makes it possible to use one drive for filling at several stationary pump stations. AccuOne and EnergyOne are designed for applications in which even very small amounts of liquid can be added to small containers with narrow openings. The TouchPanel is sealed against dust, dirt and water. By a foil Keyboard it can be used to regulate the flow rate continuously and precisely from 0.4l/min to 12 l/min. The light and powerful pumps are made of high-quality materials, PP, PTFE and Hastelloy C, to ensure outstanding chemical resistance. Please make note of detailed information related to chemical resistance!

Bürkle

	AccuOne EnergyOne
Maximum pumping capacity:	12 l/min
Weight:	750 g 580 g
Discharge connection:	3/4"
Shaft:	Hastelloy C
Pump station, Seals:	PP, PTFE
Power supply:	Battery Li-Ion (up to 600l) 230V incl. international plug adapter



Type	Description	Tube length mm	PK	Cat. No.
AccuOne	with rechargeable battery, rigid discharge tube and charger	500	1	9.001 420
AccuOne	with rechargeable battery, rigid discharge tube and charger	700	1	9.001 421
AccuOne	with rechargeable battery, rigid discharge tube and charger	1000	1	9.001 422
EnergyOne	with power supply unit and rigid discharge tube	500	1	9.001 423
EnergyOne	with power supply unit and rigid discharge tube	700	1	9.001 424
EnergyOne	with power supply unit and rigid discharge tube	1000	1	9.001 425

Suitable accessories can be found in our online shop.

Flow meter TR3

NEW

Can be combined with all drum and container pumps. For thin-bodied fluids.

- Measurement according to the turbine wheel principle
- Free-rotatable after assembly
- Variable display alignment
- Large illuminated display
- Simultaneous display of subset (4-digit) and total quantity (7-digit)
- Display of the partial and total volume
- Customary 1.5 V batteries (AAA)

Specifications

Measuring range:	5 ... 120 l/min
Viscosity range:	0.8 ... 40 mPas
Operating pressure:	max. 10 bar
Bursting pressure:	max. 20 bar
Power supply:	2 x 1.5 V batteries (AAA), replaceable
IP code:	IP 65

Connection	Material	PK	Cat. No.
G 1 1/4	PP	1	6.311 932 6
G 1	PP	1	6.311 933
G 1 1/4	PVDF	1	6.311 934 7

Lutz Pumpen



6.311 932

6.311 934

Pumps/Drum pumps-Peristaltic pumps

1



1 Drum pumps, mains-powered

Lightweight and powerful pump for transferring small amounts of aqueous liquids up to 300 mPas from cans and drums with infinitely variable speed controller.

Lutz Pumpen

- Motor 230 V, 200 W (IP 24)
- Seal less pump tube
- Suitable accessory flow meter required
- Pump with tubing connection

Two options:

- Polypropylene version for acids and alkalis
- Stainless steel version for low-viscosity lubricants

Available as a set (9.880 310-9.880 315) with 1.5 m PVC tubing, nozzle in polypropylene, wall bracket.

Set accessories: Lutz nozzle, 1.5 m PVC hose 3/4", hose connection, hose clamps, wall bracket (for pump B2 Vario PP-SL Ø 32 mm).

Type	Immersion tube diam.	Immersion depth	Delivery head	Flow rate	Material	PK	Cat. No.
	mm	mm	mWS	l / min.			
Pump	32	500	7.0	75	PP	1	9.880 300
Pump	32	700	7.0	75	PP	1	9.880 301
Pump	32	1000	7.0	75	PP	1	9.880 302
Pump	28	500	6.5	68	stainless steel	1	9.880 303
Pump	28	700	6.5	68	stainless steel	1	9.880 304
Pump	28	1000	6.5	68	stainless steel	1	9.880 305
Pump	32	700	7.0	75	PVDF	1	6.283 249
Pump set	32	500	7.0	75	PP	1	9.880 310
Pump set	32	700	7.0	75	PP	1	9.880 311
Pump set	32	1000	7.0	75	PP	1	9.880 312
Pump set	28	500	6.5	68	stainless steel	1	9.880 313
Pump set	28	700	6.5	68	stainless steel	1	9.880 314
Pump set	28	1000	6.5	68	stainless steel	1	9.880 315
Set accessories					PVC	1	7.930 292

2



2 Anti-static set

When dispensing combustible/explosive liquids pump, both dispensing and filling drum involved in the process must be sufficiently earthed, in order to prevent ignition or explosion through electrostatic discharges. Antistatic set, includes three colour-coded connecting cables with clamps, supplied complete in plastic case.

Bürkle

Type	PK	Cat. No.
Antistatic set	1	9.001 346

3



9.880 360

Horizontal centrifugal pumps, magnetically coupled

These new magnetic drive pumps are designed for pumping acids, bases, mixtures of acids and bases, solvents, photochemicals into alkali stripping baths, galvanic baths, as well as radioactive, sterile, expensive or highly corrosive liquids. The pumps are sealless. The impeller is driven by the magnetic force of the outer magnets, therefore no mechanical seal is required. As the pump housing is hermetically sealed no leaks can occur. The use of high performance, permanent magnets, ensures high transmission forces even at elevated temperatures.

Lutz Pumpen

- viscosity up to 20 mPas
- pump complete with flanged-to motor

4



9.880 361

Magnetic drive pump 15 Watt: Motor 230V, material PP (fibre-glass reinforced), stainless steel (shaft), Viton® (O-ring), tubing connection 14mm
 Magnetic drive pump 29 Watt: Motor 230V, material PP (fibre-glass reinforced), ceramics (shaft), Rulon (guide bearing), Viton® (O-ring), suction/discharge G 3/4" OT (BSP)

Description	Delivery head mWS	Flow rate L / min.	PK	Cat. No.
15 Watt, without thread	2	12	1	9.880 360 3
29 Watt, with 3/4" outer thread	3	24	1	9.880 361 4

1 Peristaltic pump LLG-uniPERISTALTICPUMP 1

NEW

1

The extra compact peristaltic pump. Ideal for continuous dosing applications. Space-saving, robust and with a wide range of easily exchangeable pump heads.

- Stable flow rates
- **Compact design**
- Reversible working direction
- Pump heads easily exchangeable
- Various pump heads with different hose diameters available as accessory
- Low power consumption
- Corrosion-resistant ABS housing
- OLED display for indication of speed and working direction

Scope of supply: Pump, pump head, PharMed® hose connectors 3 mm ID, 5 mm AD

Specifications

Speed range:	0.1 ... 150 min ⁻¹
Speed accuracy:	±0.1 min ⁻¹
Flow rate range:	0.004 ... 63.69 ml/min
Weight:	0.8 kg
Dimensions (W x D x H):	180 x 115 x 125 mm
IP code:	IP 31
Working temperature range:	0 ... 40 °C
Max. humidity:	80 %
Power rating:	10 W
Power supply:	100 ... 240 V, 50/60 Hz
Warranty:	3 years

Type	Plug type	PK	Cat. No.
LLG-uniPERISTALTICPUMP 1	EU	1	6.263 540
LLG-uniPERISTALTICPUMP 1	UK	1	6.263 541



2 Peristaltic pump LLG-uniPERISTALTICPUMP 3

NEW

2

The peristaltic pump with high pumping capacity. Ideal for continuous dosing applications. Space-saving, robust and with stable flow rate.

- **High pumping capacity of 398 ml/min**
- Reversible working direction
- Hose connectors easily exchangeable
- Low power consumption
- Corrosion-resistant ABS housing
- OLED display for indication of speed and working direction

Scope of supply: Pump, pump head, PharMed® hose connectors 6.4 mm ID, 9.6 mm AD

Specifications

Speed range:	0.1 ... 150 min ⁻¹
Speed accuracy:	±0.1 min ⁻¹
Flow rate range:	0.08 ... 398 ml/min
Weight:	0.8 kg
Dimensions (W x D x H):	190 x 128 x 135 mm
IP code:	IP 31
Working temperature range:	0 ... 40 °C
Max. humidity:	80 %
Power rating:	20 W
Power supply:	100 ... 240 V, 50/60 Hz
Warranty:	3 years

Type	Plug type	PK	Cat. No.
LLG-uniPERISTALTICPUMP 3	EU	1	6.263 550
LLG-uniPERISTALTICPUMP 3	UK	1	6.263 551



Accessories for LLG-uniPERISTALTICPUMP 1 and 3

Description	For	PK	Cat. No.
Pumphead with PharMed® tubing ID 1 mm	LLG-uniPERISTALTICPUMP 1	1	6.263 542
Pumphead with PharMed® tubing ID 2 mm	LLG-uniPERISTALTICPUMP 1	1	6.263 543
Pumphead with PharMed® tubing ID 3 mm	LLG-uniPERISTALTICPUMP 1	1	6.263 544
PharMed® tubing ID 1 mm with connector and Tube Clip	LLG-uniPERISTALTICPUMP 1	1	6.263 546
PharMed® tubing ID 2 mm with connector and Tube Clip	LLG-uniPERISTALTICPUMP 1	1	6.263 547
PharMed® tubing ID 3 mm with connector and Tube Clip	LLG-uniPERISTALTICPUMP 1	1	6.263 548
PharMed® tubing (ID: 3.1mm, OD: 6.3mm) with connector and Tube Clip	LLG-uniPERISTALTICPUMP 3	1	6.263 552
PharMed® tubing (ID: 4.8 mm, OD: 8 mm) with connector and Tube Clip	LLG-uniPERISTALTICPUMP 3	1	6.263 553
PharMed® tubing (ID: 6.4 mm, OD: 9.6 mm) with connector and Tube Clip	LLG-uniPERISTALTICPUMP 3	1	6.263 554

ID = Inner diameter
OD = Outer diameter

1

1 Laboratory peristaltic pumps, PLP

The behrotest peristaltic pumps PLP are suitable for the transport of watery solutions/non aggressive applications. They find their application in the laboratory, the food industry as well as in the analytical, medicinal or biological field.

Dülabo Laborgeräte

The RPM (rotation per minute) can be adjusted manually and the flow direction can be amended. These PLP pumps have angle connectors to which tubing can be attached either with or without additional brackets, depending on the tube size.

Type	Flow rate ml/min.	Weight g	PK	Cat. No.
PLP 33	7 - 33	1300	1	9.700 420
PLP 66	17 - 66	1300	1	9.700 421
PLP 330	66 - 400	1300	1	9.700 422
PLP 1000	250 - 1000	1440	1	9.700 423

2

6.287 159

Laboratory peristaltic pumps PLP 38

For the Dülabo peristaltic pump PLP38 there are different pump heads which can be used, this results in flexibility in your day to day usage, enabling multiple tubing sizes being applicable.

Dülabo Laborgeräte

Depending on the tubing material in use, this pump type can be used for various chemicals, corrosive and aggressive as well as sterile solutions.

The user friendly membrane keyboard enables the user to regulate the flow speed (RPM) using the switch arrays. Furthermore the user can make use of the special button on the membrane keyboard which activates a "quick flow mode".

Via RS485 or other external adapters for other signals, steering the pump externally is also possible. Additionally a foot switch can be attached to the pump to enable the pumping function as long as the foot switch is activated.

Specifications:

Speed:	0.1 to 100 rpm, reversible
Speed precision:	0.1 rpm
Speed control:	Membrane keypad
Display:	3-digit LED displays current rpm
Communication interface:	RS485
Power supply:	90 bis 260 V _{ac} 50/ 60 Hz
Power consumption:	< 30 W
Operating condition:	0 to 40 °C
Relative humidity:	< 80%
Dimensions (L x W x H in mm):	232 x 142 x 149
Drive weight (without Pump Head):	2.3 kg
IP code:	IP 31

3

6.287 160

Type	Description	Flow rate ml/min.	Rollers	PK	Cat. No.
PLP 38_103	Laboratory peristaltic pump with pump head, 1 channel	0,07 - 380	3	1	6.287 159 2
PLP 38_5061	Laboratory peristaltic pump with pump head, 1 channel	0,00025 - 41	6	1	6.287 160 3

4

4 Compact peristaltic pumps MS-CA

Flow rate 0.021 to 26ml/min. Simple Click'n'go mini tubing assembly cartridges.

Cole-Parmer GmbH

- 3-stop colour-coded tubing
- fixed-speed motor
- Dimensions MS-CA2 (W x D x H): 88 x 135 x 125mm
- Dimensions MS-CA4 (W x D x H): 88 x 135 x 145mm

Type	Rotation speed rpm	Flow rate ml/min.	Channels	Rollers	PK	Cat. No.
MS-CA 2/620	20	0.028 - 8.5	2	6	1	9.828 142
MS-CA 2/660	60	0.083 - 26.0	2	6	1	9.828 146
MS-CA 2/640	40	0.055 - 17.0	2	6	1	9.828 144
MS-CA 2/840	40	0.043 - 14	2	8	1	9.828 154
MS-CA 2/820	20	0.021 - 7.1	2	8	1	9.828 152
MS-CA 2/860	60	0.064 - 21.0	2	8	1	9.828 156

1 Peristaltic pumps, Reglo ICC

Independent 4-Channel Control Pump

Cole-Parmer GmbH

- Increased efficiency
- Control of complex pump applications with only one pump
- Controlled by computer or directly through the control panel on the pump
- Continuous pumping and precise dosing
- Flexible bi-directional flow direction in each channel
- Self-priming
- Especially for viscous or foaming liquids, also when containing particles or live cells
- Contamination-free pumping even under sterile conditions

Flow rate: 0.0001 to 43 ml/min
 Differential Pressure: Max. 1.0 bar (14.5 psi)
 Tubes: 3 stoppers 0.13 to 3.17 mm ID



Type	Channels	Rollers	Flow rate ml / min.	PK	Cat. No.
Reglo-ICC	2	6	0.0002 - 43	1	6.287 569
Reglo-ICC	3	6	0.0002 - 43	1	6.287 570
Reglo-ICC	4	6	0.0002 - 43	1	6.287 571
Reglo-ICC	2	8	0.0002 - 35	1	6.264 156
Reglo-ICC	3	8	0.0002 - 35	1	9.828 487
Reglo-ICC	4	8	0.0002 - 35	1	4.012 977
Reglo-ICC	2	12	0.0001 - 24	1	6.283 719
Reglo-ICC	3	12	0.0001 - 24	1	6.287 572
Reglo-ICC	4	12	0.0001 - 24	1	6.282 379

Pumps, peristaltic, Ecoline

Flow rate 0.003 to 5400 ml/min. Robust and economical tube pump with a large flow rate range. Stainless steel housing. Easy handling. For all applications in laboratory and industry. Microprocessor-controlled drive and 2-digit digipot for precise speed adjustment. Analogue interface for start/stop and direction of rotation (potential-free contact) as well as speed (0 to 5 V, 0 to 10 V or 0 to 20 mA, 4 to 20 mA). Variable speed drive.

Ecoline VC-280:

Economical, basic, single-channel drive model for flow rates up to 5.4 l/min with variable speed.

Ecoline VC-280, Ecoline VC-360 and VC-380:

1-channel tubing pumps, for 1.6 mm wall thickness tube.

Ecoline VC-281 and VC381:

1-channel tubing pumps, for 2.4 mm wall thickness tube.

Ecoline VC-drive without pump heads:

- combinable with Easy-Load®, MS/CA 8-6 and MS/CA 4-12 pumpheads.

Type	To fit tubing mm	Flow rate ml / min.	Channels	Rollers	PK	Cat. No.
VC-280 II	1.6 - 11.1	1.7 - 5400	1	2	1	9.828 513
VC-360 II	0.8 - 6.4	0.25 - 1300	1	3	1	9.828 514
VC-380 II	1.6 - 11.1	1.6 - 5000	1	3	1	9.828 515
ECOLINE VC-drive	-	-	-	-	1	9.828 516
Easy-Load®	0.8 - 8.0	0.23 - 1600	1	3	1	9.828 391
MS/CA 8-6	0.13 - 3.17	0.005 - 150	8	6	1	9.828 376
MS/CA 4-12	0.13 - 3.17	0.003 - 83	4	12	1	9.828 378
VC-281	4.8 - 9.5	13 - 4600	1	2	1	6.287 568
VC-381	4.8 - 9.5	12 - 4200	1	3	1	7.621 423

2

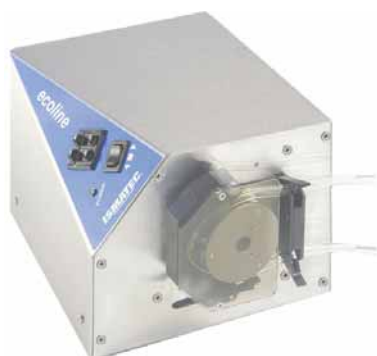

9.828 514

3



9.828 515



4.671 781



4.671 782



4.671 769



4.671 777

Peristaltic pump-Sets rotarus®

NEW

Hirschmann

Sets with peristaltic pump and pump head. The speed and the most important parameters can be programmed directly on the housing front on a TFT touchscreen. Simple and easy loading of the tubing.

Peristaltic pump smart 30 + Single-channel pump head PKF 60-16-3: For endless hoses, for low viscosity media.

Peristaltic pump smart 30 + Multi-channel pump head MKF 60-4-8: For stopper hoses, for low viscosity media. Sturdy hose cassettes with screws for precise adjustment of the delivery rate.

Peristaltic pump smart 40 + Single-channel pump head PKF 60-24-3: For endless hoses. Due to the 2-stage planetary gearbox ideally suited for media with higher viscosity.

Please order tubing separately.

Description	PK	Cat. No.
smart 30 + PKF 60-16-3	1	4.671 781 1
smart 30 + MKF 60-4-8	1	4.671 782 2
smart 40 + PKF 60-24-3	1	4.671 783

Further models can be found in our online shop.

Pump heads rotarus®

Hirschmann

For use with all rotarus® peristaltic pumps.

PK: With double-pivoted rollers made of high-grade, medical stainless steel. With RFID-technology for detection and monitoring of pump head and tubing.

MKF 4/8/12: With components made of anodized aluminum and stainless steel. For tubing cassettes, with lateral set screw for the adjustment of the flow rate. With RFID-technology for detection and monitoring of pump head and tubing.

PKF 60/MKF 60: With components made of durable PPS plastics. Simple and easy loading of the tubing. For attaching the pump heads to the rotarus® drives a PKF/MKF 60 adapter set is required. Please order separately.

Type	Description	Channels	Rollers	PK	Cat. No.
PK 10-16	Single channel pump head for tube with wall thickness 1.6mm	1	3	1	9.880 380
PK 10-16-5	Single channel pump head for tube with wall thickness 1.6mm	1	5	1	4.671 769 3
PK 10-24	Single channel pump head for tube with wall thickness 2.4mm	1	3	1	9.880 381
PKF 60-16-3	Single channel pump head for tube with wall thickness 1.6mm	1	3	1	4.671 770
PKF 60-24-3	Single channel pump head for tube with wall thickness 2.4mm	1	3	1	4.671 771
MKF 4-8	4 Channel pump head for stopper tubes	4	8	1	9.880 382
MKF 8-4	8 Channel pump head for stopper tubes	8	4	1	9.880 383
MKF 12-8	12 Channel pump head for stopper tubes	12	8	1	9.880 384
MKF 60-2-8	2 Channel pump head for stopper tubes	2	8	1	4.671 772
MKF 60-4-8	4 Channel pump head for stopper tubes	4	8	1	4.671 773
MKF 60-8-8	8 Channel pump head for stopper tubes	8	8	1	4.671 774
MKF 60-16-2-4	2 Channel pump head for stopper tubes	2	4	1	4.671 775
MKF 60-16-4-4	4 Channel pump head for stopper tubes	4	4	1	4.671 776

Accessories for Pump heads rotarus®

NEW

Hirschmann

Description	For	PK	Cat. No.
Adapter set PKF 60 for feeding pumps, without RFID	PKF 60-16-3 / PKF 60-24-3	1	4.671 777 4
Adapter set PKF 60 for dispensing pumps, with RFID	PKF 60-16-3 / PKF 60-24-3	1	4.671 778
Adapter set MKF 60 for feeding pumps, without RFID	MKF 60-2-8 / MKF 60-4-8 / MKF 60-8-8 / MKF 60-16-2-4 / MKF 60-16-4-4	1	4.671 779
Adapter set MKF 60 for dispensing pumps, with RFID	MKF 60-2-8 / MKF 60-4-8 / MKF 60-8-8 / MKF 60-16-2-4 / MKF 60-16-4-4	1	4.671 780

Further accessories can be found in our online shop.

1 Peristaltic pump tubing, Tygon® LMT-55 with 2 colour-coded bridges

With 2 colour-coded bridges (international standards). Shore: 55. Fits most common peristaltic pump models, e.g. Verder, Ismatec, Watson-Marlow, IKA and Heidolph. *Saint Gobain*

Standard tubing, transparent. Length 380mm. Long working lifespan. Good resistance to acids and alkalis. Food-safe.

1



Colour	Int. diam. mm	Wall thickness mm	PK	Cat. No.
orange-black	0.13	0.90	12	9.208 201
orange-red	0.19	0.90	12	9.208 202
orange-blue	0.25	0.90	12	9.208 203
orange-green	0.38	0.90	12	9.208 204
green-yellow	0.44	0.90	12	9.208 221
orange-yellow	0.51	0.90	12	9.208 205
white-yellow	0.57	0.90	12	6.251 393
orange-white	0.64	0.90	12	9.208 206
black-black	0.76	0.85	12	9.208 207
orange-orange	0.89	0.85	12	9.208 208
white-black	0.95	0.85	12	6.240 570
white-white	1.02	0.85	12	9.208 209
white-red	1.09	0.85	12	6.901 236
red-red	1.14	0.85	12	9.208 210
red-grey	1.22	0.85	12	6.233 930
grey-grey	1.30	0.85	12	9.208 211
yellow-yellow	1.42	0.85	12	9.208 212
yellow-blue	1.52	0.85	12	9.208 219
blue-blue	1.65	0.85	12	9.208 213
blue-green	1.75	0.85	12	6.227 063
green-green	1.85	0.85	12	9.208 214
purple-purple	2.06	0.85	12	9.208 215
purple-black	2.29	0.85	12	9.208 216
purple-orange	2.54	0.85	12	9.208 217
purple-white	2.79	0.85	12	9.208 218
black-white	3.18	0.85	12	9.208 222

Peristaltic pump tubing, Tygon® LMT-55 with 3 colour-coded bridges

With 3 colour-coded bridges (international standards). Shore: 55. Fits most common peristaltic pump models, e.g. Verder, Ismatec, Watson-Marlow, IKA and Heidolph. *Saint Gobain*

Standard tubing, transparent. Length 380mm. Long working lifespan. Good resistance to acids and alkalis. Food-safe.

Colour	Int. diam. mm	Wall thickness mm	PK	Cat. No.
orange-black	0.13	0.90	12	6.056 875
orange-red	0.19	0.90	12	6.800 824
orange-blue	0.25	0.90	12	6.081 419
orange-green	0.38	0.90	12	6.081 420
green-yellow	0.44	0.90	12	7.510 401
orange-yellow	0.51	0.90	12	6.052 441
white-yellow	0.57	0.90	12	6.241 505
orange-white	0.64	0.90	12	6.052 442
black-black	0.76	0.85	12	6.052 443
orange-orange	0.89	0.85	12	6.051 516
white-black	0.95	0.85	12	6.268 656
white-white	1.02	0.85	12	6.078 175
white-red	1.09	0.85	12	6.077 201
red-red	1.14	0.85	12	6.081 424
red-grey	1.55	0.85	12	6.303 689
grey-grey	1.30	0.85	12	9.208 611
yellow-yellow	1.42	0.85	12	6.052 445
yellow-blue	1.52	0.85	12	4.657 440
blue-blue	1.65	0.85	12	7.079 547
blue-green	1.75	0.85	12	6.052 446
green-green	1.85	0.85	12	6.052 447
purple-purple	2.06	0.85	12	6.056 436
purple-black	2.29	0.85	12	7.616 226
purple-orange	2.54	0.85	12	6.052 449
purple-white	2.79	0.85	12	6.081 520
black-white	3.17	0.85	12	6.056 876

1 Pumps, peristaltic, multichannel, precision, IPC, IPC-N-IP and IP-N

Cole-Parmer GmbH

IP and IP-N series, without dispensing features

- Microprocessor controlled
- very precise pumping

IPC and IPC-N series, with dispensing features

- Microprocessor controlled
- very precise pumping
- with "standby-mode" (prevents draining the tubing line e.g. overnight)
- with dispensing and calibration functions

IPC-N and IP-N series

- 4, 8, 12, 16 or 24 channels
- 8 actively driven stainless steel rollers
- Transparent keyboard and LED-display
- Clickánágo cassettes providing defined and repeatable occlusion conditions.
- different tube sizes can be inserted in each channel.
- 2 Stopper tubes
- Differential pressure: 1.0 bar

Specifications IPC and IPC-N:

Motor type:	d.c. motor
Speed:	IPC: 0.4 up to 44 rpm IPC-N: 0.11 up to 11.25 rpm
Speed setting:	1 to 100 %, resolution 0.1 %
Flow rate setting:	in µl/min to ml/min
Input:	30W
Supply requirements:	230V 50Hz, 115V 60Hz (selectable)
Protection class:	IP 30

Specifications IP and IP-N:

Motor type:	d.c. motor
Speed:	IP: 0.4 up to 44 l/min IP-N: 0.11 up to 11.25 l/min
Speed setting:	1 to 100 %, resolution 0.1 % IP; rpm, resolution 0.1rpm IP-N: rpm, resolution 0.03 rpm
Input:	30W
Supply requirements:	230V 50Hz, 115V 60Hz a.c. (selectable)
Protection class:	IP 30

Type	Dimensions (W x D x H) mm	Flow rate ml/min.	Inputs	PK	Cat. No.
IP-4	175 x 180 x 130	0,002 - 44	4	1	9.828 346
IP-8	175 x 220 x 130	0,002 - 44	8	1	9.828 347
IP-12	175 x 260 x 130	0,002 - 44	12	1	9.828 348
IP-16	175 x 300 x 130	0,002 - 44	16	1	9.828 349
IP-24	175 x 380 x 130	0,002 - 44	24	1	9.828 350
IP-N-4	175 x 180 x 130	0,0004 - 11	4	1	9.828 356
IP-N-8	175 x 220 x 130	0,0004 - 11	8	1	9.828 357
IP-N-12	175 x 260 x 130	0,0004 - 11	12	1	9.828 358
IP-N-16	175 x 300 x 130	0,0004 - 11	16	1	9.828 360
IP-N-24	175 x 380 x 130	0,0004 - 11	24	1	9.828 370
Foot switch	-	-	-	1	9.828 476
IPC-4	175 x 180 x 130	0,002 - 44	4	1	9.828 351
IPC-8	175 x 220 x 130	0,002 - 44	8	1	9.828 352
IPC-12	175 x 260 x 130	0,002 - 44	12	1	9.828 353
IPC-16	175 x 300 x 130	0,002 - 44	16	1	9.828 354
IPC-24	175 x 380 x 130	0,002 - 44	24	1	9.828 355
IPC-N-4	175 x 180 x 130	0,0004 - 11	4	1	9.828 361
IPC-N-8	175 x 220 x 130	0,0004 - 11	8	1	9.828 362
IPC-N-12	175 x 260 x 130	0,0004 - 11	12	1	9.828 363
IPC-N-16	175 x 300 x 130	0,0004 - 11	16	1	9.828 364
IPC-N-24	175 x 380 x 130	0,0004 - 11	24	1	9.828 365

1



1 Peristaltic pump drives, BVP-Standard/BVP-Process

Can be combined with over 20 pump-heads for **flow rates of 0.001 to 3700 ml/min (depending on pump-head).**

Cole-Parmer GmbH

For the continuous pumping of liquids and suspensions with up to 60 % solids content according to capacity or time. Analogue interface for Start/Stop, rotation direction, autostart. LED display on BVP Process. Stainless steel housing, dust-tight and water-proof. Dimensions (W X D x H): 155 x 220 x 260mm (without pump-head).

Specifications: BVP Standard

- speed 3.8 to 240 rpm
- speed setting: 1-99.9 %, resolution 0.1%
- protection rating: IP30
- power supply: 230 V/ 50 Hz - 115 V/60Hz
- weight: 5.7kg (without pump head)

Specifications: BVP Process

- speed 1 to 240 rpm
- speed setting: rpm, resolution: 0.1 rpm
- LED display
- protection rating: IP65
- power supply: 100 - 230 VAC/50 - 60 Hz (autom. switching)
- weight: 6.9 kg (without pump head)

1



Type	Flow rate	PK	Cat. No.
	ml / min.		
BVP-Standard	0.003 - 3700	1	9.828 366
BVP-Process	0.001 - 3700	1	9.828 512

2 Single-channel pumpheads for BVP-Standard (-Process) and MCP-Standard (-Process) peristaltic pump drive units

For tubing with max. wall thickness: 1.6mm

Cole-Parmer GmbH

Pumphead type	Flow rate	Inputs	Rollers	PK	Cat. No.
	ml / min.				
360	0.072 - 530	1	3	1	9.828 371
380	0.44 - 2800	1	3	1	9.828 372
380 AD**	0.41 - 3600	1	3	1	9.828 373
Pro 280	0.49 - 3700	1	2	1	9.828 520
Pro 380	0.45 - 3400	1	3	1	9.828 521
Pro 281*	3.6 - 3100	1	2	1	9.828 394
Pro 381*	3.3 - 2900	1	3	1	9.828 396

* Tubing wall thickness 2.4 mm

**Pump head for tubing wall thickness of 1.6 to 2.4 mm

2



3 Multichannel pumpheads for BVP-Standard/Process and MCP-Standard/Process drive units

Cole-Parmer GmbH

Pumphead type	Flow rate	Inputs	Rollers	PK	Cat. No.
	ml / min.				
SB removable plate	-	-	6	1	9.828 533
SB-3V*	0.09 - 530	3	6	1	9.828 216
SB-2V*	1.1 - 1100	2	6	1	9.828 215

* Removable plate 9.828 533 is required for operation.

3



4 Multichannel pumpheads for BVP-Standard/Process and MCP-Standard/Process drive units

Cole-Parmer GmbH

Pumphead type	Flow rate	Inputs	Rollers	PK	Cat. No.
	ml / min.				
CA4	0,002 - 230	4	8	1	9.828 379
CA12	0,002 - 230	12	8	1	9.828 381
MS/CA8-6*	0,002 - 100	8	6	1	9.828 375
MS/CA4-12**	0,001 - 57	4	12	1	9.828 377
MS/CA8 cartridge block	0,002 - 100	8	6	1	9.828 376
MS/CA4-12 cartridge block	0,001 - 57	4	12	1	9.828 378

*extendible to 24 channels

**extendible to 16 channels

4



1 Peristaltic pump drives, MCP standard/MCP process

Can be combined with over 20 pumpheads for **flow rates of 0.001 to 3700 ml/min (depending on pump-head).**

Cole-Parmer GmbH

Combined peristaltic pump and precise dispenser. Microprocessor controlled, with precise controlled rotation speed and metering unit for 1 to 24 pump channels. The speed (1rpm to 240rpm) is adjustable to 0.1rpm, key-pad with LED-display, programmable. Different dosing modes supply very exact and reproducible results. With RS232 interface, tubing valve operation, dosing handle and foot switch. Can be used for sterile dosing up to 135°C (with adequate tubing). Dimensions (W x D x H): 155mm x 220mm x 260 mm (without pumphead).

Programmable functions:

- ml/min
- drive speed
- drop-free (roller reverse step)
- calibration ml/min (flow rate); ml (volume)
- drive unit on/off

Dosing:

- volume ml
- volume/time unit
- dosing time (0.1s to 999 h)
- intermittent dosing with pre-set pause time; number of dosing cycles selectable

Additional functions MCP process:

- programmable sequences
- dust-tight and water-proof

Specifications

Motor type:	d.c. motor
Speed:	1 to 240rpm
Speed setting:	rpm, resolution 0.1rpm
Flow rate setting:	µl/min, ml/min, l/min
Power consumption:	100W
Power supply:	100 to 230V, 50 to 60Hz a.c.
Protection rating:	IP65
Weight:	6.9kg (without pumphead)
MCP-Standard	
Motor type:	d.c. motor
Speed:	1 to 240rpm
Speed setting:	rpm, resolution 0.1rpm
Flow rate setting:	µl/min, ml/min, l/min
Power consumption:	100W
Power supply:	230V 50Hz; 115V, 60Hz a.c. selectable
Protection rating:	IP30
Weight:	6.4kg (without pumphead)

Type	PK	Cat. No.
MCP-Process	1	9.828 510
MCP-Standard	1	9.828 367

1



➔ Suitable pump heads please see page 1049

Analog Pump Drive Hei-FLOW Value

Feed pump for standard applications. The speed is adjustable with the analog control knob and stays constant even under changing loads.

Heidolph

- Smooth start operation prevents from spills and splashing media
- Feed direction reversible
- For safety in unattended continuous operation, the motor will be switched off in case of an overload situation to prevent overheating
- Optional footswitch to operate pump drive in closed fume hoods and to facilitate filling operations
- Pump heads with convex rollers for cell protection are available for use in cell biology

The pump head is not included. Please order separately.

Specifications

Control accuracy motor:	±2 %
Flow rate accuracy (water without counter pressure):	±5 %
Motor power:	100 W
Permissible ambient conditions:	5 ... 31 °C
Permissible rel. humidity:	80 %
Dimensions (W x D x H):	166 x 256 x 225 mm
Weight:	7.6 kg
Protection class DIN EN 60529:	IP 55

1 Analog Pump drive Hei-FLOW Value 06

This pump drive is only suitable for use with single-channel pump heads.

Heidolph

Specifications

Speed range:	50 ... 600 rpm
Flow rates single-channel pumps:	4.0 ... 4151 ml/min

Type	PK	Cat. No.
Hei-FLOW Value 06	1	9.829 241

Further models can be found in our online shop.



Single-channel Pump Heads SP standard and SP vario for Pump drives Hei-FLOW

SP standard

Heidolph

- Recommended for standard applications
- Convex rollers do not squeeze or crush organic cell cultures
- Pump head features ball bearings
- Rollers made of stainless steel and polyamide
- For tubes with a 1.6mm or 2.5mm wall thickness (wt)
- Depending on drive and tubing, the flow rate ranges from 2.0 to 4151 ml per minute

SP vario

- Suitable for most Heidolph tubing due to adjustable roller spacing
- Convex rollers do not squeeze or crush organic cell cultures
- Pump head features ball bearings
- Rollers made of stainless steel and aluminum
- Depending on drive and tubing, the flow rate ranges from 2.0 to 4151 ml per minute



9.829 254



9.829 256

Type	Tubing wall thickness	Flow rate ml/min.	PK	Cat. No.
SP standard 1.6*	1.6	0.5 to 3644	1	9.829 254 2
SP standard 2.5*	2.5	0.5 to 3644	1	9.829 255
SP vario**	var.	0.5 to 3644	1	9.829 256 3

* for simple flow requirements.

** rotor with adjustable roller distance.

1 Single-channel Pump Heads SP quick for Pump drives Hei-FLOW

- Fast and convenient tube changes
- Low pulsation due to 5 roller system
- Pump head features ball bearings
- Rollers made of stainless steel
- For tubes with a 1.6mm or 2.5mm wall thickness (wt)
- Depending on drive and tubing, the flow rate ranges from 0.38 to 3436 ml per minute

Heidolph

Type	Tubing wall thickness	Flow rate ml/min.	PK	Cat. No.
SP quick	1.6	0.38 ... 3436	1	9.829 250
SP quick	2.5	0.38 ... 3436	1	9.829 251

1



Multi-channel Pumps for Pump drives Hei-FLOW

- These pump drives are able to be configured for multi-channel use: Value 01, Advantage 01, Precision 01
- Increased output by running up to 12 individual cassettes on one single pump drive and pump head system
- Separate metering into multiple vessels with different feed rates at the same time by using different tubing dimensions to adjust flow rates
- Easy and quick tubing change
- In addition to standard pump heads which feature a 4 roller system, 8 roller pump heads are available for low pulsation
- Easy change of cassettes, even during operation
- Cassettes adjustments and changes are simple due to click system
- With possibility to upgrade the pump drive with an adapter for multi-channel operation

Heidolph

Type	Description	PK	Cat. No.
C4	for max. 4 x small cassettes	1	9.829 285 2
C8	for max. 8 x medium or 4 x large cassettes	1	9.829 286 3
C12	for max. 12 x small cassettes	1	9.829 287 4
Cassette, small	Flowrate: 0.005 to 40.8 ml/min	1	9.829 288
Cassette, medium	Flowrate: 0.29 to 25.2 ml/min	1	9.829 289
Cassette, large	Flowrate: 1.0 to 336 ml/min	1	9.829 290

2



9.829 285

3



9.829 286

4



9.829 287

1 Chemically-resistant Liquid Pumps LIQUIPORT®

- Application: Transferring liquids
- Flow rate from 0.2 up to 3 l/min
- Pressure head 10 mWg, suction head 3 mWg
- Self priming, dry running
- Tubing connection for tubing with ID 8 mm for NF 100 and ID 12 mm for NF 300
- Pump heads available in your choice of PP (Typ KT), PVDF (Typ TT) or PTFE (Typ FT), diaphragms available in PTFE, valves in FFKM
- Flow rate can either be set manually (Version S) or both manually and via an external control device (Version RC)

Specifications

Suction head:	3 mWg
Pressure head:	10 mWg
Ambient temp.:	5 ... 40 °C
Liquid temp.:	5 ... 80 °C
Pump head:	optional PP, PVDF or PTFE
Diaphragm:	PTFE-coated
Valves:	FFKM
Supply requirements:	100 ... 230 V, 50/60 Hz

Type	Int. diam. mm	Width mm	Height mm	Depth mm	Flow rate l / min.	Rating W	Weight kg	PK	Cat. No.
NF 100 KT.18 S	8	99	177	130	0.2 ... 1.3	12	1.0	1	9.880 597
NF 100 KT.18 RC	8	99	177	130	0.2 ... 1.3	12	1.0	1	7.627 990
NF 100 TT.18 S	8	99	177	130	0.2 ... 1.3	12	1.0	1	9.880 598
NF 100 FT.18 S	8	99	177	130	0.2 ... 1.3	12	1.0	1	4.664 493
NF 300 KT.18 S	12	104	188	160	0.5 ... 3.0	29	1.5	1	9.880 599
NF 300 TT.18 S	12	104	188	160	0.5 ... 3.0	29	1.5	1	9.880 600
NF 300 FT.18 S	12	104	188	160	0.5 ... 3.0	29	1.5	1	7.634 612

KNF



2 3 Chemically-resistant Diaphragm Dosing Pumps SIMDOS® 02/10

- Application: Metering liquids
- Flow rate from 0.03 up to 100 ml/min/Pressure head 60 mWg, suction head 2 mWg and 3 mWg respectively
- Pump heads available in your choice of PP, PVDF or PTFE-diaphragms available in PTFE, valves in FFKM
- Flow rate can either be set manually (Version S) or both manually and via an external control device as well as with interface RC 232 (Version RCP)
- Additional safety diaphragm for maximum security
- Easy exchange of the transfer diaphragm by activating the maintenance command in the operating program

Advantages:

- Intuitive operation, easy calibration
- Adjustable to liquid characteristics
- Self-priming and dry-running
- Spray water protected IP 65
- Small size

Specifications

Pressure:	6 bar
Allowed ambient temperature:	+5 ... +40 °C
Allowed liquid temperature:	+5 ... +80 °C
Dimensions (WxDxH):	93 x 150 x 144 mm
Pump head:	optional PP, PVDF or PTFE
Diaphragm:	PTFE
Valves:	FFKM
Power supply:	100-240 V, 50-60 Hz
Weight:	0.9 kg

Type	Head	Control	Flow rate	Dosing volume	Max. suction height	PK	Cat. No.
SIMDOS® 02 FEM 1.02KT.18S	PP	S	30 µl/min - 20 ml/min	30 µl - 999 ml	2 m	1	9.880 565
SIMDOS® 02 FEM 1.02KT.18RCP	PP	RC plus	30 µl/min - 20 ml/min	30 µl - 999 ml	2 m	1	7.940 190
SIMDOS® 02 FEM 1.02TT.18S	PVDF	S	30 µl/min - 20 ml/min	30 µl - 999 ml	2 m	1	9.880 567
SIMDOS® 02 FEM 1.02TT.18RCP	PVDF	RC plus	30 µl/min - 20 ml/min	30 µl - 999 ml	2 m	1	6.280 030
SIMDOS® 02 FEM 1.02FT.18S	PTFE	S	30 µl/min - 20 ml/min	30 µl - 999 ml	2 m	1	9.880 569
SIMDOS® 02 FEM 1.02FT.18RCP	PTFE	RC plus	30 µl/min - 20 ml/min	30 µl - 999 ml	2 m	1	6.288 412
SIMDOS® 02 FEM 1.02ST.18S	stainless steel	S	30 µl/min - 20 ml/min	30 µl - 999 ml	2 m	1	7.643 148
SIMDOS® 02 FEM 1.02ST.18RCP	stainless steel	RC plus	30 µl/min - 20 ml/min	30 µl - 999 ml	2 m	1	6.280 334
SIMDOS® 10 FEM 1.10KT.18S2	PP	S	1 - 100 ml/min	1 - 999 ml	3 m	1	6.268 391
SIMDOS® 10 FEM 1.10KT.18RCP2	PP	RC plus	1 - 100 ml/min	1 - 999 ml	3 m	1	6.310 685
SIMDOS® 10 FEM 1.10FT.18RCP2	PTFE	RC plus	1 - 100 ml/min	1 - 999 ml	3 m	1	6.274 454
SIMDOS® 10 FEM 1.10FT.18S2	PTFE	S	1 - 100 ml/min	1 - 999 ml	3 m	1	6.268 389
SIMDOS® 10 FEM 1.10ST.18RCP2	stainless steel	RC plus	1 - 100 ml/min	1 - 999 ml	3 m	1	6.313 297
SIMDOS® 10 FEM 1.10TT.18S2	PVDF	S	1 - 100 ml/min	1 - 999 ml	3 m	1	6.268 393
SIMDOS® 10 FEM 1.10TT.18RCP2	PVDF	RC plus	1 - 100 ml/min	1 - 999 ml	3 m	1	6.285 974

KNF



3



1 Pumps, liquid, ceramic piston, MCP-CPF Process and Reglo-CPF Digital

Flow-rate from 0.025 to 2300 ml/min (depending of the pump head). Operate on a valveless rotating piston principle with liquid pathway materials made of sapphire-hard, chemically inert ceramic (99.7 % Al₂O₃). Ideal for chemically aggressive and viscous or crystallizing materials. Differential pressure up to 6.9 bar. Industrial process-adapted drive, dust- and water-tight, with washdown (IP 65) capability due to completely sealed stainless steel housing. PC-programmed routines can be stored in the pump memory and run without needing a PC.

Cole-Parmer GmbH

Specifications

Motor:	MCP-CPF Process // Reglo-CPF Digital
Rotation speed:	d.c. motor
Speed resolution:	10 to 1800 rpm. // 40 to 1800 rpm
Flowrate setting:	1rpm, 0.1 rpm selectable.
Power rating:	µl/min, ml/min, l/min // µl/min, ml/min
Overall (W x D x H):	100 W // 50 W
Safety protection:	155 x 220 x 260 mm* // 100 x 175 x 135 mm*
Weight:	IP 65 // IP 30
Supply requirements:	6.9 kg* // 2.5 kg
* without pumphead	100 to 230V a.c. 50/ 60 Hz

Type	Width mm	Depth mm	Height mm	Flow rate ml / min.	PK	Cat. No.
MCP-CPF-Process	155	220	260	0.025 - 2300	1	9.828 511
Reglo-CPF Digital	100	175	135	0.08 - 180	1	9.828 368

2 Gyro flask pumpheads for MCP-CPF-Process and Reglo-CPF Digital

Cole-Parmer GmbH

Gyro flask pumpheads for the RH series:

Housing:	Kynar (on request also Tefzel possible)
Connection:	union nut for 6 - 6.4 mm AD tube/LF = UNF 1/4 "-28
Max. Temperature:	100 °C
Bushing and piston:	Ceramic

Type	To fit tubing mm	Flow rate ml / min.	Working vol. µl	Pump head	PK	Cat. No.
RH00SKY-LF	i.d. 1.5	0.025 - 45	2.5 - 25	steel SS316	1	9.828 423
RH00KC	o.d. 6.4	0.050 - 90	5 - 50	ceramic	1	9.828 420
RH10KC	o.d. 6.4	0.10 - 180	10 - 100	ceramic	1	9.828 421

Alternative Gyro flask pumpheads RH... and QP... available on request !

1



2



Syringe Pumps Legato®

The Legato® series syringe pumps provide the smoothest most accurate flow available. The intuitive, chemically resistant touch screen enables the user to quickly create configurations and recall them for ease of use. Single syringe, single remote syringe, dual syringe and multirack configurations are available along with the infuse only or infuse/withdraw/continuous operation (model dependent).

KD Scientific

- Single and dual syringe infuse, infuse withdraw & continuous models
- Holds syringe sizes from 0.5ul to 140 ml (Model dependent)
- Flow rates down to the picoliter/min (Model dependent)
- Programmable interface without the need for a PC (Model dependent)
- USB/RS-232/TTL Interfaces for external control (RS232 available on Legato® 200 Series Only)
- Rugged construction with cold rolled steel chassis

Applications: Electrospinning, Flow Cytometry, Microfluidics, Mass Spec, Drug Discovery, Organic Synthesis, Nanofluidics, Stereotaxic Injections

Legato® 100 Single Syringe Infusion Pump: This pump is ideal for applications where a single syringe is used.

Legato® 101 Dual Syringe Nanoliter Pump: This infusion only pump is ideal for applications where dual syringes are required with small volumes under 10ml.

Legato® 110 Single Syringe Infusion/Withdraw Pump: The Legato® 110 is based on the Legato® 100. It offers infuse/withdraw flow control and programmability for up to two multi-step programs of 50 steps each. This pump is ideal for more complex multi-step dosing and has multi-mode operation.

Legato® 110 DRS Dual syringe pump combination: Two Legato® 110 pumps connected by an input/output cable. Both pumps can be started synchronously and operated at different flow rates.

Legato® 180 Dual Syringe Picoliter Infusion/Withdraw Pump: For low flow with program options for 2 programs. 50 steps each. User definable flow rates with selectable target volume or time values to control the total infusion volume.

Legato® 185 Single Syringe Infusion/Withdraw Pump: It offers infuse/withdraw flow control and programmability for up to two multi-step programs of 50 steps each. This pump is ideal for more complex multi-step dosing and has multi-mode operation. Minimum flow rate only 0.54 pl/min.

Legato® 200 Dual Syringe Infusion Pump: This unit supports infuse only. User definable flow rates with selectable target volumes or time values to control the total infusion volume.

Legato® 210 Dual Syringe Infusion/Withdraw Pump: This unit supports infuse only, withdraw only, infuse/withdraw, withdraw/infuse and continuous mode. User defined flow rates with selectable target volumes.

Legato® 210P Dual Syringe Infusion/Withdraw Pump: as Legato® 210, features additional multi-step programming with user defined configurations/programs of up to 1000 steps. Up to 40 programs of 25 steps each can be stored in memory.

Legato® 270P Dual Push/Pull Syringe Pump: as Legato® 210, features additional user defined configurations/programs of up to 800 steps. Up to 40 programs of 20 steps each step can be stored in memory.

Type	For syringes	Flow rate	Dimensions (W x D x H) mm	Weight kg	PK Cat. No.
Legato® 100	1 (0.5 µl ... 60 ml)	1.26 pl/min* ... 88,28 ml/min	226 x 191 x 150	2.7	1 6.267 706
Legato® 101	2 (0.5 µl ... 10 ml)	1.28 pl/min* ... 25,99 ml/min	226 x 191 x 150	2.7	1 6.267 707 ¹
Legato® 110	1 (0.5 µl ... 60 ml)	1.28 pl/min* ... 88,28 ml/min	226 x 191 x 150	2.7	1 6.267 708 ²
Legato® 180	2 (0.5 µl ... 10 ml)	0.58 pl/min* ... 11,70 ml/min	226 x 191 x 150	2.7	1 6.275 380
Legato® 185	1 (0.5 µl ... 10 ml)	0.54 pl/min* ... 11,70 ml/min	226 x 191 x 150	2.7	1 6.270 180
Legato® 200	2 (0.5 µl ... 140 ml)	3.06 pl/min* ... 215,80 ml/min	279 x 254 x 165	5.0	1 6.267 701
Legato® 210	2 (0.5 µl ... 140 ml)	3.06 pl/min* ... 215,80 ml/min	279 x 254 x 165	5.0	1 6.267 702
Legato® 210P	2 (0.5 µl ... 140 ml)	3.06 pl/min* ... 215,80 ml/min	279 x 254 x 165	5.0	1 6.264 000
Legato® 270P	2 (0.5 µl ... 140 ml)	3.06 pl/min* ... 215,80 ml/min	279 x 254 x 165	5.0	1 4.661 188

*using a 0.5 µl syringe

1

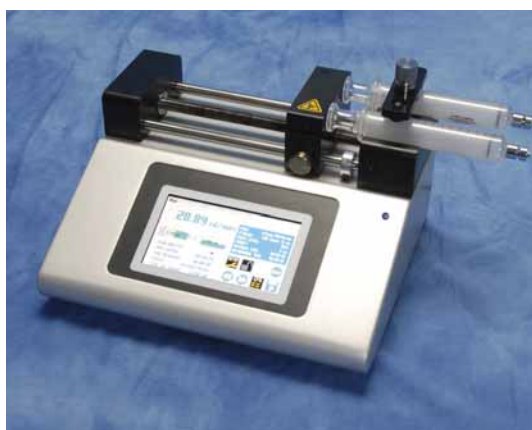

6.267 707

2



6.267 708

Syringe Pumps Legacy®

NEW

KD Scientific

The simple and easy to use Legacy® pumps are a high value solution for delivering precise and smooth flow in research and production applications. The KDS 100 pump gives customers the most cost effective solution for infusing fluids. Alternatively, the KDS 200 gives advanced features with RS232 and TTL interfaces and can be daisy chained together to create a pumping network. KDS 220 holds up to 10 syringes.

- Vibration Elimination System
- Flow Direction Indicator
- Fast Forward/Reverse
- Power Recovery Diagnostics
- Syringe Library
- Flow Rate Selection
- Volume Dispense Mode
- Direct Entry Syringe Diameter
- Optional: Foot Pedal Interface, NIST Certificate, Alarm

KDS 100 Single-Syringe Infusion Pump: Economical pump combining precision flow with outstanding ease-of-use and exceptional durability.

KDS 101 Two-Syringe Nanoliter Pump: For microdialysis and similar applications which require virtually pulseless flow at very low flow rates.

KDS 200 Two-Syringe Infusion Pump: Programmable pump for daisy chain connection. Feature-laden and with a broad speed range and a wide range of syringe sizes it meets the requirements of most laboratory applications.

KDS 220 Multi-Syringe Infusion Pump: For applications requiring multiple syringes. This pump has been modified to hold up to 10 syringes.

Type	For syringes	Flow rate	Dimensions (W x D x H) mm	Weight kg	PK	Cat. No.
KDS 100	1 (10 µl ... 60 ml)	0.1 µl/h ... 423 ml/h	230 x 153 x 130	2	1	6.290 324 1
KDS 101	2 (10 µl ... 10 ml)	0.001 µl/min ... 0.351 ml/min	230 x 153 x 130	2	1	6.291 640
KDS 200	2 (10 µl ... 140 ml)	0.001 µl/h ... 8824 ml/h	280 x 235 x 140	4	1	6.237 902
KDS 200*	2 (10 µl ... 140 ml)	0.001 µl/h ... 8824 ml/h	280 x 235 x 140	4	1	6.311 356
KDS 220	≤10 (10 µl ...10 ml)	0.001 µl/h ... 8824 ml/h	280 x 235 x 140	4	1	4.672 169 2
	≤6 (40 ml ...60 ml)					
	≤4 (100 ml ...140 ml)					

* with CE Mark

1

6.290 324

2

4.672 169

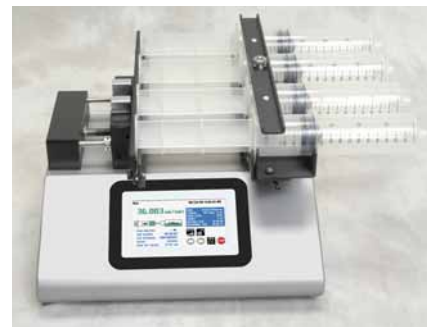
3

6.267 704

Multi-Rack for syringe pumps Legato® 200 and Legato® 210

Modular syringe racks can be purchased to create a multichannel syringe pump. These racks will work with the Legato® 200 or Legato® 210 only. All of them could be for infuse only as well.

KD Scientific

Small Syringe Multi-Rack: The small syringe multi-rack will accommodate up to six 30ml to 60ml syringes or up to ten 0.5µl to 20ml syringes. For Infuse/Withdraw applications.

Large Syringe Multi-Rack: The large syringe multi-rack will accommodate up to four 60ml to 140ml plastic syringes. For Infuse/Withdraw applications.

Microliter Syringe Multi-Rack: The microliter syringe multi-rack will accommodate up to four 0.5µl to 10ml syringes. For Infuse/Withdraw applications.

Description	PK	Cat. No.
Small Syringe Multi-Rack	1	6.267 703
Large Syringe Multi-Rack	1	6.267 704 3
Microliter Syringe Multi-Rack	1	6.267 705

➔ Disposable syringes please see page 1460.

1 Syringe pump Legato® 130

The Legato® 130 Nanoliter pump is ideal for stereotaxic and micro manipulator devices. *KD Scientific*
 The Legato® 130 is an infuse/withdraw single syringe pump. It works with micro syringes from 0.5 to 1000 µl. Any type of syringe can be used including glass and plastic. It has a remote pump head which can be placed close to the experiment to eliminate dead volume with long tubing. The remote pump head is ideal for use with a micromanipulator, stereotaxic and other clamping devices. Syringe size and flow rates are easily displayed as well as the volume delivered and the elapsed time. A wide dynamic flow range from picoliters per minute to milliliters per minute can be programmed into the pump.

- Remote pump head
- Large colour touchscreen display
- 2 programs with 50 steps each
- Icon driven software
- USB, RS-232 and RS485 interface
- Precise and smooth flow

Specifications

Flow rate: 3.66 pl/min to 3.82 ml/min
 (depending on syringe size)
 Accuracy: ±0.5 %
 Syringe size: 0.5 to 1000 µl
 Dimensions: 9 x 19 x 7.6 mm
 Weight: 2 kg
 Power supply: 100-240 VAC, 50/60 Hz

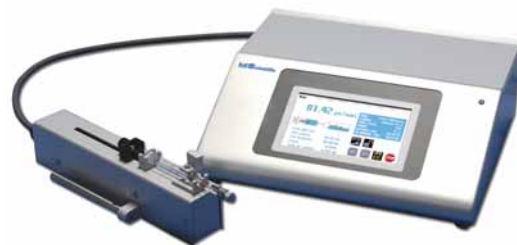

Type	PK	Cat. No.
Legato® 130	1	6.287 229

2 3 LLG-Glass-Syringes, borosilicate glass

With brown graduations. Sterilisable up to 134 °C.

Capacity ml	Material Cone	Nozzle type	PK	Cat. No.
1	Glass	Luer-Slip	1	6.272 088
2	Glass	Luer-Slip	1	6.272 089
5	Glass	Luer-Slip	1	6.272 090
10	Glass	Luer-Slip	1	6.272 091
20	Glass	Luer-Slip	1	6.272 092
50	Glass	Luer-Slip	1	6.272 093
1	Metal	Luer-Lock	1	6.272 094
2	Metal	Luer-Lock	1	6.272 095
5	Metal	Luer-Lock	1	6.272 096
10	Metal	Luer-Lock	1	6.272 097
20	Metal	Luer-Lock	1	6.272 098
50	Metal	Luer-Lock	1	6.272 099



4 Tubing Versilic®, Silicone

Versilic® 60 shore tubing is biologically inert and does not inhibit cell culture. It stays flexible down to -50 °C and maintains its chemical, mechanical and electrical performance up to +200 °C. Versilic® meets the European Pharmacopoeia requirements for silicone elastomer for closures and tubing, USP Class VI biological tests and ISO 10993 biocompatibility (systemic toxicity, irritation, sensitization, cytotoxicity, hemocompatibility and Ames test). *Saint Gobain*



Int. diam. mm	Ext. diam. mm	Wall thickness mm	PK	Cat. No.
0.5	2.5	1.0	1	9.205 300
1.0	3.0	1.0	1	9.205 301
2.0	4.0	1.0	1	9.205 302
3.0	5.0	1.0	1	9.205 303
4.0	6.0	1.0	1	9.205 304
4.0	8.0	2.0	1	9.205 267
5.0	7.0	1.0	1	9.205 305
6.0	9.0	1.5	1	6.236 287
6.0	10.0	2.0	1	9.205 275
7.0	11.0	2.0	1	9.205 306
8.0	11.0	1.5	1	6.235 261
8.0	12.0	2.0	1	9.205 285
9.0	13.0	2.0	1	9.205 307
10.0	14.0	2.0	1	9.205 308
12.0	17.0	2.5	1	9.205 309

1

6.091 193

2

6.800 467

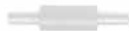
3

6.800 466

4

6.078 174

Adapters for Luer Lock Hub Tubing

Hamilton

Description	PK	Cat. No.
Female Luer/Female Luer	1	6.091 193 1
Female Luer/Male Luer	1	6.800 467 2
Female Luer/Male Luer Lock	1	6.287 085
Female Luer/1/4"-20 UNC	1	6.287 087
Female Luer closure	1	6.800 447
Male Luer/Male Luer	1	6.800 466 3
Male Luer Lock/Male Luer	1	6.241 919
Male Luer Lock/Male Luer Lock	1	6.078 174 4
Male Luer Lock/1/8"-NPT	1	6.287 086
Male Luer Lock/1/4"-28 UNF	1	6.083 814

5

5 Luer Lock Hub Tubing Assemblies, 1 Hub, 300 mm

The tubing is 300 mm in length but can be trimmed shorter to a desired length.

Hamilton

Gauge	Ext. diam. mm	Int. diam. mm	Material	PK	Cat. No.
30	0.75	0.35	PTFE	1	6.071 810
28	0.86	0.40	PTFE	1	6.206 417
24	1.12	0.59	PTFE	1	6.287 133
22	1.23	0.71	PTFE	1	6.071 809
20	1.50	0.91	PTFE	1	6.231 359
19	1.83	1.02	PTFE	1	6.071 808
18	1.68	1.07	PTFE	1	6.300 542
17	1.62	1.02	PTFE	1	6.287 132
16	2.02	1.42	PTFE	1	6.231 356
15	2.17	1.57	PTFE	1	6.287 131
14	2.35	1.75	PTFE	1	7.612 023
13	2.54	1.95	PTFE	1	6.287 130
12	2.77	2.16	PTFE	1	6.287 129
11	3.04	2.44	PTFE	1	6.287 128
10	3.33	2.72	PTFE	1	6.287 127
9	3.76	3.02	PTFE	1	6.287 126
8	4.19	3.43	PTFE	1	6.287 125
7	4.60	3.84	PTFE	1	7.611 570

6

6 Luer Lock Hub Tubing Assemblies, 1 Hub, 500 mm

The tubing is 500 mm in length but can be trimmed shorter to a desired length. Further tubing lengths available on request.

Hamilton

Gauge	Ext. diam. mm	Int. diam. mm	Material	PK	Cat. No.
30	0.75	0.35	PTFE	1	6.250 028
28	0.86	0.40	PTFE	1	6.287 102
26	0.91	0.46	PTFE	1	6.287 101
24	1.12	0.59	PTFE	1	6.287 100
22	1.23	0.71	PTFE	1	6.287 099
20	1.50	0.91	PTFE	1	6.287 098
19	1.83	1.02	PTFE	1	6.287 097
18	1.68	1.07	PTFE	1	6.204 854
17	1.62	1.02	PTFE	1	6.204 855
16	2.02	1.42	PTFE	1	6.204 856
15	2.17	1.57	PTFE	1	6.287 096
14	2.35	1.75	PTFE	1	6.287 095
13	2.54	1.95	PTFE	1	6.287 094
12	2.77	2.16	PTFE	1	6.287 093
11	3.04	2.44	PTFE	1	6.287 092
10	3.33	2.72	PTFE	1	6.287 091
9	3.76	3.02	PTFE	1	6.287 090
8	4.19	3.43	PTFE	1	6.287 089
7	4.60	3.84	PTFE	1	6.287 088

7

6.800 626

Removable Adapters (RN) for Luer Lock Hub Tubing

For 250 µl RN needle syringes and larger. Port diameter 1.5 mm, Inert Gas Sampling Valve 1 mm.

Hamilton

Description	PK	Cat. No.
Male Luer	1	6.079 139
Male Luer Lock	1	6.305 865
Female Luer	1	6.306 806
Inert Gas Sampling Valve	1	6.800 626 7

9. Vacuum technology, Drying, Dry storage Contents

Water jet pumps	1060
Water jet pumps.....	1060
Piston pumps/Compressors	1061
Pumps and compressors.....	1061
Diaphragm pumps	1062
Pumps	1062
Pump units-speed controlled	1069
Pump units-valve controlled	1071
Rotary vane pumps	1074
Pumps	1074
Accessories	1075
for vacuum pumps.....	1075
Cold traps, Woulff bottles.....	1076
Vacuum controller	1078
Sensors and Controllers.....	1078
Desiccators	1081
Desiccators - glass.....	1081
Desiccators - plastic.....	1084
Desiccator cabinets.....	1085
Laboratory Freeze drying	1091
Freeze dryers.....	1091

Water jet pumps/Water jet pumps



1 Water jet pump, PP

This pump will work on pressures up to 10 kg/cm². With built-in, non-return valve to eliminate back flow. Useful for vacuum removal of spilt chemicals, as well as for filter work. Easily dismantled for cleaning.

Kartell

Description	PK	Cat. No.
Water jet vacuum pump	1	9.303 031
Tubing connectors	1	9.303 032



2 Water jet pumps, PP

With constant ultimate vacuum, high suction flow rate and very low water consumption.

BRAND

Can be connected to mains water system in a number of different ways using the adapter supplied and reducing adapters that are available as accessories. For continuous use at temperatures up to 80 °C max. High chemical resistance as the media being pumped only comes into contact with PP, FKM and PTFE. Integral non-return valve increases safety.

Comprises: Water jet pump, including:

Mains water connections: R 3/4" sleeve nut, R 1/2" reducing adapter and flexible tubing connection (nozzle) with external diameter from 10 mm to 12 mm.

Vacuum connection: Detachable nozzle with external diameter from 6mm to 9mm and GL 14 screw cap.

Type	PK	Cat. No.
Reducing adapter R 3/8" for water jet filter pump	1	7.020 037
Reducing adapter M 22x1 for water jet filter pump (thread for screen tap)	1	7.020 038
Water jet pump	1	9.303 125



3 Water jet pump, nickel-plated

Nickel-plated brass, non-return valve, with connection for quick coupling.

Usbeck

Description	Thread	Weight	PK	Cat. No.
		g		
Water jet pump	G 1/2	188	1	9.303 000
Quick coupling for water jet pump			1	9.303 001



4 Water Jet Pump, nickel-plated

Nickel-plated brass, non-return valve, with female connection to water tap.

Usbeck

Thread	Ext. diam.	Weight	PK	Cat. No.
	mm	g		
G 1/2	21.0	245	1	6.070 401
G 3/4	26.5	250	1	6.302 608

1 Piston pump LLG-uniVACUUPUMP 1

1

The **portable** piston pump LLG-uniVACUUPUMP 1 has been developed for **vacuum and pressure applications** in the laboratory, in particular in the field of Life Science. Typical applications for this low-cost vacuum pump are the single funnel filtration of aqueous and buffered solutions, SPE, as well as any applications where no harmful gases are conveyed. The LLG-uniVACUUPUMP 1 operates oil-free and can also be used as a compressor to a pressure up to 3.3 bar. This allows you, for example, pressure filtration, if vacuum filtration is not sufficient. Not recommended for pumping organic, acidic, or basic vapours.

Advantages:

- Dry-running technology for physical applications
- Can be used as a vacuum pump and compressor
- Cost-effective alternative for water pumps
- Sound suppressor for quiet operation
- Compact, light weight and portable
- Oil-free, suitable for continuous operation
- Suction/pressure connection: hose nozzle DN 6 for hose inner diameter 6 mm

Scope of delivery: Pump, incl. 2 hose clamps, EU + UK-plug power cord.

Specifications

Pump speed 50/60 Hz at atmospheric pressure:	9.2/11 l/min
Final pressure:	292 mbar
Max. overpressure:	3.3 bar
Max. operating gas temperature:	60 °C
Permissible ambient temperature:	10 ... 40 °C
Suction/pressure connection:	DN 6
Noise emission:	<45 dB(A)
Motor power:	25 W
Dimensions (W x D x H):	194 x 114 x 191 mm
Weight:	2.0 kg
Power supply:	230 V/50 Hz
IP code:	IP 20
Warranty:	3 years



Type	PK	Cat. No.
LLG-uniVACUUPUMP 1	1	6.263 580

2 Piston pump, complete

2

Piston pumps are a reliable partner for physical applications, notably with aqueous solutions. Being a vacuum pump and compressor, it can be used for a wide variety of applications such as filtration, gas sampling, vacuum drying, desiccation and automation technology. The integrated vacuum and pressure gauges and regulators allow the pressure to be continuously monitored and adjusted. For use with dry or aqueous vapor applications only.

Welch Vacuum

- Oil free
- Easy to clean
- Easy maintenance
- Easy handling and control features
- Robust construction
- Pressure connection with exhaust silencer
- Suction/pressure connection: hose nozzle DN 8 for hose inner diameter 8 mm

Scope of delivery: vacuum pump, vacuum and pressure regulators with gauges, inlet water trap and muffler

Specifications

Suction/pressure connection:	DN 8
Ambient temperature:	10 ... 40 °C
Max. Operating gas temperature:	60 °C
Noise DIN EN ISO 2151:	56 dB (A)
IP code:	IP 20



Ultimate pressure	Flow rate	Max. pressure	Dimensions (W x D x H)	Weight	Rating	PK	Cat. No.
mbar	L / min.	bar	mm	kg	W		
133	18	7.9	206 x 224 x 254	5.3	93	1	6.287 585
93	28	5.8	206 x 224 x 254	5.3	93	1	6.287 586
80	38	5.2	254 x 191 x 77	6.3	190	1	6.287 587

1 Mini Diaphragm Vacuum Pumps LABOPORT®

For Filtration, SPE, Degassing, Fluid aspiration.

KNF

- N 938.50 KT.18 ensures exceptionally fast evacuation by the parallel and in series connection of both pump heads
- N 86 KT.18 has a very small footprint
- PTFE-coated diaphragm is ideal for aggressive/corrosive gases and vapors
- Pump head made from PPS (Polyphenylsulfide), valves made from FFPM (Perfluoro rubber)

Specifications

Operating pressure:	0.5 bar
Connectors for tube	
N 86 KT.18/KN.18:	ID4 mm
N 816.3 KT.18/N 816.1.2 KT.18:	ID6 mm
N 938.50 KT.18:	ID10 mm
Permissible media and ambient temperature:	5 to 40 °C
Flow rate:	Up to 1.8 m³/h
Ultimate vacuum:	Up to 15 mbar abs.
IP code:	IP 20

Type	Flow rate l / min.	Ultimate vacuum mbar (abs).	Max. pressure bar	PK	Cat. No.
N 86 KN.18	6	100	2.4	1	9.880 510
N 86 KT.18	5.5	160	2.5	1	9.880 680
N 816.3 KT.18	16	20	0.5	1	7.620 376
N 816.1.2 KT.18	30	160	0.5	1	6.206 850
N 938.50 KT.18	30	15	0.5	1	7.940 228

2 Mini-Diaphragm vacuum pumps LABOPORT® N96, chemically-resistant

NEW

The Pump combines a high flow rate with a very compact design. Suitable for filtration, SPE, and liquid aspiration using a vacuum. Due to the manual rotational speed control, the pump is quiet, very energy efficient, and can be optimally adjusted in accordance with the application.

KNF

- Easy-to-clean surface
- Very small footprint
- Adjustable in flowrate due to manual rotational speed control
- PTFE-coated diaphragm for use with aggressive/corrosive gases and vapors

Specifications

Ultimate vacuum (abs.):	<130 mbar
Operating pressure:	2.5 bar
Connectors for tube:	ID 6 mm
Permissible ambient temperature:	5 ... 40 °C
Pump head:	PPS
Diaphragm:	PTFE coated
Valves:	FKM

Type	Flow rate L / min.	Ultimate vacuum mbar (abs).	Width mm	Depth mm	Height mm	Weight kg	PK	Cat. No.
N96	7	130	75	156	119	1.3	1	4.672 374



9. Vacuum technology, Drying, Dry storage Diaphragm pumps/Pumps

Diaphragm pumps, Aluminium PTFE design, ME 1, MD 1

The diaphragm pumps ME 1 offer a compact and high performance solution. With their easy-to-use functionality, they are a perfect partner for both single and multiple filtrations.

One-stage diaphragm pumps are an excellent solution for continuous, oil-free pumping of gases and vapors for modest vacuum requirements. In contrast to water-jet pumps, they do not consume water and therefore do not produce any contaminated waste water in daily use.

Vacuum filtration is frequently used for sample preparation in chemistry, microbiology, waste water control and analysis. Typical applications for the ME 1 are aqueous filtrations. The PTFE diaphragm and valves are rugged and provide high chemical resistance. If aluminium has the required specific resistance, solvent-containing samples can also be filtrated.

VACUUBRAND



9.880 930



9.880 080

Type	Dimensions (W x D x H)	Flow rate (50/60 Hz)	Number of steps	Ultimate vacuum	Connector	Weight	PK	Cat. No.
	mm	L / min.		mbar		kg		
ME 1	247 x 121 x 145	11.66 / 14.16	1	100	CEE	5.0	1	9.880 930 1
ME 1	247 x 121 x 145	11.66 / 14.16	1	100	UK	5.0	1	9.880 932
MD 1	303 x 143 x 163	20 / 23.33	3	1.5	CEE	6.5	1	9.880 080 2
MD 1	303 x 143 x 163	20 / 23.33	3	1.5	UK	6.5	1	6.284 823

Country-specific power cord versions available on request.

Diaphragm pumps chemistry design, ME 1C, MZ 1C, MD 1C

The diaphragm pumps ME 1C offer a compact and high performance solution. With their easy-to-use functionality, they are the perfect partner for both single and multiple filtrations.

One-stage diaphragm pumps are an excellent solution for continuous, oil-free pumping of gases and vapors for modest vacuum requirements. In contrast to water-jet pumps, they do not consume water and therefore do not produce any contaminated waste water in daily use.

Vacuum filtration is frequently used for sample preparation in chemistry, microbiology, waste water control and analysis. In the chemistry diaphragm pumps ("C") all major parts in contact with pumped media are made of chemically resistant fluoroplastics. The ME 1C is also often used for solid phase extraction (SPE).

An optional manual regulator valve with dial gauge enables variable fine adjustment of the pumping speed and the ultimate vacuum.

Gas ballast for reliable pump performance.

Two up to four stage chemistry diaphragm pumps (letters in the product name Z, D or V) are equipped with a manual gas ballast valve as standard. The supply of gas ballast minimizes the risk of condensation inside the pump.

VACUUBRAND



9.880 934



9.880 083

Type	Dimensions (W x D x H)	Flow rate (50/60 Hz)	Ultimate vacuum without / with gas ballast	Connector	Weight	PK	Cat. No.
	mm	L / min.	mbar		kg		
ME 1C	247 x 121 x 145	11.66 / 14.16	100	CEE	5.0	1	9.880 934 3
ME 1C	247 x 121 x 145	11.66 / 14.16	100	UK	5.0	1	9.880 936
MZ 1C	312 x 121 x 170	12.5 / 15	12 / 20	CEE	6.7	1	6.254 394
MZ 1C	312 x 121 x 170	12.5 / 15	12 / 20	UK	6.7	1	9.880 947
MD 1C	316 x 143 x 223	21.66 / 25	2 / 4	CEE	6.9	1	9.880 083 4
MD 1C	316 x 143 x 223	21.66 / 25	2 / 4	UK	6.9	1	6.284 822

Diaphragm pumps ATEX-models available on request. Country-specific power cord versions available on request.

Diaphragm pumps, Aluminium

- Improved performance, increased pumping speed (up to 16 m³/h) and better ultimate vacuum (up to 0.5 mbar). VACUUBRAND
- Extend applications with non-aggressive gases whether used in the laboratory or for industrial processes.
- Very low leak rate due to enhanced leak-tight tubing connections, resulting in consistent performance characteristics
- even after many years of operation. Ideal for analytical applications.
- Long diaphragm and valve lifetimes: made of highly flexible FPM, with fabric-reinforced double diaphragms for improved long term stability.
- Very quiet and ultra low vibration due to compact drive with patented motor drive system. Ideal as a built-in component for sensitive analytical equipment.
- Easy to clean due to smooth surfaces. A robust solution for numerous applications in industrial environments

The VARIO® design provides vacuum control by precise and continuous adaption of the diaphragm pumps motor speed, and includes the vacuum pump, as well as the VACUU-SELECT controller.

Specifications

Vacuum inlet	
10 mm tubing nozzle:	ME4NT, ME4RNT, ME8NT, MZ2NT
KF DN16:	MZ2DNT, MD4NT, MV2NT
Pressure outlet	
Silencer:	ME4NT, MZ2NT, MZ2DNT, MD4NT, MV2NT
Twin silencers:	ME8NT
Tubing nozzle:	ME4RNT

Type	Dimensions (W x D x H) mm	Flow rate (50/60 Hz) L / min.	Ultimate vacuum mbar	Number of steps	Connector	PK	Cat. No.
ME 2 NT	243 x 211 x 198	33.33 / 36.67	70	1	CEE	1	9.880 940
ME 2 NT	243 x 211 x 198	33.33 / 36.67	70	1	UK	1	9.880 941
ME 4 NT	239 x 243 x 198	66.67 / 73.33	70	1	CEE	1	9.880 883
ME 4 NT	239 x 243 x 198	66.67 / 73.33	70	1	UK	1	4.670 420
ME 4R NT	239 x 243 x 290	63.33 / 70	100	1	CEE	1	9.880 884
ME 4R NT	239 x 243 x 290	63.33 / 70	100	1	UK	1	4.670 423
ME 8 NT	239 x 325 x 198	121.67 / 135	70	1	CEE	1	9.880 885
ME 8 NT	239 x 325 x 198	121.67 / 135	70	1	UK	1	4.670 483
ME 16 NT	554 x 260 x 359	273.30 / 306.67	70	1	CEE	1	9.880 952 ¹
ME 16 NT	554 x 260 x 359	273.30 / 306.67	70	1	UK	1	9.880 953
MZ 2 NT	239 x 243 x 198	36.67 / 40	7	2	CEE	1	9.880 887
MZ 2 NT	239 x 243 x 198	36.67 / 40	7	2	UK	1	4.670 427
MD 12 NT	554 x 260 x 359	201 / 221	2	3	UK	1	9.880 950
MD 12 VARIO select	554 x 260 x 420	223	1.5	3	CEE	1	4.670 566
MD 4 NT	239 x 325 x 198	63.30 / 71.67	1	3	CEE	1	9.880 890 ²
MD 4 NT	239 x 325 x 198	63.30 / 71.67	1	3	UK	1	4.670 487
MD 4 VARIO select	239 x 325 x 245	95	1	3	CEE	1	4.670 492
MV 10 NT	554 x 260 x 359	173.30 / 193.30	0.5	4	CEE	1	9.880 954
MV 10 VARIO select	554 x 260 x 420	202	0.3	4	CEE	1	7.983 695
MV 10 VARIO select	554 x 260 x 420	202	0.3	4	UK	1	4.670 571
MV 2 VARIO select	239 x 325 x 245	55	0.3	4	CEE	1	4.670 552

Country-specific power cord versions available on request.

1



9.880 952

2



9.880 890

1 Diaphragm vacuum pumps -NT Series, Chemistry design

- Improved performance, increased pumping speed and lower ultimate vacuum extends applications in both the laboratory and in industrial applications.
- Long-life diaphragm with PTFE sandwich construction and unstressed diaphragm support.
- Easy service/exchange of diaphragm or valves due to novel integrated valve head assembly. Easy dismantling, cleaning and reassembly without requiring readjustment.
- Very quiet and ultra low vibration due to compact drive with patented motor control system. Ideal as a built-in component for sensitive equipment in both the laboratory and in industry.
- Superior vapour tolerance due to integral tubing connections and gas ballast valve for continuous purge (at ME 16C NT, MZ 2C NT, MD 4C/12C NT and MV 10C NT).
- Easy to clean due to smooth exterior surfaces.

VACUUBRAND



The VARIO® design provides vacuum control by precise and continuous adaption of the chemistry diaphragm pumps motor speed, and includes the vacuum pump, as well as the VACUU-SELECT controller.

Specifications

Vacuum inlet: 10 mm tubing nozzle
Pressure outlet: 10 mm tubing nozzle

Type	Dimensions (W x D x H) mm	max. discharge flow m ³ / hr.	Ultimate vacuum without / with gas ballast mbar (abs.)	Number of steps	Connector	PK	Cat. No.
ME 2C NT	243 x 211 x 198	2.1 / 2.4	70	1	CEE	1	9.880 943
ME 2C NT	243 x 211 x 198	2.1 / 2.4	70	1	UK	1	9.880 944
ME 4C NT	243 x 255 x 198	3.9 / 4.3	70	1	CEE	1	9.880 894
ME 4C NT	243 x 255 x 198	3.9 / 4.3	70	1	UK	1	4.670 425
MZ 2C NT	243 x 243 x 198	2.0 / 2.3	7 / 12	2	CEE	1	9.880 898
MZ 2C VARIO select	243 x 243 x 245	2.8	7 / 12	2	CEE	1	4.670 437
ME 8C NT	243 x 325 x 198	7.1 / 7.8	70	1	CEE	1	9.880 896
ME 8C NT + 2AK	243 x 319 x 374	7.1 / 7.8	70	1	-	1	6.267 643
MD 4C NT	243 x 325 x 198	3.4 / 3.8	1.5 / 3	3	CEE	1	9.880 900
MD 4C NT	243 x 325 x 198	3.4 / 3.8	1.5 / 3	3	UK	1	4.670 495
MD 4CRL NT	243 x 325 x 198	3.4 / 3.8	1.5 / 0.001*	3	-	1	9.880 926
MD 4C VARIO select	243 x 325 x 245	4.6	1.5 / 3	3	CEE	1	4.670 500
ME 16C NT	533 x 260 x 359	16.3 / 18.4	70 / 100	1	CEE	1	9.880 955
ME 16C NT	533 x 260 x 359	16.3 / 18.4	70 / 100	1	UK	1	9.880 956
ME 16C VARIO select	533 x 260 x 450	20	70 / 100	1	CEE	1	4.672 102
MD 12C NT	533 x 260 x 359	12.0 / 13.3	2 / 4	3	CEE	1	9.880 957
MD 12C NT	533 x 260 x 359	12.0 / 13.3	2 / 4	3	UK	1	9.880 958
MD 12C VARIO select	533 x 260 x 450	14.3	1.5 / 3	3	CEE	1	6.311 049
MD 12C VARIO select	533 x 260 x 450	14.3	1.5 / 3	3	UK	1	4.672 103
MV 10C NT	533 x 260 x 359	9.5 / 10.7	0.9 / 1.5	4	CEE	1	9.880 960
MV 10C VARIO select	533 x 260 x 359	9.5 / 10.7	0.9 / 1.5	4	CEE	1	4.672 104

* diaphragm pump with reduced leakage rate (mbar x l/s). Country-specific power cord versions available on request.

2 Diaphragm pump MPC 101 Z

The two-stage pump is designed for pumping and compressing gases and vapours and generate vacuum e.g. for rotary evaporators, vacuum ovens and vacuum filtration. Their electrical conductivity prevents electrostatic charging and minimizes the risk of the gas mixture igniting inside the pump.

Welch Vacuum



- For tubes with ID = 8 mm
- Chemically resistant
- Resistant to aggressive solvents and acid vapours
- Elastomer diaphragms with PTFE layer
- Pump and connection heads are carbon fibre reinforced
- Integrated motor protection switch
- Vibration isolating feet

Scope of delivery: 2-head chemical diaphragm pump, external power supply and device connection cable with plug (EU, UK).

Specification

Pump speed 50/60 Hz: 16.7/18.3 l/min
Final vacuum (abs.): < 8 mbar
Suction/pressure connection: Hose nozzle DN 8
Noise: < 44 dB(A)
Motor power: 60 W
Voltage/frequency: 230 V/50/60 Hz
Dimensions (W x D x H): 225 x 195 x 147 mm
Weight: 6.5 kg
IP code: IP 54

Type	Ultimate vacuum mbar (abs.)	Flow rate L / min.	Dimensions (W x D x H) mm	PK	Cat. No.
MPC 101 Z	8	18	225 x 195 x 147	1	6.241 127

1

1 Diaphragm pump MPC 301 Z

The two-stage pump is designed for pumping and compressing gases and vapours and generate vacuum e.g. for rotary evaporators, vacuum ovens and gel dryers. *Welch Vacuum*
 Their electrical conductivity prevents electrostatic charging and minimizes the risk of the gas mixture igniting inside the pump.

- For tubes with ID = 8 mm
- Chemically resistant
- Resistant to aggressive solvents and acid vapours
- Elastomer diaphragms with PTFE layer
- Pump and connection heads are carbon fibre reinforced
- Integrated motor protection switch
- Vibration isolating feet

Scope of delivery: 2-head chemical diaphragm pump, external power supply and device connection cable with plug (EU, UK).

Specification

Pump speed 50/60 Hz:	38.3/41.7 l/min
Final vacuum (abs.):	< 8 mbar
Suction/pressure connection:	Hose nozzle DN 8
Noise:	< 44 dB(A)
Motor power:	180 W
Voltage/frequency:	230 V/50/60 Hz
Dimensions (W x D x H):	265 x 230 x 170 mm
Weight:	11.2 kg
IP code:	IP 54

Type	Ultimate vacuum mbar (abs).	Flow rate L / min.	Dimensions (W x D x H) mm	PK	Cat. No.
MPC 301 Z	8	41	265 x 230 x 170	1	6.224 872

2

2 Laboratory Vacuum Pump Microsart® e.jet

The laboratory vacuum pump for the filtration of samples in microbiology. *Sartorius Lab Instruments*
 During the vacuum filtration, the filtrate is directly discharged to the drain.

- Transmembranous pressure of less than 700 mbar, acc. ISO 8199
- Constant flow rates
- Defined maximum vacuum
- Suitable for gases and liquids

Specifications

Flow rate:	> 4.0 l/min.
Max. vacuum:	0.4 bar
Power supply:	100 ... 240 V , 47 ... 63 Hz

Type	PK	Cat. No.
Microsart® e.jet	1	7.629 701

3

9.880 613

Diaphragm vacuum pumps LABOPORT®

- Application: Fluid aspiration, Degassing, Gel drying, Rotary evaporation, Centrifugal concentration, Distillation *KNF*
- Flow rate up to 2.04 m³/h/Ultimate vacuum up to 8 mbar abs.
- High level of vapor and condensate compatibility
- PTFE pump head combined with PTFE-coated diaphragm are ideal for extremely aggressive/corrosive gases and vapors
- N 820.3 FT.18 and N 840.3 FT.18: ATEX-compliant in accordance with ATEX II 2/-G IIB+H2 T3 Gb internal atmosphere only

Specifications

Operating pressure:	1 bar
Connectors for tube:	ID10 mm
Permissible media and ambient temperature:	5 to 40 °C
Pump head:	PTFE
Diaphragm:	PTFE-coated
Valves:	FFPM

4

9.880 675

Type	Width mm	Length mm	Height mm	Flow rate L / min.	Ultimate vacuum mbar (abs).	PK	Cat. No.
N 820.3 FT.18	154	312	207	20	8	1	9.880 613 3
N 840.3 FT.18	166	341	226	34	8	1	9.880 614
N 842.3 FT.18	167	341	223	34	2	1	9.880 675 4



Diaphragm vacuum pumps LABOPORT® N820G/N840G, chemically-resistant

The compact pumps feature a control knob for manual adjustments of the flow rate, making them well suited to a wide variety of applications, e.g. rotary evaporation, distillation, gel drying, degassing as well as the use with vacuum ovens and vacuum concentrators. Due to the manual rotational speed control, the pumps are quiet, very energy efficient, and can be optimally adjusted in accordance with the application.

KNF

- Easy-to-clean surface
- Adjustable in flowrate due to manual rotational speed control
- Combination of PTFE pump head and PTFE-coated diaphragm makes the pump ideal for extremely aggressive/corrosive gases and vapors
- High level of compatibility with vapor and condensation
- Integrated gas ballast valve
- 3-color status display: In operation/Stand-by/Error
- ATEX-compliant in accordance with II 2/-G IIB+H2 T3 internal atmosphere only
- 100 % oil-free transfer to ensure uncontaminated transfer, evacuation and compression
- Optional: Easily expandable with separators and/or condensers

Specifications

Ultimate vacuum (abs.):	6 mbar
Operating pressure:	0.1 bar
Connectors for tube:	ID9/10 mm
Permissible ambient temperature:	5 ... 40 °C
Pump head:	TFM™ PTFE
Diaphragm:	PTFE-beschichtet
Valves:	FFPM

Type	Flow rate L / min.	Ultimate vacuum mbar (abs).	Width mm	Depth mm	Height mm	Weight kg	PK	Cat. No.
N820G	20	6	163	259	220	8.8	1	4.672 375 1
N840G	34	6	177	289	240	11.3	1	4.672 376

2

Diaphragm vacuum pumps LABOPORT® SD, chemically-resistant

t-Application: Rotary evaporation, Distillation, Vacuum oven, Centrifugal concentration

KNF

- Flow rate up to 2.04 m³/h/Ultimate vacuum 10 mbar abs.
- Integrated KNF self-drying system ensures that condensate is quickly removed from the pump heads without the vacuum being altered. This significantly reduces process time and preserves the pump heads.
- Chemically resistant and thus ideal for use with extremely aggressive/corrosive gases and vapors

Specifications

N 820 // N 840

Operating pressure:	1 bar
Flow rate:	2.04 m³/h
Ultimate vacuum:	10 mbar
Connectors for tube:	ID10 mm
Permissible ambient temperature:	5 to 40 °C
Pump head:	PTFE
Diaphragm:	PTFE-coated
Valves:	FFPM
Weight:	9.6 kg // 12.9 kg

Type	Flow rate L / min.	Ultimate vacuum mbar (abs).	Width mm	Length mm	Height mm	PK	Cat. No.
N 820.3 FT.40.18	20	10	177	312	220	1	9.880 615
N 840.3 FT.40.18	34	10	189	341	239	1	9.880 616

1



4.672 375

2



1 Diaphragm Vacuum Pump N 920 G

- Application: Degassing, Gel drying, Rotary evaporation, Distillation, Centrifugal concentration
- Flow rate 1.26 m³/h/Ultimate vacuum 2 mbar abs.
- High suction speed, particularly in the low vacuum range
- Integrated rotational speed control enables pumping capacity to be easily adapted manually to process requirements
- PPS pump head combined with PTFE-coated diaphragm are ideal for aggressive/corrosive gases and vapors
- Integrated gas ballast valve

KNF

Tip: When combined with the VC 900 vacuum control unit and the connection cable, the rotational speed is controlled in accordance with the requirements of the process.

Specifications

Operating pressure:	0.5 bar
Connectors for tube:	ID10 mm
Permissible media and ambient temperature:	5 to 40 °C
	10 to 40 °C
Pump head:	PPS
Diaphragm:	PTFE-coated
Valves:	FFPM
Weight:	8.5 kg

Type	Flow rate l / min.	Ultimate vacuum mbar (abs).	Width mm	Length mm	Height mm	PK	Cat. No.
N 920 G	21	2	158	324	226	1	6.287 429

2 Diaphragm Vacuum Pump N 860.3 FT.40.18

- Application: Rotary evaporation, Distillation, Vacuum oven, Centrifugal concentration
- Flow rate 3.6 m³/h/Ultimate vacuum 4 mbar abs.
- Integrated KNF self-drying system ensures that condensate is quickly removed from the pump heads without the vacuum being altered. This significantly reduces process time and preserves the pump heads.
- Chemically resistant and thus ideal for use with extremely aggressive/corrosive gases and vapors

KNF

Specifications

Operating pressure:	1 bar
Connectors for tube:	ID12 mm
Permissible media and ambient temperature:	5 to 40 °C
Pump head:	PTFE
Diaphragm:	PTFE-coated
Valves:	FFPM
Weight:	14.8 kg

Flow rate l / min.	Ultimate vacuum mbar (abs).	Width mm	Length mm	Height mm	PK	Cat. No.
60	4	291	331	278	1	7.608 467

1



2



Vacuum Pumps Rotavac Vario

Suitable for Rotary evaporators Hei-VAP series. Controllable vacuum pumps for digital regulation of the vacuum via operation panel or directly at the unit.

Heidolph

- High distillation rates and reduced process time by 30 %.
- Solvent recovery up to 99 %.
- Pump stops automatically as soon as the set vacuum is reached and reliably holds the vacuum constant
- Increased diaphragm performance life due to periods of non-operation
- Low energy consumption
- Significant noise and vibration reduction
- The pumps can be combined with a condenser

1 Vacuum Pumps Rotavac Vario Control

- 3-stage diaphragm pump
- High suction capacity for fastest evacuation
- Even if the gas ballast valve is open an excellent ultimate vacuum is reached when working with easily condensable vapors. This makes distilling high boiling point solvents such as DMF or DMSO possible at low bath temperatures

Heidolph

Specifications

Suction capacity:	1.7 m ³ /h
Ultimate vacuum:	2 mbar
Power input:	160 W
Dimensions (W x D x H):	167 x 236 x 196 mm
Weight:	5.4 kg

Type	PK	Cat. No.
Rotavac Vario Control for Hei-VAP	1	9.812 477



2 Vacuum Pumps Rotavac Vario Tec

- 2-stage diaphragm pump
- Recommended for solvents with low or medium boiling points

Heidolph

Specifications

Suction capacity:	1 m ³ /h
Ultimate vacuum:	12 mbar
Power input:	160 W
Dimensions (W x D x H):	156 x 236 x 196 mm
Weight:	4.3 kg

Type	PK	Cat. No.
Rotavac Vario Tec for Hei-VAP	1	9.812 478



3 Vacuum Pumps Rotavac Vario Pump Unit

Suitable for Hei-VAP Core. Fully controllable stand-alone pumping unit including vacuum controller

Heidolph

- 3-stage diaphragm pump is made from chemical-resistant material
- High suction capacity for fast evacuation
- Precise vacuum control avoids bumping and eliminates foaming of your evaporation solution
- Automatic vacuum supply to the process parameters
- The pump unit can be combined with a condenser

Specifications

Suction capacity:	1.7 m ³ /h
Ultimate vacuum:	5 mbar
Power input:	160 W
Dimensions (W x D x H):	193 x 263 x 299 mm
Weight:	6 kg

Type	PK	Cat. No.
Rotavac Vario stand-alone pumping	1	9.812 365



1

4.658 071

Speed vacuum systems SC 920 G, SC 950, SCC 950

- Application: Vacuum oven
- Flow rate up to 3 m³/h/Ultimate vacuum 2 mbar abs.
- Integrated KNF self-drying system ensures that condensate is quickly removed from the pump heads without the vacuum being altered. This significantly reduces process time and preserves the pump heads.
- Chemically resistant and thus ideal for use with extremely aggressive/corrosive gases and vapors

KNF

SC 920G: Vacuum system for one rotary evaporator.

SC 950: Vacuum system for one rotary evaporator, with higher flow rate

SCC 950: Vacuum system for 2 rotary evaporators. Equipped with 2 controllers for different vacuum requirements.

2

6.266 708

Specifications

Connectors for tube:

SC 920 G:

SC 950:

Permissible media and ambient temperature:

Pump head:

Diaphragm:

Valves:

pneumatic ID10 mm, coolants ID8 mm

inert gas ID6 mm

inert gas ID4 mm

5 to 40 °C

PPS

PTFE-coated

FFPM

Type	Flow rate L / min.	Ultimate vacuum mbar (abs).	Width mm	Length mm	Height mm	PK	Cat. No.
SC 920 G	20	2	366	294	423	1	4.658 071 1
SC 950	50	2	246	313	487	1	6.266 708 2
SCC 950	50	2	353	376	487	1	6.287 426

With overload protection and mains fuse

3

4.662 294

Chemistry Pumping Units VARIO® select

NEW

VACUUBRAND

The combination of speed controlled VARIO® chemistry diaphragm pumps and the new VACUU-SELECT vacuum controller makes the VARIO® select chemistry pumps the ideal solution for chemical processes that require precise vacuum, such as rotary evaporation, vacuum drying or vacuum concentration.

- High chemical resistance and therefore ideally suited for pumping aggressive gases and vapours.
- Short process times and smooth running due to optimal setting of the pressure via the VACUU-SELECT controller.
- The VARIO® technology controls the vacuum precisely and efficiently via motor speed.
- Power consumption, maintenance and noise are exceptionally low.
- The outlet catchpot and solvent condenser combine to prevent solvent vapor emissions into the lab, allowing for nearly full recovery of solvents.

Type	Flow rate (50/60 Hz) L / min.	Ultimate vacuum without / with gas ballast mbar	Dimensions (W x D x H) mm	Plug type	Weight kg	PK	Cat. No.
PC 3001 VARIO® select	33.3	2 / 4	306 x 303 x 400	CEE	8.2	1	4.662 294 3
PC 3001 VARIO® select	33.3	2 / 4	306 x 303 x 400	UK	8.2	1	6.274 832
PC 3002 VARIO® select	46.67	7 / 12	419 x 243 x 457	CEE	17.9	1	7.649 323
PC 3002 VARIO® select	46.67	7 / 12	419 x 243 x 457	UK	17.9	1	4.670 478
PC 3003 VARIO® select	46.67	0.6 / 1.5	419 x 243 x 457	CEE	21.1	1	6.311 665
PC 3003 VARIO® select	46.67	0.6 / 1.5	419 x 243 x 457	UK	21.1	1	4.670 558
PC 3004 VARIO® select	76.67	1.5 / 3	419 x 243 x 457	CEE	21.1	1	4.667 856
PC 3004 VARIO® select	76.67	1.5 / 3	419 x 243 x 457	UK	21.1	1	4.670 543
PC 3010 VARIO® select	193.33	0.6 / 1.5	616 x 387 x 450	CEE	27.0	1	4.672 099
PC 3012 VARIO® select	215	1.5 / 3	616 x 387 x 450	CEE	27.0	1	4.672 100
PC 3016 VARIO® select	321.67	70 / 100	616 x 387 x 450	CEE	27.0	1	4.672 098

Country-specific power cord versions available on request.

9. Vacuum technology, Drying, Dry storage

Diaphragm pumps/Pump units-speed controlled-Pump units-valve controlled

1 Chemistry Pumping Unit PC 3001 VARIO® select with condenser Peltronic®

The PC 3001 VARIO® select pumping unit precisely controls the vacuum level in order to achieve unparalleled process control. VACUUBRAND
 This pump is suitable for even high boiling point solvents. The integrated VACUU-SELECT controller provides an easy-to-use, application based interface that covers all common lab applications. The pump's variable motor speed responds to demand, reducing energy waste and mechanical wear, ensuring unrivalled service life for the diaphragms.

- For solvent evaporation, the controller detects solvent boiling and automatically adjusts the pump's motor speed to maintain process control
- User-defined applications with simple drag-and-drop editing.
- Small footprint and low weight for flexible use in the laboratory
- The inlet separator, made of glass with a robust protective coating, prevents particles and liquid droplets from entering the pump
- The included emission condenser Peltronic® works without any cooling media like water or dry ice.

Scope of supply: Chemistry pumping unit PC 3001 VARIO® select completely mounted with condenser Peltronic®, ready for use, with manual.

Without mains cable, please order separately.

Specifications

Cooling power at 21 °C:	50 W
Ambient temperature range:	10 ... 40 °C
Preset cooling temperature:	10 °C
Materials in contact with media:	PP, PFA, ETFE/ECTFE, borosilicate glass
Power supply:	100 ... 230 V, 50/60 Hz
Dimensions (W x D x H):	175 x 179 x 392 mm

Description	Flow rate (50/60 Hz) L / min.	Ultimate vacuum mbar	Weight kg	Dimensions (W x D x H) mm	PK	Cat. No.
PC 3001 VARIO® select EKP	33.33	2	11.8	300 x 370 x 400	1	4.669 248

2 Vacuum system LABOPORT®

- Application: Rotary evaporation, Distillation KNF
- Flow rate up to 2.04 m³/h/Ultimate vacuum 8 mbar abs.
- Vacuum system comprising chemically resistant diaphragm vacuum pump, base plate, condenser, separator and vacuum control unit
- PTFE pump head combined with PTFE-coated diaphragm are ideal for extremely aggressive/corrosive gases and vapors

Specifications

Operating pressure:	1 bar
Connectors for tube:	pneumatic ID10 mm, coolants ID8 mm
Permissible ambient temperature:	5 to 40 °C
Pump head:	PTFE
Diaphragm:	PTFE-coated
Valves:	FFPM

Type	Flow rate L / min.	Ultimate vacuum mbar (abs).	Pump Model	PK	Cat. No.
LABOPORT® SC 820	20	8	N 820.3 FT.18	1	9.880 627
LABOPORT® SC 840	34	8	N 840.3 FT.18	1	9.880 632



Vacuum Pumps Rotavac Valve

Suitable for all Hei-VAP Rotary evaporators.

Heidolph

Vacuum can be controlled manually or via valve operated vacuum controllers.

- With two-stage diaphragm pump
- All components which come in contact with media are built from chemically resistant fluoropolymer
- The durable PTFE design guarantees an superior diaphragm lifespan
- The head cover and clamping disc have a stable core made of metal which offers unsurpassed long-term performance of your operational parameters
- The direct pump drive (without belt) is exceptionally quiet, creates a very low vibrational environment and reduces the need of wear and tear parts to a minimum
- The gas ballast valve has been optimized to prevent media condensing in the pump
- The pumps can be combined with a condenser
- For combination with the Hei-VAP Precision Rotary evaporators a vacuum valve is necessary.

1



1 Vacuum Pumps Rotavac Valve Control

- High suction capacity for fast evacuation
- Suction capacity for up to 3 rotary evaporators at the same time
- Depending on your application you can switch on and off the vacuum pump via switchbox

Heidolph

Specifications

Suction capacity:	2 m ³ /h
Ultimate vacuum:	7 mbar
Power input:	180 W
Dimensions (W x D x H):	195 x 245 x 310 mm
Weight:	12.8 kg

Type	PK	Cat. No.
Rotavac Valve Control	1	9.812 385

2



2 Vacuum Pumps Rotavac Valve Tec

Recommended for solvents with low or medium boiling points.

Heidolph

Specifications

Suction capacity:	0.75 m ³ /h
Ultimate vacuum:	12 mbar
Power input:	80 W
Dimensions (W x D x H):	145 x 315 x 169 mm
Weight:	6 kg

Type	PK	Cat. No.
Rotavac Valve Tec for Hei-VAP	1	6.231 964

3



3 Valve-regulated vacuum pump Rotavac 20

Includes secondary condenser and air intake separation vessel. This vacuum system can be applied in many different fields in order to evacuate, evaporate and pump out gases and vapors. Thanks to the emission condenser it is possible to achieve a chemical recovery of almost 100 %.

Heidolph

- Excellent compatibility with chemicals and condensate
- Excellent ultimate vacuum
- Very quiet and very low Vibration
- Very high suction capacity of 50 l/min

Specifications

Suction capacity:	3 m ³ /h
Ultimate vacuum:	2 mbar
Power input:	250 W
Dimensions (W x D x H):	350 x 275 x 495 mm
Weight:	19.9 kg

Type	PK	Cat. No.
Rotavac 20	1	6.257 926

Chemistry Pump Units and Vacuum Systems

Compact design, ready to use, no set-up required. Constructed in chemically resistant materials. Quiet operation.

VACUUBRAND

- 100 % oil-free pumping of gases
- gas ballast as standard for working with condensable vapours
- good vacuum even with gas ballast
- high vapour tolerance for water and solvents
- long service life, low maintenance

Features:

2AK: Inlet and outlet separator

AK + EK: Inlet separator, exhaust vapour condenser

PC 510 select (two-stage)/610 select (three-stage) : with AK + EK; 1 electronically controlled vacuum port

PC 511 select (two-stage)/611 select (three-stage) : with AK + EK; 1 electronically controlled and 1 manually controlled vacuum port

PC 520 select (two-stage)/620 select (three-stage) : with AK + EK; 2 electronically controlled vacuum ports

Characteristics and applications:

Without vacuum control:

MZ 2C NT +2AK: e.g. filtration, distillation without condensation at the outlet

MZ 2C NT +AK+EK: Well-proven unit for a wide range of applications for the single-user, e.g. gel drying, distillation, vacuum concentrator. For solvents with medium to low volatility.

MD 1C +AK+EK: Space-saving single-user configuration. For high-boiling-point solvents.

MD 4C NT + AK+EK: Larger or multi-user applications, the local vacuum network VACUU-LAN®.

For high-boiling solvents.

MV 10C NT +EK: Four-stage diaphragm pump with exhaust vapour condenser. For particularly high demands regarding low ultimate vacuum and pumping speed in chemistry laboratories, pilot plant or small production units.

With vacuum controller:

PC 510 select/511 select: Well-proven units for a wide range of processes in chemistry laboratories, e.g. all common solvents. PC 511 select with additional manually controlled vacuum port.

PC 610 select/611 select: Proven solution for supporting electronically controlled evaporation or drying processes even with many high boiling point solvents. PC 611 select with additional manually controlled vacuum port.

PC 520 select/620 select: Compact solution for simultaneous operation of two electronically controlled vacuum applications with one single pump.

1



9.880 921

2



4.665 353

Type	Dimensions	max. discharge flow	Ultimate vacuum without / with gas ballast	Connector	PK	Cat. No.
	(W x D x H)					
	mm					
MD 1C + AK + EK	239 x 316 x 405	1.3 / 1.5	2 / 4	CEE	1	9.880 828
MD 1C + AK + EK	239 x 316 x 405	1.3 / 1.5	2 / 4	UK	1	4.670 345
MZ 2C NT + 2AK	243 x 319 x 309	2.0 / 2.3	7 / 12	CEE	1	9.880 832
MZ 2C NT + 2AK	243 x 319 x 309	2.0 / 2.3	7 / 12	UK	1	4.670 442
MZ 2C NT + AK + EK	242 x 326 x 402	2.0 / 2.3	7 / 12	CEE	1	6.234 067
MZ 2C NT + AK + EK	242 x 319 x 309	2.0 / 2.3	7 / 12	UK	1	4.670 445
MZ 2C NT + AK + M + D	243 x 310 x 313	2.0 / 2.3	7 / 12	CEE	1	6.231 821
MZ 2C NT + AK SYNCHRO + EK	243 x 326 x 402	2.0 / 2.3	7 / 12	CEE	1	9.880 921 1
MZ 2C NT + AK SYNCHRO + EK	243 x 310 x 313	2.0 / 2.3	7 / 12	UK	1	4.670 449
PC 510 select	243 x 418 x 457	2.0 / 2.3	7 / 12	CEE	1	4.665 353 2
PC 510 select	243 x 418 x 457	2.0 / 2.3	7 / 12	UK	1	4.670 456
PC 511 select	243 x 435 x 457	2.0 / 2.3	7 / 12	CEE	1	7.983 629
PC 511 select	243 x 435 x 457	2.0 / 2.3	7 / 12	UK	1	4.670 463
PC 520 select	243 x 435 x 457	2.0 / 2.3	7 / 12	CEE	1	7.983 628
PC 520 select	243 x 435 x 457	2.0 / 2.3	7 / 12	UK	1	4.670 470
MD 4C NT + AK + EK	243 x 326 x 402	3.4 / 3.8	1.5 / 3	CEE	1	9.880 837
MD 4C NT + AK + EK	248 x 326 x 402	3.4 / 3.8	1.5 / 3	UK	1	4.670 506
PC 610 select	243 x 419 x 457	3.4 / 3.8	1.5 / 3	CEE	1	4.670 516
PC 610 select	243 x 419 x 457	3.4 / 3.8	1.5 / 3	UK	1	4.670 518
PC 611 select	243 x 435 x 457	3.4 / 3.8	1.5 / 3	CEE	1	4.670 525
PC 611 select	243 x 435 x 457	3.4 / 3.8	1.5 / 3	UK	1	4.670 527
PC 620 select	243 x 435 x 457	3.4 / 3.8	1.5 / 3	CEE	1	4.670 533
PC 620 select	243 x 435 x 457	3.4 / 3.8	1.5 / 3	UK	1	4.670 535
MD 12C NT + EK	387 x 528 x 395	12.0 / 13.3	2 / 4	CEE	1	9.880 965
MD 12C NT + AK + EK	387 x 616 x 395	12.0 / 13.3	2 / 4	CEE	1	9.880 968
MD 12C NT + AK + EK	387 x 616 x 395	12.0 / 13.3	2 / 4	UK	1	9.880 970
MV 10C NT + EK	528 x 387 x 395	9.5 / 10.7	0.9 / 1.5	CEE	1	9.880 976

Country-specific power cord versions available on request.

Rotary vane pumps/Pumps



1 Rotary vane pumps

Vacuubrand rotary vane pumps encompass one and two stage pumps with throughputs from 2 to 9 m³/h.

VACUUBRAND

Typical rotary vane pump applications include, use as a backing pump for turbomolecular pumps but also serve in diverse chemical laboratory applications.

Features and important characteristics: high water vapour tolerance, vacuum tight pumping mechanism when switched off, high performance gas ballast mechanisms. These increase the overall performance potential of these pumps, the service life of mechanical parts, increase oil-change intervals and reduce maintenance overheads.

Type	Dimensions (W x D x H) mm	Flow rate (50/60 Hz) L / min.	Ultimate vacuum (abs.) mbar	Weight kg	Connector	PK	Cat. No.
RE 2.5	316 x 125 x 190	38.33 / 46.67	0.3	10.2	CEE	1	9.880 120
RE 6	370 x 142 x 207	95 / 133.33	0.1	15.4	CEE	1	9.880 121
RE 6	370 x 142 x 207	95 / 133.33	0.1	15.4	UK	1	4.670 373
RE 9	460 x 152 x 232	148.33 / 170	0.1	21.4	CEE	1	9.880 101
RZ 2.5	316 x 125 x 190	38.33 / 46.67	0.002	11.4	CEE	1	9.880 123
RZ 2.5	316 x 125 x 190	38.33 / 46.67	0.002	11.4	UK	1	4.670 378
RZ 6	370 x 142 x 207	95 / 133.33	0.002	16.4	CEE	1	9.880 124
RZ 9	460 x 152 x 232	148.33 / 170	0.002	24.2	CEE	1	9.880 125
RZ 9	460 x 152 x 232	148.33 / 170	0.002	24.2	UK	1	4.670 384

Country-specific power cord versions available on request.

Rotary vane pump CRVpro 2/4/6/8

The Welch CRVpro pumps are high-performance two-stage vacuum pumps.

Welch Vacuum

They impress with their long service life, high reliability and low maintenance requirements.

The CRVpro series are the perfect partners for freeze dryers, vacuum concentrators, Schlenklines, glove boxes and vacuum ovens, as well as industrial applications.

- Cool running operation for less oil consumption
- Coated oil case to slow metal corrosion
- Extended oil change intervals for less maintenance costs
- Dual voltage

Scope of supply: Every pump is supplied complete with Directorr™ Premium vacuum pump oil, centering rings, clamping rings and motor overload protection.



2 Rotary vane pump CRVpro 2

NEW

Welch Vacuum

Specifications

Ultimate pressure without gas ballast partial:	3 x 10 ⁻⁴ mbar
Ultimate pressure without gas ballast total:	3 x 10 ⁻³ mbar
Ultimate pressure with gas ballast total:	9 x 10 ⁻² mbar
Connection:	DN 16 KF
Motor rating 50/60 Hz:	0.29/0.3 kW
Nominal speed 50/60 Hz:	1440/1720 rpm
Dimensions (L x W x H):	384 x 138 x 211 mm
Weight:	15 kg

Type	Suction rate (50/60 Hz) L / min.	Oil capacity ml	Plug type	PK	Cat. No.
CRVpro 2	38/47	450	EU, UK	1	6.313 234



3 Rotary vane pump CRVpro 4/6/8

Welch Vacuum

Specifications

Ultimate pressure without gas ballast partial:	5 x 10 ⁻⁴ mbar
Ultimate pressure without gas ballast total:	2 x 10 ⁻³ mbar
Ultimate pressure with gas ballast total:	7 x 10 ⁻² mbar
Connection:	DN 16 KF
Motor rating 50/60 Hz:	0.37/0.4 kW
Nominal speed 50/60 Hz:	1450/1740 rpm
Dimensions (L x W x H):	463 x 157 x 230 mm

Type	Suction rate (50/60 Hz) L / min.	Oil capacity ml	Weight kg	Plug type	PK	Cat. No.
CRVpro 4	63/77	1150	21.0	EU, UK	1	6.290 993
CRVpro 6	85/122	1150	22.0	EU, UK	1	6.290 994
CRVpro 8	122/143	1000	22.5	EU, UK	1	6.290 995

9. Vacuum technology, Drying, Dry storage

Rotary vane pumps/Pumps-Accessories/for vacuum pumps

1 Rotary Vane Vacuum Pump RC 6

VACUUBRAND

The Rotary Vane Vacuum Pump RC 6 has been designed to minimise the adverse effects of condensable and corrosive vapours. Its main components are a two-stage rotary-vane pump and a two-stage chemistry diaphragm for optimised corrosion resistance. The diaphragm pump continuously evacuates the oil reservoir of the rotary-vane pump in order to keep the partial pressures of solvent vapours, oxygen and corrosive gases at a low level and/or below their condensation point. The RC 6 is a low-maintenance pump for freeze-drying and other applications requiring an ultimate vacuum in the 10⁻³ mbar range.

Scope of supply: Pump, overload circuit breaker and mains cable (2 m), centering and clamping ring for inlet, particulate filter, operating instructions, oil (bottle of 500 ml).

Specifications

Pumping speed 50/60 Hz:	98.33/115 l/min
Ultimate vacuum (partial) without gas ballast:	0.0004 mbar
Ultimate vacuum (total) without gas ballast:	0.002 mbar
Ultimate vacuum (total) with gas ballast:	0.01 mbar
Oil capacity (B-Oil):	min. 0.34 l; max. 0.53 l
Inlet connection:	Small flange NW 16
Outlet connection:	Hose nozzle NW 8-10 mm
Motor rating:	0.37 kW
Nominal speed 50/60 Hz:	1500/1800 rpm
Dimensions (L x W x H):	510 x 305 x 230 mm
Weight:	24.2 kg
IP code:	IP 40



Type	Plug type	PK	Cat. No.
RC 6	CEE	1	9.882 235
RC 6	UK	1	4.670 386

Country-specific power cord versions available on request.

Chemistry pumping units

VACUUBRAND

Vacuubrand chemistry vacuum systems and chemistry pumping units for fine to high vacuum ranges. Complete chemical vacuum systems and chemical pump stands offer the advantages of practical, connection-ready units.

- compact structure, little space requirement and a high degree of mobility
- the great convenience of proven pump stand configuration
- good ultimate vacuum even with gas ballast and smooth running
- high tolerance to water and solvent vapours due to efficient gas ballast

Type	Dimensions (W x D x H) mm	Flow rate (50/60 Hz) L / min.	Ultimate vacuum (abs.) mbar	Pump Model	PK	Cat. No.
PC 3 with RZ 2.5	342 x 448 x 608	38.33 / 46.67	0.002	RZ 2.5	1	9.881 368
PC 3 with RZ 6	370 x 448 x 608	95 / 113.33	0.002	RZ 6	1	9.881 369 2
PC 3 with RZ 9	460 x 486 x 608	148.33 / 170	0.002	RZ 9	1	9.881 370



9.881 369

3 Chemistry pump device GP3

NEW
KGW

The mobile chemistry pump stand has a cold trap and a pump fork with a separate aeration cell. The pump fork has four independently switched vacuum valves and additionally four independently switched aeration valves. So can every sample holder get individually evacuated or aerated without affecting the vacuum of the other sample holders. You can also connect an electronic vacuum gauge. The vacuum pump is not included in the delivery.

- Small flange KF-NW 16 with vacuum manometer
- GL18 glass screw thread
- 10 mm PTFE-olive
- PE-table plate
- Aluminum-rack
- Four lockable guide rolls

Specifications

Capacity with cold trap:	2000 ml
Condensate capacity of cold trap:	max. 250 ml

Type	PK	Cat. No.
Chemistry pump device GP3	1	6.311 927

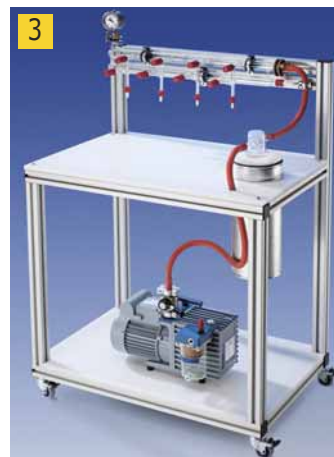

➔ Vacuum tubing - please see page 146.

1

1 Condensation traps, borosilicate 3.3, two-piece

Borosilicate 3.3 glass, comprising bottle with ground glass cone neck fitting a separate inlet/outlet head with choice of tubing or ground joint connections.

Capacity	Cone	Socket	Connection	PK	Cat. No.
ml	NS	NS			
100	29	29	Tubing connections	1	9.305 350
250	45	45	Tubing connections	1	9.305 351
100	29	29	Cone / socket NS 29	1	9.305 352
250	45	45	Cone / socket NS 29	1	9.305 353

2

2 Cold traps, borosilicate 3.3, one-piece

Borosilicate 3.3 glass, one-piece, with GL 45 neck and cap closure, GL 14 threaded side connections with caps and plastic tubing adapters.

Capacity	PK	Cat. No.
ml		
250	1	9.305 349

Cold traps with Dewar flask, borosilicate glass 3.3

Cold traps with Dewar flasks are made from 3.3 DIN/ISO 3585 borosilicate glass to hold LN₂ for vacuum applications. The flasks are vacuum insulated and silver-plated. They are encased in metal sheet, blue coated for protection and have a plastic ring collar, into which the cold trap is inserted. Thus no additional support is needed for the cold trap.

KGW

The Dewar flask has got a theoretical coolant capacity of 1.0 L or 2.0 L respectively.

The cold trap has got a theoretical condensate capacity of 150 ml or 250 ml respectively.

Items supplied: Cold trap, Dewar-flask, plastic ring.

Dewar type 12C/18C: see no. 9.032.024/9.032.030

Versions Cold trap joints:

S29 = spherical joints

GL18 = glass screwthead with PTFE olive 10 mm

O 29 = spherical joints S29 with O-ring seal

The standard assembly is designed for use with LN₂ as coolant. When using CO₂ and acetone please order CO₂ grid separately (Dewar Type 12 C Cat. No. 9.032 081 and Dewar Type 18 C Cat. No. 9.032 082).

Type	Condensate capacity	Coolant capacity	Dewar	Cold trap	PK	Cat. No.
	ml	ml	type	joints		
KF 29-K	150	1000	12 C	S 29	1	9.032 065 3
KF 29-OK	150	1000	12 C	O 29	1	9.032 066 5
KF 29-GL	150	1000	12 C	GL 18	1	9.032 067 4
KFL 29-K	250	2000	18 C	S 29	1	9.032 068
KFL 29-OK	250	2000	18 C	O 29	1	9.032 069
KFL 29-GL	250	2000	18 C	GL 18	1	9.032 070
KF 29-K-A	150	1000	12 C	S 29	1	9.032 071
KF 29-OK-A	150	1000	12 C	O 29	1	9.032 072
KF 29-GL-A	150	1000	12 C	GL 18	1	9.032 073 6
KFL 29-K-A	250	2000	18 C	S 29	1	9.032 074
KFL 29-OK-A	250	2000	18 C	O 29	1	9.032 075
KFL 29-GL-A	250	2000	18 C	GL 18	1	9.032 076



9.032 065



9.032 067



9.032 066



9.032 073

➔ Dewar vessels please see page 770.

1 Woulff bottles, DURAN®



DIN 12480. With 3 NS standard ground joints. Without base tubulature.
Vacuum resistant. Glass Type I/neutral glass as per USP, EP and JP. Autoclavable.

Capacity	Diam.	Neck	PK	Cat. No.
L	mm	NS		
0.5	87	19/26	1	9.305 319
1.0	113	24/29	1	9.305 324
2.0	135	29/32	1	9.305 329
5.0	185	34/35	1	9.305 336

DWK Life Sciences



2 Woulff bottles, DURAN®

Erlenmeyer pattern (5000 ml is bottle-shaped), with reinforced walls, for work under vacuum and plastic coating to act as a splinter and implosion protection. A glass insert is fitted with removable PP tubing connections, vent valve head and analogue pressure gauge with 2 scale ranges (1000 to 0 mbar, 760 mm to 0 mm Hg).

Form	Capacity ml	Diam. mm	PK	Cat. No.
Erlenmeyer pattern	500	110	1	9.305 340
Erlenmeyer pattern	1000	140	1	9.305 341
Erlenmeyer pattern	2000	170	1	9.305 342
bottle-shaped	5000	185	1	9.305 343
bottle-shaped	10000	240	1	9.305 344
bottle-shaped	15000	255	1	9.305 345
bottle-shaped	20000	290	1	9.305 346



1



1 LLG-Vacuum measuring instrument DVR 2 pro

Versatile vacuum gauge for vacuum measurement between atmospheric pressure and 1 mbar. With integral, alumina ceramic, pressure transducer providing excellent corrosion resistance and long-term stability.

- Mains independent due to battery operation
- Large display
- High measuring accuracy
- Optimal menu navigation
- With support rod
- All parts in contact with media are made of chemically resistant materials

DKD initial delivery calibration (Cat. No. 7.059 540) please order separately.

Scope of supply: Vacuum measuring instrument with connections for small flange D16, compression fitting and tubing nozzle for tubing with 6 to 10 mm ID.

Specifications

Measuring range: 1080 to 1 mbar (hPa), 810 to 1 Torr
 Measurement principle: Capacitive; gas type-independent absolute pressure measurement
 Measuring accuracy: < 1 mbar (0.75 Torr) ±1 digit
 Power supply/battery: 9 V battery
 Dimensions (W x D x H): 115 x 115 x 66 mm
 Weight: 0.40 kg

Type	PK	Cat. No.
DVR 2 pro	1	6.263 582

2



6.268 865

Vacuum measuring instrument VACUU-VIEW

VACUUBRAND

The rough vacuum gauge VACUU-VIEW covers the measuring range from atmospheric pressure down to 0.1 mbar very precisely. The combined rough and fine vacuum gauge VACUU-VIEW extended works in the enhanced range from atmosphere down to 10⁻³ mbar. The illuminated displays of both vacuum gauges enable comfortable reading.

- Compact design with integrated sensors one piece equipment for direct connect at point of interest
- Chemically resistant, heavy duty vacuum sensors highly reliable at harsh laboratory conditions even in case of very aggressive chemicals
- High repeatability and long-term accuracy under all typical conditions reliable and repeatable results
- Display with menu driven handling, easy to use e.g. for unit settings
- Compatible to gauge DCP 3000 and controller CVC 3000 or VACUU-SELECT
- The product is delivered ready for use

VACUU-VIEW

Chemically resistant ceramic diaphragm sensor for measurement in the rough vacuum range. VACUU-VIEW provides gas-independent pressure indication with precise capacitive readout. Highest precision and chemical resistance in the range from atmosphere down to 0.1 mbar, a perfect gauge for all rough vacuum applications.

VACUU-VIEW extended

The heavy duty combination of ceramic diaphragm sensor and ceramic jacketed Pirani sensor ensures reliable readings in the wide range from atmosphere down to 10⁻³ mbar. Precision and chemical resistance in an exceptionally wide range, one gauge covers all applications in the fine and rough vacuum range

3



6.268 864

Specifications

Measuring range VACUU-VIEW 1100 to 0.1 mbar(hPa)/825 to 0.075 torr
 Measuring range VACUU-VIEW extended: 1100 to 0.001 mbar(hPa)/825 to 0.001 torr
 Accuracy VACUU-VIEW: ±1 mbar(hPa)
 Accuracy VACUU-VIEW extended: ±15 % of indicated value in the range from 0.01-5 mbar(hPa)
 ±3 mbar for > 5 mbar(hPa)
 Vacuum connection: KF DN 16/hose nozzle DN 6/10 mm
 Dimensions (L x W x H): 103 x 62 x 50 mm
 Weight: 190 g
 Power supply: 100-230 V, 50/60 Hz (CEE/CH/UK/US/AUS/CN)

Type	Plug type	PK	Cat. No.
VACUU-VIEW	EU, UK, CH	1	6.268 865 2
VACUU-VIEW extended	EU, UK, CH	1	6.268 864 3

Vacuum Controller VACUU-SELECT®

VACUUBRAND

Fully equipped vacuum controller with capacitive, gas type-independent absolute pressure measurement using an alumina-ceramic diaphragm. While the base unit Vacuum Controller VACUU-SELECT® still requires a separate vacuum control valve as an accessory, there is the fully equipped Compact controller VACUU-SELECT® as two-point vacuum regulator with chemical suction line valve. With connected vacuum valve the VACUU-SELECT® automatically detects the boiling point during solvent evaporation and switches to two-point control mode. The graphical user interface offers predefined vacuum processes for all common laboratory applications. Applications, such as desired vacuum and other parameters can also be put together and controlled individually.

- Interactive, graphic touch display for easy operation
- Touchscreen display can be operated with safety gloves
- Predefined vacuum processes for reproducible results and time savings in the laboratory
- Fully automatic evaporations at the touch of a button
- Easy-to-use application editor for creating your own processes
- Integrated help function
- Integrated ventilation valve also for inert gas
- Ethernet/USB (Type A) interface
- EX approval: II 3/- G IIC T4 X Internal Atm. Only

Specifications

Measuring range:	0.1 ... 1080 mbar
Accuracy:	<±1 mbar/±1 digit (after adjustment, constant temp.)
Housing:	Plastic, good chemical resistance
Connection venting valve:	Hose nozzle DN 4-5 mm
Vacuum connection (Compact controllers only):	Hose nozzle DN 6/10 mm
Ambient temperature range:	10 ... 40 °C
Dimensions (W x D x H):	152 x 127 x 41 mm
Weight:	0.745 kg
Power supply:	100 ... 230 V, 50/60 Hz
IP code/IP code front side:	IP 40/IP 42

Compact Vacuum Controller VACUU-SELECT®

VACUUBRAND

Fully equipped two-point vacuum controller with capacitive, gas type-independent absolute pressure measurement using an alumina-ceramic diaphragm. Available as benchtop or stand version and ready to use due to standard laboratory connections.

Scope of delivery: Vacuum controller VACUU-SELECT® with chemistry suction line valve, check valve, integrated ceramic vacuum sensor, venting valve and power supply.



6.662 221



6.274 041

Type	Description	Dimensions (W x D x H) mm	PK	Cat. No.
Compact controller VACUU-SELECT®	Benchtop version	191 x 127 x 187	1	4.662 221 1
Compact controller VACUU-SELECT®	Stand version	152 x 127 x 189	1	6.274 041 2

Accessories for Vacuum Controller VACUU-SELECT

VACUUBRAND

Description	PK	Cat. No.
Solenoid inline valve VV-B 6C	1	9.882 851
Cooling water valve VKW-B	1	9.882 852
Air admittance valve VBM-B	1	9.882 849
Extension cable for VACUU-BUS®, 2m	1	9.882 853
Y-adapter for VACUU-BUS®	1	6.284 162
Exhaust filter FO for R8 / 9 / 16, outlet DN 25 KF	1	6.206 298

1

1 Vacuum measuring instrument DCP 3000 with Pirani sensor VSP 3000

VACUUBRAND

The Pirani-type vacuum sensor VSP 3000 offers an outstanding corrosion resistance and mechanical robustness for fine vacuum measurements. It is primarily designed for applications in chemistry and process engineering.

The vacuum gauge DCP 3000 is now also available with this new Pirani sensor VSP 3000 for an increased measuring range down to the 10^{-3} mbar range. Up to eight external gauge heads (four of ceramic diaphragm-type VSK 3000 and four VSP 3000) can be connected simultaneously to the DCP 3000 vacuum gauge for easy measurements at multiple points. Communication between the DCP 3000 and the external components is provided by the especially developed bus control system VACUU-BUS®. It is self-configuring, easy to use due to standardized plug connectors and allows cable extensions up to 30 m. The large illuminated display, controlled by a simple jog wheel, displays the readings from each gauge head.

Performance features

- brand new rugged vacuum sensor VSP 3000 made of plastics and ceramics with high chemical resistance
- wide measurement range from atmospheric pressure to fine vacuum (10^{-3} mbar) due to Pirani measurement system (thermal conductivity)
- upto 8 gauge heads VSP 3000 (Atm. to 10^{-3} mbar), VSK 3000 (Atm. to 0.1 mbar) can be connected (4 of each)
- rugged, splash-water proof vacuum sensor, also for rough operating conditions
- with vacuum controller VVC 3000, VSP 3000 and vacuum solenoid valves of type VV-B vacuum control from atm. to 10^{-3} mbar is achieved

Specifications:

Upper measuring limit mbar/hPa/torr:	$1 \times 10^3/7.5 \times 10^2$
Lower measuring limit mbar/hPa/torr:	$1 \times 10^{-3}/1 \times 10^{-3}$
Measurement principle	Thermal conductivity acc. to Pirani
Measurement uncertainty	$\pm 15\%$ of indicated value in the range 0.01-10 mbar/hPa/torr
Vacuum connection	Small flange KF DN 16 and hose nozzle DN 6/10 mm
Control connections:	1 socket for supply/Vario pump 2 expandable sockets for external sensors/valves
Rated mains voltage	100-230 V 50/60 Hz /CEE/CH/UK/US/AUS
Dimensions (desktop unit, L x W x H):	144 x 124 x 114 mm
Weight (without mains adapter):	0.44 kg

Description	PK	Cat. No.
Vacuum gauge Set DCP 3000 + VSP 3000	1	9.882 207

2

2 Vacuum Control Unit VC 900

KNF

- Application: Rotary evaporation, Distillation, Multi-user vacuum system
- Easy to use to control the vacuum application
- Separate control unit with pressure sensors and two-step controlled valve to be placed independently from the operating unit
- Vacuum controller can be operated with components from KNF and other producers

Specifications

Housing material:	Plastic
Power supply:	Power cord, cable length 150 cm
Protection class:	IP30
Mains voltage:	100-240 V
Frequency:	50/60 Hz
Operating current:	max. 1.0 A
Accuracy of measurement:	± 1 mbar
Measuring limit:	upper: 1100 mbar abs. lower: 0 mbar abs.

Specifications of the Control Unit

Hose connections:	for gas in ID 10 mm, PVDF/for gas out ID 10 mm, PVDF or venting ID 4 mm, nickel-plated brass
Dimensions (W x H x D):	155 x 109 x 60 mm
Permissible media and ambient temperature:	10 to 40 °C
Weight:	1.2 kg

Type	Width mm	Length mm	Height mm	PK	Cat. No.
VC 900	101	67	181	1	6.281 572

Please order the appropriate control cable for operating the N 920 G pump separately.



9. Vacuum technology, Drying, Dry storage Desiccators/Desiccators - glass

1 Desiccators, borosilicate glass 3.3, with plastic knob and porcelain plate

Desiccator made of borosilicate glass 3.3, clear glass, with plastic lid, without vacuum connector.

Ext. diam.	Plate diam.	DN	PK	Cat. No.
mm	mm			
151	90	100	1	9.042 810
210	140	150	1	9.042 811
269	190	200	1	6.230 515
329	240	250	1	9.042 812
392	290	300	1	6.225 773



2 Desiccators, DURAN®, knob lid

DURAN®. Clear glass, without vacuum, with knob lid. DIN 13130.

DWK Life Sciences

Height mm	DN	PK	Cat. No.
187	100	1	9.042 019
252	150	1	9.042 031
309	200	1	9.042 038
357	250	1	9.042 043
433	300	1	9.042 047



3 LLG-Desiccators, soda-lime glass, with lid, stopcock and porcelain plate

Desiccator made of soda-lime glass with lid, porcelain plate and stopcock.

The stopcock has an outer diameter of about 9 mm. Not suitable for vacuum-tight applications.

Ext. diam.	Plate diam.	Height	PK	Cat. No.
mm	mm	mm		
215	140	224	1	9.042 740
262	190	239	1	9.042 741
293	235	278	1	9.042 742
380	280	414	1	9.042 743

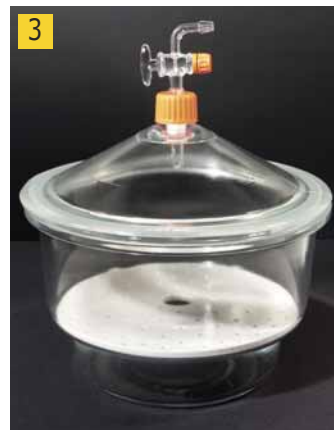

4 Vacuum-Desiccators with tubes, borosilicate glass 3.3, stopcock SJ 24/29 and porcelain plate

Desiccators borosilicate glass 3.3, vacuum-tight. The stopcock has an outer diameter of approx. 9 mm.

Ext. diam.	Plate diam.	DN	PK	Cat. No.
mm	mm			
151	90	100	1	9.042 815
210	140	150	1	6.226 934
269	190	200	1	6.226 935
329	240	250	1	6.226 936
392	290	300	1	6.227 443





1 Desiccators, DURAN®, vacuum, with stopcock

DURAN®. Clear glass. With Novus stopcock assembly in lid. Vacuum-tight. DIN 13130.

DWK Life Sciences

Height	Tube socket	DN	PK	Cat. No.
mm	NS			
174	24/29	100	1	9.042 119
239	24/29	150	1	9.042 131
296	24/29	200	1	9.042 138
344	24/29	250	1	9.042 143
420	24/29	300	1	9.042 147



9.042 232

2 Vacuum-Desiccators, DURAN®, complete

DURAN® vacuum desiccator "ready to use".

DWK Life Sciences

Type NOVUS

DURAN® Vacuum desiccator with plane flange and porcelain plate, with NOVUS standard ground joint (NS 24/29), junction tube in the lid and stopcock.

Type MOBILEX

DURAN® Vacuum Desiccator with flat flange, no outlet, DURAN® desiccator lid with threaded outlet type Mobilex GL 32, porcelain desiccator plate, silicone sealing ring with bonded PTFE face, DURAN® stopcock with PTFE spindle, PBT screw cap with pierced aperture GL 32.

Type	Height mm	Tube socket	DN	PK	Cat. No.
NOVUS	239	NS 24/29	150	1	9.042 132
NOVUS	296	NS 24/29	200	1	9.042 139
NOVUS	344	NS 24/29	250	1	9.042 144
NOVUS	420	NS 24/29	300	1	9.042 148
MOBILEX	239	GL 32	150	1	9.042 232 2
MOBILEX	296	GL 32	200	1	9.042 239
MOBILEX	344	GL 32	250	1	9.042 244
MOBILEX	420	GL 32	300	1	9.042 248



3 Desiccator lids with knob, DURAN®

DURAN®. Clear glass. Knob lid. Fits all desiccator bases with the corresponding flat flange. Vacuum-tight. DIN 13130.

DWK Life Sciences

ID diam. Flange mm	OD diam. Flange mm	Height mm	DN	PK	Cat. No.
119	153 ± 2	75	100	1	9.042 319
172	215 ± 2	98	150	1	9.042 331
224	270 ± 2	107	200	1	9.042 338
274	320 ± 2	122	250	1	9.042 343
332	380 ± 2	150	300	1	9.042 347



4 Desiccator lids, NOVUS type, DURAN®

DURAN®. Clear glass. Tube top, for NOVUS stopcock assembly. Without stopcock. Vacuum-tight. DIN 13130.

DWK Life Sciences

ID diam. Flange mm	OD diam. Flange mm	Height mm	NS	DN	PK	Cat. No.
119	153 ± 2	62	24 / 29	100	1	9.042 419
172	215 ± 2	85	24 / 29	150	1	9.042 431
224	270 ± 2	94	24 / 29	200	1	9.042 438
274	320 ± 2	109	24 / 29	250	1	9.042 443
332	380 ± 2	137	24 / 29	300	1	9.042 447

1 LLG-Plate for desiccator, porcelain

Perforated. Without feet. To DIN 12911. 20 mm diameter central hole and 5mm diameter outer holes.

Diam. mm	For DN	PK	Cat. No.
90	100	1	9.042 801
140	150	1	9.042 802
190	200	1	9.042 803
235	250	1	9.042 804
280	300	1	9.042 805



Desiccator stopcocks, borosilicate glass 3.3

With PTFE spindle. For NOVUS-type desiccators. Cone: NS 24/29, bore: NW 2.5 mm, hose connection: outer dia. 8 mm.

Lenz

Description	Length mm	NS	PK	Cat. No.
for side tubulation	108	24/29	1	9.042 500 2
for lid tubulation	124	24/29	1	9.042 505 3



9.042 500

9.042 505

Stopcocks for desiccators, DURAN®

DURAN® stopcocks with PTFE spindle. Outer diameter: 8 mm

DWK Life Sciences

For Type	For Tube socket	Description	Length mm	PK	Cat. No.
NOVUS	NS 24/29	lateral connection	85	1	6.901 259 4
NOVUS	NS 24/29	lid connection	85	1	7.200 573
MOBILEX	GL 32	thread connection	160	1	9.042 507 5



6.901 259

9.042 507

6 Desiccators, vacuum, O- ring seals

Soft rubber. These O-ring seals make glass lubrication unnecessary. Suitable for desiccators, Witt jars etc.

For DN mm	PK	Cat. No.
100	1	9.042 710
150	1	9.042 715
200	1	9.042 720
250	1	9.042 725
300	1	9.042 730



7 Glass drying pistol

Ideally suited for drying of small sample volumes. This sample dryer, for analysing substances and synthetic products, uses heat, desiccant and vacuum at the same time for optimum results. Its temperature range can be adjusted between +30 °C to +160 °C, with a temperature stability of ±1 °C.

LABC-Labortechnik

The two-part drying vessel is approximately two parts of DURAN® glass:
 1) Drying tube with an outer diameter of 44 mm, length inside 200 mm, joint NS45.
 2) Ground flask with stopcock for connection to a vacuum pump.
 The glass drying oven needs to be fixed with screw stand rod at the laboratory stand to be secured.
 Dimensions (without mounting for tripod and Flask): H 120 mm x B 195 mm x T 185 mm. Weight: 2 kg

Supplied with: Glass drying oven consisting of heating element with support rod and glassware with ground drying tube and ground flask with stopcock.

Type	PK	Cat. No.
Glass drying oven	1	6.269 737
Glassware for Glass drying oven	1	6.269 738



Desiccators/Desiccators - plastic

1



1 LLG-Vacuum desiccators, polycarbonate, round form, "Heavy Duty"

Cost effective alternative to glass desiccators. Highly transparent, lightweight, shatterproof, made of polycarbonate. Silicon O-ring and specially designed 'locking clip' allows use without grease and ensures an airtight seal. Flange lock holds the bottom and the lid together during non-vacuum conditions. Three-way stopcock provides great convenience for consistent vacuum draw, vacuum release or gas exchange e.g. inert gas. Maximum vacuum of 1.3 mbar (1.3×10^{-4} MPa) for more than 72 hours. Wide base provides superior stability. Hose connection outer diam. 9.5 mm.

Also available in brown with UV-blocking effect for light sensitive samples.

G Models will be delivered with a vacuum gauge.

Included in delivery: Drying agent tray, perforated sample tray, O-ring and flange locker.

Type	Capacity l	Ext. diam. mm	Height mm	PK	Cat. No.
VDR-20 Vacuum Desiccator	6	242	279	1	9.042 751
VDR-20G Vacuum Desiccator with gauge	6	242	354	1	9.042 753
VDR-25 Vacuum Desiccator	10	308	325	1	9.042 755
VDR-25G Vacuum Desiccator with gauge	10	308	400	1	9.042 757
VDR-30 Vacuum Desiccator	20	385	399	1	9.042 759
VDR-30G Vacuum Desiccator with gauge	20	385	475	1	9.042 761

2



2 Desiccators, plastic, vacuum, PC/PP

Crystal clear, PC dome lid. PP. Lower section and desiccant tray. Venting stopper with non-return valve in lid. Polychlorbutadiene rubber (CK) O-ring seal between lid and base which is compressed when vacuum is applied. Lightweight and easy to use.

Kartell

Diam. mm	Nominal diam. mm	Height mm	PK	Cat. No.
170	150	195	1	9.042 615
235	200	240	1	9.042 620
285	250	300	1	9.042 625

3



3 Portable Desiccator DURAPorter™, PC

Heathrow Scientific



Ideal for transporting biological and clinical samples, as well as instruments and products that you want to keep clean and dry under testing environmental conditions.

Are light weight and easy to carry; they are ideal for moving samples that must be protected from humidity, dust and other environmental influence. The clarity of the DURAPorter™ enables the user to visibly check sample integrity, so that it can be opened using the right precautions.

- Polycarbonate construction are available in three colours for use/owner identification
- Silicone water-tight seal and three lid clasps provide secure closure
- Carry handle folds neatly into body space allowing the units to be stacked
- Lid opens a full 180°, allowing total access to contents and making it easier to clean
- Will accommodate 13 and 16 mm tubes in a 72-place one rack®, or similar sized/brand of rack
- Use the separators provided to create your own compartment sizes, or use empty to transport larger products and equipment
- Autoclavable

Matching rack (e.g. Cat. No. 9193 997, 9193 998) please order separately.

Further colours available on request.

Type	Colour	Dimensions (l x w x h) mm	Material	PK	Cat. No.
DURAPorter™	Clear with blue handles	380 x 196 x 160	PC	1	9.194 005
DURAPorter™	Yellow with yellow handles	380 x 196 x 160	PC	1	9.194 006
DURAPorter™	Red with red handles	380 x 196 x 160	PC	1	9.194 007

9. Vacuum technology, Drying, Dry storage Desiccators/Desiccators - plastic-Desiccator cabinets

1 Desiccator Nalgene™, Type 5311, PC

Transparent, lightweight, unbreakable, for vacuum or non-vacuum use. With stopcock. *Thermo Scientific*
 Large, stable base. No danger of implosion. Capable of maintaining 0.95 bar negative pressure over a 24 hour period. With silicone O-ring, no lubrication required.
 Suitable for 230 mm diameter desiccator discs or plates. Max. height over plate 195 mm. Plate not included.
 External diameter: 280 mm
 Internal diameter: 251 mm

Type	PK	Cat. No.
5311	1	9.042 690



2 LLG-Vacuum desiccator cabinets, polycarbonate, square form, "Heavy Duty"

High-quality and stable construction made of polycarbonate. Highly transparent, lightweight, shatterproof and stackable. The Silicon O-ring and specially designed locking clip allow use without grease. Three-way stopcock provides great convenience for consistent vacuum draw, vacuum release or gas exchange e.g. inert gas. Stopcock outer diameter: 9.5 mm. Hose connection outer diam. 9.5 mm. Maximum vacuum of 1.3 mbar (1.33 x 10⁻⁴ MPa) for more than 72 hours, with built-in vacuum gauge. Also available in brown with UV-blocking effect for light sensitive samples.

Included in delivery: Vacuum gauge, O-ring, drying agent tray, 2 x perforated sample trays (VDC-11 and VDC-21) or 3 x perforated sample trays (VDC-31 and VDC-41).

Type	Capacity	External dimensions (W x D x H) mm	Internal dimensions (W x D x H) mm	Max. grids	PK	Cat. No.
VDC-11	11	322 x 285 x 271	248 x 254 x 238	4	1	9.042 769
VDC-21	23	420 x 392 x 281	346 x 365 x 246	4	1	9.042 767
VDC-31	35	420 x 397 x 381	355 x 375 x 345	5	1	9.042 765
VDC-41	45	420 x 397 x 491	355 x 374 x 445	6	1	9.042 763



3 LLG-Desiccant drying agents, silica gel, self-indicating

With orange indicator colour. Grain size 1 to 3 mm or 2 to 5 mm. Self-indicating drying agent free from any heavy metals and therefore environmentally compatible. The gel is naturally orange when active and at a 6 weight-% saturation level. As the gel adsorbs moisture, the colour changes into green. The range of application is identical with that of white silica gel. The colour change, however, represents a great advantage since it allows monitoring of the saturation level. The gel can be regenerated when heated at a temperature of maximum 120 °C until it turns to its original orange colour.

Adsorption capacity RH 20 % 12 weight %
 (RH : residual moisture) RH 35 % 20 weight %
 RH 50 % 27 weight %
 RH 90 % 40 weight %

Granulation	Package contents	PK	Cat. No.
1 to 3 mm	Tin, 1 kg	1	9.042 584
1 to 3 mm	Bucket, 3 kg	1	9.042 585
1 to 3 mm	Bucket, 8 kg	1	9.042 586
1 to 3 mm	Carton box, 25 kg	1	9.042 587
2 to 5 mm	Tin, 1 kg	1	9.042 581
2 to 5 mm	Bucket, 3 kg	1	9.042 582
2 to 5 mm	Bucket, 8 kg	1	9.042 583



1



1 Desiccators Auto Dry Box

Automatic drying and storage without desiccant. Ideal for the long-term storage of e.g. Reference samples, electronic components or optical instruments under defined moisture conditions. Relative humidity adjustable in 3 steps between 30 % and 55 % relative humidity, very quiet operation. Includes 1 to 3 shelves, lockable glass door and analogue hygrometer.

Specifications

Max. load shelves: 10 kg
Power: 220-240 V

Type	Internal dimensions (W x D x H) mm	External dimensions (W x D x H) mm	Volume litres	Max. grids	Power consumption W	PK	Cat. No.
AD-45PG	300 x 275 x 295	340 x 320 x 390	32	1	3	1	4.672 809
AD-51PG	360 x 357 x 345	400 x 415 x 440	55	1	3	1	4.672 810
AD-72PG	360 x 357 x 460	400 x 415 x 555	72	2	3	1	4.672 811
AD-106	360 x 357 x 740	400 x 412 x 835	114	3	6	1	6.286 119

2



2 3 Filament Dry Cabinet for 3D-Printing

The Dry Cabinet provides low humidity environment and is suitable for storing various types of filament material. 4 filament feed ports supporting up to 3 mm filaments allows direct printing of dry filament from the cabinet while in humidity controlled storage. Adjustable hanging rod will allow hanging of dry filament spools up to 330 mm in diameter. Air tight cabinet will prevent moisture and dust from contaminating your printed project. Low energy consumption. Convenient design with no consumable parts nor desiccants to replace, no water tanks to empty. Powerful molecular sieve desiccants keeps filament dry without heat to maintain tensile strength.

Taiwan Dry Tech Corp.

- <20 % RH Low Humidity Storage
- 4 filament feed ports for direct printing
- Dries without heat: Maintains tensile strength
- Standalone Hygrometer for Active Monitoring
- Fast 2 Hour Recovery
- Fully adjustable spool hanger

Specifications

Humidity: <20 % RH
Capacity: 79 l
Energy consumption: 12 W Avg/100 W Max.
Overall Dimensions (W x D x H): 400 x 405 x 555 mm
Internal Dimensions (W x D x H): 320 x 325 x 460 mm

Type	PK	Cat. No.
Filament Dry Cabinet	1	6.289 099

3



Desiccators Mini Basic/Premium, polycarbonate

Three versions (one, two or three permanently fixed compartments).

SICCO

Specifications

Panels: clear
Temperature resistance: from -35 °C to +70 °C

Type	Volume litres	External dimensions (W x D x H) mm	Internal dimensions (W x D x H) mm	Weight kg	PK	Cat. No.
Mini 1 Basic	6.2	221 x 214 x 183	212 x 180 x 162	0.9	1	9.042 646
Mini 2 Basic	2 x 6.2	221 x 214 x 362	212 x 180 x 162	1.8	1	9.042 647 4
Mini 3 Basic	3 x 6.2	221 x 214 x 540	212 x 180 x 162	2.7	1	9.042 648
Mini 1 Premium	6.2	221 x 214 x 183	212 x 180 x 162	0.9	1	9.042 652
Mini 2 Premium	2 x 6.2	221 x 214 x 362	212 x 180 x 162	1.8	1	9.042 653
Mini 3 Premium	3 x 6.2	221 x 214 x 540	212 x 180 x 162	2.7	1	9.042 654

Premium Versions incl. 2 shelves, hygrometer. Bottom with non-slip rubber feet.

4



9.042 647

5



9.042 657

Desiccators Mini Mobil, polycarbonate

With practical handle, one compartment.

SICCO

Specifications

Panels: clear
Temperature resistance: from -35 °C to +70 °C
Use: normal pressure

Type	Volume litres	External dimensions (W x D x H) mm	Internal dimensions (W x D x H) mm	Weight kg	PK	Cat. No.
Mini Mobil Basic	6.2	221 x 214 x 183	212 x 180 x 162	1.0	1	7.638 923
Mini Mobil Premium	6.2	221 x 214 x 183	212 x 180 x 162	1.0	1	9.042 657 5

Premium version incl. 2 shelves, hygrometer. Bottom with non-slip rubber feet.

Desiccators Mini for Gas Filling, polycarbonate

Two gas filling couplings with self-closing valves and hoses.

SICCO

Specifications

Panels: clear
 Temperature resistance: from -35 °C to +70 °C
 Use: normal pressure

Type	Volume	External dimensions (W x D x H)	Internal dimensions (W x D x H)	Weight	PK	Cat. No.
	litres	mm	mm			
Mini Inertgas Basic	6.2	221 x 214 x 183	212 x 180 x 162	0.9	1	7.629 763
Mini Inertgas Premium	6.2	221 x 214 x 183	212 x 180 x 162	0.9	1	9.042 658 1

Premium version incl. 2 shelves, hygrometer. Bottom with non-slip rubber feet.



9.042 658

2 Desiccator Star, PMMA

Includes four transparent acrylic shelves, tray, hygrometer and desiccant, with positions for up to 26 shelves and stackable.

SICCO

Specifications

Panels: clear
 Material: PMMA
 Temperature resistance: -20 °C to +70 °C
 Maximum all-over load per shelf: 10 kg
 Total all-over load: 30 kg

Type	Volume	External dimensions (W x D x H)	Internal dimensions (W x D x H)	Weight	PK	Cat. No.
	litres	mm	mm	kg		
Star	42	310 x 375 x 525	260 x 330 x 480	7	1	9.042 651



3 Desiccators Star-Super, PMMA

Gas filling Desiccators provide ideal conditions for the safe and secure storing of poisonous chemicals. An inert gas such as nitrogen can be introduced as soon as the door is closed tightly. Unlike the ambient air, the inert gas does not react with the stored substances. Includes four transparent acrylic shelves, positions for up to 26 shelves, hygrometer, tray, desiccant and tubing with quick coupling for gas filling and door lock.

SICCO

Specifications

Panels: clear
 Material: PMMA
 Temperature resistance: from -20 °C to +70 °C
 Maximum all-over load per shelf: 10 kg
 Total all-over load: 30 kg

Type	Volume	External dimensions (W x D x H)	Internal dimensions (W x D x H)	Weight	PK	Cat. No.
	litres	mm	mm	kg		
Star-Super	51	310 x 375 x 525*	260 x 330 x 480	7	1	6.800 667

* Additional space requirement for coupling, 150 mm per side.



4 Desiccator Star-Protect, PMMA

Including four shelves made of acrylic glass, tray, hygrometer and desiccant, usable with up to 26 shelves, stackable, orange acrylic panels reduce light incidence and protect against ultraviolet radiation.

SICCO

Specifications

Panels: orange
 Material: PMMA
 Temperature resistance: from -20 °C to +70 °C
 Maximum all-over load per shelf: 10 kg
 Total all-over load: 30 kg

Type	Volume	External dimensions (W x D x H)	Internal dimensions (W x D x H)	Weight	PK	Cat. No.
	litres	mm	mm	kg		
Star-Protect	51	310 x 375 x 525	260 x 330 x 480	7	1	6.901 030





1 Desiccator Star-Horizontal, PMMA

The desiccator can be equipped with up to 13 shelves.
Raster and rails made metal-free PA/fiberglass. Rails with level numbering.

SICCO

Specifications

Panels:	clear
Material:	PMMA
Temperature resistance:	-20 °C to +70 °C
Maximum all-over load per shelf:	1.5 kg
Total all-over load:	30 kg

Type	Volume litres	External dimensions (W x D x H) mm	Internal dimensions (W x D x H) mm	Weight kg	PK	Cat. No.
Star-Horizontal	51	525 x 375 x 340	480 x 330 x 260	7	1	6.800 632



2 Desiccator Star-Auto, PMMA

With maintenance-free automatic drying that can maintain a constant humidity of between 20 % and 30 %, Automatic Desiccators are highly suitable for long-term storage. Even frequent opening of the door is compensated for automatically. The ideal solution for storing reference materials, electronics, photo equipment, papers, historical artefacts and much more. With four transparent acrylic shelves and hygrometer with positions for up to 26 shelves and stackable. Requires a 230 V, 50 Hz power supply.

SICCO

Specifications

Panels:	clear
Material:	PMMA
Temperature resistance:	-20 °C ... 70 °C
Maximum all-over load per shelf:	10 kg
Total all-over load:	30 kg

Type	Volume litres	External dimensions (W x D x H) mm	Internal dimensions (W x D x H) mm	Weight kg	PK	Cat. No.
Star-Auto	51	310 x 375 x 525	260 x 330 x 480	7.3	1	6.201 892



3 Desiccator Star-Big, PMMA

Inclusive two removable and adjustable shelves made of stainless steel.
The desiccator can be equipped with up to 8 shelves.

SICCO

Specifications

Panels:	clear
Material:	PMMA
Temperature resistance:	-20 °C to +70 °C
Maximum all-over load per shelf:	30 kg
Total all-over load:	80 kg

Type	Capacity l	External dimensions (W x D x H) mm	Internal dimensions (W x D x H) mm	Weight kg	PK	Cat. No.
Big Star	156	560 x 580 x 560	445 x 540 x 500	18	1	6.300 334



4 Desiccator Star-Vitrium, borosilicate glass 3.3

Panels made of borosilicate glass 3.3, including four shelves made of stainless steel, tray, hygrometer and desiccant, usable with up to 26 shelves, stackable.

SICCO

Specifications

Panels:	clear
Material:	Borosilicate glass 3.3/stainless steel
Temperature resistance:	-70 °C to +150 °C
Maximum all-over load per shelf:	10 kg
Total all-over load:	30 kg

Type	Volume litres	External dimensions (W x D x H) mm	Internal dimensions (W x D x H) mm	Weight kg	PK	Cat. No.
Star-Vitrium	51	310 x 375 x 525	260 x 330 x 480	14	1	9.042 006

1 Desiccator Star-Vitrium-Big, borosilicate glass 3.3

Aluminium frame with panels made of borosilicate glass 3.3, including two shelves made of stainless steel, tray and hygrometer, usable with up to 17 shelves. SICCO

Specifications

Panels:	clear
Material:	Borosilicate glass 3.3/stainless steel
Temperature resistance:	-70 °C to +150 °C
Maximum all-over load per shelf:	30 kg
Total all-over load:	80 kg

Type	Volume litres	External dimensions (W x D x H) mm	Internal dimensions (W x D x H) mm	Weight kg	PK	Cat. No.
Star-Vitrium-Big	156	560 x 580 x 560	495 x 540 x 500	22	1	9.042 661

Desiccator Star-Antistatik/Star-Antistatik-Big, PC

Aluminium frame with static dissipative panels made of polycarbonate, including 4 stainless steel shelves (2 stainless steel shelves for Star-Antistatik-Big), tray and hygrometer, usable with up to 26 shelves (17 shelves for Star-Antistatik-Big). SICCO
All materials used can discharge electrostatic charging by means of a grounding cable which can be connected on the back side (connecting thread M6).

Specifications

Panels:	clear
Material:	dissipative polycarbonate
Temperature resistance:	-20 °C to +70 °C
Maximum all-over load per shelf	
Star-Antistatik/Star-Antistatik-Big:	10 kg /30 kg
Total all-over load	
Star-Antistatik/Star-Antistatik-Big:	30 kg/80 kg

Type	Capacity l	External dimensions (W x D x H) mm	Internal dimensions (W x D x H) mm	Weight kg	PK	Cat. No.
Star-Antistatik	51	310 x 375 x 525	260 x 330 x 480	7	1	6.204 393
Star-Antistatik-Big	156	560 x 580 x 560	495 x 540 x 500	18	1	9.042 664 2



9.042 664



1 Desiccators Maxi

SICCO Desiccators are designed for storing or drying humidity sensitive products using silica gel. The tight fitting door protects the contents from contamination from the atmosphere. The controlled environment inside the desiccators are ideal for storing reference materials, retained samples, metallographic specimen, tobacco and DNA-samples.

- Reinforced aluminium frame with acrylic panels
- Door with magnetic catch and circular rubber seal
- Four casters (two of the casters with brakes)
- Easy to read electronic hygrometer
- Variable height shelves made of stainless steel
- Telescopic shelves
- Desiccant tray



Desiccators Maxi 1 and Maxi 2, PMMA

Maxi 1: Including four shelves made of stainless steel, tray and hygrometer, usable with up to 17 shelves.

SICCO

Maxi 2: Two chambers, two doors, each chamber usable with up to 8 shelves. Including two shelves per chamber, two trays and two hygrometers.

Specifications

Panels:	clear
Material:	PMMA, stainless steel
Temperature resistance:	-20 °C to +70 °C
Maximum all-over load per shelf:	30/80 kg
Total all-over load:	160 kg

Maxi 1/Maxi 2

Type	Volume litres	External dimensions (W x D x H) mm	Internal dimensions (W x D x H) mm	Weight kg	PK	Cat. No.
Maxi 1	311	560 x 580 x 1150	495 x 540 x 1030	30	1	9.042 643 2
Maxi 2	156*	560 x 580 x 1150	495 x 540 x 500*	34	1	9.042 644

* per chamber

9.042 643



Desiccators Maxi 1-Vitrum and Maxi 2-Vitrum, borosilicate glass 3.3

Maxi 1-Vitrum: Aluminium frame with panels made of borosilicate glass 3.3, including four shelves made of stainless steel, tray and hygrometer, four castors, usable with up to 34 shelves.

SICCO

Maxi 2-Vitrum: Aluminium frame with panels made of borosilicate glass 3.3, two compartments and two doors, including four shelves made of stainless steel, two trays and two hygrometers, four castors, usable with up to 17 shelves per compartment.

Specifications

Panels:	clear
Material:	Borosilicate glass 3.3/stainless steel
Temperature resistance:	-70 °C to +150 °C
Maximum all-over load per shelf:	30 kg
Total all-over load	
Maxi 1-Vitrum:	160 kg
Maxi 2-Vitrum:	80 kg per chamber

Type	Volume litres	External dimensions (W x D x H) mm	Internal dimensions (W x D x H) mm	Weight kg	PK	Cat. No.
Maxi 1-Vitrum	311	560 x 580 x 1150	495 x 540 x 1030	37	1	9.042 662 3
Maxi 2-Vitrum	156*	560 x 580 x 1150	495 x 540 x 500*	42	1	6.253 315

* per chamber

9.042 662

Laboratory freeze dryer VaCo Series

Freeze dryer in modular design for routine applications in the laboratory. Cooling is done by air-cooled compressor with direct temperature measurement at the cooling surface. Apre-cooling of the condenser is possible to avoid a delayed start or thawing of the samples. Further functions are the display of the vacuum and temperature curves, an error message memory and an operating hours counter.

Zirbus Technology

- 3 program places with 3 drying stages each
- Operation via 4.3" colour touch screen
- Adjustable parameters for each drying stage: Hold-up time, vacuum setpoint, (shelf space temperature (with the option heated shelf spaces) for VaCo 5/VaCo 10)
- Displayed actual values during operation: Condenser temperature, vacuum (mbar), time
- Automatic defrosting of the ice condenser (VaCo 10)
- Variable shelf space (VaCo 10)
- Stainless steel housing resistant against commercial disinfectants
- CFC-free refrigerant

Operating language: English or German, other languages on request.

1 Laboratory freeze dryer VaCo 2



Required for operation: Basic unit VaCo 2, ice condenser (-50 °C or -80 °C) and optional accessories. Please order components separately.

Zirbus Technology

Specifications

Ice condenser

Temperature:	-50 °C or -80 °C
Ice condenser capacity:	2 kg/24 h
max. ice capacity:	3 kg
Volume:	5.7 l
Cooling system:	one-stage (-50 °C)/two-stage (-80 °C)
Material:	Stainless steel 1.4404/AISI316L
Dimensions (Ø x H):	220 x 150 mm

Basic unit

Weight:	45 or 58 kg (depending on the version ice condenser)
Dimensions (W x D x H):	490 x 470 x 440 mm
Power supply:	230 V, 50/60 Hz

Type	PK	Cat. No.
Basic unit VaCo 2	1	4.672 302
Ice condenser -50 °C	1	4.672 303
Ice condenser -80 °C	1	4.672 304

Accessories for Laboratory freeze dryer VaCo 2



Zirbus Technology

Description	PK	Cat. No.
Dry rack, stainless steel 6	1	4.672 305
Dry rack, stainless steel 8	1	4.672 306
Acrylic glass chamber, Ø 200 x 360 mm	1	4.672 307
Stainless steel chamber, Ø 200 x 360 mm	1	4.672 308
Lid for acrylic glass and stainless steel chamber	1	4.672 309
Lid for acrylic glass and stainless steel chamber with 8 vacuum connections (flask drying)	1	4.672 310
Insert rack with 1 shelf space	1	4.672 311
Additional shelf space for insert rack (max. 4 additional pieces)	1	4.672 312
Vacuum control VaCo 2 (magnetic valve to the vacuum pump)	1	4.672 313
Vacuum pump 2-stage, 1.8 m³/h, type E2M1.5	1	4.672 314
Closing system for vials "unheated" (all necessary components included)	1	4.672 315



1 Laboratory freeze dryer VaCo 5

NEW

Required for operation: Basic unit VaCo 5, ice condenser (-50 °C or -80 °C) and optional accessories.
Please order components separately.

Zirbus Technology

Specifications

Ice condenser

Temperature:	-50 °C or -80 °C
Ice condenser capacity:	5 kg/24 h
max. ice capacity:	8 kg
Volume:	16 l
Cooling system:	one-stage (-50 °C)/two-stage (-80 °C)
Material:	Stainless steel 1.4404/AISI316L
Dimensions (Ø x H):	270 x 280 mm

Basic unit

Weight:	60 or 75 kg (depending on the version ice condenser)
Dimensions (W x D x H):	800 x 530 x 400 mm
Power supply:	230 V, 50/60 Hz

Type	PK	Cat. No.
Basic unit VaCo 5	1	4.672 316
Ice condenser -50 °C	1	4.672 317
Ice condenser -80 °C	1	4.672 318

Accessories for Laboratory freeze dryer VaCo 5

NEW

Zirbus Technology

Description	PK	Cat. No.
Dry rack, stainless steel 12	1	4.672 319
Dry rack, stainless steel 8	1	4.672 320
Acrylic glass chamber, Ø 300 x 450 mm	1	4.672 321
Stainless steel chamber, Ø 300 x 450 mm	1	4.672 322
Lid for acrylic glass and stainless steel chamber	1	4.672 323
Lid for acrylic glass and stainless steel chamber with 8 vacuum connections (flask drying)	1	4.672 324
Insert rack with 1 shelf space, Ø 272 mm, unheated	1	4.672 325
Additional shelf space for insert rack, unheated (max. 5 additional pieces)	1	4.672 326
Insert rack with 1 shelf space, Ø 280 mm, heated	1	4.672 327
Additional shelf space for insert rack, heated (max. 4 additional pieces)	1	4.672 328
Vacuum control VaCo 5 (magnetic valve to the vacuum pump)	1	4.672 329
Vacuum pump 2-stage, 9.7 m ³ /h, type RV8	1	4.672 330
Closing system for vials "unheated" (all necessary components included)	1	4.672 331
Closing system for vials "heated" (all necessary components included)	1	4.672 332



Optical instruments	1094
Magnifiers	1094
Microscopy	1097
Light microscopes	1097
Stereomicroscopes.....	1103
Digital microscopes and cameras	1104
Microscopy accessories.....	1107
Cold light sources	1109
Counting chambers.....	1114
Slides	1116
Slide covers	1118
Slide storage.....	1119
Staining racks	1121
Refractometers	1125
Hand held refractometers	1125
Benchtop refractometers	1130
Photometers	1135
Polarimeters	1135
Spectrophotometers.....	1137
OD-Measurement	1143
Microplate reader and washer.....	1144
Colour measurement.....	1147
Special Photometers	1148
Glass cuvettes.....	1150
Plastic cuvettes	1157
Accessories cuvettes	1160



1 Round Magnifier

The large plastic lens is fitted with an integrated smaller additional lens. The frame and handle is black. Supplied in self-service carton box.

Werner Dorsch

Lens	Dimensions	Magnification	Colour	PK	Cat. No.
mm	mm				
Ø 48	127 x 59 x 11	2,5-fold/5-fold	black	1	6.273 732
Ø 63	152 x 70 x 12	2-fold/4-fold	black	1	6.273 733
Ø 74	187 x 86 x 17	2-fold/4-fold	black	1	6.273 734



2 Illuminated magnifying lens Lux-50

Orange body colour, with illuminator and plastic lens. Requires 2 x 1.5 V AA batteries for operation (included).

Lens	Magnification	PK	Cat. No.
mm			
Ø 50	2.5x - 5x	1	9.151 817



3 Handheld magnifier with illumination

- Hand held magnifier with magnification of 3X and 5X (depending of the view location)
- Ergonomic handle design
- Aspherical lens provides spherical aberration and distortion free images with edge-to-edge sharpness.
- LED bulb with on/off control.
- Adjustable angle of illumination.

ISOLAB

Description	PK	Cat. No.
3X / 5X magnification	1	6.267 407



9.151 680

Magnifying lens, economic

With practical additional lens in the handle. Particularly suitable for those who require a low level of magnification. An additional high-magnification lens enables small details to be read. Transparent plastic frame ensures easy orientation on the reading material. With eyelet in the end of the handle for round-the-neck cord which is supplied. The biconvex reading magnifiers offer a large visual field in a medium magnification range. Plano-convex additional lens with 5x magnification in handle.

Eschenbach



9.151 688

Lens	Magnification	PK	Cat. No.
mm			
Ø 100	2.0 x 4.1 dpt	1	6.244 118
Ø 65	3.0 x 7.7 dpt	1	9.151 680
Ø 80	2.3 x 5.4 dpt	1	9.151 682
80 x 40	2.4 x 5.7 dpt	1	9.151 688



6 Illuminated pocket magnifiers, mobilux® LED

The tried and tested illuminated hand-held magnifiers now feature a new design and improved functions.

Eschenbach

- Easy to use: large, easy to operate light switch
- 3 different filters are supplied
- The batteries are easy to change
- Incl. protective case for lens

Dimensions	Magnification	PK	Cat. No.
mm			
Ø 58	6x/24.0 dpt	1	7.970 900
Ø 35	7x/28.0 dpt	1	9.151 181
Ø 35	10x/38.0 dpt	1	9.151 182



7 Precision linen testers, plastic

- Linen tester with lateral scale
- Black plastic housing
- Scale: lateral scale with mm graduation

Eschenbach

Lens	Field of view	Height	Magnification	PK	Cat. No.
mm	mm	mm			
diam. 18	20 x 20	35	8x/30dpt	1	6.236 477

1 Precision linen testers, metal

- Brass frame, chrome-plated, silk matt finish
- Silica glass lenses, biconvex

Lens	Field of view	Magnification	PK	Cat. No.
mm	mm			
diam. 12.5	10 x 10	12x / 48dpt	1	9.151 423
diam. 14.5	15 x 15	10x / 40dpt	1	9.151 427
diam. 17.5	20 x 20	8x / 32dpt	1	9.151 433
diam. 22.5	25 x 25	6x / 24dpt	1	9.151 442
diam. 31.5	30 x 30	5x / 20dpt	1	9.151 453



2 Folding magnifiers mobilent LED

NEW

- Very compact, high-magnification folding magnifiers suitable for wearing around the neck or for handbag or trouser pockets.
- White plastic housing encloses the lens and makes it dust-tight
 - Aspheric PXM® lightweight lens for a distortion-free image with edge-to-edge sharpness
 - Efficient LED lighting
 - Battery cover is also threaded when using the lanyard

Eschenbach



Scope of supply: Magnifier, lanyard

Specifications

- Colour temperature: 6000 K
 Illumination intensity: > 300 lx (battery dependent)
 Battery: 1 x CR 2032 (included)

Magnification	Diopter	Lens	PK	Cat. No.
mm				
4x	16	Ø 35 mm	1	6.313 468
7x	28	Ø 35 mm	1	6.313 469
10x	32	Ø 35 mm	1	6.313 470

Precision folding magnifiers, plastic

- Glass fibre reinforced, non-breakable polyamide body
- The body is dustproof when closed
- Glass lenses

Eschenbach

Description	Lens	Lens	Magnification	PK	Cat. No.
mm					
Distortion-free image	Ø 23	Achromatic, coated	3x + 6x = 9x	1	9.151 055
Distortion-free image	Ø 23	Aplanatic	10x	1	9.151 155



9.151 055

Precision folding magnifiers, metal

- Matt chromium-plated brass body with eyelet
- Lens surround in black-painted metal

Eschenbach

Lens	Lens	Magnification	PK	Cat. No.
mm				
diam. 15	Achromatic	10x	1	9.151 040
diam. 17	Achromatic	20x	1	9.151 050
diam. 21	Aplanatic	8x	1	9.151 051
diam. 21	Aplanatic	10x	1	9.151 052
diam. 15	Aplanatic	12x	1	9.151 053



9.151 051

Precision scale magnifiers

- Distortion-free image with pinpoint clarity
- Fine focusing via easy-grip focusing ring
- Supplied with standard scale, measuring range 20 mm, 1/10 mm graduation, size: diam. 23 mm
- Housing made from glass fibre reinforced polyamide
- Supplied in a solid plastic box with space for other scales

Eschenbach

- LED lighting unit for precision scale magnifiers.
- Handle holds 2 batteries (not included)

Description	Magnification	PK	Cat. No.
Magnification	7x / 28,0 dpt	1	9.151 107
Magnification	10x / 40,0 dpt	1	9.151 108
Handle with LED illumination for magnifying lenses	--	1	9.151 106



9.151 107

9.151 108



9.151 106

1

1 Micromagnifier with illumination

NEW
Eschenbach

Suitable for inspecting a wide variety of surfaces such as metals, textiles, minerals, varnishes, etc. The wide focusing range enables raised or depressed features (e.g. holes) to be examined in detail.

- Precise focusing with adjustable wheel
- Wide adjustment range is able to compensate for a high level of visual impairment
- High brightness level due to large lens aperture
- The LED light can be used when required
- Magnification 30 x, glass lenses

Specifications

Colour temperature: 6500 K
 Battery: 2 x AA (not included)

Description	Magnification	PK	Cat. No.
with illumination	30x	1	6.313 363

2

2 Light Boxes slimlite plano

Super flat light boxes, only 8 mm thin, with built-in rechargeable battery.

Kaiser Fototechnik

Illumination by daylight-type LEDs (approx. 5000 Kelvin).

Touch switch for ON/OFF and brightness control, cm and inch scales. Optional mains or battery operation.

Lithium ion battery: 1050 mA. Mains/charging adapter included.

External dimensions (W x D x H) mm	Dimensions Illuminated area (W x D) mm	Lighting	PK	Cat. No.
290 x 200 x 8	220 x 160	23 LEDs	1	6.270 828
390 x 270 x 8	320 x 228	33 LEDs	1	6.270 829

3

3 Table-top magnifier

- Multifunctional table-top magnifier with magnification power of 2x and 4x depending of the view location.
- Can be operated with one hand
- 4 LED bulbs with on/off control.
- Magnifying lens position and illumination angle can be individually adjusted via the flexible gooseneck system
- Flicker free illumination without heat development
- Aspherical lens provide spherical aberration and distortion free images with edge-to-edge sharpness.
- Ideal for counting bacterial colonies on different culture media

Description	PK	Cat. No.
2X / 4X magnification	1	6.267 406

4

4 Illuminated magnifier

Magnifier lens complete with articulated arm.

Exacta Optech

Lens power: 2 x
 Lens dimensions: 190 mm x 157 mm
 Illumination: 2 fluorescent lamps: 9 W (230V /50Hz)
 Clamp opening: 70 mm

Type	PK	Cat. No.
Magnifier lamp	1	9.170 701

Binocular Microscopes for Schools/Laboratories B1-220E-SP

Established Quality with a new design. The B1 series covers a wide range of the daily work for Laboratory and University use. The Elite Series with improved optics and mechanics enables efficient work for many years.

- Observation Tube Binocular 45°/Phototube 30°, 360° rotating
- Widefield eyepieces WF10X/18 mm
- Quadruple revolving nosepiece
- Semi-Plan objectives SP 4X, 10X, 40X S, 100X S-Oil
- Coaxial coarse and fine focusing system with tension adjustment
- Built-in low position coaxial rackless mechanical stage
- Focusable 1.25 N.A. Abbe condenser with iris diaphragm
- LED illumination 3 W with intensity control
- Power supply 100-240 V
- Dust cover and immersion oil

Type	Description	PK	Cat. No.
B1-220E-SP	Binocular	1	6.284 968 1
B1-223E-SP	Trinocular	1	6.284 969

1

Motic



6.284 968

2 Educational Stereomicroscopes, RED 30S

With independent LED illumination. Innovative and user-friendly. Motics "One-touch" sample clip helps to fix the specimen easily. Fixed arm type stand with large integrated carrying handle for a stable stand and easy transportation.

- With magnification changer (2x, 4x)
- Binocular head, 45° inclined
- Widefield eyepieces WF10X/20 mm
- Objective turret magnification changer (2X, 4X)
- Coarse focusing system with tension adjustment
- Base with fixed arm and carrying handle
- Incident and transmitted rechargeable LED illumination with independent intensity control
- Power supply 100-240 V (CE), charger and batteries included
- Black/white and frosted stage plates, "one-touch" sample clips and dust cover
- 10 years warranty

Type	Description	PK	Cat. No.
RED 30S	Binocular	1	6.281 648

2

Motic



Basic Biological Microscope for Education and Routine, BA210E

Compact and robust, the BA210E is ideal for the requirements of colleges and universities as well as for medical training institutes.

- Infinity Optics [CCIS®]
- Observation Tube Siedentopf Type, Binocular -/Phototube 30°, F.N. 20
- Interpupillary Distance 55-75 mm
- Eyepieces High-Eyepoint N-WF 10x/20 mm with dioptre adjustment on both eyepieces and rubber eyecups
- Reversed quadruple revolving nosepiece
- Objectives CCIS EC Plan 4x, 10x, 40x-S, 100x-S-Oil
- Built in low position coaxial, rackless mechanical stage (right hand control)
- Focusable Abbe condenser N.A. 1.25 with iris diaphragm and slot
- Illumination 3 W LED
- Universal power supply 100-240 V (CE)
- Scope of supply: Immersion oil (5 ml), power cord, Allen hexagonal key, thumb crew, vinyl dust cover
- 6 V/30 W HAL illumination available as an option

Optional, available: Phase-contrast 10x/40x, DF 10x-40x, Polarization

Type	Description	PK	Cat. No.
BA210E	Binocular	1	6.265 838 3
BA210E	Trinocular	1	6.266 907

3

Motic



6.265 838

1

7.659 854

Advanced Upright Microscope for Life Science and Laboratories, BA310E

The BA310E is specially designed for the requirements of daily routine in universities, clinics and laboratories.

Motic

- Infinity Optics [CCIS®]
- Observation Tube Siedentopf Type, Binocular -/Phototube 30°, F.N. 20
- Interpupillary Distance 48-75 mm
- Eyepieces High-Eyepoint N-WF 10x/20 mm with dioptre adjustment on both eyepieces and rubber eyecups
- Reversed quintuple revolving nosepiece
- Objectives CCIS EC Plan 4x, 10x, 40x-S, 100x-S-Oil
- Built in low position coaxial, rackless mechanical stage (right hand control)
- Focusable Abbe condenser N.A. 0.90/1.25 with iris diaphragm and slot
- Koehler illumination 3 W LED with intensity control
- Universal power supply 100-240 V (CE)
- Scope of supply: Immersion oil (5 ml), power cord, Allen hexagonal key, thumb crew, vinyl dust cover
- 6 V/30 W HAL illumination available on option

Optional, available: Phase-contrast 10x/20x/40x/100x for slider or Turret-condensor, DF 10x-40x for slider or Turret-condensor, Polarization

Type	Description	PK	Cat. No.
BA310E	Binocular	1	6.262 306
BA310E	Trinocular	1	7.659 854

2

9.727 050

Clinical & Lab Microscope for advanced applications, BA410E

Professional microscope for numerous applications in biomedical research.

Motic

- Infinity Optics [CCIS®]
- Observation Tube Siedentopf Type, Binocular -/Phototube 30°, F.N. 22
- Interpupillary Distance 48-75 mm
- Eyepieces High-Eyepoint N-WF 10x/22 mm with diopter adjustment on both eyepieces and rubber eyecups
- Reversed sextuple nosepiece
- Objectives CCIS EC-H Plan 4x, 10x, 40x-S, 100x-S-Oil
- Low position coaxial, rackless mechanical stage with ceramic insert (right hand control)
- Achromatic swing-out condenser N.A. 0.90/0.13 with iris diaphragm
- Koehler illumination quartz halogen 12V/50W or 12 V/100 W with external lamp house and intensity control
- Auto-off and light-memory function when changing the magnification
- Universal power supply 100-240V (CE)
- Ø 45mm blue filter, immersion oil (5 ml), power cord, Allen hexagonal key, vinyl dust cover
- arm rest, spare fuse

Optional, available: Phase-contrast (Ph 1.2.3), DF 10x-40x, Polarization, Plan fluar objectives, Epi-fluorescence, Multi-head viewing system

Type	Description	PK	Cat. No.
BA410E	Binocular 50 W	1	9.727 050
BA410E	Binocular 100 W	1	9.727 051
BA410E	Trinocular 50 W	1	9.727 052
BA410E	Trinocular 100 W	1	9.727 053

Light microscopes Panthera C

Upright light microscopes for education, research and diagnostics.
Due to high quality optics and digital features especially suited for professional users.

- Tube type Siedentopf, swiveling
- Widefield oculars for spectacle wearers with diopter adjustment on both oculars
- CCIS® Plan achromatic objectives UC PL
- Reversed coded nosepiece
- Focusable Abbe condenser with iris diaphragm and slot
- Illumination acc. to Köhler, with interchangeable illuminator
- With Motic LightTracer (Intelligent Light Management): LED light intensity, light memory, sleep mode (auto on-off), mode indicator
- Coaxial coarse and fine focusing system with tension adjustment
- Compact, built-in mechanical stage
- Integrated power supply with sleep mode

Additional equipment depending on the model with common contrast methods such as phase contrast, darkfield, single polarization or LED fluorescence (single-channel) possible.

Inclination Tube:	25°
Angle of rotation Tube:	360°
Eyepieces:	Widefield UC-WF10X/22 mm
Nosepiece:	Quintuple
Objectives:	Spring: 4X/0.10 (WD 30.5 mm), 10X/0.25 (WD 17.4 mm), 40X/0.65 (WD 0.6 mm), Spring/oil: 100X/1.25 (WD 0.16 mm)
Interpupillary distance:	48 ... 75 mm
Condenser:	N.A. 0.90/1.25 Abbe condenser
Illumination:	3 W LEDs/30 W Halogen
Focusing stroke:	25 mm
Dimensions Stage (W x D):	185 x 145 mm
Dimensions (W x D x H):	210 x 282 x 394 mm
Netweight:	8.4 kg
Power supply:	110 ... 240 V, 50/60 Hz

1

Motic



4.668 673

Light microscopes Panthera CC

With USB 2.0 port for external camera power supply.

Motic

Scope of supply: Microscope, rubber eyecups, blue filter, LED and halogen modul, immersion oil (5 ml), allen key, dust cover, power cord

Type	Description	PK	Cat. No.
Panthera CC	Binocular	1	4.668 673
Panthera CC	Trinocular	1	4.668 674

2 Light microscope Panthera DL

Digitale microscope with integrated Wi-Fi camera for wireless image transfer to tablet or smartphone via the MotiConnect app or integration into a network via Ethernet.

Motic

- Ethernet and Wi-Fi
- Live image in FullHD
- Saved image with 4 MP

Scope of supply: Microscope, software Motic Images Plus 3.0 for Windows, OSX and Linux, MotiConnect App for iOS and Android, rubber eyecups, blue filter, LED and halogen modul, immersion oil (5 ml), allen key, dust cover, power cord

Sensor type:	CMOS
Sensor size:	1/3"
Resolution:	4 MP (2592 x 1520)
Live resolution:	1280 x 720, 1920 x 1080

2



Type	Description	PK	Cat. No.
Panthera DL	Digital binocular	1	4.668 716

1

9.727 031

Inverted Routine microscope for live cell inspection, AE2000

Classic cell culture microscope for daily work in the laboratory.

Motic

- Infinity Optics [CCIS®]
- Observation Tube Siedentopf Type, Binocular -/Phototube 45°, F.N. 20
- Interpupillary Distance 48 mm-75 mm
- Eyepieces High-Eyepoint N-WF 10x/20 mm provide dioptre adjustment for both eyes
- Side facing quadruple nosepiece
- Objectives CCIS Plan Achromat PL 4x, LWD PL 40x
- CCIS Plan Achromat Phase PL Ph10x, LWD PL Ph20x
- Plain stage 200 mm x 239 mm surface with metal & glass stage inserts
- Condensor ELWD N.A. 0.3 with phase slider (Ph1, BF)
- Illumination 6V/30W halogen with intensity control and sleeping mode
- Universal power supply 100 V-240 V (CE)
- Ø 45mm blue, green interference and neutral density filters with filter slider, centering telescope, power cord, Allen hexagonal key, vinyl dust cover.
- Interchangeable LED module available

Optional: phase-contrast 4x/40x, mechanical stage with well plate holder.

Type	Description	PK	Cat. No.
AE2000	Binocular	1	9.727 030
AE2000	Trinocular	1	9.727 031

2

6.268 478

Inverted Microscope for advanced applications AE31E

Professional inverted research microscope for a wide range of applications.

Motic

- Infinity Optics [CCIS®]
- Observation Tube Siedentopf Type, Binocular -/Phototube 45°, F.N. 22
- Interpupillary Distance 48-75mm
- Eyepieces High-Eyepoint N-WF 10x/22mm with diopter adjustment on both eyepieces
- Side facing quintuple nosepiece
- Objectives CCIS Plan achromat PL 4x,
- CCIS Plan Achromat Phase PL Ph10x, LWD PL Ph20x, LWD PL Ph40x
- Plain stage 200 mm x 239 mm surface with metal & glass stage inserts
- Condensor ELWD N.A. 0.3 with phase slider (Ph1, BF)
- Illumination: Externally mounted lamp house, Koehler 6V/30W Quartz halogen with intensity control
- Universal power supply 100 V-240 V (CE)
- Ø 45 mm blue, green interference and ground glass filters, centering telescope, power cord, Allen hexagonal key, vinyl dust cover
- Interchangeable LED module available

Optional available: mechanical stage with well plate holder, Epi-Fluorescence

Type	Description	PK	Cat. No.
AE31E	Binocular	1	6.268 477
AE31E	Trinocular	1	6.268 478

3

C-Mount camera adapter to BA & AE series

Motic

Description	PK	Cat. No.
Adapter C-Mount 0,5x	1	7.626 193
Adapter C-Mount 0,35x	1	6.274 030
Adapter C-Mount 0,65x	1	6.243 486

1 Light Microscopes Educational-Line OBT



1

The fully equipped all-round compound microscope for school, training and laboratories.

Kern & Sohn

- Monocular and Binocular
- Widefield Eyepiece: WF 10x/18 mm
- Diopter adjustment one-sided (for binocular models)
- Coarse and fine focussing on both sides
- OBT 101: simple 0.65 condenser lens with adjustable aperture diaphragm, triple nosepiece
- OBT 102 - 106: ABBE 1.25 condensor focussed with aperture diaphragm, quadruple nosepiece
- Dimmable 1 W LED illumination
- Dust Cover and manual instruction included
- Different colour filters as accessoires availabl

Total dimension (W x D x H): 195 x 147 x 325 mm
 Weight: 2.5 kg
 Power supply: 230 V/50 Hz, battery (optional)

Type	Description	PK	Cat. No.
OBT 103	Monocular, achromatic objective 4x, 10x, 40x	1	4.670 975
OBT 104	Binocular, achromatic objective 4x, 10x, 40x	1	4.670 976
OBT 105	Monocular, achromatic objective 4x, 10x, 40x, 100x	1	4.670 977
OBT 106	Binocular, achromatic objective 4x, 10x, 40x, 100x	1	4.670 978



2 3 Light Microscopes Educational-Line OBE 12/13



Kern & Sohn

The fully equipped all-round compound microscope for school, training and laboratories.

- Monocular (OBE 121, 131): Tube 30° inclined
- Binocular (OBE 122, OBE 132): Tube Butterfly 30° inclined, 360° rotatable
- Trinocular (OBE 124, 134): Tube Butterfly 30° inclined, 360° rotatable
- Widefield Eyepiece: WF 10x/18 mm
- Diopter adjustment at bino- and trinocular Version available (at one eyepiece tube)
- Quadruple nosepiece
- Coaxial pre-and fine focussing
- ABBE 1.25 condensor focussed with aperture diaphragm
- Dimmable 3 W LED illumination
- Storage compartment on the rear side
- USB connection (only as power source)
- Dust Cover, eyepiece rubber caps and manual instruction included
- Different colour filters as accessoires available

Total dimension (W x D x H): 360 x 150 x 320 mm
 Weight: 4.6 kg
 Power supply: 230 V/50 Hz, external power bank via USB

Type	Description	PK	Cat. No.
OBE 121	Monocular, achromatic objective 4x, 10x, 40x	1	4.670 979
OBE 122	Binocular, achromatic objective 4x, 10x, 40x	1	4.670 980
OBE 124	Trinocular, achromatic objective 4x, 10x, 40x	1	4.670 981
OBE 131	Monocular, achromatic objective 4x, 10x, 40x, 100x (oil immersion)	1	4.670 982
OBE 132	Binocular, achromatic objective 4x, 10x, 40x, 100x (oil immersion)	1	4.670 983
OBE 134	Trinocular, achromatic objective 4x, 10x, 40x, 100x (oil immersion)	1	4.670 984

2



3



Light Microscopes Lab-Line OBL

The flexible laboratory assistant with infinity optical system and fixed, pre-centred Koehler illumination.

Kern & Sohn

- Tube 30° inclined , 360° rotatable
- Widefield eyepiece: WF 10x/20 mm
- Diopter adjustment at one eyepiece tube
- Quadruple nosepiece (backward inclined)
- Objectives 4x, 10x, 40x, 100x (Oil immersion), (different Quality objectives in different series)
- Infinity Optical System and Infinity corrected lenses
- Objective quality: Infinity E-Plan
- Coaxial pre-and fine focussing
- ABBE 1.25 N.A. condensor with aperture diaphragm, focusable and pre-centered koehler illumination
- Lightfield diaphragm
- Available with 20 W Halogen or 3 W LED illumination
- Available as phase contrast microscope (OBL 145 und OBL 155) or individuell phase contrast units.
- Dust cover, eyepiece rubber caps and manual instruction included
- Additional eyepiece and filters available as accessoires

1



1 Light Microscopes Lab-Line OBL

NEW

- Binocular Tube (OBL 125, OBL 127, OBL 145)
- Trinocular Tube (OBL 135, OBL 137, OBL 155)
- OBL 145 and OBL 155 are equipped with 4x/100x Infinity E-Plan objective for brightfield and 10x/40x Infinity Plan Phase Contrast objective

Kern & Sohn

Type	Description	Lighting	PK	Cat. No.
OBL 125	Binocular	6 V/20 W Halogen	1	4.657 658
OBL 127	Binocular	3 W-LED	1	4.657 659
OBL 135	Trinocular	6 V/20 W Halogen	1	4.657 660
OBL 137	Trinocular	3 W-LED	1	4.657 661
OBL 145	Binocular, 10x/40x Plan PH	6 V/20 W Halogen	1	6.285 897
OBL 155	Trinocular, 10x/40x Plan PH	6 V/20 W Halogen	1	6.285 898

Light Microscopes Lab-Line OBL sets

NEW

The sets are the complete digital solution for live investigations. Optionally available with an adapted tablet or C-mount camera, including appropriate C-mount adapter. The adapted tablet-camera has been specially developed for simple, convenient and direct investigation of the sample on the screen.

Kern & Sohn

- Trinocular Tube
- 3W-LED illumination (transmitted light)

Type	Description	PK	Cat. No.
OBL 137C825	Incl. 5 mpx camera, with USB 2.0 interface and C-Mount adapter	1	6.313 869
OBL 137C832	Incl. 5 mpx camera, with USB 3.0 interface and C-Mount adapter	1	4.670 985
OBL 137T241	Incl. 5 mpx tablet-camera, with WLAN, USB 2.0 interface, HDMI, SD	1	6.313 870



Accessories for Light Microscopes Educational-Line OBE and Lab-Line OBL

Further eyepieces, phase contrast units and filters available on request. Complete fluorescence units for OBL series available on request.

Kern & Sohn

Description	For	PK	Cat. No.
C-Mount Adapter: 0.5x with adjustable focus	OBE	1	6.285 913
C-Mount Adapter: 0.5x with adjustable focus	OBL, OCM	1	6.272 562
Darkfield Unit: 4x-40x	OBE	1	4.657 466
Darkfield Condensor: 4x-40x	OBL	1	6.285 901
Objective: Plan 100x/1.0 (water/spring loaded) W.D. 0.18 mm	OBE	1	6.285 900
Objective: Infinity Plan 100x/1.15 (water/spring loaded) W.D. 0.18 mm	OBL	1	6.286 318

Compact Zoom Stereo Microscope with LED, SMZ-161 Series

Convincing optical performance combined with compact footprint and robust mechanics makes the SMZ-161 the ideal stereo microscope for teaching environments in High Schools and Universities.

SMZ-161-LED(R2LED)

- Greenough zoom optical system
- Fixed optical split 50:50
- Widefield eyepieces WF10X/20 mm, incl. rubber eyecups
- Diopter adjustment on both eyepiece tubes
- 6:1 Zoom ratio, WD=110 mm
- Objective magnification range: 0.75X-4.5X
- R2LED: Compact incident/transmitted illumination stand
- Coarse focusing system with tension adjustment
- 3W incident and transmitted LED illumination with intensity control
- Main supply 100 V-240 V (CE)
- Black/White and frosted glass stage plates and dust cover

Type	Description	PK	Cat. No.
SMZ-161-BLED (R2LED)	Binocular	1	6.266 908
SMZ-161-TLED (R2LED)	Trinocular	1	7.658 531



6.266 908

High-performance Greenough Stereo Microscope with LED, SMZ-171 Serie

Versatile Stereo microscope for a wide range of biological and material science applications.

- Improved image contrast due to multi-layer lens coating
- ESD compatible set ups available
- Various accessories available
- Observation Tube Binocular -/Phototube 45°, 360° rotating, F.N. 23
- Fixed optical split 50:50
- Widefield adjustable eyepieces WF10X/23 mm, incl. eyecups
- 6.7:1 Zoom ratio, WD=110 mm
- Objective magnification range: 0.75X-5X
- SMZ-171 Pole type stand with large working area and head holder
- Coarse focusing system with tension adjustment
- 3W incident and transmitted LED illumination with independent intensity controls
- Transmitted light with tilting reflector (oblique illumination)
- Option to adapt flexible light guide
- Main supply 100 V-240 V (CE)
- Black/White and frosted glass stage plates, and dust cover

Type	Description	PK	Cat. No.
SMZ-171-BLED	Binocular	1	6.264 087
SMZ-171-TLED	Trinocular	1	7.671 016



7.671 016

C-Mount Camera Adapter for SMZ 161/171 series

Description	PK	Cat. No.
adapter C-Mount 0,5x	1	7.626 193
adapter C-Mount 0,65x	1	6.243 486



1

Greenough-Stereomicroscope Educational-Line OSE

NEW

Ideal for workshops, schools and training.

Kern & Sohn

- Tube 45° inclined
 - WF 10x/ Ø 20 mm
 - Diopter adjustment: Both-sided
 - Illumination 1 W LED incident and transmitted
 - Integrated handle and arm curved stand
- Total dimension (W x D x H): 230 x 130 x 300 mm
 Weight: 2.0 kg
 Power supply: 230 V/50 Hz, battery

Type	Description	Magnification	PK	Cat. No.
OSE 421	Binocular	2x / 4x	1	4.666 529
OSE 422	Binocular, rechargeable batteries included	2x / 4x	1	4.666 530

2

6.286 167

Greenough Stereo Microscopes Lab-Line OZL

The flexible all-rounder with zoom function for schools, training companies, inspection authorities and laboratories.

Kern & Sohn

- Tube 45° inclined
- Wide Field WF 10x/20 mm
- Diopter adjustment: Both-sided
- Illumination: 3 W-LED Incident and 3 W-LED transmitted, separately dimmable
- Interpupillary distance 55 to 75 mm
- Large selection of eyepieces, external illumination units as well as auxiliary objectives are available as accessories
- Protective dust cover, eye piece rubber caps, as well as multi-lingual user instructions included in the scope of delivery

Type	Description	Magnification	PK	Cat. No.
OZL 463	Binocular	7x ... 45x	1	6.286 167
OZL 464	Trinocular	7x ... 45x	1	6.286 168

Accessories for Greenough Stereo Microscopes Lab-Line OZL 463/OZL 464

Kern & Sohn

Type	PK	Cat. No.
C-Mount Adapter 0.5x	1	4.657 806
Auxiliary objective 0.5x	1	6.285 902
Auxiliary objective 1.5x	1	6.285 903
Auxiliary objective 2.0x	1	6.285 904

3

Wi-Fi Microscope Camera Moticam X3

Wireless transfer of microscope images in full HD to smartphones or tablets.

MotiC

Connect mobile devices with the Wi-Fi signal of the camera and up to 6 users are ready to capture, edit and save pictures with the free App MotiConnect.

- Data transfer Wi-Fi (2.4 or 5 GHz) and Ethernet (RJ45)
- Operating System Microsoft Windows XP/Vista/7/8/MAC OSX/Android 4.0 or higher/iOS7 or higher
- External Power Supply (12 V)

Scope of supply: CS Ring Adaptor, Focusable Lens, 30 mm and 38 mm Eyepiece Adapters, USB 2.0 Cable, Calibration Slide, Macro Tube, Motic Images Plus 3.0 for PC/OSX/Linux

Type	Resolution	Sensor format	PK	Cat. No.
Moticam X3	4 MP (1920 x 1080 px or 1280 x 720 px)	1/3" CMOS	1	4.662 164

4

Microscope Camera MOTICAM S

NEW

The next generation of Moticams offers solutions for a wide variety of applications in digital microscopy. Compact and robust, equipped with high-quality sCMOS sensors with many different resolutions and fast USB 3.1 connection.

MotiC

Type	Resolution	Sensor format	PK	Cat. No.
MOTICAM S1	1,2MP (max. 1280 x 950 px)	1/3" sCMOS	1	4.672 118
MOTICAM S3	3MP (max. 2448 x 1536 px)	1/2.8" sCMOS	1	4.672 119
MOTICAM S6	6MP (max. 3072 x 2048 px)	1/1.8" sCMOS	1	4.672 120
MOTICAM Pro S5 Lite	5MP (max. 2448 x 2048 px)	2/3" sCMOS	1	4.672 121

1 2 Microscope Camera Moticam 1080

A multi-output camera with Full-HD resolution. This multifunctional camera with integrated software offers a new quality for interactive microscopy in educational, laboratory and industrial environments and allows working without additional computer. The HDMI signal delivers a fast live image with 1080 (60P) resolution and high color fidelity. Still images and videos are stored either at 2 MP or 8 MP format on MicroSD card. Especially for the visualisation of fast, moving samples in biology and industry 60 full frames per second are ideal system preconditions. The on-board software is controlled via WiFi mouse. As an alternative, the USB port of the camera can be used, also simultaneously to the HDMI port, to run the camera with the new Motic Images Plus 3.0 software with all its measuring tools. A HDMI video projector allows to present the impressive live image to a greater public. The delivery package includes the software Motic Images Plus 3.0, calibration slide, eyepiece adapters as well as macro tube with focusable lens.

Motic



Type	Resolution	Sensor format	PK	Cat. No.
Moticam 1080	2.0/8 MP	1/2.8" CMOS	1	6.282 488

➔ C-Mount camera adapter please see page 1100.



3 Digital CMOS Microscope Cameras ODC

Specialists in microscopy for measurement, counting, documentation, archiving and image processing.

Kern & Sohn

- C-Mount USB-camera with CMOS sensor
- USB-cable, eyepiece adapter and calibration slide included
- Kern-Microscope-VIS Software in 6 languages inclusive, for WINDOWS XP and higher



Type	Resolution	Sensor format	Interface	PK	Cat. No.
ODC 824	3,1 MP	1/2" CMOS	USB 2.0	1	6.285 783
ODC 825	5,1 MP	1/2.5" CMOS	USB 2.0	1	6.285 906
ODC 831	3,1 MP	1/3" CMOS	USB 3.0	1	6.285 907
ODC 832	5,1 MP	1/2.5" CMOS	USB 3.0	1	6.285 908

USB Hand held microscopes for schools and education

The Dino-Lite microscopes are available for teachers and students for all levels of education. They are suitable for use in science teaching for detailed examination e.g. of insects, plants, minerals, fossils and mechanical and electrical components.

Dino-Lite

- USB 2.0, 30 fps
- VGA (640 x 480) or 1.3 MP image resolution
- WF4115ZT with WLAN streamer
- Incl. Dino-Lite software, for AM4113T and WF4115ZT the software also includes measurement functions
- Warranty: 2 years

Scope of supply: Carrying pouch, Software CD for Windows and Mac OS, calibration sheet for AM4113T and WF4115ZT, manual



6.285 940



4.668 457

Type	Resolution	Magnification	Lighting	PK	Cat. No.
AM2111	640 x 480 pixels	10x ... 70x, 200x	4 x LED, white	1	6.285 940
AM4113T	1.3 MP	10x ... 70x, 200x	8 x LED, white	1	6.285 920
WF4115ZT	1,3 MP	20x ... 220x	8 x LED, white	1	4.668 457

Accessories for USB Hand held microscopes for schools and education

Dino-Lite

Description	PK	Cat. No.
Table stand with vertical orientation	1	4.675 298
Table stand with 30° inclinable pole feature	1	4.675 299
WiFi Streamer for AM4113T	1	6.285 946



4.675 298



6.285 946

➔ More manual microscopes please see chapters 13.



6.285 935

USB Hand held fluorescence microscopes

The Dino-Lite fluorescence microscopes are considered the smallest fluorescence microscopes. They are flexible, compact, user-friendly and economical. With excitation LEDs from 400 to 620 nm, they are suitable for viewing a wide range of luminophores for applications in biology, pathology and anatomy.

Dino-Lite

- USB 2.0, 30 fps
- 1.3 megapixel (1280x1024) image resolution
- Light source switchable from fluorescent LEDs to a white LED for localisation and fousation of the object
- Long-pass emission filter
- Guarantee: 2 years

Scope of supply: Carrying pouch, Software CD for Windows and Mac OS, calibration slide, manual

Type	Resolution	Magnification	Lighting	Fluorophore	PK	Cat. No.
AM4115T-CFVW	1.3 MP	20x-220x	400 nm excitation, 430 nm emission	DAPI	1	6.285 935
AM4115T-GFBW	1.3 MP	20x-220x	480 nm excitation, 510 nm emission	GFP, FITC	1	6.285 936
AM4115T-YFGW	1.3 MP	20x-220x	525 nm excitation, 570 nm emission	Cy3, TRITC	1	6.285 937
AM4115T-RFYW	1.3 MP	20x-220x	575 nm excitation, 610 nm emission	TxRED, mCherry	1	6.285 938
AM4115T-DFRW	1.3 MP	20x-220x	620 nm excitation, 650 nm emission	Cy5	1	6.285 939



4.661 946

USB Hand held microscopes Dino-lite Edge 3.0

The Dino-lite Edge 3.0 high-speed series with its USB 3.0 connection offers uncompressed transmission of images with high resolution and color accuracy. It achieves a maximum speed of 45 fps. The built-in polarizing filter make this models ideal for working with shiny or reflective objects such as metal, plastic, glass, jewelry, electronics, etc. Special features such as Automated Magnification Reading (AMR) for making easy and accurate measurements or Extended Depth of Field (EDOF) for combining a series of images with different focus levels, are available on selected models.

Dino-Lite



4.661 952

- USB 3.0, maximum 45 fps
- 5 Megapixel Edge sensor
- Extended Depth of Field (EDOF)
- Extended Dynamic Range (EDR)
- Automatic Magnification Reading (AMR)
- Adjustable Polariser
- Flexible-LED-Control (FLC)

Scope of supply: Carry pouch, USB cable, Software for Windows and Mac OS (not for EDOF, EDR models), open and closed cap, diffuser and side light cap, extension and long cap, calibration slide and manual.

Type	Resolution	Magnification	Lighting	Max. Working Distance mm	PK	Cat. No.
AM73115MZT (FLC)	5 MP	20x ... 220x	LED, white	60	1	4.661 946
AM73115MZTL (FLC)	5 MP	10x ... 140x	LED, white	235	1	4.661 947
AM73115MTF (FLC)	5 MP	10x ... 70x	LED, white	480	1	4.661 948
AM73515MZT (AMR, FLC)	5 MP	20x ... 220x	LED, white	60	1	4.661 949
AM73515MZTL (AMR, FLC)	5 MP	10x ... 140x	LED, white	235	1	4.661 950
AM73915MZT (EDOF, EDR, AMR, FLC)	5 MP	10x ... 220x	LED, white	235	1	4.661 951
AM73915MZTL (EDOF, EDR, AMR, FLC)	5 MP	10x ... 140x	LED, white	235	1	4.661 952



6.285 944



6.275 263

Accessories for USB Hand held microscopes

Dino-Lite

Description	PK	Cat. No.
Table top stand with quick-release incl. extension arm	1	6.285 944
Metal stand, vertical and horizontal positioning	1	6.275 263

10. Optical instruments and Microscopes

Microscopy/Microscopy accessories

1 Immersion oil

Motic

Type	PK	Cat. No.
Immersion oil, 5 ml	1	6.283 838



2 Microscope Cleaning Kit

Content: 1 power blower, cotton swabs, cleaning liquid, cleaning cloth, lens cleaning paper, retractable brush

Motic

Type	PK	Cat. No.
Mikroskope Cleaning Kit	1	6.280 087



3 Drying pads Grade 556Z

For retaining specimen visibility (50 sheets).

Whatman

Width mm	Length mm	PK	Cat. No.
37	100	1	9.069 003



4 Lens Tissue Paper

Special paper for cleaning optical glass
Packing: 500 pieces/dispenser box

Hecht

Type	Dimensions mm	PK	Cat. No.
Lens tissue paper	90 x 72	500	6.050 595

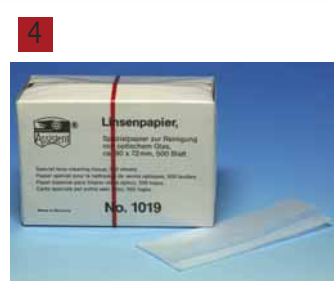

5 6 Lens cleaning tissues, 105 series

For the safe removal of surface moisture and grease from lenses and other optical surfaces. Chemically pure and free from silicones and other additives.

Whatman

Width mm	Length mm	PK	Cat. No.
100	150	625	9.056 887
200	300	100	9.056 888

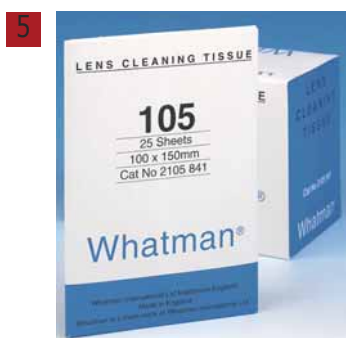

1

6.272 060

Liquid Dispenser, ESD

Ideal for a wide range of applications in chemistry and medical laboratories.

Ideal-tek

Made of antistatic HDPE with Teflon tube inside, for a great chemical resistance, ESD-safe.

With hinged lid. Just touch the dispensing dish with a brush, cloth or other applicator and solvent is brought to the surface the instant it is needed. Stainless steel valves seal contents in bottle until used, preventing spills, dripping and escaping fumes from endangering the user.

Fluid pumped into the dish does not drip back into the bottle, keeping stored liquids uncontaminated.

Capacity ml	Description	PK	Cat. No.
120	Fluid dispenser	1	4.666 353
120	Anti-splash fluid dispenser	1	4.666 354
180	Anti-splash fluid dispenser	1	6.272 060

2

2 Hand Wrap ASPURE, glass

- Lid: PP
- Pumps: brass, lid nickel plating
- Tube: PTFE
- Easy liquid dispense by pressure on the metal head
- Economical dosing
- No evaporation

AS ONE

Type	Capacity ml	Diam. mm	Height mm	PK	Cat. No.
200	170	85	108	1	4.663 665
500	280	85	140	1	4.663 666

3

3 Canada balsam bottle

Goldschmidt pattern. Clear glass. For microscopy examinations.

Ground joint maximises useful life of contents.

Capacity g	PK	Cat. No.
30	1	6.070 616
60	1	6.053 546



1 LED cold light sources LED3

Titanium-grey. The fan-less Led light sources are an energy saving replacement for conventional 150 W halogen cold light sources. The passive cooling system enables a noiseless and vibration-free operation. Data for the lumen refer to the measurement at the end of a flexible, 1-arm fiber optic light guide with active diameter \varnothing 9 mm and length 1000 mm.

Starlight Opto-Electronics

- Adaptable to various light guides
- Flicker-free lighting
- Solid aluminium housing
- Stackable and horizontal positionable

Scope of delivery: LED cold light source LED3, multi adapter power supply (EU, UK, US), user manual

Specifications

Illuminant:	30 W
Operation time:	50000 h
Brightness control:	0 - 100 %
Light guide access:	15 mm
Dimensions (W x D x H):	174 x 259 x 81 mm
Weight:	3.7 kg
Power supply:	100 ... 240 V AC, 50/60 Hz

Type	Colour temperature K	Light flux lm	Plug type	PK	Cat. No.
LED3-P, CRI 70	5700	730	EU, UK, US	1	4.668 033
LED3-PC, CRI 90	5700	590	EU, UK, US	1	4.668 034
LED3-N, CRI 80	4000	630	EU, UK, US	1	4.668 035
LED3-W, CRI 80	3000	630	EU, UK, US	1	4.668 036

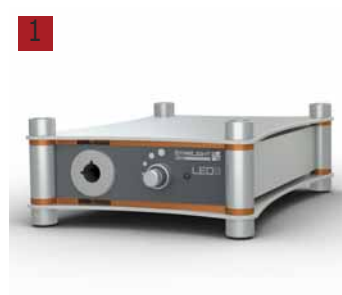

2 Semi-rigid light guides, GLS1/GLS2/GLS3

The semi-rigid light guides are available in versions of 1-arm, 2-arms and 3-arms.

Starlight Opto-Electronics

- High flexibility and luminous efficiency
- Very good transmission
- Spot illumination
- Low heat generation
- For halogen and LED cold light sources
- Adaptable to cold light sources from all manufacturers



4.668 060

Type	Description	Material	Colour	PK	Cat. No.
GLS1	1-armed, arm length 450 mm, active \varnothing 4.5 mm	Steel / brass	black	1	4.668 057
GLS1	1-armed, arm length 600 mm, active \varnothing 4.5 mm	Steel / brass	black	1	4.668 058
GLS1	1-armed, arm length 800 mm, active \varnothing 4.5 mm	Steel / brass	black	1	4.668 059
GLS2	2-armed, arm length 400 mm, active \varnothing 3.2 mm	Steel / brass	silver	1	4.668 060
GLS2	2-armed, arm length 450 mm, active \varnothing 4.5 mm	Steel / brass	black	1	4.668 061
GLS2	2-armed, arm length 600 mm, active \varnothing 4.5 mm	Steel / brass	black	1	4.668 062
GLS2	2-armed, arm length 800 mm, active \varnothing 4.5 mm	Steel / brass	black	1	4.668 063
GLS2	2-armed, arm length 600+800 mm, active \varnothing 4.5 mm	Steel / brass	black	1	4.668 064
GLS3	3-armed, arm length 450 mm, active \varnothing 4.5 mm	Steel / brass	black	1	4.668 065
GLS3	3-armed, arm length 600 mm, active \varnothing 4.5 mm	Steel / brass	black	1	4.668 066
GLS3	3-armed, arm length 800 mm, active \varnothing 4.5 mm	Steel / brass	black	1	4.668 067

Further accessories can be found in our online shop.

3 Fiber optical ring lights SRL3/SRL6

Black. The fiber optical ring lights offer high flexibility and luminous efficiency.

Starlight Opto-Electronics

- Very good transmission
- Low heat generation
- For halogen and LED cold light sources
- Adaptable to cold light sources from all manufacturers

Specifications

Working distance:	SRL3 // SRL6 20 ... 150 mm // 35 ... 150 mm
Active diameter:	6.4 mm // 9 mm
Height:	26 mm // 25 mm
Outer diameter:	58 mm // 92 mm
Clamping diameter:	30.5 mm // 66 mm
Material:	Anodized aluminium
Material tube:	Steel spiral, PVC



4.668 046

Type	PK	Cat. No.
SRL3	1	4.668 045
SRL6	1	4.668 046



4.668 075

2 LED incident lamps IL1/IL1-Lab

Black. The modul-LED® concept allows a quick change of the light source. For use in industry and science. The LED incident lamps are available in versions of 1-arm, 2-arms and with screw caps and borosilicate protective glass. The modules must be ordered separately.

Starlight Opto-Electronics

- Brightness control with memory function
- Flexible illumination thanks to semi-rigid arms
- Flicker-free lighting for photographic and video
- Solid aluminium housing

Scope of delivery: LED incident lamp IL1, multi adapter power supply (EU, UK, US), user manual

Specifications

Illuminant:	3 W LED Module 21 mm
Brightness control:	0 - 100 %
Fixing rod Ø:	12 mm
Dimensions control unit (W × D × H):	40 × 80 × 37 mm
Power supply:	100 ... 240 V AC, 50/60 Hz



Type	Description	Weight kg	Plug type	PK	Cat. No.
IL1-Lab	1-arm, arm length 450 mm	0.5	EU, UK, US	1	4.668 073
IL1-Lab	1-arm, arm length 600 mm	0.5	EU, UK, US	1	4.668 074
IL1-Lab	2-arms, arm length 450 mm	0.7	EU, UK, US	1	4.668 075
IL1-Lab	2-arms, arm length 600 mm	0.7	EU, UK, US	1	4.668 076
IL1*	1-arm, arm length 450 mm	0.5	EU, UK, US	1	4.668 077
IL1*	1-arm, arm length 600 mm	0.5	EU, UK, US	1	4.668 078
IL1*	2-arms, arm length 450 mm	0.8	EU, UK, US	1	4.668 079
IL1*	2-arms, arm length 600 mm	0.8	EU, UK, US	1	4.668 080

* With screw caps and borosilicate protective glass



3 LED-Modules

21 mm. Available in different colours, beam angles and UV versions.

Starlight Opto-Electronics

Description	Colour	Colour temperature	Shaft length	PK	Cat. No.
		K	mm		
Spot (10°)	pure white	6000		1	4.668 085
Spot (10°)	natural white	4000		1	4.668 086
Spot (10°)	warm white	3000		1	4.668 087
Spot (10°)	red		625	1	4.668 088
Spot (10°)	green		528	1	4.668 089
Spot (10°)	blue		470	1	4.668 090
Spot (10°)	amber		590	1	4.668 091
Flood (28°)	pure white	6000		1	4.668 092
Flood (28°)	natural white	4000		1	4.668 093
Flood (28°)	warm white	3000		1	4.668 094
Flood (28°)	red		625	1	4.668 095
Flood (28°)	green		528	1	4.668 096
Flood (28°)	blue		470	1	4.668 097
Flood (28°)	amber		590	1	4.668 098
Diffuse (40°)	pure white	6000		1	4.668 099
Diffuse (40°)	natural white	4000		1	4.668 100
Diffuse (40°)	warm white	3000		1	4.668 101
Diffuse (40°)	red		625	1	4.668 102
Diffuse (40°)	green		528	1	4.668 103
Diffuse (40°)	blue		470	1	4.668 104
Diffuse (40°)	amber		590	1	4.668 105
Line (12° x 30°)	pure white	6000		1	4.668 106
Line (12° x 30°)	natural white	4000		1	4.668 107
Line (12° x 30°)	warm white	3000		1	4.668 108
Line (12° x 30°)	red		625	1	4.668 109
Line (12° x 30°)	green		528	1	4.668 110
Line (12° x 30°)	blue		470	1	4.668 111
Line (12° x 30°)	amber		590	1	4.668 112
Reflektor (80°)	UV		365	1	4.668 113
Reflektor (80°)	UV		405	1	4.668 114

Suitable accessories can be found in our online shop.

Cold Light Sources

For sample illumination in microscopy, clinical diagnostics, dental technology, photography or mineralogy. Cold light sources filter out heat-producing, infra-red radiation and offer significantly higher intensities at magnifications over 30x magnification. Compact, easy to use and maintenance-free. KL 300 LED without fan otherwise with a low-noise fan with air vented at the rear of the casing.
Power supply: 100-240 V, 50/60 Hz

SCHOTT



9.705 204

KL 300 LED - compact

Cost-effective LED light source with easy handling and continuous dimming. Convection cooling for silent and vibration-free operation. Max. light intensity: 80 lm. Incl. wide-range power supply with international plug system.

Adapter or stand-alone stand sold separately.

KL 1600 LED - economy

Standard LED light source with continuous dimming, filter slider and multi-chip white light engine for a homogeneous illumination. Max. lighting intensity: 680 lm. Incl. wide-range power supply without cable.

KL 2500 LED - advanced

Professional LED light source, additionally, with extra-fine dimming option (0.1 % steps), LCD display for reproducible settings and USB-connectivity. Max. light intensity: 1100 lm. Incl. wide-range power supply and USB connection cable, without power cable. Footswitch optional.

KL 1500 HAL - natural colour

150 W halogen light source with continuous dimming and full halogen spectrum (colour rendering index CRI=100) for natural colour reproduction. Colour temperature indication on integrated LCD display. Maximum lighting intensity: 600 lm. Incl. wide-range power supply without cable.

Please order Fibre optic ring light or gooseneck light guide separately.

Please order a country-specific power cable for KL 1600 LED, KL 2500 LED and KL 1500 HAL separately.

Type	Width mm	Depth mm	Height mm	Colour temperature K	Light flux lm	PK	Cat. No.
KL 300 LED	106	114	61	5600	80	1	6.253 748
KL 1600 LED	114	231	137	5600	680	1	9.705 206
KL 2500 LED	114	231	137	5600	1100	1	9.705 204
KL 1500 HAL	200	286	147	1950 - 3400	600	1	6.269 725

2 Cold Light Source KL 1600 LED Packages

The KL 1600 LED is an innovative fiber optic light source which uses cold light to illuminate all types of objects in industrial and life science applications.

SCHOTT



- Powerful illumination system with a brightness of 680 lm
- Ergonomically placed dimming control
- Ripple free illumination for digital imaging applications
- Colour temperature of 5.600 K does not change when the light source is dimmed
- Maintenance free due to long lifetime LEDs of 50.000 hours

Scope of supply:

LED Cold light source KL 1600 LED incl. 2-armed gooseneck light guide, 2 focus lenses and according power cord

Specifications

Colour temperature:	5600 K
Light flux:	680 lm
Dimensions KL 1600 LED (W x D x H):	114 x 231 x 137 mm
Dimensions light guide (Ø x L):	4.5 x 600 mm
Weight:	3.9 kg
Power supply:	100 ... 240 V, 50/60 Hz

Type	Plug type	PK	Cat. No.
KL 1600 LED Package	EU	1	4.666 289
KL 1600 LED Package	UK	1	4.666 291
KL 1600 LED Package	CH	1	4.666 290

LED Illumination, direct

EasyLED Ringlight/EasyLED Ringlight Plus: Powerful and robust LED ring light with continuous dimming.

SCHOTT

Ringlight Plus version with basic segment features and segment rotation. Easy and intuitive operation via integrated jog dial wheel.

Including wide input range power supply with world wide plug (clip system). External/internal diameter 114/66 mm.

If necessary, please order the necessary lens adapter separately.

EasyLED Spotlight Plus (Single/ Double): Advanced high power LED gooseneck system with integrated controller and continuous dimming.

With the Spotlight Plus Double, the two spots can also be activated individually. Including wide input range power supply with world wide plug (clip system).

Please order mounting bracket or column adapter separately (same adapter as for KL 300 LED).

Type	Description	Working Distance mm	Colour temperature		Light flux lm	PK	Cat. No.
			K	K			
Ringlight	no segments	75	5600		190	1	6.258 176 1
Ringlight Plus	8 segments	65	5600		250	1	6.238 244
Spotlight Plus Single	single arm	10-90	5600		130	1	6.266 980
Spotlight Plus Double	double arm, separately switchable	10-90	5600		2 x 130	1	6.266 981 2



6.258 176



6.266 981



6.275 481



6.275 482

LED ringlight illumination VisiLED Packages

SCHOTT

Answering the needs of the most specialised tasks, the modular VisiLED series is built on flexibility and quality. Molding the lighting setup to each application, a number of high performance ringlights in combination with the separate Controller MC 1100 enable high intensity illumination. Diffusers and polarizer sets, which are optional available, allow a combination of different techniques right at the point of examination.

- Homogeneous and shadow free illumination
- Segmentable, in 1/8 steps rotatable, different segment modes available
- Actively controlled LED temperature for a long lifetime of 50000 hours
- Package 1 is ideal for unrestricted work on object preparations and the use of revolving nosepiece due to a slim ring light design (AD 92 mm)
- Optionally available adapter rings for connecting the ring lights to all common Stereomicroscope lenses with diameters up to 66 mm

Scope of supply:

Package 1: Controller VisiLED MC 1100, power adapter, LED Ringlight S40-75

Package 2: Controller VisiLED MC 1100, power adapter, LED Ringlight S80-55

If applicable, order necessary lens adapter separately.

Please order a country specific power cable separately.

Type	Description	Colour temperature		Working Distance mm	Light flux		PK	Cat. No.
		K	K		lm	lm		
Package 1	40 LEDs in 8 segments	5600		85	260		1	6.275 481 2
Package 2	80 LEDs in 8 segments	5600		75	290		1	6.275 482 4



9.705 220

Gooseneck light guide for SCHOTT Cold light sources

SCHOTT

Flexible light guides which will remain in place after positioning.

Gooseneck branches positioned in opposite directions create near shadow-free illumination.

Description	For	PK	Cat. No.
1-branch, diam. 3.5 mm, L 500 mm	KL 300 LED	1	9.705 221
2-branch, diam. 3.5 mm, L 500 mm	KL 300 LED	1	9.705 220 5
1-branch, diam. 4.5 mm, L 600 mm	KL 1500 HAL, KL 1600 LED, KL 2500 LED	1	9.705 151
2-branch, diam. 4.5 mm, L 600 mm	KL 1500 HAL, KL 1600 LED, KL 2500 LED	1	9.705 152
3-branch, diam. 4.5 mm, L 600 mm	KL 1500 HAL, KL 1600 LED, KL 2500 LED	1	9.705 153

Flexible light guide for SCHOTT Cold light sources

SCHOTT



9.705 226

Description	For	PK	Cat. No.
2-branch, PVC coated, diam. 4.0 mm, L 1000 mm	KL 300 LED	1	9.705 226
1-branch, PVC coated, diam. 4.5 mm, L 600 mm	KL 300 LED	1	9.705 225
2-branch, M-PVC coated, diam. 4.5 mm, L 1000 mm	KL 1500 HAL, KL 1600 LED, KL 2500 LED	1	9.705 165
2-branch, M-PVC coated, diam. 4.5 mm, L 1600 mm	KL 1500 HAL, KL 1600 LED, KL 2500 LED	1	9.705 169
3-branch, M-PVC coated, diam. 4.5 mm, L 1000 mm	KL 1500 HAL, KL 1600 LED, KL 2500 LED	1	9.705 166
1-branch, M-PVC coated, diam. 5.0 mm, L 1000 mm	KL 1500 HAL, KL 1600 LED, KL 2500 LED	1	6.228 108
1-branch, M-PVC coated, diam. 5.0 mm, L 1600 mm	KL 1500 HAL, KL 1600 LED, KL 2500 LED	1	9.705 164
1-branch, M-PVC coated, diam. 8.0 mm, L 1000 mm	KL 1500 HAL, KL 1600 LED, KL 2500 LED	1	9.705 168
1-branch, M-PVC coated, diam. 9.0 mm, L 1000 mm	KL 1500 HAL, KL 1600 LED, KL 2500 LED	1	7.642 628

Suitable accessories can be found in our online shop.

Flexible light guide for SCHOTT Cold light sources

For intensive, uniform and shadow-free illumination of samples.

SCHOTT



9.705 195

Description	For	PK	Cat. No.
6 point, int. diam. 66 mm	KL 300 LED	1	9.705 230
Annular, int. diam. 58 mm	KL 1500 HAL, KL 1600 LED, KL 2500 LED	1	9.705 194
Annular, int. diam. 66 mm	KL 1500 HAL, KL 1600 LED, KL 2500 LED	1	9.705 195
Annular, "slim", int. diam. 66 mm	KL 1500 HAL, KL 1600 LED, KL 2500 LED	1	6.254 612

Suitable accessories can be found in our online shop.

Clamps for Cold light source KL 300 LED and EasyLED Spotlight

SCHOTT

For	PK	Cat. No.
Ø 20 mm column	1	6.274 401
Ø 25 mm column	1	7.910 430
Ø 30 mm column	1	4.666 071
Ø 32 mm column	1	6.237 972
Ø 35 mm column	1	4.666 072
ZEISS stand K and stand M	1	4.666 076



We can **supply** this
manufacturer's
 whole
product range !



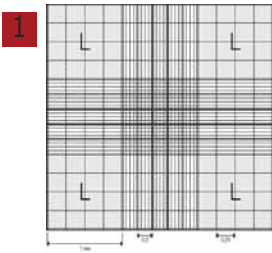

1 Counting chamber, Improved Neubauer

With double ruling. Calibratable. Cell depth 0.1 mm. BRAND
 Counting grid with 9 large squares each 1 mm². The 4 large squares in the corners for counting leucocytes are each subdivided into 16 squares with a side length of 0.25 mm. The large square in the middle is subdivided into 25 squares each with a side length of 0.2 mm. Each of these is further subdivided into 16 smaller squares each with a side length of 0.05 mm and an area of 0.0025 mm². The 5 group squares marked with an 'E' are used to count thrombocytes and erythrocytes. All group squares have triple boundary lines on each side.

Type	PK	Cat. No.
Without snap-on clips	1	7.020 270
With snap-on clips	1	7.020 272

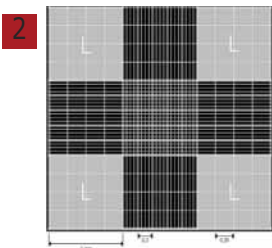

2 Counting chamber, Improved Neubauer, bright line

Bright line. With double ruling. Calibratable. Same counting grid as the Improved Neubauer cell, but with rhodium coated chamber base. Rulings are engraved into the Rhodium layer and appear bright under normal microscope settings. By altering the contrast it is possible to reverse the image under the microscope to make the rulings appear brighter or darker as required. BRAND

Description	PK	Cat. No.
Without snap-on clips	1	7.020 271

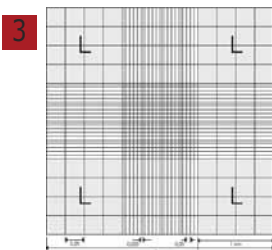

3 Counting chamber, Improved Neubauer

With double ruling. Calibratable. Cell depth 0.1 mm. Same ruling as Improved Neubauer, but the large square in the centre is divided into 16 squares each with a side length of 0.25 mm. Unlike the more modern Improved Neubauer counting chambers, the counting area of each group square is limited by the outermost of the triple border lines. BRAND

Description	PK	Cat. No.
without clamp	1	7.020 277
with clamp	1	7.020 278



4 Counting chamber, Thoma

Double ruling. Without snap-on clips. Calibratable. Cell depth 0.1 mm. Grid is the same as the grid in the centre of large square in the Neubauer chamber. The area of the small square is 0.0025 mm². Since the large outer squares are not included, the Thoma system is only used to count thrombocytes and erythrocytes.

Description	PK	Cat. No.
double ruling, without clamp	1	9.161 080
double ruling, with clamp	1	7.607 192

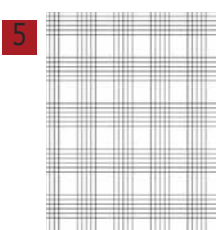

5 Counting Chamber, Malassez

BLAUBRAND®. Double ruling. Without snap-on clips. Cell depth 0.2 mm. BRAND
 The ruling is rectangular, covering an area of 5 mm². The large rectangles measure 0.25 x 0.20 = 0.05 mm². They are each subdivided into 20 mini squares with an area of 0.0025 mm². This chamber is commonly used for counting cells in the cerebrospinal fluid, or for counting nematodes. CE-marked according to IVD-Directive 98/79 EC.

Description	PK	Cat. No.
Without snap-on clips	1	7.020 281

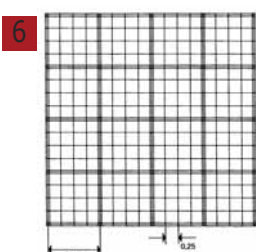

6 Counting chamber, Fuchs-Rosenthal

With double ruling. Without snap-on clips. Calibratable. Cell depth 0.2 mm. Grid has 16 x large 1 mm² squares. Each square is divided into 16 smaller squares each with a side length of 0.25 mm and an area of 0.0625 mm². These counting chambers are commonly used to count cells in cerebrospinal fluid.

Description	PK	Cat. No.
double ruling, without clamp	1	9.161 098
double ruling, hell-linig, with clamp	1	6.050 057

1 Counting Chambers according to McMaster

For veterinary medicine (e.g. helminth eggs counting) with 2 counting areas, cover glass with 2 counting grids glued on 3 supports. Hecht
 Counting area: 10 x 10 x 0.5 mm.

Length mm	Width mm	PK	Cat. No.
76	32	1	6.258 239

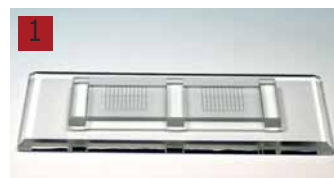

2 3 Counting chambers C-Chip

Disposable counting chamber made of optical plastic. NanoEn Tek Inc.
 Dimensions: 25 x 75 mm, thickness 1.6 mm.
 Various applications such as blood cell counting, cell concentration measurement, sperm counting, investigation of cell viability and bacteria and fungal spore counting.

- No need for coverslips
- Two chambers per chip
- Reduces the risk of infectious materials
- Quartz grade optical plastic
- Guaranteed repeatability and reliability
- Individually wrapped

Type	Depth mm	Capacity µl	PK	Cat. No.
according to Bürker	0.1	10	50	4.668 325
according to Bürker-Türk	0.1	10	50	4.668 326
according to Fuchs-Rosenthal	0.2	20	50	4.668 324
according to Malassez	0.2	20	50	4.668 327



4 Hand tally counter

Use for counting blood cells, bacterial colonies, drops of liquid, or any repetitive event. Heathrow Scientific
 Tallies up to 9999. Features a quick-reset knob, lens window for easy reading, and finger ring for a secure grip. Sturdy, chrome-finished, metal housing.
 Dimensions: 46 mm diameter x 41mm W.

Description	PK	Cat. No.
Hand tally counter	1	6.237 971



5 Economy Counters

Mechanical, benchtop counters are ideal for determining the number of cells, counting parts, etc. Use with blood cell labels provided or insert your own. Heathrow Scientific
 Each key records up to 999 count strokes. A totalising window keeps track of the total number of strokes made on all keys; a bell rings at every 100 total counts reached.

Description	Width mm	Length mm	Depth mm	PK	Cat. No.
6-key Economy Counter	76	250	56	1	9.521 801
9-key Economy Counter	76	320	56	1	9.521 802





1 Microscope slides

According to ISO 8037/1. Prewashed and polished. Nominal thickness 1 mm.
Size 76 x 26 mm. Also available with 20 mm, frosted, writing patch at one end.

Menzel

Type	Description	Edge finish	PK	Cat. No.
Without frosted end	Extra white	Cut	50	9.161 110
With frosted end	Extra white	Cut	50	9.161 145
Without frosted end	Extra white	Ground 45°	50	9.161 120

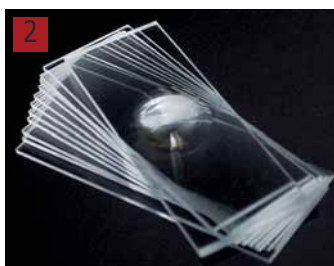

2 Microscope slides with cavities

Dimensions: 76 mm x 26 mm x 1.2 mm to 1.5 mm,
with cavities approx. 15 mm to 18 mm diameter and approx. 0.6 to 0.8 depth.

Menzel

Colour	Edge finish	PK	Cat. No.
extra white glass	90° ground edges	1	9.161 151



3 Superfrost® slides

According to ISO 8037/1. With colour-coded writing patch as outlined below.
Size 76 mm x 26 mm. Nominal thickness 1.0 mm. With cut or ground edges.
An extensive color palette allows easy and clear identification and classification of different examination preparations.

Menzel

Colour	Edge finish	PK	Cat. No.
white	Cut	50	9.161 161
blue	Cut	50	9.161 162
pink	Cut	50	9.161 163
yellow	Cut	50	9.161 164
green	Cut	50	9.161 165
white	Ground 45°	50	9.161 171
blue	Ground 45°	50	9.161 172
pink	Ground 45°	50	9.161 173
yellow	Ground 45°	50	9.161 174
green	Ground 45°	50	9.161 175



4 Superfrost® Plus adhesive microscope slides

Size: 75 mm x 25 mm x 1.0 mm. Ground edges 90°, white SuperFrost marking area.
A new application method provides the surface of a slide with a permanent positive charge.
Electrostatic attraction binds fresh, frozen tissue sections and cytology preparations.
Also available with blue, yellow, pink or green SuperFrost marking area.

Menzel

Type	Colour	PK	Cat. No.
SuperFrost® Plus	white	72	9.161 155

Adhesive microscope slides Polysine™

75 x 25 x 1 mm. ground edges 90°, white marking area.

Menzel

Polysine adhesion slides are electrostatically and biochemically adhesive.

The preparation is first adhered by electrostatic attraction and then fixed in place by biochemical binding.

Polysine adhesion slides are best suited for paraffin-embedded tissue slices from human sources fixed in formalin, alcohol or Bouin solution. For tissue slices 2-5 µm thick.

Type	Colour	Edge finish	PK	Cat. No.
Polysine™	white	ground 90°	72	6.055 100

1 Diagnostic slides without adhesion coating

75 mm x 25 mm x 1.0 mm, with 90° ground edges.

Menzel

Colour	Diam. mm	No. of chambers	Material	PK	Cat. No.
Blue	8.0	1	Epoxy	100	9.161 181
Black	14.0	3	Epoxy	100	9.161 182
Black	6.0	8	Epoxy	100	9.161 183
Black	6.7	10	Epoxy	100	9.161 184
White	5.0	12	Epoxy	100	9.161 185
Blue	8.0	1	PTFE	100	9.161 186
Black	14.0	3	PTFE	100	9.161 187
Black	6.0	8	PTFE	100	9.161 188
Black	6.7	10	PTFE	100	9.161 189
White	5.0	12	PTFE	100	9.161 190



2 LLG-Slide dispenser

Slide dispenser can dispense 91 slides, individually. By turning the knob, one slide is dispensed. Only dry slides should be inserted into the storage magazine. With transparent, removable upper section for easy viewing of remaining slides and clean storage. For microscope slides with dimensions 75 x 25 mm and 76 x 26 mm.

Type	PK	Cat. No.
Dispenser	1	9.161 000



3 Microscope slide or paper strip holder, PS

This slide holder has a sloped groove that accepts up to 10 single or double slides standing on end. Front ledge serves as a place to dry slides. Made of durable polystyrene.

Bel-Art Products

Internal dimensions (W x D x H) mm	PK	Cat. No.
250 x 50 x 30	1	9.161 208



4 Slide Holders, PE

For microscope slides 76 x 26 mm. For storing, cleaning, drying microscope slides. Robust design with anti-slip rubber feet. Temperature resistant in the range -50 to +80°C.

Heathrow Scientific

Array	Dimensions (W x D x H) mm	Colour	PK	Cat. No.
15	153 x 102 x 21	natural	1	6.254 573
40	298 x 105 x 24	natural	1	6.254 574
78	299 x 178 x 21	natural	1	6.254 575

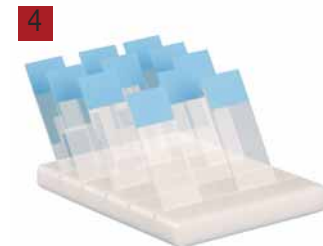



1 Square cover slips

Made of D263 M borosilicate glass. Accurate cutting free of flaws and blisters. Further thicknesses are available on request.

Menzel

Width mm	Length mm	Thickness mm	PK	Cat. No.
15	15	0,13-0,16	200	9.161 015
18	18	0,13-0,16	200	9.161 018
20	20	0,13-0,16	200	9.161 020
22	22	0,13-0,16	200	9.161 022
24	24	0,13-0,16	200	9.161 024
26	21	0,13-0,16	100	9.161 021
32	24	0,13-0,16	100	9.161 032
40	24	0,13-0,16	100	9.161 040
50	24	0,13-0,16	100	9.161 050
60	24	0,13-0,16	100	9.161 060



2 Circular cover slips

Made of D263 M borosilicate glass. Accurate cutting free of flaws and blisters. Diameters as indicated. Further sizes and thicknesses are available on request.

Menzel

Diam. mm	Thickness mm	PK	Cat. No.
10	0,13-0,16	100	9.161 063
12	0,13-0,16	100	9.161 064
13	0,13-0,16	100	9.161 065
14	0,13-0,16	100	9.161 066
15	0,13-0,16	100	9.161 061
18	0,13-0,16	100	9.161 062



3 Haemacytometer cover glasses

Quality A, ground edges.

Menzel

Width mm	Length mm	Thickness mm	PK	Cat. No.
22	22	0,4	10	6.073 041
24	24	0,4	10	6.313 619
26	20	0,4	10	6.314 328

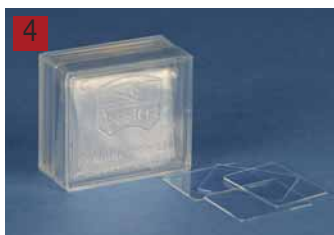

4 Haemacytometer Cover Glasses

Packing: boxes of 10 pieces.

Hecht

Length mm	Width mm	Thickness mm	PK	Cat. No.
30	30	0.4	10	7.632 190
20	26	0.4	10	6.053 291
22	22	0.4	10	6.234 347
24	24	0.4	10	7.630 066



5 LLG-Cover glass forceps, self-locking, stainless steel

Stainless steel 4301

Form	Length mm	PK	Cat. No.
Straight	105	1	9.160 380
Curved	105	1	9.160 381



6 LLG-Cover glass forceps, acc. to Kühne, stainless steel

Stainless steel 4301

Form	Length mm	PK	Cat. No.
curved	115	1	9.160 386
curved	130	1	9.160 387
curved	145	1	9.160 388
straight	115	1	9.160 391
straight	130	1	9.160 392
straight	145	1	9.160 393

1 Prepared Slides

Prepared microscope slides for education and studies.
Sets of 10 slides.

Type	PK	Cat. No.
Fishes, frogs and other ambhíbians	1	9.151 850
Lizard snakes and birds	1	9.151 851
Animal reproduction	1	9.151 852
Bacteria simple organisms	1	9.151 854
Plant reproduction and propagation	1	9.151 856
Structure of vegetable plants	1	9.151 857
Cell development and reproduction	1	9.151 858
Nanoplankton	1	9.151 859
Human body, normal tissues Part 1	1	9.151 860
Human body, normal tissues Part 2	1	9.151 861
The human body pathological tissues part 1	1	9.151 862
The human body pathological tissues Part 2	1	9.151 863
Animal and human parasites	1	9.151 864
Life in the ground	1	9.151 866
Animals and plants damaged by the environment	1	9.151 868
Set for teaching science	1	9.151 869
Set for teaching biology part 1	1	9.151 870
Set for teaching biology part 2	1	9.151 871



2 LLG-Slide mailers

Manufactured from high density polypropylene, for shipping, storing or staining slides.
Flat mailers can hold 1, 2, 3 or 5 standard (up to 76 mm x 26 mm) slides securely.

- Light weight and flat
- With marking area and "Top" printed on top surface
- With large, easy-to secure snaps.
- Slotted channels inside mailer keep slides safely separated

To hold microscope slides	PK	Cat. No.
1	10	9.161 291
2	10	9.161 292
3	10	9.161 293
5	10	9.161 294

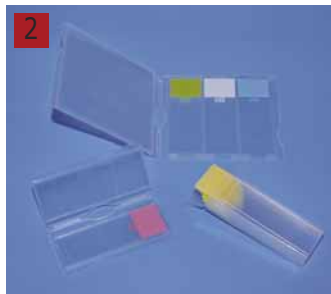

3 Slide mailers

For transporting 76 x 26 mm specimen slides, as outlined below.

To hold microscope slides	Cover type	PK	Cat. No.
2	Without	1	9.161 270
4	Without	1	9.161 274
6	Without	1	9.161 272
10	Without	1	6.225 466



4 Slide Mailers

Ideal for shipping, storing, or staining slides. These polypropylene containers hold five standard slides (75 mm x 25 mm and 3 x 1"). Inside wall features slotted channels to keep slides separated and to make removal easier. Close securely to keep slides safe.
Dimensions: 43 mm x 24 mm x 88 mm.

Heathrow Scientific

Colour	PK	Cat. No.
natural	25	6.242 062
red, yellow, blue, purple, orange	25	9.409 662



5 Slide Mailer, PP

For storing or shipping 5 thick or 10 thin slides. Sturdy design. Screw cap with fitting for sealing wire tag. When cap is open the slides protrude approximately 10 mm so they can be removed easily. Unbreakable, chemically inert, leakproof.

Kartell

Int. diam. mm	Height mm	PK	Cat. No.
40	90	1	9.161 395

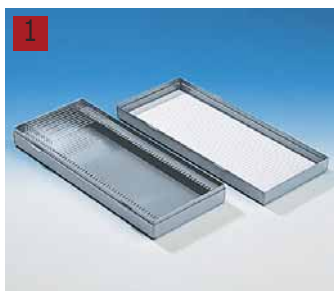

1

1 Microscope slide boxes, PS

High impact. For 76 mm x 26 mm slides. Numbered slots in base. Index card in lid.

Kartell

To hold microscope slides	Width mm	Length mm	Height mm	PK	Cat. No.
25	83	98	38	1	9.161 380
50	97	230	35	1	9.161 381
100	180	230	35	1	9.161 382

2

2 Microscope slide folders

Cardbord. Available with, or without, gatefold cover. For 76 mm x 26 mm slides as outlined below.

To hold microscope slides	Cover type	PK	Cat. No.
20	without	1	9.161 230
20	with	1	9.161 235

3

3 20- and 30-place Cardboard Slide Trays

Features thumb cut for easy slide removal.

Heathrow Scientific

Cardboard slide trays hold standard slides (76 mm x 26 mm and 3 x 1"). The horizontal compartments are recessed to protect the specimens when the cover is closed. Features thumb cut for easy slide removal.

To hold microscope slides	Colour	Size	PK	Cat. No.
20	black	208 x 341 x 9 mm	1	9.161 295
30	black	281 x 328 x 10 mm	1	9.161 296
20	blue	208 x 341 x 9 mm	1	9.161 297
20	green	208 x 341 x 9 mm	1	9.161 298
20	red	208 x 341 x 9 mm	1	9.161 302

4

4 Microscope slide folder, Munich type

Cardboard. For 76 mm x 26 mm slides.

To hold microscope slides	PK	Cat. No.
24	1	9.161 250

5

Slide storage box

To hold microscope slides	Dimensions (D x W) mm	Cover type	Material	PK	Cat. No.
100	76 x 26	+	plastic	1	9.161 211 S
100	40 x 76	+	Cardboard, leather paper, wooden frame	1	6.314 963
100	48 x 28	-	Cardboard, leather paper, wooden frame	1	9.161 224

9.161 211

6

6 Microscope slide tray without lid

Cardboard. For 76 mm x 26 mm slides.

To hold microscope slides	PK	Cat. No.
20	1	9.161 260

Trays for other sizes of slide are available on request.

7

7 Slide storage box

Cardboard covered with imitation leather. Hinged lid with locking clips. Holds slides 76 mm x 26 mm slides as outlined below.

To hold microscope slides	Cover type	PK	Cat. No.
25	+	1	6.206 674
50	+	1	9.161 215
100	+	1	9.161 210

10. Optical instruments and Microscopes

Microscopy/Slide storage-Staining racks

1 Microscope slide boxes

Colour-coded for easy identification. Slide boxes are perfect for storage or transportation of standard size slides (76 mm x 26 mm). With cork lining. Stackable. Each 100 place box is secured with a rust-resistant nickel-plated clasp and hinge pin. The 50 place box is secured by a thumb-latch lock mechanism. Each slot is numbered to correspond to the slide inventory sheet on the inside cover of the box.

Heathrow Scientific



To hold microscope slides	Colour	Dimensions (W x D x H) mm	PK	Cat. No.
25	Red	141 x 88 x 35	1	6.240 818
25	Green	141 x 88 x 35	1	6.240 819
25	Blue	141 x 88 x 35	1	6.241 030
50	Red	209 x 86 x 35	1	9.161 289
50	Blue	209 x 86 x 35	1	9.161 300
50	White	209 x 86 x 35	1	6.268 500
100	Red	208 x 175 x 34	1	9.161 286
100	Green	208 x 175 x 34	1	9.161 285
100	Blue	208 x 175 x 34	1	9.161 284
100	White	208 x 175 x 34	1	7.079 563
100	Yellow	208 x 175 x 34	1	9.161 288
100	Black	208 x 175 x 34	1	9.161 287

2 Microscope Slide Boxes Premium Plus

Made from ABS and Polypropylene. The stackable slide boxes are perfect for storage or transportation of 100 standard size slides (76 x 26 mm). Unique side storage can accommodate e.g. a pen or desiccant. Dimensions (W x D x H): 195 x 207 x 32 mm.

Heathrow Scientific

- With EVA foam lining
- Removable Inventory card
- Sliding lock
- Centrally positioned numbering
- Labelling area on the lid of the box with "project" and "date" molded in and the back of the index card can be used as the lid is transparent



Colour	PK	Cat. No.
Blue	1	4.666 453
Orange	1	4.666 454
Green	1	4.666 455
Red	1	4.666 456
Purple	1	4.666 457
Purple, Blue, Green, Red, Orange	5	4.666 458

3 Staining blocks, moulded glass

With hemispherical cavity, 32 mm diameter and 40 mm x 40 mm glass cover plate.

Colour	Int. bore diam. mm	Number of cavities	PK	Cat. No.
Clear	32	10	1	9.163 285
Black	32	10	1	9.163 286

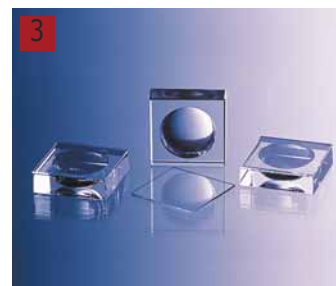

4 LLG-Staining plates, porcelain

Rectangular, white, glazed. With cavities as outlined below.

Int. bore diam. mm	Width mm	Length mm	Cavity depth mm	Height mm	Number of cavities	PK	Cat. No.
25	81	112	4	25	6	1	6.232 575
17	91	115	2	17	12	1	6.265 001



5 Cavity tiles, porcelain

Rectangular, white, glazed, with cavities as outlined below.

Haldenwanger

Int. bore diam. mm	Width mm	Length mm	Cavity depth mm	Height mm	Number of cavities	PK	Cat. No.
36	80	115	11	12	6	1	9.253 406
20	85	119	3	6	12	1	9.253 412
25	97	127	6	12	12	1	6.901 028





1 LLG-Staining jars, soda-lime-glass

The Schiefferdecker Staining Jar is suitable for holding 76 mm x 26 mm slides horizontally. This staining jar has 10 grooves which can accommodate 20 slides back-to-back. The Hellendahl Staining Jar is suitable for holding 76 mm x 26 mm slides vertically. This staining jar has 8 grooves which can accommodate 16 slides back-to-back. The "Macro" Staining Jar is suitable for holding 20 slides with 76 mm x 26 mm (please order rack separately). This Stainless Steel rack for "Macro" has 20 grooves which can accommodate 20 single slides. Each staining jar is supplied with a glass lid.

Type	Width mm	Length mm	Height with cap mm	PK	Cat. No.
Schiefferdecker Staining Jar	68	88	50,15	1	9.163 250
Hellendahl Staining Jar	61	63	102	1	9.163 251
"Macro" Staining Jar	88	105	78	1	9.163 252
Rack, Stainless Steel, for "Macro" jar				1	9.163 253



2 Staining rack, Glass

Glass. Holds microscope slides 76 mm x 26 mm to 50 mm. (Fits trough 9.163 281 not supplied). An accessory wire lifting handle is available.

Type	Width mm	Length mm	Height mm	PK	Cat. No.
Staining rack	30	85	45	1	9.163 280
Wire handle				1	9.163 284



3 Trough

Glass. Accepts one staining rack 9.163 280 (not supplied).

Type	Width mm	Depth mm	Height mm	PK	Cat. No.
Trough	105	85	70	1	9.163 281
Insert for 10 slides	91	70	48	1	7.020 105
Wire handle for insert				1	7.020 111



4 Preparation box DURAN®, with ground glass plate

The precise grinding of the glass plate and the lower part of the vessel enables a tight closure.

DWK Life Sciences

Width mm	Depth mm	Height mm	PK	Cat. No.
50	60	100	1	7.021 162
50	100	120	1	7.021 164
50	130	130	1	7.021 165
50	150	150	1	9.172 319
60	120	180	1	9.020 440
100	210	210	1	7.021 170
140	250	250	1	7.021 172



5 Aquaria, clear glass

With fine ground rim.

Hecht

Width mm	Depth mm	Height mm	PK	Cat. No.
100	150	150	1	6.306 510
130	180	180	1	6.270 192
150	200	200	1	6.270 193
180	220	250	1	6.270 194
220	300	240	1	6.079 530
230	360	260	1	7.601 329
220	300	150	1	7.601 348

1 Disposable Staining Slide Tray

Stain, rinse, and dry your slides on a single working tray. Made of a polypropylene and polyethylene blend, this rugged staining tray is an economical alternative to metal versions offering a clean and fresh working surface area every time. Up to eight slides fit comfortably onto the base and the deep well holds liquid waste up to 38 ml. Two convenient pour spouts make it easy to dispose of unwanted liquid waste. Unique dark lid protects slides when used with light sensitive applications. Supplied with 4 Base Trays and 1 Lid.

Heathrow Scientific



To hold microscope slides	Length mm	Width mm	Height mm	PK	Cat. No.
8	305	127	29.5	1	9.161 400

2 Staining jar, PMP (TPX®)

Supplied with 2 lids, one complete lid for use providing evaporation-free storage of staining liquids, the other lid with an opening to allow the handle of accessory staining rack 9.161 341 to be inserted. Note: Xylene can cause etching after 2 days at room temperature.

Kartell



Width mm	Length mm	Height mm	PK	Cat. No.
74	95	63	1	9.161 340

3 Staining rack, PP

For use with staining jar 9.161 340. PP, with horizontal tray, holds 20 slides.

Kartell



Width mm	Length mm	Height mm	PK	Cat. No.
21.5	86	72	1	9.161 341

4 Staining jar, PMP (TPX®), Schiefferdecker pattern

Accepts 20 slides 76 mm x 26 mm (10 pairs back to back). Transparent. Complete with lid. Note: Xylene can cause etching after 2 days at room temperature.

Kartell



Width mm	Length mm	Height mm	PK	Cat. No.
65	76	45	1	9.161 352

5 Staining jar, PMP (TPX®), Hellendahl pattern

Accepts 16 slides 76 mm x 26 mm (8 pairs back to back). Transparent, with grooves. Complete with lid.

Kartell



Width mm	Length mm	Height mm	PK	Cat. No.
58	53.5	86	1	9.161 350



1 Staining troughs

Hellendahl pattern. Glass with lid.
Hold 16 slides, 76 x 26 mm.

Width mm	Length mm	Height mm	PK	Cat. No.
35	85	95	1	9.163 277
55	60	105	1	9.163 278

9.163 278 with flared top



2 Staining jar, glass, Coplin

Coplin pattern. Glass.

Diam. mm	Height mm	PK	Cat. No.
45	105	1	9.163 283



3 Staining troughs, Hellendahl extended, Soda-lime glass

- With lid
- For 16 slides à 76 x 26 mm

BRAND

Dimensions (W x D x H) mm	PK	Cat. No.
60 x 55 x 105	1	6.020 109



4 Staining cylinders

Soda lime glass. With drop-on cover.

Type	Diam. mm	Width mm	Length mm	Height mm	PK	Cat. No.
Round	40			85	1	9.163 273
Oval		25	40	85	1	9.163 274
Rectangular		20	40	85	1	9.163 275

1 Precision refractometers, basic model

Simple and precise optical instruments to analyse liquids and their solid contents. Models are equipped with an automatic temperature compensation device (ATC). Supplied with a plastic box and comfortable leather-type case.

Type	For	Measuring range	Accuracy	PK	Cat. No.
RSM/ATC	Salinity	0 - 100 ‰	1 ‰	1	9.801 249
RMA/ATC	Wine	0 - 25 % Vol	0,2 % Vol	1	9.801 252
		0 - 40 % Brix	0,2 % Brix		
RGA/ATC	Alcohol	0 - 80 % Vol	1 % Vol	1	9.801 256
RCS/ATC	Salinity	0 - 28 ‰	0,2 ‰	1	9.801 250
RPC/ATC	Freezing point	-50 - 0 °C	5 °C	1	9.801 251
	batteries	1,10 - 1,40	0,1		
RBO/ATC	Wine	0 - 140° Oe	1° Oe	1	9.801 254
		0 - 25° Babo	0,2° Babo		
		0 - 32 % Brix	0,2 % Brix		
RBB/ATC	Wine	0 - 25 % Vol	0,2 % Vol	1	9.801 255
		0 - 22° Be'	0,2° Be'		
		0 - 40 % Brix	0,2 % Brix		
RCZ/ATC		0 - 32 % Brix	0,2 %	1	9.801 200
RBC/ATC		0 - 10 % Brix	0,1 %	1	9.801 241
RLC/ATC		0 - 18 % Brix	0,1 %	1	9.801 242
RFC/ATC		28 - 62 % Brix	0,2 %	1	9.801 244
RPU		0 - 80 % Brix	1 %	1	9.801 246
RMM/ATC	Honey and jam	58 - 90 % Brix	0,5 % Brix	1	9.801 247
		38 - 43° Be'	0,5° Be'		
		17 - 27 water	1 % water		

Manual hand-held refractometers

Precision instruments for quick daily use. Various scales and functions ensure there is a suitable refractometer for every application area.

A.KRÜSS Optronic

Type	Measuring range	Accuracy	PK	Cat. No.
HRB32-T*	0 ... 32 % Brix	±0.2 % Brix	1	9.801 142
HRB90	0 ... 90 % Brix	±0.2 % Brix	1	9.801 150
HRND	nD 1.3330 ... 1.5170	nD ±0.0005	1	9.801 151
HRB92-T	58 ... 92 % Brix, 38 ... 43 °Baume, 12 ... 27 % water in honey	±1 % Brix, ±0.5 °Baume, ±1 % water in honey	1	6.290 771
HRB18-T	0 ... 18 % Brix	±0.1 % Brix	1	4.662 296
HRB82-T	45 ... 82 % Brix	±0.2 % Brix	1	4.662 319
HRKFZ-T	50 ... 0 °C, 1.10 ... 1.30 g/cm ³	±5 °C, 0.01 g/cm ³	1	4.662 320
HRS10-T	0 ... 10 ‰	±1 ‰	1	4.662 321
HRH30-T	12 ... 30 % water in honey	±0.1 % water in honey	1	6.311 908

*with automatic temperature compensation



Refractometers, hand-held, precision

For simple, manual measurement of concentrations and refractive indices of liquids. Hand-held, precision refractometers with focussing eyepiece, soft rubber eyecups (to reduce straylight ingress, also spectacle lenses do not slip off and are not scratched), case and conversion tables. Hand-held refractometers cannot be fitted with a thermostatic controller and so measurements have to be temperature compensated.

ATAGO

Models with extra code M: Basic model

Models with extra code T: with automatic temperature compensation (ATC)

Models with extra code α : with automatic temperature compensation (ATC) and protection class IP65

Models with extra code H: for hot samples, with prism made of tempered glass

Type	For	Measuring range	Accuracy	Minimum scale value	PK	Cat. No.
MASTER 53 α	Brix	0,0 - 53,0 % Brix	± 0.5 % Brix	0.5 % Brix	1	7.619 590
MASTER-S10 α	Sodium chloride	0,0 - 10,0 g/100 g	± 0.2 g/100 g	0.1 g/100 g	1	9.801 372
MASTER-S28 α	Sodium chloride	0,0 - 28,0 g/100 g	± 0.2 g/100 g	0.2 g/100 g	1	7.653 540
MASTER-20T	Brix	0,0 - 20,0% Brix	± 0.2 % Brix	0.1 % Brix	1	9.801 301
MASTER-53T	Brix	0,0 - 53,0 % Brix	± 0.5 % Brix	0.5 % Brix	1	9.801 472
MASTER-20M	Brix	0,0 - 20,0 % Brix	-	0.1 % Brix	1	6.235 710
MASTER-53M	Brix	0,0 - 53,0% Brix	-	0.5 % Brix	1	9.801 302
MASTER-S10M	Sodium chloride	0,0 - 10,0 g/100 g	-	0.1 g/100 g	1	9.801 370
MASTER-S28M	Sodium chloride	0,0 - 28,0 g/100 g	-	0.2 g/100 g	1	9.801 335
MASTER-S/Mill- α	Salinity, Sea water Spec. density	0,0 - 100,0 ‰ 1,000 - 1,070	± 2 ‰ $\pm 0,001$	1 ‰ 0.001	1	9.801 359
MASTER 500	Universal application	0,0 - 90,0 % Brix	-	1.0 % Brix	1	6.261 851
MASTER-BR	Freezing point coolant*	0 - 70%, 0 ... -50 °C	-	5 °C	1	9.801 348
MASTER-RI	Refractive index	1,435 - 1,520 nD	-	0.001 nD	1	9.801 360
HSR-500	Brix	0,0 - 90,0% Brix	-	0.2 % Brix	1	9.801 312
R-5000	Refractive index	1,333 - 1,520 nD	-	0.001 nD	1	9.801 313
HHR-2N	Honey	12,0 - 30,0% humidity	-	0.1 %	1	9.801 333
MASTER-20 α	Fruit juice, cutting oil	0,0 - 20,0 % Brix	± 0.2 % Brix	0.1 % Brix	1	6.230 298
MASTER-TA	Wine	0,0 - 25,0 % T.A., 0,0 - 40,0 % Brix	± 0.3 % T.A. ± 0.2 % Brix	0.2 % T.A. 0.5 % Brix	1	6.231 790
MASTER-OE	Wine	0 - 130 Oe 0,0 - 33,0 % Brix	± 2 Oe ± 0.2 % Brix	2 Oe 0.5 % Brix	1	7.970 129
MASTER-GOE	Wine	30 - 170° 0,0 - 40,0 % Brix	± 2 ° ± 0.5 % Brix	1° 0.5 % Brix	1	6.286 459
MASTER-KMW	Wine	0,0° - 27,0° 0,0 - 33,0 % Brix	± 0.5 ° ± 0.5 % Brix	0.5° 0.5 % Brix	1	6.286 460
MASTER-BAUME	Wine	0,0 - 21,0 Baume 0,0 - 40,0 % Brix	± 0.3 Baume ± 0.5 % Brix	0.2 Baume 0.5 % Brix	1	6.229 977
MASTER-80H	Brix	30,0 - 80,0 % Brix	± 0.5 % Brix	0.5 % Brix	1	6.230 295
MASTER-93H	Brix	45,0 - 93,0 % Brix	± 0.5 % Brix	0.5 % Brix	1	6.238 823
MASTER-100H	Brix	60,0 - 100,0 % Brix	± 0.5 % Brix	0.5 % Brix	1	7.652 042
MASTER-Honey/BX	Honey	12,0 - 30,0% humidity 58,0 - 90,0 %	± 0.2 % Brix	0.2 % Brix	1	6.286 461
MASTER-50H	Brix	0.0 - 50.0 Brix	± 0.5 % Brix	0.5 % Brix	1	6.234 218
MASTER-S/MiIM	Sodium chloride	0 - 100‰	-	1 ‰	1	6.242 307

*for Ethylene glycol and Propylene glycol

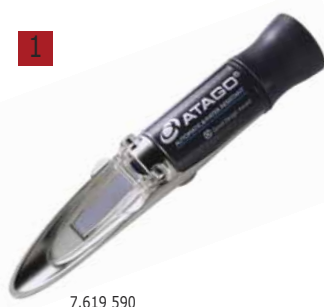
1

7.619 590

2

9.801 312

3

9.801 333

1 LLG-uniREFRACTO 5 pro NEW

LLG-uniREFRACTO 5 pro is a compact digital 3-scale handheld refractometer for measuring, e.g. Brix and refractive index of liquids. Two scales are pre-set to 0 - 95 % Brix and 1.33 - 1.54 RI, the third scale can be freely selected from more than 45 different scales, including Brix, refractive index, AdBlue®, °Baume, °Butyro, Ethylene Glycol %, Calcium Chloride % and specific gravity. All three scales can be freely selected and changed. The operation is quick and easy, calibration can simply be done with distilled water. The waterproof housing (IP 65) allows cleaning under running water.

- Easy switching between the three scales
- 4-digit LCD display
- Automatic temperature correction
- Sample plate made of stainless steel

Scope of supply: refractometer, protective cover

Specifications

Resolution:	0.1 % Brix/0.0001 RI
Accuracy:	±0.2 % Brix/±0.0003 RI
Operating temperature:	5 ... 40 °C
Measuring temperature sample:	5 ... 80 °C
Rel. Humidity:	< 95 %
Dimensions (W x D x H):	120 x 55 x 35 mm
Weight:	180 g
Power supply:	2 x AAA/LR03
IP code:	IP65
Warranty:	3 years



Type	PK	Cat. No.
LLG-uniREFRACTO 5 pro	1	6.263 632

Digital Hand-held Pocket Refractometer PAL series 2

For measurement of various high concentration samples such as jam, marmalade, jelly, honey, concentrated juice or acidity and salinity. Ingress Protection class IP 65 means that they can be cleaned under running water. Easily calibrated since "zero-setting" (calibration) is achieved using water. Temperature measurement with Automatic Temperature Compensation. Various models for a variety of applications, e.g. measurement of urine, salt, sugar. With data transmission via near field communication (NFC).

ATAGO

Specifications

Resolution:	Brix 0.1 %
Measurement accuracy:	Brix ±0.2 %
Ambient operating temperature:	10 to 40 °C
IP code:	IP 65
	dust- and waterproof
Power supply:	2 x AAA Batteries (incl.)
Dimensions:	55 x 31 x 109 mm
Weight:	100 g



9.801 375

Type	For	Measuring range	Temp. range °C	PK	Cat. No.
PAL-1	Brix	0.0 - 53.0 Brix	10 - 100	1	9.801 375
PAL-3	Brix	0.0 - 93.0 Brix	10 - 100	1	9.801 382
PAL-Alpha	Brix	0.0 - 85.0 Brix	10 - 100	1	9.801 362
PAL-RI	Refractive index	1.3306 - 1.5284nD	5 - 45	1	9.801 383
PAL-BX/RI	Brix + refractive index	0.0 - 93.0 Brix, 1.3306 - 1.5284nD	Brix: 10 - 100, nD: 5 - 45	1	6.231 591
PAL-22S	Honey, moisture	12.0 - 30 %	10 - 40	1	6.232 434
PAL-10S	Urine, spec. gravity (USG)	1000 - 1060 S.G.	10 - 35	1	6.236 094
PAL-UREA	Urine, concentration in water	0.0 - 55.0 %	10 - 40	1	6.258 218
PAL-DOG/CAT	Urine of animals, spec. gravity	DOG: 1000 - 1060 S.G. CAT: 1000 - 1080 S.G.	10 - 35	1	6.286 468
PAL-SALT	Salt	0.00 - 10.0 % g/100 g	5 - 100	1	6.283 064
PAL-03CS	Salt	0.00 - 28.0 % g/100 g	10 - 40	1	4.672 019
PAL-06S	Salinity, Sea water	0 - 100 ‰	10 - 40	1	6.272 489
PAL-34S	Ethyl alcohol (g/100 g)	0,0 - 45 %	10 - 35	1	6.251 197
PAL-91S	Ethylene glycol (V/V)	0,0 - 90,0 %	10 - 40	1	7.920 049
PAL-88S	Polypropylene, concentration (V/V)	0,0 - 90,0 %	10 - 40	1	7.910 093
PAL-PLATO	Beer	0,0 - 30,0 P	10 - 75	1	6.258 663
PAL-COFFEE (BX/TDS)	Coffee	0,00 - 25,00 % Brix 0,00 - 22,00 % TDS	10 - 100	1	6.270 239
PAL-39S	Hydrogen peroxid (g/100 g)	0,0 - 50,0 %	10 - 35	1	6.230 985
PAL-102S	Cutting oil + coolant	0.0 - 70.0	10 - 100	1	6.242 530

1



6.291 100

Digital Hand-held Pocket Refractometer PAL-BX/ACID series

NEW

ATAGO

For measuring Brix and Acidity of fruit.

The combination of Brix and Acidity determines fruit maturity and Brix to Acid ratio.

Easy and precise measurement without titration and chemicals.

Scope of supply: Refractometer, balance, 1 x beaker, 1 x measuring spoon

Specifications

Measuring range Brix:	0.0 ... 60.0 %
Accuracy Brix:	±0.2 %
Accuracy Acidity:	±0.10 % (0.10 .. 1 %) relative accuracy ±10 % (1.01 ... 8.80 %)
Temperature range:	10.0 ... 40.0 °C
Accuracy Temperature:	±0.1 °C
Dimensions (W x D x H):	55 x 31 x 109 mm
Weight:	100 g
Power supply:	2 x AAA batteries
IP code:	IP65

Type	For	Measuring range	PK	Cat. No.
PAL-BX/ACID F5 Master Kit	Multi Fruit	Multiple	1	6.291 099
PAL-BX/ACID1 Master Kit	Citrus	0.10 ... 8.80 %	1	6.291 100
PAL-BX/ACID2 Master Kit	Grape & Wine	0.10 ... 4.00 %	1	6.287 939
PAL-BX/ACID3 Master Kit	Tomato	0.10 ... 4.00 %	1	6.286 007
PAL-BX/ACID4 Master Kit	Strawberry	0.10 ... 3.50 %	1	6.291 101
PAL-BX/ACID5 Master Kit	Apple	0.10 ... 4.00 %	1	6.291 102
PAL-BX/ACID6 Master Kit	Banana	0.10 ... 0.60 %	1	6.291 103
PAL-BX/ACID7 Master Kit	Blueberry	0.10 ... 4.00 %	1	6.291 104
PAL-BX/ACID8 Master Kit	Kiwi	0.10 ... 3.00 %	1	6.291 105
PAL-BX/ACID9 Master Kit	Pineapple	0.10 ... 3.50 %	1	6.291 106
PAL-BX/ACID11 Master Kit	Plum	0.10 ... 4.00 %	1	6.291 107
PAL-BX/ACID14 Master Kit	Pear	0.10 ... 4.00 %	1	6.291 109
PAL-BX/ACID40 Master Kit	Coffee cherry	0.10 ... 1.90 %	1	6.291 110
PAL-BX/ACID91 Master Kit	Milk	0.10 ... 0.30 %	1	6.291 111
PAL-BX/ACID96 Master Kit	Yogurt	0.10 ... 3.00 %	1	6.291 112
PAL-BX/ACID101 Master Kit	Beer	0.10 ... 20.00 %	1	6.291 113
PAL-BX/ACID121 Master Kit	Sake	0.5 ... 25.00 %	1	6.291 114
PAL-BX/ACID181 Master Kit	Vinegar	0.5 ... 12.00 %	1	6.291 115

2



9.80 1376

Digital refractometers

ATAGO

Type PR-32α

Can be used to measure fruit juices, soft drinks, diluted soluble oils, aqueous cleaning solutions, etc.

Type PR-101α

Applications include measuring fruit juices, lemonade, coffee, diluted soluble oils and anti-freeze solutions.

Type PR-201α

It can be used for accurately measuring jams, concentrated fruit juices, coolants and similar products.

Type PR-301α

Especially suited to measuring jellies, liquid cane sugar, etc.

Type PET-109

This model is used for simply determining the concentration of ethyl alcohol, which is used in foods and for cleaning, cooling and other purposes.

Type PR-RI

A new Refractive Index model has been added to the popular long-selling "Palette Series".

It is suitable for measuring the refractive indices of liquid samples in pharmaceutical and chemical products.

Ambient temperature: 10 to 40 °C.

All models are with data transmission via near field communication (NFC).

3



9.801 369

Specifications (all types):

Measurement time:	3 seconds (Type PET-109, Measurement time: 2 seconds)
Sample volume:	0.1 ml
Power supply:	9V battery
Dimensions:	170 x 90 x 40 mm
Weight:	300g

Type	Measuring range	Graduations	Accuracy	Working Temp. range °C	PK	Cat. No.
PR-32α	0,0 - 32,0 % Brix	0,1 % Brix	± 0,1 % Brix	5,0 - 40,0	1	9.801 376
PR 101α	0,0 - 45,0 % Brix	0,1 % Brix	± 0,1 % Brix	5,0 - 40,0	1	9.801 377
PR-201α	0,0 - 60,0 % Brix	0,1 % Brix	± 0,1 % Brix	10,0 - 40,0	1	9.801 378
PR-301α	45,0 - 90,0 % Brix	0,1 % Brix	0,1 % Brix*	10,0 - 40,0	1	9.801 379
PET-109	0,0 - 45,0 % (w / w)	0,1 % (w / w)	± 0,5 % (w / w)	10,0 - 35,0	1	9.801 344
PR-RI	1,3306 - 1,4436 nD	-	± 0,0002 nD / 20 °C	5,0 - 45,0	1	9.801 369

*from 10 to 30 °C

10. Optical instruments and Microscopes

Refractometers/Hand held refractometers

Digital hand-held refractometers DR101-60/DR201-95/DR-301-95

Digital hand-held refractometer with two different scales, Brix and RI. Handling is fast and very easy, distilled water is used for calibration. With automatic temperature compensation.

A.KRÜSS Optronic

DR301-95 offers 2 additional user-defined scales and can be connected to a computer. Specialities: optional temperature compensation feature and upper and lower tolerance alarm.

Specifications	DR101-60 DR201-95 DR301-95
Temperature range:	10 ... 40 °C
Accuracy:	±0.5 °C
Temperature compensation:	10 ... 40 °C
Dimensions:	110 x 62 x 32 mm 130 x 80 x 40 mm 180 x 100 x 60 mm
Weight:	160 g 200 g 500 g
Power supply:	1.5 V battery 1.5 V battery 9 V battery, incl. AC adapter
IP code:	IP65 IP64 IP50

Type	Measuring range	Accuracy	Resolution	PK	Cat. No.
DR101-60	nD 1.330 ... 1.4419 0 ... 60.0 %Brix	nD ±0.0005 ±0.35 %Brix	nD 0.0001 0.1 %Brix	1	9.801 117
DR201-95	nD 1.3330 ... 1.5318 0 ... 95 %Brix	nD ±0.0003 ±0.2 %Brix	nD 0.0001 0.1 %Brix	1	6.230 350
DR301-95	nD 1.3330 ... 1.5318 0 ... 95 %Brix	nD ±0.00015 ±0.1 %Brix	nD 0.0001 0.1 %Brix	1	6.236 921

1



6.230 350

2



6.236 921

Digital portable refractometers Refracto 30PX/30GS

Portable device for determining refractive index and derived concentration values. Simple operation and fast results: the sample is either dripped onto the measuring cell or the instrument is immersed directly in the sample liquid. Suitable for laboratory and field measurements, e.g. in food processing or industry.

Mettler-Toledo Online

- Automatic temperature compensation
- Suitable for measurement of dark samples
- Backlit LCD display shows values and menu functions
- Calibration with water
- Memory for up to 1100 measured values, together with sample ID, unit, temperature compensation coefficient, time and date
- Individual formulas for calculation of user-defined concentration data can be defined in the device
- Measuring units: nD, nD temperature compensated, Brix% temperature compensated, HFCS42, HFCS55, °Baumé, °Oechsle (D, CH), °KMW (Babo), T.A. 1990, weight %, vol.-%, specific weight and freezing point (in °C or °F) for ethanol and NaCl, weight %, volume % and freezing point (in °C or °F) for ethylene glycol and propylene glycol, weight % and volume % for isopropyl alcohol, user-defined unit
- Values can be transferred to the PC via IR interface

Refracto 30PX: Optical glass measurement cell

Refracto 30GS: Sapphire measurement cell for larger measuring range and faster temperature compensation

Scope of delivery: Refracto 30PX/GS, pipette for sample handling, cleaning towels, operating instructions, flasks for sample and cleaning solutions, CD-ROM with software for data transmission, transport case

3



9.947 555

Specifications	Refracto 30 PX // Refracto 30 GS
Refraction range:	1.32 ... 1.50 // 1.32 ... 1.65
Refraction accuracy:	±0.0005
Refraction resolution:	0.0001
Brix range:	0 ... 85 %
Brix accuracy:	±0.2 %
Brix resolution:	0.1 %
Temperature range:	0 ... 40 °C
Temperature resolution:	0.1 °C
Dimensions (W x D x H):	62 x 187 x 63 mm
Weight:	250 g
Power supply:	2 x AAA 1.5 V (please order separately)

Type	PK	Cat. No.
Refracto 30PX	1	9.947 555
Refracto 30GS	1	9.947 556

1

6.266 906

Digital Refractometer RX-5000i/RX-5000i-Plus

ATAGO

The most accurate refractometer in the world is now even more stylish, smart, and functional. Featuring intuitive touch screen technology, the new RX-i series makes navigation and selection a breeze. The RX-5000i measures with the same accuracy level as the RX-5000alpha (± 0.03 % Brix and ± 0.00004 nD). The RX-5000i-Plus measures with the same accuracy level as the RX-5000alpha-Plus (± 0.010 % Brix and ± 0.00002 nD). The RX-i series come with newly added functions, such as USB flash drive and self-diagnosis capability. These products come standard with a 2 year warranty. The warranty period can be extended to 3 years if the product is registered with ATAGO. FDA 21 CFR Part 11 Software Included in Standard Delivery

Modes:

- Displays the measurement value once the sample reaches the target temperature
- Measures refractive index and temperature at fixed intervals and displays the estimated measurement value at the target temperature
- The thermo-module can be turned off. Without temperature control, the measurement value is displayed in 4 seconds after the START key is pressed
- Displays the measurement value once a certain level of sample stability is achieved.
- Only on the RX-5000i-Plus: Measuring of Low Brix Liquid Samples (such as teas), obtaining highly repeatable results (0.010 % Brix).

Specifications

Measurement range:	0.000 to 100.00 % Brix, 1.32420 to 1.58000 nD
Resolution	
RX-5000i:	0.01 % Brix, 0.00001 nD
RX-5000i-Plus:	0.005 % Brix, 0.00001 nD
Accuracy	
RX-5000i:	0.03 % Brix, 0.00004 nD
RX-5000i-Plus:	0.010 % Brix, 0.00002 nD
Working temperature:	5 to 75 °C
Output terminals:	USB, RS-232C
Power supply:	100 - 240 V, 50/60 Hz
Dimensions:	370 x 260 x 140 mm
Weight:	6.6 kg

Type	PK	Cat. No.
RX-5000i	1	6.266 906
RX-5000i-Plus	1	6.245 034

2

2 CO₂/Brix Monitor CooRe

NEW

ATAGO

Dissolved carbon dioxide monitor with three functions, piercing a hole in the container, measuring dissolved carbon dioxide and Brix.

- Easy operation with a press of button
- With auto measurement, results in 1.5 min
- Simultaneously measures CO₂ and Brix
- Requires only 100 ml of sample
- Can be operated by AC adapter or battery for mobile use
- USB port



Specifications

Measuring range Brix:	0.00 ... 20.00 %
Accuracy:	± 0.05 %
Measuring range CO ₂ :	0.000 ... 24.000 g/l
Measuring range pressure:	0.00 ... 10.000 bar
Accuracy:	± 1.0 %
Messbereich Temperatur:	0.0 ... 30.0 °C
Accuracy:	± 1 °C
Working Temperature	
Brix:	5.0 ... 30.0 °C
CO ₂ :	0 ... 25 °C
Dimensions (W x D x H):	405 x 210 x 450 mm
Weight:	13 kg
Power supply:	230 V, 50/60 Hz or 1 x Lithium battery
IP code:	IP 65

Type	PK	Cat. No.
CooRe	1	6.273 964

Digital Laboratory refractometers

The DR6000 refractometers work with hardly any service and are very quiet, good for long-term work in the lab. Very easy to operate due to an intuitive touch screen. Optional connections to printer, PC or network provide highest flexibility. High precision through integrated peltier thermostat (T-model). Flow measurement cells enable continuous measuring (TF-model). The devices are used wherever a substance in watery solutions has to be measured. Areas of usage: beverage, chemistry, pharma, food, paper, sewerage, textile, petrochemistry, cosmetics.

A.KRÜSS Optronic



9.801 102

Specifications

Interface: RS-232, USB, Ethernet
 Temperature range: 10 ... 80 °C
 Resolution: 0.1 °C
 Accuracy: 0.1 °C
 Measurement modes: Single, interval
 Scales: Refractive index (nD), concentration of sucrose, glucose, fructose and invert sugar (%Brix), user-defined
 Power supply: 90 ... 240 V, 47/63 Hz

Type	Measuring range	Accuracy	Resolution	PK	Cat. No.
DR6000	nD 1.3200 ... 1.5800 0 ... 95 %Brix	nD ±0.0001 ±0.1 %Brix	nD 0.0001 0.1 %Brix	1	6.239 384
DR6000-T	nD 1.3200 ... 1.5800 0 ... 95 %Brix	nD ±0.0001 ±0.1 %Brix	nD 0.0001 0.1 %Brix	1	6.237 965
DR6000-TF	nD 1.3200 ... 1.5800 0 ... 95 %Brix	nD ±0.0001 ±0.1 %Brix	nD 0.0001 0.1 %Brix	1	9.801 101
DR6100-T	nD 1.3200 ... 1.7000 0 ... 95 %Brix	nD ±0.0001 ±0.1 %Brix	nD 0.0001 0.1 %Brix	1	6.241 690
DR6100-TF	nD 1.3200 ... 1.7000 0 ... 95 %Brix	nD ±0.0001 ±0.1 %Brix	nD 0.0001 0.1 %Brix	1	6.235 892
DR6200-T	nD 1.32000 ... 1.58000 0 ... 95 %Brix	nD ±0.00002 ±0.02 %Brix	nD 0.00001 0.01 %Brix	1	9.801 102
DR6200-TF	nD 1.32000 ... 1.58000 0 ... 95 %Brix	nD ±0.00002 ±0.02 %Brix	nD 0.00001 0.01 %Brix	1	9.801 103
DR6300-T	nD 1.32000 ... 1.70000 0 ... 95 %Brix	nD ±0.00002 ±0.02 %Brix	nD 0.00001 0.01 %Brix	1	9.801 104
DR6300-TF	nD 1.32000 ... 1.70000 0 ... 95 %Brix	nD ±0.00002 ±0.02 %Brix	nD 0.00001 0.01 %Brix	1	9.801 105

Digital Laboratory refractometers Abbemat 3000/3100/3200



Anton Paar

The laboratory refractometers Abbemat are equipped with the most important refractometric concentration beams, whereby further methods can be installed. They are characterised by fast measurements with high accuracy and are maintenance-free. For Abbemat 3200 and 3100 the built-in temperature control unit regulates the temperature, while the Abbemat 3000 provides automatic temperature correction.

- Compact device according to DIN A 4 size
- Sample trough with smooth, easy to clean surface and optimal shape of the measuring area
- 5.8" touchscreen for clear presentation of the measurement results
- More than 200 additional scales available on request
- 3 years warranty



6.313 802

Specifications

Temperature accuracy: ±0.05 °C
 Light source: LED
 Wave length: 589 nm
 Sample volume: approx. 0.2 ml
 Interfaces: RS-232, 2 USB-interface, 1 serial USB-interface, ethernet printer, ethernet LIMS (Abbemat 3200)
 Scales: refractive index, brix, glucose, fructose, invert sugar, sucrose
 Dimensions (W x D x H): 228 x 300 x 94 mm
 Power supply: 100 ... 240 VDC, 50/60 Hz

Type	Measuring range	Accuracy	Resolution	Temp. range °C	PK	Cat. No.
Abbemat 3000	nD 1.30 ... 1.66 0 ... 100 %Brix	nD ±0.0001 ±0.05 %Brix	nD 0.0001 0.01 %Brix	Temperature correction	1	6.313 800
Abbemat 3100	nD 1.30 ... 1.66 0 ... 100 %Brix	nD ±0.0001 ±0.05 %Brix	nD 0.0001 0.01 %Brix	20 °C / 25 °C	1	6.313 801
Abbemat 3200	nD 1.30 ... 1.72 0 ... 100 %Brix	nD ±0.0001 ±0.05 %Brix	nD 0.0001 0.01 %Brix	15 ... 60 °C	1	6.313 802

1



1 Circulation thermostat PT31

The PT31 circulation thermostat is equipped with high performance functions. The device is ideally suited for applications requiring a temperature range at a constant level. The robust locking mechanism of the PT31 provides a sturdy connection and ensures constant temperature control of the medium.

A.KRÜSS Optronic

- Temperature control using Peltier technology
- Space-saving, sturdy design
- Suitable for operation with non-flammable liquids (water or water/glycol mixture)

Specifications

Temperature range:	8 ... 35 °C
Accuracy:	±0.2 °C
Resolution:	0.1 °C
Pump performance:	20 l/h
Max. pump pressure:	20 mbar
Cooling power:	20 W
Heating power:	30 W
Power supply:	100 ... 240 V AC, 50/60 Hz, 1.3 A
Dimensions (W x D x H):	108 x 145 x 199 mm
Weight:	1.5 kg

Type	PK	Cat. No.
PT31	1	9.841 515

2



2 Circulation thermostat PT80

NEW

The PT80 circulation thermostat is an extremely quiet, energy-efficient and handy device that has been specially developed for small temperature control tasks in the laboratory.

A.KRÜSS Optronic

Fast temperature control is also possible due to the low filling volume of only 250 ml. With an accuracy of ±0.1 °C, the PT80 is ideally suited to high laboratory standards for the temperature control of polarimeters and refractometers. The PT80 is also very well equipped for efficient and environmentally friendly cooling of condensers (e.g. Liebig or reflux condensers) in thermal separation processes on a laboratory scale.

- Circulation thermostat with Peltier technology
- Rapid temperature control and high temperature accuracy
- Extremely quiet and low-vibration operation
- Environmentally friendly, due to 50 % lower energy consumption and elimination of refrigerants
- Suitable for operation with non-flammable liquids (water or water/glycol mixture)

Specifications

Temperature range:	5 ... 80 °C
Accuracy:	±0.1 °C
Resolution:	0.1 °C
Pump performance:	60 l/h
Max. pump pressure:	110 mbar
Cooling power at 20 °C:	40 W
Heating power:	120 W
Power supply:	100 ... 240 V AC, 50/60 Hz, 2.5 A
Dimensions (W x D x H):	170 x 244 x 225 mm
Weight:	2.7 kg

Type	PK	Cat. No.
PT80	1	6.273 831

3

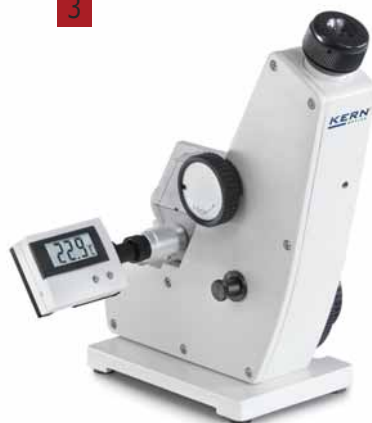

3 Abbe refractometer ORT 1RS

Universally applicable, analogue table-top Abbe refractometer for use in industry, pharmacy and laboratory.

Kern & Sohn

- Measurement of Brix and refractive index
- Compact and robust design
- For the measurement of liquids, solids and pasty samples
- With digital thermometer

Scope of supply:

Refractometer, calibration solution, calibration block, pipette, screwdriver, cleaning cloth, digital thermometer

Specifications

Measuring temperature:	20 °C
Dimensions (W x D x H):	180 x 90 x 240 mm
Weight:	1950 g

Type	Measuring range	Accuracy	PK	Cat. No.
ORT 1RS	0 ... 95 % / 1.3000 ... 1.7000 nD	0.1 % / 0.0002 nD	1	4.657 752

1 Abbe Refractometer Model RMT

Laboratory refractometer for precisely measuring liquids, solids, semi-liquids and powders. Optical refraction index and Brix scale reading system, with an excellent boundary line brightness and contrast. Prism with large windows, equipped with movable shrouds to keep out light. Focussable eyepiece.

Exacta Optech

Standard accessories: Calibrating glass prism, thermometer, dust cover, calibrating screw driver, wooden case.

Specifications

Range: 1.300 to 1.700 nD
0 to 95 % Brix
Precision: 0.001 nD
0.2 % Brix
Thermometer: 0 to 70°C

Type	PK	Cat. No.
RMT	1	9.801 257



Abbe refractometer AR4/AR2008

Classic refractometers for solids and liquids. With integrated digital thermometer. Optionally they can be combined with a thermostat.

A.KRÜSS Optronic

Specifications

Scales: Refractive index (nD),
Concentration of sucrose (%Brix)
Measuring ranges: nD 1.3000 ... 1.7200
0 ... 95 %Brix
Accuracy: nD ±0.0002
±0.1 %Brix
Light source: LED
Temperature range: 0 ... 99.9 °C

2 Abbe refractometer AR4

- Scales can be adjusted manually using the drive knob
- Measured value can be read via an eyepiece
- Temperature is shown on the LCD display
- Optionally: In combination with the circulation thermostat PT31 the temperature can be maintained at 20 °C or 25 °C

A.KRÜSS Optronic

Specifications

Dimensions (W x D x H): 100 x 190 x 270 mm
Weight: 2.5 kg
Power supply: 7.5 V

Type	Measuring range	Accuracy	Resolution	PK	Cat. No.
AR4	nD 1.3000 ... 1.7000 0 ... 95 %Brix	nD ±0.0002 ±0.1 %Brix	nD 0.0005 0.25 %Brix	1	9.801 110



3 Abbe refractometer AR2008

NEW

- Digital output of the measurement results
- With serial interface
- An automatic temperature compensation for the Brix scale can be optionally connected
- Optional: Measurement of the refractive index within the temperature range of 5 to 80 °C in combination with circulation thermostat PT80

A.KRÜSS Optronic

Specifications

Dimensions (W x D x H): 130 x 255 x 290 mm
Weight: 5 kg
Power supply: 115 V/230 V, switchable

Type	Measuring range	Accuracy	Resolution	PK	Cat. No.
AR2008	nD 1.3000 ... 1.7000 0 ... 95 %Brix	nD ±0.0002 ±0.1 %Brix	nD 0.0001 0.1 %Brix	1	6.055 199



10. Optical instruments and Microscopes

Refractometers/Benchtop refractometers

1



1 Digital Abbe refractometer, DR-A1-Plus

Very simple operation, where only the refraction boundary line has to be moved to the measurement cross hairs. The refractometer displays measurements directly (as a refractive index or in Brix (%)) in digits together with temperature. Measurements can be taken easily by anyone using this refractometer without taking an analogue scale reading in advance. Dispersive value can not be measured using this refractometer. ATAGO

Specifications

Measurement range: 1.3000 - 1.7100 nD
 0.0 - 100.0 Brix
 Resolution: 0.0001 nD
 0.1 % Brix
 Accuracy: 0.0002 nD
 0.1 % Brix
 Temperature range: 0 to 50.0 °C
 Power supply: a.c. adapter (100 to 240 V 50/60 Hz)
 Dimensions: 130 x 290 x 310 mm
 Weight: 6.0 kg

Type	PK	Cat. No.
DR-A1-Plus	1	6.283 092

2



2 Sucrose (Brix) Standards

Certified stabilized Sucrose (Brix) Standards. Reagecon

- ISO17025 accredited
- Uncertainty of measurement of 0.11 % for all Brix values at 20 °C
- Equivalent Nominal Refractive Index values from ICUMSA published tables reported on Certificate of Analysis
- Compatible with any brand of Refractometer
- 12 month shelf life
- Provided in high quality HDPE 15 ml dropper bottles

Brix %	Refractive Index at 20 °C	PK	Cat. No.
0	1.332986nD	1	6.264 212
5	1.340264nD	1	6.265 876
10	1.347824nD	1	6.257 923
15	1.355679nD	1	6.263 260
20	1.363842nD	1	6.264 889
30	1.381149nD	1	6.258 368
40	1.399860nD	1	7.660 408
50	1.420087nD	1	6.258 369
60	1.441928nD	1	6.265 875

3



3 Refractive Index standards

Certified standards with values expressed in Refractive Index (R.I) units nD. Reagecon

- ISO 17025 accredited with an uncertainty of measurement up to ±0.00014 nD units at 20 °C
- 12 month shelf life
- Aqueous based
- Compatible with any brand of refractometer
- Convenient high quality 15 ml HDPE dropper bottle

Refractive Index at 20 °C	PK	Cat. No.
1.34325nD	1	6.265 877
1.34782nD	1	7.658 877
1.37233nD	1	6.265 878
1.38115nD	1	6.258 375
1.39032nD	1	6.265 879
1.40978nD	1	6.265 142
1.42009nD	1	6.258 376
1.44193nD	1	6.265 880

Digital Refractometer/Polarimeter RePo

All-in-One refractometer and polarimeter hybrid unit. Only 3 ml sample is needed. With the press of a button, purity, international sugar scale, specific rotation and concentration can be displayed. Users can also set an upper and lower measurement limit. An indicator light alerts the user if a measurement value is within the limits.

ATAGO



RePo-1: can measure both brix and optical rotation of the sample.
 RePo-1 Package includes: Main unit, 100 ml beaker, 50 x Syringe Filters orange 45, 3 x 20 ml Syringes, 100 x Easy filter.

RePo-2: As RePo-1, additionally the RePo-2 also determines and displays the amount of fructose (%) within HFCS. The RePo-2 is ideal for various industries such as food and beverage, or sugar refining.

RePo-3: As RePo-1, additionally the RePo-3 also determines and displays the amount of invert sugar (%) derived from sucrose. The RePo-3 is ideal for various industries such as sugar refining.

RePo-4: As RePo-1, additionally the RePo-4 also determines and displays the amount of fructose (%) and honey moisture (%). The RePo-4 is ideal for total quality control of honey.

RePo-5: As RePo-1, additionally the RePo-5 can also display the refractive index (nD) of a sample. The RePo-5 is ideal for quality control in various industries such as fragrances, cosmetics, or pharmaceutical.

Specifications

Measurement range	
Angle of Rotation:	-5 to +5°
Brix (%):	0 to 85 %
Temperature:	15 to 40 °C
Resolution	
Angle of Rotation:	0.01°
Temperature:	0.1 %
Brix (%):	0.1 °C
Accuracy	
Angle of Rotation:	±0.1° (at 20 °C)
Brix (%):	±0.2 %
Temperature:	±1°C
Working temperature:	5 to 40 °C
Wavelength:	589 nm
Power supply:	4 x Size AAA alkaline battery
Dimensions:	101 x 160 x 38 mm
Weight:	325 g
IP code:	IP 67

Type	For	Measuring range	PK	Cat. No.
RePo-1	Sugar	-130 - +130°Z	1	6.266 905
RePo-1 Package	Sugar	-130 - +130°Z	1	6.286 462
RePo-2	Fructose	0,0 - 99,9 %	1	6.286 463
RePo-3	Inverted sugar	0,0 - 99,9 %	1	6.286 464
RePo-4	Fructose in Honey / Honey (moisture)	0,0 - 99,9 % / 13,0 - 30,0 %	1	6.286 465
RePo-5	Refractive index	1,3306 - 1,5050 nD	1	6.286 466

2 Polarimeter PL1

Simple and sturdy instrument to measure the rotation angle of optically active substances. The measure in 180° is directly readable on two mechanical dials.

Exacta Optech

Light source: LED lamp (589.3 nm)
 Polarimetric Tubes one 100 mm and one 200 mm
 Dust cover
 Optical Glass Windows (4 pcs)
 Rubber seals
 Fuses

Range: 0 to 180°
 Reading precision: 0.05°

Type	PK	Cat. No.
PL1	1	9.801 259



1

1 Polarimeter P1000-LED
NEW
A.KRÜSS Optronic

For basic lab applications and training, for example the experiment on saccharose inversion.

- Measurement of optical rotation according to the half-shade principle
- Manual adjustment on the scale
- Measurement results are read through an eyepiece and two noniuses
- High-performance LED with a service life of 100.000 h
- Tube chamber for tubes with a length of up to 220 mm
- Includes two measurement tubes with a debubbler
- Low-maintenance, cost-effective solution

Specifications

Scale:	Optical rotation (°)
Measuring range:	2 graduated circles (0 ... 180°)
Resolution:	1°
Accuracy:	0.05° (with nonius)
Light source:	1 LED with filter
Wavelength:	589 nm
Dimensions (W x D x H):	140 x 430 x 330 mm
Weight:	4.3 kg
Power supply:	110 ... 250 V, 50/60 Hz

Type	PK	Cat. No.
P1000-LED	1	6.059 874

2 Polarimeter P3000

Technologically high-quality polarimeter for standard applications for which a measurement accuracy of $\pm 0.01^\circ$ is sufficient and a temperature control can be omitted. Typically, the P3000 is used in the quality control of food industry.

A.KRÜSS Optronic

- Measurement of optical rotation
- Very short measurement time of approx. 1 s
- Easy, menu-driven adjustment
- Display of measured values in optical rotation or international sugar scale
- Suitable tubes for any type of sample
- Measurement up to an optical density of 3.0
- Temperature measurement with calibratable temperature sensor
- Reliable temperature compensation
- Chemical-resistant measurement tubes
- Compliance with GMP/GLP, pharmacopoeias [USP, BP, JP, Ph. Eur. (with tempering)], FDA, ISO, HACCP, OIML, ASTM, ICUMSA, NIST

Specifications

Scales:	Optical rotation [°], int. sugar scale [°Z]
Measuring range:	$\pm 90^\circ$ $\pm 259^\circ Z$
Resolution:	0.01° 0.01 °Z
Accuracy:	$\pm 0.01^\circ$ $\pm 0.01^\circ Z$
Measuring time:	approx. 1 s ($\pm 90^\circ$)
Light source:	1 LED with filter
Wavelength:	589 nm
Temperature range:	0 ... 99.9 °C
Resolution:	0.1 °C
Accuracy:	$\pm 0.2^\circ C$
Dimensions (W x D x H):	640 x 360 x 200 mm
Weight:	28 kg
Power supply:	100 ... 250 V, 50/60 Hz

Type	PK	Cat. No.
P3000	1	9.801 190

2

Spectrophotometer Libra S4+ Vis/S6+ Vis

These universal spectrophotometers are designed for a variety of applications in education, quality control and routine laboratories. They measure absorbance, transmission and concentration as well as simple kinetics. The large display allows to view the results in numerical as well as in graphical form. Stored methods can also be locked by using a pin protected password, as well as unlocked and deleted. The PVC (Print Via Computer) software is included with the instrument and providing the user with the option to transfer data directly to a PC. Data can be easily stored on a USB memory stick and analyzed at a later date.

Biochrom Ltd.

- Large LC display
- Interfaces for PC and USB stick
- Simple operation
- Small, lightweight device

1 Spectrophotometer Libra S4+ Vis

Ideal instrument for education and QC laboratories. Compact and lightweight for simpler applications.

Biochrom Ltd.

Up to 72 methods can be stored, providing a fast and easy way to recall frequently used methods.

Scope of supply:

Libra S4+, PVC software (Print Via Computer), data cable USB to PC, starter pack of 8 disposable cuvettes

Specifications

Optical system:	Single beam
Wavelength range:	325 ... 1100 nm
Accuracy:	±2 nm
Reproducibility:	±1 nm
Photometric range:	-0.300 ... 2.500 A
Accuracy:	< 0.002 A to 0A at 546 nm
Reproducibility:	< 0.002 A to 0A at 500 nm
Stray light:	< 1 %T at 340 nm
Light source:	Tungsten halogen
Outputs:	Export to PC with USB cable, USB memory stick
Dimensions (W x D x H):	325 x 225 x 133 mm
Weight:	1.6 kg
Power supply:	90-265 V, 50/60 Hz

Type	PK	Cat. No.
Libra S4+	1	4.668 614



2 Spectrophotometer Libra S6+ Vis

Fulfills the requirements of routine spectroscopy. Small and lightweight instrument with many functions. It also includes sorted methods for Bradford, BCA, Biuret and Lowry assays.

Biochrom Ltd.

Up to 90 methods can be stored, providing a fast and easy way to recall frequently used methods.

Scope of supply:

Libra S6+, PVC software (Print Via Computer), data cable USB to PC, starter pack of 8 disposable cuvettes

Specifications

Optical system:	Single beam
Wavelength range:	325 ... 1100 nm
Accuracy:	±2 nm
Reproducibility:	±1 nm
Photometric range:	-0.300 ... 2.500 A
Accuracy:	< 0.002 A to 0A at 546 nm
Reproducibility:	< 0.002 A to 0A at 500 nm
Stray light:	< 1 %T at 340 nm
Light source:	Tungsten halogen
Outputs:	Export to PC with USB cable, USB memory stick
Dimensions (W x D x H):	325 x 225 x 133 mm
Weight:	1.6 kg
Power supply:	90-265 V, 50/60 Hz

Type	PK	Cat. No.
Libra S6+	1	4.668 615



1

6.263 610

Spectrophotometer LLG-uniSPEC 2 and 4

High-quality and cost-efficient UV/VIS spectrophotometers for pharmaceutical, biochemical and clinical lab applications. Suitable for different measurement types such as kinetics, wavelength scans, quantitative analysis, multi-wavelength and DNA/Protein analysis.

Available in two versions:

LLG-uniSPEC 2 for standard routine measurements and uniSPEC 4 suitable for complex measurements e.g. required for quality controls. LLG-uniSPEC 4 features a small band width and a high wavelength accuracy. Both units can store and save 200 calibration curves. A pre-adjusted lamp design allows a fast and easy lamp replacement. Both lamps can be individually turned on/off to extend the durability. Both versions can be used either as stand-alone units or can be operated via a PC by using the supplied software.

- Single beam system, grid with 1200 lines/mm
- Silicon photodiode detector
- Parallel port for printer output
- USB port
- 4 position cell holder (10 mm) included
- Additional cell holders optionally available
- LCD display
- Deuterium and tungsten lamp
- Automatic wavelength adjustment

Scope of supply: LLG-uniSPEC 2 or 4 Photometer, software for connection to PC, 4 glass cells and 2 quartz cells.

2

6.263 620

Specifications

Optical System:	Single beam, Grating 1200 lines/mm, Silicon photodiode detector
Wavelength range:	190 to 1100 nm
Bandwidth:	2 nm // 1.8 nm
Wavelength accuracy:	±0.5 nm // ±0.3 nm
Wavelength repeatability:	0.3 nm // 0.2 nm
Wavelength setting:	automatic
Photometric accuracy:	±0.5 % T // ±0.3 % T
Photometric repeatability:	0.3 % T // 0.2 % T
Photometric range:	-0.3-3 A, 0-200 % T, 0-9999 C
Stability:	±0.002 A/h at 500 nm
Stray light:	≤0.1 %T // ≤0.05 %T at 220 nm, 360 nm
Data output:	USB port
Printer port:	parallel port
Display:	128 x 64 Dots LCD // 320 x 240 Dots LCD
Standard cell holder:	4-position 10 mm cell changer
Lamps:	D2 lamp and W lamp
Dimension (W x D x H):	460 x 360 x 225 mm // 625 x 430 x 206 mm
Weight:	18 kg // 28 kg
Power supply:	220 V/50 Hz or 110 V/60 Hz
Warranty:	3 years

LLG-uniSPEC 2 // LLG-uniSPEC 4

Type	Plug type	PK	Cat. No.
LLG-uniSPEC 2	EU	1	6.263 610
LLG-uniSPEC 2	UK	1	6.263 611
LLG-uniSPEC 4	EU	1	6.263 620
LLG-uniSPEC 4	UK	1	6.263 621

Accessories for Spectrophotometer LLG-uniSPEC 2/LLG-uniSPEC 4

Description	PK	Cat. No.
Cuvette holder for 4 cuvettes 50 mm and 100 mm	1	6.266 530
Cuvette holder, adjustable for 1 micro-cuvette	1	6.263 617
Tungsten lamp	1	6.263 615
Deuterium lamp	1	6.263 616
Circuit board power supply for LLG-uniSPEC 2	1	6.263 618
Circuit board photometer for LLG-uniSPEC 2	1	6.263 619
Spare keypad display for LLG-uniSPEC 2	1	6.263 625
Spare circuit board for LLG-uniSPEC 2	1	6.263 626
Cuvette holder, manual for 8 cuvettes, 10 mm	1	6.263 627
Foil keypad for LLG-uniSPEC 2	1	6.263 628

Spectrophotometer Models 6300 VIS/6305 UV-VIS

Models 6300 and 6305 are general purpose visible and UV/Visible range spectrophotometers which are suited to a wide range of applications in education and quality control.

Jenway



9.775 411

- Simple operation
- Versatile sampling system
- G.L.P. compliant
- Full interfacing capability
- Simple keypad and operating protocols designed to enable reliable operation by unskilled operators
- LCD gives simultaneous readout of wavelength and photometric result
- Error messages, prompts, mode indication and a choice of concentration units are presented in an easily understood format
- Cuvette holder allows 10 mm to 100 mm cells
- 3 year warranty

Supplied with: Mains lead, pack 100 disposable cuvettes, 10 x 10mm cell holder, PC Application Software on CD-ROM and operating instructions.

Various accessories e.g. sipper pump, cells, cell holders, cuvettes and lamps available on request.

Specifications

Optical system:	Single beam
Wavelength	
Range:	198 to 1000 nm (6305) 320 to 1000 nm (6300)
Resolution:	1 nm
Accuracy:	±2 nm
Bandwidth:	8 nm, 6 nm over UV range
Transmittance	
Range:	0 to 199.9 %
Resolution:	0.1 %
Stray light:	<0.5 % at 340 & 220 nm
Accuracy:	±1 %
Absorbance	
Range:	-0.300 to 1.999 A
Resolution:	0.001 A
Concentration	
Range:	-300 to 1999
Resolution:	0.1/1
Units:	ppm, mg/l, g/l, M, blank %
Outputs:	analogue (0 to 1999 mV d.c.) RS232 serial port
Light Source:	Xenon flash lamp module (6305) Tungsten halogen (6300)
Dimensions (W x D x H):	365 x 272 x 160 mm
Weight:	6 kg
Supply requirements:	230 V/50 Hz

Type	PK	Cat. No.
6300 VIS	1	9.775 412
6305 UV-VIS	1	9.775 411
Adjustable path length cuvette holder for 10 mm to 100 mm cuvettes	1	9.775 430





6.283 459

Scanning Spectrophotometers Series 72, VIS and UV-Vis

Scanning spectrophotometers from Jenway for measurements in the visible and UV range.

Jenway

Model 7200 (VIS): wavelength range of 335 to 800 nm with a spectral bandwidth of 7 nm.

Model 7205 (UV-VIS): wavelength range of 198 to 800 nm with a spectral bandwidth of 5 nm.

Both spectrophotometers are ideal for a variety of applications in education and routine testing in clinical, veterinary, pharmaceutical and QC laboratories.

The 72 series spectrophotometers offer measurement modes for single wavelength with basic absorbance and % transmittance; concentration determination (via reference standards or calibration curves with up to 6 standards), full spectrum scanning and kinetics for up to 3 simultaneous wavelength measurements.

The colour touchscreen user interface provides fast and easy set up and navigation of the instrument.

The 4" display allows full spectrum scans, quantitation curves and kinetics runs to be viewed easily.

The sample chamber lid can also be left open during measurements which is ideal for samples in tall test tubes.

Including two USB ports for data storage and printer connectivity.

Optional heated 10x10 mm cuvette holder for thermostated measurements at 37 °C.

More accessories available on request.

- Scanning diode array detector (DAD)
- Colour Touchscreen navigation
- Small footprint and lightweight
- Fast scan speed
- Multiple USB ports for data storage and printer connectivity
- 2 year warranty on the instrument

Specifications

Optical system:	Single beam
Wavelength Range:	
7200 (VIS):	335 to 800 nm
7205 (UV-VIS):	198 to 800 nm
	±2 nm
Resolution	±2 nm
Repeatability	
Spectral bandwidth:	
7200 (VIS):	7 nm
7205 (UV-VIS):	5 nm
Photometric range:	-0.300 to 2500 A
Accuracy:	±0.01 A at 1.0 A and 546 nm
Stability:	±0.005 A/h bei 0.04 A und 546 nm
Stray Light at 340 nm, %T:	< 1 % T acc. ANSI/ASTM E387-72
Concentration range:	±2500
Quantitation:	±2500
Kinetics:	15 bis 99999 s
Light source:	
7200 (VIS):	Tungsten halogen lamp
7205 (UV-VIS):	Xenon Lamp
Outputs:	2 x USB
Dimension (W x D x H):	212 x 422 x 120 mm
Weight:	2.8 kg
Power supply:	100-240 V, 50/60 Hz
Warranty:	2 Years

Description	PK	Cat. No.
Spectrophotometer 7200 (VIS)	1	6.283 459
Spectrophotometer 7205 (UV-VIS)	1	6.286 777
Cell holder, 10 x 10 mm	1	6.283 460

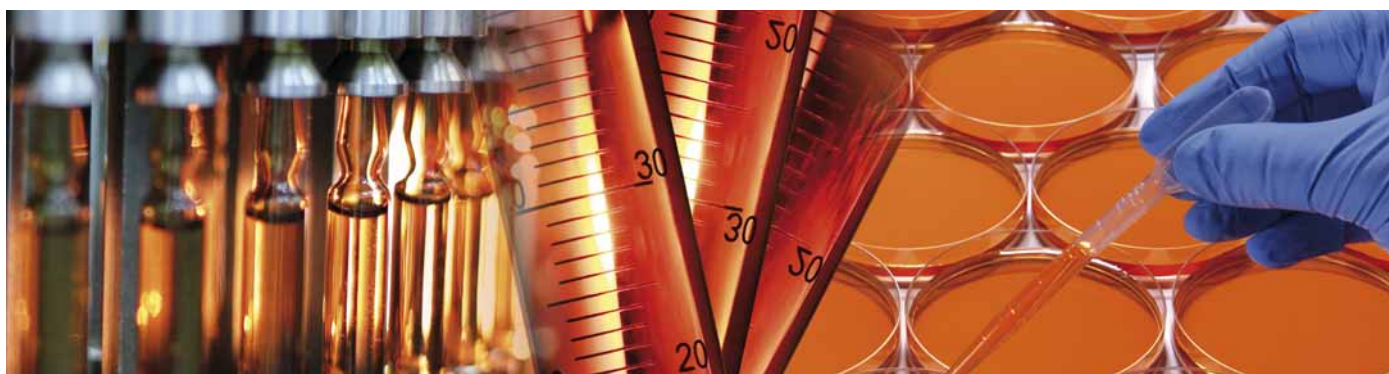

1 Spectrophotometer Model 6850

Double beam spectrophotometer with a variable spectral bandwidth. The highly stable optics and two detectors measure the sample and reference simultaneously optimising measurement accuracy. The 6850 has measurement modes for photometrics, concentration, multi-wavelength, spectrum scanning, kinetics, quantitation, DNA/RNA and protein analysis. Jenway Prism PC software is supplied as standard and offers additional functionality with preloaded methods for DNA/RNA and protein analysis, as well as extensive post-measurement tools, unlimited results saving and easy export of data. The 6850 double beam spectrophotometer is ideal for quality control, general research, pharmaceutical, biochemical and clinical laboratory applications. Installation Qualification and Operation Qualification (IQ/OQ) is available for the 6850. Jenway

- Double beam spectrophotometer with highly stable optics
- Variable spectral bandwidth 0.5, 1, 2, 4, 5 nm
- Analysis: Auto peaks and valleys, zoom, addition, subtraction, peak ratios, smoothing, area under curve, wavelength table, derivatives, overlay with PC software
- Integrated user interface
- USB port for data storage
- Conforms to European Pharmacopeia requirements
- Jenway Prism PC software included as standard
- 1 year warranty

Specifications

Optical system:	Double beam
Wavelength range:	190 to 1100 nm
Resolution:	0.1 nm
Accuracy:	±0.3 nm (at 0.5 and 1 nm bandwidth) ±0.5 nm (at 2, 4 and 5 nm bandwidth)
Reproducibility:	±0.2 nm
Photometric range:	-0.3 to 3.0 A 0 to 200 %T
Accuracy:	±0.002 A (0 to 0.5 A) ±0.3 % T (0 to 100 %T)
Reproducibility:	±0.001 Abs (0 to 0.5 Abs) ±0.002 Abs (0.5 to 1.0 Abs)
Resolution:	0.1 %T, 0.001 A
Stray light:	< 0.05 %T at 220 and 360 nm
Concentration range:	0 to 99999
Quantitation points:	Up to 3 wavelengths
Kinetics:	Up to 12 h with time intervals of 0.1, 0.2, 0.5, 1, 2, 5, 10 or 30 s
Spectrum:	Any range between 190 and 1100 nm
Scan Speed:	100 to 2000 nm/min
Scan interval:	0.1, 0.2, 0.5, 1, 2 or 5 nm
Light source:	Tungsten and Deuterium lamp
Outputs:	USB and parallel
Dimensions (W x D x H):	600 x 450 x 200 mm
Weight:	22 kg
Supply requirements:	230 V, 50/60 Hz

Type	PK	Cat. No.
6850	1	9.775 454



1

1 Spectrophotometer BioDrop DUO

Biochrom Ltd.

Biodrop Duo is a service-free bench-top instrument with a cuvette holder and a micro-volume sample port. The port enables absorption measurements in just 0.5 µl sample volume without cuvettes. Ideal for rapid serial measurements of DNA, RNA or proteins. The cuvette holder offers the possibility for measurements with larger volumes with conventional 10 mm cuvettes. The instrument has a large colour touchscreen and preprogrammed applications for the measurement of DNA, RNA, oligos and proteins. Generated data can be stored internally or transferred from the instrument using a USB flashdrive. The photometer can be operated with a PC and the supplied BioDrop Resolution Software via a USB connection. A built-in printer can also be selected for a complete stand-alone solution.

- Micro-volume sample port for minimum sample volume
- High-resolution, colour touchscreen
- Software package with preprogrammed methods for sample analysis
- USB connection for PC control and data export
- No calibration needed
- Easy cleaning of the sample port with a lint-free tissue

Specifications

Maximum concentration dsDNA:	2500 ng/µl
Detection limit:	1 ng/µl
Absorbance range:	0.3 to 2.5 A (0.3 A to 50 A, 10 mm equivalent)
Absorbance accuracy:	±0.005 A or 1 % of the reading, whichever is the greater at 546 nm
Spectral bandwidth:	5 nm
Stray light:	<0.5 %T at 220 nm and 340 nm using NaNO ₂
Wavelength range:	190 bis 1100 nm
Wavelength accuracy:	±2 nm
Light source:	Pulsed Xenon lamp
Dimensions (W x D x H):	260 x 420 x 185 mm
Weight:	3 kg
Power supply:	90-250 V, 50/60 Hz, max 50 VA

Description	PK	Cat. No.
BioDrop DUO	1	6.313 967
BioDrop DUO with printer	1	6.313 968

2

2 Spectrophotometer 7415 nano

Jenway

For accurate, fast and reproducible measurement of sample volumes from 0.5 µl to 5 µl. Programmed for the measurement of nucleic acid concentration and purity as well as protein assays. The direct application of the sample on the measuring head eliminates the need for cuvettes or sample dilution. Single measurements are performed in less than 6.5 seconds. Fast cleaning of the measuring optics simply by wiping off. Customized Android-based user interface to control the instrument, set measurement modes and retrieve results. Ethernet and USB interfaces for transfer of results, updates and printer connection as well as networking with cloud services.

- Ideal for DNA, RNA and protein determination
- Only 0.5 µl sample volume required
- For DNA concentrations up to 2 ng/µl
- 7" color touch screen
- Multilingual user interface
- 10 GB internal memory for methods and results
- 3 years warranty, also on the xenon lamp
- Stainless steel measuring head with quartz lens

Specifications

Wavelength range:	198 ... 1000 nm
Wavelength accuracy:	±2 nm
Spectral bandwidth:	5 nm
Absorbance accuracy:	±0.01 at 1.0 A
Transmittance range:	0 ... 199.9 %
Concentration range:	2 ... 6000 ng/µl dsDNA
DNA measurement modes:	dsDNA, ssDNA, RNA, Oligonucleotides, 260/280, 260/230, variable ratio
Protein measurement modes:	BCA, Bradford, Lowry, Biuret, direct UV
Light source:	Xenon lamp
Dimensions (W x D x H):	275 x 400 x 220 mm
Weight:	7.7 kg
Power supply:	100 ... 240 V, 50 ... 60 Hz

Type	PK	Cat. No.
7415 Nano	1	4.664 027

Densitometer DEN-1/DEN-1B

Compact and efficient benchtop densitometers for measuring turbidity of cell suspensions in a variety of life science applications. The densitometers are designed and factory calibrated to measure turbidity in the range of 0.3 to 5.0 McFarland units (DEN-1) 0.00 to 6.00 McFarland units (DEN-1B) with a small standard deviation. If required, they can deliver a wider measurement range (up to 15.00 McFarland units), but with a greater standard deviation.

Grant

Specifications

Light source:	light diode
Wavelength:	565 nm ±15 nm
Measuring range DEN-1:	0.3 to 15.0 McF
Measuring range DEN-1B:	0.0 to 15.0 McF
Standard deviation at 3.00 McF units:	±0.1 McF
Precision:	±3 %
Measurement time:	1 sec
Tubes diameter, external:	18 mm
Tube diameter with D16 adapter (included):	16 mm
Sample volume:	≥2 ml
Dimensions (W x D x H):	165 x 115 x 75 mm
Power supply:	12V (DEN-1B additionally 3 x AAA batteries)

Type	Description	PK	Cat. No.
DEN-1		1	6.234 576
DEN-1B		1	9.721 057
DEN MCF STDS	Set of 5 reference standards (0.5/1.0/2.0/3.0/4.0)	1	6.237 141



6.234 576



9.721 057

3 Densitometer WPA CO8000, Cell density meter

NEW

Biochrom Ltd.

The single-beam cell density meter measures the optical density at 600 nm using an LED. This LED light source has a long life span and requires little maintenance. The CO8000 is a robust, easy to use instrument dedicated to the measurement of the density of cells in suspension such as E.coli, yeast cells and other cell cultures. Once all measurements have been completed, up to 99 results can be displayed on the easy-to-read screen.

- Small, portable size
- Stores up to 99 results
- Rechargeable battery
- Easy to use, clean and sterilise
- No warm up time

Specifications

Optical system:	Single beam
Wavelength:	600 nm
Photometric range:	-0.3 ... 1.99 A
Accuracy:	±0.02 A at 1 A
Reproducibility:	0.02 A at 1 A in 10 mm cuvette
Stray light:	< 1 %T
Light source:	LED
Outputs:	Store, *Print, *Export to PC (*optional)
Dimensions (W x D x H):	150 x 180 x 60 mm
Weight:	0.6 kg
Power supply:	110-220 V, 50/60 Hz, 20 VA

Type	PK	Cat. No.
WPA CO8000	1	4.668 624



Accessories for Densitometer WPA CO8000

NEW

Biochrom Ltd.

Description	PK	Cat. No.
Adaptor set for 10 and 12 mm tubes	1	4.668 629
Serial cable	1	4.668 630

1 Microplate Reader EZ Read 400

The EZ Read range provides a comprehensive range of robust, fast and accurate microplate readers for absorbance assays. They come in several application focused models.

Biochrom Ltd.

Applications:

- Measures flat, round and v-bottomed 96-well microplates with standard SBS footprints
- Accurate measurements ensured by automatic lamp calibration prior to each reading
- USB 2.0 PC connection
- Create new plate layouts
- Add multiple assays to a plate
- Add multiple plates per analysis
- Easy to create new methods
- Select only the data you want for data reporting
- Windows 7 and 8 compatibility as well as older Windows OS from XP
- So easy you will not need to export your data into Excel

EZ Read 400 ELISA: ELISA assays

EZ Read 400 Research: ELISA, total protein and cell proliferation assays.

The EZ Read 400 microplate readers are PC-controlled using intuitive Galapagos software to simplify data acquisition and analysis.

Further EZ Read models on request.

Specifications

Detection System:	Single channel silicon photodiode filters
Optical System/Wavelength Selection:	400 to 750 nm
Wavelength Range:	0 to 3.3 OD
Measuring Range:	0.5 % from 1.0 OD at 450 nm
Accuracy:	0.25 % from 1.0 OD at 450 nm
Reproducibility/Precision:	0.25 % from 0.1 to 2.5 OD at 492 nm
Linearity:	25 seconds
Reading Speed:	315 x 182 x 435 mm
Dimensions (W x D x H):	100-240 V, 50/60 Hz, 1.5 A
Power supply:	

Type	UV filters nm	Measuring mode	PK	Cat. No.
EZ Read 400 Elisa	405, 450, 492, 620	NPP, OPD, Slow TMB, Turbo TMB, Ultra TMB	1	4.658 171
EZ Read 400 Research	405, 450, 492, 562, 570, 595, 620, 650	NPP, OPD, Slow TMB, Turbo TMB, Ultra TMB, Bradford, BCA, Lowry, MTT, XTT, Cell density	1	4.658 176

Further models can be found in our online shop.

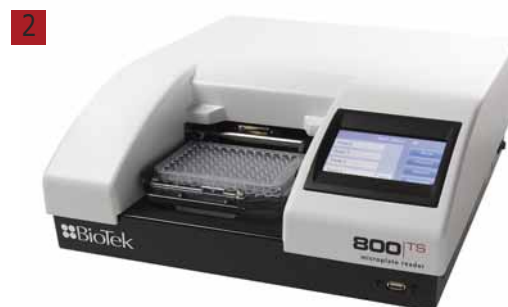

2 Microplate Reader 800 TS

The 800 TS with high-resolution colour touchscreen is designed for applications within the clinical and life science research laboratory. Its compact footprint and proven robust design makes it an ideal solution for many microplate-based assays.

BioTek Instruments

- Reliable 1-channel Absorbance Microplate Reader for endpoint, kinetic and well scanning read modes
- Compatible with 6 to 384-well formats
- Wavelength range: 400-750 nm or 340-750 nm
- Filter wheel capacity: 5 positions, up to 5 filters supplied
- Dynamic range: 0.0 to 4.0 OD, Resolution: 0.0001 OD
- Easy-to-use Gen5 Data Analysis Software for easy data collection, analysis, export and printing

Typical Applications: ELISA, protein quantification and cytotoxicity assays.

Type	Description	Filter nm	Measuring range nm	PK	Cat. No.
800TS	6- to 96-well plates, shaking	405, 450, 490, 630	400 ... 750	1	6.287 397
800TSUV	6- to 96-well plates, shaking	340, 405, 450, 490, 630	340 ... 750	1	6.287 398
800TSUVI	6- to 96-well plates, shaking and temperatur control (50°C)	340, 405, 450, 490, 630	340 ... 750	1	4.674 974
800TSNB	6- to 384-well plates, terasaki plates	405, 450, 490, 630	400 ... 750	1	4.674 970

1 Microplate Reader ELx808

High quality optics, fast measurement and superior incubation are the hallmarks of the ELx808 Absorbance Microplate Reader. These and other top features make it suitable for a wide array of applications, from endpoint ELISAs to kinetic cell growth studies.

BioTek Instruments



- 8-channel Absorbance Microplate Reader for endpoint, kinetic and linear well scanning read modes
- Compatible with standard 96-well, flat- or round-bottom plates
- Wavelength range: 380-900 nm; 340-900 nm (ELx808IU)
- Filter wheel capacity: 6 positions, up to 5 filters supplied
- Dynamic range: 0.0 to 4.0 OD
- Linear shaking and 4-Zone incubation to 50 °C (ELx808IU)
- Easy-to-use Gen5™ Data Analysis Software for rapid data collection, export and printing

Typical applications: ELISA, enzyme kinetics, protein assay, endotoxin (LAL) assays, cell growth studies and agglutination assays.

Type	Filter nm	Measuring range nm	PK	Cat. No.
ELx808	405, 450, 490, 630	380-900	1	6.283 100
ELx808IU	340, 405, 450, 490, 630	340-900	1	6.283 101

2 Micro-Volume Plate Take3

Nucleic acid and protein quantification is fast and easy with the Take3 Trio Micro-Volume plate, used in BioTek microplate spectrophotometer. Up to sixteen 2 µl samples can be measured at a time, without dilution or additional specialized equipment.

BioTek Instruments



- Compatible with Epoch, Synergy and Cytation readers from BioTek
- 16 microspots for 2 µl samples, 1 location for standard cuvette and 2 locations for BioCell™ measurements
- Pre-programmed DNA, RNA and protein protocols in Gen5 make quantification fast and easy
- Easy routine cleaning using laboratory wipe

Typical Applications: -Micro-volume DNA, RNA and protein quantification, Spectral scanning in micro-volume, cuvette or BioCell™.

Type	PK	Cat. No.
Micro-Volume Plate Take3	1	6.283 109

3 Microplate Spectrophotometer Epoch

Epoch™ is a monochromator-based microplate spectrophotometer that offers superior functionality at an accessible price. Controlled by the easy-to-use Gen Data Analysis Software, Epoch is designed for a wide range of applications, from nucleic acid and protein quantification to cell-based assays and ELISAs.

BioTek Instruments



- Spectrophotometer for single, dual and multi-wavelength measurements in endpoint and kinetic read, as well as spectral and well area scanning
- Wavelength range: 200 - 999 nm, selectable in 1 nm increments
- 6- to 384-well plate reading capability
- Xenon flash lamp to last the instrument's lifetime
- Robust housing design for longevity even under heavy usage
- Full Gen5 Data Analysis Software for data collection, export and printing included
- Compatible with Take3 Plate for direct nucleic acid and protein quantification in up to sixteen 2 µL samples at a time

Typical Applications: ELISA, nucleic acid quantification, DNA purity measurements, protein quantification, cytotoxicity, cell proliferation and spectral scanning.

Type	PK	Cat. No.
EPOCH	1	6.283 693

1

1 Microplate washer CAPPWash

NEW

AHN

The microplate washer is ideal for small scale work. It can be purchased individually or as a set, including all components necessary for the set up. The Two-in-One Design of Capp elisa plate washer offers two functions: add the washing solution to the well and aspiration of the used solution back to the waste collection bottle.

- Produced from stainless steel and polypropylene
- Resistant to aggressive chemicals

Scope of supply:

CAPPWash kit 8 channel: Plate washer 8 channel, vacuum pump 230V, bottle for washing solution (5 l), waste collection bottle (2 l), vacuum trap, silicon tubing (3 m)

CAPPWash kit 12 channel: Plate washer 12 channel, vacuum pump 230V, bottle for washing solution (5 l), waste collection bottle (2 l), vacuum trap, silicon tubing (3 m)

Type	PK	Cat. No.
CAPPWash 8 channel	1	4.671 829
CAPPWash 12 channel	1	4.671 830
CAPPWash kit 8 channel	1	4.671 831
CAPPWash kit 12 channel	1	4.671 832

2

2 Microplate washer Atlantis 2/4

NEW

Biochrom Ltd.

Microplate washer for 96-well plates with flexibility in washing options, simple operation and digitally controlled aspiration and dispensing pumps.

- 8-channel manifold
- Up to 50 wash programmes
- Auto rinse function prevents clogging
- Reduced aerosols due to cover and pumping technology
- Low noise, pressure-free aspiration and dispensing pumps
- Detachable plate carrier for easy cleaning

Scope of supply:

Atlantis 2: With 2 liquid lines, two 2 l wash-bottles, 2.5 l waste-bottle

Atlantis 4: With 4 liquid lines, four 2 l wash-bottles, 2.5 l waste-bottle

Maintenance kit: 2 x T 2.5 A spare fuses, 2 cleaning needles, tubing sets for all bottles, cleaning tool for needles, tubing set for manifold, spare tubing set for manifold

Type	PK	Cat. No.
Atlantis 2	1	7.971 823
Atlantis 4	1	6.315 207
Maintenance kit	1	6.315 189

3

3 Microplate Washer 50 TS

BioTek Instruments

The 50 TS Microplate Strip Washer is a truly flexible platform that provides washing capabilities unsurpassed in its class. As a welcome upgrade from manual processing, the 50 TS is ideally suited for academic, clinical and veterinary diagnostic laboratories.

- Compact and robust microplate strip washer with 8-, 12- or 16-tube washing manifold
- Compatible with 96/384 well plates or single strips
- Integrated syringe pump for precise control over all fluid flow rates
- Automatic buffer switching for up to 3 wash buffers
- Total programming control for all wash parameters, like number of cycles, dispense volume, dispense rate, aspiration rate, etc. via touchscreen user interface
- Programmable shaking duration and intensity
- Many built-in maintenance programs

Typical Applications: ELISA assays, Cell-based assays

Type	Description	PK	Cat. No.
50TS8	with 8-tube washing manifold, 96 well	1	6.287 399
50TS12	with 12-tube washing manifold, 96 well	1	6.287 400
50TS16	with 16-tube washing manifold, 96/384 well	1	4.674 978
50TS8V	with 8-tube washing manifold, 96 well, buffer switching option	1	6.287 401
50TS12V	with 12-tube washing manifold, 96 well, buffer switching option	1	6.287 402
50TS16V	with 16-tube washing manifold, 96/384 well, buffer switching option	1	4.674 973

Colorimeters, Lovibond® PFXi series

The PFXi series of spectrophotometric colorimeters introduces a unique concept in liquid colour control: RCMSI technology (Remote Calibration & Maintenance Service via internet).

Lovibond®

Users can benefit from the capability for remote calibration and servicing via the internet - eliminating any costs and time delays associated with servicing and guaranteeing compliance with standards. The PFXi range is supplied with a full range of colour scales for specific markets including, but not limited to, Petroleum, Edible Oils, Pharmaceuticals, Brewing and Honey. Users can upgrade scales remotely at any time. Every PFXi is supplied with colour control software for data analysis (LAN & USB cable provided). Optical glass cells, a certified glass calibration filter, a spare lamp and user instructions included. The PFXi-880 and -995 series are available with an optional integrated heater unit. (This is not available for the PFXi-195). This is a critical feature when dealing with materials such as fats and waxes where temperature needs to be maintained at a constant temperature +10°C above the "Cloud Point" of the material.

Please Note: CIE values and spectral data readings are standard on all the instruments listed below.



9.947 280

Type	For	Colour scale	PK	Cat. No.
PFXi-195/1	Chemicals & Industrial Oils	Pt-Co/Hazen/APHA, Gardner, Iodine	1	9.947 280
PFXi-195/2	Petroleum Oils & Waxes	Saybolt, ASTM Color, Pt-Co/Hazen/APHA	1	9.947 281
PFXi-195/4	Beers, Malts & Caramels	EBC (CIE & 430nm), ASBC (CIE & 430nm), Series 52	1	9.947 282
PFXi-195/5	Pharmaceutical Solutions	European & US Pharmacopoeia, Pt-Co/Hazen/APHA	1	9.947 283
PFXi-880/L	Oils and Fats	Lovibond® RYBN	1	9.947 284
PFXi-880/P	Fuels and Waxes	Saybolt, ASTM Color	1	9.947 285
PFXi-995	Transparent Samples	Lovibond® RYBN, AOCs-Tintometer®, Gardner, Saybolt, Kreiss, Hess-Ives, Hunter Lab, Iodine colour, Pt-Co/Hazen/APHA	1	9.947 286
PFXi-995/P	Petroleum Oils and Waxes	Saybolt Colour, ASTM Colour, Pt-Co/Hazen/APHA Colour, Gardner Colour, Lovibond® RYBN, IP Units	1	9.947 287

2 Cells W600

Cells made of optical glass or Borosilicate glass 3.3, 21 mm x 40 mm, for instrument Models Fs, PFXi/PFX195, 880, 950 and 995. (Note: PFXi/PFX-195 max. path length 50 mm).

Lovibond®

W600/OG/xx for unheated samples (up to 40 °C)
W600/B/xx for heated samples (up to max. 100 °C)

Further versions available on request.

Type	Path length	Material	PK	Cat. No.
mm				
W600/OG/10	10	optical glass	1	6.207 120
W600/OG/1/2"	12.7	optical glass	1	9.947 341
W600/OG/25	25	optical glass	1	6.241 234
W600/OG/1"	25.4	optical glass	1	9.947 342
W600/OG/33	33	optical glass	1	6.093 322
W600/OG/50	50	optical glass	1	6.207 119
W600/OG/100	100	optical glass	1	6.235 055
W600/OG/5/4"	133.35	optical glass	1	9.947 343
W600/B/10	10	Borosilicate glass 3.3	1	6.241 927
W600/B/1"	12.7	Borosilicate glass 3.3	1	9.947 344
W600/B/33	33	Borosilicate glass 3.3	1	6.086 921
W600/B/100	100	Borosilicate glass 3.3	1	6.253 940
W600/B/5/4"	133.35	Borosilicate glass 3.3	1	9.947 345



3 Cells W680

Cells made of optical glass 17 mm x 75 mm, for Comparator 2000+ and Comparator 3000 using unheated samples (up to 40 °C).

Lovibond®

Further versions available on request.

Type	Path length	PK	Cat. No.
mm			
WG680/OG/10	10	1	9.600 781
WG680/OG/33	33	1	6.093 260
W 680/OG/40	40	1	9.600 784
WG680/OG/20	20	1	4.672 166
WG680/OG/25	25	1	9.600 782
WG680/OG/50	50	1	4.672 157
W 680/OG/2,5	2.5	1	9.947 172
W 680/OG/5	5	1	9.947 173



1 Flame Photometer PFP7 and PFP7/C

Single channel, low temperature flame photometer for use in industry, medicine and education.
Can be operated with propane, butane, natural gas or liquid gas (LPG).
With built-in electronic flame failure safety system for operational safety.

Jenway

- Model PFP7 incl. Na, K, Ca, Ba and Li filters
- Model PFP7/C incl. Na, K and Li filters
- 3 year warranty

Supplied with: Na, K, Li filters (model PFP7/C), additionally Ba and Ca filter (model PFP7), connecting hoses and clips, compressor plug, drain trap, fuses and operating/service instructions

Specifications

Range PFP7: 0 ... 199.9 ppm

Range PFP7/C: 120 ... 160 ppm Na, 0 ... 10 ppm K

Limits of detection

Na/K: < 0.2 ppm

Li: < 0.25 ppm

Ca: < 15 ppm

Ba: < 30 ppm

Reproducibility: < 1 % (Coefficient of variation for 20 consecutive samples using 10 ppm Na set to a reading of 50)

Linearity: < 2 % (when concentration of 3 ppm Na/K and 5 ppm Li are set to a reading of 100)

Specificity: Interference from Na, K and Li equal in concentration to test element will be < 0.5 %

Recorder output: Nominal 1.00 V for a reading of 100.0

Air: 6 l/min at 1 Kg/cm² /14psi (oil and moisture free pressurised air)

Dimensions (W x D x H): 420 x 360 x 300 mm

Weight: 8 kg

Power supply: 190 ... 250 V, 50/60 Hz

Type	PK	Cat. No.
PFP7	1	9.309 409
PFP7/C	1	6.272 846
Air compressor	1	9.309 410



2 Accessories to Flame Photometer PFP7

Please Note: These products will only operate with the correct type of air compressor and gas regulator as specified below.

Jenway

Description	PK	Cat. No.
Air compressor	1	9.309 410
Butane regulator	1	9.309 411
Propane regulator	1	9.309 412
Water separator (small)	1	9.309 419
Water separator (large)	1	9.309 420
Dust cover	1	9.309 421
Minor spares kit	1	6.281 378
Major spares kit	1	6.285 678
Industrial standard 1000 ppm K	1	9.309 425
Industrial standard 1000 ppm Li	1	9.309 426
Industrial standard 3000 ppm Ba	1	9.309 427
Industrial standard 1000 ppm Na	1	9.309 428
Industrial standard 1000 ppm Ca	1	9.309 429
Calibration standard 500 ml (100 mmol/l sodium, 100 mmol/l potassium)	1	6.206 011
Calibration Standard 500 ml (140 mmol/l sodium, 5 mmol/l potassium)	1	6.235 605
Sodium filter	1	6.233 141
Potassium filter	1	6.252 007
Atomiser PFP7	1	6.232 237
Ignition electrodes	3	6.253 386

Flame Photometers FP8000 series



A.KRÜSS Optronic

Even the lowest concentrations of alkali and alkaline earth elements in aqueous solutions can be determined cost-effectively and user-friendly. Simultaneous measurement of the elements Na, K, Ca and Li in the laboratory and process analysis (others on request). Thanks to proven measuring methods and modern instrument electronics, the flame photometers achieve precise and reproducible measurement results in a matter of seconds with maximum operational reliability. Suitable for individual measurements, fully automatic measuring operation, continuous operation and use as a process instrument.

- Economic, user-friendly and durable solution for use in laboratory and process operation
- Simultaneous measurement of up to four alkaline and alkaline earth elements, depending on model up to 300 measurements per hour
- Maximum operational safety through intelligent security mechanisms
- Simple operation through touch screen and intuitive software
- To use with Popan/Butan (alkaline elements) and Acetylene (alkaline earth elements)
- Interfaces: 2 x USB, 1 x Ethernet, 1 x RS-232 for printer, FP8500 additionally: Upgrade 4 to 20 mA analogue, passive current interface
- Compliance with international norms and standards

Specifications

Measuring ranges:	
Na/K/Li	0.01 ... 4500 ppm
Ca	0.50 ... 4500 ppm
Calibration:	Linear with 2 standards Not-linear with 6-8 standards, cubic approximation
Drift:	1 % in 60 min
Reference:	Lithium guideline with 5 mmol/l Cäsium guideline on request

Type	Sample volume ml	Description	Resolution	Accuracy	PK	Cat. No.
			mg/l	± mg/l		
FP8400	2.5	manual sample feeding	0.001	0.01	1	6.311 904
FP8500	2.5	automatic sample feeding	0.001	0.01	1	6.311 905
FP8600	2.5	sample supply via sampler	0.001	0.01	1	6.311 906
FP8700	0.25	diluted sample supply, incl. sampler, diluter, mixer	0.010	0.10	1	6.311 907



2 Standards for Flame photometers

Suitable for calibration, control, IQ/OQ and method validation. Compatible with all Flame Photometry Instruments. Available as single element analytical standards (in ppm) or Multi-element clinical standards (in mmol/l). NIST traceable. HDPE bottles of 500 ml.

Reagecon

Type	Measuring range	PK	Cat. No.
Barium	1000 ppm	1	4.012 213
Barium	3000 ppm	1	6.210 154
Lithium	1 mmol/L	1	4.012 220
Lithium	1000 ppm	1	4.012 214
Potassium	1000 ppm	1	6.210 151
Sodium	1000 ppm	1	6.210 152
Calcium	1000 ppm	1	6.210 153
Sodium / Potassium	100 / 100 mmol/L	1	4.012 215
Sodium / Potassium	120 / 2 mmol/L	1	4.012 216
Sodium / Potassium	140 / 5 mmol/L	1	4.012 217
Sodium / Potassium	160 / 8 mmol/L	1	4.012 218
Sodium / Potassium	160 / 80 mmol/L	1	4.012 219
Rinse solution	-	1	6.286 180



Cells for spectrophotometer

High precision standard cells for routine analysis. Suitable for most spectral photometers, using rectangular cells. Available with cover or with stopper for a liquid-tight seal. Cover and stopper made of PTFE.

Starna Scientific

Glass types

Type G: Optical glass, 334 to 2500 nm

Type SOG: Special optical glass, 320 to 2500 nm

Type Q: Spectrosil® For UV Quartz glass, 190 to 2700 nm

Specifications

Windows parallel to: < 3 arcmin

Window polish: 60/40 scratch/dig

Window thickness: 1.25 mm

Window flatness to: < 4 Newton fringes

Standard Rectangular Cells

NEW

Starna Scientific

Type	Volume ml	Path length mm	External dimensions (W x D x H) mm	Internal width mm	Description	PK	Cat. No.
1/G/10	3.500	10	12.5 x 12.5 x 45	10	with cover	1	4.678 102
1/G/50	17.500	50	12.5 x 52.5 x 45	9.5	with cover	1	4.678 103
1/SOG/10	3.500	10	12.5 x 12.5 x 45	10	with cover	1	4.678 104
1/SOG/40	14.000	40	12.5 x 42.5 x 45	10	with cover	1	4.678 105
1/Q/1	0.400	1	12.5 x 3.5 x 45	10	with cover	1	4.678 106
1/Q/2	0.700	2	12.5 x 4.5 x 45	10	with cover	1	4.678 107
1/Q/5	1.700	5	12.5 x 7.5 x 45	10	with cover	1	4.678 108
1/Q/10	3.500	10	12.5 x 12.5 x 45	10	with cover	1	4.678 109
1/Q/20	7.000	20	12.5 x 22.5 x 45	10	with cover	1	4.678 110
1/Q/40	14.000	40	12.5 x 42.5 x 45	10	with cover	1	4.678 111
1/Q/50	17.500	50	12.5 x 52.5 x 45	9.5	with cover	1	4.678 112
1/Q/100	35.000	100	12.5 x 102.5 x 45	9.5	with cover	1	4.678 113
9/Q/10	1.400	10	12.5 x 12.5 x 45	4	with cover, semi micro cell	1	4.678 115
21/Q/1	0.400	1	12.5 x 3.5 x 55	10	with stopper	1	4.678 116
21/Q/2	0.700	2	12.5 x 4.5 x 55	10	with stopper	1	4.678 117
21/Q/5	1.700	5	12.5 x 7.5 x 48	10	with stopper	1	4.678 118
21/Q/10	3.500	10	12.5 x 12.5 x 48	10	with stopper	1	4.678 119
21/Q/20	7.000	20	12.5 x 22.5 x 48	10	with stopper	1	4.678 120
21/Q/40	14.000	40	12.5 x 42.5 x 48	10	with stopper	1	4.678 121
21/Q/50	17.500	50	12.5 x 52.5 x 48	9.5	with stopper	1	4.678 122
21/Q/100	35.000	100	12.5 x 102.5 x 48	9.5	with stopper	1	4.678 123
21/MS/Q/10	3.5	10	12.5 x 12.5 x 48	10	with stopper, stirring cell	1	4.678 124

1



4.678 110

2



4.678 115

3



4.678 124

Standard rectangular fluorometer cells

NEW

Starna Scientific

Type	Volume ml	Path length mm	External dimensions (W x D x H) mm	Internal dimensions (W x D x H) mm	Description	PK	Cat. No.
3/Q/10	3.500	10	12.5 x 12.5 x 45	10	with cover	1	4.678 114
23/Q/10	3.500	10	12.5 x 12.5 x 48	10	with stopper	1	4.678 125

4



4.678 114

5



4.678 125

Calibration - Qualification of spectrophotometers with the certified reference materials from Hellma Analytics

To maintain constant good measurement results, a regular review of the accuracy of the spectrophotometer is required. With the use of certified reference materials from Hellma Analytics, you make sure that your equipment qualifications meet the requirements of the pharmacopoeias and fulfill your internal quality requirements, at the same time you reach the international comparability of your measurement results. The certified reference materials (calibration standards) of the DIN EN ISO 17025 accredited Hellma Analytics calibration laboratory are traceable to the primary standards of NIST (National Institute of Standards and Technology) and meet the requirements of the major pharmacopoeias (e.g. EP, DAB, USP).

Your benefits:

- High quality of the measurement results
- International comparability of measurement results
- Meeting the requirements of the major pharmacopoeias (EP, DAB, USP)
- Results traceable to NIST primary standards
- 30 years warranty on the reference materials

Scope of delivery:

- Certified reference materials (Calibration Standards) in quality storage box
- DAkkS Calibration Certificate (DIN 17025)
- Handling guidelines



9.190 980



Certified reference materials for qualifying spectrophotometer as a complete set

Glass Filters 666-S000: For testing spectrophotometers. Photometric accuracy and wavelength accuracy in the visible spectral region.

Hellma Analytics

Liquid Filters 667.033-UV: For testing spectrophotometers according to European Pharmacopoeia, wavelength accuracy, photometric accuracy, stray light behaviour, resolution.

Type	Capacity	Material	Wave-length nm	PK	Cat. No.
666-S000	666-F1	Holmium Oxide Glass Filter	279, 361, 453, 536, 638	1	9.190 973
	666-F2	Neutral Density Glass Filter NG 11	440; 465; 546,1; 590; 635		
	666-F3	Neutral Density Glass Filter NG 5	440; 465; 546,1; 590; 635		
	666-F4	Neutral Density Glass Filter NG 4	440; 465; 546,1; 590; 635		
	666-F0	Empty Filter Mount			
667.003-UV	667.100-UV	Potassium Chloride + blank	198, 200 (certified)	1	9.190 980
	667.200-UV	Toluene in Hexane + blank	266, 269		
	667.305-UV	Potassium Dichromate in HClO ₄ + blank	235, 257, 313, 350, 430		
	667-UV5	Holmium Perchlorate in Perchloric Acid	241,15; 287,15; 361,5; 536,3		

Filters also available individually.

Check for spectral resolution

Hellma Analytics

Type	Description	Wave-length nm	PK	Cat. No.
667.200-UV	Calibration set according to European Pharmacopoeia, contains filter UV6, UV9		1	6.240 535
667-UV6	Liquid filter UV6, Toluene in n-hexane	266, 269	1	9.190 983
667-UV9	Reference filter UV9, n-hexane	-	1	6.231 555

Check the wavelength accuracy

Hellma Analytics

Type	Description	Wave-length nm	PK	Cat. No.
667-UV5	Liquid filter UV5, Holmium oxide in Perchloric acid	240 - 650	1	6.227 666
667-UV25EPUSP	Liquid filter UV25, Didymium in Perchloric acid	329 - 864	1	4.670 729
667-UV35	Liquid filter UV35, Rare Earth in Perchloric acid	201 - 252	1	4.670 730
667-UV45	Liquid filter UV45, Holmium oxide and Didymium in Perchloric Acid	240 - 870	1	6.286 793
666-F1	Glass filter F1, Holmium oxide	279 - 638	1	6.201 067
666-F7A	Glass filter F7, Didymium	270 - 340	1	7.612 486
666-F7W	Glass filter F7, Didymium	329 - 875	1	6.286 794



6.227 666

4.670 729

4.670 730

6.286 793

6.201 067

7.612 486

Check for photometric accuracy

Hellma Analytics

Type	Description	Wave-length nm	PK	Cat. No.
667-UV305	Calibration set acc. to European Pharmacopoeia (UV60, UV600, UV14)		1	7.626 372
667-UV350	Liquid filter calibration-Set, Niacin (UV506, UV512, UV518, UV524, UV599)	213 - 261	1	4.670 731
667-UV60	Liquid filter UV60, Potassium dichromate 60 mg/l	235 - 350	1	6.240 039
667-UV600	Liquid filter UV600, Potassium dichromate 600 mg/l	430	1	9.190 984
667-UV14	Reference filter UV14, Perchloric acid	-	1	6.240 040
666-F2	Neutral density glass filter F2, 0.25 absorbance	440 - 635	1	6.801 867
666-F3	Neutral density glass filter F3, 0.5 absorbance	440 - 635	1	6.801 332
666-F4	Neutral density glass filter F4, 1.0 absorbance	440 - 635	1	6.801 868
666-F7W	Glass filter F7, Didymium	329 - 875	1	6.286 795

Cells for Absorption Measurement, Vis-range

Hellma Analytics

Wavelength Range:

 260nm - 2500 nm
 320 nm - 2500 nm
 360 nm - 2500 nm

Optical material:

 HOQ 310H (UV)
 Special optical glass (OS)
 Optical glass (OG)

Type	Description	Capacity µl	External dimensions (W x D x H) mm	Internal width mm	Path length mm	optical material	PK	Cat. No.
macro		3500	12,5 x 12,5 x 45	9,5	10 (± 0,05)	UV	1	9.144 301
macro	PTFE lid	3500	12,5 x 12,5 x 45	9,5	10	OG	1	9.144 300
macro		7000	12,5 x 22,5 x 45	9,5	20	OG	1	9.144 302
macro		14000	12,5 x 42,5 x 45	9,5	40	OG	1	9.144 340
macro		17500	12,5 x 52,5 x 45	9,5	50	OG	1	9.144 350
semi-micro		1400	12,5 x 12,5 x 45	4	10 (± 0,05)	UV	1	9.144 361
semi-micro	PTFE lid	1400	12,5 x 12,5 x 45	4	10	OS	1	9.144 410
semi-micro	PTFE lid	7000	12,5 x 52,5 x 45	4	50	OS	1	9.144 450
semi-micro		1400	12,5 x 12,5 x 45	4	10	OG	1	9.144 360
micro	PTFE lid	700	12,5 x 12,5 x 45	2	10	OS	1	9.144 750

6
6 Micro Volume Analysis TrayCell

Fibre-Optic Micro Measuring Cell. Accessory for standard spectrophotometer for droplet analysis.

Hellma Analytics

Sample volume 0.7 µl to 10 µl.

Typical applications are:

- nucleic acid analysis.
- determination of the incorporation frequency of fluorescent dye labels (FOI).
- protein analysis (A280, BCA, Lowry etc.).
- all UV/Vis analysis utilising wavelength range 190 nm to 1100 nm.
- material: Quartz glass High Performance.

Please state the required cell centre height (8.5 mm, 15 mm or 20 mm) when placing your order!

TrayCell is supplied as standard with caps for both 0.2 mm and 1 mm light path.

Additional light path of 0.1 mm and 2 mm are available.

Capacity µl	Height mm	Path length mm	Centre height mm	PK	Cat. No.
0.7 to 10	68.5 / 75 / 80	0.2 / 1	8.5 / 15 / 20	1	6.224 913
0.7 to 10	53 / 59.5 / 64.5	0.2 / 1	8.5 / 15 / 20	1	6.230 433

Cells for Absorption Measurement, UV-range

Wavelength Range: 200 nm - 2500 nm.
Optical material: Quartz glass High Performance

Hellma Analytics



Type	Description	Capacity µl	External dimensions (W x D x H) mm	internal width (mm) / aperture (mm x mm/Ø)	Centre height	Path length	PK	Cat. No.
					mm	mm		
macro	Screw cap **	3500	12.5 x 12.5 x 56	9.5		10	1	6.801 219
semi-micro	PTFE lid	1400	12.5 x 12.5 x 45	4		10	1	9.144 460
semi-micro	PTFE lid	7000	12.5 x 52.5 x 45	4		50	1	9.144 465
semi-micro	PTFE lid *	1400	12.5 x 12.5 x 45	4		10	1	9.144 490
semi-micro	PTFE lid	1000	12.5 x 12.5 x 45	4	15.2	10	1	6.250 017
semi-micro	PTFE stopper	1400	12.5 x 12.5 x 46	4		10	1	9.144 730
semi-micro	PTFE stopper *	1400	12.5 x 12.5 x 46	4		10	1	9.144 372
micro	PTFE lid	700	12.5 x 12.5 x 45	2		10	1	9.144 751
micro	PTFE lid *	700	12.5 x 12.5 x 45	2		10	1	9.144 756
micro	PTFE lid	500	12.5 x 12.5 x 45	2	15.2	10	1	6.084 722
micro	PTFE lid *	500	12.5 x 12.5 x 45	2	15.2	10	1	6.076 641
micro	PTFE lid	400	12.5 x 12.5 x 40	2		10	1	9.144 758
micro	PTFE lid *	400	12.5 x 12.5 x 40	2		10	1	9.144 385

* = Measuring volume
*black side walls and base
**with silicone rubber seal and with ISO thread GL 14

Ultra micro cells for absorption measurement, UV-range, quartz glass High Performance

Quartz glass High Performance 200 - 2500 nm.
Type A: with PE stopper
Type B: open pipette tips

Hellma Analytics



Type	Path length	Centre height	External dimensions (W x D x H) mm	Aperture mm	Capacity µl	PK	Cat. No.
	mm	mm					
A	10	15	12,5 x 12,5 x 45	8x2	160	1	9.190 969
A	10	8,5	12,5 x 12,5 x 45	8x2	160	1	9.190 966
A	10	15	12,5 x 12,5 x 45	5x2	100	1	9.190 968
A	10	8,5	12,5 x 12,5 x 45	5x2	100	1	9.190 965
A	10	15	12,5 x 12,5 x 45	2,5x2	50	1	9.190 967
A	10	8,5	12,5 x 12,5 x 45	2,5x2	50	1	9.190 964
B	10	15	12,5 x 12,5 x 40	Ø 0,8	5	1	9.144 156
B	10	8,5	12,5 x 12,5 x 40	Ø 0,8	5	1	9.144 157

We can supply this
manufacturer's
whole
product range !



Photometers/Glass cuvettes



Macro cells for absorption measurement, UV-range, quartz glass High Performance

Quartz glass High Performance 200 - 2500 nm. Inside width 9.5 mm.
Base thickness 1.5 mm.

Hellma Analytics

Type A: with PTFE lid
Type B: with small glass lid
Type D: with PTFE stopper/from 40 mm with 2 PTFE stoppers

Type	Path length	External dimensions (W x D x H) mm	Capacity µl	PK	Cat. No.
	mm				
A	5	12,5 x 7,5 x 45	1750	1	9.144 205
A	10	12,5 x 12,5 x 45	3500	1	9.144 210
A	20	12,5 x 22,5 x 45	7000	1	9.144 220
A	40	12,5 x 42,5 x 45	14000	1	9.144 240
A	50	12,5 x 52,5 x 45	17500	1	9.144 250
B	1	12,5 x 3,5 x 45	350	1	9.144 201
B	2	12,5 x 4,5 x 45	700	1	9.144 202
C	100	12,5 x 102,5 x 45	35000	1	6.088 125
D	1	12,5 x 3,5 x 52	350	1	9.144 601
D	2	12,5 x 4,5 x 52	700	1	9.144 602
D	5	12,5 x 7,5 x 46	1750	1	9.144 605
D	10	12,5 x 12,5 x 46	3500	1	9.144 610
D	20	12,5 x 22,5 x 45	7000	1	9.144 620
D	40	12,5 x 42,5 x 46	14000	1	9.144 640



Macro cells for absorption measurement, VIS-range, special optical glass

Special optical glass 360 - 2500 nm. Inside width 9.5 mm. Base thickness 1.5 mm.

Hellma Analytics

Type A: with PTFE-Falzdeckel
Type B: with small glass lid
Type C: with regular glass lid
Type D: with PTFE stopper/from 40 mm with 2 PTFE stoppers

Type	Path length	External dimensions (W x D x H) mm	Capacity µl	PK	Cat. No.
	mm				
A	5	45 x 12,5 x 7,5	1750	1	9.144 105
A	10	45 x 12,5 x 12,5	3500	1	9.144 110
A	20	45 x 12,5 x 22,5	7000	1	9.144 120
A	40	45 x 12,5 x 42,5	14000	1	9.144 140
A	50	45 x 12,5 x 52,5	17500	1	9.144 150
B	1	45 x 12,5 x 3,5	350	1	9.144 101
B	2	45 x 12,5 x 4,5	700	1	9.144 102
D	10	46 x 12,5 x 12,5	3500	1	9.144 510



Macro cells for absorption measurement, NIR-range, quartz glass Extended Range

Quartz glass Extended Range, Wavelength range: 200 - 3500 nm.
Inside width 9.5 mm. Base thickness 1.5 mm.

Hellma Analytics

Type A: with PTFE lid
Type B: with small glass lid
Type D: with PTFE stopper/from 40 mm with 2 PTFE stoppers

Type	Path length	External dimensions (W x D x H) mm	Capacity µl	PK	Cat. No.
	mm				
A	5	45 x 12,5 x 7,5	1750	1	6.053 055
A	10	45 x 12,5 x 12,5	3500	1	6.086 375
A	50	45 x 12,5 x 52,5	17500	1	6.078 779
B	1	45 x 12,5 x 3,5	350	1	6.302 993
B	2	45 x 12,5 x 4,5	700	1	6.901 645
D	1	52 x 12,5 x 3,5	350	1	6.800 848
D	5	46 x 12,5 x 7,5	1750	1	6.072 791
D	10	46 x 12,5 x 12,5	3500	1	6.052 763

Cells for Fluorescence Measurement, Vis-range

Wavelength Range: 320 nm - 2500 nm
Optical material: Special optical glass

Hellma Analytics



Type	Description	Capacity µl	External dimensions (W x D x H) mm	Internal width mm	Path length mm	PK Cat. No.
macro	PTFE-lid	3500	12.5 x 12.5 x 45	10	10 x 10	1 9.144 760
macro	PTFE-stopper	3500	12.5 x 12.5 x 46	10	10 x 10	1 9.144 770

Cells for Fluorescence Measurement, UV-range

Wavelength Range: 200 nm - 2500 nm
Optical material: Quartz glass High Performance

Hellma Analytics

Type	Description	External dimensions (W x D x H) mm	Internal width (mm) / aperture (mm x mm/Ø)	Path length mm	Centre height mm	PK Cat. No.
macro	PTFE lid, 4 window	12.5 x 12.5 x 45	10	10 x 10		1 9.144 761
macro	PTFE stopper, 4 window	12.5 x 12.5 x 46	10	10 x 10		1 9.144 771
semi-micro	PTFE stopper **	12.5 x 12.5 x 49.5	4	10 x 4		1 6.080 511
micro	PTFE lid	12.5 x 12.5 x 45	2	10 x 2	20.0	1 6.081 483
micro	PTFE lid	12.5 x 12.5 x 45	2	10 x 2		1 9.144 801
ultramicro	PE stopper, 3 window	12.5 x 12.5 x 45	5 x 3	3 x 3	15.0	1 9.144 391
ultramicro	PE stopper, 3 window	12.5 x 12.5 x 45	5 x 3	3 x 3	8.5	1 9.144 390
ultramicro	PE stopper, 3 window	12.5 x 12.5 x 45	5 x 2	10 x 2	15.0	1 6.051 579
ultramicro	PE stopper, 3 window	12.5 x 12.5 x 45	5 x 2	10 x 2	8.5	1 6.510 380

**for magnetic stirrers



Cells for light scattering measurements, UV-range

Wavelength: 200 nm - 2500 nm
Optical material: Quartz glass High Performance

Hellma Analytics

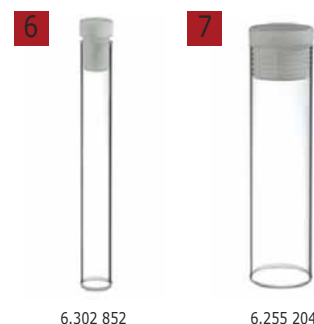

Description	Capacity µl	External dimensions (H x Ø) mm	Internal dimensions (H x Ø) mm	PK Cat. No.
PTFE-stopper	2800	75 x 10	74 x 8	1 6.302 852
PTFE-stopper, outer cylinder fire-polished	2800	75 x 10	74 x 8	1 6.073 106
PTFE-stopper	14000	75 x 20	74 x 18	1 6.255 204

Cells for Absorption Measurement, Flow-Through Measurement, UV-range

Wavelength Range: 200 - 2500 nm.
Optical material: Quartz glass High Performance

Hellma Analytics

Type	Path length	Capacity	Description	External dimensions (W x D x H)	Internal width	Centre height	PK	Cat. No.
	mm	µl		mm	mm	mm		
semi-micro	10	450	Supply and outlet tubes	12,5 x 12,5 x 45	11 x 4	15.0	1	6.051 845
semi-micro	50	2250	Supply and outlet tubes	12,5 x 52,5 x 45	11 x 4	15.0	1	6.080 156
semi-micro	50	2250	Supply and outlet tubes	12,5 x 52,5 x 38,5	11 x 4	8.5	1	6.242 811
semi-micro	5	195	2 screw terminals *	12,5 x 12,5 x 35	11 x 3,5	15.0	1	6.059 697
semi-micro	5	195	2 screw terminals *	12,5 x 12,5 x 35	11 x 3,5	8.5	1	6.300 696
semi-micro	10	390	2 screw terminals *	12,5 x 12,5 x 35	11 x 3,5	15.0	1	9.144 667
semi-micro	10	390	2 screw terminals *	12,5 x 12,5 x 35	11 x 3,5	8.5	1	9.144 666
micro	0,1	6	2 screw terminals *	12,5 x 12,5 x 35	17,5 x 3,5		1	9.144 660
micro	0,2	12	2 screw terminals *	12,5 x 12,5 x 35	17,5 x 3,5		1	6.206 587
micro	0,5	31	2 screw terminals *	12,5 x 12,5 x 35	17,5 x 3,5		1	9.144 662
micro	1	62	2 screw terminals *	12,5 x 12,5 x 35	17,5 x 3,5		1	9.144 664
micro	2	124	2 screw terminals *	12,5 x 12,5 x 35	17,5 x 3,5		1	9.144 663

* M 6 x 1 and FEP tubes (outside diameter 1.9mm, inner diameter 1.1mm, length 500mm)

1



6.080 156

2



9.144 667

3



9.144 664

4



6.266 794

Flow-through cells with two optical paths lengths, Absorption and Fluorescence Measurement

Wavelength Range: 200 nm - 2500 nm
Optical material: Quartz glass High Performance

Hellma Analytics

Type	Path length	Capacity	External dimensions (W x D x H)	internal width (mm) / aperture (mm x mm/Ø)	Centre height	PK	Cat. No.
	mm	µl		mm	mm		
semi-micro*	5 x 10	550	35 x 12.5 x 12.5	11 x 6/11 x 5	15.0	1	6.267 923
semi-micro*	5 x 10	550	35 x 12.5 x 12.5	11 x 6/11 x 5	8.5	1	6.266 794
semi-micro	2.5 x 5	140	35 x 12.5 x 12.5	11 x 4/11 x 2.5	15.0	1	4.658 278
semi-micro	2.5 x 5	140	35 x 12.5 x 12.5	11 x 4/11 x 2.5	8.5	1	6.286 789
semi-micro	1.5 x 3	50	35 x 12.5 x 12.5	11 x 2.5 /11 x 1.5	15.0	1	6.280 788
semi-micro	1.5 x 3	50	35 x 12.5 x 12.5	11 x 2.5 /11 x 1.5	8.5	1	6.286 790
semi-micro	1 x 10	110	35 x 12.5 x 12.5	11 x 6/11 x 1	15.0	1	6.280 645
semi-micro	1 x 10	110	35 x 12.5 x 12.5	11 x 6/11 x 1	8.5	1	6.286 791
semi-micro*	2 x 10	220	35 x 12.5 x 12.5	11 x 6/11 x 2	15.0	1	4.658 277
semi-micro	2 x 10	220	35 x 12.5 x 12.5	11 x 6/11 x 2	8.5	1	6.286 792

* For fluorescence measurement

1 LLG-Disposable plastic cells, PS

The shape and narrow wall thickness of the cuvettes enable an excellent heat transfer resulting in constant sample temperatures during photometric measurements.

- Cavity sorted
- Glass clear polystyrene (PS)
- Applicable wavelength range 340 nm to 900 nm
- Very low variation of extinction values
- Excellent optical transmission range
- Path length 10mm
- Overall dimensions 12.5 mm x 12.5 mm x 45 mm
- Styrofoam racks: 100 cuvettes in a styrofoam box with cover

1



Description	Capacity ml	Path length mm	Operating range nm	Material	PK	Cat. No.
Macro	4.0	10	340 to 900	PS	100	9.406 011
Semi-micro	1.6	10	340 to 900	PS	100	9.406 012

2 Disposable cuvettes

Disposable cuvettes for spectroscopy, in optical-quality PS and UV grade PMMA with optical windows for optimum transmittance when using wavelengths from 340nm to 800 nm (PS) and from 280 nm to 800 nm (PMMA). Moulding and quality control determine the reproducibility of cuvettes. Kartell cuvettes are strictly controlled and variations should be within the range ±1% absorption. This is the vital when batch analysis is being undertaken. Dust proof packaging: 100 pcs in expanded polystyrene box with lid, 5 boxes in inner carton and 12 inner cartons (60 boxes) per case.

Kartell

2



Description	Capacity ml	Path length mm	Material	PK	Cat. No.
Standard cuvettes	4.5	10	PS	100	9.406 431
Semi-micro cuvettes, low form	1.5	10	PS	100	9.406 432
Semi-micro cuvettes, high form	2.5	10	PS	100	9.406 433
Standard cuvettes, 4 clear faces	4.5	10	PS	100	9.406 434
Standard cuvettes	4.5	10	PMMA	100	9.406 435
Semi-micro cuvettes, high form	2.5	10	PMMA	100	9.406 436
Semi-micro cuvettes, low form	1.5	10	PMMA	100	9.406 437
Standard cuvettes, 4 clear faces	4.5	10	PMMA	100	9.406 438

3 Accessories for standard and semi-micro cuvettes

Kartell

3



Description	Material	Length mm	Diam.	PK	Cat. No.
Disposable stirrer	PS	90	3	100	9.406 439
Caps for cuvettes	PE-LD			1000	9.406 440
Cuvette holder for 12 cuvettes	PE			1	9.406 441

VIS cuvettes Eppendorf®, PMMA

The Eppendorf® Vis Cuvettes are disposable cuvettes made of clear plastic with a light transmission of 300 nm to 900 nm. They are the perfect tool for applications outside of the UV range, for example, colorimetric protein assays (Bradford, Lowry, etc.), determining of the optical density of bacterial cultures (OD600 methods), kinetic and fluorescence measurements. Based on the volume you would like to measure, you can select semi-micro or macro cuvette.

Eppendorf AG

4



6.265 212

5



6.265 213

Description	Capacity µl	Path length mm	Operating range nm	Material	PK	Cat. No.
Macro	4500	10	300 -900	PMMA	1000	6.265 212
Semi-micro	3000	10	300 -900	PMMA	1000	6.265 213



1 Macro and semi micro cuvettes

Sorted by mould cavity number. PMMA or PS.

BRAND

Quality characteristics:

- Minimal extinction value variation.
- Optically perfect transmission range
- Recessed window, to protect against scratches
- Arrow head marking shows the direction of transmission.

Advantages to user:

- Ideal for kinetics measurements
- 1000 cells from the same cavity in each pack
- Practical packaging: clear, re-closable.

Polymethylmethacrylate (PMMA) cuvettes

Typical operating range: from 300 nm to 900 nm.

Standard deviation at 320 nm ± 0.004 extinction units.

Polystyrene (PS) cuvettes

Typical operative range: from 340 nm to 900 nm.

Standard deviation at 360 nm $\leq \pm 0.005$ extinction units.

Macro cell with 4 optical windows, PS/UV-transparent

Particularly suitable for fluorescence spectroscopy. The UV version can be used from a wavelength of 230 nm and shows minimal autofluorescence. Standard deviation: Cuvettes of Polystyrene (PS) at 360 nm $\leq \pm 0.005$ extinction units, cuvettes UV-transparent at 240 nm $\leq \pm 0.007$ extinction units and at 300 nm $\leq \pm 0.005$ extinction units.

Dimensions: 12.5 mm x 12.5 mm x 45 mm
 Window: Macro cell 10 mm x 35 mm
 Semi micro cell 4.5 mm x 23 mm

Description	Volume ml	Path length mm	Operating range nm	Material	PK	Cat. No.
Macro	2.5 to 4.5	10	300 to 900	PMMA	100	9.406 111
Semi-micro	1.5 to 3.0	10	300 to 900	PMMA	100	9.406 115
Macro	2.5 to 4.5	10	340 to 900	PS	100	9.406 110
Semi-micro	1.5 to 3.0	10	340 to 900	PS	100	9.406 114
Macro, 4 optical windows	2.5 to 4.5	10	340 to 900	PS	100	6.280 982
Macro, 4 optical windows	2.5 to 4.5	10	340 to 900	PS	500	6.280 981
Macro, 4 optical windows	2.5 to 4.5	10	230 to 900	UV-transparent	100	6.280 680
Macro, 4 optical windows	2.5 to 4.5	10	230 to 900	UV-transparent	500	6.280 980



2 Macro and semi micro cuvettes, plastic

NEW

Ratiolab

For photometric measurements even in the UV range.

- Applicable wavelength range 220 to 900 nm
- Low variation of extinction values
- Good optical transmission range
- Sorted by mould cavity number

Scope of supply: 100 netidentical cuvettes in styrofoam box with a resealable cover

Description	Nominal capacity ml	Operating range nm	Path length mm	Dimensions (W x D x H) mm	PK	Cat. No.
Macro	4.0	220 ... 900	10	12,5 x 12,5 x 45	100	6.225 579
Semi-micro	1.6	220 ... 900	10	12,5 x 12,5 x 45	100	6.243 404



1 Plastic disposable UV-Cuvettes for the UV/VIS range

BRAND

UV-transparent plastic Brand cuvettes replace fragile glass or quartz cuvettes in many applications that were previously beyond the range of plastic cuvettes. Designed for single use, they eliminate time-consuming washing, and the cross-contamination risk associated with washing and re-using cuvettes. Their very high chemical resistance allows use with most polar solvents, acids and alkalis (e.g. Acetone, Butanone, DMF, hydrochloric acid). The UV-cuvette micro has a working range from 230 nm - sample volumes as small as 70 µl are sufficient. The UV-Cuvette is also available in macro and semi-macro sizes for applications from 230 nm to 900 nm.

- Specially designed for photometric determination of proteins, ssDNA, dsDNA, TNA and oligonucleotides in the UV range.
- Ideally suited for measurements at 260 nm, 280 nm and in the visible range.
- Two different centre heights (8.5 mm and 15 mm) allow use in most commercial spectrophotometers without adapters (for more information please visit the Brand website, www.brand.de).
- Round caps provide a tight seal and allow storage of samples at -20 °C.
- Coloured caps are available for easy sample identification.
- Grouped by mould cavity number to minimize extinction value variation.

The UV cuvette is also available as a macro and semi-microscope cuvette for analyzes from 230 to 900 nm.

Made of plastic for the UV/VIS range. For analyzes from 230 to 900 nm

- Compatible with most polar solvents, as well as acids and alkalis (eg acetone, butanone, DMF, concentrated HCL, etc.)
- Ideal for the determination of proteins, DNA, RNA
- number-sorted to reduce extinction deviations
- Verified windows to protect against scratches



Description	Capacity	Path length	Operating range	PK	Cat. No.
	µl	mm	nm		
UV micro cuvette (centre height 8.5 mm)	70 - 850	10.0	230 - 900	100	9.406 120
UV micro cuvette (centre height 8.5 mm)	70 - 850	10.0	230 - 900	500	9.406 121
UV micro cuvette (centre height 15 mm)	70 - 550	10.0	230 - 900	100	9.406 122
UV micro cuvette (centre height 15 mm)	70 - 550	10.0	230 - 900	500	9.406 123
Cap for UV micro cuvette, blue				100	9.406 124
Cap for UV micro cuvette, yellow				100	9.406 125
Cap for UV micro cuvette, green				100	9.406 126
Cap for UV micro cuvette, orange				100	9.406 127
UV macro cuvette	2.5 ml - 4.5 ml	10.0	230 - 900	100	9.406 119
UV semi-micro cuvette	1.5 - 3.0 ml	10.0	230 - 900	100	9.406 118

2 3 UV cuvette UVette®

Eppendorf AG

The plastic material of the UVettes® provides a transparency range of 220 nm to 1600 nm. It is possible to carry out measurements in the UV range as well as the entire VIS range.

- Suitable for measuring small volumes, min. 50 µl
- Individually blister-packed for sterile work
- DNA-/RNase- and protein-free
- Choice of two optical path lengths: 2 mm and 10 mm
- UV- and VIS-transparent between 220 nm and 1600 nm
- Volume markings at 500 µl and 1000 µl
- Total transparent material with outstanding surface properties
- Optimal filling guaranteed by tapered cuvette base
- Recessed optical window prevents scratches
- Self-standing design
- Marking possible on frosted gripping surface
- Optimal use in BioPhotometer and in most common spectrophotometers, using adapters.

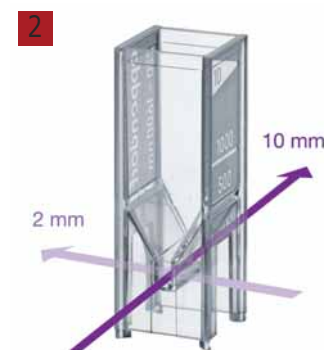

Description	PK	Cat. No.
UVettes®, 80 x individually wrapped, disposable cells for direct use in BioPhotometer, path length 2 and 10 mm	80	9.409 392
UVette® routine pack, Eppendorf Quality, path length 2 and 10 mm	200	9.409 398
Starter kit, 80 x UVettes® + 1 universal adapter for photometers/spectrophotometers with beam centre height of 15 mm, convertible	80	9.409 397

1

1 HELLMANEX® III liquid
Cleaning:

HELLMANEX® III is an alkaline liquid concentrate used for the highly effective cleaning of glass or silica cells and other sensitive optical components. Laboratory equipment made of glass, quartz, sapphire and porcelain can also be cleaned using the solution.

Hellma Analytics
Characteristics:

Hellmanex® III significantly reduces the surface tension of water. The removal of dirt particles is also assured by the good wetting action of a Hellmanex® III aqueous solution, whilst its high emulsifying and dispersing capabilities prevent the re-deposition of the loosened particles. Special surface-active substances facilitate the residue-free rinsing of the optical components once they have been cleaned.

Cleaning and Dilution:

The optimal dilution depends on several factors, such as the hardness of the water, the degree and type of contamination, the temperature, etc. The use of demineralised water improves the cleaning characteristics.

Available in 1.3kg PE-bottle.

The following treatments have been proven at a **concentration (vol%) 0.5 to 2** in practice.

Attention

H phrases: H290|H315|H319|H335

Temperature°C

20-25

30-35

50-60 (quartz only)

70-80 (quartz only)

Time minutes

120-180

30-40

10-15

< 5

Type	Capacity Litres	PK	Cat. No.
HELLMANEX® III	1	1	9.190 985

2

2 Cuvette rack, PP

ISOLAB

For safe handling and holding of 16 spectrophotometer cuvettes with 10 mm width.

Alphanumerical index on cuvette rows enables easy identification of tube positions.

2 tier body form offers clear visibility option from horizontal direction. Autoclavable (121 °C).

Length mm	Width mm	Height mm	PK	Cat. No.
210	70	35	1	6.286 844

3

3 Cuvette rack, PP

BRAND

Grey. 16 numbered positions.

Autoclavable (121°C).

Width mm	Length mm	Height mm	PK	Cat. No.
70	210	38	1	9.145 020

4

4 Cuvette rack with attached lid, PP

For safe handling and holding up to 12 cuvettes with a 10 mm light path.

ISOLAB

These racks consist of hinged lids with secure clasps and removable inserts for easy cleaning.

The height of the lid is designed to accommodate all spectrophotometer cells - even those with covers or stoppers.

Description	PK	Cat. No.
Cuvette rack with attached lid	1	6.267 353

Disinfection	1162
Wipes	1162
liquid	1163
for Instruments	1166
Cleaning implements	1174
Dry wipes	1174
Towels and dispensers	1178
Absorbent pads / Cotton wool	1179
Cleaning equipment	1180
Brushes	1182
Hair brushes	1183
Draining racks	1184
Ultrasonic cleaners	1185
Instruments	1185
Ultrasonic cleaners	1193
Washers, disinfectors	1194
Instruments	1195
Accessories	1196
Steam sterilisers - Autoclaves	1197
Instruments	1197
Accessories	1206
Sterile packaging	1209

11. Cleaning and sterilisation

Disinfection/Wipes



1 2 LLG-Dispenser system Wiper Bowl® Safe & Clean for cleaning tissues

The economical "building block solution" for thorough disinfection and cleaning of sensitive areas in the medical and foodstuff industries. Can be filled with all commercial disinfectant and cleaning agents. The fine perforated structure of Multitex® cleaning tissues ensures an even distribution of the surface disinfectant. These tissues are also ideally suited to the cleaning of grossly soiled surfaces. Easy handling thanks to tear-off perforation. After cleaning the lid can be closed and the tissues stay moistured for more than 30 days ensuring a constant cleaning and disinfection performance.

LLG-Dispenser bucket Wiper Bowl® Safe & Clean:

Empty. For 1 roll Multitex® DR. Made of plastic, dia. approx. 21cm, resealable and reusable.

LLG-Cleaning tissues Multitex® DR:

Viscose fleece for LLG-Dispenser bucket Wiper Bowl® Safe & Clean. White, fine, tear-resistant, absorbent and lint free. Dimensions: 300mm x 320mm. 1 roll of 90 tissues

Please order separately.



Type	PK	Cat. No.
LLG-Dispenser bin	1	9.413 216
LLG-Cleaning tissues Multitex® DR	1	9.413 215



3 Dispenser system neoform® wipes RTF



Disposable fleece wipe dispensing system for use with surface disinfectants. Disinfecting cleaning and disinfection of surfaces, appliances, medical devices and medical equipment in combination with suitable Dr. Weigert surface disinfectants.

Dr. Weigert

Description	PK	Cat. No.
Bucket with 115 wipes per roll	8	4.672 079



4 HBV Tissues Meliseptol®

Ready to use, alcoholic disinfectant tissues, 145 x 200 mm.
 - For small alcohol resistant surfaces
 - Active in 1 minute
 - Hygienic individual removal from practical dispenser box
 - Dermatologically tested

B. Braun Deutschland

This product is a disinfectant containing biocides. Please inquire its availability and legal information.



Danger

H phrases: H226|H318|H336

Package contents	PK	Cat. No.
100 cloths, dispenser	100	9.191 272
100 cloths, refill pack	100	6.800 451



5 Wipes Flow Wipes Fresh



Ready-to-use wipes for the gentle disinfection and cleaning of medical devices and medical inventory and surfaces of all kinds in patient-oriented areas. The cloths can be removed individually from the practical package with reclosable lid. Cloth size 20 x 22 cm.

Unigloves



Warning

H phrases: H226

Package contents	PK	Cat. No.
Pack of 100 tissues	100	6.312 125

1 2 Disinfection Tissues Bacillo[®] Tissues/Bacillo[®] AF Tissues

Hartmann

With Bacillo[®] AF solution pre-soaked and ready-to-use wipes with a wide range of effects, e.g. fungicidal, tuberculocidal and mycobactericidal.

- Wide compatibility with alcohol-resistant surfaces
- Aldehyde, dye and perfume free
- Good wetting and quick drying
- Acc. to VAH for risk areas

This product is a disinfectant containing biocides. Please inquire its availability and legal information.



Warning

H phrases: H226|H319

Type	Length mm	Width mm	Package contents	Life time	PK	Cat. No.
Bacillo [®] Tissues	225	139	Dispenser of 100 Tissues	3 months	1	6.232 040
Bacillo [®] Tissues	225	139	Refill bag of 100 Tissues	3 months	1	6.237 958
Bacillo [®] AF Tissues	200	180	Flowpack of 80 Tissues	28 days	80	7.670 865



3 Spray disinfectant Meliseptol[®]

B. Braun Deutschland

Ready-to-use alcoholic disinfectant for all non-invasive medical inventory, medical devices e.g. examination chairs, hospital beds, theatre equipment and other kinds of surfaces.

- Highly efficient based on a mid level alcohol concentration - active within 1 minute
- Enhanced cleaning performance, even on shining metallic surfaces
- Without additional antimicrobial ingredient (like aldehydes, QAC)
- Pleasant, lemon-like smell
- Fast and comprehensive activity spectrum incl. Mycobacteria and non-enveloped viruses as Rota-, Adeno- as well as Norovirus (MNV)ation

Use disinfectants safely. Always read the label and product information before use.

This product is a disinfectant containing biocides. Please inquire its availability and legal information.



Warning

H phrases: H226

Type	Capacity ml	PK	Cat. No.
Hand spray bottle	250	1	9.191 292
Hand spray bottle without spray head*	1000	1	9.191 293
Spray head for 1L hand spray bottle		1	9.191 268
Jerrycan	5000	1	9.191 295

*Spray head for 1000ml hand spray bottle - please order separately.



4 Meliseptol[®] rapid, fast acting spray disinfectant

B. Braun Deutschland

Meliseptol[®] rapid is a fast acting, ready-to-use disinfectant for medical equipment such as treatment chairs, operating theatre equipment and hospital beds.

Meliseptol[®] rapid works within 1 min. as a bactericide, tuberculocide, fungicide (incl. mould fungi) and inactivates Hepatitis-B, HIV, rotaviruses, adeno and vaccinia viruses. Free from aldehydes and alkyl amines.

This product is a disinfectant containing biocides. Please inquire its availability and legal information.



Danger

H phrases: H226|H318|H336

Type	Capacity ml	PK	Cat. No.
Spray bottle	250	1	9.191 036
Dosing bottle	250	1	9.191 037
Hand spray bottle without spray head*	1000	1	9.191 038
Spray head for 1000ml hand spray bottle		1	9.191 268
Jerrycan	5000	1	9.191 040

*For spray bottle 1000ml - please order spray head separately.





1 Fast Acting Spray Disinfectant Bacillol® AF

Alcoholic disinfectant with full effectiveness for alcohol resistant surfaces and devices with fast exposure and drying time.

Hartmann

- Ready-to-use solution
- Fast effect
- Wide material compatibility
- Aldehyde, dye and perfume free
- Good wetting

This product is a disinfectant containing biocides. Please inquire its availability and legal information.



H phrases: H226|H318|H336

Type	Capacity ml	PK	Cat. No.
Bottle	50	1	7.637 244
Bottle	1000	1	6.239 263
Jerrycan	5000	1	6.263 817

You can find ordering information for all articles described above as well as other articles online.



2 Surface disinfectant neoform® Rapid

NEW

Dr. Weigert

Alcohol-based solution for disinfecting surfaces of medical devices, surfaces in the laboratory area as well as surfaces and equipment in the pharmaceutical and cosmetics area. Application: wiping method. VAH listed and included in the IHO disinfectant list.



H phrases: H226|H319|H336

Type	Capacity ml	PK	Cat. No.
Bottle	750	1	6.274 227



3 Surface disinfection Pursept®-A Xpress

Pursept®-A Xpress is a ready-to-use preparation for rapid disinfection and cleaning of surfaces and instruments (e.g., liquid handling instruments).

Schülke & Mayr GmbH

It works in only 15 secs. - even before the surface dries. DGHM tested and RKI compliant. Dermatologically tested for skin tolerance. Aldehyde-free

For RKI compliant use, apply Pursept®-A Xpress full strength to a disposable cloth. Then thoroughly wipe off the area to be disinfected with the wet cloth. Be sure to wipe everything completely. The surface should remain moist during the entire working time.

Use disinfectants safely. Always read the label and product information before use.

This product is a disinfectant containing biocides. Please inquire its availability and legal information.



H phrases: H226|H319

Contents per 100g:

55g ethanol, 0.03g N-alkyl aminopropyl glycine; auxiliary agents.

Surface disinfection:

Bacteria and fungi with little organic burden with mechanics acc. to DGHM/VAH*directives:

15secs.

Limited virucidal efficacy** (incl. HIV, HBV, HCV):

15secs.

Effectiveness against TbB:

30secs.

Liquid:

colourless, transparent

Density:

approx. 0.9g/cm³

pH value:

approx. 7.5

Type	Capacity Litres	PK	Cat. No.
Pump spray bottle (without cap)	1	1	9.192 567
Jerrycan	5	1	9.192 568
Spray cap		1	9.192 566

*Tested according to standard DGHM methods of surface disinfection. Latest version: 9/1/2001

**As recommended by the Robert-Koch-Institute (RKI), Bundesgesundheitsblatt 01/2004

1 Surface disinfection concentrate, Pursept® AF

For alcohol-resistant worktops and equipment surfaces in microbiological and medical laboratories. Cleans and disinfects floors, walls and equipment in one operating cycle. Effective against bacteria, fungi and viruses, in particular Hep.-B and HIV. Tested and certified in accordance with the guidelines of the DGHM (German Hygiene and Microbiology Society). Particularly gentle on surfaces, kind to skin and has a pleasant, fresh fragrance. Use disinfectants safely. Always read the label and product information before use.

Schülke & Mayr GmbH



This product is a disinfectant containing biocides. Please inquire its availability and legal information.



Danger

H phrases: H302|H314|H400

Contents per 100g: 12.5g didecyl dimethyl ammonium chloride
 < 5% NTA,
 < 5% non-ionic surfactants, auxiliary agent
 1.5g (aminopropyl)-lauryl amine, auxiliary materials

Microbiological power/application concentration Surface disinfection:
 Bacteria and fungi in acc. with DGHM: 0.25%/4 hrs., 0.5%/60 min., 1%/30 min., 2%/15 min.
 Limited virucidal efficacy* (incl. HIV, HBV, HCV): 1%/15 min.
 Inactivating human rotaviruses: 0.25%/2 mins.
 Concentration for TbB: 2%/60 mins.
 Liquid: clear, green
 Density: approx. 1g/ml
 pH value (1%): approx. 10

Type	Capacity Litres	PK	Cat. No.
Bottle	2	1	9.192 569
Jerrycan	5	1	9.192 570

2 Molecular BioProducts™ RNase AWAY™ Surface Decontaminant

Eliminates unwanted DNA and RNase from glassware and plasticware without affecting subsequent DNA samples. Degrades DNA more quickly and effectively than autoclaving. Suitable for gel boxes, pipettes, benchtops, thermocyclers, or other apparatus. Use before performing PCR or working with DNA for a DNA-free work area. Simply apply the ready-to-use formula to the surface to decontaminate, then wipe dry or rinse clean.

Thermo Scientific



This product is a disinfectant containing biocides. Please inquire its availability and legal information.



Danger

H phrases: H314|H318

Capacity ml	Package	PK	Cat. No.
250	bottle	1	6.225 974
475	spray bottle	1	6.227 799
1000	bottle	1	6.206 320

3 DNA AWAY™ for surface decontaminant

Eliminates unwanted DNA and DNase from glassware and plasticware without affecting subsequent DNA samples. Degrades DNA more quickly and effectively than autoclaving.

Thermo Scientific



This product is a disinfectant containing biocides. Please inquire its availability and legal information.

Type	Capacity ml	Package	PK	Cat. No.
MBP DNA Away™	250	Flask	1	6.228 401



1 Disinfectant for temperature-sensitive materials, Helipur® H plus N

Liquid concentrate for disinfecting flexible endoscopes, anaesthetic accessories, rubber and plastic items.

B. Braun Deutschland

- Also suitable for disinfecting metal, glass and ceramics
 - Effective against bacteria incl. T.B.-B, spores, fungi, lipophilic viruses including Hepatitis-B and HIV, coxsackie, adeno and vaccinia viruses
 - Can also be used in ultrasonic baths
 - Formaldehyde free
 - Material compatibility reports are available from leading manufacturers.
- Use disinfectants safely. Always read the label and product information before use.

This product is a disinfectant containing biocides. Please inquire its availability and legal information.



H phrases: H302+H332|H314|H317|H334|H335|H412

Application concentration: 1.5% reaction time 15mins. = 15ml in 1L water
1.0 % reaction time 60 mins. = 10 ml in 1 L water

Type	Capacity ml	PK	Cat. No.
Dosing bottle	1000	1	9.191 277
Jerrycan	5000	1	9.191 278



2 Instrument disinfection, Mucocit® T

A fresh fragranced solution with exceptional cleaning power and disinfection in only 5 minutes due to the Active-Power-PLUS formula. Ideal for sensitive instruments, thanks to a unique material tolerance. Mucocit® T is used for manual instrument cleaning in a soaking or ultrasonic bath. Use disinfectants safely. Always read the label and product information before use.

Schülke & Mayr GmbH

This product is a disinfectant containing biocides. Please inquire its availability and legal information.



H phrases: H302|H314|H317|H334|H373|H410

Contents per 100g:

3.9g didecyl-dimethyl-ammonium chloride,
4.5g alkylpropylendiamine-1.5-bisguanidiniumacetate,
2g bis(-aminopropyl)-laurylamine, 2.8g laurylpropylenediamine,
5-15% non-ionic tenside surfactants, auxiliary agents.

Microbiological power/application concentration:
DGHM/VAH* bacteria and fungi as well as tuberculocide
and myobactericide with high organic stress:

1%/60 min., 2%/30 min., 3%/15 min.

Limited virucidal efficacy** (incl. HIV, HBV, HCV):

1%/5 min.

Inactivation of rotaviruses:

2%/5 min.

Physico-chemical data:

Liquid:

blue, transparent

Density:

approx. 1g/ml

pH value (1%, 20 °C):

approx. 10.5

Type	Capacity Litres	PK	Cat. No.
Jerrycan	5	1	9.192 551

*Tested according to standard DGHM methods of surface disinfection. Latest version: 9/1/2001

**As recommended by the Robert-Koch-Institute (RKI), Bundesgesundheitsblatt 01/2004

You can find ordering information for all articles described above as well as other articles online.

1 Universal cleaner, neodisher® LaboClean A 8

Alkaline universal detergent for the automated cleaning of laboratory glassware and other utensils for laboratories, powder.

Dr. Weigert

Universally applicable, with excellent cleaning performance and dirt carrying capacity. Removes blood, serum, food residues, pharmaceuticals, paints, varnishes, gelatine and other organic residues. Free of surfactants.



Danger

H phrases: H290|H314|H318|H411|H335

Type	Capacity kg	PK	Cat. No.
Bottle	1	1	9.192 404
Bucket	10	1	9.192 403
Bucket	25	1	9.192 401

1



2 Special cleaner, neodisher® LaboClean GK

Mildly alkaline detergent for the automated cleaning of laboratory glassware and other utensils for laboratories, powder.

Dr. Weigert

Especially for the automated cleaning of glassware for cell and tissue cultures, in the field of microbiology and nuclear medicine as well as in isotope laboratories. Removes residues of culture media, residues of cell and tissue cultures, radioactive contamination, organic colour and pigment contamination. Easy to rinse off. Free of surfactants.



Warning

H phrases: H315|H319|H335|H411

Type	Capacity kg	PK	Cat. No.
Bucket	10	1	9.192 415

2



3 Special cleaner, neodisher® LaboClean LA

Highly alkaline intensive detergent for the automated cleaning of laboratory glassware and other utensils for laboratories, powder.

Dr. Weigert

With a highly emulsifying, dispersing and defoaming action. Especially suitable for the removal of fat, oil, resins and paraffin. Free of oxidising agents.



Danger

H phrases: H290|H314|H318|H335

Type	Capacity kg	PK	Cat. No.
Bucket	3	1	9.192 418

3



4 Special cleaner, neodisher® MA

Mildly alkaline detergent for the automated reprocessing of surgical instruments and anaesthesia materials, and other medical technological utensils, powder.

Dr. Weigert

Excellent cleaning action and material compatibility. Free of oxidising agents.



Danger

H phrases: H314|H318|H335

Type	Capacity kg	PK	Cat. No.
Bottle	1	1	9.192 406
Bucket	10	1	9.192 405

4



1

1 Special cleaner, neodisher® LaboClean UW

Mildly alkaline detergent for the automated cleaning of laboratory glassware and other utensils for laboratories, powder. *Dr. Weigert*

Especially suitable for the automated cleaning of laboratory glassware and utensils in water analysis laboratories, in serological institutes and in the phosphates industry, where residues of phosphorous compounds would be adulterate analysis results. Free of phosphates.

Danger

H phrases: H314|H318|H335

Type	Capacity kg	PK	Cat. No.
Bucket	10	1	9.192 445

2

2 Special cleaner, neodisher® LaboClean F

Highly alkaline intensive detergent for the automated cleaning of laboratory glassware and other utensils for laboratories, powder. *Dr. Weigert*

With excellent cleaning performance. Especially suitable for the removal of resins, organic colourants and residues of felt-tip pens. Good complexing and dispersing action. Free of phosphates, surfactants and oxidising agents.

Danger

H phrases: H290|H314|H335

Type	Capacity kg	PK	Cat. No.
Tubs	3	1	9.192 387

3

3 Cleaning detergent ProCare Lab 11 AP

Powder alkaline, free from phosphates. Material protection and good cleaning performance on inorganic and organic soils. *Miele*

Suitable for: Stainless steel, laboratory glassware, ceramics, suitable plastics (PE, PP, PVDF, PTFE)
Not suitable for: Light alloys and non-ferrous metals, aluminium, anodised aluminium

Danger

H phrases: H314|H335

Type	Capacity kg	PK	Cat. No.
Bucket	10	1	6.281 512

4

4 Special cleaner, neodisher® FA

"Classical" alkaline detergent for the automated reprocessing of thermostabile and thermolabile instruments, liquid concentrate. *Dr. Weigert*

Excellent cleaning action and material compatibility. Free of surfactants and oxidising agents.

Danger

H phrases: H314|H318|H290

Type	Capacity	PK	Cat. No.
Canister	5 l	1	9.192 435
Canister	10 l	1	9.192 431
Canister	25 kg	1	9.192 434

1 Universal cleaner neodisher® LaboClean FLA

Alkaline universal detergent for the automated cleaning of laboratory glassware and other utensils for laboratories, liquid concentrate.

Dr. Weigert

Universally applicable. With excellent cleaning performance. Removes stubborn oily and other organic residues. Free of surfactants, phosphorous compounds and oxidising agents.



Danger

H phrases: H290|H302|H314

Type	Capacity	PK	Cat. No.
Canister	5 l	1	9.192 446
Canister	10 l	1	9.192 447
Canister	25 l	1	9.192 448

1



2 Special Cleaner neodisher® LaboClean FM

Alkaline intensive detergent with highly emulsifying and dispersing action, liquid concentrate.

Dr. Weigert

Especially suitable for the removal of oil, fat, resins and paraffin as well as organic dyes. Free of phosphates and oxidising agents.



Danger

H phrases: H290|H314

Type	Capacity	PK	Cat. No.
Canister	5 l	1	7.654 947

2



3 Special cleaner, neodisher® LaboClean FT

Alkaline detergent for the automated cleaning of laboratory glassware and other utensils for laboratories, liquid concentrate.

Dr. Weigert

Especially suitable for the residue-free cleaning of pharmacy glass bottles, infusion flasks, glassware for cell and tissue culture as well as utensils for microbiology and nuclear medicine. Removes residues of culture media, blood, proteins, radioactive contamination, residues of cell and tissue cultures as well as other organic residues. With oxidising effect, free of surfactants.



Danger

H phrases: H290|H314|H400|H411

Type	Capacity	PK	Cat. No.
Canister	5 kg	1	6.261 212
Canister	12	1	9.192 436
Canister	25	1	9.192 437

3



4 Special cleaner neodisher® N

Acidic neutralising agent and detergent for the automated cleaning of laboratory glassware and other utensils for laboratories, liquid concentrate.

Dr. Weigert

For neutralising carried over alkaline residues as well as for the acidic pre-cleaning resp. cleaning of laboratory glassware. Lime and other acid-soluble residues are removed. Easy to rinse off. Based on phosphoric acid. Free of surfactants.



Danger

H phrases: H314|H318|H290

Type	Capacity	PK	Cat. No.
Bottle	1 l	1	9.192 422
Canister	5 l	1	9.192 421
Canister	12 kg	1	9.192 420

4



You can find ordering information for all articles described above as well as other articles online.

1

1 Special cleaner neodisher® Z

Acidic neutralising agent and detergent for the automated cleaning of laboratory glassware and other utensils for laboratories, liquid concentrate.

Dr. Weigert

For neutralising carried over alkaline residues as well as for removing acid-soluble residues in laboratories where residues of phosphates or surfactants would adulterate analysis results and where particular material compability is necessary. Based on organic acids. Free of surfactants and phosphates.

Warning

H phrases: H319

Type	Capacity	PK	Cat. No.
Bottle	1 L	1	9.192 426
Canister	5 L	1	9.192 425
Canister	10 L	1	9.192 427
Canister	20 L	1	9.192 428

2

2 Special cleaner neodisher® LM 3 for pipettes

Alkaline cleaner for the manual cleaning and pre-cleaning of laboratory glassware as well as for the cleaning of pipettes and viscometers in special washers, liquid concentrate.

Dr. Weigert

Especially suitable for the cleaning of laboratory glassware in water, phosphates and metal laboratories and in laboratories where enzymatic and serological analyses are conducted. Also suitable for automated cleaning. Low foam. Free of phosphates.

Danger

H phrases: H314|H318|H290

Type	Capacity Litres	PK	Cat. No.
Canister	10	1	9.192 441

You can find ordering information for all articles described above as well as other articles online.

3

3 Special cleaner, neodisher® MediClean forte

Alkaline universal detergent for the automated and manual reprocessing of thermostable and thermolabile instruments, liquid concentrate.

Dr. Weigert

Excellent material compatibility, universally applicable. Residues of dried-on and denaturated blood are reliably removed. Prevents re-deposition of protein residues. Contains alkalinity donors, enzymes and surfactants.

Warning

H phrases: H210

Type	Capacity Litres	PK	Cat. No.
Canister	5	1	6.228 020

4

4 Cleaning additive, neodisher® EM

Additive for emulsification or dispersion as well as foam suppression in special dishwashers, liquid concentrate.

Dr. Weigert

neodisher® EM, in combination with alkaline and acidic cleaners, emulsifies or disperses undissolved impurities. neodisher® EM emulsifies and/or disperses fats, oils, paraffins and solid matter in aqueous solutions. neodisher EM also has an anti foaming action. Glass, special steel and aluminium are fully resistant to neodisher® EM. Can be used with any level of waterhardness.

Warning

H phrases: H210

Type	Capacity Litres	PK	Cat. No.
Canister	5	1	9.192 450

1 Alkaline detergent, neodisher® Alka 300

Mild alkaline liquid cleaning agent for use in special washing machines. neodisher® Alka 300 is mildly alkaline and removes blood, protein residues and organic residues.

Dr. Weigert

Instrument steel, chrome nickel steel, chromium-plated and nickel-plated materials, pure aluminium, aluminium-magnesium alloys and ordinary plastics are not affected. Suitability tests should be carried out before use in the case of special instruments, e.g. optical instruments or anaesthetic and respiration materials, as well as anodised aluminium. neodisher® Alka 300 can be used with any level of water hardness, but should generally be used with softened water for reasons of economy.



Danger

H phrases: H290|H314|H400|H411

Type	Capacity kg	PK	Cat. No.
neodisher® Alka 300	12	1	6.070 119
neodisher® Alka 300	25	1	6.229 269

1



2 Cleaning detergent ProCare Lab 11 MA

Powder mildly alkaline, foam-inhibiting, free from oxidants. Good cleaning performance on blood, protein and food residue, good protection against corrosion for laboratory glassware, stainless steel, chrome-plated items, laboratory equipment made from common types of plastic. Suitable for: Stainless steel, laboratory glassware, ceramics, suitable plastics (PE, PP, PVDF, PTFE) Not suitable for: Anodised aluminium

Miele



Danger

H phrases: H314|H335

Type	Capacity kg	PK	Cat. No.
Bucket	10	1	6.281 511

2



3 Cleaning Detergent ProCare Lab 10 MA

Liquid, alkaline, versatile, free from oxidants and tensides. Good material protection good cleaning performance on organic soils. Suitable for: Stainless-steel, laboratory glassware, ceramics, suitable plastics (PE, PP, PVDF, PTFE) Not suitable for: Anodised aluminium

Miele



Danger

H phrases: H290|H314

Type	Capacity Litres	PK	Cat. No.
Canister	5	1	6.281 513
Canister	10	1	6.281 514

3



4 Cleaning Detergent ProCare Lab 10 AP

Liquid, alkaline, versatile, free from tensides, phosphates and oxidative agents. Good material protection and good cleaning performance on stubborn or dried-on residues. Suitable for: Stainless-steel, laboratory glassware, ceramics, plastics (PE, PP, PVDF, PTFE). Not suitable for: Light alloys and non-ferrous metals, aluminium, anodised aluminium.

Miele



Danger

H phrases: H290|H302|H314

Type	Capacity Litres	PK	Cat. No.
Canister	5	1	6.281 515
Canister	10	1	6.281 516

4



1



1 Cleaning Detergent ProCare Lab 10 AT

Liquid, alkaline, contains tensides, versatile, free from phosphates, silicates and oxidative agents. Good material protection and good cleaning performance on stubborn residues such as oils, greases, paraffins, resins and organic dyes.
Suitable for: Stainless-steel, laboratory glassware, ceramics, plastics (PE, PP, PVDF, PTFE).
Not suitable for: Light alloys and non-ferrous metals, aluminium, anodised aluminium.

Miele

Danger

H phrases: H290|H314

Type	Capacity Litres	PK	Cat. No.
Canister	5	1	6.281 517
Canister	10	1	6.281 518

2



2 Neutralising agent ProCare Lab 30 C

Liquid, acidic (based on citric acid), versatile, free from tensides and phosphates. Good material protection and for residues soluble in acids.

Miele

Suitable for: Stainless-steel, laboratory glassware, ceramics, plastics (PE, PP, PVDF, PTFE), additionally suitable for the neutralisation of non-anodised aluminium.

Not suitable for: Light alloys and non-ferrous metals, chrome- and nichel-plate parts, anodised aluminium, additionally not suitable for acidic pre-cleaning of non-anodised aluminium.

Warning

H phrases: H319

Type	Capacity Litres	PK	Cat. No.
Canister	5	1	6.281 519
Canister	10	1	6.281 520

3



3 Neutralising agent ProCare Lab 30 P

Liquid, acidic (based on phosphoric acid), versatile, free from tensides.

Miele

Good material protection and removes limescale and other soils soluble in acids.

Suitable for: Stainless-steel, laboratory glassware, ceramics, plastics (PE, PP, PVDF, PTFE).

Not suitable for: Light alloys and non-ferrous metals, chrome- and nichel-plate parts, anodised aluminium, aluminium.

Danger

H phrases: H290|H314

Type	Capacity Litres	PK	Cat. No.
Canister	5	1	6.281 521
Canister	10	1	6.281 522

4



4 Reactivation salt ProCare Lab Universal 61

Coarse special salt for reactivation of built-in water softener.

Miele

It prevents scaling and protects loads.

Type	Capacity kg	PK	Cat. No.
Box	6	1	7.660 602

1 Universal cleaner, Mucosol®

High performance, alkaline cleaning concentrate in liquid form for soaking and ultrasonic cleaning baths. *Schülke & Mayr GmbH*

Suitable for use on laboratory equipment and instruments made of glass, porcelain, plastic, rubber and metal. Items are cleaned in ~ 10 - 30mins, without mechanical help. An alternative to chromosulphuric acid mixtures, free from chlorine and caustic alkalines, non-toxic, non-corrosive and is biodegradable. Zinc and non-anodized aluminium items should not be immersed in Mucosol® for long periods as corrosion may occur. Also suitable for wiping down surfaces.



Danger

H phrases: H315|H318

Contents: >30% phosphates, <5% anionic surfactants, amphoteric surfactants, complexing agents, corrosion inhibitors, auxiliary agents

Application concentration:
In ultrasonic baths: 0.2% to 2% (1.4ml/l to 14ml/l)
In soaking baths: 0.7% to 3% (5ml/l to 22ml/l)

Physico-chemical data:
Liquid: light green, transparent
Density: approx. 1.4g/ml
pH value (0.7%): approx. 11.5
pH value (3%): approx. 11.7

Type	Capacity Litres	PK	Cat. No.
Bottle	2	1	9.192 501



2 Dust remover spray DRUCKLUFT 67

DRUCKLUFT 67 is a high pressure, inert, liquefied gas with a reduced Global Warming Potential (GWP) value of 7. The dry and oil-free gas does not leave any residues and is non-flammable according to directive 2008/47/EC. The spray bottle is equipped with an extension tube for an accurate cleaning procedure removing dust and loose debris. The balanced spray system delivers a medium spray-pressure. Economic and harmless to sensitive components. *CRC*



Warning

H phrases: H229

Description	Capacity ml	PK	Cat. No.
Dust remover spray	200	1	9.412 800
Dust remover spray	400	1	9.412 801
Flexible spray hose 50 cm		1	7.660 941

2



Dust remover spray DRUCKLUFT 67 SUPER/DRUCKLUFT 67 HOCHDRUCK

Spray for the contact-free removal of dust and dirt from hard-to-reach places. *CRC*
For highest safety also for devices under electric tension. Acc. to Aerosol policy 75/324/EWG no danger of inflammation or explosion even in the presence of ignition sources.
DRUCKLUFT 67 SUPER contains pure and efficient compressed gas. Especially suitable for work under electric tension and for ex-use.

DRUCKLUFT 67 HOCHDRUCK is based on high purity liquified gas with low global warming potential (GWP=7). The dry, oil-free gas will not leave residues and is non-flammable according to directive 2008/47/EC. The high flow rate valve ensures a powerful blowing action for heavy duty applications.



Warning

H phrases: H229

Type	Capacity ml	PK	Cat. No.
DRUCKLUFT 67 SUPER	200	1	7.027 746 3
DRUCKLUFT 67 SUPER	400	1	9.412 805
DRUCKLUFT 67 HOCHDRUCK	340	1	6.242 238

3



7.027 746

➔ Label solvent - please see page 170.

11. Cleaning and sterilisation

Cleaning implements/Dry wipes

1 2 3 LLG-Laboratory and hygienic tissues, 2-ply, 150 wipes

Laboratory and hygienic tissues in dispenser box
 - contains 150 white, double-ply tissues, 210mm x 220mm
 - highly absorbent and ultra-soft
 - for sensitive application areas

Carton of 30 boxes with 150 wipes

Wall Mount, wire, white-coated with wall mounting material for packaging up to 70mm depth, please order separately.

Package contents	PK	Cat. No.
Carton of 30 boxes with 150 wipes	30	9.413 220
Wall Mount for Laboratory and hygienic tissues	1	9.405 371

1



2



3



4



4 Precision wipes, KIMTECH SCIENCE, 1-ply

Precision tissue wipes for critical cleaning in the electronic, optic and precision mechanics industries, lint-free, highly absorbent and strong, even when wet. 1-ply, white. Anti-static.

Kimberly-Clark

Dimensions	Package contents	PK	Cat. No.
mm			
304 x 304	Box of 196 wipes	1	9.413 020
115 x 215	Box of 280 wipes	1	9.413 021

5



9.413 017

Laboratory wipes, KIMTECH SCIENCE*, 2-ply

Tissue wiping cloth for professional use in laboratories. Highly absorbent and soft for wiping up small amounts of liquid and for cleaning pipettes and microscope slides. Chemical resistant and chemically neutral. 2-ply, white. Anti-static.

Kimberly-Clark

6



9.413 015

Dimensions	Package contents	PK	Cat. No.
mm			
200 x 210	Box of 100 wipes	100	9.413 017 5
200 x 210	Box of 200 wipes	200	9.413 015 6

7



7 Cleaning wipes, KIMTECH*Process Wiper, cloths

Blue, super strong, robust, lint-free, PP reusable wiping cloths, ideal for residue-free wet cleaning with cleaning agents and solvents as well as wiping up oil and grease. 100% silicon-free. Folded into quarters, embossed.

Kimberly-Clark

Colour	Width	Length	Package contents	PK	Cat. No.
	mm	mm			
blue	490	380	12 bags containing 35 cloths	12	9.413 070

11. Cleaning and sterilisation

Cleaning implements/Dry wipes

1 Absorbent Towels, KIMTECH* 7505

Soft and gentle, yet strong. White, embossed, sterilisable. Individual cloths.

Kimberly-Clark

1



Dimensions mm	Package contents	PK	Cat. No.
320 x 380	Bag of 50 cloths	50	9.413 033

2 3 4 5 Universal dishwashing

Universal cloth:

Made from 80 % viscose and 20 % polyester. The universal cloth has a finely structured surface. It provides a cleaning result without streaks, is nearly lintfree and washable up to 95 °C. Please wash in lukewarm water before first use.

Washing up liquid:

HS citro is a dish washing detergent for universal implementation with a fresh fragrance for porcelain, glass, plastic, and metal. Professional recipe with high grease dissolving strength and plant-based skin protecting additives. 1L

Sponge:

For cleaning any kind of incrustation.

Gloves:

Natural rubber. Excellent finger sensitivity, high flexibility. Flock-lined for optimal comfort. Special surface finish provides a firm hold. Good resistance to ketones and many acids. L 305mm.

2



4



3



5



Description	Colour	Dimensions mm	PK	Cat. No.
Universal cloth	blue/white	380 x 380	10	6.266 668
Universal cloth	red/white	380 x 380	10	6.266 669
Universal cloth	green/white	380 x 380	10	6.266 670
Universal cloth	yellow/white	380 x 380	10	6.266 671
Sponge	green/yellow	150 x 90 x 40	10	6.266 672
Sponge	green/yellow	95 x 70 x 45	10	6.266 673
Washing up liquid, 1L			1	6.266 678
Rinsing brush	blue/white	220 x 60	1	9.019 110
Gloves size 6 - 6 1/2	yellow		1	9.005 201
Gloves size 7 - 7 1/2	yellow		1	9.005 202
Gloves size 8 - 8 1/2	yellow		1	9.005 203
Gloves size 9 - 9 1/2	yellow		1	9.005 204
Gloves size 10 - 10 1/2	yellow		1	9.005 205

6 7 Wipes Unitex®

Made from cellulose and polyester fibers, turquoise.

- Without binders, chemicals or adhesives
- Resistant to solvents and silicone free
- Particularly tear-resistant and lintfree
- Useable dry and wet, high absorption capacity
- Excellent for cleaning and degreasing surface

6



7



Width mm	Length mm	Thickness mm	Weight g / m ²	Package contents	PK	Cat. No.
380	300	0.28	68	pack of 4 x 50 tissues	4	6.266 676
390	325	0.28	68	roll with 500 tears	1	6.266 677

11. Cleaning and sterilisation

Cleaning implements/Dry wipes

1



1 LLG-Laboratory tissues, roll, 102 sheets 3-ply

Roll with 102 sheets (220 x 260mm).
 - strong when wet
 - absorbent
 - low lint

Package contents	PK	Cat. No.
roll of 102 tissues	2	9.413 224
roll of 102 tissues (advantage pack)	28	9.413 225

2



6.261 940

Wipes Multitex®

The high-quality viscose fleece with textile characteristics is suitable for wet and dry cleaning thanks to its incredible strength. The cloths are very soft and yet low-lint, they can absorb large amounts of liquid and remain tear-resistant, they are solvent-resistant and they meet food safety requirements. Silicone free.

Width	Length	Colour	Package contents	PK	Cat. No.
mm	mm				
380	340	white	400 sub-packed (10 x 40)	400	6.261 940 2
300	400	white	1 roll with 475 tears	1	7.646 593

3



3 Wipes Multiclean®, 3-ply

Handy cleaning cloths, resistant and with high wet strength they are ideal for light and coarse dirt work. The appropriate holder, whether as floor stand or for wall mounting are available on request.

Width	Length	Weight	Package contents	PK	Cat. No.
mm	mm	g / m ²			
220	380	60	2 rolls with 500 tears	2	7.618 013
360	380	54	2 rolls with 500 tears	2	7.618 212
360	380	54	Roll with 1000 tears	1	7.671 903

4



4 5 Wipes Multitex® Ultra z 70, white, disposable tissues

The high-quality viscose fleece with textile characteristics is suitable for wet and dry cleaning thanks to its incredible strength. The cloths are very soft and yet lint-free, they can absorb large amounts of liquid and remain tear-resistant, they are solvent-resistant and they meet food safety requirements. Silicone free.

Width	Length	Thickness	Weight	Package contents	PK	Cat. No.
mm	mm	mm	g / m ²			
350	300	0.36	80	12 bags of 76 tissues	12	6.266 674
410	380	0.36	80	roll with 500 tears	1	6.266 675

5



11. Cleaning and sterilisation

Cleaning implements/Dry wipes

1 Sontara® EC sheets

Engineered specifically for wiping, Sontara EC® is a tough, durable material that is abrasion and solvent resistant, contains no binders or glues, is low-linting, and highly absorbent in water, oil and solvents

- Tough and durable for multiple reuse
- Absorbent and wipes dry
- Solvent-resistant
- Low-linting

Sontara

Width	Length	Thickness	Weight	Package contents	PK	Cat. No.
mm	mm	mm	g / m ²			
305	305	0.53	73	1000 tissues	1	4.663 294
305	380	0.54	77	roll with 400 tears	1	4.663 295



2 Process Wipers, KIMTECH* , roll

Super strong, robust, reusable lint-free PP wipers. Ideal for residue-free wet cleaning of smooth surfaces with cleaning agents and solvents and for wiping up oil and grease. Perforated large roll, embossed.

Kimberly-Clark

Colour	Width	Length	Package contents	PK	Cat. No.
	mm	mm			
blue	305	425	160 towels	1	7.630 073
blue	340	380	Large roll of 500 towels	1	9.413 065



3 Wipes, WypAll*L10/L20/L30/L40

Perforated, blue Airflex*material. Bulky wipes with excellent absorption capacity and wet strength. For cleaning-up large spillages and suitable for most surfaces.

Kimberly-Clark

L10: AIRFLEX*, 1-ply
 L20: AIRFLEX*, 2-ply
 L30: AIRFLEX*, 3-ply
 L40: DRC base material, 1-ply

Width	Length	Type	Package contents	Colour	PK	Cat. No.
mm	mm					
195	380	L10	6 rolls x 800 wipes	white	6	6.312 879
185	380	L10	6 rolls x 630 wipes	white	6	9.413 018
235	380	L20	1 roll x 500 wipes	blue	1	9.413 054
330	380	L20	1 roll x 500 wipes	blue	1	9.413 044
185	380	L20	6 rolls x 300 wipes	white	6	9.413 091
235	380	L20	1 roll x 1000 wipes	blue	1	4.666 151
240	380	L20	24 rolls x 140 wipes	blue	24	6.313 602
370	380	L30	1 roll x 670 wipes	blue	1	9.413 046
317	304	L40	56 wipes	white	18	9.413 093
320	340	L40	1 roll x 750 wipes	white	1	9.413 094



4 Cleaning wipes, WypAll*X60, tear-resistant

Hydroknit*material. The general purpose, extended use, wipe range. Every Wypall*X cloth absorbs liquid rapidly and is puncture and cut-resistant. Extremely hard-wearing and reliable, with excellent tear resistance, even under wet conditions. The unique Hydroknit*fabric structure used for Wypall*X ensures that these cloths provide long lasting, economical cleaning and wiping across a range of possible applications.

Kimberly-Clark

Width	Length	Package contents	PK	Cat. No.
mm	mm			
245	420	Centre-feed, Barrel Roll (blue) of 150 tissues, textured	1	9.413 019
318	305	Individual cloths (folded in Z shape, white), 12 bags of 76 tissues	12	9.413 034
231	426	10 boxes (white) of 126 tissues	10	9.413 035
380	420	Large roll (white) of 750 tissues	1	9.413 036



11. Cleaning and sterilisation

Cleaning implements/Towels and dispensers

Dispensing systems

- White roll dispenser, 250 mm
- Free-standing or wall mounted unit for large rolls
- Aquarius™ Roll Control Wiper Dispenser

Kimberly-Clark

Description	Colour	Width mm	Depth mm	Height mm	Material	PK	Cat. No.
Wall, for small rolls up to 250 mm width	white	296	148	148	plastic	1	9.413 043 1
Floor, for large rolls up to 490 mm width	blue	515	300	328	metal	1	9.413 047 2
AQUARIUS* Dispenser casing for Roll Control System	white	276	226	278	plastic	1	6.264 929 3



9.413 043



9.413 047



6.264 929

Roll holders

Description	PK	Cat. No.
Floor stand with waste bag holder for rolls up to 42cm width	1	6.266 990 4
Wall bracket with waste bag holder for rolls up to 42cm width	1	6.266 991 5



6.266 990



6.266 991



6 LLG-Hand towels, 3-ply

Bright white, extra absorbent, completely unfolding, matching with most dispenser systems, economic use by high absorbency and comfortable size. Suitable for LLG-Dispenser for hand towels, Cat No 7.618 375.

Width mm	Length mm	Package contents	PK	Cat. No.
220	420	20 Packs with 100 tissues	20	6.266 568



7 LLG-Hand towel dispenser

White plastic, easy to refill, with window to observe the filling level, suitable for towel up to 245mm width, e.g. Cat. No. 6.266 568.

Width mm	Depth mm	Height mm	PK	Cat. No.
280	137	375	1	7.618 375

Cleaning implements/Towels and dispensers-Absorbent pads / Cotton wool

1 Hand towels, KLEENEX® Ultra

The new way to get more value for money; tissues made of extremely soft, Airflex*material. So economical, they can be used in any situation.

Kimberly-Clark

Description	Width mm	Length mm	Package contents	PK	Cat. No.
2-ply	215	415	Clip of 94 tissues	1	9.413 051
2-ply	215	315	Clip of 124 tissues	1	9.413 077
3-ply	215	415	Clip of 72 tissues	1	9.413 050
3-ply	215	315	Clip of 96 tissues	15	6.314 919

1



2 Hand Towels, Scott® Performance

Made of highly absorbent, Airflex*material. These rapidly absorbing hand towels are very effective for drying hands due to high moisture absorbency and good wet strength. 1-ply, 70 % recycled material.

Kimberly-Clark

Colour	Package contents	PK	Cat. No.
White	Pack of 212 towels, 215mm x 315mm	15	6.272 380
Blue	Pack of 212 towels, 215mm x 315mm	15	6.272 381

2



3 Towels, Scott® Excellent Plus

Airflex™ material, ultra-white, 2-ply. SCOTT® Hand Towels are renowned for their reliability, consistent performance and in-use value. Made from AIRFLEX*Highly Absorbent Fabric, they offer an effective and economical solution to your hand drying requirements. The towels are folded and interleaved so that when they are dispensed they provide an individual towel that is ready for use and has been touched only by the user. The system is hygienic and helps to reduce wastage. FSC-certified.

Kimberly-Clark

Type	Width mm	Length mm	Package contents	PK	Cat. No.
Small - cross-folded	247	230	Boxes of 180 towels	20	9.413 106

3



4 LLG-Cellulose tissue, supplied in stacks

- Unbleached or highly bleached
- Pack quantity: 1 x 5kg

Description	Width mm	Length mm	PK	Cat. No.
unbleached	600	400	1	9.413 210
highly bleached	600	400	1	9.413 211

4



5 6 Askina® Brauncel® cellulose absorbent pads

Non-sterile. Size 40mm x 50mm. In rolls of 500. Soft, perforated design, easy to tear off. Extremely absorbent and strong.

B. Braun Deutschland

Description	PK	Cat. No.
Cellulose absorbent pads	500	9.413 101
Dispenser	1	9.413 102

5



6



11. Cleaning and sterilisation

Cleaning implements/Absorbent pads / Cotton wool-Cleaning equipment



1 Cotton wool roll

- 100 % Cotton
 - White cotton - bleaching with Hydrogen Peroxide (non chlorine-bleached and without fluorescent whitening agent)
 - according to European Pharmacopoeia & Ecotex 100 Certificate, respond to the maximum rate Standards of Biobinden (100 cfu/g)
 - Width - Max. 20 cm, length ±7 m (500 g)
- For absorbent cotton roll:
- highly absorbent
 - Tenacity of water : appr. 23 g/g of cotton

Description	PK	Cat. No.
Cotton roll 500 g, absorbent	1	9.413 155
Cotton roll 500 g, non-absorbent	1	9.413 156



2 Cotton wool

Meets requirements of German Pharmacopeia.
100% cotton.
Medical cotton wool for home use and general hygiene.

Hartmann

Capacity g	PK	Cat. No.
100	1	9.413 152
400	1	9.413 151



3 Dustpan, PP

Vikan A/S



- Ergonomically designed
- Food-safe
- For colour coding
- Autoclavable

Length mm	Colour	PK	Cat. No.
330	green	1	4.666 171
330	blue	1	4.666 172
330	red	1	4.666 173
330	white	1	4.666 174
330	yellow	1	4.666 175



4 Hand brush, PP

Vikan A/S



- Soft bristles
- To remove fine particles
- Food-safe
- For colour coding
- Autoclavable

Bristle length mm	Overall length mm	Width mm	Height mm	Colour	PK	Cat. No.
50	330	35	110	green	1	4.666 176
50	330	35	110	blue	1	4.666 177
50	330	35	110	red	1	4.666 178
50	330	35	110	white	1	4.666 179
50	330	35	110	yellow	1	4.666 180

➔ Surface protector - please see page 190

11. Cleaning and sterilisation

Cleaning implements/Cleaning equipment

1 Broom, PP



Vikan A/S

- Material: PP, Polyester, Stainless Steel
- Soft bristles
- To remove fine particles
- Food-safe
- For colour coding
- Autoclavable

Bristle length mm	Overall length mm	Width mm	Height mm	Colour	PK	Cat. No.
52	410	65	130	green	1	4.666 181
52	410	65	130	blue	1	4.666 182
52	410	65	130	red	1	4.666 183
52	410	65	130	white	1	4.666 184
52	410	65	130	yellow	1	4.666 185
56	610	65	125	green	1	4.666 186
56	610	65	125	blue	1	4.666 187
56	610	65	125	red	1	4.666 188
56	610	65	125	white	1	4.666 189
56	610	65	125	yellow	1	4.666 190



2 Hand Brush, PP, hard



Vikan A/S

Use this multipurpose Hand Brush to effectively clean tables, conveyor belts, chopping boards, buckets, large bowls and equipment with hard-to-reach corners and crevices. At one end of the brush are even harder bristles, which make it possible to solve persistent dirt.

- Food-safe
- For colour coding
- Autoclavable

Bristle length mm	Overall length mm	Width mm	Height mm	Colour	PK	Cat. No.
36	200	70	60	green	1	4.666 231
36	200	70	60	blue	1	4.666 232
36	200	70	60	red	1	4.666 233
36	200	70	60	white	1	4.666 234
36	200	70	60	yellow	1	4.666 235



3 Washing Brush with Long Handle, PP, hard



Vikan A/S

This Washing Brush is ideal for cleaning hard-to-reach surfaces on machines and equipment such as deep buckets, containers and tubs. It has a long handle and angled bristles that enhance cleaning efficacy.

- Food-safe
- For colour coding
- Autoclavable

Bristle length mm	Overall length mm	Width mm	Height mm	Colour	PK	Cat. No.
36	415	71	75	green	1	4.666 236
36	415	71	75	blue	1	4.666 237
36	415	71	75	red	1	4.666 238
36	415	71	75	white	1	4.666 239
36	415	71	75	yellow	1	4.666 240



11. Cleaning and sterilisation

Cleaning implements/Cleaning equipment-Brushes



1 Ultra Hygienic Handle, PP

Vikan A/S



- Polypropylene, Glass reinforced
- Cold shock and strength tested
- Ergonomically designed
- Easy to clean and dry
- Chemical resistant
- Smooth surface finish
- Food-safe
- For colour coding
- Autoclavable

Length mm	Diam. mm	Colour	PK	Cat. No.
1500	34	green	1	4.666 246
1500	34	blue	1	4.666 247
1500	34	red	1	4.666 248
1500	34	white	1	4.666 249
1500	34	yellow	1	4.666 250
1300	34	green	1	4.666 251
1300	34	blue	1	4.666 252
1300	34	red	1	4.666 253
1300	34	white	1	4.666 254
1300	34	yellow	1	4.666 255

Further products can be found in our online shop.

Brushes, natural bristle

Type	Diam. mm	Length mm	PK	Cat. No.
Pipette brush	5	480	1	9.019 010 2
Pipe cleaner	4	150	100	9.019 005 3
Reagent bottle brush with wool tip	10	190	1	9.019 020
Reagent bottle brush with head bundle	10	250	1	9.019 030 4
Reagent bottle brush with wool tip	15	280	1	9.019 035 5
Reagent bottle brush with wool tip	30	270	1	9.019 040
Erlenmeyer flask and bottle brush with head bundle	50	330	1	9.019 050
Erlenmeyer flask and bottle brush with head bundle	63	470	1	9.019 060
Beaker brush with wooden handle	85	390	1	9.019 070 6
Beaker brush with wooden handle	85	430	1	9.019 080
Beaker brush with wooden handle	80	430	1	9.019 090
Beaker brush with extra long wooden handle	80	630	1	9.019 092
Rinsing brush**	60	220	1	9.019 110 7
Set*			1	9.019 002
Hinge glasses brush bristled fall, with hinge		440	1	6.237 788
Replacement head for Hinge glasses brush		43	1	6.266 904
Burette brush with 1m long wire handle	30	1000	1	9.019 100

* Set consisting of order numbers 9.019 010, 9.019 020, 9.019 030, 9.019 040, 9.019 050, 9.019 060, 9.019 070, 9.019 080, 9.019 090 and 9.019 092.

**Nylon



8 Cleaning brushes

ISOLAB

Pack of 10.
Brush with swivel head, head 21mm x 44mm x 24mm for vessels with NS 29/32 or diam. 24 mm, Length: 440 mm

Description	PK	Cat. No.
Brush with swivel head, head 21mm x 44mm x 24mm	10	6.242 423

11. Cleaning and sterilisation

Cleaning implements/Brushes-Hair brushes

1 LLG-Cleaning brushes

Excellent tools for washing and cleaning of all type of laboratory bottles, flasks, tubes, condensers, burettes, etc. Brush material is manufactured from highest quality of fibre/perlon for long life cycle. Brush stem is manufactured from corrosion proof twisted steel wire. Brush handle is manufactured from polypropylene and offers extreme easy handling and use of the brush. Unique handle design enables hanging of the brush to a convenient place for easy reach. Spherical sponge top part enables access to every corner of the labware and guarantees perfect cleaning results.



For	Description	Length mm	Figure	PK	Cat. No.
burettes and tubings	LLG-Cleaning brush 20x125mm	845	a	10	6.267 293
large size bottles	LLG-Cleaning brush 70x130mm	460	b	10	6.267 294
medium size bottles	LLG-Cleaning brush 50x110mm	460	c	10	6.267 295
small size bottles	LLG-Cleaning brush 40x110mm	380	d	10	6.267 296
test tubes	LLG-Cleaning brush 25x100mm	295	e	10	6.267 297
narrow test tubes	LLG-Cleaning brush 12x80mm	235	f	10	6.267 298

2 LLG-Weighing brush, with wooden handle

Fine hair weighing brush with pointed tips and wooden black handle. Excellent tool for cleaning of weighing boats, weighing dishes and analytical balances.



Description	PK	Cat. No.
LLG-Weighing brush	1	6.267 404

3 Brush bag

Empty, imitation leather bag, for 8 brushes.



Type	PK	Cat. No.
Brush bag	1	9.172 064

4 Hair brushes, oval

Black goat hair. In metal mounts on round wood handle.



Size	Diam. mm	PK	Cat. No.
0	6	1	9.172 025
1	7	1	9.172 026
2	8	1	9.172 027
3	9	1	7.655 206

5 Hair brushes, broad

Bear bristle. Blunt head. Flat stem.



Width mm	Hair length mm	Wall thickness mm	PK	Cat. No.
12.5	16	3.9	1	9.172 042
19.0	18	3.9	1	9.172 043
25.4	22	4.1	1	9.172 044

6 Red marten-hair brushes

Silver ferrule. Black enamelled round handle.



Size	Hair length mm	PK	Cat. No.
2/0	7	1	6.091 204
0	8	1	9.172 050
1	9	1	9.172 051
2	11	1	9.172 052
3	13	1	9.172 053
4	15	1	9.172 054
5	18	1	9.172 055
6	19	1	9.172 056

7 Balance brush

Oval.



Type	Size	Diam. mm	PK	Cat. No.
Brush	1	5	1	2.600 069
Brush	2	6	1	6.266 807
Brush	4	9	1	6.074 169
Brush	6	12	1	6.266 808
Brush set*	2, 4, 6		1	6.266 825

*consisting of one brush each size 2/6mm, size 4/9mm and size 6/12mm

11. Cleaning and sterilisation

Cleaning implements/Draining racks

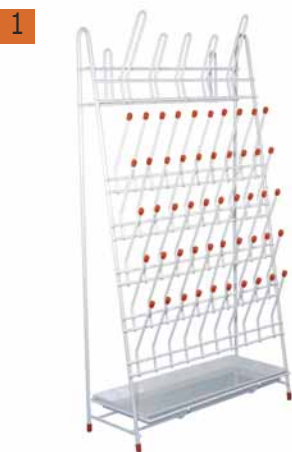

1 LLG-Draining racks, PE-coated wire

Wall or bench mounting for 50 reagent bottles and 5 flasks
With drip channel and plastic covered feet.
Dimensions (L x W x H): 360 x 130 x 650 mm.

Description	PK	Cat. No.
For 50 reagent bottles and 5 flasks	1	6.281 619



2 Draining racks, PE-coated wire

Wall or bench mounting. With drip channel and plastic covered feet.

With	Internal dimensions (L x W x H) mm	PK	Cat. No.
60 bars and 5 arches	420 x 160 x 610	1	9.003 305
24 bars and 20 arches	420 x 160 x 610	1	9.003 320



3 Draining rack, PS

Wall mounting, with wide draining trough. Pegs can be inserted as required. Kartell
Peg holes are sealed at the rear to prevent water leakage penetrating the wall behind.
Supplied with 72 pegs (15mm diameter, 95mm long), 11 small pegs (6mm diameter, 95mm long) drain tubing and fittings for wall mounting.
Dimensions (L x W x H): 450 x 110 x 630 mm

Description	Rods 95 x 15mm Quantity	Rods 95 x 6mm Quantity	PK	Cat. No.
Draining rack, wallmount possible	72	11	1	9.003 240
Place supports		11	11	9.003 032
Place supports	72		72	9.003 033



4 Draining rack LaboPlast®, PVC

The stable rods are individually placed into the holes of the draining rack and are clicked into place. Their positions can be changed at any time. Bürkle

Scope of supply draining rack with drain channel: Draining rack incl. wall mounting set (screws, dowels), removable drain channel incl. drainage connection and drain tube

Scope of supply draining rack without drain channel: Draining rack incl. wall mounting set (screws, dowels)

Description	Width mm	Height mm	Rods			PK	Cat. No.
			60 x 6 mm Quantity	100 x 10 mm Quantity	150 x 12 mm Quantity		
Without draining channel	400	400	5	26	2	1	9.003 344
Without draining channel	500	500	10	39	4	1	9.003 355
Without draining channel	600	600	15	56	6	1	9.003 366
With draining channel	400	400	5	26	2	1	9.003 374
With draining channel	500	500	10	39	4	1	9.003 375
With draining channel	600	600	15	56	6	1	9.003 376

11. Cleaning and sterilisation

Ultrasonic cleaners/Instruments

1 2 Mini-Ultrasonic Cleaner LLG-uniSONIC 1

For convenient cleaning of goggles or smaller laboratory instruments. Eco-friendly, only needs warm water. By ultrasonic sound millions of small air bubbles are generated. Combined with a very high pressure these achieve a fast, efficient and effortless cleaning.

- Ready to use, no assembly required
- Automatic 3-minute-operation can be stopped anytime
- Removable lid
- Stainless steel tank

Scope of supply: ultrasonic cleaning device, lid

Specifications

Capacity:	approx. 340 ml
Frequency:	45 kHz
cleaning performance:	30 Watt
Outer Dimensions (W x D x H) approx.:	200 x 115 x 115 mm
Dimensions tank (W x D x H) approx.:	155 x 80 x 40 mm
Weight:	630 g
Power supply:	220 ... 240 V, 50 Hz
Warranty:	3 years

Type	PK	Cat. No.
LLG-uniSONIC 1	1	6.263 560



3 Ultrasonic Baths, SONOREX SUPER

These devices work at 35kHz and have transducers for maximum cleaning power. SweepTec® for permanent sound field oscillation ensures even and gentle cleaning. Available with heating with adjustable temperature range from 30 to 80 °C . Power information: High ultrasonic peak power and nominal ultrasonic power 230V, 50/60Hz. All models are spill-proof with stainless steel tanks (RK 102H hard-chromium plated) and outer cases, drip proof (IP32).

For cleaning of technical glassware like burettes, pipettes, petri dishes and laboratory flasks, metal parts of all kinds, electronic components. Also suitable for cleaning and disinfection of medical instruments and acceleration of suspending processes, production of emulsions.

Type RK 102 H and above supplied with outlet
Type H with heating adjustable from 30 to 80 °C

Bandelin



Type	Capacity of the bath litres	Width of the interior mm	Depth of the interior mm	Height of the interior mm	PK	Cat. No.
RK 31 H	0.9	190	85	60	1	6.200 370
RK 31	0.9	190	85	60	1	9.877 021
RK 52	1.8	150	140	100	1	9.877 052
RK 52 H	1.8	150	140	100	1	9.877 051
RK 100	3.0	240	140	100	1	9.877 100
RK 100 H	3.0	240	140	100	1	9.877 101
RK 102 H	3.0	240	140	100	1	9.877 103
RK 103 H	4.0	240	140	150	1	9.877 114
RK 156	6.0	500	140	100	1	9.877 156
RK 156 BH	9.0	500	140	150	1	9.877 155
RK 255 H	5.5	300	150	150	1	9.877 256
RK 510	9.7	300	240	150	1	9.877 510
RK 510 H	9.7	300	240	150	1	9.877 511
RK 512 H	13.0	300	240	200	1	9.877 512
RK 514	13.5	325	300	150	1	9.877 540
RK 514 H	13.5	325	300	150	1	9.877 516
RK 514 BH	18.7	325	300	200	1	9.877 515
RK 1028	28.0	500	300	200	1	9.877 537
RK 1028 H	28.0	500	300	200	1	9.877 529
RK 1050	58.0	600	500	200	1	9.877 551
RK 1050 CH	90.0	600	500	300	1	9.877 552

Ultrasonic cleaners/Instruments

Ultrasonic Baths, SONOREX SUPER

Heavy duty ultrasonic baths for cleaning or sample treatment in aqueous liquids. Suitable for laboratory and respiratory protection area, industry, workshop and service area.

Bandelin

- Stainless steel tank and housing
- Drip water protected
- With integral tank drain tap (G 1/2) for easy emptying (RK 106 with G 1/4)
- Radio shielded

Models with Type addition H with adjustable temperature range.

Specifications

HF-Frequency: 35 kHz, SweepTec®
 Temperature range: 30 ... 80 °C
 Timer: 1 ... 15 min or continuous
 Power supply: 230 V~, 50/60 Hz
 IP code: IP 32

1

1 Ultrasonic sieve-bath SONOREX SUPER RK 106

Ultrasonic bath for cleaning of 1 test sieve with 200 mm diameter.

Bandelin

Please order sieve holder SH 7 separately.

Type	Capacity of the bath litres	Width of the interior mm	Depth of the interior mm	Height of the interior mm	Plug type	PK	Cat. No.
RK 106	5.6	240	240	130	EU	1	9.877 106
RK 106	5.6	240	240	130	UK	1	9.877 105
RK 106	5.6	240	240	130	CH	1	9.877 107

2

2 Ultrasonic sieve-bath SONOREX SUPER RK 1040

Ultrasonic bath for cleaning of 1 test sieve with 500 mm diameter.

Bandelin

Please order sieve holder GH 28 separately.

Type	Capacity of the bath litres	Width of the interior mm	Depth of the interior mm	Height of the interior mm	Plug type	PK	Cat. No.
RK 1040	39.5	500	500	195	EU	1	9.877 108

3

3 Ultrasonic sieve-bath Sonorex Super ultrasonic bath RK 1028 C

For 5 test sieves with 200 mm diameter. With handles on both sides.

Bandelin

Please order sieve holder SH 28 C separately.

Type	Capacity of the bath litres	Width of the interior mm	Depth of the interior mm	Height of the interior mm	Plug type	PK	Cat. No.
RK 1028 C	45	500	300	300	EU	1	9.877 528
RK 1028 C	45	500	300	300	UK	1	9.877 538
RK 1028 C	45	500	300	300	CH	1	9.877 539
RK 1028 CH	45	500	300	300	EU	1	9.877 530

Accessories please see page 1188.

1 Ultrasonic Baths SONOREX DIGITEC/SONOREX DIGIPLUS

Ultrasonic baths in stainless steel housing, time setting 1, 2, 3, 4, 5, 10, 15, 30 min and continuous, Type H with heating, adjustable temperature range from 20 to 80 °C and warning LED at excess temperature, degassing of liquids (DEGAS), Pulse function, SweepTec®. Power supply 230 V ~, 50/60 Hz.

Bandelin

SONOREX DIGIPLUS DL: Devices additionally with power setting 20 to 100%.

Type	Capacity of the bath litres	Width of the interior mm	Depth of the interior mm	Height of the interior mm	PK	Cat. No.
DT 31	0.9	190	85	60	1	9.877 830
DT 31 H	0.9	190	85	60	1	9.877 831
DT 52	1.8	150	140	100	1	9.877 832
DT 52 H	1.8	150	140	100	1	9.877 833
DT 100	3.0	240	140	100	1	9.877 834
DT 100 H	3.0	240	140	100	1	9.877 835
DT 102 H	3.0	240	140	100	1	9.877 836
DT 103 H	4.0	240	140	150	1	9.877 837
DT 156	6.0	500	140	100	1	9.877 838
DT 255	5.5	300	150	150	1	9.877 839
DT 255 H	5.5	300	150	150	1	9.877 840
DT 510	9.7	300	240	150	1	9.877 841
DT 510 H	9.7	300	240	150	1	9.877 842
DT 106	5.6	240	240	130	1	9.877 848
DT 156 BH	9.0	500	140	150	1	9.877 849
DT 512 H	13.0	300	240	200	1	9.877 850
DT 514	13.5	325	300	150	1	9.877 851
DT 514 H	13.5	325	300	150	1	9.877 852
DT 514 BH	18.7	325	300	200	1	9.877 853
DT 1028	28.0	500	300	200	1	9.877 854
DT 1028 H	28.0	500	300	200	1	9.877 855
DT 1028 CH	45.0	500	300	300	1	9.877 857
DT 1050 CH	90.0	600	500	300	1	9.877 860
DL 102 H	3.0	240	140	100	1	9.877 865
DL 156 BH	9.0	500	140	150	1	9.877 866
DL 255 H	5.5	300	150	150	1	9.877 867
DL 510 H	9.7	300	240	150	1	9.877 868
DL 512 H	13.0	300	240	200	1	9.877 869
DL 514 BH	18.7	325	300	200	1	9.877 870
DL 1028 H	28.0	500	300	200	1	9.877 871

1



Ultrasonic Baths Sonorex Digitec DT ... F - Basic equipment

Flat ultrasonic baths with fast degassing and for sample preparation.

Bandelin

- Sample preparation in laboratory flasks
- Fast degassing of samples at the push of the button
- Homogenising
- Same power density in all ultrasonic baths
- Reproducibility of results in the different bath sizes
- Uniform sonication of samples irrespective of size and arrangement of the flasks

Scope of delivery:

DT 510 F: flask holder GL 510 F and 250ml Tickopur R 33

DT 1028 F: 2 x flask holder GL 510 F and 250ml Tickopur R 33

Spring clamps EK or flask holders ZF are necessary to fix the laboratory flasks.

2



9.877 862

Type	Capacity of the bath litres	Width of the interior mm	Depth of the interior mm	Height of the interior mm	PK	Cat. No.
DT 510 F	4.3	300	240	65	1	9.877 862 2
DT 1028 F	9.5	500	300	65	1	9.877 863

Ultrasonic cleaners/Instruments



1 Suspension baskets for Sonorex ultrasonic baths

Stainless steel.

Bandelin

Optimal ultrasonic wave transmission. Items to be cleaned should not be placed on the bottom of the tank.
K 6: round, adjustable.

Type	For bath type	Width mm	Depth mm	Height mm	PK	Cat. No.
K 1 C	RK/DT 52 / 52 H	120	110	40	1	9.877 631
K 3 C	RK/DT 100 / 100 H / 102 H / 102 H-RC, DL 102 H	200	110	40	1	9.877 633
K 3 CL	RK/DT 103 H	200	110	40	1	9.877 632
K 5 C	RK/DT 255 H / 255 H-RC, DL 255 H	260	110	40	1	9.877 635
K 6	RK/DT 106	215	215	50	1	9.877 634
K 6 L	RK/DT 156	460	100	50	1	9.877 636
K 6 BL	RK/DT 156 BH, DL 156 BH	460	100	50	1	9.877 637
K 08	RK/DT 31 / H	170	65	50	1	9.877 630
K 10	RK/DT 510 / 510 H / 510 H-RC, DL 510 H	250	195	50	1	9.877 697
K 10 B	RK/DT 512 H, DL512 H	250	195	50	1	9.877 700
K 14	RK/DT 514 / H	275	245	50	1	9.877 694
K 14 B	RK/DT 514 BH / 514 H-RC, DL 514 BH	275	245	50	1	9.877 701
K 28	RK 1028/H / DT 1028 / H, DL 1028 H	455	245	50	1	9.877 698
K 28 C	RK/DT 1028 CH	455	245	50	1	9.877 702
K 28 CA **	RK1028 CH	470	270	215	1	9.877 712
K 28 CV *	RK1028 CH	470	270	215	1	9.877 713
K 50	RK 1050	545	450	50	1	9.877 699
K 50 C	RK/DT 1050 CH	545	450	50	1	9.877 703
K 50 CA ***	RK 1050 CH	540	445	240	1	9.877 715
K 50 CV **	RK 1050 CH	540	445	240	1	9.877 716

*3 sections

**6 sections

***9 sections



2 Handle adjusters, GV 3 and GV 10, for Sonorex insert baskets

The immersion depth of the baskets can be continuously adjusted using the handle adjuster prevents laboratory flasks from floating, tipping over or becoming flooded.
Quick and easy attachment to insert baskets or utensil holders (except GH 1).
1 pair.

Bandelin

Type	For baskets	PK	Cat. No.
GV 3	K 1 C, K 3 C, K 3 CL, K 5 CL, K 6 L, K 6 BL	1	9.877 720
GV 10	K 10, K 10 B, K 14, K 14 B, K 28, K 28 C, GH 10, GH 28	1	9.877 721



9.877 651

3 Flask Clips for Sonorex insert baskets

Stainless steel. Suitable for insert baskets and instrument holders with mesh size up to 12.5mm x 12.5mm and for glass holder GL for DT...F.
Essential for the attachment of laboratory flasks.

Bandelin



9.877 653

Type	PK	Cat. No.
EK 10 for insert baskets up to 31 mm dia.	1	9.877 651 3
EK 25 for insert baskets up to 42 mm dia.	1	9.877 653 4
EK 50 for insert baskets up to 52 mm dia.	1	9.877 655
EK 100 for insert baskets up to 65 mm dia.	1	9.877 657
EK 250 for insert baskets up to 85 mm dia.	1	9.877 658

1 Lids for Sonorex ultrasonic baths

Stainless steel.
For covering bath tanks, as outlined below.

Bandelin



Type	For bath type	PK	Cat. No.
D 08	RK/DT 31 / H	1	9.877 597
D 52	RK/DT 52 / 52 H	1	9.877 601
D 100	RK/DT 100 H / 102 H / 102 H-RC / 103 H, DL 102 H	1	9.877 603
D 6	RK/DT 106	1	9.877 606
D 156	RK/DT 156 BH, DL 156 BH	1	9.877 602
D 255	RK/DT 255 H / 255 H-RC, DL 255 H	1	9.877 605
D 510	RK/DT 510 / 510 H / 510 H-RC / 512 H, DL 510 H	1	9.877 610
D 514	RK/DT 514 / 514 H / 514 BH / 514 BH-RC, DL 514 BH	1	9.877 604
D 1028	RK 1028/H / DT 1028 H, DL 1028 H	1	9.877 607
D 1028C	RK/DT 1028 CH	1	9.877 600
D 1050 C	RK1050 CH	1	9.877 608
D 170	RK 170/H	1	6.230 773

2 Sonorex insert beakers

For positioning lids and beaker holders.
SD 06, PD 06, EB 05: with retaining ring
SD 05, KB 04, SD 04: with retaining ring, only for DE 08
SD 09: with retaining ring

Bandelin



Type	Capacity ml	Diam. mm	Height mm	Material	PK	Cat. No.
SD 04	400	76	110	Glass	1	9.877 624
SD 05	600	76	150	Glass	1	9.877 645
SD 06*	600	84	125	Glass	1	9.877 622
SD 09	1000	91	180	Glass	1	9.877 623
EB 05*	600	87	120	Stainless steel	1	9.877 626
KB 04	400	76	110	Plastic	1	9.877 644
PD 06*	600	86	125	Plastic	1	9.877 628

* with lid.

3 Inset baskets for SONOREX insert beakers

Mesh width: 1 x 1 mm.
KD 0: Stainless steel wire basket
PD 04: Plastic basket with sieve bottom

Bandelin



Type	For	Int. diam. mm	Material	PK	Cat. No.
PD 04	Inset beakers	60	Plastic	1	9.877 643
KD 0*	Inset beakers	75	Stainless steel	1	9.877 642

*not for SD 04, SD 05 and KB 04

4 Inset tubs for Sonorex ultrasonic baths

Unperforated plastic, with cover. For cleaning with aggressive liquids.

Bandelin



Type	For bath type	Internal dimensions (W x D x H) mm	PK	Cat. No.
KW 3	RK/DT 102 H / 102 H-RC / 103 H / 100 / H, DL 102 H	195 x 115 x 88	1	9.877 800
KW 5	RK/DT 255 H/-RC, DL 255 H	254 x 96 x 130	1	9.877 801
KW 14	RK/DT 514/H	280 x 215 x 145	1	9.877 802
KW 14 B	RK/DT 514 BH/-RC, DL 514 BH	275 x 210 x 195	1	9.877 803
KW 28-0	RK 1028/H, DT 1028 H/CH, DL 1028 H	437 x 230 x 155	1	9.877 804
KW 50-0	RK 1050	517 x 445 x 184	1	9.877 806
KW 50 B-0	RK1050 CH	445 x 520 x 284	1	9.877 717
KW 10-0	RK 510/H, DT 510/H/H-RC, DL 510 H	242 x 182 x 135	1	6.207 107

➔ Sieves please see page 594.

Ultrasonic cleaners/Instruments



1 Utensil and test sieve holder for Sonorex ultrasonic baths

Bandelin

Instrument and test sieve holder.

GH 1: Holder for 1L glass flasks, 105mm diameter.

SH 7: Sieve holder for test sieve 200mm diameter.

GH 10/28 instrument holders, stainless steel, mesh size 12.5mm x 12.5mm

Type	For bath type	Dimensions (W x D) mm	PK	Cat. No.
GH 1	RK/DT 52, RK/DT 100 / H, RK 103 H, RK/DT 102 H / H-RC, DT 103 H, DL 102 H	129 x 117	1	9.877 781
SH 7	RK/DT 106	-	1	9.877 784
GH 10	RK/DT 510 / 510 H / H-RC, DL 510 H	260 x 200	1	9.877 731
GH 28	RK 1028/H, DT 1028 H/CH, RK 1040	455 x 250	1	9.877 733
SH 28 C	RK 1028 C	-	1	9.877 746



2 Ultrasonic bath BactoSonic® 14.2

Bandelin

Ultrasonic special bath for a gentle removal of biofilms.

Scope of supply:

BactoSonic® 14.2: Ultrasonic bath only

BactoSonic® 14.2 SET: Ready-to-use Set consisting of

-Ultrasonic bath BS 14.2

-Scientifically proven description of the procedure

-Transport containers:

IB 5, PP, 0.52 l - 2 pcs

IB 6, PP, 0.6 l - 2 pcs

IB 10, PP, 1.0 l - 1 piece

IB 18, PP, 1.8 l - 1 piece

IB 20, PP, 2.0 l - 1 piece

BT 5, PC, for 2 pcs IB 5

BT 6, PC, for 2 pcs IB 6

BT 10, PC, for 1 piece IB 10

BT 18, PC, for 1 piece IB 18

GH 14, stainless steel, for 3 pcs IB 20

FT 14

TICKOPUR R 33 - 250 ml (concentrate)

-Container carriers for transport containers:

-Utensil holder for transport containers:

-Frame for foil test:

-Contact liquid:

Type	Capacity of the bath litres	Width of the interior mm	Depth of the interior mm	Height of the interior mm	PK	Cat. No.
BactoSonic® 14.2, bath only	13.5	325	300	150	1	7.920 371
BactoSonic® 14.2 SET	13.5	325	300	150	1	9.650 290



3 Container holders, PC for BactoSonic® 14.2

Bandelin

Type	For	PK	Cat. No.
BT 5	IB 5	1	9.650 311
BT 6	IB 6	1	9.650 312
BT 10	IB 10	1	9.650 313
BT 18	IB 18	1	9.650 314

Transport containers, PP for BactoSonic® 14.2

Bandelin

Type	Capacity L	Dimensions mm	PK	Cat. No.
IB 5	0.5	145 x 110 x 67	5	9.650 291 4
IB 6	0.6	dia. 142 x 68	5	9.650 292 5
IB 10	1.0	278 x 115 x 60	5	9.650 293 6
IB 18	1.8	208 x 143 x 94	5	9.650 294 7
IB 20	2.0	135 x 102 x 282	5	9.650 295 8



9.650 291



9.650 292



9.650 293



9.650 294



9.650 295

1 Ultrasonic bath SONOCOOL® 255

1

Bandelin

Ready-to-use set consisting of:

- Ultrasonic bath SC 255
- Sample holder PH 255-11 for 11 inset beakers SD 01.2
- Lid made of glass D 255 G
- Inset beakers SD 01.2, glass - without spout, 20 pieces of 100 ml,
- 250 ml TICKOPUR TR 3 (contact liquid concentrate)



Specifications

Inner tank dimensions (W x D x H):	280 x 150 x 150 mm
Tank volume:	5 litres (contact liquid)
Adjustable temperature range:	4 - 40 °C (at 20 °C room temperature)
Cooling power:	200 W
Ultrasonic peak power:	720 W
Ultrasonic nominal power:	180 W
Power setting:	adjustable: 25/50/75/100 %
Ultrasonic frequency:	35 kHz, SweepTec®
Timer:	10 s - 99 h 59 min 59 s (countdown)
External dimensions (W x D x H):	360 x 605 x 385 mm
Housing:	aluminium: coated with flush pulls (grips recessed inside the housing)
Outlet:	front left, concealed
Current consumption:	1.6 A
Mains connection:	230 V~ (±10 %) 50/60 Hz
Weight:	27.5 kg
IP code:	IP 31

Type	Capacity of the bath litres	Width of the interior mm	Depth of the interior mm	Height of the interior mm	PK	Cat. No.
SONOCOOL® 255	5	280	150	150	1	9.650 300

2 Ultrasonic pipette cleaner PR 140 DH

2

Bandelin

Ultrasonic cleaning of plastic or glass pipettes, burettes and other glassware.

Short cleaning times, no time-consuming washing.

- Gentle cleaning of volume-measuring devices and parts with lengths up to 755 mm
- Pulse function
- With heating for dissolving grease residues
- Robust tank of stainless steel 1.4301, 1.5 mm
- Tilt handles for easy transport
- Placement on the floor nearby the drain
- Cleaning liquid for multiple use, fast emptying by ball valve

Scope of supply:

Ultrasonic bath PR 140 DH incl. pipette basket K 140 B, lid 140 D, cleaning concentrate TICKOPUR R 33 (5 l) and TICKOPUR TR 3 (1 l)



Danger

H phrases: H315|H318

Specifications

Effective capacity:	9 ... 18 l
Effective cleaning depth:	850 mm
Ultrasonic output max.:	800 W
Ultrasonic nominal power:	200 W
Ultrasonic frequency:	35 kHz, SweepTec®
Adjustable temperature range:	20 ... 80 °C
Heating capacity:	700 W
Timer:	1, 2, 3, 4, 5, 10, 15, 30 min, continuous
Dimensions, outer (L x W x H):	330 x 330 x 1003 mm (without handles and stopcock)
Dimensions, inner (L x W x H):	150 x 150 x 895 mm
Weight:	28.2 kg
Power supply:	230 V~, 50/60 Hz
IP code:	IP 33

Type	Capacity of the bath litres	Width of the interior mm	Depth of the interior mm	Height of the interior mm	PK	Cat. No.
Set PR 140 DH	18	150	150	895	1	6.280 456



1



1 Ultrasonic Bath with Shaking Device SONOSHAKE

Bandelin

Consisting of:

Ultrasonic bath Sonorex Digitec DT 1028 F

- Especially for sonification of samples in laboratory flasks and for rapid degassing (DEGAS)
- Low-profile, ultrasonic bath with stainless steel tank, inner dimensions 500mm x 300mm x 65mm (L x W x D)
- Housing made of stainless steel, protected against spray, 535mm x 325mm x 205mm (L x W x H)
- Outlet: G $\frac{1}{2}$ ball valve
- Timer: 1, 2, 3, 4, 5, 10, 15, 30 min, or continuous
- Ultrasonic peak power 1280W
- Ultrasonic nominal power 320W
- Working frequency 35kHz, SweepTec®
- Current consumption 1.4A

Shaking device SA 1028

- Analogue setting of time (1 to 15 min, or continuous) and shaking frequency
- Reciprocating motion: settings in 4 steps possible of up to 200/min
- Constant amplitude of 20mm independent of loading
- Rack easy to remove - easy mounting of the laboratory clamps EK 10-250 (separately to order)
- Footprint approx. 410mm x 280mm (L x W)
- Holds 36 x 10ml, 36 x 25ml, 18 x 50ml, 12 x 100ml or 10 x 250ml flasks

- Bench space required for Sonoshake approx. 850mm x 360mm (L x W)

An existing SONOREX DIGITEC DT 1028 F ultrasonic bath can easily be retrofitted with the shaker attachment SA 1028.

Type	Capacity of the bath litres	Width of the interior mm	Depth of the interior mm	Height of the interior mm	PK	Cat. No.
SONOSHAKE	9.5	500	300	65	1	9.877 864

2



6.280 063

Sound proof boxes USBB series

Sonation GmbH

The USBB series has been developed especially for the noise insulation of ultrasonic baths in the laboratory.

Advantages:

- High noise reduction up to 30dB(A). That means a drop in noise of 90 to 95%
- Available in four different sizes for mostly all ultrasonic baths, compatibility list for Bandelin Ultrasonic baths on request
- The cover can be completely opened, so the removal of the basket is very easy to handle
- Smooth and easy handling of the cover, no additional space needed when opening, so the box can be placed and operated under extractor hoods
- Control panel stays visible. Thanks to the transparent front, the progress of the washing program can be observed anytime
- Equipped with fast access openings on the front and both sides to operate the ultrasonic bath or to drain the cleaning agent
- Integrated fan to remove vapors
- Recessed grips on the sides for easy transportation
- Powder coated, robust and easy cleanable surface

Type	External dimensions (W x D x H) mm	Internal dimensions (W x D x H) mm	Weight kg	PK	Cat. No.
USBB-S	512 x 350 x 125	454 x 269 x 316	15	1	6.280 063 2
USBB-L	607 x 460 x 633	529 x 379 x 496	25	1	6.280 064

Concentrates for ultrasonic baths TICKOPUR

Concentrates for SONOREX ultrasonic cleaning baths. Enhances cavitation, cleans intensively, kind to most materials and free from chloride. For use cold or warmed up.

Bandelin

TICKOPUR R 33: Universal cleaner, concentrate. Properties: mildly alkaline pH 9.9 at 1%, dosage 3 to 5%. For: metal, light metals, glass, ceramics, plastic, rubber, e-filters, respirators. Against: grinding, polishing and lapping residues, oily and greasy soiling, waxes, silicone films, ink.

TICKOPUR RW 77: Special cleaner with ammonia, concentrate. Properties: mildly alkaline, pH 9.9 at 1%, dosage 5%. Based on: surfactants, ammonia. For: metal, glass, ceramics, plastic, rubber, boards, watches, test sieves. Beware of light metals. Against: resin, soot, pigments, polishing and lapping residues, greases, oils, waxes, stains, flux.



Danger

H phrases: H315|H318

1



9.192 605

Type	Capacity Litres	PK	Cat. No.
TICKOPUR R 33	1	1	9.192 601
TICKOPUR R 33	2	1	9.192 602
TICKOPUR R 33	5	1	9.192 605 1
TICKOPUR R 33	25	1	9.192 610
TICKOPUR RW 77	1	1	9.192 611
TICKOPUR RW 77	2	1	9.192 612
TICKOPUR RW 77	5	1	9.192 615

* Transport regulations for dangerous goods have to be observed.

Further products can be found in our online shop.

Concentrates for ultrasonic baths STAMMOPUR

STAMMOPUR concentrates have been especially developed for ultrasonic application and are marked CE according to the Medical Devices Directive (MDD). All solutions are environmentally friendly, biodegradable and easy to dispose. STAMMOPUR contains special active substances and adjuvants which achieve an optimal disinfecting and cleansing effect while at the same time sparing the instruments

Bandelin

STAMMOPUR 24*: Intensive disinfection and cleaning concentrate. VAH-certified-bactericidal, yeasticidal virucidal against BVDV, Vaccinia, HBV, HCV, HIV. Effectiveness EXAM - expertise against H5N1. Free from aldehydes, chlorine and phenol. Application 1% to 2%, mildly alkaline, pH 9.9 (1%). Highly compatible with most materials.

STAMMOPUR DR 8*: Instrument disinfection and intensive cleaning concentrate. VAH-certified. Without aldehydes-, phenols and chlorine. Bactericidal, virucidal against Vaccinia, BVDV, Papova, Adeno, HBV, HCV, HIV, H5N1. Application 1 % to 3 %, mildly alkaline, pH 9.9 (1%).

This product is a disinfectant containing biocides. Please inquire its availability and legal information.



Danger

H phrases: H302|H314|H317|H334|H336|H361fd|H411

2



9.192 711

Type	Capacity Litres	PK	Cat. No.
STAMMOPUR 24*	2	1	9.192 711 2
STAMMOPUR 24*	5	1	9.192 712
STAMMOPUR 24*	25	1	9.192 714
STAMMOPUR DR 8*	2	1	6.201 247
STAMMOPUR DR 8*	5	1	6.900 236

* Transport regulations for dangerous goods have to be observed.

Further products can be found in our online shop.

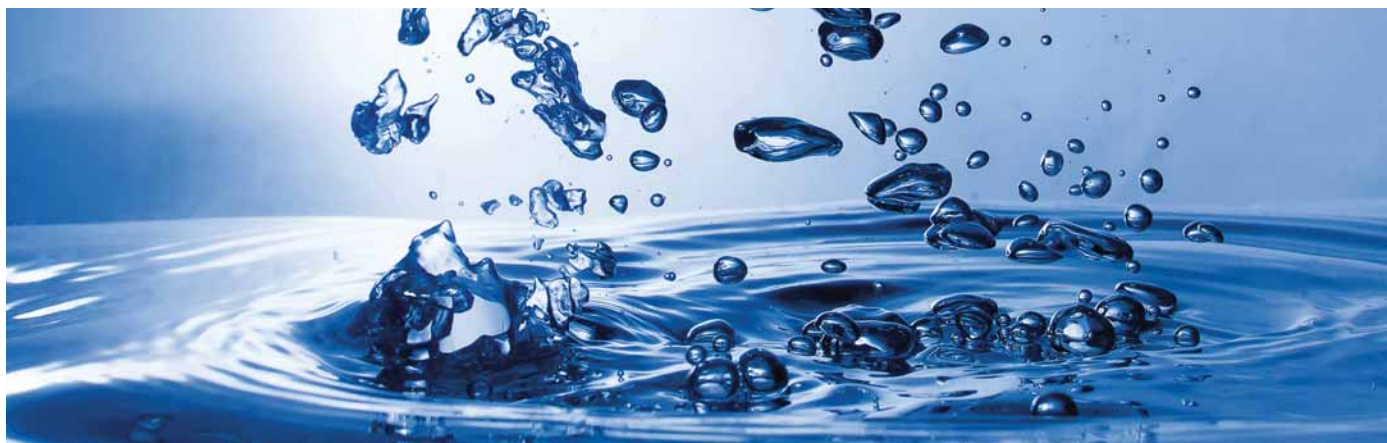

Strong and flexible: Miele lab washers in three size categories

Miele Professional. Immer Besser.



Miele sets new standards with three model series when it comes to performance, safety and user-friendliness in the reprocessing of laboratory glassware.

- PLW 86* large-chamber lab washers in two widths
- Space-saving SlimLine units with ample capacity on a small footprint
- Compact lab washers* – also as undercounter models
- With EasyLoad – Miele's highly flexible loading system

www.miele.com

Perfectly matched
System4Lab -
Single-source supply



1 2 Washer-disinfector PG 8583/PG 8583 CD/PG 8593

Miele

PG 8583

- Capacity per cycle: e.g. 128 laboratory flasks or 98 pipettes together with other laboratory glassware
- Efficient use of resources with the variable speed heater pump
- Monitored for reliability: Wash pressure and spray arm monitoring
- Convenient drying assistance: EcoDry function
- Total security: Link to process documentation possible
- Depending on version, up to 2 integrated dispenser pumps for liquid products

PG 8593

- Additionally with integrated DryPlus hot-air drying

PG 8583 CD

- Additionally conductivity monitoring
- Efficient hot air drying: Dry Plus
- Two integrated dosing pumps (liquid detergent, neutralising agents)
- Setting options for chemical agents (3 x 5l/2x 10l)

In several countries different machine versions of Miele washer-disinfector are available (type, electrical connections etc.)

Specifications

Dimensions (W x D x H)

PG 8583 + PG 8593: 600 x 600 x 835 (820 without lid)mm

PG 8583 CD: 900 x 600 x 820 mm

Controls: TouchControl

Water connection: 2x cold-, hot- and de-min. water

Power supply: 3N AC/400 V/50 Hz/9.3 kW

Type	Housing	Description	PK	Cat. No.
PG 8583	White	Powder dispensing*	1	6.266 426
PG 8583	White	Liquid dispensing*	1	6.266 427
PG 8583	Stainless steel	Powder dispensing*	1	6.266 428
PG 8583	Stainless steel	Liquid dispensing*	1	6.266 429
PG 8583	Stainless steel	Powder dispensing**	1	6.266 430
PG 8583	Stainless steel	Liquid dispensing**	1	6.266 431
PG 8583	Stainless steel	Powder dispensing, oil application*	1	6.266 432
PG 8583	Stainless steel	Liquid dispensing, oil application*	1	6.266 433
PG 8593	Stainless steel	with DOS module	1	6.266 434
PG 8593	Stainless steel	with conductivity monitoring and DOS module	1	6.266 435
PG 8593	Stainless steel	with DOS module, suitable for oil applications	1	6.266 436
PG 8583 CD	Stainless steel	with water-connection conductivity module*	1	6.269 767
PG 8583 CD	Stainless steel	demineralised water pump, with water-connection conductivity module**	1	6.287 715
PG 8583 CD	Stainless steel	with water-connection conductivity module, oil application*	1	6.280 201

*hot water and distilled water connection

**hot water connection, distilled water pump

1



2



11. Cleaning and sterilisation

Washers, disinfectors/Instruments-Accessories

1 2 Baskets and carriages for Miele Laboratory Washers and Disinfectors

Easy Load:

- New injector system for all common injector modules and a large number of further load carriers
- Optimum use of available vertical clearance
- Particularly fast and simple arrangement of load
- Thorough internal cleaning of glassware of all shapes and sizes
- Secure hold and exceptional material protection during wash cycle

Miele

Type	Description	For	PK	Cat. No.
A 100	Upper basket for modules	PG 8583 / PG 8593	1	6.266 437
A 101	Upper basket / mounting height 160 ±30mm	PG 8583 / PG 8593	1	6.266 438
A 102	Upper basket / mounting height 205 ±30 mm	PG 8583 / PG 8593	1	6.266 439
A 103	Upper basket for lids and accessories	PG 8583 / PG 8593	1	6.266 440
A 301/5	Module for laboratory glassware 2 x 9, 18 injector nozzles	PG 8583 / PG 8593	1	4.666 032
A302/3	Module for laboratory glassware 2 x 16, 32 injector nozzles	PG 8583 / PG 8593	1	4.666 034
A 150	Lower basket for modules	PG 8583 / PG 8593	1	6.266 441
A 151	Lower basket (W x D x H): 529 x 522 x 88mm, mounting height depending on upper basket	PG 8583 / PG 8593	1	6.266 442
A 200	Carriage for pipettes	PG 8583 / PG 8593	1	6.266 448
A 202	Carriage for sieve trays	PG 8583 / PG 8593	1	6.266 444
A 861	Holding frame for A 301/4 and A 301/5	PG 8583 / PG 8593	1	4.666 339
A 862	Holding frame 4 x 8	PG 8583 / PG 8593	1	4.667 530

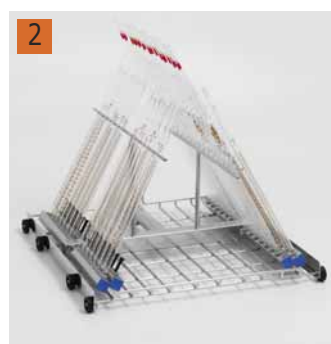

Modules for Miele Laboratory Washers and Disinfectors

Miele

Type	Description	For	PK	Cat. No.
A 300/3	Module for laboratory glassware with 8 nozzles	PG 8583 / PG 8593 / 120 series	1	4.666 033
A 301/5	Module for laboratory glassware 3 x 6, 18 injector nozzles	PG 8583 / PG 8593	1	4.666 032
A302/3	Module for laboratory glassware 4 x 8, 16 injector nozzles	PG 8583 / PG 8593	1	4.666 034
A 861	Holding frame for A 301/4 and A 301/5	PG 8583 / PG 8593	1	4.666 339
A 862	Holding frame 4 x 8	PG 8583 / PG 8593	1	4.667 530

Accessories for Miele Laboratory Washers and Disinfectors

Miele

Type	Description	For	PK	Cat. No.
A2	Net 1/2, 216 x 456 mm	PG 8583 / 8593	1	9.803 720
A 3	Net 1/4, for inserts 1/4 metal frame	PG 8583	1	9.803 738
DE-CS7	Stainless-steel lid	PG 8583	1	6.401 199
ML/2	Magnetic strip for automatic mobile unit recognition	PG 8583	1	9.803 766
A 11/1	Frame 1/1, 450 x 450 mm	PG 8583 / 8593	1	9.803 737
A12	Frame 1/2	PG 8583 / 8593	1	9.803 719
A 802	Flushing nozzle for injector modules	PG 8583 / 8593	1	6.266 443
E 313	Wall fitting	PG 8056 / 8057 / 8172	1	9.803 759
E 314	Floor fitting	PG 8056 / 8057 / 8172	1	9.803 760
E 315	Disposable ion exchange resin for E 318	PG 8583 / 8593 / 8056 / 8057 / 8172	1	9.803 755
E 316	Resin dispensing set	PG 8583 / 8593 / 8056 / 8057 / 8172	1	9.803 756
E 336	Pipette sleeve MIBO	PG 8583 / 8593	1	9.803 765
DOS K 85/1	Dosing module for PG 8583/8593 with short suction lance (5-l-container)	PG 8583 / 8593	1	6.266 457
DOS K 85	Dosing module for PG 8583/8593 with long suction lance (10-l-container)	PG 8583 / 8593	1	6.266 458
VE P 2800	cartridge stainless steel filled	PG 8583 / 8593 / 8056 / 8057 / 8172	1	6.280 202
HEPA filter		PG 8583	1	6.235 680
Coarse filter		PG 8583	1	7.646 222

 Note: We can supply products from the entire Miele laboratory range, on request.

CertoClav tabletop autoclaves

Its versatility and compact construction make autoclaves especially interesting for small labs or they can be used as an optimal addition to a large autoclave.

CertoClav

All models: Low-maintenance. No water connection required. Compliant with 2014/35/EU Low Voltage Directive, 2014/30/EU EMV Directive, 2011/65/EU Directive on the restriction of the use of certain hazardous substances in electrical and electronic equipment.

Vertical models: Class N steam sterilisers. Venting procedure: free steam flow process or fractional flow procedure. A heater is integrated in the bottom of the chamber, but it is not exposed. Therefore, it cannot calcify. The autoclaves are easy to transport and location independent. All you need is a power supply and a mixture of tap water and demineralised water. Safeguarded by a multiple safety system. In aluminum models, it consists of an overpressure valve, a pressure valve, a safety lock inside the lid to prevent opening under pressure and the overpressure safety cavity. In stainless steel models, it consists of an overpressure valve, a pressure valve, a safety lock inside the lid to prevent opening under pressure and a two-bimetal safeguard to prevent overheating of the device.

1 Tabletop autoclaves CertoClav EL

The vertical laboratory autoclave with valve control is suitable for sterilisation of unpackaged solids without hollow bodies, liquids, bottles, instruments, synthetic materials, food preservation, culture media preparation and waste. A precision manometer with drag pointer and a precision thermometer ensure that operations and processes are precise. This autoclave is available in two versions, each with two temperature levels. Pressure control via valve, temperature control via thermostat. Pressure valves are not interchangeable, because the thermostat of the device is perfectly adapted and calibrated to the valve.

CertoClav

Scope of supply: Autoclave, stable instrument panel with 3 feeds, minimum water level indicator, power cable

Specifications	EL 12 // EL 18
Chamber diameter:	240 mm
Chamber depth:	260 // 390 mm
Air evacuation:	Free steam flow process
Chamber material:	Aluminium
Operating pressure:	2.7 bar
Heating capacity:	1900 W
Power supply:	230 V ±10 %/50 - 60 Hz

Type	Capacity Litres	Working Temp. range °C	Weight kg	PK	Cat. No.
EL 12	12	125 / 140	6.2	1	9.842 013
EL 12	12	115 / 121	6.2	1	6.243 349
EL 18	18	125 / 140	7.6	1	9.842 014
EL 18	18	115 / 121	7.6	1	6.232 206

1



2 Tabletop autoclaves CertoClav Classic

CertoClav Classic is the result of further development of the EL, but made of corrosion resistant, electropolished stainless steel. Suitable for sterilisation of unpackaged solids without hollow bodies, liquids, bottles, instruments, synthetic materials, food preservation, culture media preparation and waste. A timer is integrated.

CertoClav

Scope of supply: Autoclave, stable instrument panel with 3 feeds, minimum water level indicator, power cable

Specifications	260 mm
Chamber diameter:	350 mm
Chamber depth:	Free steam flow process
Air evacuation:	Stainless steel
Chamber material:	2.7 bar
Operating pressure:	1300 W
Heating capacity:	230 V ±10 %/50 - 60 Hz
Power supply:	

Type	Capacity Litres	Working Temp. range °C	Weight kg	PK	Cat. No.
Classic	18	125 / 140	8.8	1	9.842 028
Classic	18	115 / 121	8.8	1	9.842 029

2



1



9.842 030

Laboratory autoclaves CertoClav MultiControl 2

CertoClav

The PT100 sensor-controlled, vertical laboratory autoclave is suitable for extended/long-term cycles, material tests, HAST test, pressure vessel test und ICP - TM 650, food preservation, culture media preparation, sterilisation of waste, unpackaged solids without hollow bodies, liquids, bottles, instruments, synthetic materials and rubber. Basic version of PC software for data monitoring is included. With this software, you can only set single-step programs. For multi-step programs, PC software professional version is required.

The CertoClav MultiControl 2 Touch is additionally equipped with a 7-inch robust high-resolution tablet. The operating steps are explained with videos on the screen.

- Programmable from 1 minute to 30 days and from room temperature to 140 °C
- Automated process control and error detection
- USB port
- Printer port (RS232) for printing sterilisation protocols

Scope of supply:

MultiControl 2: Autoclave, stable instrument panel with 3 feeds and minimum water level indicator, power cable, MC2 controller

MultiControl 2 touch: Autoclave, stable instrument panel with 3 feeds and minimum water level indicator, power cable, MC2 controller, tablet

2



6.268 833

Specifications

Chamber diameter:	260 mm
Chamber depth:	350 mm
Air evacuation:	Fractional flow procedure
Chamber material:	Stainless steel 316L
Operating pressure:	2.7 bar
Heating capacity:	1300 W
Power supply:	230 V ±10 %/50 - 60 Hz

Type	Capacity Litres	Working Temp. range °C	Weight kg	PK	Cat. No.
MultiControl 2	18	20 ... 140	9.5	1	9.842 030 1
MultiControl 2 Touch	18	20 ... 140	10.5	1	6.268 833 2

3



Laboratory autoclaves CertoClav Connect

CertoClav

The fully automated, vertical laboratory autoclave is suitable for extended/ long- term cycles, material tests, HAST Test, pressure vessel test, ICP - TM 650, food preservation, culture media preparation, sterilisation of waste, unpackaged solids without hollow bodies, liquids, bottles, instruments, synthetic materials and rubber. It is operated via of a 7-inch high-resolution tablet. All operating steps are explained with videos directly on the tablet. Compliance with GLP requirements through automatic documentation of users and cycles. Process protocols are stored in the CertoCloud for 10 years. Integration into laboratory data systems possible. For autoclaving liquids, a PT100-media sensor is optionally available.

Scope of supply: Autoclave, stable instrument panel with 3 feeds, minimum water level indicator, power cable, tablet

Specifications

Chamber diameter:	260 mm
Chamber depth:	350 mm
Air evacuation:	Fractional flow procedure
Chamber material:	Stainless steel 316L
Operating pressure:	2.7 bar
Heating capacity:	1300 W
Power supply:	230 V ±10 %/50 - 60 Hz

Type	Capacity Litres	Working Temp. range °C	Weight kg	PK	Cat. No.
Connect	18	20 ... 140	16	1	9.842 031
Media sensor, PT100 *				1	9.842 037

* only available in conjunction with a new device

1 Laboratory autoclaves CertoClav Cibus



The fully automatic, freely programmable, vertical laboratory autoclave is suitable for sterilisation of food, beverages, culture media and demineralised water in sealed bottles. For autoclaving liquids, a PT100-media sensor is integrated. It is operated via of a 7-inch high-resolution tablet. All operations are explained with videos directly on the tablet. Compliance with GLP requirements through automatic documentation of users and cycles. Process protocols are stored in the CertoCloud for 10 years. Integration into laboratory data systems possible. Optimised sterilisation time due to active rapid cooling. The autoclave is equipped with support pressure.

Scope of supply: Autoclave, stable instrument panel with 3 feeds, minimum water level indicator, power cable, tablet



Specifications

Chamber diameter:	260 mm
Chamber depth:	350 mm
Air evacuation:	Fractional flow procedure
Chamber material:	Stainless steel 316L
Operating pressure:	2.7 bar
Heating capacity:	1300 W
Power supply:	230 V ±10 %/50 - 60 Hz

Type	Capacity Litres	Working Temp. range °C	PK	Cat. No.
Cibus	18	25 ... 140	1	6.311 937

2 Tabletop autoclaves CertoClav Vacuum Pro series

CertoClav

Due to the intelligent combination of vacuum, pressure and steam, the autoclaves are suitable for liquids and solids of all kinds. The additional media sensor guarantees a complete sterilisation of liquids such as culture media. Solids of all kinds and hollow materials are optimally sterilised with the help of a vacuum pump. The preheatable chamber, cooling-ventilation and vacuum pump guarantees short cycle times from 20 minutes including drying time.

- 7-inch touchscreen
- Including free CertoCloud software for all protocols and programs
- Remote maintenance, alarm system via PC, tablet or smartphone
- Notification by e-mail and SMS
- 12 customisable programs (45 l version with 8 customisable programs)
- Interfaces: USB, WiFi, Ethernet, Bluetooth, SD-Card
- Integrated documentation (GMP/GLP conform)
- Standard interfaces for bar scanner, protocol and label printer

Scope of supply: Autoclave, tray set, power cable, touchscreen



6.288 411

Specifications

Temperaturrange:	105 ... 134 °C
Cooling system:	Air venting
Chamber material:	Stainless steel 304L
Operating pressure:	2.3 bar
Heater power:	2400 W
Power supply:	220 V ±10 %/50 - 60 Hz



9.842 009

Type	Capacity Litres	Int. diam. mm	Int. depth mm	External dimensions (W x D x H) mm	Weight kg	PK	Cat. No.
Vac Pro 12	12	200	360	500 x 610 x 430	51	1	6.287 463
Vac Pro 22	22	250	450	500 x 650 x 430	55	1	6.288 411 2
Vac Pro 45	45	319	617	640 x 840 x 560	120	1	9.842 009 3

11. Cleaning and sterilisation

Steam sterilisers - Autoclaves/Instruments

1



1 Accessories for Autoclaves, CertoClav

Service kit 1: with lid gasket, valve gasket, gasket for exhaust cock and manometer, steam valve

CertoClav

Service kit 2: with lid gasket, control valve gasket, seals for exhaust cock and pressure gauge, steam valve and safety valve

Service kit 3: with door gasket, safety valve and bacteria filter

Description	For	PK	Cat. No.
Exhaust steam container with hose	EL, Classic, MultiControl, MultiControl 2	1	6.313 654
Exhaust hose	EL, Classic, MultiControl, MultiControl 2	1	4.668 551
Exhaust air filter incl. exhaust container and exhaust hose	MultiControl, MultiControl 2	1	6.266 073
Bacteria filter	Vac Pro 12, Vac Pro 22, Cibus Pro	1	6.311 844
Barcode scanner	Vac Pro 12 - 45, Cibus Pro	1	6.273 378
CertoCloud premium licence	MultiControl 2, Connect, Cibus, Cibus Pro, Vac Pro 12 - 45	1	7.910 770
CertoServer	MultiControl 2, Connect, Cibus, Cibus Pro, Vac Pro 12 - 45	1	6.313 656
Water distiller	All models	1	6.272 938
Wire basket with drip tray	Vac Pro 12	1	6.313 657
Wire basket with drip tray	Vac Pro 22, Cibus Pro	1	6.313 658
Wire basket with drip tray	Vac Pro 45	1	6.313 659
Wire basket with handle, Ø 23 x 17 cm	EL, MultiControl	1	9.842 025
Wire basket with handle, Ø 25 x 23 cm	Classic, MultiControl 2, Connect, Cibus	1	9.842 035
Replacement filter cartridge	Exhaust air filter	1	6.313 655
Label printer	Vac Pro 12 - 45, Cibus Pro	1	6.313 660
PC software professional version	MultiControl, MultiControl 2	1	9.842 038
Log printer	MultiControl, MultiControl 2, Vac Pro 12 - 45, Cibus Pro	1	9.842 033
Service set 1	EL, MultiControl	1	9.842 036
Service set 2	Classic, MultiControl 2, Connect, Cibus	1	9.842 020
Service set 3	Vac Pro 12, Vac Pro 22, Cibus Pro	1	6.272 936
Thermal direct labels	Label printer	1	6.313 994
Thermal paper	Log printer	1	6.288 989

Digital horizontal autoclave Type AH

This autoclave is microprocessor controlled and monitored with 10 sterilisation programmes of which 4 are fixed and 6 are freely selectable and has bacteriological filters included by default.

Raypa

- Operating temperature range 100 °C to 134 °C
- On request, also available with B Class
- RS 232 interface
- Fully automatic functions
- With water reservoir, pre-vacuum and drying
- Case and lid shrouding are AISI 304 stainless steel
- Sterilisation chamber, lid and sealing system are AISI 316 stainless steel
- Electrical heating with protected heating elements
- Safety pressure valve
- Safety thermostat
- Automatic steam controlled by Touch Screen microprocessor
- Manual valves for emptying the sterilisation chamber and for draining steam
- Equipped with mesh stand on the chamber base and trays
- Supply requirements: 230 V 16 A single phase

Type	Capacity Litres	Chamber diam. x depth mm	Width mm	Length mm	Height mm	Rating W	PK	Cat. No.
AH-21 L	21	250 x 430	680	590	425	2000	1	9.851 898
AHS-50 DRY	50	400 x 400	760	780	630	2000	1	6.267 579
AHS-75 DRY	75	400 x 600	760	980	630	3200	1	9.851 888

On request also available counter-pressure, steam generator or without vacuum and drying.

2



6.267 579

Digital vertical autoclaves, AES series

These autoclaves are microprocessor controlled and monitored with 10 sterilisation programmes of which 4 are fixed and 6 are freely programmable.

- Operating temperature range 100 °C to 134 °C
- On request also available with with vacuum pump and steam generator
- Agar modus (40 °C to 80 °C)
- RS 232 interface
- Timer
- Programmable auto-start (24 h)
- Fully automatic functions
- Case and lid shrouding are AISI 304 stainless steel
- Sterilisation chamber, lid and sealing system are AISI 316 stainless steel
- Electrical heating with protected heating elements in the interior of the chamber
- Safety pressure valve
- Safety thermostat
- Automatic steam controlled by microprocessor
- Manual valves for emptying the sterilisation chamber and for draining steam

- Supply requirements:

AES-12 and AES-75: 230 V 16 A single phase

AES-110 and AES-150: 400 V + Neutral (3-phase)

Raypa

1



9.851 894

Type	Capacity	Chamber diam. x depth	Width	Length	Height	Rating	PK	Cat. No.
	Litres	mm	mm	mm	mm	W		
AES-12	12	250 x 270	490	500	650	1000	1	9.851 893
AES-28	28	300 x 400	510	560	1120	2000	1	9.851 894 1
AES-50	50	300 x 700	510	560	1300	3200	1	6.267 578
AES-75	75	400 x 600	620	730	1190	3200	1	9.851 895
AES-110	110	400 x 850	620	730	1440	4500	1	9.851 896
AES-150	150	500 x 750	760	850	1400	6000	1	9.851 897

Accessory baskets for Digital vertical autoclaves, AES series

Type	For	Diam.	Height	Baskets per autoclave	PK	Cat. No.
		mm	mm			
Mesh basket	AES 12	220	200	1	1	6.268 955
Mesh basket	AES 28 - 50	270	200	2 / 3	1	6.270 951
Mesh basket	AES 75 - 110	370	280	2 / 3	1	6.261 937 2
Mesh basket	AES 150	470	250	2	1	6.260 676
Solid basket	AES 28 - 50	280	200	2 / 3	1	9.851 876
Solid basket	AES 75 - 110	380	260	2 / 3	1	9.851 877
Solid basket	AES 150	475	360	2	1	9.851 879

2



6.261 937



11. Cleaning and sterilisation

Steam sterilisers - Autoclaves/Instruments



TLV-50

1 2 Smart vertical autoclaves, TLV series

NEW

Raypa

These autoclaves are microprocessor controlled and monitored with 50 sterilisation programmes and comes with bacteriological filters included by default.

- Operating temperature range 100 °C to 140 °C
- With with vacuum pump and steam generator
- Maximum working pressure 2.6 bar (37psi)
- RS 232 interface, USB and WiFi
- Timer
- Fully automatic functions
- PT 100 temperature sensor
- Case and lid shrouding, stainless steel
- Sterilisation chamber, lid and sealing system, stainless steel
- Electrical heating with protected heating elements in the interior of the chamber
- Safety pressure valve
- Safety thermostat
- Automatic steam controlled by microprocessor
- Pressure gauge
- 4 casters (with brakes in two of them)
- 7" capacitive colour touch screen
- Power Supply: 230V 50/60 Hz
- Remote maintenance and diagnosis via cloud
- Remote operation monitoring via cloud

TLV: Basic
 TLV-FA: with Air Ballast and Fast Cooling
 TLV-PD: with Super Drying

Type	Capacity Litres	Chamber diam. x depth mm	Dimensions (W x D x H) mm	Rating		PK	Cat. No.
				W	kg		
TLV-50	58	400 x 450	610 x 870 x 1000	3600	140	1	4.672 183
TLV-75	83	400 x 650	610 x 870 x 1080	3600	150	1	4.672 184
TLV-50FA	58	400 x 450	610 x 870 x 1000	3600	140	1	4.672 185
TLV-75FA	83	400 x 650	610 x 870 x 1080	3600	150	1	4.672 186
TLV-50PD	58	400 x 450	610 x 870 x 1000	3600	140	1	4.672 187
TLV-75PD	83	400 x 650	610 x 870 x 1080	3600	150	1	4.672 188



4.675 456

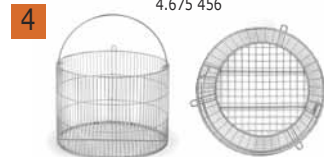

4.675 457

Accessory baskets for Digital vertical autoclaves, TLV series

NEW

Raypa

Type	For	Diam. mm	Height mm	PK	Cat. No.
Solid basket	TLV Series	370	200	1	4.675 456 3
Mesh basket	TLV Series	370	200	1	4.675 457 4



6.265 153



6.270 012

Thermoprinter for automatic autoclaves

Built-in printer IT:

Raypa

Must be installed ex factory, please order with autoclave.
 For Models: AES-12, AES-28, AES-50, AES-75, AES-110, AES-150, AE-28-DRY, AE-50-DRY, AE-75-DRY, AE-110-DRY, AE-150-DRY, AHS-50-N, AHS-75-N, AH-21-L, AHS-50-DRY, AHS-75-DRY

Built-in printer IT/TS:

Must be installed ex factory, please order with autoclave.
 For Models: AE-50-B, AE-75-B, AE-110-B, AE-150-B, AH-21-B, AHS-50-B, AHS-75-B, AE-20-MP, AE-40-MP, AE-60-MP, AE-80-MP, AE-100-MP

Table top printer ITS:

Print program number, cycle number, temperature, date and hour of the run. Error messages are also printed.
 With RS 232 interface. Only for AES-12/AES-28/AES-50/AES-75/AES-110/AES-150/DRY

Built-in printer IT/TLV

Must be installed ex factory, please order with autoclave.
 For TLV/Series

Type	PK	Cat. No.
Thermoprinter IT	1	6.265 153 5
Thermoprinter IT/TS	1	4.672 193
Thermoprinter ITS	1	6.270 012 6
Thermoprinter IT/TLV	1	4.675 455

1 Steam sterilizers (autoclaves), HG series

HMC-EUROPE

- Certified according to the Pressure Equipment Directive 2014/68/EU
- Available in 4 sizes with 50, 80, 113, 133 liters of effective usable volume
- Innovative locking system with motorized lid including pressure and temperature monitoring
- Steam generation in the chamber
- High energy efficiency and long service life
- Rapid cooling for short cooling times
- Also available with flexible temperature sensor for the sterilization of liquids
- Timer function and 4 program groups with 3 sub-groups each, including night and dissolution program, adjustments for customized programs are always possible
- No water/waste-water installation required
- Castors for mobile use
- Easy to clean plastic surface with rounded edges in contact areas (no burns or injuries).
- Electrical, mechanical and constructional factors guarantee the highest level of quality and user protection
- The accessories make it possible to configure the autoclave according to your wishes
- Exhaust air filters for laboratories of safety level S2 and higher are also available

Type	Capacity Litres	External dimensions (W x D x H) mm	Chamber Dimensions (diam. x H) mm	Rating W	Working Temp. range °C	Pressure bar	Weight kg	PK	Cat. No.
HG 50	50	455 x 691 x 890	364 x 482	3000	60 ... 135	2.5	62	1	9.842 410
HG 80	76	455 x 691 x 1030	364 x 730	3800	60 ... 135	2.5	73	1	9.842 411
HG 113	108	686 x 870 x 930	500 x 552	5800	60 ... 135	2.5	137	1	9.842 412
HG 133	129	686 x 870 x 1034	500 x 656	5800	60 ... 135	2.5	145	1	9.842 413

2 Accessories for HG series steam sterilisers

HMC-EUROPE

Description	Dimensions (dia. x H) mm	PK	Cat. No.
Flexible temperature sensor		1	9.842 420
Built-in printer HG		1	6.251 590
Exhaust air filter for sterilisation		1	9.842 422
Lifting equipment Loadmaster for HG 113/133		1	6.266 420
Stainless steel sterilising basket	340 x 220	1	9.842 423
Stainless steel sterilising basket with bottom	340 x 220	1	9.842 424
Stainless steel sterilising can	331 x 185	1	9.842 425
Automatic water supply		1	9.842 421
Charging basket A for HG 113/133	482 x 215	1	6.266 417
Charging basket A for HG 113/133, closed bottom	482 x 215	1	6.259 903
Charging basket B for HG 113/133	474 x 265	1	6.266 418
Charging basket B for HG 113/133, closed bottom	474 x 265	1	6.266 419
Charging basket C for HG 113/133	475 x 310	1	7.980 484
Charging basket C for HG 113/133, closed bottom	475 x 310	1	7.980 485

1



2



1 Steam sterilizers (autoclaves), HV series

Tireless, durable and ingeniously simple

HMC-EUROPE

- Certified according to the Pressure Equipment Directive 2014/68/EU
- Available in 4 sizes with 25, 50, 85 and 110 liters of effective usable volume
- Simple, reliable and with a long service life, your perfect choice for standard tasks
- Optionally available with flexible temperature sensor for the sterilization of liquids
- For all devices up to 110 liters only a single-phase power supply (220/240 V; 50/60 Hz) is required
- Timer function and 3 program groups with a max. of 6 programs including dissolution program, adaptations for customized programs are always possible
- No installation to a feed water supply required
- Castors for mobile use
- Easy to clean plastic surface with rounded edges in contact areas (no burns or injuries)
- Electrical, mechanical and constructional factors guarantee the highest level of quality and user protection
- The accessories make it possible to configurate the autoclave according to your wishes
- Exhaust air filters for laboratories of safety level S2 and higher are optionally available

Type	Capacity Litres	External dimensions (W x D x H) mm	Internal dimensions (Ø x H) mm	Rating W	Working Temp. range °C	Weight kg	PK	Cat. No.
HV-L25	25	480 x 460 x 950	240 x 550	1500	60 ... 126	41	1	7.980 025
HV-L50	50	540 x 530 x 1040	300 x 710	2000	60 ... 135	57	1	6.232 481
HV-L85	85	660 x 650 x 1000	420 x 615	3000	60 ... 128	71	1	9.842 418
HV-L110	110	660 x 650 x 1180	420 x 795	4000	60 ... 123	81	1	6.254 337

2 Accessories for HV series steam sterilisers

HMC-EUROPE

Description	Internal dimensions (Ø x H) mm	Baskets per autoclave	PK	Cat. No.
Flexible temperature sensor			1	7.980 024
Integrated printer			1	9.842 427
Air cooling			1	9.842 428
Exhaust-air filtration			1	9.842 429
Feed water autm.			1	6.251 161
Feed water HG 113/133			1	6.272 774
Stainless steel sterilising basket for HV-25	210 x 250	2	1	7.980 027
Stainless steel sterilising basket with bottom for HV-25	210 x 250	2	1	9.842 430
Stainless steel sterilising can for HV-25	210 x 255	2	1	9.842 431
Stainless steel sterilising basket for HV-50	270 x 220	3	1	6.232 482
Stainless steel sterilising basket with bottom for HV-50	270 x 220	3	1	9.842 432
Stainless steel sterilising can for HV-50	280 x 220	3	1	9.842 433
Stainless steel sterilising can for HV-85	390 x 285	2	1	6.259 905
Stainless steel sterilising basket with bottom for HV-85	390 x 290	2	1	6.259 908
Stainless steel sterilising basket for HV-85	390 x 290	2	1	6.264 959
Stainless steel sterilising can for HV-110	390 x 285	2	1	6.254 338
Stainless steel sterilising basket for HV-110	390 x 380	2	1	6.259 904
Stainless steel sterilising basket with bottom for HV-110	390 x 380	2	1	6.259 909

1



2



11. Cleaning and sterilisation

Steam sterilisers - Autoclaves/Instruments

Benchtop-Autoclaves HMT FA/-MA and -MB series

HMT 230/260 FA - for standard tasks:

- Certified according to regulation 93/42/EEC
- Available in 2 sizes with a volume of 16 or 24 liters
- 9 sterilization programs, fully automatic: 121 °C wrapped/unwrapped solid items; with or without drying, 135 °C wrapped/unwrapped solid items; with or without drying, Liquid program: 121 °C, 40 min.
- Controlled by a microprocessor
- Simple digital display
- Water tank
- Electromechanical overheating protection
- Safety valve
- Mechanical pressure-dependent door lock
- Reset/emergency button
- Easy maintenance

HMC-EUROPE



7.980 101

HMT 230/260/300 MA - versatile table-top autoclave:

- Certified according to regulation 93/42/EEC
- Available in 3 sizes with a volume of 16, 24 or 40 liters
- Powerful integrated vacuum pump, an essential feature for sterilizing tubes and hollow components
- 7 sterilization programs, fully automatic: 121 °C wrapped/unwrapped (vacuum), 134 °C wrapped/unwrapped (vacuum), Liquid and prion programs, Bowie-Dick test
- Controlled by a microprocessor
- Progress indicator
- Internal water tank
- Electromechanical overheating protection
- Electronic overpressure protection
- Pressure safety valve
- Mechanical pressure-dependent door lock
- Reset/emergency button
- Easy maintenance

2



4.655 164

HMT 260/300 MB - premium table-top autoclave:

- Certified according to regulation 93/42/EEC
- Available in 2 sizes with a volume of 24 or 40 liters
- Powerful integrated vacuum pump, an essential feature for sterilizing tubes and hollow components
- 5 sterilization programs, fully automatic: Sterilization of wrapped items: 121 °C - 30 min.; 134 °C - 15 min.; Sterilization of unwrapped items: 121 °C - 15 min.; 134 °C - 4 min., Individual temperature selection from 105 to 135 °C, Preset prion program
- 3 test programs: leakage test, helix test, Bowie-Dick test
- Controlled by a microprocessor
- Easy operation with a LCD display
- Documentation/data storage via SD card and printer
- Drying program, 1- 60 minutes
- 4 literwater tank, to be filled manually or automatically (purified water)
- Various safety features, e.g. safety valve or pressure-dependent door lock
- With modern design, easy maintenance

3



6.287 544

Type	Capacity	Chamber diam. x depth	Width	Length	Height	Rating	PK	Cat. No.
	Litres							
HMT 230FA	16	230 x 410	522	594	410	1.9	1	6.237 578
HMT 260FA	24	260 x 450	533	655	442	2.4	1	7.980 101 1
HMT 230 MA	16	230 x 410	522	594	410	1.9	1	4.655 160
HMT 260 MA	24	260 x 450	533	655	442	2.4	1	4.655 162
HMT 300 MA	40	300 x 570	620	900	489	3.2	1	4.655 164 2
HMT 260MB	24	260 x 450	553	665	440	2.7	1	4.655 166
HMT 300MB	40	300 x 570	620	766	489	2.3	1	6.287 544 3

We can supply this
manufacturer's
 whole
product range !



Labor- & Sterilisationstechnik

1

1 Autoclave thermometer

Durable bi-metal thermometer with a maximum registering pointer (red), moved up by the temperature measuring pointer (black), to indicate the highest temperature achieved, and remains there until it is manually reset.

Bel-Art Products

- Traceable to NIST Standard
- Threaded connection (1/4" NPT), screws directly into in-line processes, can be used to mount thermometer on included stand
- Waterproof and pressurised, withstands autoclave cycles and has a removable protective silicone sleeve to prevent moisture from making contact with the dial
- Constructed from 304 stainless steel with a glass lens; withstands pressure, high temperatures and rust
- Tested and inspected in the USA
- Includes a multi-language (English, French, German, Italian, Portuguese, and Spanish) Statement of Accuracy and instructions
- Available as an option with an individual Thermometer Calibration Report

Specifications

Measuring range: -20 to +150 °C
 Probe length: 50 mm

Description	PK	Cat. No.
Autoclave thermometer	1	6.287 577

2

2 Biological Indicators Attest™ for Control of Steam Autoclaves

Biological control involves the use of indicators, which check whether all microorganisms were killed during the sterilisation process. The bio-indicators are unique, as they directly indicate how many microbial spores have actually been killed. Thanks to the reliability and quality of the information, the regular use of a bio-indicator can lead to an improvement in the performance of the sterilisation process and thus to better results.

3M Deutschland

Features:

- No external laboratory is required for performance evaluation
- Easy handling
- Reasonable to use after repairs or maintenance of autoclaves

Application:

- Program 3.5 minutes, holding time at 121 °C or 134 °C
- After sterilisation, break the vial in order to bring the nutrient solution into contact with the spore strip
- Results in 48 hours
- Meets EN ISO 11138 standard

Type	PK	Cat. No.
Biological Indicators Attest™ for steam autoclaves, brown cap	100	6.089 578

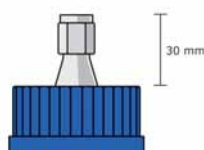
3

3 4 Screw Cap GL 45 with temperature probe holder, DURAN®

The DURAN® temperature probe holder GL 45 consists of a stainless steel holder that is permanently fitted into a blue DURAN® polypropylene GL 45 cap. The holder will accept the 6.0 mm metal temperature measuring probes that are commonly used in laboratory autoclaves and sterilizers.

DWK Life Sciences

Applications

- Routine sterilization /autoclave cycles
- "Loaded Chamber heat penetration" tests during Performance Qualification (PQ)
- Performance tests after autoclave maintenance or repair

Features

- Usable with DURAN® original GL 45 laboratory bottles (1000 ml or less).
- The depth of the probe can be adjusted to suit the bottle size
- Adjustable ferrule suitable for 6.0 mm diameter probes
- Retrace code for product traceability and downloadable certificate
- Easy positioning of the sensor in the middle of the bottle

4

Type	PK	Cat. No.
Screw Cap GL 45	1	9.072 178

1 2 Screw Cap GL 45 thermocouple holder, DURAN®

The DURAN® Screw Cap GL 45 thermocouple holder consists of a holder fitted into a blue DURAN® polypropylene GL 45 cap that accepts up to three separate thermocouple wires used in autoclaves or sterilizers.

DWK Life Sciences

Applications

- "Loaded Chamber heat penetration" tests during Performance Qualification (PQ)
- Routine sterilization /autoclave cycles
- Performance tests after autoclave maintenance or repair

Features

- Usable with DURAN® original GL 45 laboratory bottles (1000 ml or less).
- The 240 mm PTFE tube may be cut to length
- Suitable for holding up to three separate thermocouple wires (Conductor sizes 1/0.3 mm, 1/0.5 mm or 7/0.2 mm)
- Retrace code for product traceability and downloadable certificate

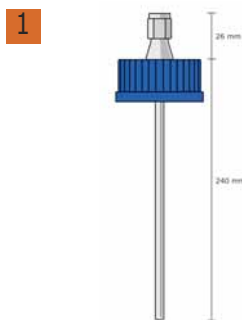

Description	PK	Cat. No.
Screw Cap GL 45 thermocouple holder	1	9.072 179

3 Autoclave deodorant Anabac®

Laboratories are very concerned about hygiene, cleanliness and comfort in the workplace. Try Anabac® autoclave deodorant balls to improve the working environment in the laboratory. These autoclave deodorant balls bring a discrete scent that speaks of cleanliness.

interscience

You can find ordering information for all articles described above as well as other articles online.



Warning

H phrases: H317|H319|H412



Type	Description	PK	Cat. No.
Peach	Peach fragrance	100	7.626 766

4 Indicator tape for steam, hot air and gas sterilisation

Crepe paper, adhesive. With indicator. Colour changes according to DIN EN ISO 11140-1. Rolls of 50 m.

With	colour change	Width mm	Figure	PK	Cat. No.
Steam indicator, lead free	green / black	18	a	1	9.140 787
Steam indicator, lead free	green / black	24	a	1	9.140 788
Steam indicator	green / black	19	b	1	9.140 784
Steam indicator	white / black	25	b	1	9.140 789
Steam indicator, strongly adhesive, for non-woven fabric	white / black	19	c	1	9.140 790
Steam indicator, strongly adhesive, for non-woven fabric	white / black	25	c	1	9.140 791
Ethylene oxide indicator	red / green	19	d	1	9.140 792
Hot air indicator	green / brown	19	e	1	6.240 223

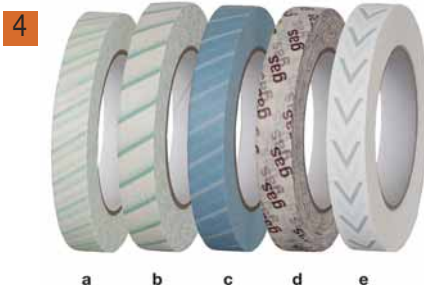

➔ Disposal bags - please see page 258.



1 polySteribox® sterilisation containers with permanent filter

The polySteribox® from Ritter Medical for sterilisation of instruments, storage and transportation of sterile goods is a secure solution in line with the requirements of validated processes in sterile goods provision. The polySteribox® is available in 4 different standardized sizes (SH, M, L and XL) which are suitable for all current sterilisation automats. polySteribox® is produced out of a transparent, dimensionally stable and high temperature resistant (up to 150 degrees celcius) material. It is therefore suitable for autoclave vacuum sterilisation at 121°C or 134°C depending on the sterilisation method recommended by relevant authorities such as the Robert Koch Institute in Germany. In addition the polySteribox® can be used for plasma sterilisation (STERRAD®) as well as for gas sterilisation (formaldehyde and ethylene oxide) at a maximum of 65°C. Lid and bottom close hermetically and include a built-in bacteria barrier. The patented interlocking system is compatible within all different models and prevents from accidental opening of the box. The boxes are space-saving and easy to stack, therefore they are well suited for storage of sterile goods.

Ritter

Type	External dimensions (W x D x H) mm	Internal dimensions (W x D x H) mm	PK	Cat. No.
polySteribox® SH	208 x 111 x 54	177 x 76 x 45	1	6.267 058
polySteribox® M	184 x 144 x 59	155 x 123 x 32	1	6.267 059
polysteribox® L	290 x 183 x 74	261 x 164 x 65	1	6.263 116
polySteribox® XL	498 x 118 x 63	465 x 95 x 55	1	6.267 061

2

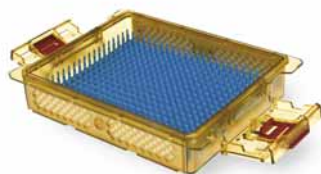

2 3 Accessories for polySteribox®

Ritter

Description	PK	Cat. No.
Filter set L/XL	1	9.284 283
Silicone positioning mat for box S, SH	1	9.284 288
Silicone positioning mat for box L	1	9.284 292
Silicone positioning mat for box M	1	9.284 293
Safety seals	1000	9.284 285
Sterilisation seal for box SH, M, L, XL	1000	9.284 287
Stainer for the Polysteribox L	1	9.284 294
Stainer for the Polysteribox XL	1	6.266 241

3



Multiparameter Indicator 3M™ Comply™

Class 4 indicators with endpoint reaction. With chemical coating, change their colour when the sterilization cycle is successfully completed. Indicator strips for steam sterilization or ethylene oxide sterilization.

3M Deutschland

- Steam sterilization colour change from yellow to black
- EO sterilization colour change from red to green
- Economical due to the possibility of cutting in half
- Complies with EN ISO 11140-1

Description	PK	Cat. No.
Comply™ 1250 chemical indicator strips	240	7.970 699 4
Comply™ 1251 EO Chemical Indicator Strip	240	6.274 555 5

4



7.970 699

5



6.274 555

1 Self-Seal Sterilization Pouches

Self-seal sterilization pouches are pre-folded and assure accurate and fast closing without the requirement of a heat sealing device. They are especially suited for use in small general practices, dental surgeries and by users who want to avoid costs of additional sealing equipment. The self-seal sterilization pouches are constructed from transparent PET/PP multi-layer copolymer film, medical grade paper and adhesive strip which provides excellent resistance to over-exposure of steam and clean opening. Water based, non-toxic process indicators for steam and ethyleneoxide sterilization complying with ISO 11140-1 are applied on the paper surface and help to differentiate between processed and unprocessed packages.

- Reinforced film to avoid tearing during opening
- Clean and accurate indicator color change
- Tear, fibre-free opening and aseptic presentation
- Triple band seal for higher package integrity



Dimensions mm	PK	Cat. No.
75 x 200	200	6.272 280
90 x 230	200	6.272 281
90 x 270	200	6.272 282
130 x 290	200	6.272 283
190 x 340	200	6.272 284
300 x 430	200	6.272 285

Heat-Sealable Sterilization Pouches and Reels

Heat-sealable sterilisation pouches and reels as a packaging solution for sterilisation applications, ensure reliable protection of the medical device against contamination with bacteria from the time of sterilisation until use of the sterile medical device. Flat and gusseted type and wide range of standard sizes allow optimum choice of correct sized packaging of each item. The sterilisation reels and pouches are constructed from transparent PET/PP multi-layer copolymer film and medical grade paper. Water based, non-toxic process indicators for steam and ethylene oxide sterilisation (complying with ISO 11140-1) are applied on the paper surface. This helps differentiating between processed and unprocessed packages.

- Reinforced film to avoid tearing during opening
- Clean and accurate indicator colour change
- Tear, fibre-free opening and aseptic presentation
- Triple band seal for higher package integrity

The sterilisation pouches and reels are effective barriers against germs and according the requirements of ISO 11607, EN 868-5 and ISO 11140-1 standards.

2 Heat-Sealable Sterilization Pouches

Description	Dimensions mm	PK	Cat. No.
flat	75 x 200	1000	6.272 268
flat	100 x 300	1000	6.272 269
flat	150 x 400	1000	6.272 270
flat	200 x 450	1000	6.272 271
flat	250 x 400	1000	6.272 272
flat	250 x 500	1000	6.272 273
flat	300 x 500	1000	6.272 274
gusseted	100 x 300	1000	6.272 275
gusseted	150 x 390	1000	6.272 276
gusseted	200 x 500	500	6.272 277
gusseted	250 x 500	500	6.272 278
gusseted	300 x 600	500	6.272 279



3 Heat-Sealable Sterilization Reels

Description	Width mm	Length m	PK	Cat. No.
flat	50	200	1	6.272 250
flat	75	200	1	6.272 251
flat	100	200	1	6.272 252
flat	150	200	1	6.272 253
flat	200	200	1	6.272 254
flat	250	200	1	6.272 255
flat	300	200	1	6.272 256
flat	350	200	1	6.272 257
flat	400	200	1	6.272 258
flat	500	200	1	6.272 259
gusseted	75	100	1	6.272 260
gusseted	100	100	1	6.272 261
gusseted	150	100	1	6.272 262
gusseted	200	100	1	6.272 263
gusseted	250	100	1	6.272 264
gusseted	300	100	1	6.272 265
gusseted	350	100	1	6.272 266
gusseted	400	100	1	6.272 267



1

1 Sterilisation Pouches Qualitix®

Suitable for many laboratory instruments. The disposable bags are used for simple and effective wrapping of sterilization goods that are visible through the transparent PET/CPPE film. With the self-sealing strip they can be closed safely and quickly.

Socorex

- Intended for steam and EO gas sterilization
- With two colour indicators
- Robust, durable material
- Wide, self-sealing strip
- Thumb notch for easy opening
- ISO 17665-06 and ISO 11135 conform

Internal dimensions (W x D) mm	PK	Cat. No.
65 x 110	200	4.664 119
70 x 205	200	4.664 120
115 x 205	200	4.664 121
170 x 300	200	4.664 122
270 x 335	200	4.664 123

2

2 Roll dispenser with Cutter

The dispenser frame is made of stainless steel and steel rods with nylon bearings for hygienic use at CSSDs. The integrated cutting unit includes an accurate and high quality cutting blade, providing safe and secure handling, as well as easy replacement. The roll dispenser and cutter is a useful addition to rotary sealing machines. It's renewed and the modular design makes it an ergonomic and economic tool which can be used as single or double rack model on working stations or just mounted on the wall.

Description	PK	Cat. No.
Roll dispenser with cutter	1	6.272 287

3

3 Rotary Sealer

This Rotary Sealer is an entry model which is solid, durable and extremely easy to use. Once power is on and the variable temperature adjustment has been done, the Rotary Sealer works when it's needed and stops automatically when the work is done. The basic rotary sealer is microprocessor controlled and the temperature can be adjusted anytime easily. The sensitive temperature ranging between 50 °C and 250 °C provides the user with flexibility to seal different kinds of packaging such as paper/film and Tyvek® pouches. Automatic feeding driven by optical sensors and multiline sealing technique ensure optimum seal strength at continuous operations. This sealing system is validated, calibrated and in compliance with international standards.

Description	Dimensions (W x D x H) mm	PK	Cat. No.
Rotary Sealer	225 x 430 x 160	1	6.272 286



Sample preparation	1212
Air sampling and analysis	1212
for standard analysis.....	1217
Trace analysis	1221
Tubes.....	1221
Accessories.....	1231
Sample analysis	1235
Elemental analysis	1235
Oil Testing	1237
Photometers	1238
COD	1249
BOD	1254
Turbidity.....	1261
Extraction.....	1266
Kjeldahl.....	1271
Special distillation.....	1274
Milk analysis	1275
Water purification	1278
Distillation	1278
Pure and ultra-pure water.....	1278

Sample preparation/Air sampling and analysis



1 Sampling bags, PVDF

Reusable bags made of 2 mil (50 µm) PVDF fluoropolymer film, Chemware® Gas Bags offer an economical alternative for analysis of noncorrosive gases. Durable, heat-sealed seams ensure leak-proof operation. Available with either a nickel-plated, brass on/off valve that accepts 6.4mm I.D. flexible tubing or with a PTFE/silicone septum in a polypropylene housing for use with a hypodermic needle. Applications include sampling carbon monoxide, sulfur dioxide, hydrogen sulfide, radon and mercaptan. The bags are individually packaged. When used for liquid samples, bags should be supported with a tray. Custom sizes and configurations available on request.

Saint Gobain

- Flexible
- Will not contaminate sample
- Choice of fitting style: on/off or septum
- For use in gas sampling trains
- Use for gas or liquid sample containment

Capacity L	Size mm	Connection	PK	Cat. No.
0.3	150 x 150	on/off	1	6.267 492
1.6	230 x 230	on/off	1	6.267 493
3.8	300 x 300	on/off	1	6.267 494
8.1	380 x 380	on/off	1	6.267 495
20.3	460 x 460	on/off	1	6.267 496
37.7	600 x 600	on/off	1	6.267 497
0.3	150 x 150	septum	1	6.267 498
3.8	230 x 230	septum	1	6.267 499
1.6	300 x 300	septum	1	6.267 600
8.1	380 x 380	septum	1	6.267 601
20.3	460 x 460	septum	1	6.267 602
37.7	600 x 600	septum	1	6.267 603



2 Sampling bags, FEP

Made from 5 mil (125 µm) FEP fluoropolymer film, these flexible, sturdy bags are heat sealed on all four sides for complete chemical resistance and leak-proof operation. They are inert to most chemicals and have low permeability which limits sample loss. Available with either a nickel-plated, brass on/off valve that accepts 6.4mm I.D. flexible tubing or with PTFE/silicone septum in polypropylene housing for use with a hypodermic needle. These FEP bags are easy to use. They can be stored for an unlimited period prior to use. Applications include gas sample analysis, extracting air samples from smokestack exhaust systems, monitoring air quality or calibrating instruments in the field. The bags are individually packaged.

Saint Gobain

- Chemically resistant
- Flexible
- Will not contaminate sample

Capacity L	Size mm	Connection	PK	Cat. No.
1.2	150 x 250	on/off	1	6.267 484
0.5	150 x 150	on/off	1	6.267 485
4.7	300 x 300	on/off	1	6.267 486
50.0	600 x 900	on/off	1	6.267 487
0.5	150 x 150	Septum	1	6.267 488
1.2	150 x 250	Septum	1	6.267 489
4.7	300 x 300	Septum	1	6.267 490
50.0	600 x 900	Septum	1	6.267 491



3 Air Flow Tester

In many fields, such as mining or industry, it is very important to detect even the smallest air flows, in order to quickly and reliably evaluate the possible diffusion of dangerous substances. With the air flow test tubes, the source, direction and speed of the air flow are visible immediately.

Dräger



Danger

H phrases: H290|H314

Type	PK	Cat. No.
Air Flow Tester (Set with blower ball and 10 flow test tubes)	1	6.054 581
Blower Ball	1	6.200 206
Flow test tubes	10	6.076 362

Gas sampling tubes, DURAN® tubing

Made of DURAN® tubing. Available with or without nozzle (with thread GL and septa), with two one-way stopcocks NS14 (with retaining device), connections: capillary tube (outer dia. 8 mm, inner dia. 2.7 mm), glass olive (outer dia. 8 mm), with inscription label. Also available with PUR coating.

Lenz

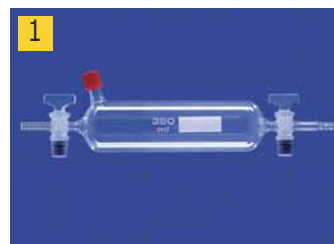

9.110 236

Type	Capacity	External body diam.	Length*	PK	Cat. No.
	ml	mm			
Without sampling connections	150	42	155	1	9.110 215
Without sampling connections	350	54	200	1	9.110 220
Without sampling connections	500	65	220	1	9.110 225
Without sampling connections	1000	85	260	1	9.110 230
With sampling connections, GL 14	150	42	155	1	6.243 069
With sampling connections, GL 14	350	54	200	1	9.110 236 1
With sampling connections, GL 14	500	65	220	1	9.110 237
With sampling connections, GL 14	1000	85	260	1	7.623 930

* Body length (mm)

2 Digital Anemometer

For the measurement of wind speed (in m/s, km/h, mph, knots, ft/min), maximum and average wind speed, indication of temperature (in °C or °F). LCD backlight display. Auto/Manual power off. Useful for the functional check of fume hoods and safety cabinets.

Wind speed range: 0.2 to 30 m/s
 Resolution: 0.1 m/s
 Accuracy: ±5 %
 Temperature range: -10 ... +45 °C (-14 ... +113 °F)
 Power supply: 3V CR2032 (included)

Height mm	Width mm	Depth mm	PK	Cat. No.
104	58	19	1	6.264 198



3 Dräger Sampling Tubes

Using the Dräger activated charcoal tubes or silica gel tubes, hazardous substances in the air are collected using a suitable medium via adsorption or chemisorption. The sample is then analysed in the laboratory by means of various analytical methods such as gas chromatography (GC), high performance liquid chromatography (HPLC), UV-VIS photometry, or IR spectroscopy.

Dräger

Type	Description	PK	Cat. No.
BiA 10	Charcoal tubes	10	9.620 414
G 50	Charcoal tubes	50	7.616 384
G 10	Charcoal tubes	10	9.620 415
G 200	Charcoal tubes	200	6.081 355
B/G 10	Charcoal tubes	10	9.620 416
BiA 10	Silica gel tubes	10	9.620 417
G 10	Silica gel tubes	10	9.620 418
B/G 10	Silica gel tubes	10	9.620 419
ORSA 5	Diffusion sampler ORSA 5	5	6.050 155
ORSA 25	Diffusion sampler ORSA 25	25	6.080 611
IPS	Isocyanate sampling set incl. analysis	1	6.070 187



4 Gas Pump accuro®

Fast measurement with one hand: The Dräger-Tube pump accuro® allows you to use the established Dräger-Tubes® to take measurements under extreme conditions. The easy-to-use Dräger-Tubes® have already been calibrated and form a perfect unit with the Dräger-Tube pump.

Dräger

Gas pump Dräger accuro® set consisting of:
 Dräger-Tubes® pump accuro®, ready bag, with tube opener and spare part set

Description	PK	Cat. No.
Gas pump accuro®	1	9.620 410
Gas pump set accuro®	1	9.620 411



Sample preparation/Air sampling and analysis

1

1 Dräger-Tubes®

The Dräger-Tubes® measuring system is the safe method for measuring pollutants in the soil, water and air. More than 500 substances can be measured in varying concentrations.

Dräger

The long-established principle of Dräger-Tubes® is still the same. A defined volume of gas/air must be pumped through the sampling tube. This can be achieved by using the Accuro® gas pump. On contact with the substance under test the reagent system contained in the tube reacts and displays a colour. The strength of the concentration of the substance is shown by the length of the colour band displayed and can be read directly from the scale. The Dräger-Tubes® sampling system provides accuracy, efficiency, quick and easy handling. Over 250 tubes are available on request for all substances and measuring fields. Further sampling devices, diffusion tubes for long-term measurements as well as sampling systems with activated carbon tubes, ORSA collector and TDS thermodesorption tubes are also available.

2

9.620 404

Type	Measuring range	PK	Cat. No.
Acetone 100/b	100 - 12000 ppm	10	9.620 421
Acetone 40/a	400 - 800 ppm	5	7.615 731
Ammonia 0,25/a	0.25 - 3 ppm	10	6.056 774
Ammonia 0,5%/a	0.5 - 10 Vol.-%	10	6.300 565
Ammonia 2/a	2 - 30 ppm	10	9.620 404 2
Ammonia 5/a	5 - 70 ppm	10	9.620 405
Ammonia 5/b	50 - 600 ppm	10	9.620 424
Petroleum hydrocarbons 10/a	5 - 100 ppm	10	9.620 426
Petroleum hydrocarbons 100/a	10 - 300 ppm	10	6.076 365
Benzene 0,25/a	100 - 2500 ppm	10	6.268 692
Prussic Acid 0,5/a	0.25 - 2 ppm	10	9.620 449
N-Butanol 10/a	0.5 - 5 ppm	10	9.620 449
Chlorine 0,2/a	5 - 50 ppm	10	6.287 566
Chlorine 0,3/b	10 - 250 ppm	10	9.620 407
Ethanol 100/a	3 - 30 ppm	10	6.051 690
Natural gas test	0.3 - 5 ppm	10	6.284 047
Acetic acid 5/a	100 - 3000 ppm	5	6.077 329
Hydrogen fluoride 0,5/a	5 - 8 ppm	10	6.900 409
Formaldehyde 0,2/a	0.5 - 15 ppm	10	6.206 032
	10 - 90 ppm	10	9.620 429
	0.2 - 2.5 ppm	10	9.620 429
	0.5 - 5 ppm		

3

9.620 408

4

6.077 398

Type	Measuring range	PK	Cat. No.
Carbon dioxide 0.5 % / a	0.5 - 10 vol.-%	10	6.200 383
Carbon dioxide 100 / a	100-3,000 ppm	10	9.620 408 3
Carbon dioxide 0.1 % / a	0.1 - 1.2 % by volume	10	6.088 165
Carbon dioxide 5 % / a	0.5 - 6 % by volume	10	6.050 554
Carbon monoxide 2 / a	5 - 60 vol.-%	10	9.620 432
Carbon monoxide 5 / c	2 - 60 ppm	10	9.620 409
Carbon monoxide 8 / a	23 - 300 ppm	10	9.620 409
Hydrocarbons 2 / a	5-150 ppm	10	6.088 162
Mercaptan 0.1 / a	8-150 ppm	10	6.240 701
Mercaptan 0.5 / a	2 - 24 mg /m ³	10	6.230 608
Mercaptan 20 / a	0.1-2.5 ppm	10	6.079 278
Methanol 20 / a	3-15 ppm	10	6.800 619
Methyl bromide 0.1 / a	0.5 - 5 ppm	10	6.284 102
Nitrous fumes 0.2 / a	20-100 ppm	10	4.675 452
Nitrous fumes 2 / a	20 - 250 ppm	10	6.266 890
	20 - 5000 ppm	10	6.077 398 4
Ozone 0.05 / b	5 - 50 ppm	10	9.620 434
Ozone 10 / a	0.05-0.7 ppm	10	6.058 619
Phenol 1 / b	20-300 ppm	10	9.620 437
Phosphines 0.01 / a	1 - 20 ppm	10	9.620 438
I-propanol	0.01 - 0.3 ppm	10	6.287 567
Mercury vapor 0.1 / b	0.1 - 1 ppm	10	9.620 439
	50-4000 ppm		
	0.05 - 2 mg /m ³		

12. Environmental-, soil-, water-, food analysis

Sample preparation/Air sampling and analysis

Dräger-Tubes®

More than 500 substances can be measured in varying concentrations. Dräger
 The long-established principle of Dräger-Tubes® is still the same. A defined volume of gas/air must be pumped through the sampling tube. This can be achieved by using the Accuro® gas pump. On contact with the substance under test the reagent system contained in the tube reacts and displays a colour. The strength of the concentration of the substance is shown by the length of the colour band displayed and can be read directly from the scale.

Type	Measuring range	PK	Cat. No.
Hydrochloric acid 0,2/a	0.2 - 3 ppm	10	7.622 794
Hydrochloric acid 1/a	1 - 10 ppm	10	9.620 413
Hydrochloric/Nitric acid	1 - 10/15 ppm	10	9.620 441
Oxygen 5%/c	5 - 23 Vol.-%	10	9.620 448
Sulphur dioxide 0,5/a	0.5 - 5 ppm	10	9.620 420
	1 - 25 ppm		
Carbon disulphide 3/a	3 - 95 ppm	10	9.620 442
Carbon disulphide 5/a	5 - 60 ppm	10	6.259 530
Hydrogen sulphide 0,2%/a	0.2 - 7 Vol.-%	10	6.088 166
Hydrogen sulphide 0,2/a	0.2 - 5 ppm	10	6.085 794
Hydrogen sulphide 0,2/b	0.2 - 6 ppm	10	6.077 399
Hydrogen sulphide 0,5/a	0.5 - 15 ppm	10	6.304 822
Hydrogen sulphide 1/c	1 - 20 ppm	10	6.052 630
	10 - 200 ppm		
Hydrogen sulphide 1/d	1 - 20 ppm	10	9.620 443
	10 - 200 ppm		
Hydrogen sulphide 100/a	100 - 2 000 ppm	10	6.050 553
Hydrogen sulphide 2%/a	2 - 40 Vol.-%	10	6.203 543 1
Hydrogen sulphide 2/a	20 - 200 ppm	10	6.210 081
Hydrogen sulphide 2/b	2 - 60 ppm	10	7.622 680
Hydrogen sulphide 5/b	5 - 60 ppm	10	9.620 425
Toluene 5/b	50 - 300 ppm	10	9.620 446
Trichloroethylene 2/a	2 - 50 ppm	10	9.620 447
	20 - 250 ppm		
Water vapour 0,1	1 - 40 mg/l	10	6.050 757 2



6.203 543

6.050 757

3 Test gas in disposable bottles

According to ISO 9002. DOT39 and EN12205. Dräger
 Control valve not included, please order separately.



Attention

H phrases: H280

Type	Concentration	Capacity	PK	Cat. No.
Hydrogen sulfide	20 ppm	60 l, 35 bar	1	6.253 813
Methane / Hydrogen sulfide / Carbon dioxide	2,5 Vol.% / 15 ppm / 2 Vol.%	60 l, 35 bar	1	7.618 098
Hydrogen sulfide / Carbon monoxide / Carbon dioxide	2,5 Vol.% / 15 ppm / 50 ppm / 2 Vol.%	60 l, 35 bar	1	7.655 788
Sulfur dioxide	10 ppm	60 l, 35 bar	1	7.661 308
Methane	2 Vol.%	112 l, 70 bar	1	7.661 767
Standard control valve, 0.5 l per min			1	7.654 036
Pressure reducer On Demand 2001 for Gas detectors with internal pump			1	7.660 299



3

We can supply this
 manufacturer's
 whole
 product range !



Sample preparation/Air sampling and analysis

1

7.629 381

Dräger Aerotest Alpha

The Dräger Aerotest Alpha allows the quality of breathing air supplied by a compressor or compressed gas cylinder to be determined. Use of the test system performs a reliable check in accordance with the breathing air standard EN 12 021.

Dräger

Dräger Aerotest Alpha

comprising of 1 pressure reducer, measuring device for 4 tubes, impactor adapter, coupling, barbed nipple, stopwatch, tube opener Dräger TO 7000, bubble test hose, pack of 5 sintered filters, instruction for use, transport case (black)

Dräger Aerotest Alpha, with Dräger Tubes:

Dräger Aerotest Alpha

- + box of 10 Dräger Oil Impactors,
- + box of 10 Dräger-Tubes carbon dioxide (CO₂) 100/a-P,
- + box of 10 Dräger-Tubes carbon monoxide (CO) 5/a-P,
- + box of 10 Dräger-Tubes water vapor (H₂O) 20/a-P

Specifications

Dimensions of carrying case (L x W x H)	350 x 300 x 85 mm
Weight, including contents	approx. 3.0 kg
Max. supply pressure	15 bar
Supply pressure (set on delivery)	3.0 bar
Pressure gauge	0.3 to 15 bar
Connection for compressed air supply	barbed nipple 9 mm
Flow rate	0.2 and 4.0 l/min

Description	PK	Cat. No.
Dräger Aerotest Alpha	1	6.241 227
Dräger Aerotest Alpha, with Dräger Tubes	1	7.629 381 1
Oil-impactor	10	6.241 225
Carbon monoxide 5/a-P	10	6.801 977
Carbon dioxide 100/a-P	10	6.801 978
Water Vapor 5/a-P	10	6.087 703
Water vapour 20/a-p	10	6.801 979
Oil 10/a-P	10	6.078 279

2

9.620 470

Automatic tube pump Dräger X-act® 5000

The automatic tube pump Dräger X-act® 5000 is the first all-in-one solution designed for measurements with Dräger short-term tubes and for sampling tubes and systems.

Dräger

Ease of operation and a high degree of reliability compliment the measurement and sampling of gases, vapors and aerosols.

- New Pump Concept
- Simplicity of Operation, even with protection gloves
- Automatic Transfer of Measurement Parameters with barcode reader
- Measurement in Technical Gases
- Direct Settings for Sampling
- Simple and intuitive menu structure

Specifications:

Number of strokes:	adjustable, 1 to 199 strokes
Stroke volume:	100 ml
Sample taking	
Flow rate range:	0.1 to 2.0 L/min
	Resolution 0.1 to 1.0 L/min: 0.1 L/min ±5 %
	Resolution 1.0 to 2.0 L/min: 0.2 L/min ±5 %
Sampling time:	adjustable, up to 12 hours, depending on flow rate
	Resolution in steps of 15 minutes (default) or 1 minute
Display:	two parts: segment and matrix
Menu languages:	Danish, Dutch, English, Finnish, French, German, Italian, Norwegian, Polish, Spanish, Swedish
Dimensions (H x W x D):	approx. 175 mm x 230 mm x 108 mm
Weight (without battery pack):	approx. 1.6 kg
Temperature during storage:	-20 °C to 55 °C
Temperature during operation:	5 °C to 40 °C
Humidity:	0 to 95 % r. h., non-condensing
Pressure:	700 to 1300 hPa

Description	PK	Cat. No.
Dräger X-act® 5000, shoulder strap without power supply	1	9.620 470 2
Rechargeable Battery NiMH, T4	1	9.620 471
Wall-Wart Charger 100 - 240 VAC (worldwide)	1	9.620 474
Car Charger 12 / 24 V	1	9.620 475

12. Environmental-, soil-, water-, food analysis

Sample preparation/Air sampling and analysis-for standard analysis

1 Carbon Dioxide Safety Monitor AX60

1

Gas warning device for precise measurement of the amount of CO₂ in the air.
 3 alarm settings factory set: Time-weighted average (TWA) alarm (5000 ppm; 0.5 % CO₂),
 Low alarm (15.000 ppm; 1.5 % CO₂) and High alarm (30.000 ppm; 3 % CO₂)

- No calibration required (unless local regulations state otherwise)
- Very long life sensor can last up to 15 years
- Up to 4 x CO₂ sensors and 8 x CO₂ alarms can be used per Central Display Unit
- Supplied with a relay on each alarm which can be used to trigger ventilation, extraction or a building management system
- Easy installation and maintenance can be conducted by the user
- Additional (quick connect) CO₂ sensors and alarms available if more than one entrance to the laboratory or more than one risk area
- Assists in compliance with Exposure Limit regulations such as EH40



Scope of delivery: wall-mounted central display unit, CO₂ sensor and CO₂ alarm which can provide an early warning of a CO₂ leak.

Specifications:

Range:	0.1 to 5 % CO ₂
Accuracy:	±5 % of alarm setpoint
Alarm intensity:	88 dbA
Monitor Display:	16 digit 2 line LCD in ppm
TWA Alarm:	5.000 ppm (0.5 %) over 8 hours
CO ₂ Alarms:	15.000 ppm (1.5 %) and 30.000 ppm (3 %)
Operating Temperature:	-5 to 50 °C
Central Unit Dimensions:	175 x 110 x 75 mm
Sensor & Alarm Dimensions:	72 x 170 x 45 mm
IP Rating:	IP55 (IP54 Central Display Unit)
Warranty:	5 years for electronics and sensor

Description	PK	Cat. No.
AX60 CO ₂ Safety Monitor	1	6.284 262
Additional CO ₂ Sensor (Max 4 per Central Display Unit)	1	6.284 263
Additional CO ₂ Alarm (Max 8 per Central Display Unit)	1	6.284 264
Optional Sensor Protector Kit: Protector bar, splashguard and fixing kit	1	6.284 265

2 Laboratory purification plants to determine the biodegradability, according to DIN 38412

2

e.g. for the Coupled Units Test in acc. with OECD 303 A, complete.

beh

optional:

- Dentrification step with pump and stirrers
 - Oxygen control, consisting of:
 Oxygen measuring unit for preliminary sedimentation with a voltage output for switching the air supply on and off behrotest® GWS 200 limit switch. Operating capacity 0 to 200%, corresponds to 0 to 19.9 mg/l Vessels made of borosilicate glass 3.3
- Other laboratory purification plants on request.



Type	Description	PK	Cat. No.
KA 1	Laboratory purification plant, complete	1	9.920 600
KA 1/SR	Laboratory purification plant, complete, with oxygen entry control	1	9.920 605
KLD 4	Laboratory purification plant, complete, with dentrification step	1	9.920 602
KLD 4/SR	Laboratory purification plant, complete, with dentrification step and oxygen entry control	1	9.920 606
KLD 4/N	Like KLD 4, with continual sludge recirculation	1	9.920 598
KLD 4N/SR	Like KLD 4/SR, with continual sludge recirculation	1	9.920 599

Sample preparation/for standard analysis



1 Equipment to determine anaerobic digestion

The complete equipment consists of:

- Tempering bath with thermostat for 6 eudiometer units incl. clamping device for eudiometer tubes
- 6 eudiometer units with laboratory bottles, 500ml, eudiometer tubes with graduation, stopcock and connecting tube and levelling bulb
- Series magnetic stirrer, for use in water bath to stir 6 bottles, each with 500 ml, including separate control unit

behr

Specification

Dims (WxDxH): 850 x 330 x 360 mm
Weight: 16 kg

Type	Description	PK	Cat. No.
FH 6	Tempering bath made of PVC incl. thermostat for 6 eudiometer units	1	9.843 850
FH 10	Eudiometer unit. Eudiometer tube, laboratory and levelling bottle	1	9.843 851
RM 6	Series magnetic stirrer	1	9.843 852



2 behrotest® waste water mixers

behrotest® homogenisers. With transportable sample vessels. Homogenisers for pre-treatment, splitting and homogenization of heterogeneous water samples in accordance with the quality assurance and quality control standards for wastewater examinations. The vessels of the homogenizers are protected against damage in the yolk type frame and can be carried easily by the two handles. They can be filled at the sampling location by a flattened inlet connection. Capacities from 2 to 25 l permit extraction and collection of multiple samples. Exact measurement of the sample quantities due to graduation. Subsequently, the transport rack is just placed on the magnetic stirrer in the laboratory or in the sampling vehicle and the homogeniser is immediately ready for use. The speed of the magnetic stirrer can be adjusted by a controller. The user can thus comply with the specified cone height in all cases. Oxygen is thus prevented from entering the samples. Dosed extraction of the homogenised sample via PTFE spindle stopcock. 12 V, with adapter for mains connection.

behr

Type	Capacity ml	PK	Cat. No.
QMR 2	2000	1	9.920 639
QMR 5	5000	1	9.920 640
QMR 10	10000	1	9.920 641
QMR 15	15000	1	9.920 642
QMR 20	20000	1	9.920 643
QMR 25	25000	1	9.920 644



3 Distillation unit FBA

Determination of the inorganic total fluoride FBA distillation unit behrotest® distillation unit to determine inorganically bound total fluoride

behr

In highly contaminated inorganic wastewater with a fluoride ionic concentration greater than 0.2 mg/l determination of the inorganic bound total fluoride takes place after digestion and distillation. The behrotest® distillation unit combines all components required for distillation on a stable laboratory stand. The unit is also suitable for larger analysis series due to the heating control system.

The single components are: Distillation equipment made of borosilicate glass for acid steam distillation, contact thermometer, heating mantles for distillation flasks and volumetric flasks.

Type	PK	Cat. No.
FBA-3	1	4.661 175

1 Extraction unit EX 1000

Determination of hydrocarbon EX 1000 extraction unit

behr

The PFL sampling bottle is ideal for direct extraction in terms of ISO 9377-2. With its solid glass stopper, in addition it offers a decisive advantage in handling and safety.

The funnel separator facilitates the separation of the organic phase. The individual functional parts of the separator can be easily separated. The user can thus transfer the organic phase quickly and simply in one step to the clean-up column. In addition the individual functional parts are particularly easy to clean.

1



Type	Description	PK	Cat. No.
EX 1000	Extraction unit	1	9.843 800

behrotest® column elution unit for the elution of soil samples

behr

Column elution unit:

- Column elution unit in acc. with the LUA recommendation with 4-channel hose pump with controllable speed. The unit consists of:
 - Assembly stand for the system
 - Controllable 4-channel hose pump with fixed speed
 - Storage vessel, 20 l
 - 4 elution columns, internal diameter 6 cm, 32 cm long, with 2 screwed joints (GL 45, with PTFE inserts) for simple filling of the columns
 - 4 collection bottles for the column eluate, 2 l, with screwed joint (GL 45) and deaeration
 - Supply tube made of TYGON and PVC, with non-return valve in the supply to the column
 - PTFE tubes between columns and collection vessels
 - Flow rate 0.003 to 35 ml/min
 - Range of speed 2 to 100 min⁻¹
 - Simultaneous control of all 4 channels

behrotest® silica sand:

for column elution unit, grain size 1 to 2 mm in acc. with DIN V 19736, 1000 g bottle

behrotest® silica wool:

for column elution unit, 100 g bag

2



9.843 741

Type	Description	PK	Cat. No.
SEB 32 R	Column elution unit B	1	9.843 741 2
QS-SEB	Silica sand for column elution unit	1	9.843 744
QW-SEB	Fibreglass for column elution unit	1	9.843 745
GS 450	Glass column 60 x 160 mm	1	7.609 951
GS 950	Glass column 60 x 320 mm	1	9.843 925

behrotest® compact equipment for elution of solid matters

behr

Percolation equipment to jointly examine the elution behaviour of inorganic and organic substances in solid matters. Including hose pump with 2 channels and 2 different pump tubes for a flow rate of 0.25-12 ml/min. and 0.66-33 ml/min. (Other pump tubes upon request).

Complete equipment, consisting of

- Percolation columns with pre-filters on sturdy stands
- Storage bottle with cap and tube
- Tube
- Eluate lead made of PTFE
- Storage vessel made of glass, cap with ventilation tube

3



9.843 931

Type	Description	PK	Cat. No.
KEB 101	Complete equipment, elution of solid matters for one sample w/ GS 101 glass column. Incl. two-channel hose pump and 2 tubes for different flow rates	1	9.843 931 3
KEBE 101	Supplementary equipment, elution of solid matters for one sample w/ GS 101 glass column. Incl. two-channel hose pump and 2 tubes for different flow rates	1	9.843 932
GS 101	Glass column, 90 x 500 x 5 mm, thread GL 100	1	9.843 928
SRR	Tube set, 4 pump tubes made of Tygon, flow rate of 0.25 - 12 ml/min	1	9.843 929
SVV	Tube set, 4 pump tubes made of Tygon, flow rate 0.66 - 33 ml/min	1	9.843 930

Sample preparation/for standard analysis

1 CUS 2 clean-up-station

The behrotest® clean-up column with glass frit corresponds exactly to the provisions of ISO 9377-2.

behr

The practical twin stand provides safe support for two complete clean-up units with dropping funnel, clean-up columns and Kuderna-Danish flasks. Thus, the complete clean-up procedure can be carried out for two samples simultaneously - without delays due to time-consuming equipment or sample manipulation.

Clean-up-Station, supplied as: stand, 2 graduated round, bottom flasks, 100 ml, 2 columns with grade 2 frits

Type	Description	PK	Cat. No.
CUS 2	Clean-up-Station	1	9.843 801

2 KOSTA 2 nitrogen station

The two-stage concentration of the organic phase is concluded by reducing the extract down to less than 1 ml under

behr

a mild nitrogen flow. In the behrotest® nitrogen station, a distributor leads the nitrogen flow via two individually adjustable tubes into the Kuderna-Danish flasks. Thus, two samples can be reduced simultaneously in accordance with ISO 9377-2.

Type	Description	PK	Cat. No.
Kosta 2	Nitrogen station	1	9.843 802

3 Compact system for determination of volatile oils KOL

Complete and compact system for volatile oil determination according to DAB, with base unit, heating mantle, mounting frame and glassware.

behr

Type	PK	Cat. No.
KOL	1	9.920 545



Products made of PFA

Products made of PFA are chemically inert and highly suitable for applications requiring high purity, such as for environmental and trace analysis. They are heat resistant and have a non-stick, easy to clean surface. Due to the extremely hydrophobic, anti-adhesive and smooth surfaces, it has no carry-over, no cross contamination and no memory effects. High thermal stability from -200 °C to + 260 °C. Products made of PFA are ideal for storage of almost all corrosive chemicals, including hydrofluoric, nitric and perchloric acid.

Saint Gobain

Features

- Very low level of metal ions
- High mechanical strength and dimensional stability
- Can be used in the microwave
- Unbreakable, transparent
- Can be used for cryogenic applications down to -200 °C
- Heat resistant up to 260 °C

1 2 Test Tubes, PFA

These unbreakable test tubes are excellent for trace metal analysis. They are inert, non-contaminating, and transparent for easy viewing of contents. They withstand temperature extremes. Can be sterilized repeatedly. Available with or without PTFE-stopper.

Saint Gobain

- Made from fluoropolymer PFA resin
- Low metal ion content
- Inert

Description	Capacity ml	Int. diam. mm	Ext. diam. mm	Length mm	PK	Cat. No.
without cap	15	14	16	150	1	6.267 608
without cap	25	16	19	170	1	6.267 609
without cap	50	19	22	220	1	6.267 610
without cap	60	19	22	230	1	6.267 611
with cap	10	10	12	152	1	6.267 613
with cap	15	14	16	162	1	6.267 614
with cap	20	14	16	175	1	6.267 615
with cap	25	16	19	185	1	6.267 616
with cap	50	19	22	235	1	6.267 617
with cap	60	19	22	245	1	6.267 618



3 Autosampler-vials, PFA



VITLAB

Raised graduation with 1 ml subdivisions. Translucent material. Conical interior. Optionally available with snap cap for long term storage or lid with knob for fast opening and closing (dust protection) of the vial. Scope of delivery is without lid or cap. Please order the fitting lid (Cat. No. 6.283 275 resp. 6.283 276) separately.

- No memory effects
- Practically no carryover due to the extremely hydrophobic, anti-adhesive, smooth surfaces
- High thermal stability, from -200 °C to +260 °C
- Chemical inertness against nearly all chemicals
- Easy to clean

Capacity ml	Outer diam. mm	Height mm	PK	Cat. No.
1.5	13,5	24	1	6.283 272
2.5	13,5	36	1	6.283 273
4	14	52	1	6.283 274
Snap cap, PFA	18	5	1	6.283 275
Lid with knob, PFA	16	9	1	6.283 276



4 Sample tubes, PFA

Tube for sample preparation and for use in autosampler racks. With or without individually calibrated ring mark at 10 ml with GL 25 screw cap made from PFA or PE stoppers.

VITLAB

Description	Capacity ml	Diam. mm	Height mm	PK	Cat. No.
with ring mark and stopper	12	16	110	1	9.315 344
without ring mark and stopper	12	16	110	1	9.315 343
with ring mark and screw cap	15	22	110	1	9.315 345
without ring mark and screw cap	15	22	110	1	9.315 346



Trace analysis/Tubes



1 Centrifuge tubes Nalgene™ Oak Ridge, FEP



Thermo Scientific

Teflon® FEP with Tefzel® ETFE screw cap. Resistant to all acids, bases and solvents. Autoclavable. Operating temperature range -100 to +150°C. Can be used brim-full in refrigerated centrifuges at up to 50000xg rcf. Leak-proof. Accessory sealing cap assemblies are available for all sizes.

Volume ml	Diam. mm	Height mm	PK	Cat. No.
10	16.0	81.5	1	9.315 701
30	25.5	93.7	1	9.315 702
50*	28.8	107.7	1	9.315 703

* Capacity: 46 ml to the brim.

Teflon® and Tefzel® are a registered trademark of DuPont.



2 Watch Glasses, PTFE

Saint Gobain

This ultra-shallow, concave dish is ideal for holding, weighing, crystallizing, evaporating and drying small samples of liquids, powders and solids. It can also be used as a convex cover for beakers and Erlenmeyer flasks to limit airborne contaminants, while still allowing gas exchange. All sizes are molded to the same contour for easy stacking. Shatter-proof PTFE material is chemical resistant and easy to clean.

- Inert, chemically resistant
- Smooth and unbreakable
- Use as beaker covers

Diam. mm	PK	Cat. No.
50	1	6.267 619
75	1	6.267 620
100	1	6.267 621
125	1	6.267 622
150	1	6.267 623



3 Evaporating Dish, PFA

Saint Gobain

The PFA Evaporating Dish design promotes evaporation of excess fluids to produce a concentrated solution or solid precipitate. The flat bottom provides good surface contact with a heat source, while the non-stick angled walls direct fluids to the base, which limits condensation on the dish wall. This PFA dish can be used in a wide range of temperatures, from cryogenics to 260 °C. The dish is also ideal for holding solid samples or small volumes of liquid. Features a broad spout for easy pouring.

- Chemically inert
- Ideal for trace metal analysis
- Transparent for easy viewing
- Perfect for microwave use
- Smooth, non-stick surface

Capacity ml	Height mm	PK	Cat. No.
100	29.5	1	6.267 447



4 Evaporating Dish, PTFE

Saint Gobain

This PTFE Evaporating Dish can be used to concentrate a solution or to create solid precipitates. The evaporating dish can also be used as a shallow bath, as a drying dish or as a beaker cover to protect contents from dust and other contaminants. PTFE material is unbreakable, chemically inert, and withstands temperatures up to 288 °C. The non-stick surface is stain resistant and easy to clean. Features a broad spout for easy pouring.

- Chemically inert
- Ideal for ultra-pure samples
- Withstands temperatures up to 288 °C

Capacity ml	Height mm	PK	Cat. No.
100	37.3	1	6.267 448
400	45.2	1	6.267 449



5 Evaporating Dish PFA, with snap-on lid, PE

With snap-on lid, PE. For contamination free sample preparation and efficient transportation. Due to a conical depression in the middle of the base very small amounts of a solvent are adequate to absorb the evaporated samples.

Capacity ml	Diam. mm	Height mm	PK	Cat. No.
25	50	25	1	7.009 214
50	50	54	1	7.009 215

1 Petri Dish, PFA



Saint Gobain



The non-stick, chemically inert surface of PFA petri dishes is non-contaminating and ideal for high-purity biological applications that range in temperature from -200°C to 260°C. Each petri dish is shallow, cylindrical and translucent with a flat bottom that allows for easy observation and uniform specimen growth. Ideal for cell culture or drying applications. Stackable one-piece design does not require a separate lid. Can be autoclaved for repeat use.

- Inert surface
- Non-stick
- Non-protein binding
- Transparent
- Uniform flat bottom

Capacity	Ext. diam.	Height	PK	Cat. No.
ml	mm	mm		
20	50	10	1	6.267 436
100	100	15	1	6.267 437

2 LLG- Beakers, low form, PTFE

Manufactured from high quality PTFE with excellent resistance to all chemicals. Manufactured from molded, pure PTFE with a smooth internal finish. Flat base enables a flat contact to the surface for effective heat transfer. PTFE beakers have excellent resistance to chemicals and temperature stability from -200 °C to +260 °C.



Capacity	Diam.	Height	PK	Cat. No.
ml	mm	mm		
50	45	55	1	6.267 346
100	55	64	1	6.267 347
250	72	90	1	6.267 348

3 Beakers, low form, PTFE

With reinforced rim and spout. Ungraduated. Excellent chemical and temperature resistance.

BRAND



Capacity	Diam.	Height	PK	Cat. No.
ml	mm	mm		
25	32	47	1	9.013 724
50	43	55	1	9.013 725
100	54	68	1	9.013 726
150	59	75	1	9.013 727
250	66	97	1	9.013 728
400	80	125	1	9.013 729
500	100	125	1	9.013 731
1000	105	155	1	9.013 734
2000	125	205	1	9.013 735

4 Griffin Beakers, PTFE



VITLAB

White, opaque, thick-walled. Without scale. Excellent chemical resistance and high thermal stability from -200 to +260 °C. Also suitable for microwave ovens. Autoclavable at 121 °C (2 bar) according to DIN EN 285.



Capacity	Diam.	Height	Wall thickness	PK	Cat. No.
ml	mm	mm	mm		
5	22	24	2	1	6.283 264
10	25	39	2	1	6.283 265
25	32	47	2	1	6.283 266
50	42	55	2	1	6.283 267
100	55	68	3	1	7.200 572
250	62	93	3	1	6.252 898
500	81	126	4	1	6.283 268
1000	102	157	4	1	6.283 269

Trace analysis/Tubes

1

1 Griffin Beakers, PTFE

Griffin Beakers, PTFE are non-contaminating and completely inert to highly corrosive reagents. They are non-wettable, unbreakable, lightweight, and heat resistant. Easy to clean, these beakers have a broad spout for easy pouring. They can be heated on a hot plate up to 288 °C when proper care is exercised. The specially molded bottom allows rapid heat transfer.

Saint Gobain

- Can be heated to 550°F (288°C) and used in a microwave
- Chemically resistant to acids and bases
- Ultra-pure

Capacity ml	Diam. mm	Height mm	PK	Cat. No.
10	21.8	32.1	1	6.267 424
30	32.9	45.0	1	6.267 425
50	38.9	52.3	1	6.267 426
100	48.3	65.5	1	6.267 427
250	65.7	92.3	1	6.267 428
400	76.0	107.0	1	6.267 429
600	85.0	124.5	1	6.267 430
1000	104.7	146.2	1	6.267 431

2

2 Beakers, Griffin, PFA

Griffin Beakers, PFA have a specially machined bottom designed for rapid, efficient heat transfer. They are transparent for easy viewing and graduated for easy measuring. They feature a non-stick, easy-to-clean surface.

Saint Gobain

- Can be heated up to 260 °C and used in a microwave
- Ideal for ultra-pure applications
- Low metal ion content for trace metal analysis

Capacity ml	Diam. mm	Height mm	PK	Cat. No.
50	42.7	43.3	1	6.267 432
125	59.7	60.8	1	6.267 433
250	71.6	76.2	1	6.267 434
500	88.8	89.7	1	6.267 435

3

3 Griffin beakers, ETFE

Transparent. With easily readable, printed black scale. Very good chemical resistance and very high thermal stability from -100 °C to +150 °C. To preserve markings, cleaning at greater than 60 °C is not recommended.

VITLAB

Capacity ml	Grad. ml	Diam. mm	Height mm	PK	Cat. No.
25	5	32	50	1	9.013 702
50	10	39	59	1	9.013 703
100	20	50	72	1	9.013 704
250	50	67	96	1	9.013 706
400	50	77	109	1	9.013 707
500	100	88	122	1	9.013 192
600	100	91	125	1	9.013 708
1000	100	105	143	1	9.013 710



1 Griffin beakers, PFA



VITLAB

Transparent. With a raised scale. Excellent chemical resistance and very high thermal stability from -200 °C to +260 °C. Autoclavable at 121 °C (2 bar) according to DIN EN 285.

The advantages of PFA

- Specially suitable for use in trace analysis
- Ideal for sensitive and valuable samples
- Long-term maintenance of low-concentration reference materials in PFA containers
- No memory effects
- Practically no carryover, no contamination due to the extremely hydrophobic, anti-adhesive and smooth surfaces
- Chemical inertness against nearly all chemicals
- Good transparency and dimensional stability
- Easy to clean
- Use of high purity raw materials

Material	Capacity	Grad.	Diam.	Height	PK	Cat. No.
	ml	ml	mm	mm		
PFA	25	5	32	50	1	9.013 210
PFA	50	10	39	59	1	9.013 211
PFA	100	20	50	72	1	9.013 212
PFA	250	50	67	96	1	9.013 213
PFA	500	100	88	122	1	9.013 214
PFA	1000	100	109	141	1	9.013 215



2 Round-bottom flasks, PFA



VITLAB

Transparent, neck with NS 29/32. Suitable as safety flask for use with rotary evaporators to collect the distilled off liquid. High thermal stability and chemical resistance.

The advantages of PFA:

- Especially suitable for use in trace analysis
- Long-term maintenance of low-concentration reference materials in PFA containers
- No memory effects
- Practically no carryover, no cross-contamination due to the extremely hydrophobic, anti-adhesive and smooth surfaces
- High thermal stability, from -200 °C to +260 °C, autoclavable.
- Chemical inertness against nearly all chemicals
- Good transparency and dimensional stability
- Easy to clean
- Use of high purity raw materials

Capacity	Diam.	Height	PK	Cat. No.
ml	mm	mm		
100	65	117	1	9.011 896
250	88	147	1	9.011 897
500	107	177	1	9.011 898



3 Erlenmeyer flasks, graduated, PFA

Erlenmeyer flasks, PFA are chemically inert for ultra-pure applications. The neck of each flask is slightly rounded for pouring and can be plugged with a stopper. The conical shape and neck design allow contents to be mixed or stirred with reduced risk of splashing. The narrow neck also helps limit evaporation and contamination. PFA material has the lowest metal ion content of any fluoropolymer. Ideal for use in titration and for the preparation of microbial cultures.

Saint Gobain

- Chemically inert for ultra-pure applications
- Graduated
- Transparent for easy viewing
- Non-stick PFA surface-easy to clean
- Can be used in a microwave

Capacity	Height	Neck diam.	PK	Cat. No.
ml	mm	mm		
100	97	18	1	6.267 465
200	123	23	1	6.267 466
300	130	23	1	6.267 467



Trace analysis/Tubes



1 Dropper bottle Nalgene™ Type 2414, FEP/ETFE

Thermo Scientific



Teflon® FEP bottle with Tefzel® ETFE dropper and cap.
Excellent chemical resistance. Autoclavable.

Capacity ml	PK	Cat. No.
30	1	9.073 300

Teflon® and Tefzel® are registered trademarks of DuPont.



2 Narrow-mouth bottles with screw thread

VITLAB



PFA. Transparent, with tightly sealing screw closure (saw-tooth thread).
High temperature resistance from -200 to +250 °C.
Autoclavable at 121 °C (2 bar) according to DIN EN 285.

Capacity ml	Diam. mm	Height mm	Thread S	PK	Cat. No.
50	37	86	28	1	9.073 740
100	45	120	28	1	9.102 420
250	61	160	28	1	9.102 422
500	76	190	28	1	9.102 424
1000	96	240	28	1	9.102 426



3 Narrow-mouth bottles, PFA

BRAND



For long-term storage of solvents and standards in trace analysis.

- PFA screw cap with a molded sealing ring for a positive seal.
- Autoclavable
- Temperature resistant from -200 °C to +260 °C

Capacity ml	Ext. diam. mm	Height mm	Thread S	PK	Cat. No.
50	37	86	28	1	6.223 308
100	45	120	28	1	6.902 473
250	61	160	28	1	4.000 114
500	76	190	28	1	4.000 115
1000	96	240	28	1	4.000 116

Screw caps S 28, PFA

For narrowmouth PFA bottles.

BRAND

Type	Thread	PK	Cat. No.
Screw caps	S 28	1	4.000 121



4 Narrow-mouth bottles with cap, PFA

Saint Gobain

These unbreakable PFA bottles can be used for storage of virtually all corrosive chemicals, including hydrofluoric, nitric, and perchloric acids. PFA bottles are chemically inert, heat resistant with a non-stick, easy-to clean surface and are ideal for environmental sampling. The inert fluoropolymer cap liner ensures leak-proof sealing. Supplied with PFA caps.

- Ultra-pure, the lowest metal ion content of all fluoropolymers
- Unbreakable
- Chemically inert
- Non-stick, easy to clean
- Use for storage in pharmaceutical and semiconductor processing (intermediate stages)

Capacity ml	Neck diam. mm	Height with cap mm	PK	Cat. No.
100	16.7	100.8	1	6.267 438
250	16.5	133.7	1	6.267 439
500	17.0	165.1	1	6.267 440
1000	25.3	202.4	1	6.267 441

1 Narrow-Mouth Bottle Nalgene™ Teflon™ PFA, with screw cap



Thermo Scientific

- Chemical and corrosion resistant
- Temperature resistant from -270 to +250 °C
- Leak-proof Teflon™ PFA screw caps
- Autoclavable

Capacity	Diam.	Height	Neck i. d.	PK	Cat. No.
ml	mm	mm	mm		
30	32	75	14	1	9.103 141
60	39	84	14	1	9.103 142
125	46	127	24	1	9.103 143
250	59	146	24	1	9.103 144
500	72	181	24	1	9.103 146
1000	90	216	24	1	9.103 147



2 Narrow-mouth bottles Nalgene™ Type 1600, FEP with screw cap ETFE



Thermo Scientific

Transparent. Teflon® FEP bottle with leakproof Teflon® ETFE screw cap. Highly resistant to chemicals, corrosion and temperature. Autoclavable - cap should be unscrewed and sat loosely on neck before autoclaving.

Type	Capacity	Screw cap diam.	PK	Cat. No.
	ml	mm		
1600	30	20	1	9.103 011
1600	60	20	1	9.103 012
1600	125	24	1	9.103 013
1600	250	24	1	9.103 014
1600	500	28	1	9.103 015
1600	1000	38	1	9.103 016
1600	2000	38-430*	1	9.103 017

* with high form thread.

Teflon® and Tefzel® are registered trademarks of DuPont.



3 Wide-mouth bottles with screw thread, PTFE

White. Opaque. Thick walled. With screw cap made of PTFE. Very high thermal stability and chemical resistance. With very wide mouth, ideal for filling with powders and paste-like materials.

VITLAB

Capacity	Ext. diam.	Height	Neck thread	PK	Cat. No.
ml	mm	mm	mm		
10	50	26	12	1	7.009 260
25	61	33	19	1	6.283 270
50	43	76	25	1	6.283 271
100	88	52	35	1	7.009 263



4 Wide-mouth bottles with screw thread, PFA



VITLAB

Transparent, with tightly sealing screw closure (saw-tooth thread S and built-in sealing lip). Excellent resistance to temperature (from -200 to +250 °C). Ideal for long-term storage of high-purity oxidants, acids, alkalis, as well as hydrocarbons, trace analysis solvents and standards. Autoclavable at 121 °C (2 bar) according to DIN EN 285.

Capacity	Ext. diam.	Height	Thread	PK	Cat. No.
ml	mm	mm	S		
250	61	150	40	1	9.073 742
500	76	179	40	1	9.073 741
1000	96	217	40	1	9.073 743
2000	130	245	40	1	9.102 430



Trace analysis/Tubes



1 Wide-mouth bottles, PFA



BRAND

For long-term storage of solvents and standards (trace analysis).

- PFA screw cap with integrated seal lip and buttress thread
- Temperature resistant from -200 °C to +260 °C
- Autoclavable

Capacity	Ext. diam.	Height	Thread	PK	Cat. No.
ml	mm	mm	S		
250	61	150	40	1	4.000 108
500	76	179	40	1	4.000 109
1000	96	217	40	1	4.000 110
2000	130	245	40	1	4.000 111

Screw caps S 40, PFA

For wide-mouth PFA bottles.

BRAND

Type	Thread	PK	Cat. No.
	S		
Screw caps	40	1	4.000 122



2 Wide-mouth bottles with cap, graduated, PFA

Saint Gobain

These PFA graduated bottles have a convenient wide-mouth opening for easy filling and pouring. These unbreakable, chemically inert bottles can be used for storage of virtually all corrosive chemicals. PFA material is heat resistant, non-stick and easy-to-clean. Each includes a PFA cap with an inert fluoropolymer cap liner to ensure leak-proof sealing. Ideal for environmental sampling, or for storage in pharmaceutical and intermediate-stage semiconductor processing applications.

- Wide-mouth for easy filling
- Ultra pure and chemically inert
- Non-stick and easy-to-clean

Capacity	Neck diam.	Height with cap	PK	Cat. No.
ml	mm	mm		
20	16.4	60.3	1	6.267 442
100	25.7	106.5	1	6.267 443
250	25.7	136.8	1	6.267 444
500	33.9	173.8	1	6.267 445
1000	36.8	207.2	1	6.267 446



3 Wash bottles, PFA

Saint Gobain

These wash bottles feature a wide-mouth opening for convenience in filling and pouring of all types of liquids. Non-stick and easy to clean, fluoropolymer construction provides superior flex life and mechanical strength. As PFA contains the lowest concentration of trace metal ions of all fluoropolymers, these bottles are ideal for ultra-pure applications and environmental work.

- Wide-mouth for easy filling
- Chemically inert and leak-proof
- Flexible nozzle with 360° swivel; small orifice allows accurate content dispensing
- Transparent and break resistant
- Molded-in graduation marks

Capacity	Neck diam.	Height with cap	PK	Cat. No.
ml	mm	mm		
100	25.5	159.5	1	6.267 480
250	25.6	195.3	1	6.267 481
500	33.9	293.7	1	6.267 482
1000	36.9	317.5	1	6.267 483



4 Narrow-mouth wash bottles, Technical quality PFA

BRAND

These bottles include components made of reprocessed PFA material from our production process. The tip opening can be enlarged by cutting.

- High temperature and chemical resistance
- ETFE screw caps
- FEP wash elements

Capacity	Ext. diam.	Height	Neck thread	PK	Cat. No.
ml	mm	mm	GL		
250	61	157	25	1	4.000 140
500	76	189	25	1	4.000 141
1000	96	233	32	1	4.000 142

1 Wash bottles Nalgene™ Type 2403, FEP, with screw cap, ETFE

Screw cap, jet and feed tube are one-piece moulded from ETFE.
Ideal for contamination-free work and suitable for trace element analysis.

Thermo Scientific

Capacity ml	Screw cap diam. mm	PK	Cat. No.
125	24	1	9.223 231
250	24	1	9.223 232
500	28	1	9.223 233
1000	38-430	1	9.223 234



2 Measuring cylinders, graduated, PFA

These graduated cylinders offer all the advantages of non-stick inert fluoropolymers.
PFA is temperature resistant from -196 °C to 260 °C and has the lowest metal ion content.
As a result, Chemware® cylinders are excellent for trace metal analysis.

Saint Gobain

- Easy-to-read graduations
- Smooth pouring, drip-free spout
- Broad base for stability

Capacity ml	Height mm	PK	Cat. No.
10	118.5	1	6.267 450
30	165.9	1	6.267 451
50	216.7	1	6.267 452
100	231.8	1	6.267 453
200	281.8	1	6.267 454
300	295.3	1	6.267 455
500	352.4	1	6.267 456
1000	316.7	1	6.267 457



3 Volumetric flasks, PFA, class A, with screw cap

Highly transparent. Class A tolerances according to DIN EN ISO 1042.
The PFA screw cap guards against contamination. Outstanding chemical resistance, can be used with strong oxidants, highly concentrated acids and alkalis, hydrocarbons, and ketones. With laser-engraved lot number and batch certificate.
Thermal stress up to 121 °C (autoclaving) does not permanently exceed the tolerance limit.
To preserve the ring mark, do not clean at temperatures exceeding 60°C.

VITLAB

The advantages of PFA

- Long-term maintenance of low-concentration reference materials in PFA containers
- No memory effects
- Practically no carryover, no cross-contamination due to the extremely hydrophobic, anti-adhesive and smooth surfaces
- High thermal stability, from -200 °C to +260 °C
- Chemical inertness against nearly all chemicals
- Good transparency and dimensional stability, suitable for volumetric instruments
- Easy to clean
- Use of high purity raw materials

Capacity ml	Tolerance ± ml	Height mm	Neck thread GL	PK	Cat. No.
10	0.04	90	18	1	9.276 919
25	0.04	115	18	1	9.276 920
50	0.06	150	18	1	9.276 921
100	0.10	180	18	1	9.276 922
250	0.15	235	25	1	9.276 923
500	0.25	270	25	1	9.276 924

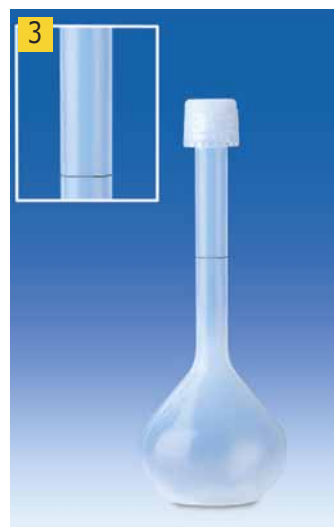

4 Gas washing bottles, PFA

With cap with S40 screw thread and srewable frit made of PTFE.
Approx. pore size 3 µm for optimal formation of gas bubbles into the liquid.
Because all parts are made of high-quality fluorocarbon resins, a broad range of applications are possible.
The threaded inlet and outlet connections accept 4 x 6mm i.d. x o.d. tubing,
(1000 ml version: 5 x 8 mm i.d. x o.d. tubing).

VITLAB

Capacity ml	Diam. mm	Height mm	PK	Cat. No.
250	61	160	1	9.110 320
500	76	190	1	9.110 322
1000	96	240	1	9.110 324



Trace analysis/Tubes



1 Sample vials, PFA

Sample vials made of PFA with conical interior and raised graduation (5 ml subdivisions).

VITLAB

Available in two different types, depending on application:

- Cored outside bottom
- Flat surface on bottom of vial for improved heat transfer (Recommended for use with hot plates)

Both 50 ml sizes fit in common Autosampler racks.

Scope of delivery is without screw cap. Please order the screw cap (Cat. No. 6.283 283) separately.

Type	Capacity ml	Outer diam. mm	Height with cap mm	PK	Cat. No.
flat	15	29	39	1	6.283 278
cored	15	29	42	1	6.283 277
flat	25	29	69	1	6.283 280
cored	25	29	72	1	6.283 279
flat	50	29	117	1	6.283 282
cored	50	29	120	1	6.283 281
Screw cap		33		1	6.283 283



2 Sample jars with screw cap, PFA



VITLAB

With screw cap made of PFA. Cylindrical, tall shape.

Ideal for sample collection, transport and storage of samples.

The advantages of PFA

- Specially suitable for use in trace analysis
- Ideal for sensitive and valuable samples
- Long-term maintenance of low-concentration reference materials in PFA containers
- No memory effects
- Practically no carryover, no cross-contamination due to the extremely hydrophobic, anti-adhesive, smooth surfaces
- High thermal stability from -200 °C to +260 °C, autoclavable at 121 °C (2 bar) according to DIN EN 285
- Chemical inertness against nearly all chemicals
- Good transparency and dimensional stability
- Easy to clean
- Use of high purity raw material

Capacity ml	Diam. with cap mm	Height with cap mm	Neck thread GL	PK	Cat. No.
30	38	54	40	1	9.401 810
60	38	90	40	1	9.401 812
90	54	62	56	1	9.401 814
180	54	112	56	1	9.401 816



3 Jars, PFA

Saint Gobain

PFA jars store solutions, paste and bulk materials with no concern about leaching, corrosion, contamination or evaporation. They are resistant to corrosive liquids, acids, solvents, sensitive reagents, and staining solutions. PFA jars feature a large mouth for easy access and non-stick surface for easy cleaning. There is an area for identification marking on the side of the jars. Stackable, these jars have a knurled top for secure grip to facilitate easy opening and closing.

- Chemically resistant
- Ultra-pure
- Heat resistant and usable to cryogenic temperatures
- Secondary inner seal design for safety and integrity
- Ideal for storing digestion samples

Capacity ml	Diam. with cap mm	Height with cap mm	PK	Cat. No.
60	50.8	46.8	1	6.267 468
120	66.0	53.2	1	6.267 469
240	66.8	96.8	1	6.267 470
360	84.4	90.6	1	6.267 471
480	65.2	94.3	1	6.267 472
1000	106.7	150.0	1	6.267 473
2000	104.1	269.1	1	6.267 474

1 Premium screw cap, TpCh260



DWK Life Sciences

TpCh260 (similar to PFA), with PTFE coated silicone seal. Colourless (to avoid risk of leaching) and temperature resistant from -196 °C to +260 °C. Ideal for dry sterilization. USP/FDA standard conformity. DFM available on request. Autoclavable. With Retrace code (Batch Identification). Certificate available via the internet.



Diam. mm	Height mm	Neck thread GL	PK	Cat. No.
32	32	25	1	9.072 159
51	26	45	1	6.205 218

2 Premium pouring ring for Premium screw cap, TpCh260

DWK Life Sciences

Colourless pouring ring TpCh260, height 4 mm. Temperature resistant from -196 °C to +260 °C.



Neck thread GL	PK	Cat. No.
45	1	6.803 677

3 DURAN PURE Premium lip seal cap, GL 45, PFA

DWK Life Sciences

Consequently the DURAN PURE premium lip seal cap is particularly suitable for use in the pharmaceutical, chemical and food industries. Due to the integrated lip seal, no further seal is needed to provide tight sealing of the bottles. Therefore it is ideal for storage and transport of sensitive products.

- Made from PFA and available for all GL 45 threads
- Produced and packed under Class 7 Cleanroom conditions
- Exceptional temperature resistance from -196 °C to + 260 °C
- Ideal for dry heat sterilization/depyrogenation
- Very high chemical resistance
- Conforms to FDA 21 CFR Section 177.1550 and USP class VI
- Simple cleanable and autoclavable



Diam. mm	Height mm	Neck thread GL	PK	Cat. No.
52	27.5	45	1	4.658 450

4 Sealing tape, PTFE

For covering areas which require protection against chemicals of all types at temperatures of -150 to +260 °C. Non-swelling. Easy loosening of seams even after continuous operation. Supplied in rolls as outlined below.



Width mm	Length cm	Wall thickness mm	PK	Cat. No.
12.8	670	0.1	1	9.404 952
24.0	670	0.1	1	9.404 955

5 Raschig Rings for distillation, PTFE

Saint Gobain

- Packing for distillation columns
- Chemically inert
- High surface area per unit of volume
- Minimum resistance to gas and liquid flow



Diam. mm	Length mm	PK	Cat. No.
3	3	500	9.012 473
6	6	300	9.012 476

1

1 Boiling Stones, PTFE

Ultra-pure, virgin PTFE chips promote gentle, efficient boiling and help prevent overheating, even of highly volatile liquids. Ideal for continuous extraction methods. Stones minimize "bumping" during reflux and distillation. The boiling stones are not affected by acids, hydrocarbons, ketones, esters, alcohols or alkalis. They are easily cleaned and non-contaminating. Shows no trace of face acidity or alkalinity. They will not scratch or abrade glassware and leave no residue. Usable up to 288 °C.

Saint Gobain

- Chemical resistant
- Ideal for boiling organic liquids
- Minimizes superheating

Weight g	PK	Cat. No.
450	1	9.012 310

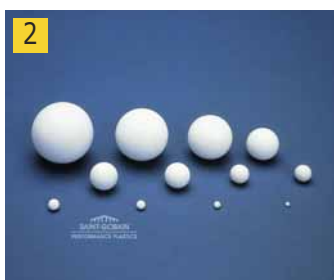
2

2 Balls, PTFE

PTFE balls minimize "bumping" during boiling. They are inert and can be used up to 288 °C. 100 balls per package.

Saint Gobain

- For column packing and mixing beds
- Resistant to most chemicals
- Non-contaminating

Diam. mm	PK	Cat. No.
3.2	100	9.012 453
6.4	100	9.012 456
9.5	100	9.012 459

3

3 Spatulas, PTFE fluoropolymer, coated

These spatulas are designed for use in the most severe laboratory conditions. They are made of nickel-plated stainless steel and fluoropolymer coating. The coating eliminates surface buildup or loss of valuable sample due to sticking. Will not scratch or damage delicate surfaces.

Saint Gobain

- Extra heavy-duty PTFE coatings
- Resistant to low and high temperatures
- Use for handling chemically active materials

Description	Length mm	Figure	PK	Cat. No.
Double-ended spatula	200	a	1	9.220 940
Spoon spatula	225	b	1	9.220 945

4

4 Stirrers, PTFE

These stirrers are ideal for scraping precipitates and residues. Chisel tip on one end and diagonal cut on other end permits applications in confined vessels. Chemically inert PTFE offers resistance to adhesion of any material. Unbreakable and heat resistant to 288 °C, they will not crack or break under severe conditions, such as thermal and mechanical shock, and will not scratch glassware.

Saint Gobain

- Highly inert PTFE coating
- Non-stick, easy to clean
- Low and high temperature resistant

Length mm	PK	Cat. No.
200	1	6.267 606

5

5 Stirring Rods, PTFE® Fluoropolymer

Contains fully enclosed steel insert for stiffness, yet can be bent to various shapes for use as a powered stirrer. Heat resistant to 288 °C and completely inert to highly corrosive reagents. Antistick properties facilitate cleaning.

Saint Gobain

- Inert to corrosives
- Easy to clean
- Bendable into shapes

Length mm	PK	Cat. No.
204.8	1	6.267 420
255.6	1	6.267 421
306.4	1	6.267 422
410.6	1	6.267 423

1 Forceps, PTFE Fluoropolymer, coated

Forceps are made of nickel-plated steel and have an extra heavy-duty coating of PTFE. The forceps have the same great features as the spatulas and tongs.

- Ridged grips prevent slips
- Inner pin retains closed position
- Rounded precision tip for accuracy and safety

Saint Gobain



Length mm	PK	Cat. No.
116	1	9.171 555

2 Forceps, PTFE

Made from PTFE resin with an encapsulated metal insert for strength. Chemically inert and non-contaminating, these forceps are ideal for laboratory work involving hot, cold, delicate or highly reactive materials.

- Chemically inert
- Non-contaminating
- Will not scratch delicate surfaces

Saint Gobain



Length mm	PK	Cat. No.
150	1	6.267 478

3 Tong, PTFE fluoropolymer, coated

The stainless steel tongs are covered with extra-heavy, non-stick PTFE coating and have the same great feature as the PTFE coated spatulas.

Saint Gobain



- Opposing grip handle for easy operation
- Coated tension screw will not corrode
- Contoured jaw enables handling of crucibles and other objects
- Tapered tips for enhanced grip; rounded for safety
- Use for handling chemically active materials

Length mm	PK	Cat. No.
240	1	6.267 479

4 Dipper/Sieve Chemware®, PFA

Resistant to most chemicals, the articles are ideal for ultra-pure applications and use with aggressive media. Handle design allows dipper to hook over edge of vessel, eliminating dripping of corrosive fluids onto surrounding surface. Use with containers that have at least an 80 mm opening. The sieve mesh size is available in 1.0 mm.

Saint Gobain



- Non-contaminating and resistant to most chemicals
- Superior chemical resistance
- Lowest concentration of metal ions of any fluoropolymer
- Ideal for coarse sorting or draining of aggressive media
- Handle hooks over edge of vessel for draining

Diam. mm	Length mm	Description	PK	Cat. No.
76	180	Dipper	1	6.267 475

5 Sampler LiquiSampler, PTFE/FEP



DIN 53242. For liquids. Made of ultra pure and chemically inert PTFE/FEP for contamination-free sampling. Practical push button, single-handed operation. Suitable for point, cross-sectional, and bottom sampling. Ideal for sampling from open and closed drums, kegs, tanks, silos, water sources (ponds, lakes, streams, rivers). Suitable for all commercial kegs and drums with openings of at least 25 mm diameter. All surfaces are non-porous and crevice-free preventing accumulation of dirt. Only round-profile screwthreads, suitable for food hygiene applications, are used. Simple to dismantle and clean.

Bürkle



Colour	Diam. mm	Length mm	Material	PK	Cat. No.
highly transparent	32	600	PTFE/FEP	1	6.255 307
highly transparent	32	1000	PTFE/FEP	1	9.303 950
highly transparent	32	2000	PTFE/FEP	1	9.303 951



Sampler ViscoSampler, PTFE/FEP

Bürkle



Ultra-pure sampler with powerful suction for tough substances. Specially designed for tough substances, such as slime, slurries, wet clay and soil samples, sediments, oils, emulsions and creams. The filter flask sucks up and discharges the material. All surfaces are non-porous and crevice-free, preventing dirt accumulation. Only round-profile threads, suitable for food hygiene applications, are used. Allow easy dismantling and cleaning.

Colour	Diam. mm	Length mm	Material	PK	Cat. No.
highly transparent	32	600	PTFE/FEP	1	6.803 102
highly transparent	32	1000	PTFE/FEP	1	9.303 960 1
highly transparent	32	2000	PTFE/FEP	1	9.303 961



2 Bottle-top dispensers Dispensette® S



The Dispensette® S bottle-top dispenser makes liquid dosing easy and secure.

- Discharge tube, with and without recirculation valve
- Valve system - tight sealing without additional sealing rings
- Fast venting through improved aerodynamics
- Minimal force needed to operate - especially with high-volume devices
- Secure volume fixing with analog slide
- 1 ml dispenser - available as digital and analog version
- Autoclavable (121 °C)
- Easy to calibrate and adjust in order to comply with ISO 9001 and GLP guidelines
- Easy to disassemble for cleaning
- Removable filling and exhaust valve with safety bulb (closes when discharge tube is not mounted)
- To allow the bottle label to face the user, the valve block can be rotated by 360 °
- Telescope filling tube easily adjusts to different bottle sizes
- DE-M marking
- Analog volume display
- Quickly adjustable dosing volume

Included items:

Bottle-top dispensers Dispensette® S, DE-M marked and supplied with performance certificate, telescope filling tube, recirculation valve (optional), mounting tool and adapters made of PP.



3 Bottle-top dispenser Dispensette® S Trace Analysis Analog

BRAND

Dispensette® S Trace Analysis is ideal for precise volume dosing of high purity media for trace analysis. Can be used as hydrofluoric acid dispenser with Pt/Ir valve.

Included items: Bottle-top dispenser Dispensette® S TA, DE-M marked and supplied with performance certificate, telescope filling tube, recirculation valve (optional), mounting tool and bottle adapters GL 28/S 28 (ETFE), GL 32 (ETFE) and S40 (PTFE), operating manual.

Volume ml	Grad. ml	Accuracy max. vol. (± R%)	Precision max. vol. (≤ CV%)	Valve spring	Recycle valve	PK	Cat. No.
1 - 10	0.2	0.5	0.1	Pt / Ir	without	1	9.284 452
1 - 10	0.2	0.5	0.1	Pt / Ir	with	1	9.284 453
1 - 10	0.2	0.5	0.1	Tantalum	without	1	9.284 457
1 - 10	0.2	0.5	0.1	Tantalum	with	1	9.284 458

1 Rapid Tests, Pooltester

The Pooltester is designed for the simultaneous determination of the most popular water treatment agents and the pH value. Each pool tester contains tablets in foil for every 20 analyzes and a multilingual user manual.

Lovibond®

1



! Attention

H phrases: EUH210

Type	Description	Measuring range	PK	Cat. No.
AF 105	Chlorine LR / pH	0.1-3 mg/l / 6.8-8.2	1	6.205 365
H 202	Biguanide-PHMB / H ₂ O ₂ / pH	10-100 mg/l / 5-50 mg/l / 6.8-8.2	12	6.900 480

2 Color Standards Platinum-Cobalt (Hazen)

NEW

Reagecon

These color standards can be used to calibrate, control, qualify or validate color measurement instruments to determine the color number. These standards can be described as Platinum-Cobalt, Pt-Co, Hazen or APHA color. All descriptions are interchangeable.

- Covers requirements of ASTM Method D 1209
- In 1 l HDPE bottle

2



Description	PK	Cat. No.
Pt-Co Hazen 0	1	4.012 117
Pt-Co Hazen 5	1	6.257 411
Pt-Co Hazen 10	1	6.235 802
Pt-Co Hazen 15	1	4.675 390
Pt-Co Hazen 20	1	6.257 412
Pt-Co Hazen 25	1	4.012 118
Pt-Co Hazen 30	1	4.675 391
Pt-Co Hazen 40	1	4.012 119

3 Colour Standards Gardner

NEW

Reagecon

- The colour standard can be used to calibrate, control, qualify or validate colour measurement instruments to determine the colour number.
- Specially for methods according to ASTM D1544, D 6166, AOCs Td 1a and MS 817 Part 10
 - Suitable for similarly coloured liquids, including several vegetable and mineral oils
 - In 100 ml glass bottle

3



Danger

H phrases: H304

Description	PK	Cat. No.
Gardner 1	1	6.311 476
Gardner 2	1	6.311 477
Gardner 3	1	6.311 478
Gardner 4	1	6.311 479
Gardner 5	1	6.311 480
Gardner 6	1	4.675 392
Gardner 7	1	4.675 393
Gardner 8	1	4.675 394
Gardner 9	1	4.675 395
Gardner 10	1	4.675 396
Gardner 11	1	4.675 397
Gardner 12	1	4.675 398
Gardner 13	1	4.675 399
Gardner 14	1	4.675 400
Gardner 15	1	4.675 401
Gardner 16	1	4.675 402
Gardner 17	1	4.675 403
Gardner 18	1	4.675 404

Nessler Tube, without spout, borosilicate 3.3

For use, for example, with the Nessleriser systems from Lovibond®.

NORMAX

4



Description	Capacity	Dimensions (dia. x H)	PK	Cat. No.
	ml			
tall form, graduated at 50 ml	50	20 x 300	1	9.170 621
tall form, graduated at 100 ml	100	24 x 375	1	9.170 622
short form, graduated at 50 ml	50	25 x 175	1	9.170 623
short form, graduated at 100 ml	100	32 x 200	1	9.170 624

9.170 623

Sample analysis/Elemental analysis

1

1 Test strips Chem-QUANT®

- Reliable and precise
- Non-bleeding
- Easy and quick analysis
- Made in Europe

CHEM-LAB n.v.

For	Measuring range	PK	Cat. No.
Ammonium 400	0 - 10 - 25 - 50 - 100 - 200 - 400 mg/l NH ₄ ⁺	100	6.286 810
Carbonate Hardness 30	0 - 5 - 10 - 15 - 20 - 30 °d	100	6.286 811 2
Chlorine 20	0 - 1 - 3 - 5 - 20 mg/l	100	6.286 812
Chlorine 1000	0 - 50 - 100 - 250 - 500 - 1000 mg/l	100	6.286 813
Fluoride 100	0 - 10 - 25 - 50 - 100 mg/l	100	6.286 814 3
Glucose 2000	0 - 100 - 250 - 500 - 1000 - 2000 mg/dl	100	6.286 815
Nitrate 500	0 - 10 - 25 - 50 - 250 - 500 mg/l	100	6.286 816
Nitrite 80	0 - 2 - 5 - 10 - 20 - 40 - 80 mg/l	100	6.286 817
Peracetic Acid 50	0 - 5 - 10 - 20 - 30 - 50 mg/l	100	6.286 818
Peracetic Acid 2000	0 - 500 - 1000 - 1500 - 2000 mg/l	100	6.286 819
Peroxide 25	0 - 0.5 - 2 - 5 - 10 - 25 mg/l	100	6.286 820
Peroxide 1000	0 - 100 - 200 - 400 - 600 - 800 - 1000 mg/l	100	6.286 821
Phosphate 100	0 - 3 - 10 - 25 - 50 - 100 - 250 - 500 mg/l	100	6.286 822
QAC 25-1000 (Benzalkonium chloride)	0 - 25 - 50 - 100 - 250 - 500 - 1000 mg/l	100	6.286 823
Sulphite 500	10 - 50 - 100 - 250 - 500 mg/l	100	6.286 824

2

6.286 811

3

6.286 814

5

4

4 5 MERCKOQUANT® test strips

Other tests on request.

Merck

Danger

H phrases: H290|H314

For	Measuring range	PK	Cat. No.
Ammonia	10 to 400 mg/l NH ₄ ⁺	100	9.129 902
Ascorbic acid	50 to 2000 mg/l	100	9.129 904
Chromate	3 to 100 mg/l CrO ₄ ²⁻	100	9.129 909
Iron	3 to 500 mg/l Fe ^{2+/3+}	100	9.129 913
Formaldehyde	10 to 100 mg/l HCHO	100	9.129 914
Total hardness	5 to 25 °dH	100	9.129 916
Total hardness	3 to 21 °dH	100	9.129 918
Total hardness	3 to 21°dH	1000	9.129 919
Copper	10 to 300 mg/l Cu ²⁺	100	9.129 923
Nickel	10 to 500 mg/l Ni ²⁺	100	9.129 928
Nitrate	10 to 500 mg/l NO ₃ ⁻ ,	100	9.129 931
Nitrite	2 to 80 mg/l NO ₂ ⁻	100	9.129 932
Nitrite	0.1 to 3 mg/l NO ₂ ⁻	100	9.129 933
Peracetic acid	5 to 50 mg/l	100	9.129 943
Peroxide	0.5 to 25 mg/l H ₂ O ₂	100	9.129 934
Sulphite	10 to 400 mg/l SO ₃ ²⁻	100	9.129 938

6

6 Water hardness test strips, AQUADUR®

 For determining water hardness.
 Colour change from green to red.

MACHERY-NAGEL

Scale gradation °d	Package contents	PK	Cat. No.
<3 / >5 / >10 / >15 / >20 / >25	Box of 100 strips	100	9.130 393
<3 / >4 / >7 / >14 / >21	Box of 100 strips	100	9.130 394
<3 / >4 / >8.4 / >14	Box of 100 strips	100	9.130 400
<3 / >4 / >8.4 / >14 / >21	Bag of 1000 strips*	1000	4.005 099
<3 / >5 / >10 / >15 / >20 / >25	Pack of 50 sachets**	50	4.005 101
<3 / >5 / >10 / >15 / >20 / >25	Bag of 5000 strips	5000	9.130 395
<3 / >4 / >7 / >14 / >21	Bag of 5000 strips	5000	9.130 396
<3 / >5 / >10 / >15 / >20 / >25	Bag of 1000 strips*	1000	9.130 397
<3 / >4 / >7 / >14 / >21	Bag of 1000 strips*	1000	9.130 398

*single sealed

**3 test each sealed

Test strips are also available as individually sealed test strips or as test cards.

12. Environmental-, soil-, water-, food analysis

Sample analysis/Elemental analysis-Oil Testing

Qualitative Test papers

Cyantesmo: Roll of 5 m length and 10 mm width

MACHERY-NAGEL



Danger

H phrases: H350|H412



7.083 428

7.075 920

Type	PK	Cat. No.
Phosphatesmo MI	50	6.206 203
Phosphatesmo KM	25	7.083 428 ¹
Peroxtesmo MI	100	6.206 902
Peroxtesmo KM	25	4.005 078
Peroxtesmo KO	100	4.005 079
Water	50	7.075 920 ²
Cyantesmo	1	6.230 526 ³
Watesmo	1	7.050 148



6.230 526

4 Test papers, potassium iodide starch

This test paper allows the quick and easy detection of strong oxidizers such as nitrite and free chlorine. Potassium iodide starch paper is also used to control diazotization reactions. Nitrite or free chlorine oxidize potassium iodide to form elemental iodine which reacts with starch to a blue-violet complex. Potassium iodide starch paper may be used by dipping it into the sample or by applying drops of the sample onto the paper. To detect gaseous oxidizers, the paper is moistened with distilled water and then exposed to the gas in question.

MACHERY-NAGEL



Type	Package contents	PK	Cat. No.
MN 616 T	1 box of 200 strips	200	6.206 041
MN 816 N	1 reel of 5 m	1	7.081 774
MN 816 N	Refill pack of 3 reels	1	4.005 092
MN 816 N	1 booklet of 100 strips	100	9.130 104

5 Oil test paper

For rapid detection of oil in water and/or soil.
Box of 100 strips.

MACHERY-NAGEL



Type	PK	Cat. No.
Oil test paper	100	9.130 095

6 Cooking oil tester FOM 330

Checks the quality and temperature of cooking oils, with indication by a clearly visible signal lamp. Can be used in hot oil up to 200 °C.

ebro

- Large display with big numbers
- FOM 330-4 with 4 controls for frequent adjustments
- FOM 330-1 with 1 control for infrequent adjustments
- Simplified menu structure
- Incl. calibration protocol

Specifications

Range:	+50 °C ... 200 °C 0 % ... 40 % TPM
Accuracy:	±1 °C, ±2 % TPM
Resolution:	1 °C, 0.5 % TPM
Dimensions (W x L x H):	54 x 22 x 304 mm
Power supply:	3 V Lithium
IP code:	IP 67

Type	Description	PK	Cat. No.
FOM 330-4	Food Oil Monitor Set	1	6.284 848
FOM 330-1	Cooking oil tester	1	6.291 242
CO 330	Reference oil for FOM 330	1	6.291 243



Sample analysis/Photometers

1

1 LLG Photometers PrimeLab 1.0

The first and only photometer using just one LED and one (JENCOLOR) sensor, simultaneously covering 400 wavelengths in one go.

The JENCOLOR sensor allows self-calibration of the unit in seconds. More than 100 test methods are available to be individually selected when device is purchased. User can choose to either use tablet, liquid or powder reagents. Users can create and export test reports per "account" via software and/or App, where it can also store individual water treatment chemicals to create dosage recommendations. Using the PrimeLab adapter for Turbidity (NTU), PTSA and Fluorescein, even those parameters can be tested by the PrimeLab whereas user normally needs to purchase a second device. A full range of available test information can be found at www.primelab.org.

PrimeLab 1.0 Multitest Photometer BASIC-KIT 0-in-1

Without activated parameters and without reagents

PrimeLab 1.0 Multitest Photometer BASIC-KIT 3-in-1 (Chlorine/pH/Chlorine dioxide):

ID11 - Chlorine (free/combined/total) using DPD tablets

ID16 - Chlorine dioxide using DPD tablets

ID38 - pH using Phenol Red tablets

Reagent tablets to do 50 tests

More combinations of measurement methods on request.

PrimeLab 1.0 Multitest Photometer ALL-IN-KIT (all current and future parameters activated):

Contains the measurement methods of BASIC-SET 3-in-1 and same content as basic (over 100 parameters).

All available parameters are activated on the device and will be automatically added and activated while performing an update through PC-software or App.

Please order reagents separately.

Specifications

Optic:	JENCOLOR Multispectral sensor, covering 380 ... 780 nm
Connection:	Free PC software (windows) "PrimeLab Desktop Assistant" and free Android/iOS App
Calibration:	Auto-calibration function
One-Time-Zero:	Intelligent OTZ, based on chosen method
Time/date:	Real Time Clock with date and auto-off
Communication:	Bluetooth
Display:	LCD (monochrome)
Memory:	On device: 20 accounts/100 test results
Environment:	30 ... 90 % RH (non-condensing), ca. 5 ... 45 °C
Size (W x D x H):	180 x 90 x 60 mm
Weight:	160 g
Power supply:	4 x AAA batteries/5.0 V DC-adaptor with international adapter plugs
Warranty:	3 years

Description	PK	Cat. No.
Photometer, BASIC-KIT 0-in-1	1	6.280 344
Photometer, BASIC-KIT 3-in-1	1	6.268 024
Photometer ALL-IN-KIT	1	6.268 025

2

6.269 941

Reagent sets tablets

WATER-i.d. GmbH

H phrases: EUH210

Description	Measuring range	No. of determinations	PK	Cat. No.
	mg / l			
DPD No. 1 / Chlorine free	0 - 8	50	50	6.269 941 2
DPD No. 3 / Chlorine (combined/total)	0 - 8	50	1	6.281 708
DPD No. 4 / Active oxygen (MPS)	0 - 10	50	50	6.269 900
Total alkalinity / Alkalinity-M	5 - 200	50	50	6.269 901
Total alkalinity / Alkalinity-M-HR	0 - 500	50	50	6.269 902
Total hardness LR / HR	2 - 500	50	50	6.269 936
Cyanuric acid / CYA test	0 - 160	50	50	6.269 927
Potassium	0.7 - 12	50	50	6.269 943
Hydrogen Peroxide LR	0 - 3.8	50	1	6.269 981
Universal pH (5 - 11)	-	50	50	6.269 965

1 Photometers MD 110

NEW
Lovibond®



Photometer for the analysis of determined parameters in drinking, industrial and waste water. Different models are available for common analyses as well as for special applications.

- Ergonomic, waterproof design
- Accurate, reproducible measurement results
- User calibration and single point calibration
- Measurement results are displayed directly in ABS or %T
- Zero value remains valid for all tests with the same sample thanks to the one-time zero (OTZ) function
- Automatic storage of measured values with time and date stamp and optional data transfer (IRiM module)
- Bluetooth® interface
- Scroll memory
- Automatic shutdown
- Adjustment function display

Scope of supply: Photometer, carrying case, reagents for 100 tests, cuvettes, batteries, standard accessories

Further photometers available on request.

Specifications

Optics:	Highly precise interference filters, LED
Wavelengths:	530/560/610/430/580/660 nm
Wavelength accuracy:	±1 nm
Photometric range:	0.005 A
pH:	6.5 - 8.4
Data memory:	16 measurements
Dimensions (W x D x H):	75 x 155 x 35 mm
Weight:	260 g
Power supply:	4 x AAA micro batteries
IP code:	IP 68



Attention

H phrases: EUH210|H290|H315|H319|H226

Description	Measuring range	PK	Cat. No.
MD 110, chlorine, pH, cyanuric acid, reagent tablets	0.1 ... 10 mg/l Cl ₂ 0.02 ... 4.0 mg/l Cl ₂ 0.01 ... 6.0 mg/l Cl ₂ 10 ... 160 mg/l CyA	1	6.312 492
MD 110, chlorine, pH, cyanuric acid, alkalinity-m, liquid reagents	5 ... 200 mg/l CaCO ₃ 0.02 ... 4.0 mg/l Cl ₂ 10 ... 160 mg/l CyA	1	4.678 235
MD 110 chlorine, bromine, pH, cyanuric acid, alkalinity-m, calcium hardness, reagent tablets	0.05 ... 13 mg/l Br ₂ 0.1 ... 10 mg/l Cl ₂ 0.02 ... 4.0 mg/l Cl ₂ 0.01 ... 6.0 mg/l Cl ₂ 10 ... 160 mg/l CyA 5 ... 200 mg/l CaCO ₃ (TA) 20 ... 500 mg/l CaCO ₃ (CaH)	1	4.678 236



Danger

H phrases: H290|H314|H410|H340|H350|EUH208|H302|H311|H373|H302+H332

Description	Measuring range	PK	Cat. No.
MD 110, CSB	200 ... 15000 mg/l	1	4.678 237



Attention

H phrases: H290|H315|H319|H226

Description	Measuring range	PK	Cat. No.
MD 110, chlorine, pH, cyanuric acid, liquid reagents	0.02 ... 4.0 mg/l Cl ₂ 10 ... 160 mg/l CyA	1	4.678 233



1 Photometers MD 200

NEW
Lovibond®

Benchtop devices suitable for mobile use. For precise water control through high-precision optics and high-quality interference filters with long-term stable LEDs as light sources.

- Automatic shutdown
- Real time clock and date
- Adjustment function display
- Illuminated LCD-display

Further photometer versions available on request.

Specifications

Measurement cycle:	approx. 3 seconds (method dependent)
Optics:	Temperature compensated LED and photosensor intensifier in a waterproof sample chamber
Keyboard:	4-key polycarbonate film, splashproof
Dimensions (W x D x H):	110 x 190 x 55 mm
Weight:	455 g
Power supply:	4 x AA
IP code:	IP 68
pH:	6.5 - 8.4

Lovibond®



Attention

H phrases: EUH210|H290|H315|H319|H226

Description	Measuring range	PK	Cat. No.
MD 200, Chlorine, pH, cyanuric acid, reagent tablets (OTZ)	0.01 ... 6.0 mg/l Cl ₂ 0.1 ... 10.0 mg/l Cl ₂ 0 ... 160 mg/l Cys	1	9.920 202
MD 200, Chlorine, pH, acid capacity KS4.3, reagent tablets (OTZ)	0.1 ... 10 mg/l Cl ₂ 0.01 ... 6.0 mg/l Cl ₂ 0.1 ... 4 mmol/l KS4.3	1	6.288 460
MD 200, Chlorine, chlorine dioxide, pH, acid capacity KS4.3, reagent tablets (OTZ)	0.01 ... 6.0 mg/l Cl ₂ 0.02 ... 11 mg/l ClO ₂ 0.1 ... 4 mmol/l KS4.3	1	4.678 240
MD 200, Chlorine, pH, cyanuric acid, alkalinity-m, calcium hardness, reagent tablets (OTZ)	0.01 ... 10.0 mg/l Cl ₂ 0 ... 160 mg/l Cys 5 ... 200 mg/l CaCO ₃ (TA) 0 ... 500 mg/l CaCO ₃ (CaH)	1	6.205 840
MD 200, Chlorine, bromine, pH, cyanuric acid, alkalinity-m, calcium hardness, reagent tablets (OTZ)	0.01 ... 10.0 mg/l Cl ₂ 0.05 ... 13 mg/l Br 0 ... 160 mg/l Cys 5 ... 200 mg/l CaCO ₃ (TA) 0 ... 500 mg/l CaCO ₃ (CaH)	1	7.910 013
MD 200, Ozone, reagent tablets	0.02 ... 2 mg/l O ₃	1	4.678 241
MD 200 Chlorine, pH, reagent tablets (OTZ)	0.01 ... 6.0 mg/l Cl ₂ 0.1 ... 10.0 mg/l Cl ₂	1	6.238 112

Lovibond®



Danger

H phrases: H290|H302|H311|H314|H373|H410|H340|H350|EUH208|H302+H332

Description	Measuring range	PK	Cat. No.
MD 200, CSB, cuvette tests	200 ... 15000 mg/l	1	9.950 531

Lovibond®



Attention

H phrases: H290|H315|H319|H226

Description	Measuring range	PK	Cat. No.
MD 200, Chlorine, pH, cyanuric acid, liquid reagents for chlorine/pH (OTZ)	0.02 ... 4.0 mg/l Cl ₂ 0 ... 160 mg/l Cys	1	6.700 320

Lovibond®



Attention

H phrases: EUH210|H226|H290|H315|H319

Description	Measuring range	PK	Cat. No.
MD 200, Chlorine, pH, cyanuric acid, acid capacity KS4.3, reagent tablets (OTZ)	0.1 ... 10 mg/l Cl ₂ 0.01 ... 6.0 mg/l Cl ₂ 10 ... 160 mg/l CyA 0.1 ... 4 mmol/l KS4.3	1	4.678 239

1 Photometer system MD 600/MD 610

Modern, mobile photometers for rapid, reliable water testing

Lovibond®

All important water analysis parameters from Aluminium to Zinc are covered by these two devices. Combined with the high precision of Lovibond® reagents, a reliable and quick analysis of water samples is guaranteed. Reagent tablets, powder reagents, liquid reagents, or cuvette tests are used depending on the method. Please order separately. Six long-lasting LEDs serving as a light source in combination with interference filters guarantee the highest precision. The devices are designed without moving optical parts and thus have a maintenance-free measuring unit. Up to 1000 data records can be stored in the MD 600, MD 610 stores 500 data records.

- Highest/reproducible precision with interference filter
- Display with background lighting
- More than 120 pre-programmed methods
- Automatic selection of wavelength
- User guidance in German, English, French, Spanish, Italian, Portuguese and Polish
- Buffer for up to 1000 data records
- More than 35 user-specific methods possible
- Waterproof housing (as defined in IP 68, 1 hour at 0.1 meter)
- Handheld format, portable

MD 600 only:

- Infrared interface

MD 610 only:

- Bluetooth interface for connection to smart phones and tablets
- Cost-free iOS®- and Android™-App for data management and email delivery

Scope of supply: The instrument is supplied complete and ready-to-use in a carrying case, incl. 4 batteries, 3 vials diam. 24 mm, 3 vials diam. 16 mm, 1 adapter each for 16 mm and 13 mm vials. Please order reagents separately.

Specifications

Optics:	High-quality Interference Filters
Power Supply:	4 batteries (Mignon AA/LR6)
Operation time:	approx. 26 hours; continuous operation or 3500 tests
Dimensions (W x D x H):	approx. 210 x 95 x 45 mm (unit) approx. 395 x 295 x 106 mm (case)
Wavelengths:	530/560/610/430/580/660 nm
Wavelength Accuracy:	±1 nm
Photometric Accuracy:	0.005 A

Type	PK	Cat. No.
MD 600	1	9.699 235
MD 610	1	9.699 237



2 Waste Water Set-Up MD 610

NEW

Lovibond®

Flexible wastewater measuring station with mobile photometer MD 610 and thermoreactor RD 125, complete with reagents for COD measurement and the appropriate accessories. With the MD 610, the measurement results of the wastewater can be called up and evaluated on a smartphone or tablet. The RD 125 thermoreactor is equipped with 24 holes for 16 mm cuvettes.

- Data transfer via Bluetooth® and AquaLX® app
- Interference filter for increased reproducibility of the results
- Memory for 500 measurement results
- 120 pre-programmed methods

Scope of supply: Photometer MD 610, standard accessories, Thermoreactor RD 125, Cuvette tests: COD (0 ... 150 mg/l, 0 ... 1500 mg/l, ammonium VARIO HR (1 ... 50 mg/l N), nitrate VARIO (1 ... 30 mg/l N), nitrite LR VARIO Powder Pack (0.01 ... 0.3 mg/l N), nitrogen VARIO Total HR (5 ... 150 mg/l N), phosphate VARIO Total HR (0.02 ... 1 mg/l P/0.06 ... 3.5 mg/l PO₄), cuvette stand, membrane filtration set, operating instructions, warranty declaration



H phrases: H272|H302|H315|H319|H334|H317|H335|H318|EUH031|H290|H314|EUH210|H412



Type	PK	Cat. No.
MD 610	1	4.678 232



1 Photometer system MultiDirect

Lovibond®

With Dual Beam Technology. The MultiDirect is a modern, microprocessor-controlled photometer with ergonomically designed keypad and large-format graphic display. It is equipped with a wide range of pre-programmed methods (e.g. ammonia, COD, phosphate) based on the proven range of Lovibond® tablet reagents, liquid reagents, vial tests and powder reagents. The calibration and software-supported control options mean that the unit is also suitable for use as a testing instrument. The seven standard rechargeable batteries (supplied) ensure easy mobile use.

- Wide range of pre-programmed methods
- Large, graphics display
- RS232 interface
- Suitable for use with standard rechargeable batteries
- Updates for new methods and languages via the Internet
- 1000 data set memory
- Custom method recall is also possible

Scope of supply: MultiDirect, ready-to-use incl. 7 x rechargeable batteries and battery charger for 100 - 240 V, 3 each 24 mm and 16 mm cuvettes, 16 mm cuvette adapter, 3 x syringes, 1 x 100 ml plastic beaker and case with waterproof insert. **Without reagents and without battery** (please order separately).

Verification Standard Kit: The verification standard kit for the MultiDirect is designed to reassure the user about the accuracy and the reliability of the results. The shelf life of the standard kit is two years from the date of production, provided that storage and use are in accordance with the instructions provided. Measurements are taken in mAbs.

Specifications

Optics:	Dual-Beam Technology, High-quality Interference Filters
Measuring time:	approx. 10 seconds
Power supply:	7 Ni-MH-battery pack (1.5 V AA), charged in the unit using external power pack
Dimensions (W x D x H):	265mm x 70mm x 195mm
Ambient operating conditions:	up to max 90 % humidity (non condensing), approx. 5 ... 40 °C
Approval:	CE
Wavelengths:	430/ 530/ 560/ 580/ 610/ 660 nm

Type	PK	Cat. No.
MultiDirect	1	9.699 230

We can **supply** this
manufacturer's
whole
product range !



Spectrophotometers XD 7000 VIS and XD 7500 UV-VIS

UV-VIS and VIS spectrophotometers with dual beam optics. The instruments benefit from a barcode test recognition system, over 150 pre-programmed analytical methods and automatic cuvette detection. Analytical quality assurance procedures include checks of the photometer, the total system (including methods) and sample matrix effects. Further functions of the spectrophotometers include measurement of transmission and absorbance, scanning of spectra, kinetics analysis and creation of user-defined methods.

Lovibond®



6.272 436

- Premium optical system with reference beam
- Automatic test recognition with internal barcode reader
- Supports round cuvettes with 13, 16, 24 mm and rectangular cuvettes with 10, 20, 50 mm
- Automatic cuvette type detection
- More than 150 analytical methods implemented
- 7" colour display and keypad
- Ethernet, USB
- 20 user profiles possible
- Up to 1000 user programmes
- Creation of up to 100 further user-defined methods
- Password protection possible

Specifications

Optical System:	XD 7000 VIS // XD 7500 UV-VIS
Wavelength range:	grid monochromator with reference beam
Bandwidth:	320 - 1100 nm // 190 - 1100 nm
Wavelength accuracy:	4 nm
Wavelength repeatability:	±1 nm on all Holmium peaks
Photometric range:	better than 0.5 nm
Photometrical resolution/Transmission:	-3.3 to +3.3 Abs
Photometric accuracy/repeatability:	0.001 Abs/0.1 %
	0.003 Abs below 0.6 Abs
	0.5 % from 0.6 to 2.0 Abs
Photometrical linearity:	<1 % up to 2.0 Abs between 340 to 900 nm
Drift:	<0.005 Abs per hour after 15 minutes heat up time
Internal Storage:	40 MB for approx. 5000 data sets
Lamps:	Tungsten-halogen-lamp // Xenon flash lamp
Dimension (W x D x H):	422 x 323 x 195 mm
Weight:	approx. 4.5 kg
Power supply:	100 - 240 V, 50/60 Hz
Protection class:	IP 30

Type	PK	Cat. No.
XD 7000 VIS	1	6.272 436 1
XD 7500 UV-VIS	1	6.272 437

2 Reagent Tablets for Photometers Lovibond®



Attention

Lovibond®

H phrases: H319

Type	For	PK	Cat. No.
DPD No. 3 HR	Chlorine HR	100	4.652 757
DPD No. 1	Rapid	100	6.700 621
DPD No. 1	Rapid	250	6.802 151
DPD No. 1	Rapid	500	6.090 190
DPD No. 1	Bromine, Chlorine, Chlorine dioxide	100	9.947 065
DPD No. 1	Bromine, Chlorine, Chlorine dioxide	250	9.947 066
DPD No. 1	Bromine, Chlorine, Chlorine dioxide	500	9.947 067
DPD No. 3	Rapid	100	6.204 073
DPD No. 3	Rapid	250	6.802 152
DPD No. 3	Rapid	500	6.090 191
DPD No. 3	Chlorine	100	9.947 071
DPD No. 3	Chlorine	250	9.947 072
DPD No. 3	Chlorine	500	6.081 229
DPD (Ness) No. 1	Chlorine	100	9.947 079
DPD (Ness) No. 1	Chlorine	250	6.202 427
DPD (Ness) No. 2	Chlorine	100	9.947 080
DPD (Ness) No. 3	Chlorine	100	9.947 081
DPD (Ness) No. 3	Chlorine	250	6.259 802
DPD (Neutral) No. 2	Chlorine	100	9.947 069
DPD (Neutral) No. 2	Chlorine	250	9.947 070
DPD No. 1	High Calcium	100	6.201 659
DPD No. 1	High Calcium	500	7.652 409
DPD No. 3	High Calcium	100	7.661 450
DPD (Rapid) No. 4	Rapid	100	6.803 289
DPD (Rapid) No. 4	Rapid	500	7.662 035
DPD No. 4	Chlorine	100	9.947 073
DPD No. 4	Chlorine	250	9.947 074
DPD No. 4	Chlorine	500	6.802 774



Further products can be found in our online shop.

Sample analysis/Photometers



1 Reagent Tablets for Photometers Lovibond®

Lovibond®

Attention

H phrases: H317|H319

Type	For	PK	Cat. No.
Alka-M / Photometer	Alkalinity-M	100	6.203 284
Aluminium No. 1	Aluminium	100	6.206 570
Glycine	Glycine	100	6.204 189
Chlorine HR (Kj)	Chlorine	100	9.947 075
Chlorine HR (Kj)	Chlorine	250	9.947 076
CyA-Test	Cyanuric acid	100	6.204 477
CyA-Test	Cyanuric acid	250	6.205 791
Iron LR	Iron	100	9.947 100
Iron LR	Iron	250	9.947 101
Hardcheck P	Hardness total	100	6.801 459
Combi pack DPD No. 1 / No. 3	Chlorine	200	6.233 306
Combi pack DPD No. 1 / No. 3	Chlorine	500	6.236 962
Copper/Zinc HR	Zinc	100	9.947 130
Copper/Zinc HR	Zinc	250	9.947 131
Phenolred / Photometer	Phenol red	100	6.300 331
Phenolred / Photometer	Phenol red	250	6.202 544
Phenolred / Photometer	Phenol red	500	6.082 435
Phenolred (Rapid)	Phenol red	250	6.802 153
Phenolred	Phenol red	100	6.801 056
Phenolred	Phenol red	250	6.205 269
Phenolred	Phenol red	500	7.601 956
Buffer tablets	Buffer	100	6.801 670
Buffer tablets	Buffer	100	6.801 671
Copper No. 1	Copper	100	6.203 226

Further products can be found in our online shop.

2 Reagent solutions for photometers Lovibond®

Lovibond®

Solution with 15 ml or refill bottle with 100 ml.

Attention

H phrases: H290|H315|H319

For	Description	Colour	PK	Cat. No.
Chlorine	DPD No. 1	green	1	6.057 943
Chlorine	DPD No. 1*	green	1	7.510 823
Chlorine	DPD No. 1	blue	1	6.058 068
Chlorine	DPD No. 1*	blue	1	7.510 822
Chlorine	DPD No. 3	red	1	6.057 944
Chlorine	DPD No. 3*	red	1	6.203 285

* Refill bottle



3 Reagents VARIO for Photometer Lovibond® and HACH®

Lovibond®

Suitable for Lovibond® Photometers as well as for Photometers of company HACH®*

Danger

H phrases: H302|H318|H319|H314|H412

For	Measuring range mg / l	HACH® Method No.	PK	Cat. No.
Ammonium Vial Test LR	0.02-2.5	10023	50	6.204 985
Ammonium Vial Test HR	0.4-50	10031	50	6.204 108
Free Chlorine DPD	0.02-2	8021	100	6.203 803
Total Chlorine DPD	0.02-2	8167	100	6.802 999
Free Chlorine DPD	up to 3.5	-	100	6.236 015
Total Chlorine DPD	up to 3.5	-	100	6.236 016

*HACH® is a registered trademark of HACH® Company, Loveland, Colorado. Using brand HACH® contains no indication of a connection to this company or to a possible agreement of HACH® Company to composition, examination or suitability for use in spectrophotometers or other equipment or systems, which are sold under the brand HACH®.

Further products can be found in our online shop.

4 Cuvettes for photometers

Lovibond®

Type	Diam. mm	Description	PK	Cat. No.
Set of 5 round cuvettes with cap	24	24 mm dia.	5	6.230 635
Set of 10 round cuvettes with cap	16	16mm dia.	10	9.699 240
Set of 12 round cuvettes with cap	24	24mm dia.	12	9.699 231

Handheld photometers pHotoFlex® series, with/without pH and turbidity measurement

Handheld photometers for use in a wide range of areas such as process control, mobile water testing or wine industry. Easy operation with menu driven, user guidance.

WTW®

- Smart cuvette adapter: holds 28 mm or 16 mm round cuvettes with height 91 to 104 mm; to be used with a variety of different test types
- Optics: LED's with filters, accuracy < 2 nm
- Available wavelengths: 436 nm, 517 nm, 557 nm, 594 nm, 610 nm and 690 nm
- Concentration, Absorption, Transmission
- Methods can be downloaded from the Internet
- 35 (pHotoFlex® STD) 100 user defined routines
- 100 (pHotoFlex® STD)/1000 data sets, RS 232 interface
- pH range: pH 0 to 16.00 (±0.01) for DIN standard combination electrodes
- incl. calibration interval and calibration protocol
- Batteries: 4 button cells

Optional: LabStation with rechargeable battery and power plug, GLP-compliant software LSdata for simplified laboratory evaluation and operation, charging function; accu and power supply separately. LSdata is also available as stand-alone package

- IP code IP 67

pHotoFlex® STD

Water Analysis purely w/o pH- and turbidity measurement for standard parameters

pHotoFlex® pH

Just like the standard version of pHotoFlex STD plus full electrochemical pH-and ORP measurement via electrodes. This allows also the measurement of the parameters NH₃ and CO₂.

- pH 0 ... 16.00 (±0.01) for Standard-DIN pH-electrodes with automatic temperature compensation ATC and automatic buffer recognition
- Calibration intervall setting and calibration record
- 1-3 point calibration

pHotoFlex® Turb:

Generally as pHotoFlex® STD, with additional turbidity measurement:

- IR light source acc. DIN 27027 /ISO 7027
- Measuring range: 0 to 1100 NTU/FNU
- Resolution: 0 to 9.99 NTU: 0.01; 10 to 99 NTU: 0.1; 100 to 1100 NTU: 1NTU
- Accuracy: 0.01 NTU or 2% of measured value
- 3 point calibration
- Standard set with traceable AMCO® Standards (0.02 - 10 - 1000 NTU)

Complete pHotoFlex® Sets:

The mobile laboratory: smart with integrated lab table to hold instrument, cuvettes, beaker and stand for pH electrode.

Complete sets with:

- pH electrode SenTix 41 with technical buffers
- 1 adjustable pipette with 5ml volume for pHotoFlex® models
- Calibration standard kit for pHotoFlex® Turb and Turb® 40 IR/T

pHotoFlex® pH Set:

Field case with pHotoFlex®, table insert, pH electrode Sentix® 41 and stand, TEC buffer, 5 ml variable pipette, and accessories, PC cable and LSdata software.

pHotoFlex® Turb Set:

Field case with pHotoFlex® Turb, table insert, pH electrode Sentix® 41 and stand, TEC buffer, 5 ml variable pipette, and accessories, PC cable and LSdata software.



9.923 625



9.923 601

Type	PK	Cat. No.
pHotoFlex® STD	1	9.923 624
pHotoFlex® pH	1	9.923 625 1
pHotoFlex® Turb	1	9.923 626
pHotoFlex® pH Set	1	9.923 601 2
pHotoFlex® Turb/Set	1	9.923 602

Sample analysis/Photometers

1



1 Photometer photoLab® S6 and S12 - Filter photometer

High-precision, laboratory photometers with multilevel AQA/IQC functions. Features easy operation, GLP-conforming documentation, simultaneous turbidity compensation: open cover, place cell, measure! Automatic selftest and zeroing of the optical systems during start up. AutoSelect for cuvettes recognition via barcode; all necessary settings automatically of more than 150 programmed methods with automatic cuvette detection. Unique barcode-support for 10, 20 und 50 mm cuvette for high quality and economic reagent test kits. The RS232 interface transfers data to the user's PC. With real time clock and memory (incl. date/time) for 500 (S6) or 1000 (S12) data records. To be used with 16mm round cells and rectangular cells (only S12) 10, 20 and 50mm path length. Autozeroing. CE, UL, CUL tested.

WTW®

photoLab® S6

With 6 interference filters for 340/445/525/550/605/690 nm ±2 nm.
For routine applications with round cuvettes in waste water analysis.

photoLab® S12

With 12 interference filters ±2 nm. Wavelength according to S6 with additional filters for 410/500/565/620/665/820 nm. All test kits can be used (round cuvettes and reagent test kits), 50 user defined methods, Kinetic functions.

Type	Description	PK	Cat. No.
photoLab® S6	Mains version, 220 V European plug	1	9.923 631
photoLab® S6-A	Rechargeable battery version, 220 V European plug	1	9.923 632
photoLab® S12	Mains version, 220 V European plug	1	9.923 635
photoLab® S12-A	Rechargeable battery version, 220 V European plug	1	9.923 636
LP 6/12	Spare lamp for S6, S12	1	9.923 638

2



2 Cells for Photometer photoLab®

Cuvettes for photometric routine and water analytics in the UV-VIS and VIS range. Cells with matt side surface are suitable for the automatic cell detection of the photoLab® filter and spectral photometer. The glass and quartz cuvettes have a marking in order to place the cuvettes into the photometer in the same direction for an even higher precision.

WTW®

- Automatic cell detection
- Glass and quartz cells with marking for higher precision
- High quality optical glass for VIS
- High quality quartz glass for UV-VIS

Description	Material	Path length	PK	Cat. No.
		mm		
Round cells, empty		16	25	7.008 397
Rectangular cells	optical glass	10	2	7.300 132
Rectangular cells	Quarz	10	1	6.241 036
Disposable cells	PMMA	10	100	7.653 830
Rectangular cells	optical glass	20	2	7.510 080
Rectangular cells	Quarz	20	1	6.241 035
Rectangular cells	optical glass	50	1	7.200 109
Rectangular cells	Quarz	50	1	6.241 034

We can **supply** this
manufacturer's
whole
product range !



Spectrophotometer photoLab® 7100 VIS and photoLab® 7600 UV-VIS with OptRF

1

WTW®



6 268 620

COD measurement without reagents.

The spectrophotometer of the photoLab® 7000 Series are universally usable and offer complete photometric functionality with lauded user-interface and guidance on a brilliant HD 7" color display. Pioneering is the optical reagent-free measurement (OptRF) of COD, Nitrate and Nitrite. No time-consuming digestion and no harmful chemicals required.

- Proven routine analysis for waste and drinking water, aquaculture, food & beverage, environmental monitoring and production
- Cost saving reagent-free OptRF measurement
- Universal for industrial, research and educational use
- Lab quality in the field: 4.5 kg light weight, with car battery and field case option
- Linking lab with Online-system WTW® IQ SENSORNET via IQ LabLink
- For 16 mm round cuvettes and 10, 20 and 50 mm rectangular cuvettes with automatic recognition
- Memory for 5000 values, spectra and kinetics approx. 40 MB, equivalent to approx. 500 spectra (300-900 nm) and 400 kinetics with 150 measured values
- More than 200 programmed methods, 1000 user defined methods, 20 profiles each for kinetics and absorption spectrum, extensive programming options

Routine Analysis:

- More than 250 programs for commercial test kits, standard parameters, direct readings of coloration, SAK, etc. as well as user-defined programming of routines
- Barcode recognition for tests in vials and rectangular cells and automatic cell recognition for 16, 10, 20 and 50 mm without adapter and automatic measurement range selection
- Up to three parallel timers
- Optional PC-Software Package for Brewery and color measurement from CIE to Yellowness

Spectral and universal analysis from 190 to 1100 nm:

- Spectral scans in various nm-steps, 700-2000 nm/min
- Kinetics and multi-wavelength readings including special methods like chlorophyll and ADMI color measurement
- Extensive programming tools for multistep and multi-wavelength functions with user guidance

AQA: Multi-level user-friendly AQA functions with administration tools and comprehensive checking aids for meter and reagents.

Data Management:

- Measurement data, PDF documents, spectra and kinetics data, with data filter for pre-selected data management
- External barcode reading option for uncoded test kits and sample ID
- Optional: PC-Software for GLP compliant data management

Specifications

Optics:	Split beam
Wavelength range:	320 to 1100 nm (VIS)/190 to 1100 nm (UV-VIS)
Bandwidth:	4 nm
Lamp:	Tungsten Halogen (VIS)/ Xenon Flashlamp (UV-VIS)
Display:	Colour, 7" backlit
Wavelength accuracy / reproducibility:	±1 nm/<0.5 nm (VIS and UV-VIS)
Photometric accuracy / reproducibility:	-0.003 E for E < 0.600/0.5 % of values for 0.600
Interface/Update:	1 USB-A, 1 USB-B, 1 Ethernet/Update via Internet and USB-Stick
Temperature range:	Operation: +10 °C to +35 °C, Storage: -25 °C to +65 °C
Dimensions (W x D x H):	404 x 314 x 197 mm
Weight:	approx. 4.5 kg
IP code:	IP 30

Type	Description	PK	Cat. No.
photoLab® 7100 VIS	Routine and Spectral analysis 320-1100 nm	1	6.268 619
photoLab® 7600 UV-VIS	Routine and Spectral analysis with OptRF, 190-1100 nm	1	6.268 620 1
photoLab® Brew	Application package brewery analysis for the photoLab® 6000/7000 Series	1	9.920 080
photoLab® color+ Data spectral	PC software for data management of photoLab® 6000/7000 Series	1	6.284 662

Sample analysis/Photometers

1

1 Photometer photoLab® and photoFlex®, stored test programs

NEW
 WTW®

- A: Stored in photoLab® S6, S12, photoLab® 6000/7000 Series and photoLab® Spectral
 B: Stored in photoLab® S12, photoLab® 6000/7000 Series and photoLab® Spectral
 C: Stored in photoFlex® STD, photoFlex® pH and photoFlex® Turb
 D: Stored in photoLab® 6000/7000 series

Reagent-free tests:

- COD, Nitrate, Nitrite optical reagent-free measurement in sewage plant outlets
 Cu - copper plating bath, 690 nm, 820 nm - copper plating bath - B
 CrO₃ - chromium plating bath - chromium plating bath - B
 Ni - nickel plating bath - nickel plating bath - B
 HZ - Hazen colour - Hazen colour - B
 IFZ - iodine number, 340 nm, 455 nm - iodine number - B
 m-1 (DFZ) - colouring - FB445 - B, C
 m-1 (DFZ) - colouring - FB525 - A, C
 m-1 (DFZ) - colouring - FB620 - B, C
 FAU - turbidity 620 - T620 - B
 E - extinction - extinction - A, B, C
 SAK - Spectral absorption coefficient at 254 and 436 nm photoLab® 6100 VIS (436nm) and photoLab® 6600 UV-VIS (254/436 nm)

Further tests and checking aids like standards and reagent solutions for the instruments on demand, range information is based on max. range and can also be smaller for photoFlex®.

All stored test sets for the photoLab® and photoFlex® photometers can be found in our online shop. Ordering information for all the articles described above and for other articles can be found online.

Danger

H phrases: H290|H302|H311|H314|H373|H412

Type	For	Description	Measuring range	No. of determinations	PK	Cat. No.
			mg / l			
14544	A, C	NH ₄ -N, Ammonium	0.5 - 16.0 mg/l	25	1	9.920 927
14825	B, C	Al, Aluminium	0.02 - 1.20	300	1	9.920 906
14560	A	COD-O ₂ , COD	4.0 - 40.0	25	1	9.920 880
14690	A, C	COD-O ₂ , COD	50 - 500	25	1	9.920 934
14895	A, C	COD-O ₂ , COD	15 - 300	25	1	9.920 936
C3/25	A, C	COD-O ₂ , COD	10 - 150	25	1	9.920 956
01744	A	pH	6.4 - 8.6 pH	280	1	9.920 945
Cl-3 TP	C, D	Cl ₂ , Total chloride	0.00 - 2.00	100	1	9.920 864
Cu-1 TP	C, D	Cu, Copper	0.00 - 5.00	100	1	9.920 862
14553	A, C	Cu, Copper	0.05 - 8.00	25	1	9.920 887
14767	B, C	Cu, Copper	0.02 - 6.00	250	1	9.920 916
14394	B	SO ₃ , Sulfite	1.0 - 20.0 mg/l	25	1	9.920 900
14896	C	Fe, Iron	1.00 - 50.00	25	1	9.920 918
01746	B	SO ₃ , Sulfite	1.0 - 60.0 mg/l	150	1	9.920 948
00809	A,C	F, Fluoride	0.10 - 1.80	25	1	9.920 966



1 Thermoreactor RD 125

Lovibond®

Chemical digestion of samples is required for the photometric determination of COD, TOC, total chromium, total phosphate and total nitrogen. The required temperatures and reaction time can be selected by using the membrane keypad of the reactor RD 125. The unit works at three different temperatures (100/120/150 °C) and three pre-set reaction times (30/60/120 minutes). When digestion is complete, the reactor automatically switches off and gives a corresponding LED indication with short beep alarm. The RD 125 reactor is fitted with 24 holes for 16 mm diameter vials.



Specifications

Power supply:	230 V/50-60 Hz or 115 V/50-60 Hz (switchable)
Power:	550 W
Dimensions:	248 x 219 x 171 mm
Weight:	3.9 kg
Holes in the aluminium block:	24 holes, 16.2 mm ±0.2 mm
Selectable temp.:	100/120/150 °C
Selected time:	30/60/120/min. and continuous operation (∞)
Heating up:	from 20 °C to 150 °C in 12 min.
Protection against overheating	
Beeper	
Environmental conditions:	10 - 40 °C max. 85 % rel. humidity

Type	PK	Cat. No.
CSB reactor RD 125	1	9.920 204

Thermoreactor CR 2200/CR 3200/CR 4200

WTW®

CR 2200:

- Routine unit for waste water analysis
- Stored programs for all important digestions
- Thermoblock with 12 holes for 16mm o.d. reaction tubes
- Temperatures: 100 °C, 120 °C, 148 °C and 150 °C
- 8 fixed heating programmes: 148 °C and 2 hours, 148 °C and 20 minutes, 120 °C and 30 minutes, 120 °C and 60 minutes, 150 °C and 120 minutes, 120 °C and 120 minutes, 100 °C and 60 minutes, 30 minutes
- Automatic temperature switch-off after end of set programs

CR 3200:

CR 3200 thermoreactor for thermal digestion with 2x12 round cuvettes with 8 fixed/8 user-defined programs with temperatures of up to 170 °C and AQA

CR 4200:

- Professional unit for waste water analysis
- 2 thermoblocks with 12 holes each for 16mm o.d. reaction tubes,
- 8 fixed heating programs (as CR2200) and 8 user-defined programs (from room temperature (25 °C) to 170 °C and 0 to 180 minutes)
- High Temperature Capability
- 2 different programs and temperatures can be used simultaneously (CR 4200 only)
- Automatic temperature switch-off after end of set programs
- Optional: External temperature probe TFK CR

2



9.920 806

3



9.920 808

Type	PK	Cat. No.
CR 2200	1	9.920 806 2
CR 3200	1	9.920 807
CR 4200	1	9.920 808 3

Sample analysis/COD



1 COD measuring station MD 200

According to ISO 15705. This measuring station from Lovibond® allows the accurate, rapid, and economical determination of meaningful waste water COD levels (Chemical Oxygen Demand). Easy operation, even by unskilled operators. Comprises of COD photometer, 25 tube tests covering lower measuring ranges, a reactor block for sample digestion and a tube stand. Waterproof acc. to IP 68, 1 hour at 0.1 meter.

Lovibond®

Scope of supply: Instrument in carrying case, 4 batteries (AA), adapter for round vials diam. 16 mm, 2 sets of tube tests 0-150 mg/l and 0-1500 mg/l, thermoreactor RD 125, tube stand, 2 syringes, instruction manual.

Danger

H phrases: H290|H302|H311|H314|H373|H410|H340|H350|EUH208

Specifications:

Range:	0 to 15.000 mg/L
Measurement cycle:	approx. 3 seconds (method dependent)
Display:	LCD readout
Optics:	High-quality Interference Filters
Power:	4 batteries (AA) capacity approx. 53 hours or 15000 tests (continuous operation with backlit switched off)
Overall W x D x H:	190 x 110 x 55 mm
Storage:	16 data sets
Interface:	internal interface for test data transfer

Type	PK	Cat. No.
MD 200	1	9.920 205



2 COD-Standard Cuvette Test, 16 mm

Due to the chemical properties suitable for various photometers (e.g. Lovibond®, Hach®) with 16 mm tube diameter.

Lovibond®



Danger

H phrases: H290|H302|H311|H314|H340|H350|H373|H410

Type	Measuring range	PK	Cat. No.
CSB LR	0 ... 150 mg/l O ₂	25	9.950 533
CSB MR	0 ... 1500 mg/l O ₂	25	9.950 534
CSB MR	0 ... 1500 mg/l O ₂	1	6.242 606
CSB HR	0 ... 15000 mg/l O ₂	25	9.950 535

New logo - new name:

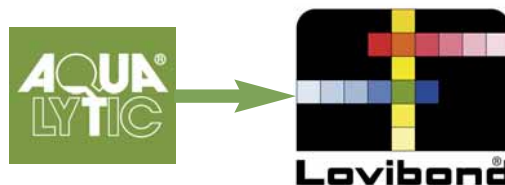
Aqualytic® becomes Lovibond®!



9.920 541

3 COD sample digestion units PA-CSB

Unit configuration for simultaneous digestion of maximum 6 or 12 COD samples in acc. with ISO, DIN etc.

behr

A digestion unit consists of the following components:

- TRS 300 microprocessor-controlled time and temperature control unit with COD program
- CSB/E Precision heating block for RG 2 reaction vessels
- E/B Insert and yoke type frame for RG 2 reaction vessels
- KW/N Cooling trough with holder and stands for E/B
- RG 2 Reaction vessels
- LK 1 COD air coolers
- LS Air cooler stands for LK COD air coolers

Type	PK	Cat. No.
PA-CSB 6	1	9.920 540
PA-CSB 12	1	9.920 541 3

COD workstations, PB-CSB/M

For COD determination. Complete workstations for simultaneous determination of maximum 6 or 12 samples in acc. with ISO, DIN etc. Manual metering and titration.

behr

A workstation consists of the following components

- TRS 300 Microprocessor-controlled time and temperature control unit with COD program
- CSB/E Precision heating block for RG 2 reaction vessels
- E/B Insert and yoke type frame for RG 2 reaction vessels
- KW/N Cooling trough with holder and stands for E/B
- SM 12/N Series magnetic stirrer for E 12/B insert/yoke type frame (only for PB-CSB 12/M)
- RG 2 Reaction vessels
- MRST 2 Magnetic stirrer rod set, 12 rods
- SIST 100 Boiling stones, contents 100 g
- LK1 COD Air coolers
- LS Air cooler stand for LK COD air coolers
- PTFE 29 PTFE Collars for LK 1, set of 12 collars
- TS COD Transport stands for E/B insert/yoke type frame
- HTI 1 Manual titration station

Type	PK	Cat. No.
PB-CSB 6/M	1	9.920 542
PB-CSB 12/M	1	9.920 543 ¹



2 behr COD Heating Blocks

COD acc. to ISO Precision heating blocks with 6, 12 or 24 sample positions. Flat surface heater for even temperature distribution to each sample position. Stainless steel and powder coated steel casing. Extensive insulation provides for inoffensive temperatures of the casing surfaces. End-to-end grooves in the precision aluminum plate at the bottom of the bores simplify sample handling and provide for exemplary safety of the analyst:

behr

- During sample insertion the grooves cause pressure compensation. Thus even the most accurately fitting reaction vessels slip easily into the bores, which is required to effortlessly handle the behr insert and yoke type frames for RG 2 reaction vessels.
- When inserting the samples into the hot heating block adherent moisture on the vessel surface evaporates in sudden bursts. The grooves drain off the vapor which otherwise might cause the vessels to jump up and down which might eventually lead to the destruction of the vessels.
- In case of one or more vessels overflowing the liquid COD samples discharge through the grooves minimizing the danger of damages inside the block caused by acids.



Type	Description	Power consumption W	Temp. range max. °C	PK	Cat. No.
CSB 6 / E	for 6 RG reaction vessels	800	299	1	9.920 721
CSB 12 / E	for 12 RG reaction vessels	1500	299	1	6.510 709
CSB 24 / E	for 24 RG reaction vessels	2000	299	1	6.054 780

3 TRS 300 programmable temperature and time control unit

Programmable control unit for behrotest® digester blocks. behr one-button operation for particularly easy and quick programming. Menu navigation in the language of the country. 10 optionally configurable programs for block temperature and digestion time. The TRS 300 has a special COD program which has already been set by the plant. Therefore in the operation mode "COD" it heats up to a temperature which is 20 °C above the set target temperature. After inserting the samples, the 20 °C higher target value remains for another 6 minutes. This procedure ensures heating up to 148 °C within 10 minutes which is specified by the ISO norm, and at the same time causes extremely high temperature constancy during the subsequent reaction process. The supplied Windows software permits the user to transfer time/temperatures profiles, which are specifically for the application, via the RS232 interface in both directions between one or more units (TRS 300) and a PC. Temperature data can also be transmitted from the unit to the PC via the RS232 interface while operating. The user can save them if necessary and print them out as graphics. Integrated safety function switches the connected units off if there is a short-circuit and an interruption of the temperature sensor.

behr



Type	Description	PK	Cat. No.
TRS 300	Temperature and control unit	1	6.229 909

Sample analysis/COD

1

1 behrotest® HTI 1 manual titration station

The HTI 1 manual titration station consists of behr

- a burette with digital display and
- a magnetic stirrer with a precisely fitting holder for COD reaction vessels. A screen serves as a neutral background and allows the user to determine the colour change at the end of the titration precisely. Therefore a titration could always be carried out under similar visual conditions. This improves the precision and the reproducibility of the results.

The precise positioning of the reaction vessels in the holder on the top of the magnetic stirrer also contributes to this. The angled wing of the screen protects against lateral dazzling light.

Specifications

Voltage	230 VAC/ 115 VAC
Frequency	50/60 Hz
Weight	approx. 3.5 kg
Dimensions in mm (W x D x H)	approx. 330 x 200 x 600

Type	Description	PK	Cat. No.
HTI	Manual titration station	1	9.920 730

2

2 COD cooling trough

The cooling trough prevents the overheating of the COD samples during the critical addition of sulphuric acid. In addition, it is used to cool the samples after the heating phase. behr

Type	Description	PK	Cat. No.
KW 6 /N	Cooling trough for E 6/B insert frame	1	9.920 706
KW 12/N	Cooling trough for E 12/B insert frame	1	6.052 519
KW 24/N	Cooling trough for E 12/BV insert frame	1	6.089 903
LS 6	Stands for 6 COD air coolers	1	9.920 723
LS 12	Stands for 12 COD air coolers	1	6.051 958

3

3 COD magnetic stirrer

The continuously adjustable COD series magnetic stirrer with 12 stirring points is used to mix the samples during the metering process. Due to its watertight casing and also its external power supply and control, it is suitable for use under water. behr

Type	Description	PK	Cat. No.
SM/12N	Series magnetic stirrer for E 12/B insert	1	6.055 561

4

4 Accessories for determining the COD

Type	Description	PK	Cat. No.
RG 1	Reaction vessel with NS 29, 175 ml volume, 100 ml scale mark	1	6.060 786
RG 2	Reaction vessel with vessel adapters, NS 29 and 100 ml scale mark, with PVDF collar	1	6.060 787
SIST 100	Boiling stones, contents 100g	1	9.920 710
LK 1	COD air cooler	1	6.060 788

5

5 COD metering funnel

COD metering funnels, placed on top of the COD reaction vessels, simplify the addition of sulphuric acid to several samples simultaneously. behr

COD metering funnel together with a cooling trough and a series magnetic stirrer increase the safety and offer considerable relief to the user when determining the COD.

Type	Description	PK	Cat. No.
DT 30	metering funnel, 30 ml, for sulphuric acid	1	9.920 713

1 HCl-absorber

To expel chloride, e.g. when determining the COD of sea water.

behr

1



Type	Description	PK	Cat. No.
HCL 29	HCL absorber to expel chloride	1	6.060 789

2 Automatic metering and titration unit DT 20

Dosage:

Time optimized COD interval dosage. The addition of sulfuric acid is carried out in several steps, while the samples are constantly cooled and stirred. This method accelerates sample preparation and at the same time prevents non-standard overheating of the samples during acid addition.

Titration:

Instead of the commonly known over-titration, the behr-specific dynamic titration guarantees the exact end-point recognition, even in the case of the typical COD edge steepness, and thus particularly accurate test results

behr

Type	Description	PK	Cat. No.
DT 20	Automatic metering and titration	1	9.920 748

2



3 Chemical Oxygen Demand (COD) Standards

These standards are ideal for use as control standards to verify that correct analysis for COD has taken place. Extensive range (10 to 60000 ppm), NIST traceable, 2 years shelf-life. HDPE bottle of 500 ml.

Reagecon

3



Type	Measuring range mg / l	PK	Cat. No.
COD10	10	1	4.012 235
COD20	20	1	6.286 181
COD50	50	1	6.234 998
COD100	100	1	6.234 999
COD200	200	1	6.206 516
COD500	500	1	6.234 552
COD600	600	1	6.206 517
COD1000	1000	1	6.232 202
COD1300	1300	1	6.206 518
COD1500	1500	1	6.238 379
COD2000	2000	1	6.286 182
COD3000	3000	1	6.286 183
COD5000	5000	1	4.012 236
COD6000	6000	1	6.286 184

Sample analysis/BOD

1



1 BOD measurement systems OxiTop®-IDS

BOD measurement system for all types of respirometric measurements, e.g. soil respiration, microbiological activity measurement, biogas determination as well as extended BOD measurement for the industrial waste water plants and further degradation tests in 3 selectable measuring types, BOD special and pressure. With the proven Bluetooth® connectivity and the convenient operation via MultiLine® multi parameter instrument Multi 3620 IDS or Multi 3630 IDS. Using a Multi 3620 IDS or Multi 3630 IDS in BOD special mode the BOD measuring range extends to 400000 mg/l. For an already existing Multi 3620 or 3630 IDS, a firmware update is sufficient. Herewith beneath the OxiTop® applications also measurement of pH, conductivity, solved oxygen and turbidity are available. All heads can be used independently for routine BOD measurements from 1 to 7 days.

WTW®

- Bluetooth® connectivity
- Direct calculation of all results in the meter
- Representation of curves for monitoring
- Parallel measurement of different examinations and methods
- Export to data acquisition programs

Specifications

Pressure range:	500 ... 1250 hPa
BOD range:	0 ... 4000 mg/l
Measurement period:	0.5 h ... 180 d
Memory:	360 values
Display:	LCD
Power supply:	100 ... 240 VAC, 50/60 Hz

2



6.314 040

BOD measuring system OxiTop®-IDS for determination of aerobic degradation

These tests quantify the biological degradability of chemicals. The OxiTop®-IDS A12 is also suited for high dilutions.

WTW®

- Respirometric degradability tests according to OECD 301F/DIN EN ISO 9408
- Versatile measurement by using the BOD special mode

Scope of supply:

OxiTop®-IDS Set 6: 6 x OxiTop®-IDS measuring heads, 6 x bottles PF600 (510 ml), 6 x rubber sleeves, nitrification inhibitor, overflow measuring flask, 6 x magnetic stirring bars, stirring bar retriever, stirring platform IS 6

OxiTop®-IDS Set 12: 12 x OxiTop®-IDS measuring heads, 12 x bottles PF600 (510 ml), 12 x rubber sleeves, nitrification inhibitor, overflow measuring flask, 12 x magnetic stirring bars, stirring bar retriever, stirring platform IS 12

3



6.314 042

Extension set for OxiTop®-IDS 6/12: 6 resp.12 OxiTop®-IDS measuring heads, 6 resp.12 bottles, universal power adapter, 6 resp.12 rubber sleeves, 6 resp.12 magnetic stirring bars, stirring platform IS 6 resp. IS 12

OxiTop®-IDS A6: 6 x OxiTop®-IDS measuring heads, 6 x bottles PF45/1000 (1000 ml), 6 x adapter OxiTop® AD/SK, nitrification inhibitor, 6 x magnetic stirring bars, stirring bar retriever, stirring platform IS 6-Var

OxiTop®-IDS A12: 12 x OxiTop®-IDS measuring heads, 12 x bottles PF45/250 (250 ml), 12 x adapter OxiTop® AD/SK, nitrification inhibitor, 12 x magnetic stirring bars, stirring bar retriever, stirring platform IS 12

Please order CO₂ absorber NHP 600 (9.303 403) separately.

The IDS multi parameter measuring instruments Multi 3620 IDS Set WL or Multi 3630 IDS Set WL are required. Please order separately.

Type	Description	PK	Cat. No.
OxiTop®-IDS Set 6	6 measuring places, stirring platform IS 6	1	6.314 040 2
OxiTop®-IDS Set 12	12 measuring places, stirring platform IS 12	1	6.314 041
OxiTop®-IDS IS 6	Extension set for OxiTop®-IDS Set 6	1	6.311 247
OxiTop®-IDS IS 12	Extension set for OxiTop®-IDS Set 12	1	6.311 248
OxiTop®-IDS A6	6 measuring places, stirring platform IS 6-Var	1	6.314 042 3
OxiTop®-IDS A12	12 measuring places, stirring platform IS 12	1	6.314 043

4



4 Wireless module for WTW® measuring instruments

Wireless module for connecting to MultiLine® 3310/3510/36x0 IDS, inoLab® Multi IDS and MonoLine. Connects up to three sensors at the same time (depends on meter capabilities). Also for operation of OxiTop®-IDS.

WTW®

Type	PK	Cat. No.
IDS WLM-M	1	6.311 250

BOD Measuring system OxiTop®-IDS for determination of soil respiration

Respirometric measuring system for 6 measuring heads for determination of aerobic soil respiration, OxiTop®-IDS B6M-2.5 acc. to AT4 guideline. These sets are suitable for forecast, survey and monitoring of clean-up operations as well as measurement of bio-degradation of pesticides, fungicides, insecticides and fertilizers for example.

WTW®

Scope of supply:

- OxiTop®-IDS B6:** 6 measuring heads, 6 sample bottles PF45/500 (500 ml), 6 adapters OxiTop® AD/SK
- OxiTop®-IDS B6M:** as OxiTop®-IDS B6, but with 6 vessels MG 1.0 (1000 ml)
- OxiTop®-IDS B6M-2.5:** as OxiTop®-IDS B6M, but with 6 vessels MG 2.5 (2500 ml) and Soda-Lime CO₂ absorbent

Please order CO₂ absorber NHP 600 (9.303 403) separately.
The IDS multi parameter measuring instruments Multi 3620 IDS Set WL or Multi 3630 IDS Set WL are required. Please order separately.

1



6.314 046

Type	PK	Cat. No.
OxiTop®-IDS B6	1	6.314 046 1
OxiTop®-IDS B6M	1	6.314 047
OxiTop®-IDS B6M-2.5	1	6.311 259

BOD Measuring system OxiTop®-IDS for determination of biogas/microbiology

For the measurement of anaerobic degradability with OxiTop®-IDS/B measuring heads. The main application for these sets is the testing of fermentability of biological waste for biogas plants acc. to VDI 4630. The yield of methane can be measured in the pressure mode.

WTW®

- Convenient and safe operation within an extended pressure range of up to 1500 hPa
- Pressure range excess warning
- Corrosion-proof head even in presence of H₂S

Scope of supply:

- OxiTop®-IDS AN6:** 6 x OxiTop®-IDS/B measuring heads, 6 sample bottles MF45/1000 (1000 ml), nitrification inhibitor, 6 x magnetic stirring bars, stirring bar retriever, 1 stirring platform IS 6-Var
- OxiTop®-IDS AN12:** 12 x OxiTop®-IDS/B measuring heads, 12 sample bottles MF45/250 (250 ml), nitrification inhibitor, 12 x magnetic stirring bars, stirring bar retriever, 1 stirring platform IS-12

Please order CO₂ absorber NHP 600 (9.303 403) separately.
The IDS multi parameter measuring instruments Multi 3620 IDS Set WL or Multi 3630 IDS Set WL are required. Please order separately.

2



6.314 044

Type	PK	Cat. No.
OxiTop®-IDS AN6	1	6.314 044 2
OxiTop®-IDS AN12	1	6.314 045

Wireless measuring heads OxiTop® IDS

OxiTop®-IDS wireless measuring head with Bluetooth® LE technology for operation with Multi 3620 IDS or Multi 3630 IDS. For routine BOD readings also operable without IDS multiparameter instrument. OxiTop®-IDS/B with enhanced pressure range up to 1.5 bar and H₂S resistant pressure sensor for biogas measurement.

WTW®

- Memory for 360 measuring points
- 3 operating buttons
- Backlit graphic LCD
- Control LED
- Volume pre-selection
- For routine BOD readings measurement duration selectable (1 to 7 days)
- Display of measuring curve
- Display of current readings
- Intermediate values available

3

4



6.311 251



6.311 252

Type	Description	PK	Cat. No.
OxiTop®-IDS	1 wireless measuring head	1	6.311 251 3
OxiTop®-IDS/B	1 wireless measuring head	1	6.311 252 4
OxiTop®-IDS 2	2 wireless measuring heads	1	6.311 253
OxiTop®-IDS 6	6 wireless measuring heads	1	6.311 254

Sample analysis/BOD

1

1 Multi parameter measuring instruments Multi 3620/3630 IDS SET WL for BSB measuring system OxiTop® IDS

Professional, digital multi-parameter measuring instrument for mobile measurement, with 2 or 3 universal measuring channels, radio-ready, color graphic display, data logger and USB interfaces. Also for controlling OxiTop® IDS.

WTW®

Scope of supply: Instrument, short manual, CD-ROM, rechargeable batteries, driver software for USB, cable, power supply, protection SM Pro, IDS WLM-M module

Type	Description	PK	Cat. No.
Multi 3620 IDS SET WL	2 measuring channels	1	6.311 255
Multi 3630 IDS SET WL	3 measuring channels	1	6.311 256

2

2 BOD measurement system OxiTop®-i IS 6/12

Easy-to-use, respirometric measuring system for determining the biological oxygen demand (BOD). The method is based on changes of pressure in a closed system using measuring heads attached to the sample bottles. The BOD can be determined simultaneously in up to 6 or 12 samples.

WTW®

- No dilution of the sample required
- Direct reading of the BOD, the time course and the intermediate values on the graphical display of the measuring heads
- Input of the used sample volume directly at the measuring head
- Monitoring time between 1 and 7 days
- Permanent display of the current status at each measuring head
- Coloured measuring heads with adjustable, numerical sample identification

Scope of supply:

OxiTop®-i IS 6: 6 x measuring heads (3 x blue, 3 x grey), 6 x sample bottles PF600, 6 x rubber quivers, CO₂ absorber, nitrification inhibitor, overflow measurement flasks, 6 x stirring rods, stirring rod remover, stirring platform SI 6
 OxiTop®-i IS 12: 12 x measuring heads (6 x blue, 6 x grey), 12 x sample bottles PF600, 12 x rubber quivers, CO₂ absorber, nitrification inhibitor, overflow measurement flasks, 12 x stirring rods, stirring rod remover, stirring platform SI 12

An incubator is required to operate the OxiTop®-i IS. Please order separately.

Danger

H phrases: H290|H314

Specifications

Pressure range: 500 ... 1250 hPa
 BOD range: 0 ... 4000 mg/l
 Display: Graphical LCD, background-illuminated
 Power supply of measuring heads: 1 x CR 2450
 Power supply of stirring platform: 100-240 V, 50/60 Hz

Type	PK	Cat. No.
OxiTop®-i IS 6	1	7.940 936
OxiTop®-i IS 12	1	4.667 879

3

3 Measuring heads OxiTop®-i

Menu-operated measuring heads. Output of the BOD measurement values directly on the display.

WTW®

- 3 operating buttons
- Backlit graphic LCD
- Control LED
- Volume pre-selection
- Measurement duration selectable (1 to 7 days)
- Display of measuring curve
- Display of current readings

Type	Description	PK	Cat. No.
OxiTop®-i G	1 x measuring head grey	1	4.667 695
OxiTop®-i B	1 x measuring head blue	1	7.940 950
OxiTop®-i 2	1 x measuring head grey, 1 x measuring head blue	1	6.311 186
OxiTop®-i 6	3 x measuring head grey, 3 x measuring head blue	6	6.311 382
OxiTop®-i 12	6 x measuring head grey, 6 x measuring head blue	1	6.311 249
OxiTop®-i Set 2	1 x measuring head grey, 1 x measuring head blue, 2 sample bottles, 2 rubber quivers, 2 magnetic stirring rods	1	4.668 473
OxiTop®-i Set 6	3 x measuring head grey, 3 x measuring head blue, 6 sample bottles, 6 rubber quivers, 6 magnetic stirring rods	1	4.667 970

Accessories for B.O.D. Auto-Check Measurement Systems OxiTop®



Danger

H phrases: H290|H314

WTW®

Type	Description	PK	Cat. No.
OxiTop® PT	Leakage test material	1	7.089 857 1
NHP 600	Sodium hydroxide pads	2	9.303 403
NTH 600	Nitrification inhibitor	1	9.303 431
GK 600 L	Rubber sleeve for CO ₂ absorber	1	9.303 405
PF 600	Spare bottle	1	9.303 401
ST-OxiTop®	Storage rack	1	7.008 310
Mark-6	Marking set	6	7.008 312

1



7.089 857

2 BOD sensor system



2

Measuring systems for the reliable determination of 90 to 999 ppm BOD. Complete with sensor heads and multi-position magnetic stirrer.

Velp Scientifica

- The sensor heads are screwed directly onto the BOD bottles
- Automatic storage of 5 results in 24-hour intervals
- Measured readings in mg/l (ppm) can be read directly on the sensor at any time
- Protected against splashing water (IP 54)

Scope of supply BOD sensor system 6: 6-position magnetic stirrer, each 6 BOD sensors incl. batteries, 500 ml brown glass bottles, KOH reservoirs and magnetic stirring rods

Scope of supply BOD sensor system 10: 10-position magnetic stirrer, each 10 BOD sensors incl. batteries, 500 ml brown glass bottles, KOH reservoirs and magnetic stirring rods



Specifications

BOD range: 90 ... 999 ppm
 Display: LED (3 digits)
 IP code: IP 54

Type	Description	Type of auxiliary energy	PK	Cat. No.
BOD sensor system 6	6 positions	230 V, 60 Hz	1	4.666 812
BOD sensor system 10	10 positions	230 V, 60 Hz	1	4.666 813
BOD sensor set	500 ml brown glass bottle with BOD sensor, KOH reservoir, stirring rod		1	4.666 791
BOD sensor	Single sensor		1	4.666 790

3 BOD EVO Sensor System 6



3

Measuring systems for the reliable determination of 90 to 999 ppm BSB. Complete with sensor heads and multi-position magnetic stirrer. With wireless data transfer and monitoring function on connected PCs.

Velp Scientifica

- An existing Wireless DataBox™ can monitor up to 80 BSB EVO sensors
- BSB EVO sets without Wireless DataBox™ can be purchased to expand an existing measurement system
- Data visualisation on the PC with software BODsoft™
- The sensor heads are screwed directly onto the BSB bottles
- Configurable measuring intervals and automatic data storage
- Measured readings in mg/l (ppm) can be read directly on the sensor at any time
- Protected against splashing water (IP 54)

Scope of supply: 6-position magnetic stirrer, each 6 BSB EVO sensors incl. batteries, 500 ml brown glass bottles, KOH reservoirs and magnetic stirring rods

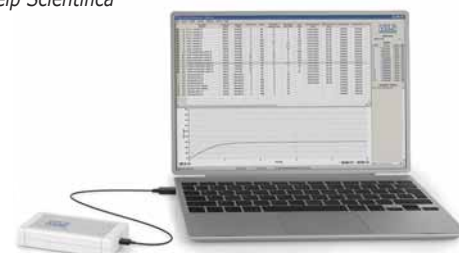

Specifications

BOD range: 90 ... 999 ppm
 Display: LED (3 digits)
 IP code: IP 54

Type	Type of auxiliary energy	PK	Cat. No.
BSB EVO Sensor System 6*	230 V, 50 Hz	1	4.666 811
BSB EVO Sensor System 6 with Wireless DataBox™	230 V, 50 Hz	1	4.666 810

* Wireless DataBox needed for operation

Sample analysis/BOD



1 BOD-Measurement-System BD 600

Lovibond®

BOD measurement is an important measurement of the effects of domestic and industrial waste water on sewage plants and outflow points.

The sensor system BD 600 is a 6 sample system that allows precise measurements of BOD based on the manometric principle. Manometric respirometers relate oxygen uptake to the change in pressure caused by oxygen consumption while maintaining a constant volume. Due to the modern integral pressure sensors, it is not necessary to use mercury for the measurements. The BOD values are stored automatically in the sensor memory at regular intervals and can be called up on the large-format display at any time without the need for time-consuming conversion using factors. This means that test series that end on a Sunday can be evaluated during the following week without any problem. Measurement series can be stored on USB stick/ SD card or transferred via USB cable to evaluate the data on a computer. The measurement period is user-selectable between 1 and 28 days to suit the application. While short measurement periods are useful for scientific applications, standard BOD measurements typically extend over a period of 5 days - and manometric determination of OECD, for example, generally takes place over a period of 28 days.

Scope of supply:

- BD 600, complete unit with 6 or 12*sensor heads and control unit with batteries
- Power supply unit incl. Y-cable for common power supply of BD 600 and stirring unit
- Inductive stirring unit
- 6 or 12*sample bottles
- 6 or 12*rubber gaskets
- 6 or 12*magnetic stirring rods
- 1 overflow flask, 157 ml
- 1 overflow flask, 428 ml
- 1 bottle, 50 ml potassium hydroxide solution
- 1 bottle, 50 ml nitrification inhibitor solution
- 1 instruction manual
- remote control

Danger

H phrases: H360FD

Specifications

Measuring principle:	respirometric, electronic pressure sensor
Ranges:	0 - 40, 0 - 80, 0 - 200, 0 - 400, 0 - 800, 0 - 2000, 0 - 4000 mg/l O ₂
Measurement period:	User-selectable, between 1 and 28 days
Power supply:	100-240 V, battery buffered or via power supply using Y-cable
Protection class:	IP 54 (sensor head)
Interface:	USB host port (USB stick), USB device port (computer), SD card
Clock:	Real time
Application:	BOD5/BODF/OECD301F

Type	Description	PK	Cat. No.
BD 600	with 6 bottles	1	6.268 048
BD 600 GLP	with 6 bottles, GLP conformity	1	4.678 126
BD 606	with 12 bottles	1	6.280 155
Nitrification inhibitor (N-ATH)	liquid, bottle of 50 ml	1	9.303 433
Sensor Calibration Set	for BSB/BOD Sensor	1	6.203 214

* 6 or 12 depending on BOD-System (BD600 or BD606)

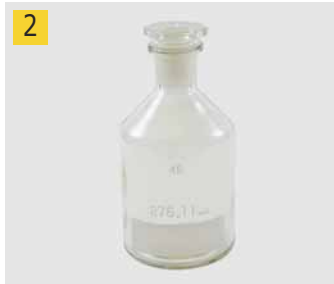

2 Dissolved oxygen bottles, Winkler pattern

Winkler pattern. Soda-lime glass.

For determination of dissolved oxygen in water. The measured capacity is specified to ± 0.01 ml.

With white labelling area. Solid, bevelled glass stopper, secured with an accessory spring clip.

Each bottle is adjusted to the relevant stopper. Stoppers and bottles are therefore not interchangeable.

Each bottle and its stopper is marked with a unique, matching identification number.

Nominal capacity ml	NS	Snap-on clip	PK	Cat. No.
100 to 150	14/23	9.304 050	1	9.304 038
250 to 300	19/26	9.304 051	1	9.304 048



3 Spring clips for oxygen bottles according to Winkler

For bottles ml	PK	Cat. No.
100 - 150	1	9.304 050
250 - 300	1	9.304 051

1 BOD meters Type KF 12, accessory funnel bottle

Karlsruher BOD bottle with NS19 conical ground joint.

behr



Type	PK	Cat. No.
Karlsruher BOD bottle, 250 ml	1	9.304 170

2 Bottles (Karlsruhe bottles) with stoppers

The special bottle neck of the Karlsruhe bottles absorbs the water which is displaced by the stopper of the electrode. This construction guarantees clean working and ensures at the same time that the test results are not adulterated by unwanted entry of oxygen into the samples.

behr



Capacity ml	Length*	PK	Cat. No.
100	20	1	9.920 514
100	60	1	9.920 515
250	20	1	9.920 513
250	60	1	9.920 509

* Stopper handle length (mm)

Plastic stopper, PPC

Plastic stopper with NS 19, PPC, for Karlsruher BOD bottle



behr



Length mm	PK	Cat. No.
69	1	7.647 391 3
97	1	6.313 219 4

7.647 391

6.313 219

Controlled Temperature Cabinets BOD

Compact temperature cabinets with internal plugs for the use of OxiTop® IS 12 stirring platforms. Depending on the size of the model 2 to 4 shelves are included. So up to 48 standard BOD samples or 4 stirring platforms can be accommodated. For special applications the largest Model TS 1008-i is required, having enough space between the shelves for 1.5L bottles. Models with insulation glass door allow for visual control of the OxiTop® heads without opening the door.

- Incubation conforming to standards
- Suited for BOD, OECD 301F, soil respiration, anaerobic degradation
- Temperature adjustable in steps of 1 K between 10 and 40 °C
- Eco-friendly refrigerant R600a

Note: The necessary temperature constancy will only achieved in combination with the samples.

TS 608/2i: Model for standard applications, with 2 internal plugs, incl. 2 shelves

TS 608-G/2i: As TS 608/2i, but with door made of insulation glass

TS 608/4i: Model for extensive sample processing, with 4 internal plugs, incl. 4 shelves

TS 608-G/4i: As TS 608/4-i, but with door made of insulation glass

TS 1008i: Model for particular applications with special vessels e.g. biogas or soil respiration measurement, with 4 internal plugs, incl. 4 shelves

Specifications

Temperature range:	10 ... 40 °C
Increment:	1 K
Temperature stability:	±0.5 K

Type	Nom. capacity	External dimensions (W x D x H) L mm	Internal dimensions (W x D x H) mm	PK	Cat. No.
TS 608/2i	180	600 x 600 x 850	513 x 441 x 702	1	4.665 324 5
TS 608-G/2i	180	600 x 600 x 850	513 x 441 x 702	1	4.665 325
TS 608/4i	360	600 x 610 x 1640	470 x 440 x 1452	1	4.665 326
TS 608-G/4i	360	600 x 610 x 1640	470 x 440 x 1452	1	4.665 327
TS 1008i	500	750 x 730 x 1640	600 x 560 x 1452	1	4.665 328

WTW®



4.665 324

Sample analysis/BOD

1



1 Thermostatic cabinets

The incubators from Lovibond® are designed for continuous tempering for different applications, mainly for the determination of BOD, the storage of wastewater samples, and the determination of enzymatic activity. The temperature range is +2 °C up to +40 °C and can be regulated in steps of 0.1 °C. Temperature tolerance is defined with ±1 °C respectively ±0.5 °C (at 20 °C). Low energy consumption due to reinforced isolation. The interior of the cabinets is equipped with sockets for connecting stirrers. There are 3 models available with standard doors from 135 to 445 litres net capacity, and 2 models with glass doors with 140 and 255 litres net capacity. Illuminated LED display with actual/setpoint display.

Lovibond®

- Temperature range 2 °C to 40 °C, continuously adjustable in steps of 0.1 °C
- Low power consumption
- Illuminated LED display of preset and current temperatures
- Ideal for BOD determination at 20 °C
- Power sockets inside the incubator
- 5 models in 3 sizes
- Standard door or glass door

Specifications

Coolant: R134a
 Fan: Axial, delivery rate 320 m³/h
 Power supply: 220-230 V/50 Hz

Capacity	External dimensions (W x D x H) mm	Internal dimensions (W x D x H) mm	Weight kg	Temp. range max. °C	PK	Cat. No.
135	600 x 600 x 850	513 x 441 x 704	39.0	+2 ... +40	1	9.699 142
255	600 x 610 x 1640	470 x 440 x 1452	61.0	+2 ... +40	1	9.699 144
445	750 x 730 x 1640	600 x 560 x 1452	78.5	+2 ... +40	1	9.699 145
140	600 x 600 x 850*	513 x 441 x 702	48.0	+2 ... +40	1	9.699 146
256	600 x 610 x 1640*	470 x 440 x 1452	77.0	+2 ... +40	1	9.699 147

* With glass door

2 BSB mixing equipment

NEW

behrotest® BSB mixing equipment is reliable and easy to operate. With the fitting additional requirements - from dilution water container with cooling hose over the recirculation thermostat up to the fine metering unit for allylthiourea - entire workstations can be combined. 1 graduated mixing column with 1 l content, three-way valve made of PTFE for bubble-free addition of dilution water from below, however with level deactivation and rinsing device.

behr

Type	Description	PK	Cat. No.
BSB4A-2	BSB mixing equipment	1	4.675 371

2



1 2 Imhoff Sedimentation cones, borosilicate glass 3.3

Manufactured from borosilicate glass 3.3 according to sedimentation tests according to DIN 12672 standard. Featured with volume graduation of 1000 ml.

ISOLAB

Volume graduations and inscriptions are printed with white enamel.

Graduations, ml:	Subdivisions ml:
0 to 2	0.1
2 to 10	0.5
10 to 40	1.0
40 to 100	2.0
100 to 1000	50.0

Type	PK	Cat. No.
without stopcock	1	6.286 841
with stopcock	1	6.286 842

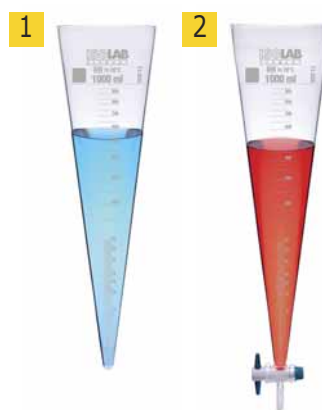

3 Sedimentation cones, borosilicate glass 3.3

Imhoff pattern. DIN 12672. Graduations and inscriptions in contrasting white enamel. Ring mark at 1000 ml.

Graduations, ml:	Subdivisions ml/Tolerance ±ml:
0 to 2	0.1/0.1
2 to 10	0.5/0.5
10 to 40	1/1
40 to 100	2/2
100 to 1000	50/10

Type	Grad.	PK	Cat. No.
	ml		
Without stopcock	up to 100*	1	9.304 262
With stopcock	up to 1000	1	9.304 272
Without stopcock	up to 1000	1	9.304 273

* No subdivisions from 100 to 1000 ml.



4 Sedimentation cone, plastic, SAN

Imhoff pattern. DIN 12672. Transparent SAN (Styrene acrylonitrile).

Kartell

With screw cap for draining the contents. Temperature-resistant up to max. 85 °C.

Graduations, ml:	Subdivisions, ml
0 to 2	0.1
2 to 10	0.5
10 to 100	1.5
100 to 300	10
300 to 1000	50

Type	Grad.	PK	Cat. No.
	ml		
With screw cap	up to 1000	1	9.304 280



5 Stand for Imhoff Sedimentation cones, PP

The stand for sedimentation funnels is used to keep, hold or store Imhoff funnels safely and reliably during sedimentation. Two funnel holders ensure that Imhoff funnels will be held safely and securely and can be placed in an absolutely vertical position. Stand with two holders for sedimentation funnels, suitable for funnels 90 mm or more in diameter. Thanks to an innovative magnet concept no clamping screws are necessary. The height of the funnel holder can be adjusted easily and flexibly with one hand. With the corresponding accessory the holders for Imhoff funnels can also be replaced by holders for all-purpose funnels.

Bürkle

- PP, chrome-plated steel
- Adjustable height up to 450 mm
- For funnels with Ø 90 mm or more

Description	PK	Cat. No.
Stand for 2 funnels	1	6.201 027



➔ Accessories - please see page 101.

Sample analysis/Turbidity



1 Stands for Imhoff cones, PMMA

Manufactured to hold two Imhoff sedimentation cones of any type. Compact design allows easy carry of Imhoff cones even when the cones are filled. The unique designs provide easy carry of all types of Imhoff cones with or without stopcock.

ISOLAB

Type	Material	PK	Cat. No.
Stands for Imhoff cones	PMMA	1	4.672 226



2 Sedimentation cones, accessory stand, Acrylic/PP

Acrylic/PP. To hold two Imhoff sedimentation cones. Compact and easy to transport even when fully loaded.

Kartell

Width mm	Length mm	Height mm	PK	Cat. No.
150	300	294	1	9.304 281



Sedimentation cones, accessory holders, PVC

Imhoff pattern, solid grey PVC. Stable design.

behr

For	PK	Cat. No.
2 Imhoff funnels without stopcock	1	9.882 101
4 Imhoff funnels without stopcock	1	9.882 102
2 Imhoff funnels with stopcock	1	9.882 103 3
4 Imhoff funnels with stopcock	1	9.882 104

9.882 103



4 5 Secchi Disk

For determining the depth of visibility and light permeability of water. Sturdy design made of strong, hard-wearing plastic. Lead weight for better lowering. The approx. 15 cm high rod is fitted with an eyelet for fastening the lowering engine. The lowering line is marked in intervals of 100 cm with figures from 1 to 10 and in between additionally with line markings each 50 cm for better reading of the depth of visibility while the disk is being lowered.

Windaus-Labortechnik

Lowering line, please order separately.



Description	PK	Cat. No.
Secchi Disk, diam. 250 mm, 4 areas (2 x black, 2 x white)	1	6.267 808
Secchi Disk, diam. 250 mm with eyelet without bottom line	1	7.072 323
Lowering line, 10 m, marked in intervals of 50 cm and 100 cm	1	7.072 324

Flocculation testers

For flocculation tests of water and waste water.

- choice of 2- or 6-bank models
- digital speed display
- two adjustable speed presets
- accurate and reproducible speeds
- diffused base illumination with black background
- accepts beakers up to 1000ml.

Adjustable speed range 25 to 250rpm.

Dimensions (H x W x D): 460 x 320 x 220mm (two-bank model) 460 x 750 x 220mm (six-bank model).

For 230 V 50 Hz, single phase supplies. Supplied with rotor blades but without beakers.

With BioCote silver based antimicrobial protection.

Stuart



9.951 491

Type	Description	PK	Cat. No.
SW5	Flocculation tester, 2-bank	1	9.951 491 1
SW6	Flocculation tester, 6-bank	1	9.951 492

2 Turbidity meter TB 211 IR

The compact infrared turbidity meter TB 211 IR is designed to allow fast, precise on-site testing. The unit measures the scattered light at an angle of 90°, as stipulated in EN ISO 7027. The wide measuring range from 0.01 to 1100 TE/F = NTU = FNU permits use of the unit for various media, ranging from drinking water to waste water. As infrared light is used for measurement, the unit can be used to test both coloured and colourless liquids. The standards required for calibration of the unit are also supplied. A second adjustment mode allows alternative adjustment with user-defined turbidity standards.

- measuring ranges from 0.01 to 1100NTU (autorange)
- measurement with infrared light at an angle of 90°
- easy operation
- 600 tests between battery charges

Scope of supply: Turbidity meter, 4 turbidity standards <0.1, 20, 200 and 800NTU, battery, USB cable (1.5 m), test vial, manual, warranty statement, case

Lovibond®



Specifications:

Measurement cycle:	approx. 9 seconds
Display/Function:	LCD
Optics:	temperature-compensated LED and photosensor amplifier in waterproof sample chamber
Keypad:	4 key polycarbonate membrane
Measuring range:	0.01 to 1100 NTU (autorange)
Resolution:	0.01 to 9.99 NTU = 0.01 NTU 10.0 to 99.9 NTU = 0.1 NTU 100 to 1100 NTU = 1 NTU
Accuracy:	±2.5 % of measuring value or ±0.01 NTU (0 to 500 NTU) ±5 % (500 to 1100 NTU)
Interface:	Micro USB
Housing:	ABS
Dimensions (L x W x H):	190 x 110 x 55 mm
Weight (Basis unit):	approx. 0.4 kg
Temperature:	0 to 40 °C
Humidity (rel.):	30 to 90 % R.H.
CE-conformity:	DIN EN 50081-1, VDE 0839 part 81-1:1993-03, DIN EN 50082-2, VDE 0839 part 82-02:1996-02

Type	PK	Cat. No.
TB 211 IR	1	9.920 203

Sample analysis/Turbidity

1



1 2 Turbidity meter Eutech™ TN-100

Thermo Scientific

The microprocessor-based waterproof Infra-Red Turbidity meter TN-100 is easy-to-use and meets all rigor of rugged field applications. Using an Infrared light source, it delivers laboratory accuracy with a resolution of 0.01 NTU across an extended range of up to 20 NTU (Nephelometric Turbidity Units).

- IP67 Waterproof and Dustproof, easy cleaning and maintenance
- Automatic Push-Button Calibration (4 points) for unprecedented full-range accuracy
- Power-saving feature allows over 1200 measurements
- Large Easy-to-Read Display for optimum viewing of measurements with user-friendly message codes for easy troubleshooting
- Meets Performance Criteria as specified by ISO 7027 (DIN EN 27027) method

Scope of supply: Turbidity meter with 4 calibration standards, 3 empty cuvettes, sturdy carrying case, batteries and instruction manual

2



Specifications

Turbidity range:	0 to 2000 NTU
Resolution:	0.01 NTU (0 to 19.9 NTU) 0.1 NTU (20.0 to 99.9 NTU) 1 NTU (100 to 2000 NTU)
Accuracy:	±2 % of reading ±1 LSD (0 to 500 NTU) ±3 % of reading ±1 LSD (501 to 2000 NTU)
Repeatability:	±1 % of reading or ±0.01 NTU
Calibration Points:	4 points (automatic)
Response Time:	< 6 seconds for full step change
Calibration Standards:	0.02 NTU; 20.0 NTU; 100 NTU; 800 NTU
Light Source:	Infrared-emitting diode (850 nm)
Light Source Life:	> 1.000.000 tests
Power supply:	4 x 1.4 V batteries, > 200 h

Type	PK	Cat. No.
Trübungsmessgerät TN-100	1	6.205 327

3



9.923 604

Turbidity meters Turb® 430

WTW®

The turbidity meters Turb® 430 IR acc. to DIN ISO 27027 and Turb® 430 T acc. to US EPA 180.1 meet the requirements of the nephelometric measurement at 90° stray light for drinking water with highest precision, especially in the range < 1 NTU. The measuring range comprises 0-1100 NTU/FNU with automatic measuring range switching and is therefore suitable for water analysis as well as quality control, such as gasoline, cell cultures, as well as in the food and beverage industries. The measurement and automatic 3-point calibration runs self-explanatory and menu-controlled. The calibration takes place via an AMCO Clear® standard set (0.02-10-1000 NTU). Up to 1000 data sets including sample ID numbers can be stored and later put out GLP-compliant via the PC software LSdata. The quality assurance of the measured results is supported by calibration interval setting with documentation.

Scope of delivery:

Turb® 430 IR/Turb® 430 T: Turbidity meter with calibration set 0.02-10.0-100 NTU

Turb® 430 IR/SET/Turb® 430 T/SET: Turbidity meter in case with table insert, calibration set 0.02-10.0-100 NTU, PC software LSdata, accessories

Specifications

Measuring range:	NTU 0 to 1100 FNU 0 to 1100
Resolution:	0.01 in the range 0.00 to 9.99 0.1 in the range 10 to 99.90 1 in the range 100 to 1100
Accuracy:	±0.01 NTU or ±2 % of measured value
Reproducibility:	0.01 NTU or < 0.5 % of measured value
Cell size:	28 x 60 mm, 20 ml sample volume
Power supply:	4 x AA batteries for approx. 3000 measurements

Type	Description	PK	Cat. No.
Turb® 430 IR	with infra red LED	1	6.223 101
Turb® 430 T	with tungsten lamp	1	7.650 036
Turb® 430 IR/SET	with infrared LED	1	9.923 603
Turb® 430 T/SET	with tungsten lamp	1	9.923 604 3

Turbidity Sensor VisoTurb® 900-P for Meters MultiLine® IDS

Accessories for measuring instruments MultiLine® IDS from WTW® for measuring turbidity parameters. Please order measuring instruments separately.

WTW®

1



6.267 682

Type	Description	PK	Cat. No.
VisoTurb® 900-P	IDS IR turbidity sensor	1	6.267 682 1
Cal-Kit VT900	Kit incl. 1 x 250 ml 124 FNU / 1010 FNU each, zero point calibration bottle	1	7.661 827
SB VT900	Sample bottle, 500 ml	1	7.661 828
AS/IDS-1.5	Cable with plug head, 1.5 m	1	7.642 673

2 Turbidity meter Turb® 355

Battery-operated portable turbidity meter with infrared LED for nephelometric measurements as per ISO 7027/DIN EN 27027 (EN ISO 7027) or as a white light model with tungsten lamp as per US EPA. It is handy, light and simple to operate and is suitable, primarily for applications to monitor > 1 NTU. With smaller samples of 15 ml, it is also very suited for applications in fermenters and cell cultures at good precision.

WTW®

2



Scope of delivery: Turbidity meter in a handy small case with quick instructions, calibration standards 0.02-10.0-1000 NTU, empty cuvettes and batteries.

Specifications

Measuring range: NTU 0 to 1100
FNU 0 to 1100

Resolution: 0.01 NTU in the range 1 to 9.99
0.1 NTU in the range 10.0 to 99.9
1 NTU in the range 100 to 1000

Accuracy: 0 to 500 NTU/FNU: ±0.1 NTU/FNU or ±2 % of measured value
500 to 1100 NTU/FNU: ±3 % of measured value

Reproducibility: 0.05 NTU or ±1% of measured value

Cell size: 25 x 45 mm, 15 ml sample volume

Power supply: 4 x AAA batteries for approx. 1500 measurements

Type	Description	PK	Cat. No.
Turb® 355 IR	with infra red LED	1	6.902 303
Turb® 355	with tungsten lamp	1	6.236 840

3 Turbidity Standards

Highly accurate turbidity standards composed of suspended microspheres, suitable for Instrument calibration and control of all turbidity meters. Stable, shelf life of 2 years (from Date of Manufacturing). NIST traceable, US EPA approved and tested in compliance with ISO 7027. HDPE bottles of 100 ml.

Reagecon

3



Two ranges available:

- Ratio range for Ratio Turbidity Measuring instruments (measure of the scattered light from the sample at a 90° angle from the incident light, plus at additional angles (several detectors))
- Non Ratio for Non Ratio Turbidity Measuring instruments will measure the scattered light from the sample at a 90° angle from the incident light (one detector)

Description	Volume ml	PK	Cat. No.
Non Ratio 0.0 NTU	100	1	6.233 961
Non Ratio 0.1 NTU	100	1	6.075 473
Non Ratio 20 NTU	100	1	6.233 962
Non Ratio 200 NTU	100	1	4.012 096
Non Ratio 800 NTU	100	1	4.012 099
Ratio 0.0 NTU	100	1	4.012 057
Ratio 0.1 NTU	100	1	6.233 012
Ratio 15 NTU	100	1	6.286 185
Ratio 100 NTU	100	1	4.012 076

➡ For the MultiLine® IDS meters please see page 350

Sample analysis/Extraction

1



1 LLG-Extraction thimbles, cellulose

Neutral and fat free. With excellent retention capacity.

Diam. mm	Length mm	PK	Cat. No.
19	90	25	9.045 705
20	80	25	9.045 701
22	80	25	9.045 700
25	100	25	9.045 709
26	60	25	9.045 707
28	80	25	9.045 711
30	80	25	9.045 708
33	80	25	9.045 702
33	94	25	9.045 703
33	100	25	9.045 704
33	118	25	9.045 706
37	130	25	6.256 301
43	123	25	9.045 710

2



2 Cellulose-Extraction thimbles Grade 603

Manufactured in pure cellulose according to DIN 12449.

Whatman

Int. diam. mm	Length mm	Wall thickness mm	PK	Cat. No.
22	80	1.5	25	9.043 901
25	80	1.5	25	9.043 909
25	100	1.5	25	9.043 902
26	60	1.5	25	9.043 910
33	80	1.5	25	9.043 907
33	90	1.5	25	9.043 911
33	94	1.5	25	9.043 903
33	100	1.5	25	9.043 916
33	118	1.5	25	9.043 904
33	130	1.5	25	9.043 917
33	205	1.5	25	9.043 905
35	150	1.5	25	9.043 915
40	85	2.0	25	9.043 918
43	123	2.0	25	9.043 950
44	230	2.0	25	9.043 906

3



3 4 Extraction thimbles, Cellulose

Supplied in packs of 25. Dimensions given are nominal internal diameter x external length in mm.

Whatman

Int. diam. mm	Length mm	Wall thickness mm	PK	Cat. No.
10	50	1.0	25	9.951 335
18	55	1.0	25	9.951 336
19	90	1.0	25	9.951 337
22	80	1.0	25	9.951 338
25	80	1.0	25	9.951 339
25	100	1.0	25	9.951 340
26	60	1.0*	25	9.951 341
28	80	1.0	25	9.951 342
28	100	1.0	25	9.951 343
28	120	1.0	25	9.951 344
30	80	1.0	25	9.951 345
30	100	1.0	25	9.951 346
33	80	1.0	25	9.951 347
33	94	1.0	25	9.951 348
33	100	1.0	25	9.951 349
33	118	1.0	25	9.951 350
37	130	1.0	25	9.951 351
41	123	1.0	25	9.951 352
43	123	1.0	25	9.951 353
60	180	1.0	25	9.951 354
22	80	2.0	25	9.951 355
33	80	2.0	25	9.951 356

*Fits Soxtec™ extractor



1 Extraction thimbles, Borosilicate glass

Recommended for Soxhlet extraction with solvents, which are incompatible with cellulose fibres and for filtration of air and gas streams.

Hahnemühle

- Made of 100 % pure borosilicate fibres, without binding elements
- High loading capacity and highly permeable to air
- Thickness is 1.5 mm (diameter < 33 mm)
- High retention of small particles, > 99 % according to BS 4400
- Good stability at high temperatures up to 500 °C
- Recommended for hot, moist, and acidic gases
- Gravimetric determination of particles in hot gases

1



Further sizes on request.

Ø mm	Length mm	PK	Cat. No.
19	90	25	4.006 162
22	80	25	4.006 163
25	100	25	4.006 164
26	60	25	4.006 165
30	100	25	4.006 166
33	94	25	4.006 167
43	123	25	4.006 168

2 Stands for Extraction Thimbles

behr

Type	Description	PK	Cat. No.
RIP 4	for 4 extraction thimbles	1	9.843 949
RIP 6	for 6 extraction thimbles	1	9.843 950

2



3 Extraction apparatuses acc. to Soxhlet, with Dimroth condenser, DURAN® tubing

Extraction apparatus, Soxhlet-pattern. With Dimroth condenser and round-bottom flask. Made of Duran® tubing.

Lenz

Extractor ml	Condenser NS	Round bottom flasks Capacity ml	PK	Cat. No.
30	29/32	100	1	9.043 001
100	45/40	250	1	9.043 003
150	45/40	250	1	9.043 004
200	45/40	250	1	9.043 008
250	45/40	500	1	9.043 005
300	60/46	500	1	9.043 009
500	60/46	1000	1	9.043 006
1000	71/51	2000	1	9.043 007

3



4 Water estimator to Dean Stark, borosilicate glass 3.3

Manufactured from borosilicate glass 3.3. Suitable for xylol method. System completed with 500 ml (NS 29/32) flask + Liebig condenser with jacket length 400 mm + measuring tube (10:0.1 ml) with PTFE stopcock.

ISOLAB

Description	PK	Cat. No.
Water estimator to Dean Stark	1	9.303 005

4



➔ For complete distillation system please see page 1274.

Sample analysis/Extraction



1 Extractors acc. to Knöfler-Böhm, DURAN® tubing

The condensate passes the extraction sample and flows back into the flask continuously without interrupting the extraction process, i.e. the solvent is recirculated continuously. The complete apparatus consists of:
Jacketed extractor head made of DURAN® tubing, Dimroth condenser with thread GL 14, made of DURAN® tubing, Round bottom flask material: DURAN®

Lenz

Round bottom flasks Capacity ml	Extractor ml	Condenser NS	PK	Cat. No.
100	30	29/32	1	6.237 313
250	150	45/40	1	6.237 312
500	250	45/40	1	9.043 010
1000	500	60/46	1	9.043 020



2 Complete compact extraction systems, with heating

Complete compact extraction systems with stand, heating module, mount, hoses and glassware (round-bottom reaction flask, extractor, Dimroth condenser for extraction).
Infinitely variable heating regulation.

behr

- practical stand for holding the condensers securely between extractions
- extractor sizes from 30 ml to 5000 ml
- the use of extractors with a stopcock eliminates the need for any additional distillation after extraction
- Condensers with screwed-on tubing nipples

Type	Description	PK	Cat. No.
KEX 30	for 30 ml extraction with 100 ml distilling flasks	1	9.843 777
KEX 60	for 60 ml extraction with 250 ml distilling flasks	1	9.843 835
KEX 100	for 100 ml extraction with 250 ml distilling flasks	1	9.843 778
KEX 30 F	for 30 ml extraction with stopcock and 100 ml distilling flasks	1	9.843 836
KEX 60 F	for 60 ml extraction with stopcock and 250 ml distilling flasks	1	9.843 837
KEX 100 F	for 100 ml extraction with stopcock and 250 ml distilling flasks	1	9.843 786
KEX 250 F	for 250 ml extraction with stopcock and 500 ml distilling flasks	1	9.843 779
KEX 500 F	for 500 ml extraction with stopcock and 1000 ml distilling flasks	1	9.843 838
KEX 1000 F	for 1000 ml extraction with stopcock and 2000 ml distilling flasks	1	9.843 839
KEX 2000 F	for 2000 ml extraction with stopcock and 5000 ml distilling flasks	1	6.313 220
KEX 5000 F	for 5000 ml extraction with stopcock and 10000 ml distilling flasks	1	4.675 372



3 Serial Extraction Apparatus behrotest® for Soxhlet-/Fat-Extraction

behrotest® serial heaters are the economical and user-friendly solution for the classic Soxhlet or fat extraction:

behr

- complete with reaction vessels, extraction spacers and coolers
- energy for each sample position is individually adjustable
- cooling water distributor ensures even cooling at all sample positions
- practical stand for holding the condensers securely between extractions
- mounts for holding the extraction spacers after removing the sample vessels
- S models: The extractors with stopcock do away with the need for any additional distillation after extraction

Type	Description	Capacity ml	PK	Cat. No.
R 304	4-position	30	1	9.043 030
R 306	6-position	30	1	9.043 031
R 304 S	4-position, with stop-cock	30	1	9.043 035
R 306 S	6-position, with stop-cock	30	1	9.043 036
R 604	4-position	60	1	9.043 037
R 606	6-position	60	1	9.043 038
R 604 S	4-position, with stop-cock	60	1	9.043 039
R 606 S	6-position, with stop-cock	60	1	9.043 040
R 104 S	4-position, with stop-cock	100	1	9.043 029
R 106 S	6-position, with stop-cock	100	1	9.043 028
R 108 S	8-position, with stop-cock	100	1	9.043 041
R 254 S	4-position, with stop-cock	250	1	9.043 042
R 256 S	6-position, with stop-cock	250	1	9.043 043

1 Single-reflux distillation apparatus

- Complete equipment for reflux distillation, consisting of
- Compact frame with supporting brackets for cooler depositing and cooler holder
 - Standing basin
 - Reaction flask
 - Behr high performance glass cooler
 - Tubing

behr

Type	Description	PK	Cat. No.
KRD 50	1 heating place for 50 ml	1	9.843 970
KRD 100	1 heating place for 100 ml	1	9.843 971
KRD 250	1 heating place for 250 ml	1	9.843 972
KRD 500	1 heating place for 500 ml	1	9.843 973
KRD 1000	1 heating place for 1000 ml	1	9.843 974

1



2 Serial heating unit for reflow distillation

- Complete equipment for reflux distillation, consisting of
- Hot bench, 4 or 6 heating positions
 - Standing basin
 - Stand rods
 - Cooling water distribution with condenser rack and cooler stand
 - Reaction flask
 - Behr high performance glass coolers

behr

Type	Description	PK	Cat. No.
RH 104	4 heating places for 100 ml round flasks	1	9.843 963
RH 106	6 heating places for 100 ml round flasks	1	9.843 964
RH 254	4 heating places for 250 ml round flasks	1	9.843 965
RH 256	6 heating places for 250 ml round flasks	1	9.843 966
RH 504	4 heating places for 500 ml round flasks	1	9.843 967
RH 506	6 heating places for 500 ml round flasks	1	9.843 968

2



3 Complete Compact Extraction System

- Compact Extraction System in accordance with Twisselmann.
Complete compact extraction system with stand, heating module, mount, hoses and glassware (round-bottom reaction flask, extractor, Dimroth condenser for extraction).

behr

Type	Description	PK	Cat. No.
KEX 100 T	Compact system for Twisselmann extraction	1	9.843 824

3



4 behrotest® Multi-sample Extractors for Twisselmann Extraction

- Economical and user-friendly units for extraction in accordance with Twisselmann

behr

- each sample position is individually adjustable
- cooling water distributor ensures an even cooling at all sample positions
- practical stand for holding the condensers securely between the extractions
- mounts for holding the spacers after the removal of the sample containers

4



Type	Description	PK	Cat. No.
R 104 T	complete for 4 positions at the same time with plunger, 250 ml	1	9.843 825
R 106 T	complete for 6 positions at the same time with plunger, 250 ml	1	9.843 826
R 104 T-FB	complete for 4 positions at the same time with plunger, 250 ml, FB execution (larger heating surface)	1	6.314 459
R 106 T-FB	complete for 6 positions at the same time with plunger, 250 ml, FB execution (larger heating surface)	1	4.675 378
R 108 T-FB	complete for 8 positions at the same time with plunger, 250 ml, FB execution (larger heating surface)	1	4.675 384

Sample analysis/Extraction

1

1 behrotest® WD 30 Cooling Monitor

With emergency shut-off function for power and water intake

behr

- The behrotest® WD 30 is a user-friendly device for monitoring cooling circuits in the laboratory.
- In case of a system leakage the WD 30 shuts off the water intake as well as the electrical heating device and thus prevents damages in the laboratory caused by water.
- The behrotest® WD 30 is position-independent, i.e. it can be run anywhere in the lab in any position.
- An audible warning signal provides additional safety.

Included in delivery of the behrotest® WD 30 coolant monitor are:

- Monitor unit with two flow sensors and solenoid valve, incl. cable connection for the controller (1.5 m)
- Controller with isolated ground receptacle for the connection of heating devices, etc.
- Hose kit with connections
- Adapter kit for the connection to the water supply and the behrotest® UK circulation cooling unit.

Power supply	230 VAC, 50/60 Hz
System pressure	0.2 ... 10 bar
Flow rate	5 ... 30 l/min.

Description	PK	Cat. No.
behrotest® WD 30 Coolant Monitor	1	6.286 375

2

2 behrotest® CF 2+2 and CF 6, Semi-automatic Crude Fibre Extraction

They are ideally suited for:

behr

- total crude fibre determination (part of the Weender animal feed analysis as performed in Europe)
 - neutral detergent fibre and acid detergent fibre determination (NDF and ADF according to Van Soest)
 - acid detergent lignin determination (ADL according to Van Soest)
 - different fractions of fibre (cellulose, hemicellulose and pectin) behrotest® semi-automatic crude fibre extraction units simplify everyday life in the lab:
 - Easy operation
 - The analyst is guided through the procedure by messages on the display.
- behr ABP ("acknowledge before proceeding") method for optimum analytical safety.
Possible manual operation of air and suction pumps.

Type	Description	Dimensions (W x D x H) mm	Weight kg	PK	Cat. No.
CF2+2	with 4 sample places	590 x 560 x 670	43	1	6.286 380
CF6	with 6 sample places	750 x 560 x 670	51	1	6.286 381

3

3 Extraction Unit for the Randall Method

Manual apparatus for hot extraction according to Randall. Several times faster than a customary Soxhlet extraction. Incl. 1 set of extraction thimbles, 100 ml.

behr

- Optimal safety thanks to screw-fastened extraction units

Multiple position extraction units:

- Every extraction thimble with sample can be independently adjusted
- The user can lower and raise all the extraction units into/out of the heating chamber with a single lever
- Every heating position has a separate temperature control

Specifications

Dimensions (H x W x D, cm):	approx. 81 x 55 x 63
Weight, kg:	approx. 32
Voltage:	230 V 50 Hz a.c.
Power consumption:	Max. 1500 W

Type	Description	PK	Cat. No.
E1	One sample position	1	9.843 923
E4	Four individually adjustable sample positions	1	9.843 922
E6	Six individually adjustable sample positions	1	9.843 924
EX 75 HS	Extraction thimbles for the EB 75 reaction flask	25	9.843 926
EB 75	Reaction flask	1	9.843 927

Exhaust Device, borosilicate

- Filter mountings, 400 ml, with thread
- PP funnels with thread
- Slotted sieve plate with 2 gaskets
- Stainless steel rack
- Water jet pump

behr



9.843.844

Type	Description	PK	Cat. No.
FU 4	Filtration unit, 4 places	1	9.843 844 1
FU 6	Filtration unit, 6 places	1	9.843 845

InKjel M manually adjustable infrared digestion system

Rapid digestion system with manually adjustable energy control and direct heating of the samples through high-quality quartz radiators (1500 W).

- Quartz infra-red radiators peak at 830 °C within 1 min.
 - Particularly uniform heating at all sample positions
- All InKjel systems are fitted completely with multi-level consoles, fume extraction unit, sample rack and glass digestion vessels.

Configurations available:

- 6 sample vessels each 250 ml
- 12 sample vessels each 100 ml
- 12 sample vessels each 250 ml
- 4 sample vessels each 500 ml
- 4 sample vessels each 750 ml

behr



9.843 770

Type	For	PK	Cat. No.
InKjel 1210 M	12 sample vessels each 100 ml	1	9.843 757
InKjel 625 M	6 sample vessels each 250 ml	1	9.843 770 2
InKjel 1225 M	12 sample vessels each 250 ml	1	9.843 771
InKjel 450 M	4 sample vessels each 500 ml	1	9.843 768
InKjel 475 M	4 sample vessels each 750 ml	1	9.843 769

Infrared rapid digestion system with temperature control

The temperature-controlled InKjel TC-series devices combine the advantages of infrared and block digestion in one system: Fast Infrared digestion at defined temperatures ensures high sample throughput.

In the programmable version InKjel TCP, the user has a choice of 25 freely configurable programs for temperature and digestion time.

The high-quality quartz infrared heaters of InKjel TC reach 830 °C in a minute and achieve uniform heating at all sample positions.

behr



9.843 706

Type	For	PK	Cat. No.
InKjel 625 TCM	6 sample vessels each 250 ml	1	9.843 706 3
InKjel 1210 TCM	12 sample vessels each 100 ml	1	9.843 707
InKjel 1225 TCM	12 sample vessels each 250 ml	1	9.843 708
InKjel450 TCM	4 sample vessels each 500 ml	1	9.843 709
InKjel 475 TCM	4 sample vessels each 750 ml	1	9.843 710

➔ Extraction apparatus, Soxhlet - please see page 1267.

Sample analysis/Kjeldahl

1



6.233 440

InKjel P infrared digestion system with 10 freely configurable programmes

Rapid digestion system with 25 freely configurable programmes for power and digestion time and direct heating of the samples through high-quality quartz radiators (1500W).

- Quartz infra-red radiators peak at 830 °C within 1 min.
- Particularly uniform heating at all sample positions

behr

All InKjel systems are fitted completely with multi-level consoles, fume extraction unit, sample rack and glass digestion vessels.

Configurations available:

- 6 sample vessels each 250 ml
- 12 sample vessels each 100 ml
- 12 sample vessels each 250 ml
- 4 sample vessels each 500 ml
- 4 sample vessels each 750 ml

Type	For	PK	Cat. No.
InKjel 1210 P	12 sample vessels each 100 ml	1	9.843 756
InKjel 625 P	6 sample vessels each 250 ml	1	9.843 760
InKjel 1225 P	12 sample vessels each 250 ml	1	6.233 440 1
InKjel 450 P	4 sample vessels each 500 ml	1	9.843 758
InKjel 475 P	4 sample vessels each 750 ml	1	9.843 759

2



2 Standard Kjeldahl block digestion systems K 8, K 12 and K 20

Block digestion systems with high-quality corrosion-resistant block housing made of stainless steel. With 8, 12 or 20 sample slots for standard Kjeldahl digestion vessels with a volume of 250 ml. High-efficiency heating and extraction hood with exhaust collector.

behr

- behr single-knob control for particularly easy and fast programming.
 - Menu navigation in national language.
 - 25 freely configurable programs for block temperature and digestion time.
 - Applications can be saved.
 - USB interface.
 - The removable inspection door on the insertion rack enables the progress of the digestion to be observed.
- Complete systems with digestion vessels, rack and extraction hood.

Type	Description	PK	Cat. No.
K 8	with 8 sample slots, for digestion vessels with a volume of 250 ml	1	9.843 900
K 12	with 12 sample slots, for digestion vessels with a volume of 250 ml	1	9.843 901
K 20	with 20 sample slots, for digestion vessels with a volume of 250 ml	1	9.843 902

3



3 Micro Kjeldahl block digestion systems K 6, K 24 and K 40

Block digestion systems with high-quality corrosion-resistant block housing made of stainless steel. With 16, 24 or 40 sample slots for micro Kjeldahl digestion vessels with a volume of 100 ml. High-efficiency heating and extraction hood with exhaust collector.

behr

- behr single-knob control for particularly easy and fast programming.
 - Menu navigation in national language.
 - 25 freely configurable programs for block temperature and digestion time.
 - Applications can be saved.
 - USB interface.
 - The removable inspection door on the insertion rack enables the progress of the digestion to be observed.
- Complete systems with digestion vessels, rack and extraction hood.

Type	Description	PK	Cat. No.
K 16	with 16 sample slots, for digestion vessels with a volume of 100 ml	1	9.843 903
K 24	with 24 sample slots, for digestion vessels with a volume of 100 ml	1	9.843 904
K 40	with 40 sample slots, for digestion vessels with a volume of 100 ml	1	9.843 905

Accessories for Kjeldahl rapid sample digestors

behrotest® standard digestion vessels have standard dimensions. That means they fit into digestion and distillation units of most brands. Of course, it also means that standard digestion vessels of most brands can be used with behr distillation units.

behr

**Danger**

H phrases: H411

Type	Description	PK	Cat. No.
SR 3i	Sample vessel, 250 ml, for InKjel*	1	9.843 766 1
SR 4	Sample vessel 100 ml, for InKjel*	1	9.843 750
SR 5	Sample vessel 500 ml, for K8 B*	1	9.843 751
KJ 500	Sample vessel, 500 ml, for InKjel*	1	9.843 775
KJ 750	Sample vessel, 750 ml, for InKjel*	1	9.843 776
KT 1	Catalyst tablets (5.0 g K ₂ SO ₄ ; 0.5 g CuSO ₄)	1000	9.843 767
KT 2	Catalyst tablets (5.0 g K ₂ SO ₄ ; 0.15 g CuSO ₄ ; 0.15 g TiO ₂)	1000	9.843 773
KT 3	Catalyst tablets (3.5 g K ₂ SO ₄ ; 0.4 g CuSO ₄)	1000	9.843 752
KT 4	Catalyst tablets (3.5 g K ₂ SO ₄ ; 3.5 g Se)	1000	9.843 969
AFS	Antifoam tablets	1000	9.843 753
SIST 100	Boiling stones, contents 100 g	1	9.920 710
WP	Nitrogen-free weighing boats	1	9.843 754

1



2 behrosog 3 Scrubber

- Infinitely variable throughput
- Transparent protective shield for safe operation of the unit
- Exterior manual control elements with easy access prevent the analyst from touching hot glass parts
- Acid resistant diaphragm pump

behr

Type	Description	PK	Cat. No.
behrosog 3	Scrubber with suction pump (40 l/min), cooling stage, neutralisation stage and drip catcher	1	9.920 584
ACS	Additional cooling for behrosog 3	1	9.920 585

2



Steam Distillation Unit S

- Exemplary safety and reliability
- Robust casing of polyurethane
- Distillation time approx.. 3 mins. per sample
- Detection limit 0.1 mg N
- Recovery rate >99.5 %
- Reproducibility ±1 %
- Steam generating capacity adjustable from 10 % - 100 %
- Extremely simple, menu-controlled operation of the programmable units via one single operating element (behr one-button operation)
- Programmable reaction time
- Serial interface (RS232)
- Filling level monitoring for can set
- Practical quick clamping device equally suited for the "left-handed" analyst

behr

3



9.843 815

Type	Description	PK	Cat. No.
S 1	Steam distillation unit, partly automated with automatic addition of NaOH	1	9.843 814
S 2	Steam distillation unit, partly automated with automatic addition of NaOH and H ₂ O	1	9.843 813
KAS 20	Can set for S 1 and S 2	1	6.236 005
S 3	Steam distillation unit, partly automated, like S2 with automatic extraction of the sample residues and with 10 programs	1	9.843 815 3
KAS 30	Set of 3 canisters (20 l each) for S 3, incl. float switch	1	9.843 816
S 4	Steam distillation unit, fully automatic, like S 3 with automatic extraction H ₂ BO ₃ of the sample residues and with 99 programs	1	9.843 817
S 5	Steam distillation with automatic addition of NaOH, H ₂ O and H ₂ BO ₃ with automatic extraction of the sample residues, with 99 programs and a connection option for external titrator	1	9.843 803
KAS 40	Set of 4 x 20 l containers for S 4, incl. float switch	1	9.843 818
TB 2	Titration module for connection with S 5	1	6.270 443

Sample analysis/Kjeldahl-Special distillation

1

1 Steam distillation unit D1 and D2

- Alcohol
- Volatile acid contents
- Fermentation process (beer, etc.)
- Ammonium chloride in liquorice products

behr

Distillation units for determining alcohol and volatile acid content in wine and other alcoholic drinks. Complete glassware, with volumetric flasks and pycnometer. Because of its rapidity, the behr D 1 and D 2 are especially suitable for high sample throughputs.

Type	Description	PK	Cat. No.
D1	for determining alcohol content, distillation into a pycnometer	1	9.843 830
D2	for determining Volatile acid content, distillation into an erlenmeyer flask 500 ml	1	9.843 831

2

2 Compact systems for sulphur dioxide determination, KSO/SO

For determination of sulphur dioxide (total SO₂), 2 absorption units per sample.

behr

With base unit, heating mantle, mounting frame and glassware, including 500 ml reaction flasks.

Systems with adsorption units or other flask sizes on request.

Type	Description	PK	Cat. No.
KSO 2 N	Complete compact sytem	1	9.920 546
SO 2-6	Sytem for 6 working units	1	9.920 547

3

3 Compact system for determination of water content

Compact system for determination of water content by azeotropic distillation.

behr

Suitable for non-homogeneous and irregularly shaped food such as dried fruit and vegetables, Sauerkraut etc. With base stand, heating mantle, mounting frame and glassware.

Type	PK	Cat. No.
KWA 500	1	9.920 548
KWA 500/4 for 4 samples	1	9.920 537
KWA 500/6 for 6 samples	1	9.920 538

1 Milk Butyrometer Original Gerber

With frosted label on bulb, plain neck, without stopper, for milk quantities of 10.73-11 ml.

Gerber

Fat	Graduation	Acc. to	Accessories	PK	Cat. No.
%					
0 - 4	0,05	ISO	Code A, B, E, F	1	9.112 565
0 - 5	0,1	ISO	Code A, B, E, F	1	6.073 298
0 - 6	0,1	ISO	Code A, B, E, F	1	9.112 588
0 - 7	0,1	ISO	Code A, B, E, F	1	6.803 740
0 - 8	0,1	ISO	Code A, B, E, F	1	6.224 904
0 - 9	0,1	ISO	Code A, B, E, F	1	6.226 307



2 Cream Butyrometer Koehler Gerber Standard

Volumetric method for 5 ml cream, with frosted label on bulb, ring neck, without stopper.

Gerber

Fat	Graduation	Accessories	PK	Cat. No.
%				
0 - 40	0.5 (± 0.25)	Code E, F	1	9.112 567
0 - 50	0.5 (± 0.25)	Code E, F	1	6.224 905
0 - 60	1.0 (± 0.5)	Code E, F	1	6.264 746
0 - 70	1.0 (± 0.5)	Code E, F	1	9.112 568



3 Cream Butyrometer Roeder with accessories

Gravimetric method for 5 g cream, with 2 openings, frosted label on bulb, complete with rubber stoppers and glass beaker without hole.

Gerber

Fat	Graduation	PK	Cat. No.
%			
0 - 5 - 40	0.5 (±0.25), Norm: DIN	1	6.243 591
0 - 30 - 55	0.5 (±0.25), Norm: DIN	1	6.243 590
0 - 50 - 75	0.5 (±0.25), Norm: DIN	1	6.237 816



4 Cheese Butyrometer Van Gulik with accessories

Weighing method for 3 g cheese, with two openings, frosted label on bulb, complete with rubber stoppers and glass beaker with 16 holes.

Gerber

Fat	Graduation	PK	Cat. No.
%			
0 - 5 - 40	0.5	1	6.203 256
0 - 40	0.5; Norm: ISO	1	9.112 572



5 Dry Milk Butyrometer Teichert with Accessories

Weighing method for 2.5 g dry milk, closed bulb with frosted label, with rubber stopper and glass nail.

Gerber

Fat	Graduation	PK	Cat. No.
%			
0 - 35	0.5 (±0.25)	1	9.112 569
0 - 70	1.0 (±0.5)	1	6.203 600



6 Stoppers, EPDM, for butyrometers

Made of ethylene propylene diene monomer rubber.

Deutsch & Neumann

Bottom diam.	Top diam.	Height	PK	Cat. No.
mm	mm	mm		
11	16	43	1	6.401 031



7 Pipettes for the Gerber method

Gerber

Description	PK	Cat. No.
Milk pipette 11.00 ml	1	9.112 589
Milk pipette 10.75 ml acc. to DIN	1	9.112 603
Cream pipette 5 ml, 20 °C	1	9.112 609
Sulfuric Acid pipette 10 ml with 2 bulbs	1	9.112 607
Amyl alcohol pipette 1 ml with 1 bulb	1	9.112 604



Sample analysis/Milk analysis

1

9.112 575

2

6.262 314

Accessories for Butyrometers

Gerber

Description	Accessories	PK	Cat. No.
GERBAL-M stopper with bush, length 23.5 mm	Code A	1	9.112 573
Regulating pin for GERBAL-M stopper, nickel plated brass	Code B	1	9.112 574
Double conical rubber stopper, 36x12/14 mm for milk-, skim milk- and Koehler-Cream-Butyrometer	Code E	1	6.224 906
Single conical rubber stopper 35x11/16 mm, acid-proof for milk, skim milk and Koehler-Cream-Butyrometer	Code F	1	6.202 638
Single conical rubber stopper, small, 15x10.5/13 mm for butyrometers with two openings		1	9.112 576
Single conical rubber stopper, large, 30 x 17.5/22 mm, with hole for beaker, for butyrometers with two openings		1	9.112 575 1
Single conical rubber stopper, large, 30 x 17.5/22 mm, without hole, for butyrometers with two openings		1	6.202 636
Glass beaker without holes for Cream Butyrometers		1	9.112 577
Glass beaker with two holes for butter butyrometers		1	6.262 314 2
Glass Beaker with 16 holes for Cheese Butyrometers		1	9.112 578
Glassnail for powder milk butyrometer		1	6.234 037

3

3 Extraction tubes Mojonnier, Borosilicate glass 3.3

Gerber

Description	PK	Cat. No.
Type Gerber, round bulb, with spout, incl. cork stopper Cat. No. 6.264 751	1	9.112 612
Type Gerber, round bulb, without spout, incl. glass stopper NS 19 Art.-Nr. 9.230 007	1	6.073 104
Type NEST, flat bulb, with spout, incl. cork stopper Cat. No. 6.264 751	1	9.112 613

4 Accessories for Extraction tubes Mojonnier

Gerber

Description	PK	Cat. No.
Cork stopper, diam. 14/17x27 mm for Cat. No. 9.112 612	1	6.256 027
Cork stopper, diam. 15/18x27 mm for Cat. No. 9.112 613	1	6.264 751
Rack for 8 Mojonnier flasks, PP	1	6.253 377

4

1 Centrifuge Micro III

Small centrifuge for the determination of fat in milk and dairy products acc. to Gerber or Babcock.

Gerber

- Microprocessor control with actual display in minutes and seconds, adjustable from 1 to 99 minutes
- Heating with 2 segment advertisements, adjustable from 0 to 65 °C
- Increased precision thanks to the controlled speed
- Unbalance switch-off in case of uneven filling or sudden glass breakage
- Incl. Rotor (aluminium) and bushing (brass)

Specifications

Speed (fixed): 1280 rpm
 Dimensions (W x D x H): 450 x 530 x 290 mm
 Weight (with rotor and sleeves): up to 34 kg
 Power supply: 115-230 VAC, 50/60 Hz

Type	PK	Cat. No.
Centrifuge Micro III with Gerber-Rotor and 8 butyrometer sleeves	1	6.286 207
Centrifuge Micro III with Gerber-Rotor and 12 butyrometer sleeves	1	6.286 208



Universal Gerber Centrifuge

Multipurpose centrifuge for the dairy laboratory.

- Timer 0 to 255 minutes
- Automatic brake
- Heating (option) with variable temperature setting up to 65 °C (1200 W)
- Microprocessor control with an LED display to show speed, run time, temperature and error messages
- Cover lock
- Unbalance cut-off
- Emergency release

3 pre-programmed speeds for:

- Gerber Butyrometers (350 x g)
- Solubility in milk powder (164 x g)
- Extraction tubes Roese-Gottlieb/Mojonnier (80 x g)
- 1 variable speed range (200 to 1100 rpm), on request

Specifications

Dimensions (W x D x H): 640 x 640 x 450 mm
 Power supply: 230 VAC, 50 Hz

Description	PK	Cat. No.
Centrifuge without heating, with universal rotor for 12 positions, without inserts*	1	6.254 782 2
Centrifuge without heating, with special-rotor incl. 36 sleeves	1	6.264 744
Centrifuge with heating and with universal rotor for 12 positions, without inserts*	1	9.112 595
Centrifuge with heating and special rotor incl. 36 sleeves	1	6.264 745

*Inserts, please order separately



6.254 782

3 Cryoscope standards

Compatible for use on all Cryoscopes compliant to International Reference Standard ISO5764/IDF108 for the determination of Freezing Point in milk. High accuracy, 1 year shelf-life (from Date of Manufacturing). Supplied in 250 and 100ml HDPE bottle and a convenient cap with collapsible filling nozzle

Reagecon

Type	Measuring range	Capacity ml	PK	Cat. No.
MTR01025	0.000 °C	250	1	4.012 189
MTR02025	-0.408 °C, 422 m°H	250	1	4.012 190
MTR020X	-0.408 °C, 422 m°H	100	1	6.286 186
MTR03025	-0.512 °C, 530 m°H	250	1	4.012 191
MTR030X	-0,512 °C, 530 m°H	100	1	6.286 187
MTR03525	-0.557 °C, 577 m°H	250	1	4.012 192
MTR04025	-0.600 °C, 621 m°H	250	1	4.012 193
MTR040x	-0.600 °C, 621 m°H	100	1	6.286 188



➔ For more centrifuges, please see page 664.

Type classes for Pure and Ultrapure Water Systems

Type I: Ultrapure Water for analytical applications such as cell culture, tissue culture and HPLC (high-performance liquid chromatography) as well as for molecular biology techniques.

Type II: Pure Water for buffers and pH repairs, as well as for applications in histology, general reagent preparation and chemistry.

Type III: Water from reverse osmosis, for rinsing water baths, autoclaves, hydroponics and glassware and as feed water for Type I Ultrapure Water Systems.

1

1 Distilled water

Deionized and UV irradiated. Acc to DIN 43530/EN 385. In plastic canister.

Specifications

pH value:	<7.0
Conductivity:	<5 µS/cm
Hardness:	<0.02 mmol/l
Chlorine content:	<2 mg/l

Capacity L	PK	Cat. No.
10.0	1	6.273 852
20.0	1	6.280 900
60.0	1	6.289 280

Deioniser, behropur®

behropur® mixed-bed ion exchangers deliver de-ionized water according to Grade 3 of the ISO 3696 standard, -Water for analytical laboratory use; Specification and test methods.

The resins inside the behropur® ion exchangers are of certified quality.

The completely equal distribution of water inside the ion exchanger leads to the maximum utilization of the exchange capacity of the unit. Thus the user benefits from very low conductance water throughout the life cycle of each exchanger charge.

2

2 Deioniser, behropur®

Heavy-walled, robust and practical mixed bed deioniser in blue polyethylene with free flow output to the reservoir. Also ideal for the post desalination of reverse osmosis systems or for aquariums.

behr

- Can be directly connected to the water supply and is immediately ready for operation.
- Automatic venting as water is supplied from below.
- Minimal risk of contamination due to slotted filter in the raw water inlet.
- Nozzles are durable and easy to clean. Highly resistant to abrasion or shocks.
- Extremely sturdy, heavy-duty nozzle welding by the manufacturer's own welding process.
- Resistivity meter fitted.
- B5 and B10 can also be used as wall mounted devices (wall mounting included).
- Also available with water quality cut-out and solenoid valve which engages if specified limits are exceeded and reservoir level control.
- Resistivity control available directly on the unit or remotely at any location.

Output data:

Cation exchange capacity*at 10°dH:	B5/B10 500 L/1000 L
Flow max.:	50/100 L/hr.
Dia.:	16/21 cm
Height:	53/63 cm

Type	Description	PK	Cat. No.
B5	unpressurised, complete with resistivity meter	1	9.882 114
B10	unpressurised, complete with resistivity meter	1	9.882 115
B5Z	dual cartridge for unpressurised	1	9.882 116
B10Z	dual cartridge for unpressurised	1	9.882 117
B5A	unpressurised, resistivity meter with water quality cut-out and solenoid valve	1	9.882 118
B10A	unpressurised, resistivity meter with water quality cut-out and solenoid valve	1	9.882 119

* Limiting value 20 µS

12. Environmental-, soil-, water-, food analysis

Water purification/Pure and ultra-pure water

1 Deionisers, pressure-resistant, behropur®

Compact and secure mixed bed deionisers for small to medium-sized volumes of ultra pure water. Ideal for feeding laboratory washing machines, general requirements in the laboratory, low level consumption in industry and for post-treatment desalination of the output from reverse osmosis systems.

- Optimal utilisation of the deioniser due to totally uniform water distribution in the resin chamber.
- Can be connected directly to the raw water mains without a pressure reducer.
- Back pressure resistant.
- Also available with water quality cut-out and solenoid valve, which engages if specified limits are exceeded, and reservoir level control.
- Resistivity control available directly on the unit or remotely at any location.

Performance data:	B10dN/B22dN/B45dN
Cation exchange capacity at 10°dH:	1200 L/2400 L/5500 L
Flow max.:	300/500/800 L/hr
Dia.:	21/21/26 cm
Height incl. LF:	68/112/125 cm
Height, cartridge only:	55/98/110 cm



Type	Description	PK	Cat. No.
B10dN	Pressure-resistant mixed bed unit, with resistivity meter	1	9.882 120
B10dNZ	behropur water de-ioniser cartridge, nylon, pressure resistant for 9.882 120	1	9.882 123
B10dNA	Pressure-resistant mixed bed unit, with resistivity meter	1	9.882 126
B22dN	Pressure-resistant mixed bed unit, with resistivity meter	1	9.882 121
B22dNZ	behropur water de-ioniser cartridge, nylon, pressure resistant for 9.882 121	1	9.882 124
B22dNA	Pressure-resistant mixed bed unit stivity, meter with water quality cut-out	1	9.882 127
B45dN	Pressure-resistant mixed bed unit, with resistivity meter	1	9.882 122
B45dNZ	behropur water de-ioniser cartridge, nylon, pressure resistant for 9.882 122	1	9.882 125
B45dNA	Pressure-resistant mixed bed unit, meter with water quality cut-out	1	9.882 128
	Quick release coupling for water deionizers pressure resistant	1	4.675 377 2

* Limit value 20 µS/cm

3 Mixed-bed ion exchanger made of stainless steel

Standard cartridge made of V4A stainless steel for general purpose application: To supply laboratory glassware washers, for general laboratory maintenance and for small industrial consumers. For subsequent demineralization of reverse osmosis systems.

- pressure resistant to 10 bar /8 bar at E40dA
- optimum exploitation of the ion exchanger capacity due to absolute uniform water distribution in the unit
- flow rates up to 700 litres/hour
- the unique behropur® jet nozzle system distributes the raw water over the entire resin bed. This ensures an optimum exchange capacity and quality
- can be connected to the raw water network directly and without a pressure reducer
- resistant to alternating pressure
- hard rubber collars vulcanized to the base and top of the unit offer effective protection
- convenient transport thanks to the handles embedded into the top part of the unit
- conductivity is controlled directly on the unit (installed measuring equipment) or with remote location meter
- Also available with shut-off when the limit value is reached and limit control

Specifications	E 28/E 40 d
Exchange capacity*at 10°dH	2800 litres/4000 litres
Flow max. litres/hour	500/700
Diameter in cm	24/24
Height incl. LF in cm	74/84
Height of cartridge only in cm	60/70



Type	Material	Description	PK	Cat. No.
E28d	Stainless steel V 4A	complete with conductivity meter	1	9.915 730
E40d	Stainless steel V 4A	complete with conductivity meter	1	9.915 731
E28dZ	Stainless steel V 4A	spare cartridge	1	9.915 732
E40dZ	Stainless steel V 4A	spare cartridge	1	9.915 733
E28dA	Stainless steel V 4A	conductivity meter with limit switch and electrovalve	1	9.915 734
E40dA	Nylon	conductivity meter with limit switch and electrovalve	1	9.915 735

* Limit value 20 µS/cm

1

1 Ion exchangers DS 450/DS 750, PE

The non-pressurised cartridges, which are suitable for a daily requirement up to 15 litres, are simply replaced after a prolonged period of service. A filter system prevents any resin from escaping.

Stakpure GmbH

Scope of delivery DS 450: incl. analogue conductivity meter, set of hoses and wall mount.

Scope of delivery DS 750: incl. analogue conductivity meter and set of hoses.

Specifications:

Pure water quality: 0.1 ... 20 µS/cm
 Max. water temperature: 30 °C
 Connection: R ¾"
 Power supply: 230 V/50 ... 60 Hz

Type	Description	Capacity*	Flow rate L / h	Weight kg	PK	Cat. No.
DS 450	with non-reusable cartridge	425 l	50	3	1	6.274 373
DS 750	with reusable cartridge	750 l	100	6	1	6.310 979

* At 10° total dissolved solids

2

4.665 496

Replacement cartridges for ion exchanger DS 450/DS 750, PE

Stakpure GmbH

Type	Description	PK	Cat. No.
Exchange cartridges DS 450 (Set of 2)	Also suitable for TKA / Thermo DI 425	2	4.665 496 2
Replacement cartridge DS 750	Also suitable for TKA / Thermo DI 750	1	6.310 981

3

3 Ion exchangers series DS, stainless steel AISI 316

Pressure resistant stainless steel cartridge, specifically for laboratory applications, with a particularly high capacity and flow rates of up to 1000 litres an hour. The flow system ensures a fast and effective flow through the mixed-bed system with ion-exchange resins.

Stakpure GmbH

Specifications:

Max. pressure: 10 bar
 Pure water quality: 0.1 ... 20 µS/cm
 Max. water temperature: 30 °C
 Connection: R ¾"

Type	Capacity*	Flow rate L / h	Diam. mm	Height mm	Weight kg	PK	Cat. No.
DS 1500**	1500 l	300	240	410	14	1	6.310 985
DS 2000**	2000 l	300	240	490	18	1	6.291 565
DS 2800**	2800 l	950	240	579	24	1	6.310 986
DS 4000**	4000 l	1000	240	700	27	1	6.310 987
DS 6000**	6000 l	1000	240	1155	45	1	6.310 988

* At 10° total dissolved solids

**Hard rubber carrying handles

Accessories for ion exchangers

Stakpure GmbH

Description	PK	Cat. No.
Converting set to quick release nipple for cartridge - R ¾"	1	4.668 478
Converting set to quick release coupling for meter - hose R ¾"	1	4.668 477

4

6.291 567

Analogue conductivity meters AC 100/AW 100/AE 100

Analog conductivity meter for easy and reliable conductivity measurement of pure water. Analogue display of measurement value in µS/cm.

Stakpure GmbH

Scope of delivery: Measuring cell and set of two 1.5 m hoses.

Specifications:

Measuring range: 0.1 ... 50 µS/cm
 Connection: R ¾"
 Power supply: 230 V/50 ... 60 Hz

Type	Description	Dimensions (W x D x H) mm	PK	Cat. No.
AC 100	For cartridge installation	93 x 123 x 170	1	6.291 567 4
AW 100	For wall installation	93 x 125 x 96	1	6.310 992
AE 100	For front panel mounting	60 x 43 x 46	1	6.310 993

12. Environmental-, soil-, water-, food analysis

Water purification/Pure and ultra-pure water

Digital conductivity meters DC 400

For online measurement of pure and ultrapure water downstream of ionexchange cartridges and for monitoring ring-main systems.

Stakpure GmbH

- Large, 2-colour, back-lit graphic digital display
- Direct connection of peripheral equipment at potential-free contact (optionally)
- Wall mounting

Scope of delivery: DC 400, connecting cable, plug-type power supply unit, set of two 1.5 m hoses and measuring cell.

Specifications:

Conductivity measuring range:	0.1 ... 300 µS/cm
Temperature measuring range:	0.1 ... 50 °C
Conductivity limiting value setting:	0.1 ... 30 µS/cm, infinitely variable
Temperature limiting value setting:	1 ... 50 °C infinitely variable
Signal when limiting value is exceeded:	red/green LED indicator + buzzer (both can be deactivated)
Connector:	R 3/4"
Interface:	potential-free contact (optionally)
Dimensions (W x D x H):	73 x 32 x 141 mm
Power supply:	110/230 V, 50 ... 60 Hz

1



6.291 566

Type	Description	PK	Cat. No.
DC 400	Standard	1	6.291 566 1
DC 400	With potential-free contact	1	6.310 994
DC 400	With potential-free contact and solenoid valve	1	6.310 995

Accessories for digital conductivity meters DC 400

Stakpure GmbH

Description	PK	Cat. No.
Leakage sensor for DC 400 (14180600 + 14180700)	1	6.310 996

Filter for behropur® mixed-bed ion exchanger

Filter for pressure-resistant behropur® mixed-bed ion exchangers. Transparent casing.

behr

Once added to the ion exchanger, it completely retains even the finest particles and protects your high-quality equipment. Due to the transparent casing of the FG 130, you can see the state of the filter insert at any time and at a glance. Depending on the requirements, you can use a universal filter (5µ) or a carbon filter (20µ). Downstream filters may only be used on pressure-resistant behropur® ion exchangers. Pressure-free exchangers are destroyed by the counter pressure. It could also subsequently result in expensive damage.

FG 130 behropur® filter housing for filter inserts with a length of 5". Transparent casing made of PP.

Connections 3/4", maximum operating pressure 8bar, max. temp. 50°C

FE 130 behropur® filter insert, PP, 5µ, length 5", max. pressure 6bar, max. temp. 80°C

AF 130 behropur® filter insert, carbon, 20µ, length 5", max. pressure 6bar, max. temp. 50°C

Type	PK	Cat. No.
FG 130	1	9.915 736 2
FE 130	1	9.915 737
AF 130	1	9.915 738

2



9.915 736

3 Spare cartridge deionisers, stainless steel (V4A)

High quality stainless steel ion exchanger (V4A) pressure resistant up to 10 bar.

evoqua

High quality and longevity, parts in stainless steel in contact with medium.

Optimized water distribution.

Without conductivity meter. Please order separately.

For	Output	Diam.	Height	Weight	PK	Cat. No.
	L / hr.					
SG 2000 SK	450	230	410	16	1	9.914 442
SG 2800 SK	800	230	570	22	1	9.914 452
SG 4500 SK	1000	230	785	33	1	9.914 437
SG 6200 SK	1000	230	1025	46	1	9.914 432
SG 7000 SK	1500	360	670	55	1	6.285 619
SG 11000 SK	1500	360	860	66	1	6.285 620
SG 15000 SK	1500	360	1120	120	1	6.285 621
SG 2000 3/4"	450	230	410	16	1	9.914 512
SG 2800 3/4"	800	230	570	22	1	9.914 509
SG 4500 3/4"	1000	230	785	33	1	9.914 506
SG 6200 3/4"	1000	230	1125	46	1	9.914 587
SG 7000 1 1/4"	2000	360	670	55	1	9.914 502
SG 11000 1 1/4"	2500	360	860	66	1	6.035 607
SG 15000 1 1/4"	3000	360	1120	120	1	6.035 609

3



1

1 Ultra pure water system OmniaTap

For pure water and ultra pure water Type I + II.

Stakpure GmbH

OmniaTap is the ideal system when both pure water and ultrapure water are required, but in relatively small amounts. It provides both types from a single system. These also make it possible to connect the system directly to a drinking water tap. A touch on the flexible OptiFill dispenser button activates dispensing of ultrapure water type I via the digital dispenser control. The recirculation of the pure water held in the installed 10 litre tank keeps it permanently at type II quality.

Applications:

OmniaTap 6/12: AAS, IC, ICP, buffers and media preparation

OmniaTap 6 UV/12 UV: Ultra-trace analysis, ICP-MS, HPLC, TOC-analysis

OmniaTap 6 UV/UF/12 UV/UF: Life science and microbiology, cell culture media

Scope of supply: Instrument incl. filter cartridges and sterile filter capsule 0.2 µm

Specifications

Type II

Ultrapure water output:

Resistivity:

Conductivity:

Pure water tank pressurized outlet:

Type I

Dispensing performance:

Resistivity:

Conductivity:

Bacteria (with end filter):

Particles (with end filter):

Feed water requirements:

Dimensions (W x D x H):

Weight:

Power supply:

OmniaTap/OmniaTap UV/OmniaTap UV/UF

6 or 12 l/h

15-10 MΩ-cm

0.067-0.1 µS/cm

optional

up to 2 l/min

18.2 MΩ-cm

0.055 µS/cm

< 0.1 CFU/ml

< 1/ml

Drinking water according to DIN 2000

390 x 615 x 720 mm

20 kg/21 kg/21 kg

90-240 V, 50/60 Hz

Type	TOC value	Endotoxin content EU/ml	PK	Cat. No.
OmniaTap 6	5-10 ppb	-	1	6.272 145
OmniaTap 6 UV	1-5 ppb	-	1	6.272 146
OmniaTap 6 UV/UF	1-5 ppb	0.001	1	6.272 147
OmniaTap 12	5-10 ppb	-	1	6.272 148
OmniaTap 12 UV	1-5 ppb	-	1	6.272 149
OmniaTap 12 UV/UF	1-5 ppb	0.001	1	6.272 150

Accessories for Ultra pure water systems OmniaPure/OmniaTap/OmniaLab^{ED}

Stakpure GmbH

Type	For	PK	Cat. No.
Pre treatment cartridge OmniaPure	OmniaPure	1	6.272 136
Pure water cartridge Omnia 055	OmniaPure / OmniaTap / OmniaLab ^{ED}	1	6.272 137
Sterile filter capsule 0,2 µm	OmniaPure / OmniaTap / OmniaLab ^{ED}	1	6.272 138
Bio end filter	OmniaPure / OmniaTap / OmniaLab ^{ED}	1	6.272 139
Spare UV lamp Omnia 185	OmniaPure / OmniaTap / OmniaLab ^{ED}	1	6.272 140
UF ultra filtration BIG	OmniaPure / OmniaTap	1	6.272 141
Wall mount Omnia	OmniaPure / OmniaTap	1	6.272 142
Disinfection kit Omnia	OmniaPure / OmniaTap	1	6.272 143
Disinfection solution Omnia	OmniaPure / OmniaTap	1	6.272 144
RO-cartridge	OmniaTap 6	1	6.272 151
RO-cartridge	OmniaTap 12	1	6.272 152
Pre-treatment unit OmniaTap/Lab - 10"	OmniaTap / OmniaLab ^{ED}	1	6.272 154
Clear water cartridge Omnia 067	OmniaLab ^{ED}	1	6.272 159
UV tank disinfection unit	OmniaLab ^{ED}	1	6.272 160
UV flow disinfection Omnia 254	OmniaLab ^{ED}	1	6.272 161
UV unit for TOC reduction Omnia 185	OmniaLab ^{ED}	1	6.272 162

1 Ultra pure water system OmniaPure

Stakpure GmbH

For ultra pure water Type I.
 For ultra pure water system of highest quality that fulfils the demands of analytical and life science laboratory requirements. Versatile in configuration, flexible in function, economical in operation. The incorporated pre-treatment constantly ensures the reliability of your experimental results and reduces running costs. Wall-mounting or, to save bench space, in a base cabinet. The standard OptiFill dispenser and monitoring unit enables convenient and precise filling into laboratory vessels.

Applications:

- OmniaPure:** AAS, IC, ICP, buffers and media preparation
- OmniaPure UV:** Ultra-trace analysis, ICP-MS, HPLC, TOC-analysis
- OmniaPure UV/UF:** Life science and microbiology, cell culture media
- OmniaPure UV-TOC:** Ultra-trace analysis, ICP-MS, HPLC, TOC measurement
- OmniaPure UV-TOC/UF:** Life science and microbiology, cell culture media, TOC measurement

Scope of supply: Instrument incl. filter cartridges and sterile filter capsule 0.2 µm

Specifications	OmniaPure/OmniaPure UV/OmniaPure UV/UF
Ultrapure water output:	up to 2 l/min/up to 2 l/min/up to 1.6 l/min
Resistivity:	18.2 MΩ-cm
Conductivity:	0.055 µS/cm
Bacteria (with end filter):	< 0.1 CFU/ml
Particles (with end filter):	< 1/ml
Feed water conductivity:	< 30 µS/cm
RNase (with UF module):	< 0.01 ng/ml
DNase (with UF module):	< 4 pg/µl
Dimensions (W x D x H):	390 x 525 x 720*mm
Weight:	19 kg/20 kg/20 kg
Power supply:	90-240 V, 50/60 Hz

Type	TOC value	Endotoxin content EU/ml	PK	Cat. No.
OmniaPure	5-10 ppb	-	1	6.272 133
OmniaPure UV	1-5 ppb	-	1	6.272 134
OmniaPure UV/UF	1-5 ppb	0,001	1	6.272 135
OmniaPure UV-TOC	1-5 ppb	-	1	6.312 930
OmniaPure UV-TOC/UF	1-5 ppb	0,001	1	6.312 931

*with OptiFill Dispenser

1



2 Ultra pure water system OmniaLab^{ED+}

Stakpure GmbH

For pure water and ultra pure water Type I + II.
 Delivers the complete laboratory pure water and ultra-pure water supply. The system complies with international water standards such as ASTM, ISO 3696 and CLSI. The economy of it is maximized by the inclusion of a continuously self-regenerating electrodeionizer. Further to this, each OmniaLab^{ED+}-system holds 100 litres of pure water type II ready for withdrawal in a storage tank that is equipped with quality recirculation. The flexible positioning of the purification modules enables OmniaLab^{ED+} to be supplied as a tower-unit (mobile on castors) or, to save space, for fitting in a base cabinet. OmniaLab^{ED+} is exactly right as pure water supplier to autoclaves, laboratory washing machines and the dispensing of type I ultra pure water for analytical and bioscience applications.

Application: Complete laboratory supply

Specifications OmniaLab

ED20+ / ED40+ / ED70+

Type II	
Ultrapure water output:	20 l/h/40 l/h/70 l/h
Resistivity:	15-1 MΩ-cm
Conductivity:	0.067 ... 1 µS/cm
Pure water tank pressurized outlet:	optional
Bacteria (with end filter):	< 0.1 CFU/ml
Particles (with end filter):	< 1/ml
Type I	
Resistivity (with ultrapure water cartridge):	18.2 MΩ-cm
Conductivity (with ultrapure water cartridge):	0.055 µS/cm
TOC value (with UV unit):	1 ... 5 ppb
Feed water requirements:	softened water according to DIN 2000
Dimensions Tower (W x D x H):	511 x 575 x 1520*mm
Dimensions base cabinet tank (W x D x H):	511 x 575 x 800 mm
Weight:	43 kg/43 kg/45 kg
Power supply:	90-240 V, 50/60 Hz

Type	PK	Cat. No.
OmniaLab ^{ED20+}	1	6.272 155
OmniaLab ^{ED40+}	1	6.272 156
OmniaLab ^{ED70+}	1	6.272 157

*with OptiFill Dispenser

2



1 Ultrapure water system, arium® pro

ASTM Typ1 water purification system for the high-end user. Whether for routine analysis or critical applications where reagent-grade water is required, the system consistently supplies high quality that is perfect for your applications.

Sartorius Lab Instruments

arium® pro features a convincing innovative design, quality and ease of use. From the intuitive menu navigation to the operator friendly setup, all units in the arium® pro series feature ultra easy operation and ultra high flexibility for producing laboratory-grade purified water. arium® pro UV and pro VF water purification systems are also optionally available with an integrated TOC monitor for regularly checking the organic water constituents in product water. The TOC can be measured manually or automatically as required.

Areas of Application

- Atomic absorption (AA)
- Ion exchange chromatography (IC)
- High performance liquid chromatography (HPLC)
- Polymerase chain reaction (PCR)
- Inductively coupled plasma mass spectrometry (ICP-MS)
- Preparing cell culture media
- Protein purification
- Manufacturing reagents
- Preparing buffers and media
- Rinsing glass vessels

Features

- Innovative glass operator interface with touch function
- Integrated TOC measurement (optional)
- Volume- and time-controlled dispensing
- Freely adjustable flow rates up to 2 L/min
- Conductivity measurement for feed and product water
- Integrated monitoring of water consumption
- Data logging on SD card and printer or PC
- Activatable PIN code for basic configurations
- Service and alarm functions supported by graphic displays
- Intelligent alarm system
- Compact design

Product Water Quality

Resistivity:	18.2 MΩ x cm
TOC (at 50 ppb feed water):	
arium® pro DI/UF:	≤ 5 ppb*
arium® pro UV/VF:	< 2 ppb*
Endotoxin at arium® pro UF/VF:	< 0.001 EU/ml
Particles (at 0.2 µm):	< 1/ml
Bacteria (CFU/1000 ml):	< 1
Flow rate (at 2 bar without final filter)	
arium® pro DI/UV:	up to 2 L/min
arium® pro UF/VF:	up to 1.7 L/min

Type	Description	PK	Cat. No.
arium® pro DI-T	standard system	1	9.914 548
arium® pro UV-T	with UV-lamp, for chromatographic applications	1	9.914 549
arium® pro UF-T	with ultra filter, for cell culture applications	1	9.914 550
arium® pro VF-T	with ultra filter and UV-lamp, for standard, cell culture and chromatographic applications	1	9.914 553

*Values may vary depending on the quality of the feed water, the amount of contamination contained in the feed water, and/or the type of cartridge in use.

1



1 Pure water purification systems Barnstead™ Pacific™ TII

The Thermo Scientific Pacific Barnstead TII system provides ultrapure water (1 - 10 MΩm) ASTM type II for typical demand up to 200 l/day. By combining different treatment technologies such as pretreatment, reverse osmosis, ion exchangers, adsorption and optional UV lamp, the Pacific TII produces pure water (ASTM type II) that meets the highest quality standards such as ASTM II, CAP, ISO 3696, CLSI and Bi distillate. Pacific TII is suitable for table or wall mounting. Three tank sizes 30 l, 60 l, or 100 l are available to match the range of permeate capacities of 7, 12 and 20 l/h. Upgrading the system and thus increasing the capacity for a growing pure water demand is possible at any time. Ideal for supplying ultrapure water systems, clinical analysers, reagent/dilution preparation and general chemical analysis. Thermo Scientific

Product features:

- Feed water (e.g. tap water) is pre-cleaned by reverse osmosis membrane. Via the pure water cartridge and optional UV unit the type II water is temporarily stored in the storage tank. The optional recirculation of the water via the integrated pump ensures constant optimal water quality
- Flexible and compact laboratory system for optional mounting on the laboratory bench or with the integrated mounting bracket on the wall
- Simple and economical change of consumables due to separately exchangeable high-tech cartridges
- In the 4-line display numerous operating parameters, such as limit values, flushing cycles tank volume display in % can be easily set and queried
- The code-protected operating system as well as a high-precision conductivity monitoring in acc. with USP enable documentation acc. with GLP requirements
- Additional pressure booster system on the ultrapure water tank for supplying downstream devices (e.g. autoclaves, dishwasher, analyser)
- The scope of supply includes all necessary materials for immediate use: Integrated wall bracket, RO membrane, pure water cartridge, pressure reducer and UV lamp (for Pacific TII UV)

Optional hand dispenser with flexible circulating line for dispensing water in a distance of up to 3 m. The kit contains a 0.2 µm end filter.

Pure water specifications

Operating pressure:	2 to 6 bar
Temperature:	+2 °C to +35 °C
Permeate conductivity:	0.067 to 0.1 µS/cm (at <30 ppm CO ₂ in feeding water)
Permeate resistance at 25°C:	15 to 10 MΩ.cm
Removal bacteria, Pyrogens:	>99 %
TOC value:	<30 ppb
Interface:	RS 232

Specifications

Power supply:	90-240 V/50-60 Hz
Dimensions (W x D x H):	372 x 330 x 613 mm
Feedwater connector:	Tubing 1.5 m with 8 mm o.d. and R ³ / ₄ " inner thread
Wastewater connector:	¼" or 8 mm o.d., tubing 2 m, pressureless drain
Power Consumption:	0.08 kW

Type	Permeate L/hr	PK	Cat. No.
Pacific TII 7	7	1	9.535 537
Pacific TII 7 (UV)	7	1	9.535 542
Pacific TII 12	12	1	9.535 538
Pacific TII 12 (UV)	12	1	9.535 543
Pacific TII 20	20	1	9.535 539
Pacific TII 20 (UV)	20	1	9.535 544

1



Water purification/Pure and ultra-pure water

1

1 Ultrapure water purification systems Barnstead™ GenPure™, ASTM I

All Barnstead GenPure systems meet the requirements of the international standards ASTM type I, ISO 3696 type 1, ASTM D1193 and CLSI- CLRW. A variety of innovative expansion options, such as UV-lamp with wavelengths 185/254 nm and UV-intensity monitoring, a backwashable ultrafilter, real time TOC monitoring, a remote dispenser xCAD (operating radius 80 cm) or a flexible (operating radius 60 cm) dispenser on the unit (GenPure Pro), ensure optimal supply for all analytical and life science applications. All GenPure systems are supplied with: Feed water pressure reducer, wall-mounting, ultrapure water cartridge, end filter, options - all available under one order number

Thermo Scientific

Product features:

- Pre-cleaned feed water (e.g. reverse osmosis, distillation, demineralised water) is treated by a filtration cartridge and optional UV/UF units to produce ultrapure water
- Compact laboratory system for optional mounting on the laboratory bench, on the wall or with the optional dispensing unit xCAD under the laboratory bench
- Simple and economical change of consumables due to easily accessible service hood and cartridge with quick release fasteners and AquaStopp
- Integrated feed water monitoring with individually adjustable limit value ensures the purity grade of the product water and durability of the filter sets
- Swivel-mounted display/keyboard unit for setting and querying all operating and performance parameters (e.g. limit values for ultrapure water quality)
- USP-compliant conductivity measurement with auto-calibration
- Pre-settable dosing in the range from 0.01 to 65 l
- Accurate real-time TOC measurement at the sample point for continuous monitoring of the organic water constituents meets USP requirements
- Permanent UV-intensity monitoring and display in %, as well as UV operating hours counter with individual adjustable limit values

Ultrapure water specifications ASTM Type I

Flow rate, max.:	Up to 2 L/min
Operating pressure:	2 to 6 bar
Temperature:	2 °C to 35 °C
Conductivity:	0.055 µS/cm
Resistance at 25°C:	18.2 MΩxcm
TOC value in ppb (Models with UV):	1 - 5
TOC value in ppb (Models without UV):	< 10
Endotoxins*in EU/ml (Models with UF):	< 0.001
RNase*in ng/ml (Models with UF):	0.01
DNase*in pg/µl (Models with UF):	4
Bacterial content:	<1 cfu/ml
Particles >0.2µm/mL:	< 1
Dimensions (W x D x H):	372 x 330 x 615 mm
Dimensions xCAD (W x D x H):	260 x 530 x 725 mm
Feedwater connector:	¾" o.d.
Drainwater connector:	¼"
Power Consumption:	0.1 kW
Power supply:	90-240 V/50-60 Hz

Type	Description	PK	Cat. No.
GenPure UF/UV	Molecular biology, PCR, DNA, monoclonal antibodies, cell culture	1	9.535 877
GenPure Pro UV	Trace analysis, HPLC, ICP-MS, IC	1	9.535 890
GenPure Pro UV/UF	Molecular biology, PCR, DNA, monoclonal antibodies, cell culture	1	9.535 889
GenPure Pro UV-TOC	Trace analysis, HPLC, ICP-MS, IC, TOC analysis	1	9.535 891
GenPure Pro UV-TOC/UF	Molecular biology, PCR, DNA, monoclonal antibodies, cell culture	1	9.535 892

UF=with ultra filtration, UV=with UV photo oxidation 185/254 nm, UV-TOC=with UV photo oxidation 185/254 nm and TOC display, UV-TOC/UF=with UV photo oxidation 185/254 nm, TOC display and ultra filtration

*depending on feed water quality

Accessories for Ultrapure water purification systems Barnstead™ GenPure/GenPure Pro

Thermo Scientific

Description	PK	Cat. No.
Ultrapure water filter set	1	9.535 971
Sterile filter 0.2 µm	1	9.535 961

1 Ultrapure water purification system Barnstead™ MicroPure™, ASTM I

1

Thermo Scientific

The Thermo Scientific Barnstead MicroPure system provides ultrapure water (18.2 MΩ, 0.055 μS/cm) ASTM type I, for typical demand up to 15 l/day. All MicroPure systems meet the requirements of the international standards ASTM (type I), ISO 3696 (type 1), ASTM D1193 and CLSI-CLRW. A variety of innovative expansion options, such as UV-lamp with wavelengths 185/254 nm and a backwashable ultrafilter with a flow rate up to 0.6 l/min, ensure optimal supply for all analytical and life science applications.



MicroPure systems are supplied for immediate use with: pressure reducer, end filter, ultrapure water cartridge

Product features:

- Pre-cleaned feed water (e.g. reverse osmosis, distillation, demineralised water) is treated by a filtration cartridge and optional UV/UF units to produce ultrapure water
- Compact laboratory system for optional mounting on the laboratory bench or on the wall
- Simple and economical change of consumables due to easily accessible service hood and cartridge with quick release fasteners and AquaStopp
- Swivel-mounted display/keypad unit for setting and querying all operating and performance parameters such as limit values for ultrapure water quality
- **MicroPure ST systems** supplied with integrated 6 l tank for mobile use in the laboratory. Feed water supply with pre-cleaned water is provided by this tank

Specifications

Flow rate, max.:	1L/min
Operating pressure:	2 to 6 bar
Temperature:	+2 °C to +35 °C
Conductivity:	0.055 μS/cm
Resistance at 25°C:	18.2 MΩxcm
TOC value (models with UV):	1 to 5 ppb
TOC value (models without UV):	< 10 ppb
Bacterial content:	<1 cfu/ml
Particles >0.2 μm/mL:	<1
Endotoxins (Models with UF):	<0.001 EU/ml
Power consumption:	0.06 kW
Power supply:	90-240 V, 50/60 Hz, automatic voltage regulation to 24 V
Dimensions (W x D x H):	305 x 300 x 545 mm
Dimensions models with reservoir (W x D x H):	305 x 400 x 545 mm

Type	Description	PK	Cat. No.
MicroPure UV	Trace analysis, HPLC, ICP-MS, IC	1	9.535 826
MicroPure UF/UV	Molecular biology, PCR, DNA, monoclonal antibodies, cell culture	1	9.535 825
MicroPure UV-ST	Trace analysis, HPLC, ICP-MS, IC	1	9.535 830
MicroPure UF/UV-ST	Molecular biology, PCR, DNA, monoclonal antibodies, cell culture	1	9.535 829

With UF = ultrafiltration, UV = UV photo-oxidation 185/254 nm, UF/UV = Ultra Filtration and UV photo-oxidation 185/254 nm

Accessories for Ultra pure water system Barnstead™ MicroPure™

Thermo Scientific

Description	PK	Cat. No.
Ultra pure filter set	1	9.535 963
Sterile filter 0.2 μm	1	9.535 961
UV replacement lamp	1	9.535 960
Disinfectant cartridge	1	9.535 968



Water purification/Pure and ultra-pure water



1 Pure and Ultrapure water purification system Barnstead™ Smart2Pure™, ASTM I and II

The Thermo Scientific Barnstead Smart2Pure system is a compact system which converts tap water into ASTM type I and II water. The Smart2Pure models 3 and 6 are featured with an built-in 6 l tank to store the type II water. The Smart2Pure 12 offers the choice between a 30 l or 60 l tank depending on storage requirements. A variety of innovative expansion options, such as UV-lamp with wavelenghts 185/254 nm and a backwashable ultrafilter with a flow rate up to 0.6 l/min, ensure optimal supply for all analytical and life science applications. A swiveling display and the easy filter change make the Smart2Pure the perfect laboratory water unit for the small demand.

Thermo Scientific

Product features:

- Easy and economical change of consumables due to separately exchangeable high-tech reprocessing cartridges
- Guaranteed pure water quality: Recirculation pump and sterile ventilation filter protect from contamination and ensure a tank water quality from 10 up to 15 MW x cm
- Additional pressure outlet on the ultrapure water tank for supplying downstream devices (e.g. autoclaves, analyser) or connection of a flexible dispenser
- The scope of supply includes all necessary materials for the first-time operation (for Smart2Pure12 a storage tank must be supplemented)
- Optional hand dispenser with 3 m flexible circulation line for remote dispensing of the water. The kit contains a 0.2 µm end filter

Ultrapure water specifications ASTM Type I

Flow rate:	1.0 l/min
Flow rate UF-models:	0.6 l/min
Conductivity:	0.055 µS/cm
Resistance at 25 °C:	18.2 MΩxcm
TOC value:	<10 ppb
TOC values UV-models:	1 to 5 ppb
Endotoxins UF-models:	0.005 EU/ml
Bacterial content:	<1cfu/ml
Particles >0.2 µM/ml:	<1

Pure water specifications ASTM Type II

Permeate flow rate at 15 °C:	
Smart2Pure 3:	3 l/h
Smart2Pure 6:	6 l/h
Smart2Pure 12:	12 l/h
Permeate conductivity:	0.067 to 0.1 µS/cm
Permeate resistance at 25 °C:	15 to 10 MΩxcm

Specifications

Power supply:	90-240 V, 50/60 Hz
Dimensions (W x D x H):	305 x 400 x 545 mm
Feedwater connector:	¾ inch
Drain connection:	¼ inch

Type	Description	PK	Cat. No.
Smart2Pure 3 UV	Trace analysis, HPLC, ICP-MS, IC	1	9.535 862
Smart2Pure 3 UF/UV	Molecular biology, PCR, DNA, monoclonal antibodies, cell culture	1	9.535 863
Smart2Pure 6 UV	Trace analysis, HPLC, ICP-MS, IC	1	9.535 866
Smart2Pure 6 UF/UV	Molecular biology, PCR, DNA, monoclonal antibodies, cell culture	1	9.535 867
Smart2Pure 12 UV	Trace analysis, HPLC, ICP-MS, IC	1	9.535 870
Smart2Pure 12 UF/UV	Molecular biology, PCR, DNA, monoclonal antibodies, cell culture	1	9.535 871

With UF = ultrafiltration, UV = UV photo-oxidation 185/254 nm, UF/UV = Ultra Filtration and UV photo-oxidation 185/254 nm

Accessories for pure and ultrapure purification systems Barnstead™ Smart2Pure™

Thermo Scientific

Description	PK	Cat. No.
Ultrapure water cartridge	1	9.535 966
UV replacement lamp	1	9.535 960
Sterile filter, 0.2 µm for direct removal/device	1	9.535 961
Reverse Osmosis membrane with integrated pretreatment, 3 L/hr	1	9.535 970
Reverse Osmosis membrane with integrated pretreatment, 6 L/hr	1	9.535 972
Reverse Osmosis membrane with integrated pretreatment, 12 L/hr	1	9.535 973
CO ₂ adsorber and sterile venting filter for Smart2Pure 12	1	9.535 923
Smart2Pure 12 Tank 30 l	1	9.535 931
Smart2Pure 12 Tank 60 l	1	9.535 935

1 Reverse osmosis systems, Ultra Clear™ RO EDI

The well-proven Ultra Clear™ RO range has been enhanced to peak water quality level in the plus series by adding electronic deionisation cells: accessory deionisers for removing inorganic materials from the output are therefore no longer required.

evoqua

Technical parameters:

- Resistance up to 17 megohm (0.07 µS/cm)
- TOC < 5 to 20 ppb at RO cell output
- Typical pure water quality < 0.07 µS/cm

In all Ultra Clear™ RO systems the quality of the feed and output water will be shown on the display.

Features:

- pure water treatment for simple analysis, laboratory rinsing machines, autoclaves, up to ultrapure water systems
- germ/pyrogen retention rate >99 %
- complete, connection-ready system; fittings allow supply tanks to be expanded if required (e.g. Ultra Clear™ RO supply tanks with 30, 60 and 80 litre capacities, larger tanks are available on request)
- menu-driven controller, RS232 interface
- Entrance- and Product water quality will be shown on the display.

Specifications

Rating:	200/300 W
Dimensions (W x D x H):	340 x 420 x 520 mm
Colloidal index (SDI):	< 3
Supply water pressure:	2 to 6 bar (0.1 to 5 bar Ultra Clear™ RO EDI 10)
Input conductivity:	< 1400 µS/cm

1



Type	Pure water output at 15 °C l / hr	Weight kg	PK	Cat. No.
Ultra Clear™ RO EDI 10	10	31	1	6.267 641
Ultra Clear™ RO EDI 20	20	32	1	4.667 956
Ultra Clear™ RO EDI 30	30	35	1	4.667 959
Ultra Clear™ RO EDI 55	55	46	1	9.914 623

Further models can be found in our online shop.

Accessories for Reverse osmosis systems Ultra Clear™ RO/RO EDI/LaboStar™ RO DI

evoqua

Type	For	Change interval	PK	Cat. No.
Pre-treatment module VMD	Ultra Clear™ RO DI 10-40/RO EDI, LaboStar™ RO/DI	every 3 months*	1	9.914 520
Pre-treatment module AMB	Ultra Clear™ RO, LaboStar™ RO/DI	every 6 months*	1	9.914 524
RO module**	Ultra Clear™ RO EDI, LaboStar™ RO/DI	every 2 to 3 years	1	9.914 519
Conditioning module	Ultra Clear™ RO EDI	every 3 to 6 months	1	6.241 832
RO module 55 l/h	Ultra Clear™ RO EDI 55 l	every 2 to 3 years	1	6.283 462
CO ₂ trap CT1 incl. Vent filter (spare cartridge)	Ultra Clear™ RO EDI		1	9.914 527
CO ₂ trap CT1 with Vent filter VT1	LaboStar™ RO DI	every 12 months	1	6.285 641
Kit for 30 / 60 l tank				
Vent filter for 7 l tank	LaboStar™ RO DI	every 12 months	3	6.285 643
Sterile filter 0.2 µm	LaboStar™ RO DI	every 6 months	3	6.238 931
Sterile filter 0.2 µm with endotoxin retention	LaboStar™ RO DI	every 6 months	3	6.259 821
30 l Extension storage tank	LaboStar™ RO DI		1	6.285 642
60 l Extension storage tank	LaboStar™ RO DI		1	6.285 597
Degassing unit (max. 150 l/h)	LaboStar™ RO DI		1	6.285 640
Wall bracket ET 30 for 30 l tank	LaboStar™ RO DI		1	7.981 287
Wall bracket ET 60 for 60 l tank	LaboStar™ RO DI		1	6.285 639
CO ₂ + UV Kit for 30 l	Ultra Clear™ RO, RO DI, RO EDI		1	4.670 986
CO ₂ + UV Kit for 60 l	Ultra Clear™ RO, RO DI, RO EDI		1	4.670 987
CO ₂ trap CT1 incl. Vent filter for 80 l	Ultra Clear™ RO, RO DI, RO EDI		1	4.670 988
UV-Kit 80 l tank	W3T324515 + W3T314514		1	4.670 989
UV-Kit 80 l tank, UV replacement lamps	W3T197526 + W3T197510		1	4.670 990
Tank 30 l	All Ultra Clear™ RO EDI		1	6.285 646
Tank 60 l	All Ultra Clear™ RO EDI		1	6.285 647
Tank 80 l, incl. pump 8 l/min	Ultra Clear™ RO EDI 10-30		1	6.285 648
Tank 80 l, incl. pump 1.2 l/min	Ultra Clear™ RO EDI 10-30		1	6.285 649
Tank 80 l, incl. pump 8 l/min	Ultra Clear™ RO EDI 55		1	6.285 650
Tank 80 l, incl. pump 1.2 l/min	Ultra Clear™ RO EDI 55		1	6.285 651
RO module 15 l/h	Ultra Clear™ RO, RO DI, RO EDI 10 and 30 l	every 2 to 3 years	1	9.914 510

* Interval of exchanges depends on raw water quality and throughput

1 Ultra pure water system, Ultra Clear™ TP TWF EDI

The Ultra Clear™ TWF EDI system is equipped with all the necessary components to produce reagent grade water directly from municipal tap water. The built-in reverse osmosis system has a recovery rate of >30 % to conserve water. evoqua

The continuous electrodeionization (CEDI) stage purifies RO product water down to a quality range between 0.055 to 0.2 µS/cm. CEDI product water can be drawn directly from the integrated storage tank. Each system is equipped with economical state-of-the-art purification technology. Water quality with a resistivity of 18.2 MΩ-cm and a TOC level between 1 to 3 ppb far exceeds all reagent water quality standards including: ASTM Type 1, CLSI and ISO 3696 Type 1. All systems that include ultrafiltration (UF) produce the highest possible water quality. These units deliver RNase-, DNase- and DNA-free water. A separate reverse osmosis system with storage tank, an electro-deionization and an ultrapure water treatment, compiled into a system, always requires a far greater financial investment. Our system contains All-in-One.

- 7" multi-color glass display for fast and easy operation, with a generous overview
- Easy to navigate by touching functional system components
- New designed user interface
- Graphic display of all main functions
- SD cards and USB connection for data transfer
- Interface and manual available in 7 languages (German, English, French, Spanish, Portuguese, Russian and Chinese)
- Ultrapure water system with an integrated reverse osmosis system to transform municipal water to pure and ultrapure water.
- Consistent water quality due to the EDI cell
- Connection directly to the drinking water line

Specifications

Ultrapure water output:	up to 1.8 l/min
Resistivity at 25 °C:	18.2 MΩ-cm
Conductivity at 25 °C:	0.055 µS/cm
Bacteria:	< 1 cfu/ml
TOC:	< 1 to 3 ppb
Particles >0.2:	< 1 per ml
Pure water flow rate:	< 20 l/h
Feed water conductivity:	< 1400 µS/cm
DNase, RNase, DNA:	free (UF versions only)
Power supply:	100-240 V, 50/60 Hz

Type	TOC value	Endotoxin content EU/ml	Dimensions (W x D x H) mm	PK	Cat. No.
30 UV TM	< 1-3	-	640 x 320 x 535	1	6.285 633
30 UV UF TM	< 1-3	< 0.001	640 x 320 x 535	1	6.285 634
60 UV TM	< 1-3	-	900 x 320 x 535	1	6.285 635
60 UV UF TM	< 1-3	< 0.001	900 x 320 x 535	1	6.285 636

Further models can be found in our online shop.

Accessories for Ultra pure water system, Ultra Clear™ TP/TWF TP/TP TWF EDI Touch Panel

Description	For	PK	Cat. No.
CO2 trap CT1 incl. Vent filter (spare cartridge)	TWF TP / TP TWF EDI	1	9.914 527
UV replacement bulb UC (tank)	TWF TP / TP TWF EDI	1	6.265 907
RO module	TWF TP / TP TWF EDI / TP TWF EDI	1	9.914 519
Pre-treatment module AMB	TWF TP / TP TWF EDI	1	9.914 524
Conditioning module	RO EDI / TP TWF EDI	1	6.241 832
Flexible side ndispenser	TP / TWF TP / TP TWF EDI	1	6.285 637
Pre-treatment module VMD	TP / TWF TP	1	9.914 520



Genomics	1292
PCR	1292
DNA and RNA isolation	1300
Thermocyclers.....	1302
PCR cabinets.....	1305
DNA-Electrophoresis	1306
Gel-Documentation	1310
Concentration	1314
Electroporation.....	1314
Proteomics	1316
ELISA	1316
Protein-Electrophoresis.....	1321
Blotting.....	1322
Blot Imaging.....	1326
Purification	1327
Cell Culture	1331
Cultivation	1331
Aspirators.....	1351
Filtration	1354
Safety Cabinets.....	1357
Microbiology	1361
Media and reagents	1361
Cultivation	1364
Sterilizers and burners	1380
Cell disruption.....	1387
Disruptors	1389
Filtration	1390
Analysis	1392
ATP detection.....	1396
Hygiene monitoring.....	1396
Histology	1398
Embedding cassettes	1398
Microtoms	1399
Scalpels	1400
Dissecting sets.....	1402
Accessories and reagents.....	1403
General Consumables	1406
Micro Tubes	1406
Centrifugation Tubes.....	1413
Deep-well plates.....	1415

1



1 LLG-PCR tubes with attached lids, PP



- Individual tubes
- Compatible with all common thermocyclers
- 0.2 ml or 0.5 ml
- Individual attached flat or domed snap caps
- Consistent wall thickness for uniform heat transfer
- Cap design ensures fit and helps reduce sample evaporation
- Virgin polypropylene, certified RNase-, DNase- and Endotoxin-free

Description	PK	Cat. No.
0.2 ml, single, flat cap	1000	6.313 401
0.2 ml, single, domed cap	1000	6.313 402
0.5 ml, single, flat cap	1000	6.313 403

2

LLG-PCR-Tubes, 8 Strips with attached individual caps, PP



- For 0.2 ml Thermocycler blocks
- With domed or flat cap
- Made of high quality polypropylene, RNase-, DNase- and Endotoxin-free

Description	PK	Cat. No.
8 PCR tube strips with individually attached flat snap caps	126	6.313 405
8 PCR tube strips with individually attached domed snap caps	126	6.313 407
Domed caps for 8 PCR tube strips	125	6.313 406

2



3

LLG-PCR-Tubes, 8 Strips, PP



- For 0.2 ml thermocycler blocks
- Detached cap strips can be used as individual tubes when cut
- With domed or flat caps
- Consistent wall thickness for uniform heat transfer
- Contamination-free opening
- Cap strips provide tight seal during all PCR cycles
- Highly transparent cap makes them ideal for qPCR
- Virgin polypropylene, certified RNase-, DNase- and Endotoxin-free

Description	PK	Cat. No.
8 PCR tube strips plus detached cap strips, domed caps	125	6.313 412
8 PCR tube strips plus detached cap strips, flat caps	80	6.313 404

3



1 PCR Products, BRAND

BRAND has significantly expanded its product range of extra-thin-wall disposable products, which were specially developed to satisfy the demands of PCR applications.

Quality features

- Suitable for use in common thermocyclers
- PP, extra-thin uniform wall thicknesses to provide the optimal thermal transfer and short cycle times
- 96-well PCR plates with blue alphanumeric code and cut corner marking
- Highly clear flat covers optimally suited for qPCR
- DNase-, DNA- and RNase-free
- Autoclavable at 121°C (2 bar), acc. DIN EN 285
- qPCR: Products which are suitable for Real Time PCR (qPCR)

White PCR products offer significantly better results for qPCR, and are specifically recommended by many thermocycler manufacturers.



2 Single PCR tubes with attached caps, PP



BRAND

0.2 ml and 0.5 ml PCR tubes with attached caps are compatible with leading thermocyclers with heated lids. The caps are easy to open and close without tools, yet ensure a tight fit to reduce sample evaporation. The various colors of the PCR tubes allow fast sample classification.

Other colors available on request.



Capacity ml	Description	Colour	PK	Cat. No.
0.2	domed cap	clear	1000	9.409 370
0.2	flat cap	clear	1000	9.409 371
0.5	flat cap	clear	1000	9.409 372

3 Strips of 8-/12- PCR tubes plus detached cap strips, PP



BRAND

Strips of 8 or 12 connected PCR tubes (0.2 ml). Cap strips consisting of 8 or 12 domed caps (available separately) provide tight seal during all PCR cycles, thus protecting samples from cross-contamination. The tubes have a holding strap at one end, and the cover strips on each lid have a small lip on the side for careful, contamination-free opening. Consistent tube wall thickness allows rapid heat transfer along the entire exterior tube surface. Made of pure, virgin polypropylene, free from RNase-, DNase- and DNA. Autoclavable at 121 °C (2 bar), according to DIN EN 285.

Other colors on request.



Capacity ml	Description	Colour	PK	Cat. No.
0.2	Strips of 8 PCR tubes, without caps	clear	125	9.409 374
0.2	Strips of 8 PCR caps, domed	clear	125	9.409 375
0.2	Strips of 8 PCR tubes, with separate flat caps	clear	250	4.007 894
0.2	Strips of 8 PCR tubes, with separate domed caps	clear	250	4.007 895
0.2	Strips of 12 PCR tubes, without caps	clear	125	9.409 628
0.2	Strips of 12 PCR caps, domed	clear	125	9.409 633

4 PCR cap strips



NEW
BRAND

For PCR-tubes with detached cap strips.



Description	Colour	PK	Cat. No.
PCR cap stripes of 8, flat	transparent	300	4.668 917
PCR cap stripes of 8, domed	transparent	300	4.668 918



9.409 377

1 PCR tubes strips, with attached individual caps, PP

BRAND



The strips of 8 PCR tubes with attached, flat individual caps provide an ideal protection against contamination. The highly transparent cap makes them ideal for a quantitative Real Time PCR. Available in Standard (0.2 ml) or Low Profile (0.15 ml).



6.228 560

Capacity ml	Type	Colour	PK	Cat. No.
0.15	Low Profile, 1 ridge	transparent	120	9.409 377
0.15	Low Profile, 3 ridges	transparent	120	4.665 989
0.20	Standard, 1 ridge	transparent	120	6.228 560
0.20	Standard, 3 ridges	transparent	120	4.668 916
0.15	Low Profile, 3 ridges	white	120	9.409 246
0.20	Standard, 3 ridges	white	120	9.409 245



3 Strips of 8 PCR tubes with attached cap strips

BRAND



Eight 0.2 ml PCR tubes joined together in a strip with attached, hinged 8-cap strips. PP. The hinged, domed cap makes opening and closing the tubes with one hand easier.

Type	PK	Cat. No.
Colourless	125	9.409 373



4 5 PCR tubes, 0.2ml and 0.5ml, thin-walled

Eppendorf AG



Polypropylene tubes for PCR experiments

Product characteristics of 0.2ml PCR tube:

- Contamination shield on attached lid
- Defined lid position (90°) due to special hinge
- Highly transparent
- Tight sealing
- Easy to open
- Can be used in all thermal cyclers with 0.2ml block format
- The work tray for holding 96 tubes is placed in a frame and with this forms a complete rack for 0.2ml tubes. Both parts are made of polycarbonate and are autoclavable (at 121°C for 20 mins.)
- Certified being free from human DNA, DNase, RNase and PCR inhibitor

Product features of thin-walled 0.5ml PCR tube:

- frosted writing surface
- Autoclavable when open (at 121°C for 20 mins.)
- Highly transparent
- Easy to open
- Can be used in Mastercyclers with 0.5ml block format
- Certified being free from human DNA, DNase, RNase and PCR inhibitor



Description	PK	Cat. No.
0.2 ml PCR tubes, transparent	1000	9.283 579
8-tube strip of 0.2 ml PCR tubes, transparent	120	9.283 622
Work tray for 96 x 0.2 ml PCR tubes	10	9.283 623
Frame for work tray	5	9.283 624
0.5 ml PCR tubes, thin-walled, with attached lid, transparent	500	9.283 626



6 PCR cap tool, PA

NEW

Cap Tool for attaching and detaching caps on PCR plates.

BRAND

Type	PK	Cat. No.
PCR cap tool	1	4.668 919

1 LLG-96-well PCR Plates, PP



- Clear well bottom for sample visibility, with V-Bottom
- Compatible with leading thermocyclers
- Consistent wall thickness for uniform heat transfer
- Holes in the skirt for easy handling
- Virgin polypropylene, certified RNase-, DNase- and Endotoxin-free

Description	Capacity µl	PK	Cat. No.
96 Well Plate, skirted	200	50	6.313 409
96 Well Plate, non-skirted	200	100	6.313 408
96 Well Plate, half skirted	200	50	6.313 394



2 24/48 well PCR Plates, non-skirted, PP, for qPCR



0.2ml wells. The 24 /48 well plates reduce material costs and allow work on a compact PCR plate even with small sample throughputs. Suitable for most types of standard thermal cyclers.

Description	Colour	PK	Cat. No.
24-well, standard profile, elevated rim	clear	40	6.229 655
24-well, standard profile, elevated rim	white	40	4.007 901
48-well, standard profile, elevated rim	clear	20	9.409 368
48-well, standard profile, elevated rim	white	20	4.007 902

BRAND

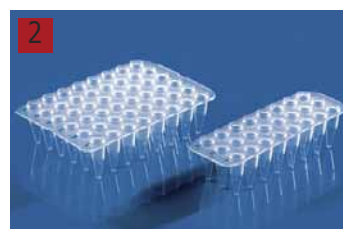

96 well PCR-Plates, PP, for PCR or qPCR

The ultra thin-walled PCR plate design facilitates constant, rapid and precise heat transfer. The smooth vessel interior minimizes the binding of enzymes and nucleic acid to the walls. The rim of the wells are designed to protect against cross-contamination, allowing a reliable seal with the sealing mats tailored to the plates. With blue alphanumeric code and cut corner for easy orientation, or as indicated.

96-well, non-skirted

PP. 0.2 ml wells. 96-well non-skirted PCR plates are suitable for most commercially available thermocyclers.

96-well, semi-skirted

PP. 0.2 ml wells. 96-well semi-skirted PCR plates can easily be labelled or tagged with a barcode.

96-well, semi-skirted. Suitable for Roche® LightCycler® 480 and other thermocyclers

PP. 0.15 ml wells. Semi-skirted. With black alphanumeric code. Available with or without self-adhesive sealing film (polyester, high-transparent, for qPCR).

96-well, skirted

PP. 0.2 ml wells. 96-well skirted PCR plates are especially rigid, and are optimally suited for use with automatic pipetting systems and for being transported.

BRAND

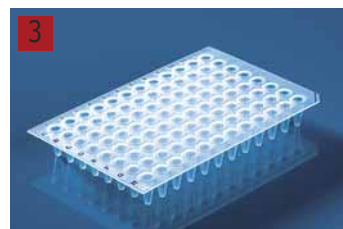

9.409 247



9.409 351

Description	Volume ml	Colour	Cut corner	PK	Cat. No.
Low Profile, non-skirted	0.15	clear	H12	50	9.409 247
Low Profile, semi skirted	0.15	clear	A12	50	9.409 256
Low Profile, semi skirted, raised skirt	0.15	clear	A1	50	9.409 258
Low Profile, fully skirted*	0.15	clear	H1	50	9.409 351
Low Profile, non-skirted	0.15	white	H12	50	9.409 248
Low Profile, semi skirted	0.15	white	A12	50	9.409 257
Low Profile, semi skirted, raised skirt	0.15	white	A1	50	9.409 259
Low Profile, for LightCycler® 480 (Roche®), semi skirted*	0.15	white	H12	50	4.007 899
Low Profile, for LightCycler® 480 (Roche®), semi skirted, incl. films*	0.15	white	H12	50	4.007 900
Low Profile, fully skirted*	0.15	white	H1	50	9.409 266
Standard profile, non-skirted	0.20	clear	A12	50	9.409 254
Standard profile, semi skirted	0.20	clear	A12	50	9.409 264
Standard profile, non-skirted, elevated rim	0.20	clear	H12	50	9.409 381
Standard profile, semi skirted, elevated rim	0.20	clear	H12	50	9.409 383
Standard profile, non-skirted	0.20	white	A12	50	9.409 255
Standard profile, semi skirted	0.20	white	A12	50	9.409 265
Standard profile, non-skirted, elevated rim	0.20	white	H12	50	4.007 896
Standard profile, semi skirted, elevated rim	0.20	white	H12	50	4.007 897

*Black alphanumeric code, no additional markings on the cut corner.



1 2 PCR plates, 96/384 well Eppendorf twin.tec®

Eppendorf AG



Purity, stability, color and other features to facilitate laboratory work.

- Extremely thin-walled polypropylene wells guarantee an optimal temperature transfer
- Exceptionally stable and torsion-resistant polycarbonate frame
- Elevated well edges ensure effective sealing and reduce the risk of cross-contamination
- Batch-tested and certified free of DNA, DNase, RNase and PCR-inhibitors (PCR clean), Eppendorf twin.tec® *microbiology* additionally free of bacterial DNA
- Two versions available: With edge (skirted) or half-skirted (semi-skirted)
- Autoclavable up to 121 °C
- Available with bar code (on request)

Description	Capacity µl	Colour	PK	Cat. No.
96 well, skirted	150	clear	25	9.283 661
96 well, skirted	150	blue	25	9.283 664
96 well, skirted	150	red	25	9.283 665
96 well, skirted	150	yellow	25	9.283 662
96 well, skirted	150	green	25	9.283 663
96 well, skirted, <i>microbiology</i>	150	clear	10	4.655 267
96 well, skirted, <i>microbiology</i>	150	blue	10	4.655 268
96 well, semi-skirted	250	clear	25	9.283 595
96 well, semi-skirted	250	blue	25	9.283 669
96 well, semi-skirted	250	red	25	9.283 670
96 well, semi-skirted	250	yellow	25	9.283 667
96 well, semi-skirted	250	green	25	9.283 668
96 well, semi-skirted, <i>microbiology</i>	250	clear	10	4.655 269
96 well, semi-skirted, <i>microbiology</i>	250	blue	10	4.655 270
384 well, skirted, <i>microbiology</i>	40	clear	10	4.655 271
384 well, skirted, <i>microbiology</i>	40	blue	10	4.655 272

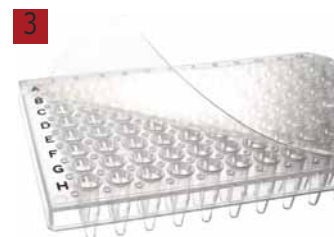

3 LLG-PCR adhesive film and foil

For use in cyclers with screw-down or clip-down lids.

PCR Film: Clear film allows both the visual inspection of samples and fluorescence measurements.

PCR Foil: Aluminium, easy to pierce, no residue of adhesive on the pipette tips.

QPCR Foil: Adhesive seal optically clear, peelable, for QPCR and fluorescence applications.

Description	Temp. range °C	PK	Cat. No.
PCR film	-40 ... 102	100	6.313 398
PCR foil	-80 ... 104	100	6.313 400
QPCR foil	-70 ... 100	100	6.313 399



4 PCR Foil, self-adhesive

For micro test plates, deep well plates, micro test tubes and 96/384 Well PCR plates. DMSO resistant. Easily perforable, even with pipette tips.

Ratiolab

- For manual use
- Temperature resistant from -80 to 120 °C
- Adhesive of PP and aluminium foils with high solvent and DMSO resistance
- All films in SBS standard format

Description	Temp. range °C	PK	Cat. No.
PP	-80 ... 120	100	7.634 537



5 Sealing paddle for sealing films, PE

NEW

White. The sealing paddle helps to attach the self-adhesive film to the plate with a uniform pressure. Especially suited for plates with raised rim.

BRAND

Type	PK	Cat. No.
Sealing paddle for sealing films	1	6.310 361

1 Sealing Films, Self-adhesive

In case the microplates, PCR- and Deepwellplates need not only to be covered, but also securely sealed, self-adhesive sealing films are available. These film sheets can be easily applied on the plates and removed also without the use of expensive equipment. They are available in different versions and are especially well-suited for storage or cell- and tissue-culture. BRAND



Description	Application	Material	PK	Cat. No.
single film, gas-permeable	Cell- and tissue culture	Rayon	100	9.407 620
single film, gas-permeable, sterile	Cell- and tissue culture	Rayon	50	6.224 223
single film, DMSO-resistant	Storage, ELISA, PCR	PP	100	9.408 983
single film	Automation	PE / PP	50	4.000 389
single film	Fluorescence measurement	Vinyl, black	50	4.000 390
single film	Luminescence measurement	Vinyl, white	50	4.000 391
single film	Automation	Vinyl	100	6.272 009
single film	Cold storage, storage	Aluminium	100	6.223 125
single film	PCR, storage	Aluminium	50	4.665 819
single film	PCR, Real-time PCR, storage	Polyester	1	4.665 818
single film	ELISA, PCR	Polyester	100	9.409 386
single film, highly transparent	ELISA, Real Time PCR	Polyester	100	4.000 237

2 PCR adhesive film and foil

Ideal for sealing PCR plates.

Eppendorf AG

- PCR clean: Certified free from human DNA, DNase, RNase and PCR inhibitor
- PCR Film: Allows visual monitoring of samples
- PCR Foil: Easy to pierce, no sticking of the pipette tips (ideal for automated systems)
- Heat Sealing: Position the film or the foil with the adhesive edges on the plate. Seal the plate using the heat sealer.



Description	PK	Cat. No.
PCR foil, self-adhesive	100	9.283 672
PCR film, self-adhesive	100	9.283 679
Heat Sealing PCR foil	100	9.776 567
Heat Sealing PCR film	100	6.241 459
Storage Film, self-adhesive	100	4.655 243
Storage Foil, self-adhesive	100	6.241 374
Sealing Mats 96/2000 *	50	6.280 065
Sealing Mats 96/1000 und 96/500 *	50	7.644 255

* autoclavable (at 121°C for 20 mins.)

3 AccuSeal Semi-Automated Plate Sealer

- Accepts a wide range of microplates and heat seals
- User-friendly control system
- Large digital display shows all operating parameters
- Adjustable sealing temperature: 100°C to 190°C, or no heat
- Precise temperature, timing and pressure for consistent sealing

Labnet

Specifications

Dimensions (W x D x H):	171mm x 324mm x 362mm
Weight:	12kg
Sealing Temperature:	Off, 100 to 190°C (increments of 1.0°C)
Temperature Accuracy:	±1.0°C
Temperature Uniformity:	±1.0°C
Sealing Time:	0.5 to 10 sec (incements of 0.1 sec)
Compatible Plate Materials:	PP (Polypropylene), PS (Polystyrene), PE (Polyethylene)
Compatible Plate Types:	Standard Assay Plates, Deep-Well Storage plates, PCR Plates (Non-Skirted, Semi-Skirted, Full-Skirted)
Maximum Plate Height:	45mm
Compatible Sealing Film Types:	Foil Polypropylene laminate, Clear Polyester-polypropylene laminate, Clear polymer, Thin clear polymer, Foil-laminate, Foil



Type	Description	PK	Cat. No.
AccuSeal	includes adapters for standard and deepwell microplates, 230V	1	9.595 290
AccuSeal	adapter for sealing PCR plates	1	9.595 291

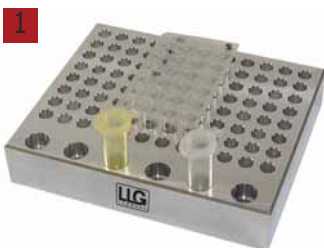

9.409 015

LLG-Temperature block *exact*, aluminium

Suitable for both cooling and heating, universally usable, uniform temperature distribution within the block, ideal for all temperature-sensitive applications.

Aluminum blocks with conical compartments and closed bottom for easy and precise tempering of reaction tubes and PCR tubes. The precisely adapted shape of the borings and the closed bottom offer advantages compared with cylindrical drilled blocks with open bottom, such as much better heat transfer and temperature accuracy. Made of a special aluminum alloy with high thermal conductivity. Identical temperature conditions for all samples. Compact size, requiring little space. Suitable for 96-well plates, 8 or 12 strips and single tubes. Ideal for working with 8- or 12-channel pipettes. Blocks for different tube sizes and combinations of tube sizes as indicated, all working steps in one block, holes closed at the bottom and tapered to fit perfectly the respective tube sizes and offer an optimum heat exchange.



9.409 017

Array	Dimensions (W x D x H) mm	PK	Cat. No.
96 x 0.2 ml PCR tubes + 6 x 1.5 ml tubes	118 x 89 x 24	1	9.409 015
36 x 0.5 ml tubes + 11 x 1.5 ml tubes	180 x 79 x 24	1	9.409 016
24 x 1.5 ml tubes	115 x 89 x 34	1	9.409 017
24 x 2.0 ml tubes	115 x 89 x 34	1	9.409 018
25 x 2.0ml Cryogenic tubes with round bottom	197 x 99 x 32	1	9.409 006
12 x 15.0ml Centrifuge tubes	75 x 89 x 38	1	9.409 008



3 96-Well PCR Rack, PP

- Manufactured from high density polypropylene which is fully autoclavable. ISOLAB
- Excellent rack for "before" and "after" PCR sampling.
- This rack can be used alone or inserted in the workstation.
- This working/storage rack is designed to accommodate 96 pieces 0.2 ml PCR tubes or strips of 8 and 12 tubes.
- Tube wells are easily identified with alphanumeric, embossed numbers and letters.
- Translucent clear cover protects the tubes from dust and has a non-slip surface to allow safe storage of multiple racks.
- Dimensions (W x D x H): 125 x 88 x 31 mm

For tubes ml	PK	Cat. No.
0.2	1	6.255 804

4 96-Well PCR® Rack, Low-Temp

The PCR® rack base is made from robust ABS construction, and the lid is made from PC. Versatile Rack for use on a bench top or for freezer storage.

Heathrow Scientific

- Storing of tubes down to -80 °C
- Holds 0.2 ml individual tubes or strips
- Ambidextrous
- Detachable lid
- Stackable

For tubes ml	Colour	PK	Cat. No.
0.2	purple, blue, green, orange, yellow	5	4.666 432
0.2	blue	5	4.666 433
0.2	green	5	4.666 434
0.2	purple	5	4.666 435



1 2 PCR-Coolers

PCR-Cooler made of PP with lid made of PC. Ice-free cooling system for PCR preparation and storage of 0.2 and 0.5 ml PCR tubes and strips as well as 96 well plates in standard and low profile well shape. Maintains sample temperature of less than 5 °C for up to 3 hours (with lid off). Maintains the entire 96-well plate at a temperature of 0 °C for 1 hour. When the temperature ceiling of 6 °C has been exceeded, users are signaled by a contrasting color change of the cooler, or a single well.

Heathrow Scientific

- 2 colour options: Purple to pink or dark blue to light blue
- Ice-free cooling reduces the risk of contamination
- Fully sealed and sonic welded cooler keeps coolant contained
- Detachable lid serves also as a stand
- Lid is suitable for left and right handed users
- Ergonomic textured finger grips provide a secure hold, especially when using gloves
- Can be used for freezer storage down to -80 °C
- Alphanumeric identification
- 2 years warranty



Description	PK	Cat. No.
Pink	2	6.292 157
Blue	2	6.292 158
1 x Pink + 1 x Blue	2	6.292 159

3 PCR box and PCR rack, PP

The rack can be fitted into the box. Together, they create an ideal workstation for 0.2 ml PCR tubes, available in individual, 8-tube strip and 12 tube strip or 96-well plate formats. The box with transparent lid can be stacked to save space and is temperature resistant from -80 to +121°C. Assorted colours (red, yellow, purple, green, blue).

BRAND



Description	PK	Cat. No.
PCR-Box /-Rack	5	9.409 379

4 PCR Mini cooler, PP

With transparent lid. For protecting samples prior to warming. The mini PCR cooler keeps samples at 4 °C for approx. 3 hours. The insulating gel changes from violet to pink at 7°C. Suitable for 0.2 ml single vessels, 8-strips, 12-strips as well as 96-well PCR plates.

BRAND



Description	PK	Cat. No.
PCR Mini cooler	2	6.228 848

5 6 PCR-Coolers

The PCR-Cooler acts as a thermochromic temperature self-indicator: pink or light-blue (depending on the model chosen) when temperature exceeds +7°C, violet or dark blue when ice-cold. The new Eppendorf PCR-Cooler reliably maintains a sample temperature of 0°C* for over an hour, changing colour when the temperature exceeds +7°C. Better than an ice bath, PCR-Cooler is simple to handle, space-saving and contamination-free, making it the perfect preparation for PCR reactions. The temperature of single tubes is indicated by the colour of the respective individual apertures. Furthermore, samples are prevented from freezing by the specially developed cone contour.

Eppendorf AG

Eppendorf PCR-Cooler: the cooling unit in the universal 96-well format for 0.2ml and 0.5ml PCR tubes, for tube strips, plates and for individual tubes. The Eppendorf PCR-Cooler is a compact, innovative solution for protecting, transporting and storing sensitive samples and obviously also ideal for safely stopping reactions.

Application note:

By changing colour from violet to pink or dark blue to light blue, the PCR-Cooler shows when the temperature has exceeded +7°C. The crucial factor for sample cooling is the well colour in the PCR-Cooler.

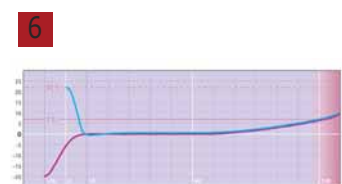

Description	PK	Cat. No.
PCR-Cooler, 0.2ml starter set (1 x pink, 1 x blue)	1	9.283 576
PCR-Cooler, 0.2ml pink	1	9.283 577
PCR-Cooler, 0.2ml blue	1	9.283 578
PCR tubes, 0.2ml, transparent	1000	9.283 579
twin.tec PCR Plate 96 semi-skirted, transparent	25	9.283 595
twin.tec PCR Plate 384 skirted, transparent	25	9.283 596

* With 2 hours precooling at -20°C.

➔ More PCR cooler, see page 794.



1 Cooling Block Systems, FreezeBox™

Blue. FreezeBox™ is a new, energy-saving, environmentally friendly and safe cooling equipment, without additives. It does not require electricity (except for pre-cooling the cores in the freezer) and no ice for low-temperature cooling of biological samples. The system can be used ice-free, is lightweight, easy to transport and ideal for the collection and storage of biological samples. It can be combined with interchangeable cores and different tube modules. Cooling cores can be tempered in a refrigerator or freezer and inserted into the FreezeBox™. For operation with dry ice, leave out the cooling core and fill with 200 g dry ice instead.

- For use with cooling core, ice or dry ice
- Easy to clean and disinfect
- Durable, suitable for frequent use
- Easy to mount

Type	Description	Dimensions (W x D x H) mm	PK	Cat. No.
FreezeBox™	with cooling core, -0.5 °C ... 4 °C and CM-01-module	152 x 170 x 123	1	4.665 848
FreezeBox™	with cooling core, -0.5 °C ... 4 °C and CM-02-module	152 x 170 x 123	1	4.665 856
FreezeBox™	with cooling core, -0.5 °C ... 4 °C and CM-03-module	152 x 170 x 123	1	4.665 857
FreezeBox™	with cooling core, -0.5 °C ... 4 °C and CM-04-module	152 x 170 x 123	1	4.665 858
FreezeBox™	with freeze core, -18 °C ... -4 °C and CM-01-module	152 x 170 x 123	1	4.665 859
FreezeBox™	with freeze core, -18 °C ... -4 °C and CM-02-module	152 x 170 x 123	1	4.665 860
FreezeBox™	with freeze core, -18 °C ... -4 °C and CM-03-module	152 x 170 x 123	1	4.665 861
FreezeBox™	with freeze core, -18 °C ... -4 °C and CM-04-module	152 x 170 x 123	1	4.665 862
FreezeBox™	Empty FreezeBox™	152 x 170 x 123	1	4.665 849
Cooling core	for -0.5 °C ... 4 °C	105 x 100 x 26	1	4.665 850
Freeze core	for -18 °C ... -4 °C	105 x 100 x 26	1	4.665 851
CM-01-module	for 30 x 2 ml tubes, Ø 12,6	119 x 101 x 38	1	4.665 852
CM-02-module	for 48 x 1.5 ml tubes, Ø 11	119 x 101 x 38	1	4.665 853
CM-03-module	for 30 x 5 ml tubes, Ø 13,5	119 x 101 x 38	1	4.665 854
CM-04-module	for 96 PCR-tubes, Ø 7	119 x 101 x 38	1	4.665 855



2 Water, nuclease-free

For use in any molecular biology application. Nuclease-free water is pure, quality-tested water suitable for use in all experiments that require nuclease-free water, including molecular biology applications. Nuclease-free water is prepared in a proprietary process, which yields DNase, RNase, and nuclease-free, deionized water without the use of chemical additives, such as diethylpyrocarbonate (DEPC). Nuclease-free water is provided in nuclease-free containers.

CHEM-LAB n.v.

NEW

Type	Nominal capacity ml	PK	Cat. No.
Water, nuclease-free	1000	1	4.675 029



3 Sample collection cards GenSaver™

Cards are designed for the collection, transport and storage of biological fluids at ambient temperature. This includes: blood, saliva, buccal cells, urine, semen, plant extracts.

Ahlstrom-Munksjö

GenSaver™: Preservation of DNA at ambient temperature for up to 20 years

GenSaver™ 2.0: Preservation of DNA at ambient temperature for up to 20 years, cells lysing and antimicrobial properties

Each product type is available in coloured and clear formats depending on sample colour.

Type	Capacity µl	Description	PK	Cat. No.
GenSaver™	125	4 spots, for blood, incl. stabilising agent	100	6.315 072
GenSaver™	125	2 spots, for blood, incl. stabilising agent	100	6.315 070
GenSaver™	125	1 spot, for blood, incl. stabilising agent	100	7.911 002
GenSaver™ Color	70	4 spots, for clear fluids, incl. stabilising agent	100	6.315 074
GenSaver™ Color	70	2 spots, for clear fluids, incl. stabilising agent	100	6.315 080
GenSaver™ Color	70	1 spot, for clear fluids, incl. stabilising agent	100	6.315 073
GenSaver™ 2.0	125	4 spots, for blood, incl. lysing and stabilising agent	100	6.315 077
GenSaver™ 2.0	125	2 spots, for blood, incl. lysing and stabilising agent	100	6.315 076
GenSaver™ 2.0	125	1 spot, for blood, incl. lysing and stabilising agent	100	6.315 078
GenSaver™ Color 2.0	70	4 spots, for clear fluids, incl. lysing and stabilising agent	100	6.315 075
GenSaver™ Color 2.0	70	2 spots, for clear fluids, incl. lysing and stabilising agent	100	6.315 071
GenSaver™ Color 2.0	70	1 spot, for clear fluids, incl. lysing and stabilising agent	100	6.315 079

Plasmid Purification-Kits I-Blue Mini/Midi

For rapid and efficient extraction of plasmid DNA from bacterial cells. *IBI Scientific*
The method is based on a combination of alkaline lysis and RNase treatment to obtain a clear lysate with minimal genomic DNA and RNA contamination. The bound plasmid DNA is washed and finally eluted by adding a buffer. The test kit contains the I-Blue Lysis Buffer, an optional colour indicator. The use of this indicator prevents common handling errors that impair efficient cell lysis and neutralization.

- Fast extraction time
- High yield
- Prevention of handling errors during cell lysis and neutralisation by I-Blue colour indicator

Specifications	I-Blue Mini Plasmid Kit // I-Blue Midi Plasmid Kit
Method:	Spin column // Anion-Exchange
Sample size:	1 - 7 ml // 50 - 100 ml high-copy plasmid/100 - 150 ml low-copy plasmid
Binding capacity:	50 µg // 500 µg
Fragment size:	1 - 15 kb // 1 - 20 kb
Typical yield:	up to 50 µg // 200 - 500 µg
Operation Time:	<15 min. // <80 min.

Type	Description	For	PK	Cat. No.
I-Blue MINI	Spin column	100 preps	1	4.661 766 1
I-Blue MINI	Spin column	300 preps	1	4.661 769
I-Blue MIDI	Gravity flow	25 preps	1	4.661 764 2



4.661 766



4.661 764

3 Gel/PCR DNA Fragment Extraction Kit

The test kit was developed to obtain or concentrate DNA fragments from agarose gels, PCR or other enzymatic processes. *IBI Scientific*
The agarose gel is dissolved, the enzymes are denatured and the DNA fragments will bind to the glass fibre matrix in the spin column. Wash buffers (containing ethanol) are used to remove contaminants and a low salt elution buffer is used to recover the purified DNA fragments. Recoveries are 90 - 95 % for PCR clean-up. With this kit, PCR purification and gel extraction procedures can be performed, so that a second test kit is not necessary.

- High recovery rate
- Short process time
- One test kit for two methods

Specifications	
Sample size:	up to 300 mg of agarose gel/up to 100 µl of PCR product
Binding capacity:	10 µg DNA
Fragment size:	<10 kb
Typical yield:	80-90% gel extraction/90-95% PCR clean-up
Operation Time:	<20 min.

For	PK	Cat. No.
100 preps	1	4.661 770
300 preps	1	4.661 771



4 Spin Columns, glass fibre filters

Spin column system consisting of filter tubes with glass fibre filter and collection tubes. *IBI Scientific*
For the use of leftover reagents from IBI I-Blue MINI Plasmidpurification-Kits (IB47170, IB47171, IB47172), Gel/PCR/DNA Fragment Extraction Kits (IB47010, IB47020, IB47030), Plasmidpurification-Kits High-Speed MINI (IB47101, IB47102) or similar products from other suppliers using a binding, washing and elution method. Sample size, binding capacity and elution volume listed in the specifications must be observed.

Specifications	Gel Fragment Extraction Kit // Plasmidpurification-Kits
Sample size:	300 mg agarose gel/100 µl PCR product // 1 - 4 ml bacterial culture
Binding capacity:	up to 10 µg // up to 30 µg
Elution volume:	20 - 50 µl // 50 - 100 µl

Type	PK	Cat. No.
MINI Hi-Speed Plasmid Columns	25	4.661 776
MINI Hi-Speed Plasmid Columns	50	4.661 777
MINI Hi-Speed Plasmid Columns	100	4.661 778
PCR / Gel DNA Fragment Extraction Columns	25	4.661 779
PCR / Gel DNA Fragment Extraction Columns	50	4.661 780
PCR / Gel DNA Fragment Extraction Columns	100	4.661 781



Genomics/DNA and RNA isolation-Thermocyclers



1 2 Micro plates Riplate® magnetic

Riplate® magnetic plates have been specially developed for the reproducible magnetic separation of DNA and proteins and can also be used for cleaning, mixing or centrifugation of samples as well as for the storage and preparation of substances. Ritter
 For the filtration of proteins as well as for DNA extraction, an automated method called magnetic separation is commonly used. The technology is based on magnetic particles which allow the fast and efficient sample preparation with high throughput. The sustainability of these products as well as reliable analysis results are ensured by the production under cleanroom conditions (class 8). The plates are in line with the SBS standard (Society for Biomolecular Screening) and have been especially developed for the magnetic separation technology.

- High resistance towards commonly used chemicals, solvents and alcohols
- High stability also during centrifugation
- Newly developed cylindrical wells enable a good bioturbation of samples
- Slightly raised rims reduce the risk of cross-contamination
- The alphanumeric code allows the registration and identification of individual samples even in confined spaces

Specifications

Total volume	
Riplate® 96 SRW magnetic 0.2 ml:	0.2 ml/Well
Riplate® 96 SRW magnetic 2 ml:	2 ml/Well
Working volume	
Riplate® 96 SRW magnetic 0.2 ml:	0 to 100 µl
Riplate® 96 SRW magnetic 2 ml:	20 to 1000 µl (with knobbed lid)

Type	PK	Cat. No.
Riplate® 96 SRW magnetic 0,2 ml	60	6.272 030
Riplate® 96 SRW magnetic 2 ml	60	6.272 031
Riplate® 96 comb	60	6.272 032

3 Thermocyclers ³PRIMEBASE/³PRIMEX/³PRIMEG

Mid-size thermocyclers - find space on any laboratory bench Techne

- Approved cyclers with new design
- With and without gradient function
- Gradient upgrade from ³PRIMEX to ³PRIMEG
- 3.5" colour touch screen with graphical display
- Height-adjustable and heatable lid, temperature from 100°C to 115°C, with ON/OFF switch and automatic switch off against overheating
- Password protected
- Auto-Restart
- USB port
- 4 years warranty for the Prime Thermocycler

Specifications

Block temperature:	+4°C to +100°C
Temperature gradient (only ³ PRIMEG or ³ PRIMEX with upgrade):	+30°C to +80°C
Max. Gradient:	+14°C
Block uniformity at 55°C:	<±0.3°C
Max. Heating rate:	3.0°C/s
Dimensions (W x D x H):	210 x 350 x 180

Type	Description	PK	Cat. No.
³ PRIMEBASE	incl. block for 18 x 0.5ml tubes	1	9.595 501
³ PRIMEBASE	incl. block for 24 x 0.2ml tubes	1	9.595 502
³ PRIMEX	incl. block for 30 x 0.5ml tubes	1	9.595 503
³ PRIMEX	incl. block for 48 x 0.2ml tubes	1	9.595 504
³ PRIME gradient upgrade	Gradient upgrade from ³ PRIMEX to ³ PRIMEG	1	9.595 505
³ PRIMEG	incl. block for 30 x 0.5ml tubes	1	9.595 506
³ PRIMEG	incl. block for 48 x 0.2ml tubes	1	9.595 507

Further models can be found in our online shop.

3



1 Real-time PCR-system Prime Pro 48

The new Prime Pro 48 real time PCR system from Techne (UK) is a high specification, economically priced real-time thermocycler. Techne
 The Prime Pro 48 system has a unique high thermal block uniformity ($\pm 0.1^{\circ}\text{C}$). This uniformity as well as validated sample volumes of down to 5 μl enable an optimized reaction run time for 40 cycles down to only 15 minutes. The uniform temperature across the plate is achieved with a unique heating and cooling system that quickly enables a uniform temperature of $\pm 0.1^{\circ}\text{C}$ in every well of the block within a fraction of a second of reaching each well temperature. This high uniformity eliminates the need for triplicates which reduces reagent running costs. Prime Pro 48 accommodates a unique and economical 48-well PCR plate, the size of which is only 1/8 the size of a standard 96-well plate. The well format mirrors a 384-well plate therefore allowing the use of a 16-channel micropipette. The small plate cuts reagent costs in half whilst still producing a strong fluorescent signal. Applications include e.g. absolute and relative quantification, Allelic Discrimination and High Resolution Melt.

Features:

- Validated volume per well: 5 to 20 μl
- High temperature uniformity of $\pm 0.1^{\circ}\text{C}$ across the whole block instantly after every temperature change
- 40 cycles in 40 minutes before optimization, and down to only 15 minutes when optimized
- Genotype in 4 minutes with over 99% accuracy
- Patented "Adaptive LED Control" minimizes optical artifacts and prevents premature detector saturation
- Dual LED excitation (452nm to 486nm and 542nm to 582nm)
- 4 emission filters (505nm to 545nm, 562nm to 596nm, 604nm to 644nm, 665nm to 705nm)
- Data is always collected in all four filters for all wells
- Distinguishes 5000 and 10000 template copies with 99 percent confidence

Additional features:

- 48-well block
- MIQE compliant
- 400 analyte specific qPCR reagent kits available
- No calibration required
- Calibrated dyes: SYBR[®], FAMTM, HEXTM, ROXTM, Cy[®]5.
- Additional dyes within the filter wavelength range are supported with no additional calibration required
- Unlimited software license
- 1 year warranty

Custom 48-well qPCR plates and corresponding seals have to be ordered separately.

Specifications

Temperature range:	30 to 100°C
Temperature stability:	$\pm 0.1^{\circ}\text{C}$
Temperature uniformity:	$\pm 0.1^{\circ}\text{C}$ within 1sec
Average ramp rate:	5.5°C/sec
Dimensions (W x D x H):	345 x 310 x 320mm
Weight:	13.6kg

Type	PK	Cat. No.
Prime Pro 48	1	9.595 515
PCR plates Prime Pro 48	50	9.595 517
Plate seals Prime Pro 48	50	9.595 516

1



1 Thermocycler Alpha Cyclers

The Alpha Cyclers family from PCRmax provides a range of features which are specifically designed to meet the needs of modern researchers when amplifying DNA. Given the flexibility in format and block options (96 or 384 well) scalability is core in the Alpha Cyclers range. Alpha Cyclers software has features such as recently used programmes, allowing users to quickly access their most commonly used protocols without the need to navigate through folders to find it, individual user logins, with protected protocols. The Alpha Cyclers systems also contain a novel programme wizard which allows users to define a protocol based specifically on their primer sequence and template source. Primer sequences or T_m 's are entered, amplicon length and source defined and the on board algorithm generates an optimised protocol for your assay. The Alpha Cyclers range of block options allow for use of the most commonly used consumables from different manufacturers and includes 96 well plates (0.2 ml), tubes (0.2 ml), strip tubes (0.2 ml) and 384 well plates.

- Single, dual or four block options available with either 96 or 384 well gradient blocks
- **Multi-block units have totally independent blocks for maximum flexibility**
- HD Android driven touchscreen interface for simplified programming
- Generate and send instrument reports to diagnose the health of your system and identify any issues before they impact users work
- Lock programs with user defined password
- Alpha Track mobile app allows remote monitoring of run progress

Alpha Track App (free of charge): Track the progress of runs and health of your system remotely via the mobile app
The Alpha Track Application is used in conjunction with your Alpha Cyclers and allows users to:

- Remotely track the progress of runs
- Send a health report for diagnosis by the technical support team
- Be notified of any issues and prevent system failures before occurring

Specifications

Block temperature:	+10 to +100 °C
Block uniformity at 55°C:	±0.3 °C
Temperature accuracy at 55°C:	±0.25 °C
Max. Heating rate:	3.4 °C/s

Type	Description	Dimensions (W x D x H) mm	Weight kg	PK	Cat. No.
AC196	1 x 96 well block	430 x 260 x 200	12	1	4.658 855
AC1384	1 x 384 well block	430 x 260 x 200	12	1	4.658 856
AC296	2 x 96 well blocks	470 x 535 x 330	30	1	4.658 857
AC2384	2 x 384 well blocks	470 x 535 x 330	30	1	4.658 858
AC2196	1 x 96 + 1 x 384 well blocks	470 x 535 x 330	30	1	4.658 859
AC496	4 x 96 well blocks	700 x 535 x 330	45	1	4.658 860
AC4384	4 x 384 well blocks	700 x 535 x 330	45	1	4.658 861
AC4196	1 x 96 + 3 x 384 well blocks	700 x 535 x 330	45	1	4.658 862
AC4296	2 x 96 + 2 x 384 well blocks	700 x 535 x 330	45	1	4.658 863
AC4396	3 x 96 + 1 x 384 well blocks	700 x 535 x 330	45	1	4.658 864

1



UV sterilisation cabinets

These UV sterilisation cabinets provide a convenient area for setting up PCR reactions in a nucleic acid free environment thus limiting PCR reaction contamination. Acting effectively as a low cost alternative to a Cleanroom, the powerful UV lights on the cabinets denature nucleic acids in 5 to 30 minutes making them unsuitable for amplification. The cabinet incorporates safety features to prevent user exposure to UV light. The UV lights themselves are timer controlled and there are safety switches on the cabinets doors which turn off the UV lights when opened. Constructed from 10 mm acrylic, the cabinets also act as efficient shields from beta radiation emissions and can therefore be safely used with isotopes such as ³²P.

Cleaver Scientific



9.584 775

Specifications

UV Lights:	Maxi/Midi/Mini
White Lights:	4 x 15 W
Dimensions (H x W x D):	15
Weight:	770 x 580 x 420 mm/620 x 580 x 420 mm/450 x 580 x 350 mm
	19 kg/14.6 kg/12 kg

Description

Description	PK	Cat. No.
UV sterilisation cabinets Maxi with timer, four UV lights and white light	1	9.584 774
UV sterilisation cabinets Midi with timer, four UV lights and white light	1	4.670 734
UV sterilisation cabinets Mini with timer, UV light and white light	1	9.584 775
General purpose tray white, 680 x 540 mm	1	6.258 034
Radiation hazard tray yellow, 680 x 540 mm	1	9.584 788

UV/PCR cabinets UVT-B-AR/UVT-S-AR/UVC/T-M-AR

Bench-top models for protection against contamination during a variety of DNA/RNA procedures. *Grant*

- UV surface irradiation, via 1 x 25 W 254 nm open UV lamp or 2 x 30 W open UV lamp (UVT-S-AR)
- Patented high intensity UV air cleaner, 25 m³/hour cleaner-recirculator continuous air flow with 1cm UV irradiation distance
- UV lamp in the upper hood disinfects the working area, inactivating DNA/RNA fragments during 15-30 min of exposure
- UV exposure control, 24 hour digital timer
- Convenient, easy to use digital timer for accurate control of UV exposure
- White lamp provides local illumination of the workplace to optimise visual control during operations
- Shock proof glass panels, metal framework and stainless steel work surface
- Automatic switch-off of open UV light when door opened
- UVT-B-AR is available with 1 x access port or 1 x internal power socket, UVT-S-AR with 3 x internal power socket, UVC/T-M-AR with 1 x access port



9.721 070

Type	External dimensions (W x D x H) mm	Internal dimensions (W x D x H) mm	Weight kg	PK	Cat. No.
UVT-B-AR, with access port	690 x 585 x 555	650 x 475 x 450	32	1	6.284 214
UVT-B-AR, with internal socket	690 x 585 x 555	650 x 475 x 450	32	1	9.721 070
UVT-S-AR	1245 x 585 x 555	1200 x 520 x 425	31	1	6.237 057
UVC/T-M-AR	690 x 515 x 555	650 x 475 x 450	58	1	7.970 866



6.237 057

4 PCR Cabinets Type Streamline®/Airstream®

Active PCR Cabinet with built-in UV Decontamination and true vertical laminar airflow. *ESCO*

- Average Airflow Velocity (adjustable): 0.3 m/s
- HEPA filter with pre-filter
- The air cleanliness within the work zone is better than ISO Class 5
- Sentinel-Microprocessor maintains steady blower speed (only 0.9 m and 1.2 m models)
- Hinged polycarbonate front window
- Tempered glass side panel
- ISOCIDE™ antimicrobial coating on all painted surfaces minimizes contamination.
- Fluorescent lighting provides superior illumination of the work zone
- Build-in UV lamp with timer
- Pass-through ports in the back wall

Options on request:
Support stands, installation

Type	Size	External dimensions (W x D x H) mm	Internal dimensions (W x D x H) mm	PK	Cat. No.
Streamline® SCR-2A1	0.6 m	730 x 617 x 950	630 x 538 x 550	1	4.658 988
Airstream® PCR-3A1	0.9 m	1035 x 617 x 950	935 x 538 x 550	1	4.658 783
Airstream® PCR-4A1	1.2 m	1340 x 617 x 950	1240 x 538 x 550	1	4.658 998





1 Gel electrophoresis tank MultiSUB Mini

The MultiSUB Mini is the smallest unit in the range, designed for low to medium numbers of samples. The cost-effective small gel size does not compromise versatility as two tray options are available: 7 x 7 cm and 7 x 10 cm. Easy preparation up to 16 samples. Simply by altering the gel tray or comb, this compact unit is capable of resolving up to 64 different samples, prepping 1ml of sample or separating sample bands over a distance of 9 cm. *Cleaver Scientific*

Supplied with:

MultiSUB Mini 7: 7 x 7 cm UV Tray, 2 x 8 sample combs.
 MultiSUB Mini 10: 7 x 10 cm UV Tray, 2 x 8 sample combs.
 MultiSUB Mini DUO: 7 x 7 cm and 7 x 10 cm UV Tray, 2 x 8 sample combs.
 Set: MultiSUB Mini DUO + Power supply OmniPAC, MINi 300 V 400mA 60 W, 110/230 V.
 Each model has an additional loading guides and dams.

Specifications

Gel dimensions (W x L): 7 x 7cm and 7 x 10 cm
 Unit dimensions (W x L x H): 21 x 9 x 9 cm
 Max. sample capacity: 7 x 7 cm tray, 32 samples
 7 x 10 cm tray, 64 samples
 Buffer volume: 225 ml

Description	PK	Cat. No.
MultiSUB Mini 7	1	6.258 373
MultiSUB Mini 10	1	9.584 650
MultiSUB Mini DUO	1	7.920 043
MS Mini DUO Nano 300 incl. CSL-AG100, CSL-Loaddye, CSL-MDNA-1kb	1	7.971 555

2



2 3 Gel electrophoresis tank MultiSUB Choice

Gel size: 15 x 15 cm (W x L). This unit is ideal for restriction fragment analysis, sample prep or checking of high number of samples. The MultiSUB Choice offers a high degree of versatility. Two additional tray options are available: 15 x 7 cm and 15 x 10 cm. *Cleaver Scientific*

- Colour coded combs 0.75/1.0/1.5/2.0 mm
- 3, 4 or 6 comb positions for maximum 210 samples
- Low buffer volume: 500 ml
- Simple gel casting by using dams

Supplied with:

MultiSUB Choice 7: 15 x 7 cm UV tray, 2 x 20 sample combs.
 MultiSUB Choice 10: 15 x 10 cm UV tray, 2 x 20 sample combs.
 MultiSUB Choice 15: 15 x 15 cm UV tray, 2 x 20 sample combs.
 MultiSUB Choice Trio: 15 x 7, 10 and 15 cm UV tray, 2 x 20 sample combs.
 MultiSUB Choice Trio 15: 15 x 15 cm UV tray, 2 x 20 sample combs.
 MultiSUB Choice Stretch 20: 15 x 20 cm UV tray, 4 x 28 sample combs.
 MultiSUB Choice Stretch 25: 15 x 25 cm UV tray, 4 x 28 sample combs.
 Each model has an additional loading guides and dams.

3



Specifications

Unit dimensions (w x l x h): 26.5 x 17.5 x 9 cm
 41 x 17.5 x 9 cm (Stretch models)
 Max. sample: 15 x 7 cm Tray - 70 Samples
 15 x 10 cm Tray - 140 Samples
 15 x 15 cm Tray - 210 Samples
 15 x 20 cm Tray - 280 Samples
 15 x 25 cm Tray - 350 Samples
 Buffer volume: 500 ml
 1000 ml (Stretch models)

Description	PK	Cat. No.
MultiSUB Choice 7	1	6.264 824
MultiSUB Choice 10	1	7.655 972
MultiSUB Choice 15	1	9.584 651
MultiSUB Choice Trio	1	6.239 273
MultiSUB Choice Trio 15	1	7.629 932
MultiSUB Choice Stretch 20	1	9.584 663
MultiSUB Choice Stretch 25	1	9.584 664

Suitable accessories can be found in our online shop.

1 Gel electrophoresis tank MultiSUB Midi

Extending only the width of this unit allows more samples to be resolved per gel than the MultiSUB Mini without a significant increase in buffer or gel volumes. A maximum of 100 samples per gel can be resolved making this unit ideal for those routinely checking medium numbers of samples over short to medium gel run lengths.

Cleaver Scientific



Supplied with:

MultiSUB Midi 7: 10 x 7 cm UV tray, 2 x 16 sample combs.
MultiSUB Midi 10: 10 x 10 cm UV tray, 2 x 16 sample combs.
MultiSUB Midi DUO: 10 x 7 cm + 10 x 10 cm UV tray, 2 x 16 sample combs.
Each model has additional loading guides and dams.

Specifications

Gel dimensions (W x L): 10 x 7 cm and 10 x 10 cm
Unit dimensions (W x L x H): 22 x 12.5 x 9 cm
Max. sample capacity: 10 x 7 cm tray, 50 samples
10 x 10 cm tray, 100 samples
Buffer volume: 300 ml

Description	PK	Cat. No.
MultiSUB Midi 10	1	6.228 823
MultiSUB Midi DUO	1	6.238 115

2 Gel electrophoresis tank MultiSUB Maxi

The MultiSUB Maxi is primarily designed for resolution of high numbers of samples such as from Cloning or PCR. The MultiSUB Maxi allows ultra high-resolution separations over extended runs. Tray sizes correspond to standard blotter sizes. It also allows easy sample transfer onto a membrane for further analysis. Four gel tray sizes are available: 20 x 10 cm, 20 x 15 cm, 20 x 20 cm and 20 x 25 cm. Multichannel pipette compatible, 40 combs facilitates speed loading of up to 440 samples per gel. 50 sample combs allow maximum sample capacity of 550 samples per gel.

Cleaver Scientific



Supplied with:

MultiSUB Maxi 15: 20 x 15 cm UV Tray, 2 x 20 sample, 1 mm thick combs.
MultiSUB Maxi 20: 20 x 20 cm UV Tray, 2 x 20 sample, 1 mm thick combs.
MultiSUB Maxi DUO: 20 x 10 + 20 x 20 cm UV Tray, 2 x 20 sample, 1 mm thick combs.
MultiSUB Maxi 25: 20 x 25 cm UV Tray, 2 x 20 sample, 1 mm thick combs.
Each model has an additional casting dams and loading guides.

Specifications

Gel dimensions (w x l): 10 x 7 cm and 10 x 10 cm
Unit dimensions (w x l x h): 22 x 12.5 x 9 cm
Max. sample capacity: 20 x 10 cm tray, 200 samples
20 x 15 cm tray, 350 samples
20 x 20 cm tray, 450 samples
20 x 25 cm tray, 550 samples
Buffer volume: 1500 ml

Description	PK	Cat. No.
MultiSUB Maxi 15	1	7.673 115
MultiSUB Maxi 20	1	6.261 058
MultiSUB Maxi 25	1	9.584 671
MultiSUB Maxi DUO	1	9.584 670

Suitable accessories can be found in our online shop.

3 Power supply nanoPAC-300 Mini for gel electrophoresis tanks

The nanoPAC-300 is capable of running all Cleaver Scientific horizontal multiSUB™ systems and vertical omniPAGE mini gel systems.

Cleaver Scientific



- Maximum constant current output of 400mA
- Simple two step feature to set a programmable change in voltage, current and time during the run
- Constant voltage up to 300 V
- Adjustable in 1 V and 1 mA increments
- Two parallel outputs
- Continuous run or timed setting up to 999 minutes
- Automatic safety shutdown
- Alarm function
- Easy-to-clean polycarbonate housing
- 3-digit LED display

Type	Rating	Supply requirements	PK	Cat. No.
nanoPAC-300P Mini	60 W	300 V / 400 mA	1	6.272 711

1

1 Enduro™ power supplies

Dependable performance, intelligent control, for the connection of different chamber systems. Ideal for DNA, RNA and protein electrophoresis as well as blotting.

Labnet

- Simple to program
- Select constant voltage or constant current mode
- Compact, lightweight and stackable
- Extremely quiet operation

Specifications

Output voltage range/increments:

Timer:

Programmable:

Dimensions:

Weight:

Input voltage:

Output voltage range/increments:

Timer:

Programmable:

Dimensions:

Weight:

Input voltage:

Model 300 V

2 ... 300 V/1 V

4 ... 500 mA/1 mA

90 W max/na

1 min to 99 h 59 min or continuous

No

190 x 250 x 80 mm

2.2 kg

120-230 V

Model 250 V

5 ... 250 V/1 V

10 ... 3.000 mA/10 mA

1 ... 300 W/1 W

1 min to 99 h 59 min or continuous

10 steps/program, 20 program memory

190 x 250 x 80 mm

2.5 kg

120 ... 230 V

Description	PK	Cat. No.
Enduro 300 V power supply	1	9.595 314
Enduro 250 V power supply	1	9.595 306

Additional accessories are available.

2

2 Agarose for gel electrophoresis

This agaroses are suitable for routine analysis of nucleic acids. They combine tensile strength with low electroendosmotic effects to achieve high resolving power for a wide size range of nucleic acid fragments. AG agaroses are also very environmentally friendly, being manufactured by a process which excludes organic solvents. Also available as low melting point agarose for nucleic acid recovery and enzymatic applications (Cat. No. 4.658 455) and as High Resolution PCR grade agarose for separation of small DNA fragments of up to 800 bp (Cat. No. 6.270 615). Other packing sizes on request.

Cleaver Scientific

Specifications

CAS:

Appearance:

EEO:

Gelling Point:

Melting Point:

Solubility:

Moisture:

Gel Strength:

Sulphate:

DNase, RNase, Protease,

Endonuclease:

AG | LMA | HRA

9012-36-6 | 39346-81-1 | 39346-81-1

White to off-white powder

≤ 0.13 % | ≤ 0.1 % | ≤ 0.1%

36 °C ±1.5°C (1.5 % gel) | 26-30 °C (1.5 % gel) | ≤ 33 °C (1.5 % gel)

88 °C ±1.5°C (1.5 % gel) | ≤ 65 °C (1.5 % gel) | ≤ 70 °C (1.5 % gel)

Clear, colourless solution at 1g in 100ml water

< 10 %

≥ 1200 g/cm² (1% gel) | ≥ 200 g/cm² (1% gel) | ≥ 750 g/cm² (1.5% gel)

< 0.20 % | ≤ 0.1 % | ≤ 0.1 %

None Detected

Type	Capacity g	PK	Cat. No.
CSL-AG100	100	1	9.584 695
CSL-AG500	500	1	9.584 696
CSL-AG1000	2 x 500	1	9.584 697
CSL-LMA50	50	1	4.658 455
CSL-HRA100	100	1	6.270 615

DNA Markers for Gel Electrophoresis

The ready-to-use DNA markers run precisely and produce a sharp, well defined ladder. They are available in six molecular weight ranges. The markers contain high intensity reference bands and may be used to perform size comparisons with DNA molecules ranging from the smallest of PCR fragments to large, linearised cosmid vectors.

Cleaver Scientific

- Up to 19 bands
- Isolated from restrictive plasmids
- 6 months stable at room temperature
- 12 months shelf life at 4 °C
- 24 months storable at -20 °C
- Vials of 500 µl

Type	Size	Bands	Reference bands	PK	Cat. No.
CSL-MDNA-50BP	50 bp - 1500 bp	17	200 bp, 500 bp	1	6.256 963
CSL-MDNA-100BP	100 bp - 1500 bp	11	500 bp, 1500 bp	1	6.256 961
CSL-MDNA-100BPH	100 bp - 3000 bp	12	500 bp, 1500 bp	1	6.256 960
CSL-MDNA-BR	100 bp - 10 Kb (Broad Range)	19	500 bp, 1.5 Kb, 3 Kb	1	6.256 964
CSL-MDNA-1KBPLUS	100 bp - 10 Kb	13	1 Kb, 3 Kb	1	4.669 511
CSL-MDNA-HR	250 bp - 25 Kb (High Range)	14	1 Kb, 3 Kb	1	6.256 965

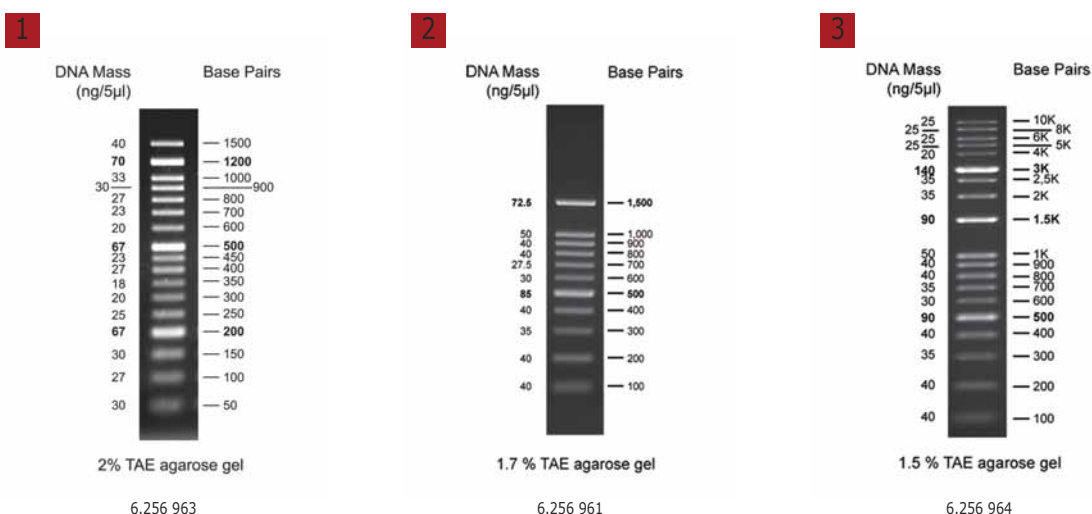

4 DNA stain proBLUE

Simple and fast staining of DNA fragments post agarose electrophoresis.

Cleaver Scientific

- Methylene blue stain as 10x concentrate
- Visibility of DNA as a blue band
- Binds to negatively charged DNA

Type	Capacity ml	PK	Cat. No.
proBLUE	120	10	4.661 309



DNA Loading Dyes

Orange G dye contains sucrose and xylene cyanol.

Cleaver Scientific

Bromophenol blue is the standard dye for electrophoresis, with a dark blue colour.

- Tracking dyes for monitoring electrophoresis runs
- The charge-to-mass ratio allows to co-migrate with small molecules in agarose and PAGE gels
- Vials of 1 ml

Type	Package contents	PK	Cat. No.
CSL-ORANGEDYE-Orange G	1 Vial	10	4.661 308
CSL-LOADDYE-bromophenolblue	10 Vials	1	6.257 263



6.257 263



1 UV lamps

- Filtered and unfiltered(*) UV lamps with different wave lengths and power levels for a broad range of applications
- Models with wave length selector suited for multiple applications
- Electronic ballast (ECG), flicker-free, low-maintenance

Vilber Lourmat

Further models on request.

Note: please order lamp holder separately.

Type	Description	Filter size mm	Wave-length nm	Power W	PK	Cat. No.
BVL-6.L	Single wavelength	145 x 48	365	1 x 6	1	7.910 047
BVL-6.LC	wavelength selector	145 x 48	365 / 254	1 x 6	1	9.971 918
BVL-115.L	Single wavelength	295 x 66	365	1 x 15	1	9.971 936
BVL-215.G*	UV sterilization lamp	495 x 120	254	2 x 15	1	9.971 915
BVL-206.G*	UV sterilization lamp	155 x 70	254	2 x 6	1	4.675 301
BVL-215.L	Single wavelength	295 x 76	365	2 x 15	1	4.675 302

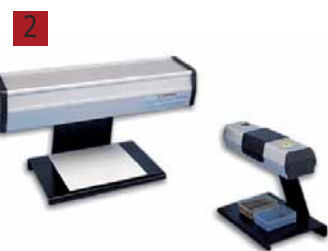

2 Lamp holder for UV lamps

Vilber Lourmat

Type	For Type	PK	Cat. No.
SVL-6	BVL-6	1	9.971 921
SVL-30	BVL-115, BVL-215	1	9.971 922



3 Handle for UV lamps

Vilber Lourmat

Type	For Type	Mounting	PK	Cat. No.
SMU	BVL-6	clip	1	9.971 938
SMA	BVL-6	handle	1	6.230 416



4 Blue- and white light LED-Transilluminators

NEW
Cleaver Scientific

Powerful LED lighting arrays for blue (470 nm) and white (broad wavelength) illumination to image fluorescent and colorimetric gels. Through LED lights no ageing of UV bulbs and because of the inbuilt white LED array a separate white light table is not necessary. Well suited for teaching labs in universities and schools. Compatible with blue light excited safe DNA stains, as well as traditional stains such as ethidium bromide.

- Magnetic filter compatible with wide range of DNA stains
- 3 level adjustable LED intensity
- Bottom up illumination provides even sample illumination
- Automatic power-off to prevent heat build-up
- High quality aluminium housing

Scope of supply:

Transilluminator, orange hinged filter, paper hood

Specifications

Wavelength:	470 nm + white light
Viewing size:	120 x 180 mm
Dimensions (W x D x H):	220 x 185 x 30 mm
Input voltage:	12 V, 2 A
Power supply:	110 ... 240 V

Type	PK	Cat. No.
proBLUEVIEW	1	4.670 749

1 Blue light LED-Transilluminators runVIEW MINI **NEW**

The Mini-Blue light Transilluminator uses harmless blue light to illuminate both traditional Ethidium bromide stained gels as well as safe stains. Slotting under any gel tank, but perfect for our MINI and MIDI sized multiSUB gel tanks. With orange filter window to visualise DNA in real time within gel tanks, perfect for quickly checking PCR fidelity and restriction digest results. The device can also be used as a stand-alone transilluminator with the gel placed directly on the illuminator.

- High intensity blue LED illuminator allows visualisation of a wide range of fluorescent gel stains
- Compatible with runSAFE, commercial safe stains and ethidium bromide

Scope of supply: Transilluminator, Filter (orange)

Specifications

Wavelength:	470 nm
Viewing size:	112 x 75 mm
Dimensions (W x D x H):	86 x 170 x 25 mm
Weight:	338 g
Power supply:	DC 12 V, 2 A

Type	PK	Cat. No.
runVIEW MINI	1	6.313 471



2 UV transilluminators

Standard features include a high/low intensity safety switch and an efficient starter that allows each of the six 8W UV tubes to energise quickly without flickering, while special filter glass minimises unwanted background light. All of these features maximise contrast and sensitivity, allowing even the faintest fluorescent gels to be viewed.

Type	Filter size mm	Wave-length nm	Tubes	Spare tubes		PK	Cat. No.
				Type	Type		
CSLUVTS254	210 x 210	254	6 x 8W	F		1	9.584 770
CSLUVTS312	210 x 210	312	6 x 8W	E		1	6.231 832
CSLUVTS365	210 x 210	365	6 x 8W	G		1	9.584 771
CSLUVTSDUO	210 x 210	254/365	6 x 8W	F / G		1	9.584 772
CSLUVTSDUO312	210 x 210	254/312	6 x 8W	F / E		1	9.584 773



3 Compact UV transilluminators

- Compact design
- Metal housing, with stainless steel filter frame and "long life" filter
- Modern technology, highest quality manufacture
- Single or dual wavelength models available
- BECXF models have intensity selector (Hi/Lo)

Type	Description	Filter size mm	Wave-length nm	No. of Tubes	Tubes		PK	Cat. No.
					W	W		
ECX-F15.M V1	Hi / Lo Intensity	150 x 150	312	4	8		1	6.260 573
BECX-F20.M V1	Hi / Lo Intensity	200 x 200	312	5	8		1	9.971 910
BECX-F26.M V1	Hi / Lo Intensity	210 x 260	312	5	8		1	9.971 911
BTCP-20.LM V1	Multi-band	200 x 200	365 / 312	5 / 4	8		1	9.971 912
BTCP-20.MC V1	Multi-band	200 x 200	254 / 312	5 / 4	8		1	9.971 913
BTCP-26.LM V1	Multi-band	210 x 260	365 / 312	5 / 4	8		1	9.971 914



Spare tubes for UV Instruments and UV Lamps

Suitable for all instruments from Vilber Lourmat. Vilber Lourmat

Type	Tubes W	Wave-length nm	PK	Cat. No.
T-6.C	6	254	1	4.675 306
T-6.L	6	365	1	4.675 303
T-8.C	8	254	1	4.675 307
T-8.M	8	312	1	4.675 304
T-8.L	8	365	1	4.675 308
T-15.C	15	254	1	4.675 309
T-15.M	15	312	1	4.675 310
T-15.L	15	365	1	4.675 311

1



2



1 2 Gel Documentation System omniDOC

The omniDOC offers high performance gel documentation and analysis at a relatively low cost. *Cleaver Scientific*
A high resolution 5 mega pixel camera with slide-out UV transilluminator, and optional blue epi-illumination module and white light table, makes the omniDOC suitable for imaging most fluorescent and colorimetric gels.

OMNIDOC features:

- Pre-focused 5 mega pixel camera with auto-exposure for almost instantaneous high resolution gel imaging; CMOS sensor for improved light sensitivity
- 6mm lens, F1.2 aperture size, with manual adjustment
- Interchangeable 4 positions filter wheel with 620 nm ethidium bromide filter as standard; 520, 560, 580 nm and neutral density filter options available for runSAFE, SYBR stain and other fluorescence applications
- Viewing pane with universal amber filter for gel inspection, which may be covered by a spring-loaded panel during documentation
- Internal white LED - aids gel positioning and focusing
- Slide-out 312 nm transilluminator; uses optional plug-in white light table for coomassie, silver-stain and other colorimetric gels
- Large 210 x 260 mm filter area
- Dark room assembly with corrosion resistant ABS construction
- Safety switch prevents accidental UV exposure when opening front door panel

omniDOCSAFE: omniDOC plus blue LED Epi-illumination and 520, 560, 580 nm and neutral density filters.

omniDOCPROSAFE: omniDOC plus blue LED Epi-illumination, 520, 560, 580 nm and neutral density filters and white light table.

Type	Description	PK	Cat. No.
OMNIDOC	with 620nm (EtBr) emission filter, 312nm UV transilluminator and USB cable	1	6.263 221
OMNIDOCSAFE	as OMNIDOC plus Blue LED Epi-illumination Module, and 520, 560, 580 nm and neutral density filters	1	6.265 278
OMNIDOCPROSAFE	as OMNIDOC plus Blue LED Epi-illumination Module, and 520, 560, 580 nm and neutral density filters and white light table	1	7.982 838

3



3 Gel documentation system gelLITE-E60



Compact gel documentation system for agarose gels and stained protein gels. Suitable for *Cleaver Scientific*
fluorescent and stained agarose gels, spot and colony counting, Coomassie stained protein gels, GFP plant imaging, molecular weight analysis of DNA agarose gels and protein gels as well as autoradiography imaging. A 302 nm UV transilluminator enables imaging of large format agarose gels or stained protein gels up to 20 x 20 cm. A 5-megapixel camera gives low light sensitivity for clear resolution of closely spaced DNA bands and ensures low levels of fluorescence are detected. With intuitive genePIX acquisition software for an efficient workflow.

- High-resolution 5 megapixel camera with 16 bit image depth and 65536 grey levels
- Manually controlled camera zoom and focus
- Image of all commercially available DNA and protein stains
- GenePIX software for acquisition and analysis
- USB connection to PC

Scope of supply:

Darkroom, camera, UV transilluminator, converter screen, UV emission filter, license free acquisition and analysis software

Specifications

Resolution:	5 megapixels
Lens:	Manual zoom 6.5 - 39, F1.4
Sensor bit-depth:	12/16 bit
Greyscales:	4096/65536
Transilluminator wavelength:	302 nm
Transilluminator size:	200 x 200 mm
Dimensions (H x D x W):	620 x 375 x 400 mm
Power supply:	230 V/60 Hz

Type	PK	Cat. No.
gelLITE-E60	1	4.670 735

Further models can be found in our online shop.

E & OE.

1 Gel Documentation System Doc-Print CX3

1

Doc-Print CX3 is a stand-alone system with a small footprint that doesn't need a computer. The free VisionCapt software guarantees full GLP compliance. Molecular weight calculation, band quantification, colony counting, distance calculation, text annotations and image enhancement are included.

Vilber Lourmat

- Field of view: 24 x 18 cm
- Scientific grade camera - Made in Germany
- 3 megapixel resolution (extendable to 20 megapixels)
- Auto-exposure
- 16-bit - 65 536 grey levels
- Passive cooling
- USB 3 connection
- Large 12.6" touchscreen interface display
- Self-understandable user interface
- Print or save on an external drive via the USB port
- Connection of a thermal printer possible



All models include the following standard components: Imaging unit with touch display and software, camera, zoom objective, UV-/vis F-590 Filter and dark hood.

Type	PK	Cat. No.
DOC-Print CX3 - standard components	1	9.971 948
DP CX3-P - standard components + grey-level thermal printer	1	9.971 949
DP CX3-20.M - standard components + UV transilluminator	1	9.971 950
DP CX3-P-20.M - standard components + grey-level thermal printer and UV transilluminator	1	9.971 951

2 Gel documentation system UVI doc-HD6

NEW

2

PC-independent gel documentation system with a compact darkroom made of metal

Vilber Lourmat

- Large, good readable touch display (12.2")
- High resolution scientific camera with motorized 6x zoom objective
- High recording quality (6 MP, 16 bit)
- Automated image recording
- Darkroom, three position filter wheel, LED incident light, integrated UV-table (20x20 cm) with full pullout and automatic safety shutdown
- USB port for data transfer
- Free analysis software

Specifications

Resolution:	6 megapixels
Extended resolution:	10 megapixels
Lens:	6x zoom objective
Sensor bit-depth:	16 bit
Greyscales:	65535
Dynamic range:	>4.0 OD
Transilluminator wavelength:	312 nm
Transilluminator size:	200 x 200 mm
Dimensions (W x D x H):	380 x 475 x 785 mm
Weight:	33 kg

Type	PK	Cat. No.
UVI doc-HD6	1	4.667 667



1 Vacuum concentrator, Concentrator plus™

The new Concentrator plus features a new LCD display and user-friendly control panel with clearly labeled function keys.

Eppendorf AG

The new Concentrator plus from Eppendorf is available in two configurations:

- Complete system with an integrated service-free diaphragm pump
- Basic concentrator for connecting to an existing vacuum.

The Concentrator's heating technology optimises the evaporation process. No matter which configuration you choose, you're assured of quick and efficient-yet gentle-vacuum concentration of your samples (e.g. DNA/RNA, proteins). The complete system includes a vapour condenser that purifies the exhaust air by up to 85%. This serves as protection against unpleasant vapours.

Specifications

Specifications	Complete system/Basic device
Max. power consumption:	350W/150W
Dimensions (W x D x H):	33cm x 58cm x 29cm/33cm x 37cm x 23cm
Weight:	31.5 kg/16.5 kg
Vacuum:	20hPa (20mbar)
Fixed rotation speed:	1.400rpm
Tube sizes:	0.2ml - 50ml
Capacity:	max. 144 tubes 2 microplates

Description	PK	Cat. No.
Complete system with integr. membrane vacuum pump and 48 x 1.5ml / 2.0ml fixed angle rotor	1	9.776 620
Complete system with integr. membrane vacuum pump, with connection for external units	1	9.776 621
Complete system with integr. membrane vacuum pump, w/o rotor	1	9.776 622
Single unit with 48 x 1.5ml / 2.0ml fixed angle rotor	1	9.776 623



9.776 623

3



3 Electroporator Eporator®

The Eppendorf Eporator® is a compact device for the fast and controlled electroporation of bacteria, yeasts and other microorganisms. Mainly for the insertion of plasmid DNA, but also RNA, proteins and all other small molecules.

Eppendorf AG

- One-button operation
- Integrated cuvette holder
- Self-explanatory due to display-controlled operation
- Frequently used parameter settings programmable
- USB interface for data transfer and GLP-supporting documentation

Specifications

Resistance:	600 ohm
Condenser:	10 µF
Time constant:	5 ms
Dimensions (W x D x H):	19 x 27.5 x 12.5 cm
Weight:	3.2 kg
Charging voltage:	200 - 2500 V
Power supply:	230 V, 50 - 60 Hz

Type	PK	Cat. No.
Eporator	1	6.285 780

1 Electroporation System ECM® 399

The ECM® 399 is an electroporation system for the simple transformation of bacteria and yeast cells. It produces exponential decay waves and is designed to deliver the field strengths and pulse lengths required for transformations. The ECM® 399 is ideal for basic transformation in research and academic environments. It is easy to operate, cost effective, compact in size and portable.

Harvard Apparatus

1



Applications: Transformation of bacteria, yeast, fungus.

Scope of supply: Generator ECM® 399 , PEP cuvette holder, Cuvettes 1 mm, 2 mm, 4 mm (10 each) and Cuvette Rack

Specifications

Capacity/Resistance Range:

LV Mode: 1050 µF/150 Ohm, fixed

HV Mode: 36 µF/150 Ohm, fixed

Max. Voltage Output: 2500 V (Peak)

Pulse Interval: 100 ms to 10 s

Charge Time: max. 5 s

Max. Pulse Length: 125 ms at 500 V (Peak)

or 5 ms at 2500 V (Peak)

Display: 16-character, liquid crystal, LCD backlit

Interface: Digital User Interface

Relative Humidity: 60 %

Power supply: 100 - 240 V, 50/60 Hz

Type	PK	Cat. No.
BTX ECM 399	1	6.274 057

2 Electroporation cuvettes Plus

BTX Cuvettes Plus are designed for use in electroporation and electrofusion of bacteria, yeast, insect, plant and mammalian cells. Each sterilized Cuvettes Plus package includes a disposable cuvette and a transfer pipette, which is used for removal of the sample after electroporation. The cuvettes are molded with embedded polished aluminum electrodes, and gamma irradiated for guaranteed sterility.

Harvard Apparatus

2



Three electrode gap sizes are available:

- 1mm for bacteria and yeast
- 2mm for all cell types
- 4mm for mammalian cells

BTX cuvette can obtain high field strengths up to 25.0 kV/cm. Round caps are leak resistant and allow for quick and easy removal. For research use only. Can be used with electroporation systems from different manufacturers (not suitable for units from Eppendorf).

Colour Cap	Volume max. µl	Volume min. µl	Gap mm	PK	Cat. No.
Grey	90	20	1.0	10	6.282 777
Blue	400	40	2.0	10	6.282 778
Yellow	800	80	4.0	10	6.282 779
Grey	90	20	1.0	50	6.282 773
Blue	400	40	2.0	50	6.282 774
Yellow	800	80	4.0	50	6.282 775



BRANDplates® - A complete premium-quality line - for every application!

Microplates for Immunoassays (non-sterile)

Diagnosis of disease, pregnancy or verification of doping substances - many analyses in the modern laboratory are performed with immunological assays in microplates. They are characterized by their high specificity and provide the opportunity to detect the lowest concentrations of defined substances in complex liquids e.g. blood serum.

immunoGrade™ (high binding)

Optimized for the immobilization of IgG, highest binding capacity for molecules with mixed hydrophilic and hydrophobic regions. The surface of choice for the majority of standard ELISAs.

hydroGrade™

Strongly hydrophilic, high affinity to hydrophilic molecules like e.g., glycoproteins and peptides, antibodies with predominantly hydrophilic regions and nucleic acids.

lipoGrade™

Strongly hydrophobic (lipophilic), immobilization of biomolecules with predominantly hydrophobic regions. An alternative to the immunoGrade™ surface for the immobilization of molecules, e.g. lipoproteins or peptides.

HydroGrade™ and lipoGrade™ can be found in the online shop.

Non-treated (sterile or non-sterile)

Non-treated PS microplates are used in the most diversified application fields, e.g. homogenous standard assays and extensive screening assays. The hydrophobic characteristics of untreated PS are often of use in performing these applications! The new BRANDplates® range contains two types of non-treated microplates:

pureGrade™ (medium binding)

Non-treated, non-sterile surface. The standard plate for most applications. Particularly applicable for homogenous assays, screening, and in the field of storage.

pureGrade™ S

Non-treated surface, sterile. Sterilized via β-radiation. Especially suited for bacteriological assays.

Colours, wells and shapes:

- 96- and 384-well format
- standard or transparent bottom
- transparent, white or black
- Various well bottom shapes: U-, V-, F-, C-bottom for 96-well format
- clearly distinguishable via color code: blue embossed alphanumeric coding for 96-well standard plates.
- free from endotoxins (< 0.01 EU/ml), DNase, DNA, RNase, non-cytotoxic (according to ISO 10993)
- ANSI/SLAS format

- **non-sterile products without lid, please order separately**

- **sterile products comply with ISO 11137 and AAMI guidelines. A SAL of 10⁻⁶ is reached. Supplied individually wrapped with lid.**

Get yourself familiar with the new range by using the BRANDplates® selection guide under www.brand.de.

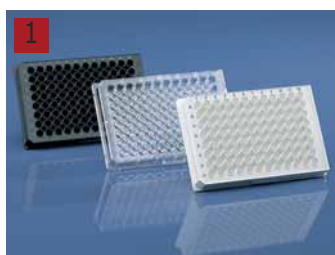

1 ImmunoGrade™ (high binding)

PS, non-sterile. Optimized for the immobilization of IgG, standard ELISA assay.
384 Well platform on request.

BRAND

Description	Bottom shape/ Well volume µl	PK	Cat. No.
96-well, transparent	U / 330	100	4.000 275
96-well, transparent	V / 360	100	4.000 276
96-well, transparent	F / 350	100	4.000 277
96-well, white	U / 330	100	4.000 279
96-well, black	U / 330	100	4.000 281
96-well, black, transparent bottom	F / 330	100	4.000 282
96-well, black, transparent bottom	F / 330	5	7.644 453



1 pureGrade™ (medium binding)

PS. Non-treated, non-sterile.
For homogenous assays, screenings, storage, etc.
Other formats (384 well or 1536 well) on request or in the webshop.

BRAND

Description	Bottom shape/ Well volume µl	PK	Cat. No.
96-well, transparent	U / 330	100	4.000 238
96-well, transparent	V / 360	100	6.233 851
96-well, transparent	F / 350	100	6.231 785
96-well, transparent	C / 350	100	4.000 239
96-well, white	U / 330	100	4.000 240
96-well, white	F / 350	100	6.233 548
96-well, black	U / 330	100	4.000 241
96-well, black	F / 350	100	6.233 756
96-well, white, transparent bottom	F / 330	100	4.000 242
96-well, black, transparent bottom	F / 330	100	4.000 243
96-well, UV-transparent*	F / 350	50	9.408 976
96-well, UV-transparent*	F / 350	50	6.272 014

*slightly hydrophilised, bottom UV-transparent foil, 25 µm wall thickness, frame PS, transmission at 240 nm is 80%, not available in USA and Japan

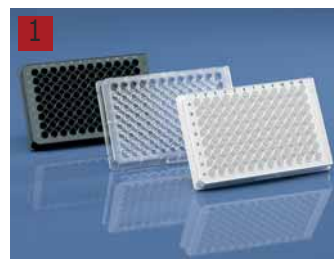
**2 pureGrade™ S, PS**

For bacteriological assays, screenings, storage, etc. Other formats (384 well or 1536 well) on request or in the webshop.

BRAND

- Non-treated
- Sterile

Description	Bottom shape/ Well volume µl	PK	Cat. No.
96-well, transparent	U / 330	50	4.000 256
96-well, transparent	V / 360	50	4.000 257
96-well, transparent	F / 350	50	6.233 912
96-well, transparent	C / 350	50	4.000 258
96-well, white	F / 350	50	4.000 259
96-well, black	F / 350	50	4.000 260
96-well, white, transparent bottom	F / 330	50	4.000 261
96-well, black, transparent bottom	F / 330	50	4.000 262

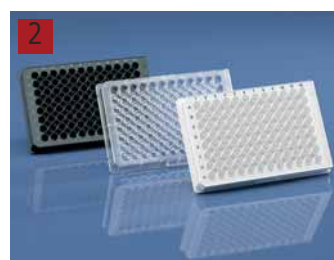
**3 Lids for BRANDplates® microplates**

To protect samples, reaction batches or cell cultures from both contamination and evaporation, compatible lids are available for all BRANDplates® microplates. The lids are made of crystal-clear polystyrene. They are optimally matched to the corresponding BRANDplates® microplates, so that plates with lids can also be stacked. The cut-corner sets the orientation of the lid. For 96-well standard plates, lids with condensation rings are also available.

BRAND

Further covers on request.

Description	Height mm	PK	Cat. No.
for 96-well standard plates with condensation rings	8.0	100	4.000 363
for 96-well standard plates	8.0	100	4.000 364
for 96-well plates with transp. bottom and for 384-well plates	4.5	50	4.000 365

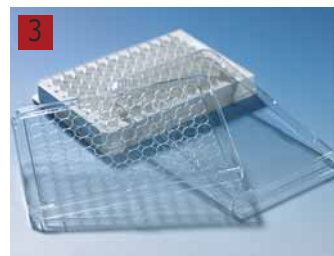
**4 Microtitration plates and sealing films**

Compatible with most microtitration plate centrifuges.

BRAND

- For volumes up to 300 µl
- U-bottom wells
- Autoclavable at 121 °C (2 bar), according to DIN EN 285
- High chemical resistance (e.g. phenol, chloroform, DMSO)
- Recessed hollows between the wells minimize contamination
- Raised rings (rims) around the orifice of each well for easy sealing using self-adhesive sealing films
- Plates can be sealed with self-adhesive, alphanumerically coded, DMSO-resistant, sealing film (cross-cut)

Type	PK	Cat. No.
Microtitration plate, PP, U-Bottom, 330µl	100	9.408 970
DMSO-resistant sealing film, PP	100	9.408 983
Sealing film, self-adhesive, polyester	100	4.000 237
Sealing film, self-adhesive, polyester	100	9.409 386





1 V96 MicroWell™ Plates, PS

Clear plates with V-shaped well bottom for maximized sample recovery. The wells have raised rims and lids are supplied with rings, which prevent cross contamination.

Thermo Scientific

Applications include: antibiotic screens, serological tests, storing and screening compounds and DNA libraries.

Material plates: Polystyrene

Total volume µl/well: 300

Description	Colour	Surface	Sterile	PK	Cat. No.
without lid	Clear	Non-treated	+	50	9.390 513
with lid	Clear	Non-treated	+	50	4.008 606
without lid	Clear	Non-treated	-	180	9.390 512



2 U96 MicroWell™/Immuno™ Plates, PS

Clear plates with excellent optical quality and round well bottom.

Thermo Scientific

- Material plates: Polystyrene

- Total volume µl/well: 300

Choice of different surfaces: Nunclon™Δ surface optimized for cell based assays and sterile non-treated versions for bacteriological applications. MaxiSorp™ and PolySorp™ suitable for solid phase immuno assays. PolySorp™ serve to absorb hydrophobic molecules. MaxiSorp™ is hydrophilic and ideal for antibody sandwich assays.

Description	Colour	Surface	Sterile	PK	Cat. No.
with lid	Clear	Nunclon™Δ*	+	50	9.407 471
without lid	Clear	Non-treated	+	50	9.390 511
with lid	Clear	Non-treated	+	160	4.009 009
without lid	Clear	Non-treated	-	180	9.390 510
without lid	Clear	MaxiSorp™	-	60	9.390 552
without lid	Clear	PolySorp™	-	60	9.390 556
with lid	Clear	Cell culture*	+	160	4.008 768

* certified.



3 96 Well Immuno Plates, PS, flat bottom

Non sterile Immuno plates with transparent flat bottom, well suited for quantitative and qualitative solid phase immunoassays.

Thermo Scientific

Choice of different surfaces:

PolySorp™, Immulon™ 1B and Universal Binding (UB) serve to absorb hydrophobic molecules.

Medisorp™ and Immulon 2HB are slightly hydrophilic and bind a variety of biomolecules.

MaxiSorp™, Immulon 4 HBX and Enhanced Bond (EB) are hydrophilic and ideal for antibody sandwich assays.

MultiSorp™ is highly hydrophilic and is well suited for glycans and water-soluble proteins.

- Reliable and repeatable results in colourimetric assays

- Very good optical quality

- Alphanumerically labeled rows and columns

Surface	Capacity µl/well	working volume µl	PK	Cat. No.
Immulon 1B	330	230	50	4.008 586
Immulon 2 HB	330	280	50	4.008 613
Immulon 4 HBX	330	280	50	6.228 807
MaxiSorp™*	400	350	60	9.390 550
MaxiSorp™	400	350	60	9.390 551
PolySorp™	400	350	180	4.008 802
MaxiSorp™*	400	350	180	6.301 671
MaxiSorp™*	400	350	180	4.009 010
MediSorp™*	400	350	60	4.008 649
MultiSorp™	400	350	60	4.008 650
PolySorp™	400	350	60	9.390 555
UB	380	330	50	6.228 762
EB	380	330	50	4.008 660

* certified.

1 2 3 96 Well Immuno™ Modules

Developed for quantitative and qualitative solid phase immuno assays, e.g. ELISA techniques.

Thermo Scientific

- Alphanumeric orientation systems
- Standard format 128 x 86 mm
- High optical quality
- Four choices for bottom: flat bottom (F), round b. (U), flat with curved b. (C) or StarWell™
- Frames and modules available separately
- Modules remain in frame when inverted
- Certified reproducibility of binding
- Free-standing modul

Choice of different surfaces:

PolySorp™, Immulon™ 1B and Universal Binding (UB) serve to absorb hydrophobic molecules. Medisorp™, and Immulon 2HB are slightly hydrophilic and bind a variety of biomolecules. MaxiSorp™, Immulon 4 HBX and Enhanced Binding (EB) are hydrophilic and ideal for antibody sandwich assays. MultiSorp™ are highly hydrophilic and are suitable for glycans and water-soluble proteins.



Type	Surface	Colour	Capacity µl/well	Sterile	PK	Cat. No.
C8	MaxiSorp™	transparent	350	-	60	7.600 270
C8	MaxiSorp™	white	350	-	60	6.223 056
C8	MaxiSorp™	transparent	380	-	60	6.201 503
C8	PolySorp™	transparent	350	-	60	6.222 763
C8	PolySorp™	white	350	-	60	4.008 839
C12	MaxiSorp™	transparent	350	-	60	4.008 808
C12	MaxiSorp™	transparent	350	-	60	4.008 817
C12	PolySorp™	transparent	350	-	60	6.222 805
F8	MaxiSorp™	transparent	400	-	120	4.009 158
F8	MaxiSorp™	transparent	400	-	60	6.051 794
F8	MaxiSorp™	transparent	400	-	640	6.307 770
F8	MaxiSorp™	dark blue	400	-	60	4.008 915
F8	PolySorp™	transparent	400	-	640	4.008 748
F8	PolySorp™	transparent	400	-	60	4.008 832
F8	MediSorp™	transparent	400	-	60	4.008 834
F8	MultiSorp™	transparent	400	-	60	4.008 841
F16	MaxiSorp™	transparent	400	-	320	6.500 038
F16	MaxiSorp™	transparent	400	-	60	7.200 083
F16	MaxiSorp™	black	400	-	60	6.076 890
F16	PolySorp™	transparent	400	-	60	6.226 552
F16	PolySorp™	transparent	400	-	320	7.631 282
F16	PolySorp™	black	400	-	60	6.300 104
U8	PolySorp™	transparent	300	-	60	4.008 833
U8	MediSorp™	transparent	300	-	60	4.008 835
U16	MaxiSorp™	transparent	300	-	320	6.080 718
Frame				-	60	6.201 611

4 Modules for Immunology, C8 LockWell, PS, breakable

Transparent modules in standard 96-well frames.

Thermo Scientific

- Standard format 128 x 86 mm
- High optical quality for reliable results
- Free-standing modules with easy handling
- Alphanumeric system for better orientation

Choice of different surfaces:

PolySorp™ serve to absorb hydrophobic molecules. Medisorp™ slightly hydrophilic and bind a variety of biomolecules. MaxiSorp™ hydrophilic and ideal for antibody sandwich assays.

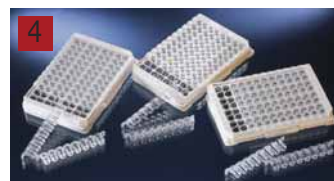

Surface	Capacity µl/well	Bottom shape	PK	Cat. No.
PolySorp™	350	flat	50	4.008 789
PolySorp™	350	flat	50	6.229 875
PolySorp™	250	C-shaped	60	4.008 854
PolySorp™	250	C-shaped	60	4.008 856
PolySorp™	250	C-shaped	60	4.009 017
PolySorp™	250	C-shaped	60	6.229 764
PolySorp™	250	C-shaped	60	6.802 228
MediSorp™	250	C-shaped	60	4.008 853
MaxiSorp™	250	C-shaped	60	6.303 882
MaxiSorp™	200	C-shaped	60	4.008 857



1 96/384 Well Plates and Modules Covalink™ and Immobilizer Streptavidin, PS

Microtiter plates for immunoassays with surfaces for affinity binding (passive streptavidin and immobilizer streptavidin, nickel chelate and glutathione, BioBind). *Thermo Scientific*

- Streptavidin-biotin interaction for a broad range of biomolecules
- Highly specific binding surface
- Improvement of the signal-to-noise ratio
- 96 well plate: Working volume 100 µl/well, total volume 350-400 µl/well
- 384 well plate: Working volume 50 µl/well, total volume 120 µl/well

Type	Bottom shape	Colour	PK	Cat. No.
Plate 96-well	flat	transparent	15	4.008 819
Plate 96-well	flat	white	15	4.008 868
Plate 96-well	flat	black	15	7.632 002
Plate 384-well	flat	transparent	15	4.009 030
Solid module F8 (x12) in frame	flat	transparent	15	4.008 998
Lock-Well module C8 (x12) in frame	C-shape	transparent	15	4.008 999



2 Lids for 96-well and 384-well Plates

Lids in various versions made of clear, strong polystyrene with notches for quick orientation. Reduce water loss due to lower evaporation. 96-well lids feature individual condensation rings. *Thermo Scientific*

Height mm	With	Sterile	PK	Cat. No.
7.90	Evaporation barrier	-	100	9.407 480
7.90	Evaporation barrier	+	50	9.407 481
7.90	Evaporation barrier	+	60	6.802 229
8.34	-	+	15	4.008 599
8.34	-	-	60	6.206 034

Evaporation barrier is a rim around the inside edge of the lid.



3 Sealing Tapes for MultiWell Plates

Effectively seals all microplate formats for storage, PCR, microscopy, culture and protection. Pre-cut, plate-sized sheets. *Thermo Scientific*

- Type 1) General use, PCR, storage, photo-sensitive samples
- Type 2) Cell Culture, sterile applications
- Type 3) Microscopy, good optics, low auto-fluorescence, DMSO compatible
- Type 4) Breathable, cell culture

Type	Colour	Glue	Sterile	Material	PK	Cat. No.
1)	Silver	Silicone	-	Aluminium	100	6.250 417
2)	Clear	Acrylic	+	Polyester	800	9.407 482
3)	Clear	Acrylate	-	Polyolefin	100	6.223 248
4)	White	Acrylate	+	Rayon	50	4.008 574
1)	Silver	Acrylate	-	Aluminium	100	7.500 007
3)	Clear	Acrylate	-	Polyolefin	100	7.601 198



1 Gel electrophoresis tank OmniPage Mini

Vertical chamber especially for protein analysis in up to 4 gels.
The special manufacturing process results in a device with unique quality and durability at a very reasonable price. Easy handling and fast cooling. The dimensions are compatible with all 8 x 10 and 10 x 10 cm ready-to-use gels. High sample throughput by up to 4 gels with 20 samples each. Low buffer volume from 250 to 1200 ml.

Supplied with:

OmniPage Mini: chamber with platinum electrodes, 2 sets of glass plates with 1 mm thick bonded Spacers, electrodes, 2 x 12 sample combs.
OmniPage Mini SYS: OmniPage Mini + caster.
OmniPage Mini CBS: OmniPage Mini + caster and blotting insert.

Cleaver Scientific



Technical specifications

Gel dimensions (W x L): 7.5 x 8 cm
Unit dimensions (W x D x H): 19 x 13 x 15 cm
Max. sample capacity: 80 samples, 20 samples per gel
Buffer volume: min. 250 ml; max 1200 ml

Description	PK	Cat. No.
OmniPage Mini	1	9.584 652
OmniPage Mini SYS	1	9.584 654
OmniPage Mini CBS	1	6.229 038

2 Gel electrophoresis package omniPAGE TETRAD Mini-Set

The gel electrophoresis tank OmniPAGE Mini is suitable for parallel treatment of up to 4 gels with 20 samples each. The tank is easy to handle, especially leak proof and guarantees an efficient cooling. For self-cast gels and all major types of 8 x 10cm and 10 x 10cm precast gels.

Supplied with:

- omniPAGE Mini, 10 x 10cm Dual
- 1x CVS10DIRM Sliding Clamp PAGE insert
- 1x CVS10EXCASTER External Casting Upstand
- 1x VS10TANK Tank
- 1x VS10LID Lid
- 1x VS10DP Dummy plate
- 1x CSL-CAB set of electrophoresis cables, one black, one red
- 2x VS10PGS1 Plain glass plates with 1mm bonded spacer (pack of 2)
- 2x VS10NG Notched glass plates (pack of 2)
- 2x VS10NGS1 Notched glass plates with 1mm bonded spacer (pack of 2)
- 4x VS10-12-1 = 4x 12 sample combs, 1mm thick
- 1x VS10DCAST Casting base with casting mat

Cleaver Scientific



Type	PK	Cat. No.
omniPAGE TETRAD Mini-Set	1	7.930 246

3 Protein Ladders, Prestained

The marker is covalently bound to a blue colour chromophore to produce a ladder of evenly interspersed bands of uniform intensity. The coloured reference bands are used as visual indicators for the process of gel electrophoresis and the efficiency of the transfer to membranes in the Western Blot. The marker is suitable for the precise identification of the molecular weight of most cellular proteins.

- Easy identification in gels and blots
- Detectable from 2.5 µl
- 2 years stable at - 20 °C
- Vials of 500 µl

Cleaver Scientific

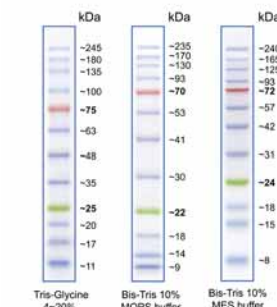

Type	Size	Bands	Reference bands	PK	Cat. No.
BLUE Wide Range	10 - 245 kDa	12	25, 75 kDa	1	4.661 311

Proteomics/Protein-Electrophoresis-Blotting

1



1 Protein gel staining kits

NEW

Ready to use kit for rapid and sensitive protein staining of 1D and 2D SDS PAGE gels.

Cleaver Scientific

It enables high contrast and optimal visualization and quantitation of proteins. After staining, proteins can be analyzed by mass spectrometry directly. The dye has optimal excitation at 302 and 470 nm, with maximum emission at approximately 610 nm. It can be excited with UV-transilluminators, 405, 445, 473-488 nm laser sources or 470 nm blue LED light source.

- High purity dye > 98 %
- Optimal signal to background ratio
- Strong, uniform and reproducible signal from 0.2 ng to 10 ng protein
- Fast three step staining protocol (220 min)
- Mass spectrometry compatible

Description	PK	Cat. No.
RUBYPROL, Reagent A 250 ml, Reagent B 250 ml	1	4.670 743

Protein staining solution

NEW

Enhanced Coomassie based protein stain formulated for fast and sensitive protein detection without the involvement of hazardous chemicals such as methanol, acetic acid, and other toxic agents. Protein detection limits are as low as 10 ng and visualization can be achieved in less than 1 hour. Applications suitable for native PAGE, SDSPAGE, isoelectric focusing, and 2D gels.

Cleaver Scientific

- Detection of protein concentration as low as 10 ng
- Protein bands visualization within 10 minutes
- Without involvement of hazardous chemicals

Type	PK	Cat. No.
BLUEPRO, 500 ml	1	4.670 744

2



2 Blotting paper

Recommended for blotting techniques with gels, like Southern, Northern and Western Blots, even Semidry-Blots of proteins

Hahnemühle

- Made from ultrapure cotton linters and cellulose, entirely without additives to ensure that no contamination will occur during the transfer steps
- Tested specifically for chromatographic and blotting techniques to ensure high and uniform capillary actions
- High wet strength for safe handling

Further sizes on request.

Description	Width mm	Length mm	Thickness mm	Weight g / m ²	PK	Cat. No.
medium absorbency	570	460	0.35	192	100	4.006 154
medium absorbency	600	580	0.35	192	100	4.006 155
medium absorbency	600	580	0.90	320	50	4.006 156
high absorbency	600	580	1.50	570	25	4.006 157

3



3 Gel blotting paper

GB 003, GB 005. High purity. Very absorbent. Easy to use. Suitable for all protein and nucleic acid blotting techniques.

Whatman

Type	Width mm	Length mm	Wall thickness mm	PK	Cat. No.
GB 003	150	100	0.8	100	6.254 192
GB 003	100	70	0.8	100	6.264 279
GB 003	200	150	0.8	100	6.242 023
GB 003	180	160	0.8	100	7.657 015
GB 003	200	200	0.8	100	9.057 077
GB 003	570	460	1.2	100	7.930 288
GB 003	100	100	0.8	50	7.010 061
GB 003	600	300	0.8	25	9.057 067
GB 003	600	580	0.8	50	9.057 078
GB 005	150	150	1.2	25	7.010 064
GB 005	200	200	1.2	25	9.057 079
GB 005	580	580	1.2	25	9.057 075

1 Transfer membrane, PVDF

Hydrophobic Polyvinylidene Fluoride (PVDF) transfer membrane with high binding capacity and low background. Ideal for use in protein binding applications such as Western blots, solid phase assays and immunoblotting procedures. BSA binding capacity up to 125 µg/cm²

GVS S.p.A.

Width	Length	Pore size	PK	Cat. No.
mm	mm	µm		
200	200	0.22	5	4.678 673
200	200	0.45	25	4.678 672
200	200	0.45	5	4.678 666
300	3000	0.22	1	4.678 670
300	3000	0.45	1	4.678 667

2 Transfer membrane, supported nitrocellulose

Supported Nitrocellulose transfer membranes combine the binding characteristics of nitrocellulose membranes with the strength of nylon membranes. These membranes are used for DNA/RNA transfers requiring low background or for multiple hybridizations. For use with chemiluminescence and radiographic detection.

GVS S.p.A.

**Warning**

H phrases: H228

Width	Length	Pore size	PK	Cat. No.
mm	mm	µm		
200	200	0.22	5	4.678 668
200	200	0.45	5	4.678 664
200	200	0.45	25	4.678 671
300	3000	0.22	1	4.678 665
300	3000	0.45	1	4.678 663

3 Transfer membrane, nitrocellulose

Pure Nitrocellulose transfer membrane for all protein or immunoblotting applications. The high sensitivity and low background ensures excellent results in all transfers. Compatible with all detection systems. BSA binding capacity up to 100µg/cm².

GVS S.p.A.

**Warning**

H phrases: H228

Width	Length	Pore size	PK	Cat. No.
mm	mm	µm		
200	200	0.22	5	4.678 669
200	200	0.22	25	4.678 674
200	200	0.45	5	4.678 677
200	200	0.45	25	4.678 678
300	3000	0.22	1	4.678 675
300	3000	0.45	1	4.678 676

Semi Dry Blotters

These Semi Dry Blotters offer rapid transfer times for DNA, RNA and protein blotting; typically 15 to 30 minutes. All units can be used for all types of blotting: western, southern and northern via uncomplicated buffer and set up procedures and are compatible with gel thicknesses from 0.25 up to 10mm without the need for additional equipment. Each unit is compatible with their respective omniPAGE vertical gel system. Semi Dry Blotting has the added benefit of economic transfers due to very low buffer volumes - typically only a few millilitres of buffer are required per transfer. These Semi-Dry Blotters utilise a screw down lid, which secures the blot sandwich and allows complete control of pressure ensuring even transfer. The electrodes, comprising platinum coated anode and stainless steel cathode, will exhibit practically no corrosion and so provide many years of trouble free use. Uniform heat dispersion across the blot sandwich ensures stable transfer times and no heat induced sample loss or transfer distortions. Being translucent, it allows viewing of the blot sandwich to ensure correct positioning and transfer is occurring correctly. Electrode plates are fully separated to prevent arching or damage.

Cleaver Scientific



9.584 753

Type	Description	Dimensions (W x D x H)	Capacity Buffer	Qty. Blots	Dimensions blots	PK	Cat. No.
		mm	ml		cm		
SD10	Mini, 10 x 10 cm	160 x 160 x 70	5	1	8 x 8,5	1	9.584 753
SD20	Maxi, 20 x 20 cm	260 x 260 x 70	20	1	16 x 17,5	1	6.229 381
				2	16 x 8,5		
				4	8 x 8,5		



9.584 752

Sub Blot Systems omniBLOT

The omniBlot is an stand-alone unit for the tank-blot method. Each unit consists of an OmniPAGE tank and lid, a electroblotting insert as well as cassettes and fibre pads. The versatile design of the tanks and the matching lids are compatible with the vertical PAGE or IEF systems with the appropriate optional inserts.

Cleaver Scientific

- Mini system transfers up to 4 Mini gels
- Mini Wide system transfers up to 4 Mini Wide and 8 Mini gels
- Maxi system transfers up to 4 Maxi gels, 8 Mini Wide and 16 Mini gels
- Run-times ranging between 2 and 20 hours
- Rigid cassettes eliminate the formation of shadow bands
- Colour coded cassettes prevent reverse polarity for correct orientation
- Cooling with cooling packs at high transmission intensity

Specifications

Dimensions (W x D x H):	Mini: 15 x 13 x 19 cm Mini Wide: 26 x 16 x 16 cm Maxi: 27 x 18 x 30 cm
Gel dimension:	Mini: 8 x 8.5 cm Mini Wide: 16 x 8.5 cm Maxi: 16 x 17.5 cm
Max. buffer volume:	Mini: 1200 ml Mini Wide: 2800 ml Maxi: 6400 ml
Run time:	Mini: 1-2 h Mini Wide: 1-2 h Maxi: 5-20 h
Power supply:	100 V

Type	PK	Cat. No.
omniBlot Mini Blotting System 10 x 10 cm + 4 cassettes	1	9.584 751
omniBlot Mini Wide Blotting System 20 x 10 cm + 4 cassettes	1	4.668 184
omniBlot Maxi Blotting System 20 x 20 cm + 4 cassettes	1	9.584 752



2 Staining Solution Ponceau S

For staining blotted proteins on nitrocellulose and PVDF membranes. Colour detection for immunoblots (Western blots). Can also be used for staining proteins on cellulose acetate membranes.

Cleaver Scientific

- Membrane staining
- Reversible colouring
- Reusable



Warning

H phrases: H315|319|335

Type	Capacity ml	PK	Cat. No.
CSL-PSS Staining solution	500	1	4.661 312

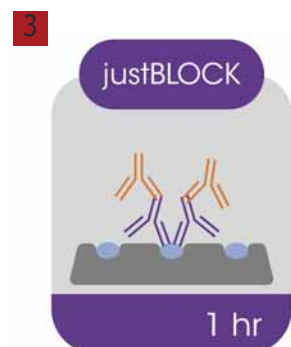

3 Blocking solution for Western blot

NEW

An all-in-one blocking solution for Western blot analysis. In one step, blocking, primary and secondary antibodies hybridization as well as enhancing the signal.

Cleaver Scientific

- Enhance antibody signal
- Universal antibody diluent
- Effective with any ECL substrates
- Compatible with PVDF and NC membrane
- Improve protein detection

Type	PK	Cat. No.
JUSTBLOCK, 500 ml	1	4.670 746

1 Substrate kits, ECL **NEW**

ECL substrate with stable light output. The formulation provides a low background for a high signal to noise ratio.

Cleaver Scientific

Test kit includes luminol/enhancer and peroxide solutions.

LumiGO: For low picogram detection. 125 ml luminol/enhancer solution, 125 ml peroxide solution.

LumiPRO: For low femtogram detection and an very high signal intensity. 50 ml luminol/enhancer solution, 50 ml peroxide solution.

- Long signal duration
- Working solution stable for at least three days

Type	PK	Cat. No.
LumiGO	1	4.670 747
LumiPRO	1	4.670 748



PBS, phosphate buffered saline **NEW**

pH 7. In a HDPE bottle.

Reagecon

Type	PK	Cat. No.
PBS, pH 7	1	4.012 324

2 Potassium phosphate buffer, monobasic, mobile phase **NEW**

The buffered eluents are tested and certified, NIST traceable, developed, formulated and specified in accordance with United States Pharmacopoeia (USP) requirements.

Reagecon

- Guaranteed stability throughout its entire shelf life
- In 1 l HDPE bottle

Description	PK	Cat. No.
Monobasic potassium phosphate, pH 2.5	1	4.012 501
Monobasic potassium phosphate, pH 4	1	4.675 416
Monobasic potassium phosphate, pH 5	1	4.012 513
Monobasic potassium phosphate, pH 6	1	4.012 517
Monobasic potassium phosphate, pH 7	1	4.012 525
Monobasic potassium phosphate / Sodium hydroxide, pH 7	1	4.012 527
Monobasic potassium phosphate, pH 7.5	1	4.012 529
Dibasic potassium / Monobasic sodium phosphate, pH 7.5	1	4.012 531
Monobasic sodium phosphate / Di-sodium hydrogen phosphate, pH 8	1	4.012 533



3 Membrane Tweezers

Swiss made. Made of austenitic steel. Non-magnetizable. Good corrosion resistance to most chemicals, salts and acids. Flat, with round tips and rounded edges. Especially suitable for safe handling of transfer membranes.

Ideal-tek

Form	Length mm	PK	Cat. No.
thin, squared, bent tips	105	1	6.272 053
flat, round tips	115	1	9.160 131
smooth and flat tips	120	1	6.269 622



4 Storage boxes, HDPE with tightly closing LDPE lid

Suitable for cold storage rooms and refrigerators. Temperature range/withstands temperatures (without mechanical stress) from -20 to +95°C. Stackable. Acid and chemical resistant. Food safe. Colour: natural.

Capacity L	Width mm	Depth mm	Height mm	PK	Cat. No.
0.5	103	103	64	1	9.033 270
1.0	103	103	127	1	9.033 275
1.0	103	208	64	1	9.033 280
1.5	103	208	94	1	9.033 285
2.0	103	255	94	1	9.033 286
2.0	208	208	64	1	9.033 287
3.2	208	208	94	1	9.033 288



Proteomics/Blotting-Blot Imaging

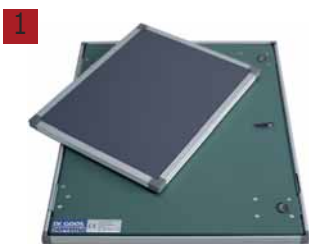

1 X-Ray cassettes

- Standard design with lead lining and snap fit lid.
- easy to open, easy to close with gentle pressure.
 - firm, consistent support for films through special shaping: base pre-formed with convex profile.
 - flexible, pure aluminium base (Absorption 1.2mm Al-value) film processed in frames
 - Aluminium base coated in impact-resistant paint
 - Anodised aluminium frame
 - Elastic foam for film protection
 - Specifically designed for autoradiography at 70°C
- Use our reinforcement films in the blue sensitivity range with these X-Ray cassettes.

Format mm	PK	Cat. No.
180 x 240	1	9.106 580
240 x 300	1	9.106 581
200 x 400	1	9.106 582
356 x 432	1	9.106 583

2 Gel documentation system chemiPRO-302E

NEW
Cleaver Scientific

Complete solution for chemiluminescence and fluorescent Western blot imaging. With highly sensitive cooled CCD Camera with high quantum efficiency, for detection of picogram level proteins. Peltier cooling allows exposure times to be increased to detect faint chemiluminescence without adding annoying background noise. Suitable for chemiluminescence Western blots, auto-rads, DNA or RNA stained with ethidium bromide, SYPRO, SYBR and SAFE dyes on agarose gels, Coomassie blue or silver stained proteins on acrylamide gels, stain-free gels and fluorescent gels. Furthermore GFP-plant imaging, colonies or plaques detection on Agar plates, bioluminescence and 2d gels. The free of charge software allows automated imaging of multicolour blots with a simple and user friendly interface.

- Cooled, high resolution, high quantum efficiency (QE) camera
- Motor driven lens and 7-position motor-driven filter wheel
- Long-life white LED EPI lighting
- CFR21 Part 11 compliant
- With acquisition and analysis software genePIX and geneQUANT

Scope of supply:

Darkroom, camera, UV transilluminator, UV emission filter, license free acquisition and analysis software

Specifications

Resolution:	4 megapixels
Effective resolution:	16 megapixels
Lens:	Zoom, f1.2
Camera cooling:	-57 °C
Sensor bit-depth:	16 bit
Greyscales:	65536
Dynamic range:	4.8
Transilluminator wavelength:	302 nm
Transilluminator size:	250 x 300 mm
Dimensions (W x D x H):	570 x 450 x 840 mm
Weight:	37 kg
Power supply:	230 V/50 Hz

Type	PK	Cat. No.
chemiPRO-302E	1	4.670 738

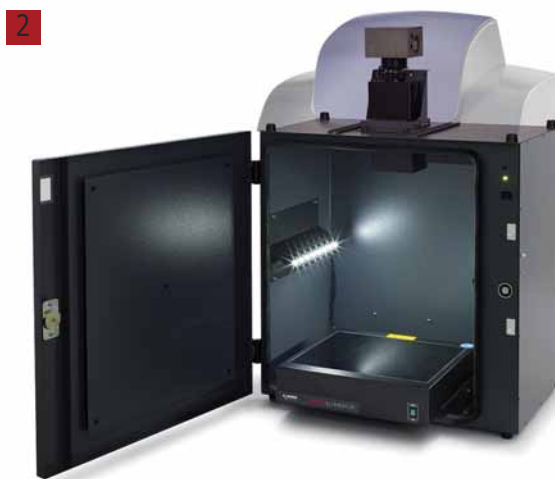

1 Centrifugal concentrators, Vivaspin 500

Membrane: polyethersulphone. Compatible with swing-out and fixed-angle rotors.
The vertical, built-in membrane guarantees minimal membrane fouling and provides rapid sample concentration. Low protein adsorption gives minimal sample loss.

Sartorius Lab Instruments

Membrane surface: 0.5cm²
Max. rcf.: 12000 x g
Hold-up volume: < 5µl

MWCO	PK	Cat. No.
da		
3000	100	9.049 864
3000	25	9.049 863
5000	25	9.049 755
5000	100	9.049 850
10000	25	9.049 756
10000	100	9.049 851
30000	25	9.049 757
30000	100	9.049 852
50000	25	9.049 758
50000	100	9.049 853
100000	25	9.049 759
100000	100	9.049 854
Starter kit (5 ea. 5K to 100K)	25	9.049 750

**2 Centrifugal concentrators, Vivaspin 2**

Membrane: polyethersulphone. This 2 ml volume unit combines the rapidity of the classic Vivaspin products with reduced internal surface and membrane areas for superior recoveries from very dilute solutions. With a choice of suitable membranes (PES, CTA, Hydrosart) Vivaspin 2 provides the highest flexibility for process optimisation. Vivaspin 2 guarantees maximum sample recovery either by reverse centrifuging into the concentrate recovery cap or by directly pipetting the concentrate from the deadstop pocket built into the bottom of the concentrator.

Sartorius Lab Instruments

Membrane surface: 1.2cm²
Max. rcf.: 8000 x g
Hold-up volume: < 10µl

MWCO	PK	Cat. No.
da		
3000	25	9.049 861
3000	100	9.049 862
5000	25	9.049 760
5000	100	9.049 777
10000	25	9.049 761
10000	100	9.049 778
30000	25	9.049 762
30000	100	9.049 779
50000	25	9.049 763
50000	100	9.049 780
100000	25	9.049 764
100000	100	9.049 781

**3 Centrifugal unit/concentrator Vivaspin 6**

Membrane: polyethersulphone. Vivaspin 6ml concentrators have been developed to offer increased volume flexibility and performance. Vivaspin 6 can process an impressive 6ml in either swing-out buckets or fixed angle rotors accepting standard 15 ml conical bottom test tubes. The Vivaspin 6 features twin vertical membranes for unparallelled filtration speeds and 100x plus concentrations.

Sartorius Lab Instruments

Membrane area: 2.5cm²
Max. centrifugal force: 8000 x g
Hold-up volume: < 10µl

MWCO	PK	Cat. No.
da		
5000	25	9.049 765
5000	100	9.049 782
10000	25	9.049 766
10000	100	9.049 783
30000	25	9.049 767
30000	100	9.049 784
50000	25	9.049 768
50000	100	9.049 785
100000	25	9.049 769
100000	100	9.049 786
0.2 µm	25	9.049 770
0.2 µm	100	9.049 787
Starter kit (5 ea. 5K to 100K)	25	9.049 753





1 Centrifugal concentrators, Vivaspin 20

Membrane: polyethersulphone. Vivaspin 20ml centrifugal concentrators have been developed to offer increased volume flexibility and performance. Vivaspin 20 handles up to 20ml in swing bucket centrifuges and 14ml in 25° fixed angle rotors accepting 50ml centrifuge tubes. Featuring twin vertical membranes for unparalleled filtration speeds the Vivaspin 20 can achieve 100x plus concentrations. Remaining volume is easy to read off the printed scale on the side of the concentrator and the modified dead stop pocket further simplifies direct pipette recovery of the final concentrate. *Sartorius Lab Instruments*

Membrane area: 6.0 cm²
Max. centrifugal force: 6000 xg
Hold-up volume: < 20 µl

MWCO	PK	Cat. No.
da		
3000	12	9.049 855
5000	12	9.049 771
10000	12	9.049 772
30000	12	9.049 773
50000	12	9.049 774
100000	12	9.049 775
300000	12	9.049 857
1000000	12	9.049 858
0.2 µm		
3000	48	9.049 856
5000	48	9.049 788
10000	48	9.049 789
30000	48	9.049 790
50000	48	9.049 791
100000	48	9.049 792
300000	48	9.049 859
1000000	48	9.049 860
0.2 µm	48	9.049 793
Starter kit (2 ea. 5K to 0.2 µm)	12	9.049 754



2 3 Crossflow filter units Vivaflow 50/200

Thin channel, crossflow filter units with 50cm²/200cm² filter areas for capacities between 100ml/500ml and 5L. This system provides high crossflow rates at minimum pumping pressure and does not require additional fittings for scale-up. VivaFlow 50 is easy to operate with a flow restrictor and, optionally, a pressure indicator. Modular construction with luer connections allows interlocking of units in series for easy scale-up. Recovery rates are maximised due to optimised recirculation volume and by use of low adsorption materials. Disposable. For greater volumes, VivaFlow 200 is available with a filter area of 200cm² and includes pressure indicator, flow restrictor, filtrate tubing and connectors. Membrane: polyethersulphone *Sartorius Lab Instruments*

Description	MWCO	Membrane	PK	Cat. No.
da				
Vivaflow 50	3.000	PES	2	6.240 542
Vivaflow 50	5.000	PES	2	9.049 742
Vivaflow 50	10.000	PES	2	9.049 743
Vivaflow 50	30.000	PES	2	9.049 744
Vivaflow 50	50.000	PES	2	9.049 745
Vivaflow 50	100.000	PES	2	9.049 746
Vivaflow 50	0,2 µm	PES	2	9.049 747
Vivaflow 200	5.000	PES	1	9.049 794
Vivaflow 200	10.000	PES	1	9.049 795
Vivaflow 200	30.000	PES	1	9.049 796
Vivaflow 200	50.000	PES	1	9.049 797
Vivaflow 200	100.000	PES	1	9.049 798
Vivaflow 200	0,2 µm	PES	1	9.049 799

Accessories available on request.



➔ More peristaltic pumps please see chapter 8.

1 Dialysis Tubing Biotech Cellulose Ester (CE)

Biologically inert and ultra-pure, Biotech CE is available in the largest selection of concise MWCOs (0.1 to 1000 kD) and sizes to provide better molecular separation for desalting, isolating ionic species and macromolecular purifications. Moderate chemical compatibility tolerates weak or dilute acids or bases and mild alcohols with only a slight change to the MWCO. Not for use with organic solvents. Use with pH 2 to 9 and temperature 4 to 37 °C. REPLIGEN

Type	Flat width mm	PK	Cat. No.
Biotech CE, 0,1-0,5 kD MWCO	10	10	7.611 951
Biotech CE, 0,1-0,5 kD MWCO	16	10	6.233 319
Biotech CE, 0,1-0,5 kD MWCO	31	10	7.651 260
Biotech CE, 0,5-1 kD MWCO	10	10	7.660 686
Biotech CE, 0,5-1 kD MWCO	24	10	6.282 267
Biotech CE, 0,5-1 kD MWCO	31	10	7.910 682
Biotech CE, 100 kD MWCO	10	10	7.673 536
Biotech CE, 100 kD MWCO	24	10	6.200 438



2 Dialysis Device Float-A-Lyzer G2

Ready-to-use dialysis device with screw cap for ultimate convenience for small volume dialysis. Easy loading and recovery. No needles, closures, knots, buoys, pontoons, or weights required. Made with Biotech CE membrane in 9 MWCO's (0.1 to 1000 kD) and 3 volume sizes (1, 5 and 10 ml). REPLIGEN

Type	Capacity ml	PK	Cat. No.
Float-A-Lyzer, 0.5-1 kD MWCO	10	12	6.253 346
Float-A-Lyzer, 8-10 kD MWCO	10	12	6.253 551
Float-A-Lyzer, 20 kD MWCO	1	12	6.256 038
Float-A-Lyzer, 20 kD MWCO	10	12	6.284 110
Float-A-Lyzer, 50 kD MWCO	10	12	6.284 111
Float-A-Lyzer, 100 kD MWCO	1	12	6.252 583
Float-A-Lyzer, 300 kD MWCO	5	12	7.672 754



3 Standard RC Dialysis Membrane Tubing, Spectra/Por®

Standard Grade Regenerated Cellulose (RC) is a clear, flexible and sturdy dialysis tubing. This tubing is ideal for a broad range of applications in which there is a significant size difference between the MW species being separated, including sample preparation, desalting, buffer exchange, pH change, protein purification. Offering a good chemical compatibility, Standard Grade RC can be used with dilute strong acids and bases, concentrated weak acids and bases, most alcohols and some mild or dilute organics, including DMSO. Standard RC can tolerate pH 2 to 12 and temperatures 4 to 121 °C. REPLIGEN



4 Dry RC Dialysis Tubing Spectra/Por® 1, 2, 3 and 4

RC dialysis tubing supplied dry with glycerol humectant for easy handling and manipulation. Soak in DI water for 30 minutes to remove glycerol. Contains trace levels of heavy metals and sulphides. REPLIGEN
Spectra/Por® 1, 3 and 4: For standard dialysis, different MWCO and flat widths
Spectra/Por® 2: Dialysis Tubing with higher permeability

Type	Flat width mm	Diam. mm	PK	Cat. No.
Spectra/Por® 1, 6 - 8 kD MWCO	10	6.4	15	9.206 645
Spectra/Por® 1, 6 - 8 kD MWCO	23	14.6	30	9.206 650
Spectra/Por® 1, 6 - 8 kD MWCO	32	20.4	30	9.206 655
Spectra/Por® 1, 6 - 8 kD MWCO	40	25.5	30	9.206 660
Spectra/Por® 1, 6 - 8 kD MWCO	50	32.0	30	9.206 665
Spectra/Por® 1, 6 - 8 kD MWCO	100	64.0	15	9.206 670
Spectra/Por® 1, 6 - 8 kD MWCO	120	76.4	15	9.206 675
Spectra/Por® 2, 12 - 14 kD MWCO	10	6.4	15	9.206 676
Spectra/Por® 2, 12 - 14 kD MWCO	25	16.0	15	9.206 678
Spectra/Por® 2, 12 - 14 kD MWCO	45	29.0	15	9.206 680
Spectra/Por® 2, 12 - 14 kD MWCO	105	67.0	15	9.206 682
Spectra/Por® 2, 12 - 14 kD MWCO	120	76.4	15	9.206 684
Spectra/Por® 3, 3,5 kD MWCO	18	11.5	15	9.206 720
Spectra/Por® 3, 3,5 kD MWCO	45	29.0	15	9.206 724
Spectra/Por® 3, 3,5 kD MWCO	54	34.0	15	9.206 725
Spectra/Por® 4, 12 - 14 kD MWCO	10	6.4	30	9.206 697
Spectra/Por® 4, 12 - 14 kD MWCO	25	16.0	30	9.206 700
Spectra/Por® 4, 12 - 14 kD MWCO	32	20.4	30	9.206 703
Spectra/Por® 4, 12 - 14 kD MWCO	45	29.0	30	9.206 706
Spectra/Por® 4, 12 - 14 kD MWCO	75	48.0	15	9.206 709



1



1 Pre-wetted RC Dialysis Tubing Spectra/Por® 6

RC dialysis tubing supplied pre-wetted with glycerol removed for convenience in 0.05 % sodium azide solution. Simply rinse away the preservative solution with DI water, load the sample and dialyze.

REPLIGEN

Type	Flat width mm	Diam. mm	PK	Cat. No.
Spectra/Por® 6, 1 kD MWCO	18	11.5	10	9.206 636
Spectra/Por® 6, 1 kD MWCO	38	24.2	10	9.206 638
Spectra/Por® 6, 1 kD MWCO	45	28.6	10	9.206 640
Spectra/Por® 6, 2 kD MWCO	18	11.5	10	9.206 620
Spectra/Por® 6, 2 kD MWCO	38	24.2	10	9.206 625
Spectra/Por® 6, 2 kD MWCO	45	28.6	10	9.206 633
Spectra/Por® 6, 3,5 kD MWCO	18	11.5	10	9.206 790
Spectra/Por® 6, 3,5 kD MWCO	45	28.6	10	9.206 792
Spectra/Por® 6, 3,5 kD MWCO	54	34.4	10	9.206 794
Spectra/Por® 6, 8 kD MWCO	12	7.6	10	9.206 779
Spectra/Por® 6, 8 kD MWCO	23	14.6	10	9.206 780
Spectra/Por® 6, 8 kD MWCO	32	20.4	10	9.206 782
Spectra/Por® 6, 8 kD MWCO	40	25.5	10	9.206 784
Spectra/Por® 6, 8 kD MWCO	50	31.8	10	9.206 786
Spectra/Por® 6, 10 kD MWCO	12	7.6	10	9.206 770
Spectra/Por® 6, 10 kD MWCO	25	15.9	10	9.206 772
Spectra/Por® 6, 10 kD MWCO	32	20.4	10	9.206 774
Spectra/Por® 6, 10 kD MWCO	45	28.6	10	9.206 776
Spectra/Por® 6, 15 kD MWCO	12	7.6	10	9.206 760
Spectra/Por® 6, 15 kD MWCO	25	15.9	10	9.206 762
Spectra/Por® 6, 15 kD MWCO	32	20.4	10	9.206 764
Spectra/Por® 6, 15 kD MWCO	45	28.6	10	9.206 766
Spectra/Por® 6, 25 kD MWCO	12	7.6	10	9.206 750
Spectra/Por® 6, 25 kD MWCO	28	17.8	10	9.206 752
Spectra/Por® 6, 25 kD MWCO	34	21.6	10	9.206 754
Spectra/Por® 6, 50 kD MWCO	12	7.6	10	9.206 740
Spectra/Por® 6, 50 kD MWCO	28	17.8	10	9.206 742
Spectra/Por® 6, 50 kD MWCO	34	21.6	10	9.206 744

2



2 Pre-treated RC Dialysis Tubing Spectra/Por® 7

RC dialysis tubing treated to remove trace levels of heavy metals and sulphide compounds. Ready-to-use Dialysis Tubing already equilibrated in water and supplied in 0.05 % sodium azide solution. Simply rinse away the preservative solution with DI water, load the sample and dialyze.

REPLIGEN

Type	Flat width mm	Diam. mm	PK	Cat. No.
Spectra/Por® 7, 1 kD MWCO	18	11.5	5	9.206 803
Spectra/Por® 7, 1 kD MWCO	38	24.2	5	9.206 804
Spectra/Por® 7, 1 kD MWCO	45	28.6	5	9.206 805
Spectra/Por® 7, 2 kD MWCO	18	11.5	5	9.206 807
Spectra/Por® 7, 2 kD MWCO	38	24.2	5	9.206 808
Spectra/Por® 7, 2 kD MWCO	45	28.6	5	9.206 809
Spectra/Por® 7, 3,5 kD MWCO	18	11.5	5	9.206 810
Spectra/Por® 7, 3,5 kD MWCO	45	28.6	5	9.206 811
Spectra/Por® 7, 3,5 kD MWCO	54	34.4	5	9.206 812
Spectra/Por® 7, 8 kD MWCO	12	7.6	5	9.206 813
Spectra/Por® 7, 8 kD MWCO	23	14.6	5	9.206 814
Spectra/Por® 7, 8 kD MWCO	32	20.4	5	9.206 815
Spectra/Por® 7, 8 kD MWCO	40	25.5	5	9.206 816
Spectra/Por® 7, 8 kD MWCO	50	31.8	5	9.206 831
Spectra/Por® 7, 10 kD MWCO	12	7.6	5	9.206 817
Spectra/Por® 7, 10 kD MWCO	25	15.9	5	9.206 818
Spectra/Por® 7, 10 kD MWCO	32	20.4	5	9.206 819
Spectra/Por® 7, 10 kD MWCO	45	28.6	5	9.206 820
Spectra/Por® 7, 15 kD MWCO	12	7.6	5	9.206 821
Spectra/Por® 7, 15 kD MWCO	25	15.9	5	9.206 822
Spectra/Por® 7, 15 kD MWCO	32	20.4	5	9.206 823
Spectra/Por® 7, 15 kD MWCO	45	28.6	5	9.206 824
Spectra/Por® 7, 25 kD MWCO	12	7.6	5	9.206 825
Spectra/Por® 7, 25 kD MWCO	28	17.8	5	9.206 826
Spectra/Por® 7, 25 kD MWCO	34	21.6	5	9.206 827
Spectra/Por® 7, 50 kD MWCO	12	7.6	5	9.206 828
Spectra/Por® 7, 50 kD MWCO	28	17.8	5	9.206 829
Spectra/Por® 7, 50 kD MWCO	34	21.6	5	9.206 830

1 Dialysis tubing closures Spectra/Por, PP



REPLIGEN

Standard and Weighted Spectra/Por Closures provide a leak-proof seal for dialysis tubing while aiding in sample buoyancy and vertical orientation. They are available in 23, 35, 55, 75 and 90 mm sealing widths and a variety of colors for easy sample identification. Closures are autoclavable.



Description	Up to Flat width mm	Colour	PK	Cat. No.
Dialysis tubing closures	23	Orange	10	6.288 668
Dialysis tubing closures	35	Orange	10	6.288 670
Dialysis tubing closures	55	Orange	10	6.288 669
Dialysis tubing closures	75	Orange	10	6.288 667
Dialysis tubing closures	90	Orange	10	6.288 666
Dialysis tubing closures	35	Blue	10	6.223 462
Dialysis tubing closures	55	Blue	10	7.637 102
Dialysis tubing closures	75	Blue	10	7.637 101
Dialysis tubing closures	35	Green	10	7.511 038
Dialysis tubing closures with weight	23	White	10	6.288 664
Dialysis tubing closures with weight	35	White	10	6.238 361
Dialysis tubing closures with weight	55	White	10	6.204 870
Dialysis tubing closures with magnet	35	Red	2	6.238 362

Clips for Biotech membranes available on request.

2 Cell and Tissue Culture Dishes, non-treated, PS, sterile



Dishes with non-treated surface, suitable for proliferation of suspension cell and tissue.

- Easy and secure stacking
- Sterilized by gamma irradiation
- Pyrogen-free



Diam. mm	Height mm	Culture surface cm ²	PK	Cat. No.
18	12	12.0	300	4.672 533
33	13	8.5	960	4.672 534
52	18	21.2	600	4.672 535
55	14	3.3	600	4.672 536
68	15	36.3	600	4.672 537
85	17	55.0	500	4.672 538
88	22	60.8	300	4.672 539
136	22	143.0	120	4.672 540
136	22	143.0	100	4.672 541

3 Cell and Tissue Culture Dishes, treated, PS, sterile



Dishes with treated surface, suitable for adhesion cells.

- Easy and secure stacking
- Sterilized by gamma irradiation
- Pyrogen-free



Diam. mm	Height mm	Culture surface cm ²	PK	Cat. No.
18	12	12.0	300	4.672 542
33	13	8.5	960	4.672 543
52	18	21.2	600	4.672 544
55	14	3.3	600	4.672 545
68	15	36.3	600	4.672 546
85	17	55.0	500	4.672 547
88	22	60.8	300	4.672 548
136	22	143.0	120	4.672 549
136	22	143.0	100	4.672 550

1



1

Cell and Tissue Culture Dishes, Nunc™ EasYDish™, PS, sterile

Nunc™ EasYDish™ improves the handling, stacking and transport of culture dishes. *Thermo Scientific*
A bevelled grip ring facilitates handling even with gloves and the proprietary notch design ensures maximum ventilation with consistent sterility. A raised outer edge on the dish lid enables very stable stacking and more safety during transport. Orientation marks on the dish bottom simplify the localization of cells under the microscope.

- Standard Nunclon™Δ surface treatment to maximize adhesion for most cell types
- RNase/DNase free, human DNA free
- Non-cytotoxic, pyrogen-free
- Gamma irradiation (SAL of 10⁻⁶)
- Shelf life 5 years from manufacturing date
- With certificate of quality

Working volume	Diam.	Height	Culture surface	PK	Cat. No.
ml	mm	mm	cm ²		
3	35	13	88.0	500	4.662 328
5	60	16	21.5	280	4.662 329
12.5	100	17	56.7	150	4.662 330
12.5	100	21	56.7	240	4.662 331
35	150	21	145.0	80	4.662 332

2



2

Cell Culture Dishes, Nunclon™Δ Surface, PS, treated, sterile

Surface treated dishes for cell culture available in various sizes and formats are optically clear and suitable for microscopy. Nunclon™Δ surface modification is certified pyrogen-free and tested for both monolayer formation and cloning efficiency employing primary cells as well as repeating cell lines. Sterile. With lid. *Thermo Scientific*
Material: Polystyrene

Working volume	Dimensions	Height	Culture surface	PK	Cat. No.
ml	mm	mm	cm ²		
3	Ø 35	10	8.8	500	9.407 393
5	Ø 60	15	21.5	400	9.407 395
12.5	Ø 100	15	56.7	150	9.407 398
12.5	Ø 100	20	56.7	240	9.407 401
35	Ø 150	20	145.0	80	9.407 399

3



3

Cell Culture Tubes Nunc™, PS, sterile

The surface of the tubes is coated with Thermo Scientific™ Nunclon™ Δ and designed for the cultivation of adherent cell cultures. With cap made of PE. *Thermo Scientific*

- Tubes with flat side provide 5.5 cm² culture surface
- Suitable for microscopy, use of cover glasses possible
- Leakproof

Working volume	Diam.	Height	Base	Cover type	PK	Cat. No.
ml	mm	mm				
3	16	110	flat side	screw cap	450	6.510 332
7	14	100	round	screw cap	600	9.407 230
7	13	100	round	push-on lid	600	4.008 816

1 Cell culture flasks, treated, PS, sterile

These cell culture flasks with treated surfaces for the cultivation of adherent cells are available with different growth areas from 12.5 to 182 cm². Available with vented or plug-seal caps made from polyethylene. Vented caps contain a 0.22 µm hydrophobic filter to allow gas exchange and minimize risk of cross-contamination. Plug Seal caps can be used in closed systems, providing a liquid and gas sheer seal, but by simply unscrewing the cap one quarter of a turn, this cap can also be used in an open system.

Features:

- Innovative angled neck design offers good pipette and cell scraper access
- Upper triangular and wider base shape provides stability
- Stackable
- Special writing area near the neck
- Engraved graduation on both flask sides
- Sterilized by gamma irradiation
- Pyrogen-free

Material: Polystyrene



Working volume ml	Neck thread mm	Culture surface cm ²	Neck	Cover type	PK	Cat. No.
20	45	12.5	angled	standard	200	4.675 617
20	45	12.5	angled	vented	200	4.675 618
40	45	25.0	angled	standard	200	4.675 619
40	45	25.0	angled	vented	200	4.675 620
75	45	75.0	angled	standard	100	4.675 621
75	45	75.0	angled	vented	100	4.675 622
400	45	182.0	angled	standard	40	4.675 623
400	45	182.0	angled	vented	40	4.675 624
800	45	300.0	angled	standard	18	6.314 340
800	45	300.0	angled	vented	18	6.314 339

2 Cell Culture Flasks, Nunclon™Δ Surface, PS/HDPE, sterile

Nunclon™Δ cell culture flasks with surface areas from 25 to 175cm² are available with filter caps or Vent/Close caps for good gas exchange. Short, wide neck (angled or straight) allows easy access to entire growth surface. The Nunclon™Δ treatment is limited to the intended growth area. Neck areas are not treated to prevent cell attachment and growth in undesired areas. Certified pyrogen-free and tested for both monolayer formation and cloning efficiency employing primary cells as well as repeating cell lines. Sterile. Material flasks: Polystyrene
Material caps: HDPE

Thermo Scientific

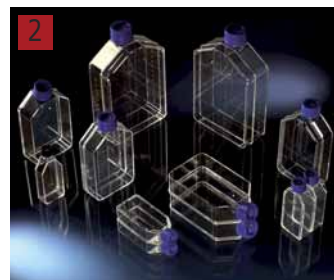

Working volume ml	Culture surface cm ²	Neck	Cover type	PK	Cat. No.
7	25	Angled	Filter	160	9.390 345
7	25	Angled	Vent/Close	160	9.407 027
30	80	Straight	Filter	50	9.390 346
30	80	Straight	Vent/Close	50	9.407 077
68	175	Straight	Filter	32	9.390 348
68	175	Straight	Vent/Close	32	9.407 152

3 Cell Culture Flasks EasYFlask™, treated, PS/HDPE, sterile

Cell culture flasks with Nunclon™Δ. Surface modifications are certified pyrogen-free and tested for monolayer formation and cloning efficiency with primary and immortalized cell lines. Sterile. Bottleneck at an angle. Sterile Material flasks: Polystyrene
Material caps: HDPE

Thermo Scientific



Working volume ml	Culture surface cm ²	Surface	Neck	Cover type	PK	Cat. No.
7	25	Nunclon™	Angled	Filter	200	9.390 331
7	25	Nunclon™	Angled	Vent/Close	200	9.390 330
25	75	Nunclon™	Angled	Filter	100	9.390 333
25	75	Nunclon™	Angled	Vent/Close	100	9.390 332
55	175	Nunclon™*	Angled	Filter	30	7.510 686
55	175	Nunclon™*	Angled	Vent/Close	30	4.008 552
70	225	Nunclon™*	Angled	Filter	30	6.236 539
70	225	Nunclon™*	Angled	Vent/Close	30	4.008 625
7	25	Collagen I	Angled	Filter	60	4.009 044
25	75	Collagen I	Angled	Filter	30	6.244 028
55	175	Collagen I	Angled	Filter	30	4.009 123
7	25	Poly-D-Lysin	Angled	Filter	60	4.009 043
25	75	Poly-D-Lysin	Angled	Filter	30	4.008 945
55	175	Poly-D-Lysin	Angled	Filter	30	4.009 122

* Batch no. and cat. no. printed on each flask.



1 Cell Culture Flasks EasyFlask™/TripleFlask™, non-treated, PS/HDPE, pyrogen-free

Non-treated, sterile flasks for suspension cell cultures. White caps for easy identification.
Pyrogen-free.
Material flasks: Polystyrene
Material caps: HDPE

Thermo Scientific

Type	Working volume ml	Culture surface cm ²	Neck	PK	Cat. No.
EasyFlask™	7	25	curved	200	6.702 724
EasyFlask™	30	75	curved	100	6.222 672
EasyFlask™	55	175	curved	30	7.900 288
TripleFlask™	200	500	straight	32	7.900 289



2 Cell culture flasks TripleFlask Nunclon™ Surface, PS/HDPE, sterile

Cell culture flasks with three parallel growth surfaces provide a total culture area of 500 cm² - with external dimensions of a 175 cm² standard flask. Ideal for scale-up.
Available with Vent/Close caps or filter caps for good gas exchange. Certified pyrogen-free and tested for both monolayer formation and cloning efficiency employing primary cells as well as repeating cell lines. Sterile
Material flasks: Polystyrene
Material caps: HDPE

Thermo Scientific

Working volume ml	Culture surface cm ²	Neck	Cover type	PK	Cat. No.
200	500	Straight	Filter	32	9.390 351
200	500	Straight	Vent/Close	32	9.390 350

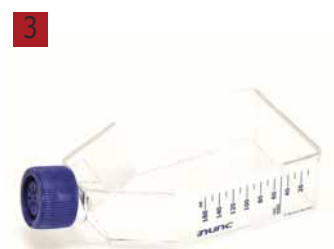

3 Cell Culture Flasks, Nunclon™ Sphera™

Optimizing spheroid formation

- Allows cells to grow in suspension with virtually no cell attachment
- Supports many different cell types and their ability to generate spheroids
- Enables consistent, repeatable cell growth

Growing 3D cancer cultures

- Minimizes variability and supports the consistent formation of cancer spheroids that simulate the 3D structures of tumor growth, providing a better model system for studying tumor cell progression and efficacy of anticancer agents in vitro

Promoting formation of embryoid bodies (EB)

- Demonstrates superior quality for embryoid body formation of pluripotent stem cells with minimal spontaneous differentiation
- Resultant cells are able to differentiate into all three germ layers

Certifications/Compliance

- Free of animal products
- Pyrogen-free: Endotoxin tested (0.5 EU/mL)
- Biologically inert: USP biological reactivity class VI
- High level of sterility: SAL 10⁻⁶, ethylene oxide gas sterilization

Thermo Scientific

Working volume ml	Culture surface cm ²	Neck	Cover type	PK	Cat. No.
7	25	angled	filter	18	6.265 520
25	75	angled	filter	24	6.265 521

➔ CO₂ incubators please see chapter 7.

1 Cell Culture Flasks DURAN® TILT

The smart, reusable bottle system for cell culture media preparation. *DWK Life Sciences*
DURAN® TILT is perfectly designed for making work in biosafety cabinets and clean hoods safer and easier. The innovative features of the DURAN® TILT bottle changes everything. The TILT bottle has two positions: upright for filter sterilization or storage, and tilted at 45° for pipetting.



- The innovative design enables both good aseptic and ergonomic practice.
- The GL 56 mouth has a 100 % bigger opening than the standard GL 45 mouth for easier pipetting.
- The ergonomically shaped GL 56 screw cap is easy to open and close. Made from a non-cytotoxic polymer.
- Vacuum resistant glass bottle for the safe filter sterilisation of media.
- Space saving shape for fridge storage and warming media in a water bath
- Low bottle height is practical in the biosafety cabinet.
- Tilted volume indicators for convenience
- Manufactured from DURAN® borosilicate 3.3 glass for reusability and lower whole life costs.

Accessories please order separately.

Description	Capacity ml	Height with cap mm	Thread	PK	Cat. No.
Cell Culture Flasks DURAN® TILT	500	151	GL 56	1	6.270 514

Suitable accessories can be found in our online shop.

2 | 3 Microscope slide Lab-Tek™ Chamber Slide™ System, PS

Chamber slides eliminate the need for cell transfer prior to visualisation/staining. Upper structure can be removed when culturing is complete. Useful for viral and mycoplasma testing, chromosome studies, toxicity tests and immunocytology. Sterile. The chemically coated growth surface of the Lab-Tek™II-CC² Chamber Slide System mimics polylysine and provides binding sites optimal for fastidious cells (e.g. neurons). Material chamber: Polystyrene *Thermo Scientific*

- Lab-Tek™: Sealant: Non-toxic medical grade silicone.
- Lab-Tek II™: Sealant, biocompatible acrylic adhesive.
- Lab-Tek II - CC²: modified glass slide, chemically coated to mimic polylysine.

Type	No. of chambers	Material	Working volume ml	Culture surface cm ²	PK	Cat. No.
Lab-Tek™	1	Glass	2.5-4.5	9.4	96	4.675 491
Lab-Tek™	1	Permanox™	2.5-4.5	9.4	16	7.624 247
Lab-Tek™	2	Glass	1.2-2.0	4.2	96	4.675 492
Lab-Tek™	2	Permanox™	1.2-2.0	4.2	96	4.675 506
Lab-Tek™	4	Glass	0.5-0.9	1.8	96	4.675 497
Lab-Tek™	4	Permanox™	0.5-0.9	1.8	96	4.675 489
Lab-Tek™	8	Glass	0.2-0.4	0.8	96	4.675 487
Lab-Tek™	8	Permanox™	0.2-0.4	0.8	96	4.675 507
Lab-Tek™	16	Glass	0.1-0.2	0.4	96	4.675 485
Lab-Tek II™	1	Glass	2.0-4.5	8.6	96	4.675 495
Lab-Tek II™	2	Glass	1.0-2.0	4.0	96	4.675 494
Lab-Tek II™	4	Glass	0.5-1.0	1.7	96	4.675 504
Lab-Tek II™	8	Glass	0.2-0.5	0.7	96	4.675 503
Lab-Tek II - CC ²	1	modif. Glass	2.0-4.5	8.6	96	4.675 486
Lab-Tek II - CC ²	2	modif. Glass	1.0-2.0	4.0	96	4.675 499
Lab-Tek II - CC ²	4	modif. Glass	0.5-1.0	1.7	96	4.675 498
Lab-Tek II - CC ²	8	modif. Glass	0.2-0.5	0.7	96	4.675 490

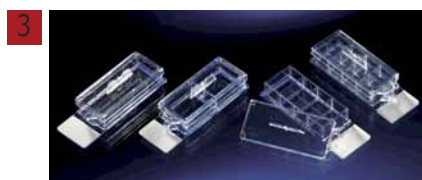
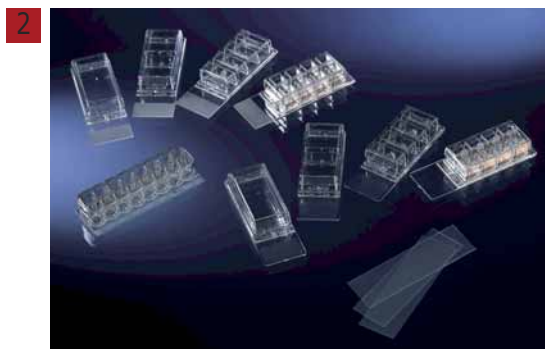

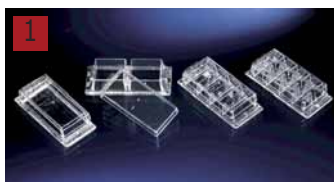

1 Chambered Coverglass Lab-Tek™ und Lab-Tek™ II, PS, sterile

Excellent for confocal image analysis and optimal for high power inverted microscopic viewing. Sterile.

Thermo Scientific

Material chamber: Polystyrene
Material slide: Glass

Lab-Tek™: connection between the chamber (s) and slides from non-toxic, medical silicone.
Lab-Tek™ II: connection between the chamber (s) and slides of biocompatible acrylic adhesive.
Medium chamber is not removable.

Type	No. of chambers	Material	Working volume	Culture surface	PK	Cat. No.
			ml	cm ²		
Lab-Tek™	1	Glass	2.2-4.5	9.4	96	4.675 505
Lab-Tek™	2	Glass	1.2-2.0	4.2	96	4.675 496
Lab-Tek™	4	Glass	0.5-0.9	1.8	96	4.675 488
Lab-Tek™	8	Glass	0.2-0.4	0.8	96	4.675 508
Lab-Tek™ II	1	Glass	2.0-4.5	8.6	96	4.675 500
Lab-Tek™ II	2	Glass	1.0-2.0	4.0	96	4.675 493
Lab-Tek™ II	4	Glass	0.5-1.0	1.7	96	4.675 501
Lab-Tek™ II	8	Glass	0.2-0.5	0.7	96	4.675 502



2 Cell Culture Plates, non-treated, PS, sterile

NEW

Standard surface non-treated cell culture plates. Reduced evaporation due to raised well rims and uniform rings on the lids.

- Available with 4-, 6-, 12-, 24-, 48-, 96- or 384-wells (lid included)
- Flat well bottom
- 96-well plate also available as round bottom plate (4.672 531)
- Single position lid reduces the risk of cross-contaminations
- Wells are labeled with alphanumeric code for easy identification
- Sterilized by gamma irradiation
- Pyrogen-free
- Material: Polystyrene

Working volume	No. of wells	PK	Cat. No.
ml			
1.96	4	100	4.672 525
2.90	6	100	4.672 526
1.14	12	100	4.672 527
0.57	24	100	4.672 528
0.29	48	100	4.672 529
0.20	96	100	4.672 530
0.38	96	100	4.672 531
0.11	384	100	4.672 532



3 Multidishes, non-treated, PS, sterile

Thermo Scientific

Non-treated, sterile multidishes for suspension cell cultures are available in formats from 4 up to 48 wells. Raised well rims lower the risk of cross contamination. Excellent optical quality. Pyrogen-free. With lid.

Material dishes and lids: Polystyrene

Working volume	No. of wells	PK	Cat. No.
ml			
1	4	120	6.223 971
3	6	75	6.803 562
2	12	75	7.623 040
1	24	75	6.222 953
0.5	48	75	6.207 164

1 Cell Culture Plates, treated, PS, sterile

These standard surface treated cell culture plates for the cultivation of adherent cells exhibit a reduced evaporation due to raised well rims and uniform rings on the lids.

- Available with 4-, 6-, 12-, 24-, 48-, 96- or 384-wells (lid included)
- Flat well bottom
- 96-well plate also available as round bottom plate (6.267 171)
- Single position lid reduces the risks of cross-contaminations
- Wells are labeled with alphanumeric code for easy identification
- Sterilized by gamma irradiation
- Pyrogenfree
- Material: Polystyrene



Working volume	Culture surface	No. of wells	PK	Cat. No.
ml	cm ²			
1.96	1.96	4	100	4.672 523
2.90	9.60	6	100	6.267 166
1.14	3.85	12	100	6.267 167
0.57	1.93	24	100	6.267 168
0.29	0.84	48	100	6.267 169
0.20	0.33	96	100	6.267 170
0.20	0.58	96	100	6.267 171
0.10	0.11	384	100	4.672 524

2 Multidishes, Nunc™ cell culture treated surface, PS, sterile

4- to 48-well multidishes with Nunclon™Δ treated surface. 6-well plates also available with Poly-D-Lysine and Collagen I coating. Raised well rims lower the risk of cross contamination. Excellent optical quality. All available surface modifications are certified pyrogen-free and tested for both monolayer formation and cloning efficiency employing primary cells as well as repeating cell lines. Sterile. With lid. Material dishes and lids: Polystyrene

Thermo Scientific



Description	Working volume	Culture surface	No. of wells	PK	Cat. No.
	ml	cm ²			
Nunclon™Δ, Flat	1	1.9	4	120	6.050 151
Nunclon™Δ, Flat	5	21.8	4	100	4.009 034
Nunclon™Δ, Flat	3	9.6	6	75	9.390 401
Nunclon™Δ, Flat	3	9.6	6	85	9.390 402
Poly-D-Lysin, Flat	3	9.6	6	20	4.008 850
Collagen I, Flat	3	9.6	6	20	4.008 874
Nunclon™Δ, Flat	3	10.5	8	100	4.009 045
Nunclon™Δ, Flat	2	3.5	12	75	9.390 403
Nunclon™Δ, Flat	1	1.9	24	75	9.390 410
Nunclon™Δ, Flat	1	1.9	24	85	7.634 155
Nunclon™Δ, Flat	0.5	1.1	48	75	9.390 411
Nunclon™Δ, Flat	0.5	1.1	48	85	6.206 402



BRANDplates® - A complete premium-quality line - for every application!

Microplates for Cell Culture (sterile)

BRAND

Cell culture is increasing in popularity in the research and development area. Outside of basic research, cells are cultivated today for a number of reasons, including the production of proteins and in particular as assay systems. As cell cultures can sometimes be quite demanding regarding their environment, the disposables used for cultivation have to be of highest quality. The four different cell culture surfaces of the BRANDplates® allow the optimum combination between microplate and specific cell line.

cellGrade™

Standard plate for the cultivation of adherent cell cultures. PS-surface with different chemical groups, like e.g. carboxyl and hydroxyl groups, that are freely accessible. Surface is hydrophilic compared with non-treated PS.

cellGrade™ plus

For cultivation of fastidious cell cultures. In addition to carboxyl and hydroxyl chemical groups, free amino groups are present on the surface. The surface has a protein-like composition; cells can directly attach and spread out. Cells adhere faster, better rate of yield. Suited for serum reduced cultivation of cells.

cellGrade™ premium

Poly-D-Lysine-equivalent surface, with analogous results regarding growth performance and cell morphology. Optimal adhesion of cells to the surface reduces cell damage when washing frequently. Surface suited for serum-free and serum-reduced cultivation of cells. Good shelf life at room temperature.

inertGrade™

For cultivation of suspension cell cultures. Especially suited for cell cultures, when adhesion is not desired. Optimized surface characteristics reducing cell adhesion and protein adsorption, enzyme and cellular activation is minimized. Stem cells can be prevented from early differentiation.

Colours, wells and shapes:

- 96-, 384- and 1536-well format
- sterile according to Ph.Eur. and USP 29, SAL 10⁻⁶
- standard or transparent bottom
- transparent, white or black
- various well bottom shapes: U-, V-, F-, C-bottom for 96-well format
- clearly distinguishable via colour code: orange embossed alphanumeric coding for 96-well standard
- free from endotoxins (< 0.01 EU/ml), DNase, DNA, RNase, non-cytotoxic (according to ISO 10993)
- Sterile Products comply with ISO 11137 and AAMI guidelines. A SAL of 10⁻⁶ is reached. Supplied individually wrapped with lid.
- ANSI/SLAS format

You can find ordering information for all articles described above as well as other articles online.

1

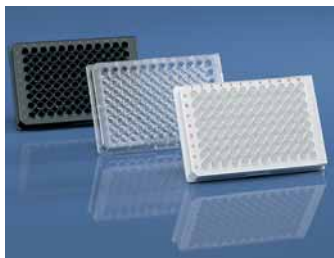

1 cellGrade™

PS, sterile. For standard cell culture applications.

BRAND

Description	Bottom shape/ Well volume µl	PK	Cat. No.
96-well, transparent	U / 330	50	4.000 329
96-well, transparent	V / 360	50	4.000 330
96-well, transparent	F / 350	50	4.000 331
96-well, transparent	C / 350	50	4.000 332
96-well, white	F / 350	50	4.000 333
96-well, black	F / 350	50	4.000 334
96-well, white / transparent	F / 330	50	4.000 335
96-well, white / transparent	F / 330	5	6.272 015
96-well, black / transparent	F / 330	50	4.000 336
96-well, black / transparent	F / 330	5	6.272 016
384-well, transparent	F / 100	50	4.000 337
384-well, white	F / 100	50	4.000 338
384-well, black	F / 100	50	4.000 339
384-well, white / transparent	F / 120	50	4.000 343
384-well, white / transparent	F / 120	5	6.272 017
384-well, black / transparent	F / 120	50	4.000 344
384-well, black / transparent	F / 120	5	6.272 018
1536-well, transparent	F / 10	50	4.000 345
1536-well, white	F / 10	50	4.000 346
1536-well, black	F / 10	50	4.000 347

Further products can be found in our online shop.



1 F96 MicroWell™ Plates, PS

Clear, white or black plates with excellent optical clarity and flat bottom wells.
Nunclon™Δ, MaxiSorp™, PolySorp™, Collagen I, Poly-D-Lysine surface modifications suitable for cell culture assays.
Material plates: Polystyrene
Total volume µl/well: 400

Thermo Scientific

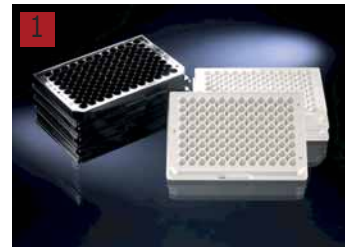

Surface	Colour	Sterile	Lid	PK	Cat. No.
Nunclon™Δ	Clear	+*	+	160	6.803 751
Nunclon™Δ	Clear	+*	+	50	9.407 473
Nunclon™Δ	White	+*	+	50	6.802 646
Nunclon™Δ	Black	+*	+	50	6.802 647
Collagen I	Clear	-**	+	20	4.008 866
Poly-D-Lysin	Clear	-**	+	20	4.008 858
Cell culture	Clear	+	-	180	4.008 767
Cell culture	Clear	+	-	50	9.407 475
Non-treated	Clear	-	-	180	6.222 441
Non-treated	Clear	-	+	160	7.603 959
Non-treated	Clear	-	-	60	9.390 514
Non-treated	Clear	+	+	160	6.237 877
Non-treated	Clear	+	-	180	4.008 715
Non-treated	Clear	+	-	50	9.390 515
Non-treated***	Clear	-	-	180	4.008 780
Non-treated***	Clear	+	+	160	6.803 101
Non-treated	White	+	+	50	6.231 848
Non-treated	White	+	+	160	6.510 546
Non-treated	White	-	-	180	6.201 514
Non-treated	Black	+	+	50	7.601 891
Non-treated	Black	-	-	180	6.228 233

* certified.

**Produced in clean environment.

***with Barcode

2 F96 Well Optical Bottom Plates, PS

- Nunclon™Δ surface for cell culture
- Non-treated plates are optimised for scintillation counting
- White or black upper structure with polymer bottom plates combine the optical clarity of virgin crystalline polystyrene with optimal surface for a wide range of HTS applications
- Working volume range: 50 - 200µl/well

Thermo Scientific

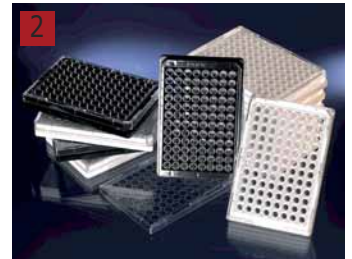

Surface	Colour	Sterile	Lid	PK	Cat. No.
Cell Culture	White	+	+	30	4.008 852
Cell Culture	Black	+	+	30	6.801 890
Non-treated	White	-	-	30	6.231 847
Non-treated	Black	-	-	30	6.901 329

3 96-well plate Nunclon™ Sphera™**Optimizing spheroid formation**

- Allows cells to grow in suspension with virtually no cell attachment
- Supports many different cell types and their ability to generate spheroids
- Enables consistent, repeatable cell growth

Thermo Scientific

Growing 3D cancer cultures

- Minimizes variability and supports the consistent formation of cancer spheroids that simulate the 3D structures of tumor growth, providing a better model system for studying tumor cell progression and efficacy of anticancer agents in vitro

Promoting formation of embryoid bodies (EB)

- Demonstrates superior quality for embryoid body formation of pluripotent stem cells with minimal spontaneous differentiation
- Resultant cells are able to differentiate into all three germ layers

Certifications/Compliance

- Free of animal products
- Pyrogen-free: Endotoxin tested (0.5 EU/mL)
- Biologically inert: USP biological reactivity class VI
- High level of sterility: SAL 10⁻⁶, ethylene oxide gas sterilization
- Shelf Life 4 years



Description	Colour	Surface	Sterile	PK	Cat. No.
round bottom	Clear	Nunclon™ Sphera™	SAL 10 ⁻⁶	1	6.264 322
flat bottom	Clear	Nunclon™ Sphera™	SAL 10 ⁻⁶	1	6.264 323



1 Cell Factories EasyFill™ mit Nunclon™Δ Surface, PS, sterile

A time and space saving vessel for large scale cell culture production. *Thermo Scientific*
Suitable for industrial scale production of vaccines, monoclonal antibodies or pharmaceuticals.
Nunclon™Δ surface modification is certified for cell culture and ensures consistent cell growth layer to layer, lot to lot.
Ready to use and easy to fill and empty with plug and play connection. Wide range of accessories available for different methods of filling, venting and harvesting (please see Cell Factories Accessories). Sterile.
Material cell factories: Polystyrene

Capacity	Culture surface	No. of chambers	PK	Cat. No.
ml	cm²			
200	630	1	6	4.008 721
400	1260	2	6	4.008 786
800	2520	4	4	4.008 806
2000	6300	10	2	4.008 779



2 Bioreactors CELLine™

New line of membrane driven flasks for high density cell culture. The flasks are designed to enhance small scale bio-production for antibodies and proteins. Conventional *in vivo* or *in vitro* cell culture methods can be laborious, may have low cell density and require significant purification. CELLine™ flasks address these three areas of limitation observed in static tissue culture flasks. *DWK Life Sciences*

- Disposable and ready-to-use
- High cell density and high product concentration
- Reduces operation time
- Decreases use of consumables
- Cost-efficient, space saving, and stackable
- No additional equipment required for operation

Type	Culture Type	Media Compartment ml	Cell Compartment ml	PK	Cat. No.
CELLine™ 1000	Suspension	1000	15	1	4.658 779
CELLine™ 1000	Suspension	1000	15	3	4.658 780
CELLine™ 1000-AD	Adherent	1000	15	1	4.658 781
CELLine™ 1000-AD	Adherent	1000	15	3	4.658 782
CELLine™ 350	Suspension	350	5	1	4.658 777
CELLine™ 350	Suspension	350	5	5	4.658 778

Spinner Flasks Celstir® and Magna Flex™

Celstir® and Magna Flex™ spinner flasks from WHEATON® are high-quality products designed for long life, high efficiency and low maintenance. Celstir® spinner flasks are the ideal environment for culturing/growing a wide variety of cells, such as insect cells, hybridomas and many other suspension adapted cells. Magna Flex™ flasks are suitable for microcarrier cultures. Celstir® and Magna Flex™ flasks are produced from autoclavable, Type I borosilicate glass. WHEATON® spinner flasks can be used on all magnetic stirrers. *DWK Life Sciences*

Scope of supply: Flask, stirring unit with lid and lids for side arms.



3 Spinner Flask, double sidearm Celstir®

- For suspension cell culture with a magnetic stirrer *DWK Life Sciences*
- Adjustable paddle impeller and sterile design as stirrer shaft does not protrude through cap
- 1:1 headspace ratio for ideal gas exchange
- Bottom dimple to reduce cell aggregation (dimple on 125mL and larger flasks)
- Autoclavable borosilicate glass that conforms to USP Type I and ASTM E 438 Type I, Class A requirements

Capacity	Dimensions (dia. x H)	Cap size, top	Cap size, sidearms	PK	Cat. No.
ml	mm				
25	38 x 122	38-430	15-415	1	4.658 741
50	38 x 141	38-430	15-415	1	4.658 742
125	65 x 155	51-400	33-430	1	4.658 743
250	85 x 155	51-400	33-430	1	4.658 745
500	110 x 190	100-400	GL 45	1	4.658 747
1000	130 x 250	100-400	GL 45	1	4.658 749
3000	178 x 341	100-400	GL 45	1	4.658 752
6000	258 x 404	100-400	GL 45	1	4.658 753
8000	293 x 445	100-400	GL 45	1	4.658 754

Further models can be found in our online shop.

1 Automated Cell Counter EVE™

EVE™ is a benchtop automatic cell counter designed to accurately and precisely measure cell count and viability of different cell cultures. It uses the standard trypan blue technique.

NanoEn Tek Inc.

- Fine distinction of clumped cells: Accurate results with advanced analysis algorithm
- Broad range of cell sizes and types: Primary (tissue and blood) cell lines and stem cells
- User friendly: Touch screen LCD without any maintenance needed
- Data store analysis: 500 test results, transfer to PC via USB drive
- Cell size gating: Select range of cell size using gating function

EVE™ cell counting slides contain two enclosed chambers which can measure two different samples or perform replicates of the same sample.

Scope of supply: Automated Cell Counter EVE™, one box of Cell Counting Slides (50 slides/100 counts), USB Drive (2 GB), User Manual and Quick Manual.



Description	PK	Cat. No.
Automated Cell Counter EVE™	1	6.284 817

2 Automated cell Counter EVE™ Plus

EVE™ Plus is a benchtop automatic cell counter designed to accurately and precisely measure cell count and viability of different cell cultures. It uses the standard trypan blue technique.

NanoEn Tek Inc.

- Fine distinction of clumped cells: Accurate results with advanced analysis algorithm
- Touch screen interface
- Auto save function up to 500 results
- Data transfer via Wi-Fi
- Acoustic signal after each count

Specifications:

Manual counting time:	1 second or less
Auto focus counting time:	10 seconds or less
Measuring range:	1 x 10 ⁴ ~ 2 x 10 ⁷ cells/ml
Zählbarer Zellgrößenbereich:	5 ~ 60 µm

Type	PK	Cat. No.
Automated cell Counter EVE™ Plus	1	4.669 246



Accessories for automated Cell Counter EVE™

NanoEn Tek Inc.

Description	PK	Cat. No.
EVE™ Cell counting slides incl. 1 x 1.5 ml trypan blue (0.4 %) for 100 counts	50	6.284 818
Test beads for EVE™ cell counter 1 x 1 ml concentration 1.0 x 10 ⁶	1	6.284 819



6.284 818





1 Cell Scrapers, sterile

NEW

Available in two blade designs, scraper and lifter. Material blades TPE and handle ABS.

- Particularly thin, swivelling, flexible blades
- Sterilized by gamma irradiation
- Individually wrapped
- Pyrogen-free

Description	Length mm	PK	Cat. No.
Blade position scraper, 20 mm	250	100	4.672 560
Blade position scraper, 30 mm	390	100	4.672 562
Blade position lifter, 20 mm	250	100	4.672 561
Blade position lifter, 30 mm	390	100	4.672 563



2 Cell Scrapers Rotatable®, sterile

NEW

Free rotating blade to twist easily to the desired direction. Easy changes of the blade angle by slight pressure on the handle. Material blades PE and handle ABS.

- Small raised knobs on the handle for better grip
- Sterilized by gamma irradiation
- Individually wrapped
- DNase/RNase-free
- Pyrogen-free

Description	Length mm	PK	Cat. No.
Scraper, 12.5 mm	230	150	4.672 556
Scraper, 12.5 mm	300	150	4.672 557
Scraper, 19.5 mm	230	150	4.672 558
Scraper, 19.5 mm	300	150	4.672 559



3 Cell Scrapers, sterile

Available in two different lengths with adjustable blade for optimal application flexibility. Pyrogen-free. Sterile.

Thermo Scientific

Width mm	Length cm	Height mm	For bottles cm ²	PK	Cat. No.
15.5	23	7.5	25 - 80	50	6.222 130
17.5	32	16.0	75 - 175	250	9.390 356



4 Cell lifters, PE, sterile

NEW

Flat blade cell lifter for manual harvesting of cells.

- Special blade design minimizes cell damage
- Sterilized by gamma irradiation
- Individually packed
- DNase/RNase-free
- Pyrogen-free

Length mm	PK	Cat. No.
23.4	100	4.672 555



5 Cell lifters, with blade or hook, PE, sterile

NEW

Cell lifter with flat blade on one end and exchangeable J-hook or narrow blade on the other end. For manual cell harvesting, also for multiwell plates or microcentrifuge tubes.

- Special blade design minimizes cell damage
- Sterilized by gamma irradiation
- Individually packed
- DNase/RNase-free
- Pyrogen-free

Description	Colour	PK	Cat. No.
J-Hook, 9.0 mm	green	100	4.672 553
Narrow Blade, 2.5 mm	green	100	4.672 554

1 LLG-Cell strainers, Nylon, sterile

Cell strainers are especially suited for the generation of homogenous single cell suspensions from tissue or primary cell lysates

- Available in 3 mesh sizes, 40 µm: 70 µm, and 100 µm
- Colour coded mesh size
- Designed to fit into 50 ml tubes
- Individually packaged
- Handle and mantle surface for improved aseptic handling
- Nylon mesh
- Pyrogen-free

Mesh size µm	Colour code	PK	Cat. No.
40	blue	50	6.268 093
70	white	50	6.268 092
100	yellow	50	6.268 091



2 Cell strainers Flowmi™



Bel-Art Products

Scienceware® Flowmi™ Cell Strainers provide fast and efficient filtering of small volume samples (up to 1000µl) prior to FLOW or FACS analysis. Removes cell aggregates and creates uniform single cell suspensions.

- Flowmi™ fits most 1000 µl tips
- Compact tray holds 50 Flowmi™ Cell Strainers
- Sliding cover for easy, one-handed use
- Sterile, packaged in a re-sealable bag

Mesh size µm	PK	Cat. No.
40	50	6.261 977
70	50	6.268 917



Freezing Aid for Cell Cultures, FreezerCell™

FreezerCell™ can be used for a variety of cell types, including stem cells, primary cells, cell lines and yeasts. The FreezerCell™ does not require any additives and only needs to be placed in an ultra deep freezer and the cooling runs at -1°C per minute. Fill the freezing aid with the cryotubes and freeze for approx. 3 hours at -80 °C. Then the samples are ready to transfer to a nitrogen tank. This gentle method ensures a high survival rate of the cells during the freezing process.

- No pre-cooling necessary
- Consistent temperature distribution, even with partial loading
- Lid can be opened easily

Type	Dimensions (W x D x H) mm	PK	Cat. No.
Hexagon shape for 12 tubes	108 x 108 x 100	1	4.665 863
Square shape for 12 tubes	117 x 117 x 100	1	4.665 865



4.665 863



4.665 865

5 Nalgene Freezing container Mr. Frosty, PC

With 120mm diameter screw cap in blue HDPE, vial holder made of white HDPE. Suitable for 18 x 1.2/2.0ml cryovials. Foam interior. Cooling rate 1°C/min. Tubes can be easily removed. Each aperture has a moulded number for identification. Stackable.

Thermo Scientific

For tubes ml	Diam. mm	Height mm	No. of tubes	PK	Cat. No.
1.0-2.0	117	86	18	1	9.400 945
3.6	117	151	12	1	9.400 990
4.5-5.0	117	151	12	1	9.400 991



1 Semi-Micro Osmometer K-7400S

The K-7400S Semi-Micro Osmometer enables the measurement of osmolality and freezing point of aqueous solutions.

KNAUER

Determination of the total concentration of all dissolved particles in a solution. All dissolved components of a liquid are collected and will be displayed in a separate value. This makes it particularly suitable for quality control and research laboratories. The standalone device can optionally be equipped with a printer. Furthermore, the device can be controlled via a PC using the EuroOsmo 7400 software (please order separately).

- Sample volume of only 50 µl
- LCD display
- User-friendly menu guidance
- Fast, easy and automatic measurements
- High reproducibility
- Peltier cooler

Scope of supply: Osmometer with measuring head, incl. sample vessels and calibration standards

Specifications

Sample volume:	50...150 µl
Osmolality range:	0...2000 mOsmol/kg
Measurement duration:	approx. 2 min.
Measurement precision	
SD:	≤ 4 mOsmol/kg (0...400 mOsmol/kg)
RSD:	≤ 1 % (400...2000 mOsmol/kg)
Linearity:	±1 % (0...1500 mOsmol/kg) ±1.5 % (0...2000 mOsmol/kg)
Display:	LCD
Ambient conditions:	10...35 °C, 20...80 % relative humidity (non-condensing)
Dimensions (W x D x H):	160 x 340 x 182 mm
Weight:	5.3 kg
Power supply:	100-240 V, 50/60 Hz, 70 W

Type	PK	Cat. No.
Semi-Micro Osmometer K-7400S	1	6.287 298



2 Osmolality standards

Osmolality Standards for calibration and control, compatible with all types of osmometers. Extensive range: 50 to 3000 mOsmol/kg H₂O, ISO 17025 certified. Values from 100 to 700 mOsmol/kg H₂O according to European Pharmacopoeia 2.2.35 and US Pharmacopoeia 785. 12 ampoules of 5 ml each.

Reagecon



Type	Description	PK	Cat. No.
RE-OSM-50	50 mOsmol/kg H ₂ O	12	6.286 326
RE-OSM-100	100 mOsmol/kg H ₂ O	12	6.286 324
RE-OSM-200	200 mOsmol/kg H ₂ O	12	6.286 325
RE-OSM-290	290 mOsmol/kg H ₂ O	12	6.280 786
RE-OSM-300	300 mOsmol/kg H ₂ O	12	6.284 310
RE-OSM-400	400 mOsmol/kg H ₂ O	12	7.970 554
RE-OSM-500	500 mOsmol/kg H ₂ O	12	6.270 201
RE-OSM-600	600 mOsmol/kg H ₂ O	12	6.286 327
RE-OSM-700	700 mOsmol/kg H ₂ O	12	6.286 328
RE-OSM-850	850 mOsmol/kg H ₂ O	12	6.286 334
RE-OSM-900	900 mOsmol/kg H ₂ O	12	6.286 335
RE-OSM-1000	1000 mOsmol/kg H ₂ O	12	6.286 329
RE-OSM-1500	1500 mOsmol/kg H ₂ O	12	6.286 330
RE-OSM-2000	2000 mOsmol/kg H ₂ O	12	6.286 331
RE-OSM-2500	2500 mOsmol/kg H ₂ O	12	6.286 332
RE-OSM-3000	3000 mOsmol/kg H ₂ O	12	6.286 333

1 LLG-Serological pipettes, PS, sterile

Serological pipettes from LLG are ideally suited for sterile serological and cell culture applications. Easy to read graduation scales facilitate volume measurement and dosing. All LLG serological pipettes are plugged, sterile, pyrogen-free and have an increased volume capacity through extra graduations.

- Also available as short-pipettes (5 ml, 10 ml and 25 ml) or wide-mouth pipette (10 ml)
- 1 ml, 5 ml, 10 ml, 25 ml and 50 ml pipettes contain a bi-directional secondary graduation scale for precise dosing
- Colour coded ringmark for easy volume identification
- Single packed in easy-to-open plastic/paper packaging

Volume ml	Grad. ml	Colour code	Negative graduations	PK	Cat. No.
1	1/100	yellow	0,3	500	9.380 440
2	1/50	green	0,6	500	9.380 441
5	1/10	blue	3	200	7.930 401
10	1/10	orange	3	200	6.268 240
10	1/10	orange (wide mouth)	3	200	9.380 442
25	2/10	red	8	150	7.930 403
50	5/10	purple	10	100	9.380 443
5	1/10	blue (short form)	3	200	6.265 881
10	2/10	orange (short form)	10	150	6.265 882
25	5/10	red (short form)	9	100	6.265 883



2 Serological pipettes, PS, bulk package, sterile

- Single packed in bulk package
- Increased volume capacity through extra graduations
- Colour coded for easy volume identification
- Plugged, filters/plugs made of PET
- Pyrogen-free
- DNase-/RNase-free
- Free of human DNA
- Sterile

Thermo Scientific

Plastic/Plastic-Peel packaging

Capacity ml	Grad. ml	additional scale ml	Tolerance \pm ml	Colour code	PK	Cat. No.
1	1/100	0.3	0.02	yellow	1000	9.380 464
2	1/100	0.3	0.04	black	500	9.380 465
5	1/10	2	0.10	blue	200	9.380 466
10	1/10	3	0.20	orange	200	9.380 467
25	2/10	10	0.50	green	200	9.380 468
50	2/10	10	0.75	purple	100	9.380 469



3 Graduated pipettes for tissue culture, clear glass, amber stain graduation

EX (TD) calibrated. Short form. Main point ring graduation. Specially for tissue culture and working on cleanroom benches. With durable amber stain graduation. Zero to the tip, cotton plugged (8mm outer diameter). With mouth piece for cotton plug.

Hirschmann

Volume ml	Grad. ml	Overall length \pm 3 mm	PK	Cat. No.
1	0.1	230	1	6.080 498
2	0.1	230	1	6.090 340
5	0.1	230	1	6.080 523
10	0.1	230	1	6.510 172
25	0.2	230	1	6.510 335

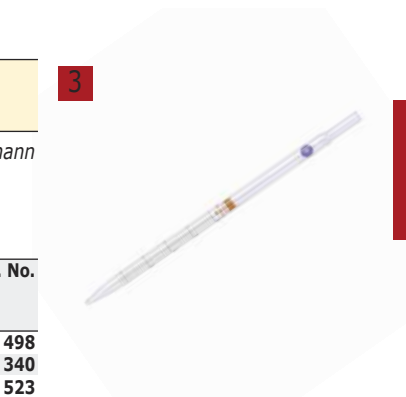



1 2 LLG-Electrical pipette Plus



Ergonomic and precise - the cordless and lightweight LLG-Electrical pipette Plus enables fast and exact pipetting with glass and plastic pipettes.

- UV resistant housing
- Fatigue-proof pipetting due to ergonomically shaped handle
- Suitable for left and right handers
- Exchangeable filters protect the device mechanism from contamination
- LED display with speed display: High, Low or Gravity mode (for free liquid flow without drive operation)
- 5 different coloured autoclavable nose pieces and labelling area enables customisation of the pipette
- Extremely quiet and powerful drive
- Low-Battery LED indicator



Scope of supply: Charger (5 V micro USB), Li-Ion battery, 5 coloured nose pieces, 3 membrane filters, adapter for 1 ml pipettes, benchtop rack, magnetic wall mounting

Specifications

Membrane filters:	PTFE/Ø 25 mm /0.45 µm
Capacity:	1 to 100 ml, glass and plastic pipettes
Pipette attachment:	Polypropylene, autoclavable
Dimensions:	15 x 152 x 41 mm
Weight:	approx. 200 g
Power supply:	rechargeable Li-Ion battery, 8 h continuous operation
Warranty:	1 year

Description	PK	Cat. No.
LLG-Electrical pipette Plus	1	9.281 041
Membrane filter, 0.45µm, PTFE, non-sterile	5	9.281 005
Replacement accu	1	6.267 647



3 4 Disposable Erlenmeyer Flasks Nalgene™ with vented closure, Type 4115, 4116, PETG, sterile

With blue vented closure, the chance for cross contamination is reduced. Ideal for shaker and suspension cell culture, media preparation or storage. Made of light, crystal clear PETG. Molded-in graduations. Leak-proof HDPE closure has a hydrophobic 0.2µm PTFE membrane that allows sterile air exchange. Flasks offer a 5-year shelf life, a 10⁻⁶ SAL, are non-pyrogenic and non-cytotoxic. Available with flat or baffled bottom. Individually packaged for easy storage and handling.

Thermo Scientific



Type	Description	Capacity ml	Cover type	PK	Cat. No.
4115	Flat Bottom	125	38-430	24	6.234 530
4115	Flat Bottom	250	38-430	12	6.231 087
4115	Flat Bottom	500	45-430	12	9.141 304
4115	Flat Bottom	1000	45-430	6	9.141 305
4115	Flat Bottom	2000	45-430	4	9.141 306
4115	Flat Bottom	2800	70	4	9.141 307
4116	Baffled Bottom	125	38-430	24	9.141 308
4116	Baffled Bottom	250	38-430	12	9.141 309
4116	Baffled Bottom	500	45-430	12	9.141 310
4116	Baffled Bottom	1000	45-430	6	9.141 311
4116	Baffled Bottom	2000	45-430	4	9.141 312
4116	Baffled Bottom	2800	70	4	9.141 313



5 Bottle InVitro™ Biotainer™ Nalgene™, Type 3030, 3120, 3233, 3405, 3410, 3423, PC, sterile

Light blue, with PP screw cap with silicone seal. Providing safe storage from -100 to 99 °C. With printed graduations in ml. With ribbed hand-grips (except 125 ml and 5000 ml). Meets USP 87, 88 and are tested for pyrogenicity.

Thermo Scientific

Type	Capacity ml	Cover type	PK	Cat. No.
3030	125	38 mm	50	4.675 587
3120	1000	48 mm	35	4.675 588
3233	2000	48 mm	20	4.675 589
3405	5000	48 mm	6	4.675 591
3405	5000	48 mm*	6	4.675 590
3410	10000	48 mm	2	4.675 593
3410	10000	48 mm*	2	4.675 592
3423	20000	48 mm	3	4.675 594

* with PE-handle.

1 InVitro™ Biotainer™-Bottle Nalgene™, Type 3025, 3005, 3110, 3230, 3415, PETG, sterile

With PE screw cap with silicone seal. Ready to use. With printed graduations in ml. *Thermo Scientific*
With ribbed hand-grips (except 125 ml and 5000 ml). Materials meet current USP VI, are non-cytotoxic and pyrogen-free.



Type	Capacity ml	Cover type	PK	Cat. No.
3025	125	38 mm	100	4.675 530
3005	500	38 mm	70	4.675 529
3110	1000	48 mm	35	9.102 974
3230	2000	48 mm	20	9.102 977
3415	5000	48 mm	6	4.675 531
3415	5000	48 mm*	6	6.233 835

* with PE handle.

2 Square Media Bottles, PET, sterile **NEW**

For safe storage and transportation of cell culture media. The bottles are manufactured at aseptically sterile production halls and then sent to gamma sterilisation. The bottle neck (32 mm) provides easy filling. *ISOLAB*

- Thick walls and crush-resistant corners
- Square shape
- Caps with large ridges, made of PE
- Embossed volume graduations



Nominal capacity ml	Dimensions (W x D x H) mm	PK	Cat. No.
125	53 x 53 x 105	36	4.678 038
250	59 x 59 x 147	32	4.678 039
500	77 x 77 x 174	32	4.678 040
1000	93 x 93 x 214	24	4.678 041

3 Square Media Bottles Nalgene™ Typ 2019, PETG, sterile

With white HDPE screw closure. Reduced permeability to CO₂/O₂ which reduces pH-shift. *Thermo Scientific*
Bottles and closures are radiation-sterilised and pyrogen-free to eliminate costly washing, depyrogenation and autoclaving steps. Heatshrink band around closure and neck provides tamper-evident seal. Packed in shrink-wrapped trays. 2L size has molded-in handgrips and a 53-mm (53B) white closure. Bottles are sterile to 10⁻⁶ SAL, non-pyrogenic, non-cytotoxic and comply with USP Class VI guidelines. Sterile. Transparent. Leakproof. Graduated.



Type	Capacity ml	Dimensions mm	Cover type	PK	Cat. No.
2019	30	64 x 38 x 38	diam. 20 mm	96	4.675 522
2019	60	82 x 41 x 41	diam. 24 mm	96	4.675 523
2019	125	110 x 54 x 54	diam. 38 mm/design 430	48	4.675 524
2019	250	146 x 61 x 61	diam. 38 mm/design 430	48	4.675 525
2019	500	177 x 74 x 74	diam. 38 mm/design 430	24	4.675 526
2019	1000	220 x 94 x 94	diam. 38 mm/design 430	24	4.675 527
2019	2000	271 x 116 x 116	diam. 53 mm/design 53B	12	4.675 528



1 Media Bottles Nalgene™, Type 382019, PETG, sterile

Suited for biopharmaceutical processing and storage of critical reagents and bulk intermediates such as vaccine and protein therapeutic preparations. Manufactured in a certified ISO 14644-1 Class 7 cleanroom. Containers are lot certified to comply with particulate limits specified in USP <788>, EP 2.9.19, and JP 14th ed. Part 1, Section 24. Packaging is designed for cleanroom applications. Bottle and closure are secured with a tamper-resistant heat-shrink band and packaged in heat-sealed bags to support cleanroom operations. USP Class VI, EP Modified Abnormal Toxicity, and USP <661> physicochemical tests compliant. Bottles meet the requirements for USP Class VI, EP Modified Abnormal Toxicity Test, are non-cytotoxic, pyrogen-free, non-hemolytic, and comply with USP <661> physicochemical guidelines. Resins are free of animal derived components (ADCF). Leakproof.

Thermo Scientific

Type	Capacity ml	Cover type	PK	Cat. No.
382019	30	diam. 20 mm /design 415	72	4.675 515
382019	60	diam. 24 mm /design 415	72	4.675 516
382019	125	diam. 38 mm /design 430	48	4.675 517
382019	250	diam. 38 mm /design 430	48	4.675 518
382019	500	diam. 38 mm /design 430	24	4.675 519
382019	1000	diam. 38 mm /design 430	24	4.675 520
382019	2000	diam. 53 mm /design 53B	12	4.675 521



2 Square Media Bottles Nalgene™ Type 2015, PC, with screw cap, PP



Thermo Scientific

PC bottle with leakproof PP screw cap. With moulded graduations and pouring rim. Ideal for storing aqueous solutions and for the short-term storage of cell culture media. Autoclavable.

Capacity ml	Screw cap diam. mm	Width mm	Depth mm	Height with cap mm	PK	Cat. No.
30	20	38	38	64	12	9.103 284
60	24	41	41	83	12	9.103 285
125	38-430*	54	54	110	6	9.103 286
250	38-430*	57	57	146	6	9.103 287
500	38-430*	74	74	177	4	9.103 288
1000	38-430*	94	94	220	4	9.103 289
2000	53B	116	116	271	1	9.103 077

* with high form thread.



3 Filling and Venting Closures Nalgene™ with 3 ports, Type 2162, PP



Thermo Scientific

With TPE gasket and port caps, Nalgene 50 platinum-cured silicone tubing. All plastic screw closures for sterile liquid transfer of tissue media, biological reagents, pure water and chemicals to and from Nalgene-carboys. For applications such as bio-reactors and fermenters. Suitable for all large Nalgene carboys or bottles with screw closures of 53mm (53B) or 83mm (83B). Includes two Nalgene 550 platinum-cured silicone tubing for drop tube and splash guard. Can be used with Nalgene carboy bottles with properly set up peristaltic pumps. Autoclavable.

Type	Dimensions (dia. x H) mm	For tubing bore mm	Cover type mm	PK	Cat. No.
2162	66,7 x 68,6	6,3	53	1	7.048 080
2162	102 x 98	12,7	83	1	7.048 081
2162	102 x 98	6,3	83	1	7.048 082

Centrifuges Cellspin® III

Centrifuge series with a large speed range for special requirements of cytology or general laboratory tasks.

THARMAC GmbH

- Very precise setting options
- Automatic rotor detection
- Clear control panel
- Pulse centrifugation
- Automatic lid lock and emergency release
- Automatic unbalance shutdown
- Very solid metal housing and centrifuge chamber made of stainless steel
- Without coal dust emissions
- Maintenance-free according to DGUV 100-500
- CE and IVD certified

Specifications

Number of memory slots:	100
Timer:	0.1 ... 99.5 min
Dimensions (W x D x H):	405 x 500 x 325 mm
Weight (without rotor):	32 kg
Power supply:	230 V, 50/60 Hz

1 Cyto-centrifuges Cellspin® III CYTO



The specialist in cytology with a large selection of open and closed rotors.

THARMAC GmbH

- Compatible with Shandon™ Cytospin™
- Quickchange® for rapid rotor change
- For cytorotors with 4, 8 and 12 positions

Specifications

Max. speed:	200 ... 2000 rpm
Max. capacity:	0.1 ... 5 ml

1



Type	Description	PK	Cat. No.
Cellspin® III CYTO	open, fixed 4-positions-rotor	1	4.672 261
Cellspin® III CYTO	open, removable 4-positions-rotor	1	4.672 262
Cellspin® III CYTO	closed, removable 4-positions-rotor	1	4.672 263
Cellspin® III CYTO	open, fixed 8-positions-rotor	1	4.672 264
Cellspin® III CYTO	open, removable 8-positions-rotor	1	4.672 265
Cellspin® III CYTO	closed, removable 8-positions-rotor	1	4.672 266
Cellspin® III CYTO	open, fixed 12-positions-rotor	1	4.672 267
Cellspin® III CYTO	open, removable 12-positions-rotor	1	4.672 268
Cellspin® III CYTO	closed, removable 12-positions-rotor	1	4.672 269
Cellspin® III CYTO	open, removable 12-positions-EASY-rotor	1	4.672 270
Cellspin® III CYTO	closed, removable 12-positions-EASY-rotor	1	4.672 271

Further models can be found in our online shop.

2 Cyto-centrifuge Cellspin® III UNI



For cytology and general laboratory applications with a wide range of rotors.

THARMAC GmbH

- No reprogramming required
- Compatible with Shandon™ Cytospin™
- Speed adjustment to max. 2000 rpm when using cytorotors
- For swing-out, angle and hematocrit rotors and cytorotors

Please order rotors separately.

Specifications

Max. speed:	15000 rpm
Standard laboratory applications:	4 x 200 ml
Cytology:	0.1 ... 5 ml

2



Type	PK	Cat. No.
Cellspin® III UNI	1	4.672 272



1 Cytocentrifuges Cellspin® III LAB

NEW

Versatile basic centrifuge for laboratory applications with fine speed gradation and a large selection of rotors.

THARMAC GmbH

Please order rotors separately.

Specifications

Max. speed: 15000 rpm
Max. load: 4 x 200 ml

Type	PK	Cat. No.
Cellspin® III LAB	1	4.672 273



4.672 282

Accessories for Centrifuges Cellspin® III

NEW

THARMAC GmbH

Description	PK	Cat. No.
EASY Single Cellfunnel, disposable, with white filter card	40	4.672 274
EASY Single Cellfunnel, disposable, with white filter card	200	4.672 275
Open, fixed 4-position rotor	1	4.672 276
Open, fixed 8-position rotor	1	4.672 277
Open, fixed 12-position rotor	1	4.672 278
Open, removable 4-position rotor	*	1 4.672 279
Open, removable 8-position rotor	*	1 4.672 280
Open, removable 12-position rotor	*	1 4.672 281
Open, removable 12-position EASY rotor	*	1 4.672 282
Closed, removable 4-position rotor	*	1 4.672 283
Closed, removable 8-position rotor	*	1 4.672 284
Closed, removable 12-position rotor	*	1 4.672 285
Closed, removable 12-position EASY rotor	*	1 4.672 286
Adapter for removable rotors	1	4.672 287

*Adapter required (Cat. No. 4.672 287)



4.672 284

Clips for Centrifuges Cellspin® III

NEW

THARMAC GmbH

Description	PK	Cat. No.
CellClip for Cellspin® cyto rotors	1	4.660 912
Clip, stainless steel for EASY rotors	1	4.660 915



4.660 912



4.660 915



6 Accessories for Cytocentrifuges Cellspin®, Single Cellfunnel®

THARMAC GmbH

Also suitable for Shandon™ Cytospin™.

Description	PK	Cat. No.
Single Cellfunnel®, reusable, for Cat. No. 4.660 917, 4.660 920	12	4.660 916
Filter cards for Cat. No. 4.660 916	200	4.660 917
Cytoslides, uncoated, 1 circle	100	4.660 918
Cytoslides, coated, 1 circle	100	4.660 919
Filter cards, thin, brown for samples ≤0,4 ml	200	4.660 920
Single Cellfunnel®, disposable with white filter card	100	4.660 923
Single Cellfunnel®, disposable with white filter card	500	4.660 924

1 Aspirator LLG-uniVACUUSYS



LLG-uniVACUUSYS Vacuum Aspiration System **with integrated vacuum pump and vacuum controller** is ideally suited for aspirating liquids in Life Science applications, e.g. the removal of media from cell cultures, aspiration of supernatants after centrifugation, or the removal of wash solutions from Immuno assay plates. The set vacuum is automatically re-adjusted in case of deviations.

- Integrated vacuum pump with vacuum control
- Easy to use
- Self-closing connectors for quick installation and prevention of liquid or aerosol escape
- **Liquid level sensor**, prevents liquid overflow
- Autoclavable waste collection bottle and nozzle

Scope of supply: Vacuum Aspiration System with integrated vacuum pump, 4 liter waste collection bottle, single channel needles and 8-channel aspirator handles, single channel and 8-channel adaptor for 200 µl pipette tips, single channel adaptor for 1000 µl pipette, tubing and quick-connectors

Specifications

Vacuum range:	0 ... 600 mbar (adjustable)
Aspiration rate:	1 ... 15 ml/s
Noise emission:	<50 dB(A)
Dimensions (W x D x H):	180 x 320 x 530 mm
Weight:	3.4 kg
Power supply:	100 ... 240 V, 50/60 Hz
Warranty:	3 years

Type	Plug type	PK	Cat. No.
LLG-uniVACUUSYS	EU	1	6.263 585
LLG-uniVACUUSYS	UK	1	6.263 586



Aspirator systems FTA-1/FTA-2i

Designed for routine aspiration of the supernatant alcohol/buffer from the walls of microtubes during DNA/RNA purification and other macromolecule reprecipitation techniques. Grant

- Fitted with hydrophobic microbiological filter
- The hydrophobic microbiological suction filter eliminates risk of contamination from the trap flask. Efficiency up to 99.9 %, holds particles bigger than 0.027 micron, which are smaller than agents of Hepatitis A, B and C.
- Polyethylene tube connects collecting tip to the trapping flask
- Built-in micro-compressor creates negative pressure in trapping flask for removal of liquid from microtubes

Specifications

Aspiration rate:	up to 10 l/min
Flow rate:	72 ml/min with collecting tip 666 ml/min without collecting tip
Power supply:	120 ... 230 VAC, 50/60 Hz

2 Aspirator FTA-1

Scope of supply: Aspirator system with integrated pump, trap flask, aspiration tip and tube holders for 2 tubes Grant

Specifications

Volume Trap flask:	1 l
Vacuum range:	500 mbar
Dimensions (W x D x H):	160 x 210 x 340 mm
Weight:	1.7 kg

Type	PK	Cat. No.
FTA-1	1	9.721 058





1 Aspirator FTA-2i

NEW
Scope of supply: Aspirator system with integrated pump and trap flask

Grant

Specifications

Volume Trap flask:	2 l
Vacuum range:	200 ... 800 mbar (adjustable)
Dimensions (W x D x H):	185 x 290 x 390 mm
Weight:	1.85 kg

Type	PK	Cat. No.
FTA-2i	1	6.311 061



4.671 980

Adapter sets for Aspirator FTA-1/FTA-2i

NEW

Grant

Scope of supply:
HAS-1: Handheld vacuum controller, 1-channel adapter (with ejector) for 200 µl tips, 1-channel adapter with 125 mm stainless steel pin, 1-channel adapter with 40 mm stainless steel pin, 8-channel adapter (with ejector) for 200 µl tips, 8-channel adapter with 35 mm stainless steel pin, SH-6 stand

MA-8: Tube adaptor, 8 channel aspiration tip, 8 channel tip holder

Type	PK	Cat. No.
HAS-1	1	4.671 980
MA-8	1	9.721 077



3 EcoVac safety suction systems

schuett-biotec



For safe and comfortable removal of liquid excess. EcoVac increases the safety standard, when working with infectious material. Completely autoclavable. Screw-cap of safety bottle incl. 2 self-locking fittings. When tubing is removed, they close automatically and the bottle will be sealed hermetically. Safety bottle made of impact and chemical-resistant polypropylene, with screw-cap incl. 2 self-locking fittings, ventilation system, safety filter and 5m of silicone tubing.

EcoVac vacuum pump (optional):

Quiet with low vibration. Throughput 4L/min., 300mbar ult. vacuum, with illuminated on/off switch and 1m connecting cable. Overall dimensions: 80mm x 60mm x 160mm (W x H x D). 230V 50/60Hz.

Foot-switch (optional): For short-time repeated use of EcoVac.

Replacement covers and other spare parts on request.

Supplied with: EcoVac system (1.2.4 or 5), safety bottle (breakproof and chemically stable) with screw cap and 2 self-locking fittings, silicone tubing 2 x 1.5m (autoclavable), safety filter, 2 angled fittings for tubing connection, 1 aeration insert

Type	Capacity Litres	PK	Cat. No.
EcoVac 1 System	1	1	6.287 611
EcoVac 2 System	2	1	9.777 000
EcoVac 4 System	4	1	9.777 001
EcoVac 5 System	5	1	6.287 612
Spare bottle 1 incl. Screw-cap with 2 self-locking fittings	*	1	6.287 613
Spare bottle 2 incl. Screw-cap with 2 self-locking fittings	*	1	9.777 007
Spare bottle 4 incl. Screw-cap with 2 self-locking fittings	*	1	9.777 010
Spare bottle 5 incl. Screw-cap with 2 self-locking fittings	*	1	6.287 614
Vacuum pump, incl. 1m cable		1	9.777 005
Foot switch		1	9.777 008
Safety filter 0.2 µm pore size, Ø 62 mm		2	9.777 009

* without angled fittings, please order separately

Fluid aspiration systems BioChem-VacuuCenter BVC basic/control/professional

VACUUBRAND



The compact BioChem-VacuuCenter offers the perfect solution for safe, sensitive and efficient aspiration of supernatants or filtration in all application areas.

- The BVC basic is designed for connection to an existing external vacuum source like a diaphragm pump or a vacuum network
- The BVC control and professional serve for efficient and convenient aspiration of supernatants. The vacuum level and thus the suction force is sensitively adjustable by the electronic touch panel and allows a delicate and reproducible operation. The chemically-resistant diaphragm vacuum pump is automatically turned on and off as needed, which reduces the low noise level even further.
- The BVC professional, with 4L PP bottle and self-closing quick couplings minimises risks in transporting hazardous waste and contamination of the workplace.
- All systems are available in two complete equipment options with different collection flasks and ready to accept a second aspiration hand controller (VHC) to support two users. The 2L borosilicate glass bottle (all types with "G" in the description) with a protective coating has a very high chemical resistance. For larger amounts of liquids the 4L bottle of unbreakable polypropylene (PP) is used.

Type	Dimensions (W x D x H) mm	Pump	Weight kg	Plug type	PK	Cat. No.
		Model				
BVC basic	200 x 250 x 490	-	2.8	CEE	1	9.882 225
BVC basic G	180 x 230 x 430	-	2.8	CEE	1	9.882 226
BVC control	194 x 408 x 500	ME 1C	7.3	CEE	1	9.882 227
BVC control	194 x 408 x 500	ME 1C	7.3	UK	1	4.670 410
BVC control G	194 x 408 x 430	ME 1C	7.7	CEE	1	9.882 228
BVC control G	194 x 408 x 430	ME 1C	7.7	UK	1	4.670 413
BVC professional	194 x 408 x 500	ME 1C	7.3	CEE	1	9.882 229
BVC professional	194 x 408 x 500	ME 1C	7.3	UK	1	4.670 415
BVC professional G	194 x 408 x 430	ME 1C	7.7	CEE	1	9.882 230
BVC professional G	194 x 408 x 430	ME 1C	7.7	UK	1	4.670 417

Country-specific power cord versions available on request.

3 Accessories for Biochem-VacuuCenter BVC basic/control/professional

VACUUBRAND

Description	PK	Cat. No.
VHCpro Vacuu Hand Control handset	1	6.260 677
Stand for VHCpro suction handset	1	6.260 678
VHCpro Adapter for pipette tips with tip ejector	1	4.652 758
VHCpro 8-channel tip adapter with ejector	1	6.266 573
BVC Shuttle, mobile underframe	1	6.266 574
Kit for second VHCpro to the bottle of a BVC professional	1	6.254 294
Kit for second VHCpro to the bottle of a BVC basic or BVC control	1	9.882 983

For connection of a second hand controller please order additionally to the adapter set the handset 6.260 677



9.882 228



9.882 229





1 Filter units, PES membrane, sterile

These bottle-top filter units are ideally suited for the separation or purification of samples which are contained in large volumes. The units are available with either 0.22µm or 0.45µm pore sizes and 3 different volumes (250, 500 and 1000ml).

Features:

- Bottle-top filter and reservoir bottle are included
- Light weight and stable wall construction
- Large knurls on the reservoir bottle cap for easy screwing
- Wide bottle mouth for efficient pouring out
- Volume graduation
- Hose connector fits multiple diameters
- Pyrogen-free

Membrane material: Polyethersulfone (PES)

Capacity ml	Pore size µm	Neck thread mm	PK	Cat. No.
250	0.22	45	12	6.267 180
250	0.45	45	12	6.267 181
500	0.22	45	12	6.267 182
500	0.45	45	12	6.267 183
1000	0.22	45	12	6.267 184
1000	0.45	45	12	6.267 185



2 Filter units Nalgene™ Rapid-Flow™, PES Membrane, sterile

Ideal for biological and pharmaceutical sterile filtration. PES membrane features low protein binding, low level of extractables and a high flow rate. Now available in three pore sizes: *Thermo Scientific*

The best filter units with 0.20µm and 0.45µm pore size and new to the protection of valuable cell cultures from mycoplasma with 0.10µm pore size. Filter top and filtrate bottle are graduated. Blue color-coded collar with cellulosic vent plug side arm and quick-disconnect tubing adapter. Leakproof, sterile screw closure included for storage of sterile filtrate. Sterile, single packed. Certificate of Quality included in each full case. Lot number, catalogue number, membrane type, pore size and expiration date are printed on filter units, bottle tops and receivers for easy identification and lot traceability.

Type	Volume upper/lower part ml	Membrane diam. mm	Pore size µm	Thread GL	PK	Cat. No.
565	150/150	50	0.10	45	1	9.046 022
568	250/250	50	0.10	45	1	9.046 024
566	500/500	75	0.10	45	1	9.046 023
565	150/150	50	0.20	45	1	6.302 336
568	250/250	50	0.20	45	1	6.228 218
566	500/500	75	0.20	45	1	6.227 381
569	500/500	90	0.20	45	1	6.225 298
567	1000/1000	90	0.20	45	1	6.229 041
165	150/150	50	0.45	45	1	7.047 785
168	250/250	50	0.45	45	1	7.047 791
166	500/500	75	0.45	45	1	7.047 787
169	500/500	90	0.45	45	1	7.047 793
167	1000/1000	90	0.45	45	1	7.047 789



3 Bottle Top Filters Nalgene™ Rapid-Flow™, PES Membrane, sterile

Filters securely screw onto glass media bottles with 33 mm or 45 mm neck sizes. *Thermo Scientific*
Allows direct filtration of liquid into sterile glass media bottles.

Tight and secure thread connection for vacuum filtration, vacuum tubing to be connected onto tubing adapter of side-arm. Graduated. Certificate of quality included in each full case. Lot number, catalogue number, membrane type, pore size and expiration date are printed on filter units for easy identification and lot traceability.

Type	Capacity ml	Membrane diam. mm	Pore size µm	Neck thread GL	PK	Cat. No.
596	150	50	0.20	33	12	4.675 537
596	150	50	0.20	45	12	4.675 532
595	500	75	0.20	33	12	4.675 533
595	500	75	0.20	45	12	4.675 535
597	1000	90	0.20	33	12	4.675 540
597	1000	90	0.20	45	12	4.675 541
296	150	50	0.45	33	12	4.675 538
296	150	50	0.45	45	12	4.675 539
295	500	75	0.45	33	12	4.675 534
295	500	75	0.45	45	12	4.675 536

1 Filter Units, Cellulose Nitrate Membrane, sterile

White, cellulose nitrate membrane. Colour code: green. Gamma-irradiated sterile. *Thermo Scientific*
 Highest throughput rate for water and aqueous solutions, low extractables content.
 Surfactant-free. Lot number, catalogue number, membrane type, pore size and expiration date are printed on filter units, bottle tops and receivers for easy identification and lot traceability.

**Warning**

H phrases: H228

Type	Volume upper/lower part ml	Membrane diam. mm	Pore size µm	Thread GL	Grid	PK	Cat. No.
121	115/115	50	0.20	45	without	72	4.675 600
121	115/115	50	0.45	45	black	72	4.675 542
125	150/150	50	0.20	45	without	12	4.675 543
125	150/150	50	0.45	45	black	12	4.675 544
125	150/150	50	0.80	45	without	12	4.675 545
126	250/250	50	0.20	45	without	12	4.675 546
126	250/250	50	0.45	45	black	12	4.675 547
126	250/250	50	0.80	45	without	12	4.675 548
450	500/500	75	0.20	45	without	12	4.675 549
450	500/500	75	0.45	45	black	12	4.675 550
450	500/500	75	0.80	45	without	12	4.675 551
127	500/1000	75	0.20	45	without	12	4.675 552
127	500/1000	75	0.45	45	black	12	4.675 553
127	500/1000	75	0.80	45	without	12	4.675 554

1

**2 Filter Units Nalgene™ Rapid-Flow™, Nylon Membrane, sterile**

Single-use, disposable filter units for sterile filtration of media and other reagents, and for other highly sensitive cell culture lines. With polystyrene (PS) upper and lower chambers and nylon membrane. Colour code: red. For cell culture. Gamma-irradiated sterile. Extremely low in extractable substances, no wetting agents. Lot number, catalogue number, membrane type, pore size and expiration date are printed on filter units, bottle tops and receivers for easy identification and lot traceability. *Thermo Scientific*

Type	Volume upper/lower part ml	Membrane diam. mm	Pore size µm	Thread GL	PK	Cat. No.
150	150/150	50	0.20	45	1	9.046 055
150	150/150	50	0.45	45	1	9.046 056
153	250/250	50	0.20	45	1	9.046 061
153	250/250	50	0.45	45	1	9.046 062
151	500/500	75	0.20	45	1	9.046 064
151	500/500	75	0.45	45	1	9.046 065
163	500/500	90	0.20	45	1	9.045 978
154	500/1000	75	0.20	45	1	9.046 067
154	500/1000	75	0.45	45	1	9.046 068
164	1000/1000	90	0.20	45	1	9.045 979

2

**3 Filter units Nalgene™ Rapid-Flow™, SFCA Membrane, sterile**

Single-use, disposable filter units for sterile filtration of media and other reagents, and for other highly sensitive cell culture lines. With polystyrene (PS) upper and lower chambers and surfactant-free, cellulose acetate membranes. Colour code: yellow collar. For cell culture. Gamma-irradiated sterile. Low protein binding, with high throughput rate for proteinaceous solutions and minimal extractables content. Lot number, catalogue number, membrane type, pore size and expiration date are printed on filter units bottle tops and receivers for easy identification and lot traceability. *Thermo Scientific*

Type	Volume upper/lower part ml	Membrane diam. mm	Pore size µm	Thread GL	PK	Cat. No.
122	115/115	50	0.20	45	72	4.675 556
122	115/115	50	0.45	45	72	4.675 555
155	150/150	50	0.20	45	12	4.675 575
155	150/150	50	0.45	45	12	4.675 576
157	250/250	50	0.20	45	12	4.675 577
157	250/250	50	0.45	45	12	4.675 578
156	500/500	75	0.20	45	12	4.675 579
156	500/500	75	0.45	45	12	4.675 580
158	500/1000	75	0.20	45	12	4.675 581
158	500/1000	75	0.45	45	12	4.675 582
162	500/500	90	0.20	45	12	4.675 573
162	500/500	90	0.45	45	12	4.675 574
161	1000/1000	90	0.20	45	12	4.675 571
161	1000/1000	90	0.45	45	12	4.675 572

3

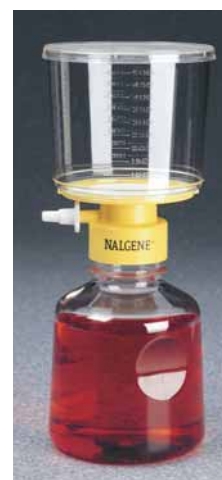



1 Filter Units Nalgene™, PSU, without membrane

Graduated reusable filtration unit bodies with upper manifolds and lower receivers made of unbreakable polysulphone (PSU). Nominal filtration surface 11cm². With membrane support plate. Without membrane. For filter membrane from 47mm to 50mm.

Thermo Scientific

Volume upper/lower part ml	PK	Cat. No.
250/250	1	9.046 151
500/500	1	9.046 152
500/1000	1	9.046 153



2 Bottle Top Filters Nalgene™ Rapid-Flow™, SFCA Membrane, sterile

Tissue culture filters for screw fitting onto bottles with 33mm or 45mm neck diameters. With surfactant-free, cellulose acetate membrane (SFCA) and polystyrene (PS) housing. Gamma-irradiated sterile. Pyrogen-free. Non cytotoxic. Low-pressure filtration can be carried out directly into a suitable sterile bottle. Caution: Only use sterile bottles authorised for use in low pressure applications. Always wear protective equipment for low pressure procedures. The membrane is characterised by its low protein binding, good throughput rates and minimal clogging with negligible protein loss. Permanent, moulded graduations. Quick-disconnection tubing adaptor with cellulosic vent plug for tubing with an internal diameter of 6mm to 9mm. Lot number, catalogue number, membrane type, pore size and expiration date are printed on filter units for easy identification and lot traceability.

Thermo Scientific

Type	Capacity ml	Membrane diam. mm	Pore size µm	Neck thread GL	PK	Cat. No.
290	150	50	0.20	33	12	4.675 561
290	150	50	0.45	33	12	4.675 562
290	150	50	0.20	45	12	4.675 563
290	150	50	0.45	45	12	4.675 564
291	500	75	0.20	33	12	4.675 565
291	500	75	0.45	33	12	4.675 566
291	500	75	0.20	45	12	4.675 567
291	500	75	0.45	45	12	4.675 568
292	1000	90	0.20	33	12	4.675 569
292	1000	90	0.20	45	12	4.675 570



3 Filter Storage Bottles Nalgene™ Rapid-Flow™, PS, sterile

Easy-to-use ergonomic design. Can be used to store sterilised filtrate. Radiation-sterilised to save you time and minimize contamination. Also handy as presterilised, single-use storage containers. 1-1/2-turn threaded screw closure guarantees a leakproof seal and eliminates pH shift in receivers. Certified. Pyrogen-free, non cytotoxic. Sterile, graduated and leakproof.

Thermo Scientific

Type	Capacity ml	Thread GL	PK	Cat. No.
455	150	45	24	4.675 557
455	250	45	24	4.675 558
455	500	45	12	4.675 559
455	1000	45	12	4.675 560



4 Disposable Syringes HSW HENKE-JECT®, 2-part, sterile

Disposable syringes with PP barrel, and PE piston. Luer-Slip or Luer-Lock nozzle.

Henke-Sass Wolf

- Sterile, individually blister strip packed
- Wipe-resistant scale
- Transparent cylinder
- Pyrogen-free, non-toxic and PVC-free

Capacity ml	Nozzle type	PK	Cat. No.
30	Luer-Slip	50	9.410 025
50	Luer-Slip	30	9.410 050
30	Luer-Lock	50	6.250 019
50	Luer-Lock	30	6.286 307

➔ Further syringes can be found in chapter 14.
➔ Syringe filters can be found in chapter 6.

1 Laminar Flow Clean Benches, Type Airstream®

The new generation of ESCO Airstream horizontal and vertical laminar flow benches offer optimal product protection by achieving ISO Class 5 conditions inside the cabinet.

ESCO

Features:

- Energy-efficient DC ECM motors
- Stable and self-compensating airflow
- Sentinel Gold microprocessor control
- Control panel to easily monitor the operating parameters
- Standby mode reduces power consumption while maintaining the ISO class 5 conditions inside the work bench
- Visual and audible alarms
- Side windows made of safety glass
- Standard working space height vertical/horizontal benches: 689 mm/573 mm
- Additional working space heights on request.
- ULPA filter with long service life and protection mesh
- Pre-filter EU3
- ISOCIDE antimicrobial coating on all painted surfaces minimizes contamination
- Apparatus for UV lamp with timer (UV lamp and protective cover must be ordered separately)

Options on request:

Stands, electrical sockets (4.662 021), front covers with UV lamp, IQ/OQ

Please order stands separately.



Type	Size	External dimensions (W x D x H) mm	Internal dimensions (W x D x H) mm	Description	PK	Cat. No.
LHG-3AG-F8	0.9 m	1035 x 784 x 1270	855 x 596 x 573	horizontal	1	6.285 840
LHG-4AG-F8	1.2 m	1340 x 784 x 1270	1160 x 596 x 573	horizontal	1	4.658 999
LHG-5AG-F8	1.5 m	1645 x 784 x 1270	1405 x 596 x 573	horizontal	1	4.659 000
LHG-6AG-F8	1.8 m	1950 x 784 x 1270	1770 x 596 x 573	horizontal	1	4.659 001
LVG-3AG-F8	0.9 m	1035 x 784 x 1270	917 x 688 x 689	vertical	1	6.285 841
LVG-4AG-F8	1.2 m	1340 x 784 x 1270	1222 x 688 x 689	vertical	1	6.286 357
LVG-5AG-F8	1.5 m	1645 x 784 x 1270	1527 x 688 x 689	vertical	1	4.659 002
LVG-6AG-F8	1.8 m	1950 x 784 x 1270	1832 x 688 x 689	vertical	1	4.659 003

2 Microbiological Safety Cabinet, class II Type Airstream®

- Class II according to DIN 12469
- Ergonomically angled and frameless front sash
- A large easy-to-read digital display and ergonomically sized touchpad
- Tempered glass side walls (S-Series with stainless steel side walls)
- Esco triple-wall design with negative pressure prevents the possibility of contamination from leaks
- ISOCIDE™ antimicrobial coating on all painted surfaces minimises contamination
- Quickstart Mode
- Sentinel-Microprocessor maintains steady blower speed
- RS232 serial interface port
- More options on request, e.g. prefilter at intake socket

ESCO

Model variations:

Model type E and S: Single ULPA-Filter/H14

Model type G: Dual ULPA-Filter/H14

Options on request:

Electrical outlet, support stand, prefilter, service fixture, UV lamp, IV bar, single piece work surface for E-Series, Q/OQ or KI DISCUS test

Please order support stand separately.



Type	Size	External dimensions (W x D x H) mm	Internal dimensions (W x D x H) mm	PK	Cat. No.
AC2-2E8	0.6 m	730 x 810 x 1400	610 x 580 x 660	1	6.284 857
AC2-3E8	0.9 m	1035 x 810 x 1400	915 x 580 x 660	1	6.270 726
AC2-4E8	1.2 m	1340 x 810 x 1400	1220 x 580 x 660	1	4.659 007
AC2-5E8	1.5 m	1645 x 810 x 1400	1525 x 580 x 660	1	4.659 008
AC2-6E8	1.8 m	1950 x 810 x 1400	1830 x 580 x 660	1	4.658 786
AC2-4G8	1.2 m	1340 x 810 x 1400	1220 x 580 x 660	1	4.658 784
AC2-6G8	1.8 m	1950 x 810 x 1400	1830 x 580 x 660	1	4.659 009
AC2-2S8	0.6 m	730 x 810 x 1400	610 x 580 x 660	1	4.676 195
AC2-3S8	0.9 m	1035 x 810 x 1400	915 x 580 x 660	1	4.676 196
AC2-4S8	1.2 m	1340 x 810 x 1400	1220 x 580 x 660	1	4.676 197
AC2-5S8	1.5 m	1645 x 810 x 1400	1525 x 580 x 660	1	4.676 198
AC2-6S8	1.8 m	1950 x 810 x 1400	1830 x 580 x 660	1	4.676 199

Suitable accessories can be found in our online shop.

1

1

Microbiological Safety Cabinet, class II, acc. to DIN 12469, Type Airstream® Plus

ESCO

- Certified according to EN 12469 by TÜV-Nord, Germany
- Ergonomically angled and motorized front sash for one handed operation (aerosol tight gasket)
- Dual Energy efficient DC ECM motor
- Sentinel-Gold-controller maintains steady blower speed
- Tempered glass side panels with E-Series, stainless steel side walls with S-Series
- LED lamp
- Esco triple-wall design with negative pressure prevents the possibility of contamination from leaks
- Multi-piece work surface removal simplifies cleaning for E-Series, single piece work surface with sink for S-Series
- ULPA-Filter/H14
- Esco ISOCIDE antimicrobial coating on all painted surfaces minimizes contamination
- Quickstart Mode
- RS232 serial interface port

Options on request:

Electrical outlet, support stand, prefilter, service fixture, UV lamp, IV bar, single piece work surface for E-Series, IQ/OQ or KI DISCUS test, RS485 serial interface port for using Voyager Software

Please order support stand separately.

Type	Size	External dimensions (W x D x H) mm	Internal dimensions (W x D x H) mm	PK	Cat. No.
AC2-3E8-TU	0.9 m	1035 x 823 x 1400	915 x 580 x 654	1	4.676 202
AC2-4E8-TU	1.2 m	1340 x 823 x 1400	1220 x 580 x 654	1	4.659 010
AC2-5E8-TU	1.5 m	1645 x 823 x 1400	1525 x 580 x 654	1	4.659 012
AC2-6E8-TU	1.8 m	1950 x 823 x 1400	1830 x 580 x 654	1	4.659 014
AC2-3S8-TU	0.9 m	1035 x 823 x 1400	915 x 580 x 654	1	4.676 203
AC2-4S8-TU	1.2 m	1340 x 823 x 1400	1220 x 580 x 654	1	4.659 011
AC2-5S8-TU	1.5 m	1645 x 823 x 1400	1525 x 580 x 654	1	4.659 013
AC2-6S8-TU	1.8 m	1950 x 823 x 1400	1830 x 580 x 654	1	4.659 015

2

Microbiological Safety Cabinets, Class II, Type NordicSafe®

ESCO

One of the silent Biological Safety Solutions from Esco. Class II according to DIN EN 12469.

- Dual-ULPA filter
- Noise emission <51 dBA
- Best comfort and safety at a favourable price
- Esco triple-wall design with negative pressure prevents the possibility of contamination from leaks
- Ergonomically angled and motorized front sash for one hand operation
- A large easy-to-read digital display and ergonomically sized touchpad
- Tempered glass side panels
- Sentinel-Gold-controller maintains steady blower speed
- Sleep mode with 50% reduced power to save energy, to maintain safety
- Esco ISOCIDE™ antimicrobial coating on all painted surfaces minimizes contamination
- Certified according to EN 12469 by TÜV-Nord, Germany

Options on request:

Electrical outlet, support stand, prefilter, service fixture, UV lamp, IV bar, IQ/OQ or KI-Discus-Test

Type	Size	External dimensions (W x D x H) mm	Internal dimensions (W x D x H) mm	PK	Cat. No.
NordicSafe® ES-NC2-4L8	1.2 m	1200 x 812 x 1410	1130 x 584 x 670	1	4.658 785
NordicSafe® ES-NC2-6L8	1.8 m	1800 x 812 x 1410	1720 x 584 x 670	1	4.659 006

1 Cytotoxic Safety Cabinets Type Cytoculture

1

The Esco Cytoculture Cytotoxic Safety Cabinet provides the highest level of patient, pharmacist and environmental protection in cytotoxic/antineoplastic drug processing. The unique demands of handling and preparing cytotoxic drugs for use in chemotherapy require a specialized cabinet. As cytotoxic drugs cannot be inactivated by chemical decontamination, Class II biosafety cabinets should not be used. With this in mind Esco has developed a highly specialized range of cabinets designed especially for handling these potentially dangerous drugs.

ESCO

- 3-fold filter system
- With V-shaped Hepa filter
- Sentinel™ microprocessor controller supervises all functions
- Motorized sash simplifies transfer of materials into the work zone
- Tested according to DIN 12980, EN 12469, ISO 14644.1 Class 3, EN-1822

Options on request:

Electrical outlet, service fixture, UV lamp, IV bar, carbon filter



Type	Size	External dimensions (W x D x H) mm	Internal dimensions (W x D x H) mm	PK	Cat. No.
CYT-4A1	1.2 m	1420 x 780 x 2190	1270 x 603 x 670	1	4.659 004
CYT-6A1	1.8 m	2030 x 780 x 2190	1870 x 603 x 670	1	4.659 005

2 Biological safety cabinets Herasafe™ 2030i, class II

NEW

2

For demanding cell culture applications and other sensitive work requiring assured safety for product, personnel and environment.

Thermo Scientific

- Interior made of stainless steel, with LED lights
- GUI touchscreen interface
- SmartFlow plus auto compensation
- Cross beam UV in side walls
- Electronic front sash window
- Hinged front window for easy cleaning and disinfection of the interior
- Sloped front window allows fatigue free working
- Padded, ergonomically adjustable armrests (optional)
- 2 x Smart Ports for feeding trough vacuum tubes and cables
- One touch auto start/stop function
- Cloud ready data output
- USB data outputs
- EN 12469



Description	External dimensions (W x D x H) mm	Power consumption		Weight kg	PK	Cat. No.
		W				
0.9 m with 2 x sockets in the rear wall	1000 x 800 x 1536	133		170	1	4.672 619
1.2 m with 2 x sockets in the rear wall	1300 x 800 x 1536	153		200	1	6.311 675
1.5 m with 4 x sockets in the rear wall	1600 x 800 x 1536	217		230	1	4.672 620
1.8 m with 4 x sockets in the rear wall	1900 x 800 x 1536	251		280	1	4.672 621

1

1 Biosafety cabinets Maxisafe™ 2030i

NEW

For CMR substances (carcinogenic, mutagenic, reprotoxic) and other work requiring assured safety for product, personnel and environment. Each device has an integrated WLAN function and can be connected immediately.

Thermo Scientific

- Interior made of stainless steel, with LED lights
- GUI touchscreen interface
- SmartFlow plus auto compensation
- Cross beam UV in side walls
- Padded, ergonomically adjustable armrests (optional)
- 2 x Smart Ports for feeding trough vacuum tubes and cables
- Cloud ready data output
- EN 12469 and DIN 12980



Description	External dimensions (W x D x H) mm	Weight kg	Power consumption W	PK	Cat. No.
0.9 m with 2 x sockets in the rear wall	1000 x 870 x 1536	200	230	1	4.672 622
1.2 m with 2 x sockets in the rear wall	1300 x 870 x 1536	240	240	1	6.292 170
1.5 m with 4 x sockets in the rear wall	1600 x 870 x 1536	280	390	1	6.292 172
1.8 m with 4 x sockets in the rear wall	1900 x 870 x 1536	330	390	1	6.292 174

2

2 MSC-Advantage™ Class II Biosafety Cabinets

Thermo Scientific biological safety cabinets combine smart design and extraordinary value with best-in-class energy efficiency, reliability and usability. The MSC-Advantage is designed to meet the stringent safety requirements of EN 12469:2000 and EN 61010-1:2001, and carries the NF Mark as well as the test report from the Health Protection Agency (HPA) from Porton Down, UK.

Thermo Scientific

- 60% less energy consumption than competing AC motor-driven cabinets
- 60% less heat emission than competing AC motor-driven cabinets
- Extremely low noise level (54 or 59 dB(A)) for a more comfortable work environment
- Largest work surface area of any cabinet (more workspace for your research)
- Cleaning position of window (patented feature that allows user to clean the entire window)
- Sloped front window for improved ergonomics (more comfortable working position)
- Motor operates at reduced speed when front window is closed (keeps interior cleaner for faster set up each day and eliminates noise into the lab when not in use)
- Low overall height to fit into labs with shorter ceilings
- Supply/exhaust air filter: HEPA H 14 EN 1822, 99.999% at 0.3 µm particle size
- Additional exhaust filter option (AEF): HEPA H 14 EN 1822, 99.999% at 0.3 µm particle size
- Voltage: 230 V, 50/60 Hz



Description	External dimensions (W x D x H) mm	Internal dimensions (W x D x H) mm	Weight kg	PK	Cat. No.
MSC Advantage 0.9	1000 x 800 x 1522	900 x 630 x 780	170	1	4.010 047
MSC Advantage 1.2	1300 x 798 x 1550	1200 x 495 x 780	240	1	6.235 767
MSC Advantage 1.5	1600 x 800 x 1522	1500 x 630 x 780	230	1	4.010 048
MSC Advantage 1.8	1900 x 798 x 1550	1800 x 495 x 780	340	1	4.010 033

Suitable accessories can be found in our online shop.

1 LLG-Microbiological Media, dehydrated

Media for bacteria

Luria Bertani (Miller):

- Standard high salt content media for *E. coli* cultivation
- Ideal for plasmid preparation
- Available also as granulated media

Luria Bertani (Lennox):

- Standard medium with low salt content for the cultivation of *E. coli*
- Ideal for cultivating recombinant *E. coli* strains

Terrific Broth:

- Rich content media for the high density cultivation of *E. coli*
- Ideal for protein expression and plasmid preparation
- Available also as granulated media

2xYT Broth:

- Nutritive medium for the cultivation of recombinant *E. coli* strains and for the growth of filamentous bacteriophages

Media for yeasts

YPD-Broth:

- Standard medium for the cultivation of *Saccharomyces cerevisiae* and other yeasts

Agar

Bact. Agar.:

- High quality agar used for the preparation of culture media and other bacteriological applications

Luria Bertani Agar (Miller):

- Standard Agar based on Luria Bertani (Miller) media with high salt content
- Ideal for growth and maintaining especially of *E. coli* strains used in molecular microbiology procedures

Luria Bertani Agar (Lennox):

- Standard Agar based on Luria Bertani (Lennox) media with low salt content
- Ideal for growth and maintaining especially of recombinant *E. coli* strains

Media components

Yeast Extract:

- Concentrate of the water-soluble portion of autolyzed *Saccharomyces cerevisiae* cells
- Non-animal product, used widely for non-animal formulations of bacterial, fungal, mammalian and insect cell culture.

Tryptone:

- Pancreatic digest, tryptone from casein
- Excellent nutrient for use in culture media for producing antibiotics, toxins, enzymes and other biological products

Casein Peptone:

- Pancreatic digest, peptone from casein
- Ideal for use in fermentation applications and microbiological culture media

The safety data sheets of these products are available under www.llg-labware.com/en/zertifikate.



2 LLG-Microbiological Media

For numerous micro- and molecular biological applications.

The safety data sheets of these products are available under www.llg-labware.com/en/zertifikate.

Description	Capacity g	PK	Cat. No.
Luria Bertani (Miller), Powder	500	1	6.271 000
Luria Bertani (Lennox), Powder	500	1	6.271 010
Terrific Broth, Powder	500	1	6.271 007
2xYT Broth, Powder	500	1	6.271 001
Bact. Agar, Powder	500	1	6.271 003
Luria Bertani Agar (Miller), Powder	500	1	6.271 009
Luria Bertani Agar (Lennox), Powder	500	1	6.271 008
YPD Broth, Powder	500	1	6.271 002
Yeast Extract, Powder	500	1	6.271 004
Tryptone, Powder	500	1	6.271 005
Casein Peptone, Powder	500	1	6.271 011
Tryptic Soya Agar (Caso-Agar), Powder	500	1	6.271 006
Gelysate Agar-PCA w/o. Sugars, Powder	500	1	6.271 013
Trypticasein Soy Broth (TSB-media), Powder	500	1	6.271 018





1 Microbiological rapid tests Lovibond® Dipslides

The Lovibond® Dipslides are designed to test liquids as well as surfaces. These dual-sided Dipslides are available in a wide range of different media types. They are ideal for use in many applications including evaporative cooling towers, closed water circuits, cutting fluids, food testing, and many more.

Lovibond®

Description	PK	Cat. No.
TTC/TTC for total viable count (TVC)	10	6.282 520
TTC/MALT for Yeast, Moulds, Fungi, TVC	10	6.282 521
TTC/ROSE for Yeast, Moulds, Fungi, TVC	10	6.282 522
TTC/MAC for coliforms, TVC	10	6.282 523
TTC/E.COLI for E. coli/coliforms, TVC	10	6.282 524
PDM/MAC for Pseudomonas species, coliforms	10	6.282 525
TTC/PDM for Pseudomonas species, TVC	10	6.282 526
SRB for Sulphate reducing bacteria	10	6.282 527
NRB for Nitrite reducing bacteria	10	6.282 528
R2A/R2A - TTC for testing of potable water	10	6.282 529



2 Incubator Lovibond® DI 10

Designed for the reliable incubation of dipslides in laboratories and field work.

Lovibond®

- Low voltage, in-car operation possible
- Holds up to 12 dipslides or 10 quanti-discs
- Excellent temperature stability
- Programmable incubation period setting
- LCD Temperature display with up/down push button control
- Rapid heating times for fast testing
- External status LEDs

Scope of supply: Incubator incl. external 12 V universal power supply, set of leads (UK, EU, US), 12 V in-car power adapter

Temperature range: ambient +5 ... +40 °C (±0.5 °C)
 Dimensions (W x D x H): 246 x 215 x 162 mm
 Weight: 1.7 kg
 Power supply: 110/220-240 V or 12 V

Type	PK	Cat. No.
Lovibond® DI 10	1	6.291 192
Dipslide-Holder	1	6.274 399



3 Culture Plates 3M™ Petrifilm™

- Ready to use
- 90 % less material volume
- Validated methods
- Time and energy saving
- Increased productivity and reliability
- Low operating costs
- Fast and reliable evaluation

3M Deutschland

Description	PK	Cat. No.
Total bacteria count aerobic bacteria	100	6.237 738
Total bacteria count aerobic bacteria	1000	6.236 670
Rapid test coliforms	50	6.245 052
Total bacteria count coliforms	50	6.269 820
Total bacteria count coliforms	1000	6.235 875
Bacteria count <i>E.coli</i>	50	6.269 819
Bacteria count <i>E.coli</i> and coliforms	50	6.257 512
Bacteria count <i>E.coli</i> and coliforms	500	6.257 513
Bacteria count Enterobacteriaceae	50	6.251 171
Bacteria count Enterobacteriaceae	1000	6.257 509
Bacteria count <i>S. aureus</i>	20	7.658 234
Bacteria count <i>S. aureus</i>	50	6.257 510
Bacteria count <i>S. aureus</i>	500	6.257 511
Rapid test Yeast and Fungi	50	6.282 104
Bacteria count Yeast and Fungi	100	7.657 837
Bacteria count Yeast and Fungi	1000	6.257 514

➔ Petrifilm™ Reader can be found in our online shop.

1 Nutrient pads

Sterile, dehydrated culture media pads in petri dishes. Once they are moistened with 3.0 ml to 3.5 ml of sterile and demineralised (or distilled) water they are ready-to-use immediately. All Nutrient Pad sets are supplied with the appropriate membrane filters, which are also individually sterile packed. Shelf life of the NPS 18 to 24 months at room temperature. Alternative nutrient media are available on request.

Sartorius Lab Instruments

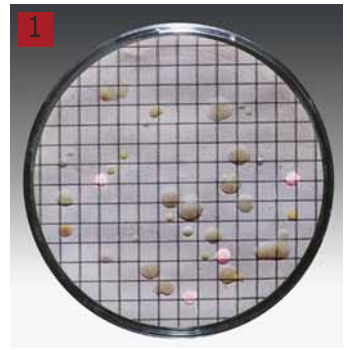

Danger

H phrases: H228

Diam. mm	Pore size µm	Type	For	Colour	PK	Cat. No.
50	0.45	Azide	Enterococci	green / green	100	9.055 006
50	0.45	Caso	Colony count	green / green	100	9.055 017
50	0.45	Standard TTC	Colony count	green / green	100	9.055 010
50	0.45	Tergitol TTC	E. coli + Coliforms	white / green	100	9.055 011
50	0.45	Chapman	Staphylococci	white / green	100	9.055 032
50	0.45	ECD	E. coli	white / green	100	9.055 025
50	0.45	VLB S7-S	Pediococci + Lactobacilli	white / green	100	9.055 014
50	0.45	Caso	Colony count	green / green	100	9.055 018
50	0.45	M-FC	E. coli + Coliforms	white / green	100	9.055 022
50	0.45	Tomato juice	Leuconostocoenos	green / green	100	9.055 026
50	0.65	Sabouraud	Yeast + mould	grey / green	100	9.055 023
50	0.65	Lysin	wild yeasts	grey / white	100	9.055 015
50	0.45	Cetrimide	Pseudomonas	white / green	100	9.055 031
50	0.65	Schaufus Pottinger	Yeast + mould	white / green	100	9.055 034
50	0.45	Yeast extract	Colony count	green / green	100	9.055 037
50	1.20	Schaufus Pottinger	Yeasts + moulds	white / green	100	9.055 028
50	0.45	Weman	Mesophilic slime-forming bacteria	green / green	100	9.055 019
50	0.45	Bismuth sulphite	Salmonellae	green / green	100	9.055 012

2 Microsart® Media, prefill dishes

Microsart® media are dishes pre-filled with different types of agar medium, sterile-packaged and ready to use.

Sartorius Lab Instruments



Description	PK	Cat. No.
Microsart ADDmedia TSA	1	6.289 297
Microsart ADDmedia Sabouraud	1	6.289 298
Microsart ADDmedia R2A	1	6.289 299

Absorbent medium pads

The absorbent pads are wetted with the appropriate liquid culture medium before a membrane filter is placed on them. They are pre-sterilized in plastic magazines.

Sartorius Lab Instruments

- 47 mm with approx. 3 ml absorption capacity
- 50 mm with approx. 3.5 ml absorption capacity
- Thickness 1.4 mm

Description	Diam. mm	PK	Cat. No.
10 magazines of 100 pads, incl. one dispenser	47	1000	7.076 653
100 pads in petri dishes	50	100	7.910 351



1



1

Automatic spiral plater and diluter easySpiral® Dilute

NEW

A 2-in-1 unit for automatic plating with the possibility of combined serial dilution series. The instrument allows up to 5 serial 1/10 dilutions of a sample to be prepared and then automatically plated onto a Petri dish. Patented circular application: 3 dilutions on a 90 mm Petri dish, 6 dilutions on a 150 mm Petri dish. The countable range is between 30 and 1×10^{12} CFU/mL on a single Petri dish.

interscience

- Times (for different sample viscosities) and volumes are also programmable via USB
- Traceability through Excel™ Export, Data Matrix label
- Intensive cleaning
- Patented overflow technology cleaning system
- 8 bar pump pressure
- 2 fully autoclavable bottles (diluent and disinfectant) and connectors

Specifications

Petri dish size:	55 ... 150 mm
Syringe capacity:	1000 µl
Volume dispensed:	10 ... 1000 µl
Counting range:	30 ... 1×10^{12} CFU/ml
Full cycle time:	134 seconds
Preset pipetting volumes:	50, 100 und 200 µl
Plating modes:	exponential, circles, uniform, pour plate
Cleaning autonomy:	1000 cycles (2 l bottles)
Dimensions (W x D x H):	400 x 415 x 290 mm
Weight:	16.4 kg
Power supply:	100-240 V /50-60 Hz

Type	Dimensions (W x D x H) mm	Weight kg	Supply requirements V	PK	Cat. No.
easySpiral® Dilute	400 x 415 x 290	16.4	100 ... 240 V / 50 ... 60 Hz	1	7.649 479

2



2

LLG-Petri dishes, soda-lime glass

Ext. diam. mm	Height mm	PK	Cat. No.
40	12	1	9.170 570
60	15	1	9.170 571
80	15	1	9.170 572
90	15	1	9.170 575
100	10	1	9.170 573
100	15	1	9.170 574
100	20	1	9.170 576
120	20	1	9.170 577
150	25	1	9.170 578
180	30	1	9.170 579
200	30	1	9.170 580
200	50	1	9.170 581
40	12	10	6.291 543
60	15	10	6.291 544
80	15	10	6.291 545
90	15	10	6.291 548
100	10	10	6.291 546
100	15	10	6.291 547
100	20	10	6.291 549
120	20	10	6.291 550
150	25	10	6.291 551
180	30	10	6.291 552
200	30	10	6.291 553
200	50	10	6.291 554

3



3

Petri dishes, Soda-lime glass

Steriplan®. Hydrolytical class 3.

DWK Life Sciences

Ext. diam. mm	Height mm	PK	Cat. No.
40	12	1	9.170 401
60	15	1	9.170 417
80	15	1	9.170 432
90	15	1	6.236 335
100	15	1	9.170 442
100	20	1	9.170 443
120	20	1	9.170 448
150	25	1	9.170 451
180	30	1	9.170 456
200	30	1	9.170 460
200	45	1	9.170 461

1 Petri dishes, DUROPLAN®, borosilicate glass 3.3

DURAN®. With lid. Petri dishes are manufactured in a special production process which results in an even media dispersion and a uniform cell growth. Bottom and lid are absolute planar and free from bubbles and cords.
Glass Type I/neutral glass as per USP, EP and JP. Autoclavable. DIN 13132.

DWK Life Sciences



Ext. diam. mm	Height mm	PK	Cat. No.
60	20	1	9.170 141
80	20	1	9.170 143
100	15	1	9.170 146
100	20	1	9.170 148
120	20	1	9.170 151
150	30	1	9.170 153

2 LLG-Petridishes, PS

Made of high quality optical clear polystyrene. Produced under aseptic conditions in an ISO 6 cleanroom. Contact plate with counting grid.

- With a smooth surface for an optimal distribution of the transport medium
- Stable thickness to prevent any deformations while using
- Stackable
- With or without vents
- Aseptic (90 mm diam.) or beta irradiated sterile versions (all sizes)
- Packed in sleeves á 10 dishes or 20 dishes (90 mm diam. dishes)

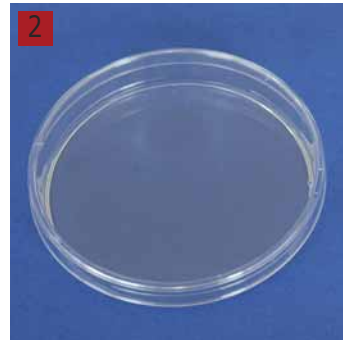

Ext. diam. mm	Description	Height approx. mm	PK	Cat. No.
90	with triple vents, aseptic	16	480	6.285 823
90	without vents, aseptic	16	480	6.285 824
90	with triple vents, sterile	16	480	6.285 816
90	without vents, sterile	16	480	6.285 817
60	with triple vents, sterile	14	1080	4.678 371
60	without vents, sterile	14	1080	4.678 372
55	contact plate, sterile	17	1000	6.285 821
150	with triple vents, sterile	19	180	6.285 822

3 Petri dishes, PS

Non-sterile. For bacteriology. With or without vents. In light or heavy duty versions.

Greiner Bio-One

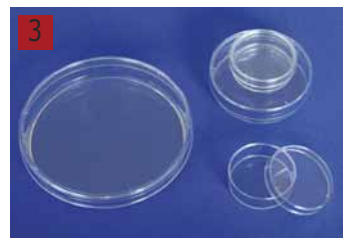

Ext. diam. mm	Height mm	Vents	Version	PK	Cat. No.
35	10	With	Light	740	9.408 035
60	15	With	Light	600	9.408 040
94	16	Without	Light	480	9.408 094
94	16	Without	Heavy	480	9.408 047
94	16	With	Light	480	9.408 095
94	16	With	Heavy	480	9.408 045
100	20	With	Light	360	6.510 005
145	20	With	Light	120	6.052 085

4 Biological test dish

Thermo Scientific™ Nunc™ Square BioAssay Dishes Available on GSA/VA Contract for Federal Government customers only. Screen large numbers of colonies for cloning experiments, culturing bacteria, fungi and agar diffusion assays using Thermo Scientific™ Nunc™ Square BioAssay dishes.

Thermo Scientific

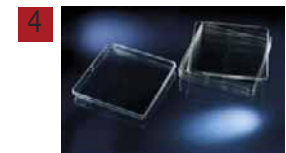

Description	Working volume	Culture surface	Sterile	Dimensions (W x D x H) mm	PK	Cat. No.
	ml	cm ²				
Standard high, with lid	225	500.0	+	245 x 245 x 25	16	6.076 793
Low profile, with lid	215	478.0	+	241 x 241 x 20	20	6.401 626

Petri dish holder

Constructed in steel wire, as outlined below. Suitable for dish diameters of 100mm, Internal diameter approx. 102mm, Internal height approx. 230mm. For approx. 10 petri dishes.



Description	PK	Cat. No.
Electropolished, grade 1.4301 stainless steel	1	9.908 127
White nylon-coated	1	9.908 128

9.908 127



1 PARAFILM® M sealing film

Can be stretched up to 200 % and clings around irregular shapes and surfaces. Parafilm® M is resistant to many polar substances such as saline solutions, inorganic acids and alkaline solutions for up to 48 hours (After this time it may become brittle). Parafilm® M conforms to general FDA requirements if used below 55 °C.

Melting temperature: 60 °C
Continued use temperature: -45°C to +50 °C
Stretching ability: 200 %

Type	Width mm	Length m	PK	Cat. No.
PARAFILM® M	50	75	1	9.170 003
PARAFILM® M	100	38	1	9.170 002
PARAFILM® M	100	75	1	9.170 005
PARAFILM® M	500	15	1	9.170 004



2 3 Inoculating Turntable

Manually operated turntable guarantees smooth and easy rotation in both directions. ISOLAB
Also enables easy and fast allocation of bacteria across petri dish surface. Double-sided construction accommodates petri dishes from 60 to 150 mm diameter by inverting the turntable. Ball bearings provide smooth and effortless spinning, ensuring rapid inoculation steps and extended operation life. Light weight but robust body manufactured from aluminum with non-skid feet. The silicone pad holds the petri dishes firmly and always keeps the dish centered during inoculation steps. The non-skid pad can easily be removed for fast and efficient cleaning.



Description	PK	Cat. No.
Inoculating Turntable	1	6.286 850

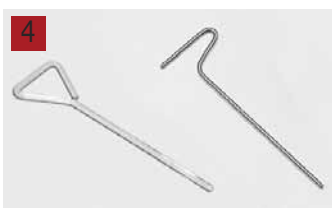

4 Petri dish turntables, schütt Petriturn

For uniform inoculation of petri dishes. Easy-to-use. Made in Germany.

schütt petriturn-M

With manually operated, heavy turntable for smooth and long-lasting rotation. Double-sided construction accommodates two sizes of petri dish (90mm or 150mm diameter), by inverting the turntable.

schütt petriturn-E

Electrically driven (100 - 240 V, 50/60 Hz), constant speed rotation. Easy operation of the rotary table contact-free start via IR sensor (adjustable rotation time from 3 to 120 sec.), in continuous operation or optionally in foot switch mode. Infinitely adjustable speed from 10 to 120 rpm. For Petri dishes up to Ø 100 mm (Ø 150 mm optional). Compact housing made of stainless steel.



9.520 201

Type	Dimensions mm	PK	Cat. No.
schuett petriturn-M, manually driven	(Dia. x H) 160 x 45	1	9.520 201
schuett petriturn-E, electrically driven	(Dia. x H) 160 x 70	1	9.520 200
Foot pedal for schuett petriturn-E		1	9.520 203
Turntable adapter for Petri dishes up to 150mm diameter		1	9.520 204
Glass inoculation spreader	(W x D) 180 x 58	1	9.520 206
Stainless steel inoculation spreader	(W x D) 145 x 40	1	9.520 205

LLG-spatulas, sterile

Ideal for the uniform spreading of cell cultures and liquids.

- Smooth , rounded surfaces for uniform spreading without scratching the agar surface
- Ethylene oxide sterilized
- Sterile, 10 per bag or individually packed

Description	Width mm	Length mm	Material	Package contents	PK	Cat. No.
LLG - Spatula, L-shaped, blue, sterile	38	156	ABS	50 x 10	500	6.265 638
LLG - Spatula, L-shaped, blue, sterile	38	156	ABS	individually packed	500	6.265 639
LLG - Spatula, T-shaped, blue, sterile	34	140	ABS	50 x 10	500	6.265 640
LLG - Spatula, T-shaped, blue, sterile	34	140	ABS	individually packed	500	6.265 641
LLG - Spatula, triangle-shaped, blue, sterile	30	208	PP	10 x 10	100	6.313 631

1



6.265 638

2



6.265 640

3



6.265 641

4 LLG-Drigalski spatulas and Inoculation hooks

For easy plating.

Description	Diam. mm	Width mm	Length mm	Material	PK	Cat. No.
LLG-Drigalski spatulas	4	40.0	190	Stainless steel 18/10	1	9.197 490
LLG-Drigalski spatulas	3	24.5	150	Wironit, CrNi 18/12, straight	1	9.197 496
LLG-Drigalski spatulas	3	45.0	190	Wironit, CrNi 18/12, angular 10°	1	9.197 497
LLG-Drigalski spatulas	5	30.0	150	Borosilicate glass 3.3	1	9.197 499
LLG-Drigalski spatulas, individually packed	4	51.5	174	PS, sterile	100	6.251 768
LLG-Inoculation hook	5	40.5	145	Glass	1	9.520 206
LLG-Inoculation hook	4	57.0	185	Stainless steel	1	9.520 205

4

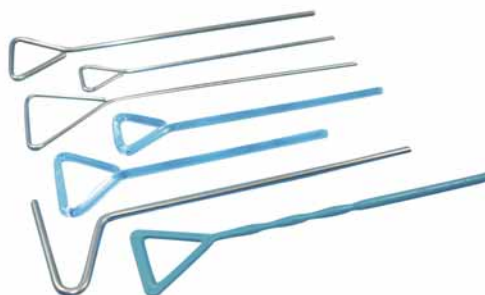

5 Toothpick in dispenser

Toothpick in dispenser, loose with 2 tips, pack of 1000 per dispenser.

5



Description	Package contents	PK	Cat. No.
Toothpick in dispenser, 80 x 2mm, Birch wood	20 x 1000	20000	6.270 862
Toothpick in dispenser, 65 x 2mm, Bambus	20 x 1000	20000	6.270 863

1

6.085 021

Cotton Swabs

Single or double cotton bud. Wooden, PP or paper applicator.

Heinz Herenz
WA 1-I, WA 1 D: Calibrated wooden rod with minimum diameter tolerances.

WA 1s, WA 1s PL, WA 1s 2x, WA 1s 25x, WA 2 PLs: Single, double or 25 pieces packed in peel-pack, EO-sterilized.

WA 7, WA 7 PL: Double cotton bud.

WA P: Flexible, bendable

2

7.615 467

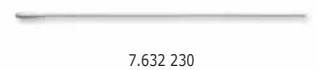
3

7.632 230

Type	Length mm	Head size mm	Material	PK	Cat. No.
WA 1-I	150	4-5 x 12	wood	2000	6.085 021
WA 1 D	150	5-5,5 x 12	wood	1000	6.085 144
WA 1 PP	150	5-5,5 x 12	PP	100	7.623 633
WA 1s	150	5-5,5 x 12	wood, single, sterile	100	6.901 126
WA 1s PL	150	5-5,5 x 12	PP, single, sterile	100	7.627 765
WA 1s 2x	150	5-5,5 x 12	wood, double, sterile	100	6.228 506
WA 1s 25x	150	5-5,5 x 12	wood, 25 pcs, sterile	25	6.240 992
WA 2	150	10 x 35	wood	500	7.618 075
WA 2	300	10 x 35	wood	500	6.287 329
WA 2	150	9 x 30	wood, thin	500	7.618 074
WA 2 PL	150	10 x 35	PP	1000	7.625 078
WA 2 PLs	150	10 x 35	PP, single, sterile	500	6.236 096
WA 3	400	15-20 x 50-60	wood	100	7.628 273
WA 7	80	4-5 x 12	wood, double bud	100	6.257 221
WA 7 PL	80	4-5 x 12	PP, double bud	2000	7.615 467
WA P	150	2,8 x 12	paper	2000	7.632 230

4

4 Cotton Applicator

Ideal for sampling in laboratories

Böttger

9.413 160: non-sterile, according to EN ISO 13485

9.413 161: sterile, according to EN ISO 13485 and conforming to 93/42/EEC, enclosure V for medical products, sterilised with ETO gas

Length mm	Wall thickness mm	Head size	Sterile	Material	Package	PK	Cat. No.
150	2.2	Ø 4 to 5.5 mm	no	Wood	bag	100	9.413 160
150	2.2	Ø 4 to 5.5 mm	yes	Wood	single, Peel-Pack	100	9.413 161

5

5 LLG-Inoculation loops, PS, sterile

Made of flexible polystyrene. With ultra-smooth loops for problem-free planting and streaking of cultures. Free of lubricants, oils and electrostatic charges, enabling consistent and complete liquid transfer. Ergonomic design of the loops for optimal grip and an easy orientation of the loop head. Needle end shape is perfect for picking off individual isolated colonies and suitable for making stab inoculations into agar slants or tubes of solid culture medium.

Package: 10 bags of 10 pieces

Type	Capacity µl	PK	Cat. No.
Needle / loop	1	100	9.160 041
Needle / loop	10	100	9.160 042
Loop / loop	1 / 10	100	9.160 043

6

6 LLG-Inoculation Loops, sterile

Uniform surface wetting and complete transfer of the liquid. The inoculation loops are available as more rigid versions (PS) or flexible versions (HIPS). Smooth edges ensure gentle agar treatment.

- With ethylene oxide sterilized
- Color coded
- Hexagonal handle for easy handling

Capacity µl	Length mm	Material	Colour	Package contents	PK	Cat. No.
1	173	PS	transparent	50 bags of 20 pieces	1000	6.290 917
10	173	PS	green	50 bags of 20 pieces	1000	6.290 918
1	173	HIPS	yellow	50 bags of 20 pieces	1000	6.290 919
10	173	HIPS	white	50 bags of 20 pieces	1000	6.290 920

1 Inoculating loops and needles, PS

Radiation-sterilised. Semi-quantitative standard for sample handling, e.g. for diseases of the urinary tract. Surface treated to increase drop adhesion. Reduced contamination risks as product is disposable and does not require flaming.

Thermo Scientific



Type	Capacity µl	PK	Cat. No.
Blue loop	10	4000	4.675 484
Colorless loop	1	4000	4.675 483
Yellow needle	--	4000	4.675 482

Other colours on request

2 3 4 Inoculation loops "metal" and loop stands

Inoculation loops made from stainless steel, special stainless steel wire or platinum-iridium wire (90/10).

schuett-biotec

Can be heated to red heat.
Length: 60mm. Wire diameter: 0.5mm.

Inoculation loop holder according to Kolle for 0.3 to 0.7mm wire diameter. Stainless steel with handle. Fixed by union nut.

Inoculation loop stand robust and sturdy made of plastic (autoclavable). Accomodate up to 6 inoculation loop holders at any one time.

Type	Description	Loop diam. mm	PK	Cat. No.
P-I 1	Platinum-iridium	1	1	9.520 180
P-I 2	Platinum-iridium	2	1	9.520 181
P-I 3	Platinum-iridium	3	1	9.520 182
P-I 5	Platinum-iridium	5	1	9.520 184
E 1	Stainless steel, special wire	1	10	9.520 170
E 2	Stainless steel, special wire	2	10	9.520 171
E 3	Stainless steel, special wire	3	10	9.520 172
E 5	Stainless steel, special wire	5	10	9.520 174
W-1.5	Stainless steel	1.5	10	9.520 185
W-2.5	Stainless steel	2.5	10	9.520 186
W-4.0	Stainless steel	4.0	10	6.233 696
Inoculation loop holder	160 mm long		1	9.520 178
Inoculation loop stand R (round)	(Diam. x H) 80 x 50mm		1	9.520 190
Inoculation loop stand L (long)	(L x W x H) 180 x 50 x 50mm		1	9.520 191

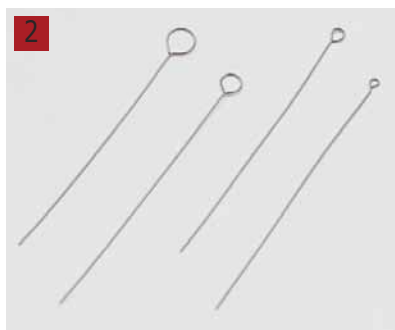

5 Stand for inoculation loop holders

Also suitable for ERGO-BRUSH brush holders.

NEW

Hammacher



Type	PK	Cat. No.
ERGO BRUSH holder	1	4.661 331

6 Inoculation loops Wironit

Wironit. CrNi 18/12.

Hammacher

Diam. mm	Length mm	PK	Cat. No.
1.5	50	1	9.160 057
2.0	50	1	9.160 056
2.5	50	1	9.160 058
4.0	50	1	9.160 055
1.5	60	1	9.160 061
2.5	60	1	9.160 062
4.0	60	1	9.160 063



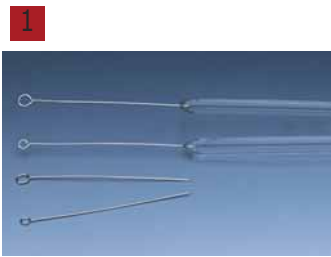

1 Inoculation loops, platinum-iridium

Platinum-iridium wire 90/10.
0.5mm thick.

Type	Diam. mm	PK	Cat. No.
without glass rod	3	1	9.160 050
without glass rod	2	1	9.160 052
fused into glass rod	3	1	9.160 053
fused into glass rod	2	1	9.160 054



2 Platinum-iridium wire

Platinum-iridium 90/10 wire available in different diameters.
Sold per cm.

Diam. mm	PK	Cat. No.
0.2	1	9.160 702
0.3	1	9.160 703
0.4	1	9.160 704
0.5	1	9.160 705
0.6	1	9.160 706
0.8	1	9.160 708
1.0	1	9.160 710



3 Culture media bottles DURAN®, glass, cylindrical

Rimless. For use with Kapsenberg caps. Glass Type I/neutral glass as per USP, EP and JP.
Autoclavable.

DWK Life Sciences

Capacity ml	Diam. mm	Neck diam. mm	Height mm	PK	Cat. No.
50	40	18	107	1	9.010 050
100	40	18	150	1	9.010 060
200	50	18	175	1	9.010 070



4 Kapsenberg caps

Aluminium. For the closure of culture tubes, bottles and flasks.

DWK Life Sciences

For neck diam. mm	PK	Cat. No.
16	1	9.010 116
18	1	9.010 118



5 Culture media bottles, glass, DURAN®

Beaded rim. Glass Type I/neutral glass as per USP, EP and JP.
Autoclavable.

DWK Life Sciences

Capacity ml	Diam. mm	Neck diam. mm	Height mm	PK	Cat. No.
100	50	29	115	1	9.010 224
300	70	42	168	1	9.010 239
500	83	42	207	1	9.010 244
1000	105	46	237	1	9.010 254
2500	150	50	315	1	9.010 266
5000	185	54	390	1	9.010 273



6 Culture flasks, DURAN®, Roux type

DURAN®. Roux type. With fire-polished, offset neck.
Glass Type I/neutral glass as per USP, EP and JP.
Autoclavable.

DWK Life Sciences

Capacity ml	Width mm	Length mm	Height mm	PK	Cat. No.
1200	123	275	56	1	9.010 512

1 Culture flasks, glass DURAN®, straight neck

DURAN®. Erlenmeyer. Straight neck. Suitable for metal caps. Glass Type I/neutral glass as per USP, EP and JP. With retrace code (Batch Identification). Certificate available via the Internet. Autoclavable.

DWK Life Sciences

Capacity	Diam.	Neck diam.	Height	PK	Cat. No.
ml	mm	mm	mm		
100	64	38	114	1	9.010 472
200	79	38	138	1	9.010 473
250	85	38	149	1	9.010 474
300	87	38	161	1	9.010 475
500	105	38	183	1	9.010 476
1000	131	38	229	1	9.010 477
2000	166	38	302	1	9.010 478



2 Culture flasks, borosilicate glass 3.3

Erlenmeyer. With 3 side baffles. Neck straight or with beaded rim.

Capacity	Diam.	Neck diam.	Height	Beaded rim	PK	Cat. No.
ml	mm	mm	mm			
100	64	38	112	without	1	9.010 120
250	85	38	145	without	1	9.010 121
500	105	38	183	without	1	9.010 122
1000	131	38	232	without	1	9.010 123
2000	166	38	305	without	1	6.236 466
250	85	34	140	with	1	9.010 125
300	87	34	156	with	1	9.010 126
500	105	34	175	with	1	9.010 127
1000	131	42	220	with	1	9.010 128



3 Baffled flasks, Pyrex® borosilicate glass

- Manufactured from Pyrex® borosilicate glass
- Exhibits 4 baffle indents to provide optimal and consistent agitation

Scilabware

Capacity	Diam.	Neck diam.	Height	PK	Cat. No.
ml	mm	mm	mm		
250	82	32	138	5	9.141 171
500	101	36	186	5	9.141 172
1000	129	43	222	2	9.141 173
2000	161	49	282	1	9.141 174



4 Baffled flasks DURAN®

With GL 45 thread

DWK Life Sciences

- Oxygen introduction is often a limiting factor for cell growth.
- Baffled flasks cause a turbulent flow, increase the gas exchange surface and produce a higher oxygen transfer.
- Automated one-step production enables a reproducible and comparable result.
- Complete with membrane screw cap (gas exchange).

Capacity	Bottom diam.	Neck diam.	Height	PK	Cat. No.
ml	mm	mm	mm		
250	85	30	145	1	9.141 260
500	105	30	149	1	9.141 261
1000	136	30	221	1	9.141 263



Fernbach baffled flasks, Pyrex®

For use in preparation of cultures.

Scilabware

- Large surface area to volume ratio
- Three laterally integrated baffles, to provide optimal and consistent agitation
- Available in 2 versions: with Delong neck, for use with culture flask caps or with PP screw cap, GL45

Description	Capacity	Diam.	Neck diam.	Height	PK	Cat. No.
	ml	mm	mm	mm		
Delong neck	2800	210	38	230	2	9.141 169
Screw cap	2800	210	45	230	2	9.141 170



9.141 169



1 Erlenmeyer flasks with baffles, PC



Thermo Scientific

Transparent. With baffles indented into the base which increases mixing when trypsinizing and aerating in processes such as cell culture and fermentation. Autoclavable. 500 ml and 1000 ml flasks have a straight neck, suitable for 38 mm standard caps of stainless steel, aluminium or plastic.

Capacity ml	PK	Cat. No.
250	12	4.675 585
500	12	4.675 586
1000	6	4.675 583
2000	4	4.675 584



2 LLG-Cellulose stoppers, Steristoppers®



Cellulose, 100% biodegradable and fully compostable autoclavable. Steristoppers® have been proved as an excellent sealing for microbiological samples and tissue cultures in test tubes and Erlenmeyer flasks. They are in constant use in many European microbiological laboratories.

- Autoclavable
- Filters bacteria
- Sterilisable
- Air permeable

Type	For inter. diam. mm	Bottom diam. mm	Top diam. mm	Length mm	PK	Cat. No.
No. 5 S	5,5 - 6,5	6	8,5	30	1000	9.231 205
No. 7	8,5 - 9,5	8	9,5	31	1000	9.231 207
No. 9	10,5 - 11,5	10	12,0	28	2000	9.231 209
No. 9 P	9,0 - 10,5	9	13,0	29	1000	6.801 854
No. 10	9,5 - 11,5	9	14,0	31	1000	9.231 210
No. 12	11,5 - 13,5	11	16,0	32	1000	9.231 211
No. 13	12,5 - 14,5	13	17,0	35	1000	9.231 212
No. 13 H	12,5 - 13,5	10	15,0	30	1000	7.628 015
No. 13.5	13,5 - 14,5	13	19,0	33	1000	9.231 213
No. 14	13,0 - 14,5	12	16,0	40	1000	9.231 214
No. 14,5	14,0 - 16,0	13	17,0	35	1000	9.231 216
No. 15	13,5 - 15,5	14	18,0	39	500	9.231 215
No. 15 D	13,5 - 16,0	12	19,0	36	5000	6.258 570
No. 18	17,5 - 18,5	17	21,0	38	500	9.231 218
No. 20	20,5 - 22,0	20	23,0	42	400	9.231 220
No. 22 long	22,0 - 24,0	24	26,0	49	500	9.231 224
No. 23.5 P	25,0 - 27,0	25	30,0	40	500	9.231 225
No. 26	26,0 - 27,0	23	28,0	42	500	9.231 226
No. 27	27,0 - 32,5	25	35,0	53	1000	7.210 063
No. 29	29,5 - 31,0	30	34,0	62	250	9.231 229
No. 32	32,5 - 35,0	32	36,0	64	100	9.231 232
No. 32 P	32,0 - 33,0	30	49,0	54	150	9.231 233
No. 32 W	32,5 - 35,0	31	36,0	65	800	9.231 231
No. 34	33,5 - 36,5	33	38,0	63	150	9.231 234
No. 36	35,5 - 39,5	36	40,0	58	600	7.600 688
No. 37	37,5 - 41,5	39	46,0	59	100	9.231 237
No. 38	40,0 - 43,5	38	48,0	60	100	9.231 238
No. 40 P	42,0 - 46,5	40	50,0	53	100	9.231 240
No. 45 P	47,0 - 48,0	45	60,0	66	75	9.231 245

P = correct fit, D = thin, W = soft, S = pointed, H = tougher version



1 Sterile stoppers SILICOSEN® and BIO-SILICO®

SILICOSEN® and BIO-SILICO® are specially processed culture plugs in sterile rubber with continuous bubbles for preparation, filling and sterilisation of culture media. Their uniform pore structure and good air permeability make them excellent for the cultivation of aerobic microorganisms.

The choice between SILICOSEN® and BIO-SILICO® culture stoppers depends on the requirements of the application. SILICOSEN® culture stoppers have low water evaporation which makes them particularly suitable for long term cultures. BIO-SILICO® culture stoppers have high air permeability, similar to cotton plugs. Both types are chemically resistant, temperature resistant, liquid repellent and reusable.



2 Sterile stoppers SILICOSEN® S-Type



Hirschmann

Superb permeability. Suitable for aerobic bacterium cultures and shaking cultures.

Type	Top diam. mm	Bottom diam. mm	Cylinder length mm	Cone length mm	Joint size (NS)	PK	Cat. No.
S-28	28	17	18	27	17/26	1	9.231 178
S-35	35	24	20	30	24/33	1	9.231 185
S-40	39	28	20	30	28/38	1	9.231 190



3 Sterile stoppers SILICOSEN® T-Type



Hirschmann

Moisture evaporation is minimal, thus there is less drying of the culture medium.
Colour: natural.

Type	Cylinder length mm	Cone length mm	Joint size (NS)	PK	Cat. No.
T-10	13	17	6/9	1	9.231 010
T-12	14	17	9/11	1	9.231 012
T-15	15	20	11/14	1	9.231 015
T-17	10	30	13/16	1	9.231 017
T-19	12	30	15/18	1	9.231 019
T-22	15	30	18/21	1	9.231 022
T-24	21	31	20/23	1	9.231 024
T-28	20	35	20/23	1	9.231 028
T-32	23	32	22/30	1	9.231 032
T-38	30	35	26/35	1	9.231 038
T-42	35	50	30/40	1	9.231 042
T-52	40	60	40/50	1	9.231 052
T-66	40	60	54/63	1	9.231 066
T-76	40	60	64/74	1	9.231 076



4 Sterile stoppers SILICOSEN® C-Type



Hirschmann

Superb permeability and fits tight onto the media container due to sealing lip, where importance is placed on mounting quality. Suitable for shaking cultures.

Type	d1 mm	I1 mm	d2 mm	d3 mm	Joint size (NS)	PK	Cat. No.
C-20	16	28	12	20	15/20	1	9.231 120
C-30	26	28	18	30	20/30	1	9.231 130
C-40	36	28	27	40	30/40	1	9.231 140
C-55	50	28	34	55	40/50	1	9.231 150
C-65	57	42	65	28	42/52	1	9.231 160



1



1 Sterile stoppers BIO-SILICO® N-Type

Hirschmann



Cell size is uniform, which provides stable and good permeability. Optimum product for shaking cultures-durability and operability are excellent.

Type	Top diam. mm	Bottom diam. mm	Cylinder length mm	Cone length mm	Joint size (NS)	PK	Cat. No.
N-12	13	9	13	17	9/11	1	9.231 100
N-15	16	11	14	22	11/14	1	9.231 101
N-17	19	13	15	25	13/16	1	9.231 102
N-19	21	15	16	28	15/18	1	9.231 103
N-22	24	18	18	30	18/21	1	9.231 104
N-24	26	20	20	32	20/23	1	9.231 105
N-28	30	21	20	34	21/26	1	9.231 109
N-32	34	22	24	36	22/30	1	9.231 106
N-42	44	30	32	46	30/40	1	9.231 107
N-52	54	40	36	50	40/50	1	9.231 108

2

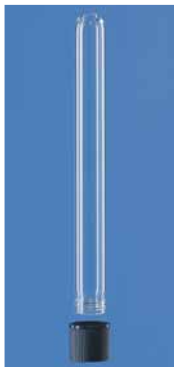

2 Culture tubes, soda glass, not graduated

Rimless or with PP screw cap and white TPE elastomer seal. Autoclavable at 121 °C (2 bar), according to DIN EN 285.

BRAND

Description	Capacity ml	Ext. diam. mm	Height mm	Wall thickness mm	Max. rcf x g	PK	Cat. No.
thread GL 14	6.5	12	100	1.0	3000	100	9.010 032
thread GL 18	10.0	16	100	1.0	3000	100	9.010 036
thread GL 18	20.0	16	160	1.0	1800	100	9.010 037
thread GL 18	30.0	18	180	1.0	1100	100	7.019 348
rimless	3.0	10	75	0.6	3000	250	9.010 040
rimless	5.5	12	75	0.6	3000	250	9.010 041
rimless	7.5	12	100	0.6	3000	144	6.312 970
rimless	13.0	16	100	0.7	2600	78	9.010 043
rimless	18.0	16	125	0.7	1800	105	9.010 044
rimless	22.0	16	160	0.7	1500	100	9.010 045
rimless	30.0	18	180	0.7	900	121	9.010 039

3



3 Disposable culture tube, Soda-lime-glass

From Soda-lime-glass. Straight rim.

DWK Life Sciences

Capacity ml	Outer diam. mm	Height mm	Wall thickness mm	PK	Cat. No.
4	9,75	75	0,80	814	4.652 793
4	10,00	75	0,60	250	6.701 755
5	11,75	75	0,80	550	4.652 794
6	11,75	75	0,55	250	6.286 586
7	12,25	75	0,55	500	7.072 127
6	12,25	75	0,80	500	6.235 314
8	11,75	100	0,80	550	6.257 184
9	12,25	100	0,80	500	7.079 811
14	15,50	100	0,80	250	7.200 457
15	15,75	100	0,90	250	7.614 741
18	12,25	120	0,80	250	7.072 274
8	10,00	150	0,80	250	6.263 370
19	15,50	150	0,80	250	7.613 424
22	15,50	160	0,80	250	6.072 878

4



4 Disposable culture tube, Borosilicate glass

Straight rim.

DWK Life Sciences

Capacity ml	Outer diam. mm	Height mm	PK	Cat. No.
1	6	50	1000	6.202 371
4	10	75	1000	6.073 292
6	12	75	1000	6.202 825
10	13	100	1000	6.072 378
15	16	100	1000	6.084 955
24	16	150	1000	6.257 491
28	18	150	500	6.251 868

1 Disposable culture tubes, soda-lime glass, with screw cap

From Soda-lime glass. With DIN thread and PP screw cap

DWK Life Sciences

Capacity ml	Outer diam. mm	Height mm	Wall thickness mm	DIN-Thread GL	PK	Cat. No.
6	12	100	1	14	100	7.021 547
12	16	100	1	18	100	7.021 548
22	16	160	1	18	100	7.021 549
32	18	180	1	18	100	7.021 550



2 Culture tubes, Borosilicate glass 3.3, screw cap

For culture growth, transport and storage. Heavy walled, thickness 1.1mm.

Wide neck for easy inoculation and cleaning. Complete with aluminium or plastic screw cap and rubber sealing gasket. Autoclavable.

schuett-biotec

Diam. mm	Nominal capacity ml	Length mm	PK	Cat. No.
16	15	98	100	9.010 612
16	20	150	100	9.190 600
16	15	98	100	9.010 613
16	20	150	100	9.190 605
25	50	150	100	9.010 620

Spare screw caps on request.



3 Tubes, glass, DURAN®, culture, screw cap

DIN thread. Complete with red PBT screw cap with PTFE-faced sealing wad. Thus, it is suitable for the cultivation of microorganisms. Glass Type I/neutral glass as per USP, EP and JP. Autoclavable.

DWK Life

Diam. mm	Height mm	Neck thread GL	PK	Cat. No.
12	100	14	50	9.010 012
13	100	14	50	9.010 013
16	150	18	50	9.010 014
16	160	18	50	9.010 016
18	180	18	50	9.010 018
20	150	18	50	9.010 019



4 Culture tubes, glass DURAN®, small, rimless

To DIN 38411. Rimless. Suitable for use with Kapsenberg caps. Glass Type I/neutral glass as per USP, EP and JP. Autoclavable. Please order cap separately.

DWK Life Sciences

Diam. mm	Height mm	Wall thickness mm	PK	Cat. No.
16	160	1.0 to 1.2	100	9.010 046
18	180	1.0 to 1.2	100	9.010 048



5 Test tubes, Durham, soda lime glass

Durham test tubes are mainly used in microbiology to detect gas produced by micro organisms. These special tubes are placed upside down in bigger test tubes.

Marienfeld

- Made of soda lime glass
- With straight rim and with round bottom
- Ungraduated

Diam. mm	Wall thickness mm	Height mm	PK	Cat. No.
6	0.7	35	250	6.266 183
6	0.7	50	350	6.266 184



➔ Kapsenberg caps - please see page 1370.



Metal caps

For culture flasks and culture medium bottles.

DWK Life Sciences

For neck diam. mm	Material	PK	Cat. No.
38	Stainless steel	1	9.010 481 1
38	Aluminium, anodised blue	1	9.010 482 2



3 Metal caps, Erlenmeyer, Aluminium

Anodised in a choice of colours. *schuett-biotec*

Special caps for sterile, but not hermetically sealing, closure of culture flasks and media bottles with straight, rimmed or rimless necks as indicated. With nichrome steel springs that clamp onto the outer wall of the container.

Cleaning advice available on request.

For neck diam. mm	Colour	PK	Cat. No.
37/39	silver	10	9.231 456
37/39	blue	10	9.231 457
37/39	red	10	9.231 458



4 Metal caps, Labocap without handle

schuett-biotec

For neck diam. mm	Colour	Handle	PK	Cat. No.
9/10	blue	without	100	9.231 421
12/13	blue	without	100	9.231 422
14/15	blue	without	100	9.231 423
15/16	blue	without	100	9.231 424
17/18	blue	without	100	9.231 425
19/20	blue	without	100	9.231 426
21/23	blue	without	100	9.231 427
24/26	blue	without	100	9.231 428
28/30	blue	without	100	9.231 429
9/10	red	without	100	9.231 441
12/13	red	without	100	9.231 442
14/15	red	without	100	9.231 443
15/16	red	without	100	9.231 444
17/18	red	without	100	9.231 445
19/20	red	without	100	9.231 446
21/23	red	without	100	9.231 447
24/26	red	without	100	9.231 448
28/30	red	without	100	9.231 449
12/13	yellow	without	100	9.231 460
15/16	yellow	without	100	9.231 461
17/18	yellow	without	100	9.231 462
19/20	yellow	without	100	9.231 339
12/13	green	without	100	9.231 463
15/16	green	without	100	9.231 464
17/18	green	without	100	9.231 465
19/20	green	without	100	9.231 340
09/10	silver	without	100	9.231 369
12/13	silver	without	100	9.231 372
14/15	silver	without	100	9.231 374
15/16	silver	without	100	9.231 375
17/18	silver	without	100	9.231 377
19/20	silver	without	100	9.231 379
21/23	silver	without	100	9.231 381
24/26	silver	without	100	9.231 385
28/30	silver	without	100	9.231 388
12/13	black	without	100	9.231 334
15/16	black	without	100	9.231 466
17/18	black	without	100	9.231 337
19/20	black	without	100	9.231 341
12/13	violet	without	100	9.231 335
15/16	violet	without	100	9.231 336
17/18	violet	without	100	9.231 338
19/20	violet	without	100	9.231 342

1 Metal caps, Labocap with handle, Aluminium

Anodised in a choice of colours. For sterile, but not hermetically sealing, closure of containers. With nichrome steel springs that clamp onto the outer wall of the container. Autoclavable. Cleaning advice available on request.

schuett-biotec

For neck diam. mm	Colour	Handle	PK	Cat. No.
15/16	silver	with	100	9.231 345
17/18	silver	with	100	9.231 347
15/16	blue	with	100	9.231 403
17/18	blue	with	100	9.231 404
15/16	red	with	100	9.231 413
17/18	red	with	100	9.231 414
15/16	yellow	with	100	9.231 326
17/18	yellow	with	100	9.231 330
15/16	green	with	100	9.231 327
17/18	green	with	100	9.231 331
15/16	black	with	100	9.231 328
17/18	black	with	100	9.231 332
15/16	violet	with	100	9.231 329
17/18	violet	with	100	9.231 333



2 Aluminium caps, pure aluminium

Matt finish. Without internal clips. Loose-fit caps for sterile, but not hermetically sealing, closure of culture flasks and other containers. Can also be used as open specimen holders. Autoclavable.

schuett-biotec

Int. diam. mm	Height mm	PK	Cat. No.
11	25	100	9.230 821
12	25	100	9.230 822
13	25	100	9.230 823
14	25	100	9.230 824
15	25	100	9.230 825
16	30	100	9.230 826
17	30	100	9.230 827
18	30	100	9.230 828
20	30	100	9.230 829
22	30	100	9.230 830
28	30	100	9.230 831
32	30	100	9.230 832
39	30	10	9.230 833
44	40	10	9.230 834
48	40	10	9.230 835
55	40	10	9.230 836
58	40	10	9.230 837



Anaerobic jars, stainless steel

For the cultivation of anaerobic and microaerophilic microorganisms in a defined and rapidly generated gas atmosphere. *schuett-biotech*
 The requested atmosphere may be reached under ideal conditions by two methods. Either by using chemical gas packs (anaerobe systems) or by manually evacuating the jars with a vacuum pump and flushing with gas afterwards (e.g. with nitrogen), in this case no chemical accessories are needed (except anaerobic jar eco and crystal eco). The jars are made of robust stainless steel or transparent PC. The lids are made of UV-resistant plastic or transparent polycarbonate with two corner valves incl. tube clips for vacuum hoses (5 mm i.d.) and with manometer for exact control of the vacuum or overpressure from -1 to 0.2 bar (except anaerobic jar eco and crystal eco). The optional racks are made of stainless steel providing holders for comfortable operation of the anaerobe systems.

Methods for reaching anaerobic conditions: 3 x times evacuating and filling gas, flushing with gas for 5 minutes and chemical gas production (GasPacks) for Anaerobic jars "small", "standard", "large" and "crystal". For Anaerobic jar "eco" flushing with gas for 5 minutes (Using GasPack-Kits).

Customized: Other equipment available upon request. Examples: customized lids, e.g. made of special or heat-resistant materials e.g. stainless steel, heat-resistant pressure gauges (up to 100 °C), also without cocks/manometer available.

Type	To hold dishes quantity	Capacity l	Int. diam. mm	Int. height mm	PK	Cat. No.
small*	10 (60-100 mm diam.)	2	120	170	1	9.520 051 1
standard*	15 (60-100 mm diam.)	3	120	270	1	9.520 056 2
large*	15 (60-150 mm diam.)	6	175	260	1	9.520 050 3
eco**	15 (60-100 mm diam.)	3	120	270	1	9.520 057 4
crystal***	15 (60-100 mm diam.)	3	120	270	1	9.520 058 5
crystal eco****	15 (60-100 mm diam.)	3	120	270	1	6.287 615 6

*Stainless steel jar with UV-resistant plastic lid (2 valves, 1 manometer)

**Stainless steel jar with UV-resistant plastic lid (ventilation screw)

***Transparent polycarbonate jar and lid (2 valves, 1 manometer)

****Polycarbonate jar with UV-resistant plastic lid (ventilation screw)



Accessories for anaerobic jars

schuett-biotech

Type	To hold dishes quantity	PK	Cat. No.
Rack "small" (for all Anaerobic jars)	10 (60 to 100mm dia.)	1	9.520 059
Rack "standard" (for "standard", "large", "eco", "crystal")	15 (60 to 100mm dia.)	1	9.520 053
Rack "150" (for "large")	15 (up to 150mm dia.)	1	9.520 060
Rack "3 x 60" (for "large")	45 (60mm dia.)	1	9.520 061
Rack "micro" (for "large")	for multiwell plates	1	9.520 062
Test tube holder (for all Anaerobic jars)	for 9 test tubes (18mm dia.)	1	9.520 063
GAS-Pack-Kit "anaerobic" (1 x 3.5 l)		10	9.520 064
GAS-Pack-Kit "CO2" (1 x 2.5 l)		10	9.520 065
GAS-Pack-Kit "microaerophil" (1 x 3.5 l)		10	9.520 066
Anaerobiose Indicator (test strip)		100	9.520 067

Bioreactors RTS-1/RTS-1C



Grant

Compact and efficient bioreactors providing patented Reverse-Spin® type agitation and logging of microbial growth, in 50 ml tubes, in real time. For applications such as bacterial cultivation with real time growth kinetics, strain screening, temperature stress and fluctuation experiments media screening and optimization, synthetic and systems biology, inhibition and toxicity tests and strain quality control.

- 3D graphical representation of OD or growth rate over time over unit
- Easy-to-read LCD screen displaying temperature, RPM and time
- Programmable cycling/profiling of cultivation parameters such as temperature, RPM, Reverse-Spin® frequency
- Active cooling and temperature profiling via software (RTS-1C only)
- Minimum PC requirements: Intel/AMD Processor, 1 GB RAM, Windows XP (not guaranteed)/Vista/7/8/8.1/10, 2.0 USB port

Specifications

Theoretically possible measurement range in OD₈₅₀, at 10 ml working volume*

Rod shaped bacteria:	0 ... 25 (0 ... 45.6 OD ₆₀₀ equivalent**)
Yeast:	0 ... 50 (0 ... 75 OD ₆₀₀ equivalent)
E.coli BL21 Factory calibration measurement range, in OD ₈₅₀	
at 10 ... 20 ml volume:	0 ... 10 OD (0 ... 19 OD ₆₀₀ equivalent)
at 20 ... 30 ml volume:	0 ... 8 OD (0 ... 15.2 OD ₆₀₀ equivalent)
Measurement wavelength (λ):	850 ±15 nm
Factory calibration measurement precision:	±0.3 OD ₈₅₀
Mass transfer coefficient kLa (h ⁻¹):	up to 350 ±26 h ⁻¹ at 5 ml
Bottom control range point RTS-1 // RTS-1C:	Ambient +5 // Ambient -15
Top control range point:	70 °C
Temperature stability:	±0.1 °C
Real time measurement:	1 ... 60 min
Revers spin time:	1 ... 60 s (increment 1 s)
Speed:	50 ... 2000 rpm (increment 10 rpm)
Precision:	±15 rpm
Dimensions (W x D x H):	130 x 212 x 200 mm
Power supply:	120 ... 230 V, 50/60 Hz

Type	Temp. range °C	Weight kg	PK	Cat. No.
RTS-1 EU	25 ... 70 (increment 0.1 °C)	1.7	1	4.671 974
RTS-1C EU	4 ... 70 (increment 0.1 °C)	2.2	1	4.671 975

*Highest kLa (h⁻¹) is achieved at 5 ml working volume which is optimal for aerobic cultivation
 **OD₈₅₀ to OD₆₀₀ vary between strains and phases of growth

Further accessories can be found in our online shop.



4.671 975

Loop steriliser SteriMax basic/smart

For rapid sterilisation of inoculation loops using infrared technology. Instantly ready for use without warm-up. Sterilisation at 750 to 1000 °C. Suitable for all laboratories, anaerobic working environments and laminar flow cabinets.

WLD-TEC

- Instantly ready to work without any unnecessary warm-up
- Heating tube made of special quartz glass
- Simple cleaning of the device and the heating tube
- Sterilisation tube closed on one side to prevent contamination
- With timer
- Easy to clean
- No danger of combustion on the housing (Cool-Touch)
- Efficient use of energy
- Tested and certified for photobiological safety in accordance with EN 62471 by the BG ETEM - Risk-free for skin and eyes
- Robust housing made of stainless steel and safety glass

Specifications

Temperatur range:	750 ... 1000 °C
Power consumption:	600 W
Dimensions (W x D x H):	110 x 180 x 170 mm
Weight:	1.8 kg
Power supply:	220 - 240 V, 50/60 Hz
IP code:	IP 20

1 Loop steriliser SteriMax basic

NEW

- Can be operated directly on the touch panel of the device or via optional foot pedal
- Fast and efficient, the sterilisation process takes only 10 seconds

WLD-TEC

Scope of supply: SteriMax basic, mains cable, 1 x Inoculation loop Ø 3 mm, 1 x Inoculation loop holder, power cable

Type	PK	Cat. No.
SteriMax basic	1	4.670 727

2 Loop Steriliser SteriMax smart

- Auto-Start through touchless IR-Sensor technology
- Touch operation
- Adjustable sterilisation and cool-down timers for two users

WLD-TEC

Scope of supply: SteriMax smart, 2 x quartz glass heating tubes, inoculation loop holder, inoculation loop (diam. 3 mm), holding device for 3 inoculation loops, power cable

Type	PK	Cat. No.
Loop Sterilizer SteriMax smart	1	6.261 507

1

2

1 Loop Sterilizer schuett solaris

Sterilisation with light. Sterilisation of inoculating loops, tweezers and small instruments within seconds.

schuett-biotec

- Sturdy and maintenance-free
- No gas, no open flame - Works with standard electrical power
- Intuitive, easy to use
- Instant, ready-to-use, no warm-up time, no waiting
- Sterilization temperature: 900 to 1300°C
- Touch-free START, with IR- sensor and adjustable timer (5 to 7 seconds)
- For use in Laminar Flow Cabinets
- Ideal for mobile operation in the field

The schuett solaris is the perfect solution if an open flame should be avoided or gas cartridges etc. are not available. Used with standard electrical power. Reaches the safe working temperature of 900 to 1300°C within a split second. No excess heat, no energy consumption between work cycles. START is generated by an infra-red sensor, which allows for efficient one-handed operation. Pathogenic material is kept inside the sterilization chamber. No spreading, no splashing. Working angle adjustment (4-steps).

Scope of supply: schuett solaris inoculation loop sterilizer, 2 x quartz glass tubes, 1 x inoculation loop holder with inoculation loop (sample)

Specifications

Dimensions (W x D x H): 152 x 195 x 210mm
Weight: approx. 2500g

Type	PK	Cat. No.
Loop Sterilizer schuett solaris, 230 V	1	9.018 741
Quartz tube with bottom, outer diam. 17mm, length 100 mm	2	9.018 742



2 Sterilisers STERI

The STERI second sterilisers permit instant disinfection and sterilization of all small instruments directly at the workplace. Especially suitable for laminar flow cabinets.

Simon Keller AG

Biological investigations and tests prove that the 250 °C temperature maintained in the glass bead container guarantees complete destruction of all micro-organisms and spores within a few seconds. The one part of the instrument which is inserted into the STERI glass beads is sterilized. The STERI 250 and 350 are two versions of the same quality apparatus, with a stainless steel container, high-performance heating element, reduced heating time, high precision thermostat, temperature limiter and built-in thermometer.

- For perfect hygiene directly at the workplace
- A guaranteed Swiss quality product

STERI 250: Steriliser incl. plain metal cover, glass-cup and glassbeads (150 g). Suitable for small & medium sized instruments (scissors, tweezers, forceps, knives, blades, spatulas, etc.).

STERI 350: Steriliser incl. plain metal cover and glassbeads (300 g). Especially suitable for medium sized and longer instruments.



Type	Filling quantity g	External dimensions (W x D x H) mm	Plug type	PK	Cat. No.
STERI 250	150	125 x 140 x 145	EU	1	6.286 282
STERI 250	150	125 x 140 x 145	CH	1	6.285 884
STERI 250	150	125 x 140 x 145	UK	1	6.286 283
STERI 350	300	125 x 140 x 205	EU	1	6.286 284
STERI 350	300	125 x 140 x 205	CH	1	6.285 885
STERI 350	300	125 x 140 x 205	UK	1	6.286 285

Accessories for Sterilisers STERI

Simon Keller AG

Description	For	PK	Cat. No.
Instrument lid, stainless steel	STERI 250/350	1	6.285 887
Instrument lid, stainless steel, isolated	STERI 250/350	1	6.285 892
Glass beads	STERI 25	1	6.285 888
Glass beads	STERI 250	2	6.285 889
Glass beads	STERI 350	1	6.285 890
Glass cup	STERI 250/350	1	6.285 891





1 Flame sterilizer schuett easyflame

Mobile device for scarfing and flame-sterilising. With piezoelectric-ignition and gas supply control to create a soft or sharp flame. Infinite adjustment of the flame. Highest operational safety. In short-term use, the flame is activated as long as the push button is pressed. For continuous operation with lock key.

schuett-biotec

schuett easyflame to use with propane/butane gas

1. Suitable with gas cartridges with 7/16" connection thread, e.g. CG 1750, Express 444, AT 2000.
2. Adapters for CV 360 or CP 250 gas cartridges optional.

schuett easyflame^{plus} for connecting natural gas and propane/butane gas with gas safety hoses

1. Natural gas hose for central gas supply for easy plugging the device (hose barb included)
2. Propane/butane gas hose with fitting (1/4"-left-hand thread) for the use of gas cartridge adapters or gas cylinders with pressure reducer. Matching adapters C 206 and CV 300/470 (already equipped with gas safety hose, 0.5m and reducer). Gas safety tubing in other lengths on request.

Specifications

Dimensions (W x D x H): 260 x 90 x 60mm
Weight: approx. 350g

Type	PK	Cat. No.
schuett easyflame for propane/butane gas	1	9.018 794
Adapter CV 360 (only for 9.018 794), for butane gas cartridges CV 360	1	6.260 874
Adapter CP 250 (only for 9.018 794), for butane gas cartridges CP 250	1	6.266 817
schuett easyflame ^{plus} for natural gas and propane/butane gas	1	6.266 818
Adapter C 206 (only for 6.266 818), for propane/butane gas cartridges C 206	1	6.244 006
Adapter CV 300/470 (only for 6.266 818), for propane/butane gas cartridges CV 300 / 470	1	6.240 475



2 Gas burner powerjet

NEW
WLD-TEC

Mobile handheld laboratory gas burner with piezoelectric ignition for liquid gas cartridges. Suitable for flame sterilisations in the microbiological or biotechnical field, where no central gas supply is available.

- For gas cartridges with 7/16" x 28 UNEF thread, e.g. CG1750
- Ignition at keystroke
- Size of the flame infinitely adjustable
- Gas supply only when bar is pressed
- With a locking device for long term flaming
- Safe handling due to one-handed operation

Scope of supply: Laboratory gas burner with gas cartridge adapter (7/16" x 28 UNEF thread)

Specifications

Weight: 300 g
Gas consumption: 120 g/h
Flame temperature: 1350 °C
Warranty: 2 years

Type	PK	Cat. No.
powerjet	1	7.970 147



3 Bunsen burner, portable Labogaz® 206

For operation with gas cartridge C 206 GLS (Cat.-No.: 9.018 520). DVGW-authorized.

Weight: 380g without cartridge
Height: 200mm with cartridge
Consumption: 55g/h

Type	PK	Cat. No.
Labogaz® 206	1	9.018 510



4 Bunsen burner, portable, Labogaz® 470

For operation with gas cartridges CV 300 Plus (Cat.-No.: 6.243 905) or CV 470 Plus (Cat.-No.: 9.018 512).

Weight: 380 g without cartridge
Height: 190 mm with cartridge CV 300 Plus
240 mm with cartridge CV 470 Plus
Consumption: 55 g/h

Type	PK	Cat. No.
Labogaz® 470	1	9.018 511

Gas cartridges

1

C 206 GLS pierceable cartridge

Piercing cartridge with integrated gas lock system according to EN 417: 2012. For bunsen burner without safety valve. For bunsen burners Labogaz® 206 and Soudogaz blow torches.

CV470 Plus and CV 300 Plus valve cartridge

With safety valve. For bunsen burner Labogaz® 470.

CV 360 valve cartridge

With safety valve. For gas-safety burner schuett phoenix (Cat.-No. 9.018 761).



6.243 905

Safety valve allows removal of partially used valve gas cartridges.



H phrases: H220

Type	Description	Height mm	Capacity g	PK	Cat. No.
C 206 GLS	Gas ratio 80/20 Butane/Propane	90	190	1	9.018 520
C 206 GLS	Gas ratio 80/20 Butane/Propane (large pack)	90	190	36	6.261 010
CV 300 Plus	Gas ratio 80/20 Butane/Propane	105	240	1	6.243 905
CV 470 Plus	Gas ratio 80/20 Butane/Propane	140	450	1	9.018 512
CV 470 Plus	Gas ratio 80/20 Butane/Propane (large pack)	140	450	12	6.261 011
CV 360	Butane	140	52	1	9.018 519

Suitable accessories can be found in our online shop.

2 Safety Bunsen Burners Flame¹⁰⁰

The safe alternative for all traditional Bunsen or alcohol burners.

WLD-TEC

Multi-Use: The Flame¹⁰⁰ is ideally suited for all flame related applications in the laboratory. The precision flame allows graduated heating of dental tools as well as safe sterilization of microbiological instruments. Flame size and intensity can be adjusted infinitely.

Easy operation: The safety Bunsen burner Flame¹⁰⁰ activates immediately with the push of a button. No match or a pilot flame are required. Optionally, the Flame¹⁰⁰ can also be operated by a foot pedal or an external infrared motion sensor. The Flame¹⁰⁰ is suitable for stationary natural gas and propane/butane gas supplies as well as gas cartridges or gas cylinders. Numerous adapter systems are optionally available.

Reliable safety: The proven Safety Control System (SCS) is also incorporated in the Flame¹⁰⁰. All potential hazards are constantly monitored and, if necessary, protective measures, such as shutting off the gas supply, are activated. In addition to the ignition and flame control function and the overheating protection the safety package also features the continuous burner head control BHC. BHC unflinchingly identifies burner head clogging by liquids or solid substances. Approved by DIN-DVGW, approval no. NG2211AS0167. 2 years warranty.

Description	PK	Cat. No.
Safety Bunsen burners Flame ¹⁰⁰	1	6.261 226

2



1



6.232 207

Safety Laboratory Gas Burners Fuego SCS series

WLD-TEC

Suitable for all flame related applications in the laboratory. The low profile body facilitates ergonomic operation; the streamlined design reduces air flow disturbances in a Cleanroom workbench. The Fuego SCS series can be operated with foot pedal, button function or touch free IR-Sensor. Made of stainless steel, with fireproof controls.

- SCS Safety Control System with gas safety cut off: Ignition and flame control, temperature monitor, automatic unit switch off, residual heat display, burner head assembly monitor.
- BHC Burner Head Control.
- Removable burner head.
- Tilt mechanism right/left.
- Turbo flame.
- Holding device for 3 inoculation loop holders.
- Operation with stationary natural gas and propane/butane gas supplies, cartridge gas or gas cylinders.
- Approved by DIN-DVGW, approval no. NG2211AS0167.
- Warranty: 2 years.

Fuego SCS basic/ Fuego SCS basic RF: With stainless steel foot pedal. The foot pedal regulates the burning time either by continuous foot pressure or by start-stop function. Instrument with ON/OFF button function. Basic model without IR-Sensor and without graphic display.

Fuego SCS basic RF: Features as Fuego SCS basic but enables wireless operation due to modern radio foot pedal.

2



6.231 770

Fuego SCS/Fuego SCS pro: with Double-Click IR-sensor, button function and foot pedal operation. (foot pedal optional). Double-Click IR-sensor: This adjustable safety function ensures that the burner can only be ignited by activating the IR-Sensor twice. Adjustable IR-sensor reaction distance: 5mm to 50mm.

Illuminated graphic display: The animated, self-explanatory and language-less symbol display facilitates a rapid selection of all functions. 6 standard-programs with count down display: 1sec to 2hrs selectable.

The first safety laboratory gas burner with comfort package: Cooling time reminder for inoculation loops, temperature regulation for heating media, gas consumption display for gas cartridges, flexible and individual by selecting user account, acoustic signals as operating aids.

Additional safety assistance: Zero-pressure shut off for a pressureless gas hose. Graphical installation instructions facilitate the initial start-up.

Fuego SCS pro: Features as Fuego SCS, plus battery operation (9hrs), 2 rechargeable batteries (Mignon AA), fast charge function (3hrs) and safety tilt sensor.

Additional accessories are available on request.

Specifications

Dimensions (W x D x H): 103 x 130 x 49mm
 Power supply: 100-240V 50/60Hz, max. 0.3A; 9 V DC, 1.3 A
 Weight: 700g

Type	PK	Cat. No.
Fuego SCS basic	1	6.232 207 1
Fuego SCS basic RF	1	6.255 678
Fuego SCS	1	6.231 770 2
Fuego SCS pro	1	9.018 584

We can supply this
 manufacturer's
 whole
 product range !



Safety Laboratory Gas Burners *gasprofi 1* SCS micro

Safe gas burner for sterilizing, heating and other flame related applications. In the event of unforeseen extinction, the flame is automatically re-ignited. If the flame extinguishes and does not re-ignite, the burner automatically closes the gas supply.

WLD-TEC

- Safety Control System (SCS) with ignition and flame control function and over temperature protection
- All outer components made of stainless steel
- Dismountable burner head
- Space-saving
- Low working height
- Operation with stationary natural gas and propane/butane gas supplies, cartridge gas or gas cylinders
- Energy saving
- Tilt adjustment
- Approved by DIN-DVGW, approval no. NG2211AS1067
- 2 years guarantee

gasprofi 1 SCS micro *school* edition

- Optimal safety in schools
- Button function
- 2 standard programs for button (function knob) and foot pedal
- Optional operation via foot pedal or external DoubleClick IR sensor

gasprofi 1 SCS micro

- Optimal in clean room workstations and in laboratories
- DoubleClick IR sensor, button function and stainless steel foot pedal
- 5 standard programs for IR sensor, button (function knob) and foot pedal
- IR sensor with adjustable operating distance
- Burner head control (BHC) and residual heat indicator
- Holding device for 3 inoculation loop holders

Specifications

Dimensions (W x D x H): 85 x 86 x 49 mm
 Weight: 700 g
 Power supply: 100-240 V, 50/60Hz, max. 0.3 A/9 V DC, 1.3 A



6.701 105



7.657 840

Type	PK	Cat. No.
gasprofi 1 SCS micro	1	6.701 105
gasprofi 1 SCS micro <i>school</i> edition	1	7.657 840

Accessories for Safety Laboratory Gas Burners *gasprofi 1* SCS micro/Fuego SCS

WLD-TEC

Type	PK	Cat. No.
Adapter for cartridges CV 360	1	6.233 324
Windshield, stainless steel	1	6.081 539
Spray protector	1	6.081 736
Carrousel for annealing of inoculation loops (<i>gasprofi</i>)	1	7.672 054
Carrousel for annealing of inoculation loops (<i>Fuego</i>)	1	6.242 237



6.081 539



6.081 736

Microbiology/Sterilizers and burners



9.018 760



9.018 761



9.018 798



7.930 139



9.018 752

Safety Bunsen Burner, schuett phoenix II

schuett-biotec

For sterilising, heating, flame sterilising. For use in every microbiological laboratory or in safety cabinets. Modern Bunsen burner with state-of-the-art safety features plus outstanding quality characteristics:

- Controlled burning time 1 sec to 120 min (selectable)
- Automatic safety shut-off (selectable)
- Overheating protection/burner control by sensors
- Precise economic flame regulation (stable flame in strong air current)
- Flame and ignition monitoring
- "Push-and-Twist" bayonet fixture for burner head, no tools needed for cleaning
- Tilting right or left

Operating status, safety notes and warnings pictures and full text (color display) written language for most international languages. Brilliant colour display. Unique Joy-Stick navigation. Operating modes: by hand or with foot pedal or motion sensor. Housing made of stainless steel and safety glass. UV- and solvent resistant. For case of cleaning and flame-sterilising. Suitable for use with natural gas (central gas) or butane/propane gas (gas cartridges). Integrated stand for tilting right or left. Safety standard acc. to DIN 30665 part 1, DIN-DVGW

schuett phoenix II eco: (with LED control lamp and foot-switch) Start flame by foot-switch or button (On/Off). Best suited for use in microbiological safety cabinets. Best price to performance ratio.

schuett phoenix II standard: (brilliant colour display, selection of native language, sensor and foot-switch) Start/Stop flame by activating sensor 1x or 2x, use foot switch or press button by hand. Continuous display of timer.

schuett phoenix II accu: (brilliant colour display, selection of native language, sensor and built-in extra heavy duty power cells) Start/stop flame by activating sensor 1x or 2x, use foot-switch or press button by hand. Continuous display of timer and battery power. Operates for up to 30 hours, intermittent use. Complete with battery charger for 3 hour recharging. Ideal for mobile usage.

Power supply: 100 - 240 V, 50/60 Hz

Flame sterilization carousels semi- and fully automated: For precise and time-controlled flaming of different kinds of inoculating loops. Minimization of gas consumption, the life of the inoculating loops is significantly increased. The inoculating loop is placed into the carousel after use and is sterilized immediately after turning the holder in flaming position. Sterilization time infinitely adjustable. Designed for continuous work-flow with sample series in the Laminar Flow.

Semi-automated: schuett easyloop (for 6 Inoculating loop holders, included): Comfortable manual rotation, fully automated flaming process. For use with Safety Bunsen Burners schuett phoenix II standard and accu. Sterilization time: 3 to 5 s (adjustable from 1 s to 120 min)

Fully automated: schuett flammy R (for 5 Inoculating loop holders, included): Fully automated rotation and inoculating. In combination with a standard gas-safety-burner (e.g. schuett phoenix II). Sterilization time: 2 to 10 s

Type	Width mm	Depth mm	Height mm	Weight g	PK	Cat. No.
schuett phoenix II eco*	128	160	85	1000	1	9.018 760 A
schuett phoenix II standard*	128	160	85	1000	1	9.018 761 B
schuett phoenix II accu	128	160	85	1000	1	9.018 762
schuett easyloop	150	190	310	900	1	9.018 798 C
schuett flammy R	100	160	345	2000	1	9.018 779

*incl. foot switch, stainless steel

Accessories for gas-safety burner schuett phoenix II

schuett-biotec

Type	PK	Cat. No.
Adapter for gas cartridges CV 360 incl. pressure reducer	1	7.930 139 A
Adapter for gas cartridges C 206*	1	6.244 006
Adapter for gas cartridges CV 300/470*	1	6.240 475
Adapter for gas cartridges CP 250*	1	9.018 750
Adapter for gas cartridges CG 1750*	1	9.018 751
Windshield, stainless steel	1	9.018 752 B
Glass spatter guard	1	9.018 753
Gas safety hose with threaded screw connections for propane/butane 0.5m	1	9.018 754
Gas safety hose with threaded screw connections for propane/butane 2.0m	1	9.018 755
Hot-Tray, stainless steel, height-optimized	1	9.018 756
Instrument tray	1	9.015 757
Foot-switch, stainless steel	1	9.018 758

* Incl. pressure regulator and 0.5m safety gas tubing.

LLG-Micropestles, stainless steel

Polished stainless steel, micropestles. Precisely fitted for Eppendorf Safe-Lock Tubes™, manufactured in one-piece, smooth handle sections, can be disinfected easily. Minimum homogenate displacement due to tapered piston.

For Reaction tubes:

For homogenisation of cells, tissues or foodstuffs/feed samples.

- For tubes with 0.5 ml, 1.5 ml, 2.0 ml and 13.0 ml
- Can be cooled down to -196 °C
- Sterilisable in an autoclave or dry heat at +200 °C
- Suitable for PCR applications
- Alternative to single-use plastic pestles
- Perfectly suitable for Eppendorf Safe-Lock Tubes

For volume ml	Pestle length mm	PK	Cat. No.
0.5	94	1	9.314 500
1.5	124	1	9.314 501
2.0	120	1	9.314 502
13.0	190	1	9.314 503



9.314 500



9.314 501



9.314 502



9.314 503

5 EPPI pestle, PP



schuett-biotec

For resuspending pellets and homogenising within tubes (1.5, 2.0ml, exact fit). Autoclavable. Suitable for homogeniser/motor drive.

Description	Material	Pestle length mm	Figure	PK	Cat. No.
EPPI pestle, 1.5 / 2.0 ml	stainless steel	100	1	1	9.197 690
EPPI pestle, 1.5 / 2.0 ml	PP	85	2	10	9.197 689
Quick change chuck for EPPI pistol	PP and stainless steel		3	1	9.197 691



Disposable Pellet pestles, PP, with reaction tube



DWK Life Sciences

Autoclavable polypropylene. Suitable for battery-operated drive motor (9.314 496). Pestle length 7cm. Supplied with reaction tube, except Cat. No. 9.314 492 and 9.314 493.



9.314 491

For volume ml	Description	Pestle length mm	PK	Cat. No.
0.5	with reaction tube	70	100	9.314 490
0.5	without reaction tube	70	100	9.314 492
0.5	with reaction tube, RNase, DNase and pyrogen free	70	100	9.314 498
1.5	with reaction tube	70	100	9.314 491
1.5	without reaction tube	70	100	9.314 493
1.5	with reaction tube, RNase, DNase and pyrogen free	70	100	9.314 499
1.5	without reaction tube, RNase, DNase and pyrogen free	70	100	7.620 842



1 Micro pestles, accessory drive motor

DWK Life Sciences

Description	PK	Cat. No.
Complete with two batteries	1	9.314 496
Spare pestle adapter	1	9.314 497



2 3 Tissue Grinders System

DWK Life Sciences

For safety grinding of any cells by minimal temperature rising. Closed System (CS) for minimizing the risk of personal contact with aerosols and sample overflow while grinding. Optimal contact of grinder and conical sample tube (15 or 50ml) to grind each cell in the best way. Each unit is gamma sterilized and comes with a fully assembled pestle, conical sample tube (PP), solid top cap (HDPE) and label.

Type CS1: Tip from glass-filled PP (30%/70%) for standard grinding
 Type CS2: Vitrified tip (cast silica) for harder grinding



Type	For volume ml	PK	Cat. No.
CS 1	15	10	9.651 050
CS 1	50	10	9.651 051
CS 2	15	10	9.651 052
CS 2	50	10	9.651 053



4 Homogenisers DUALL®, with glass pestle

DWK Life Sciences

With conical and cylindrical area for effective tissue for grinding and also for homogenising. Especially suitable for cellular tissue such as muscle, heart and lungs. The pestle is sufficiently stable to be motor driven. The space between the pestle and mortar is between 0.1mm to 0.15mm. Spare components are available and are completely interchangeable.

Capacity ml	Size	Pestle L x o.d. mm	Mortar L x o.d. mm	PK	Cat. No.
1	20	155 x 6	80 x 13	1	9.651 637
3	21	207 x 6	120 x 16	1	9.651 638
5	22	220 x 8	150 x 18	1	9.651 639
15	23	278 x 10	175 x 25	1	9.651 641
30	24	310 x 10	215 x 32	1	9.651 642
50	25	345 x 16	225 x 38	1	9.651 643



5 Homogenisers DUALL®, with PTFE pestle

DWK Life Sciences

With conical and cylindrical area for effective tissue for homogenising. The PTFE pestle is ideal for soft tissue such as brain or liver. The pestle is suitable for motor drive. The space between the pestle and mortar is between 0.1mm to 0.15mm. Spare components are available and are completely interchangeable.

Capacity ml	Size	Pestle L x o.d. mm	Mortar L x o.d. mm	PK	Cat. No.
1	20	155 x 4.5	80 x 13	1	9.651 656
3	21	210 x 6	120 x 16	1	9.651 657
5	22	228 x 6	150 x 18	1	9.651 658
15	23	268 x 6	175 x 25	1	9.651 659
30	24	305 x 10	215 x 32	1	9.651 660
50	25	330 x 10	225 x 38	1	9.651 661

1 Homogenisers Potter-Elvehjem, with glass pestle

All-glass. Pestle is suitable for motor drive. The space between the pestle and mortar is between 0.1mm to 0.15mm. Spare components are available and are completely interchangeable.

DWK Life Sciences

Capacity	Size	Pestle L x o.d.	Mortar L x o.d.	PK	Cat. No.
ml		mm	mm		
1	19	145 x 5	95 x 13	1	9.651 674
5	21	205 x 6	140 x 16	1	9.651 675
8	22	215 x 8	150 x 18	1	9.651 676
17	23	265 x 10	175 x 25	1	9.651 677
45	24	315 x 10	220 x 32	1	9.651 678

2 Homogenisers Potter-Elvehjem, with PTFE pestle

With PTFE pestle and glass mortar. Sizes 21 and 24 have notches on the bottom edge of the pestle so that particles can be transported up to the cylindrical part of the mortar for extraction. The space between the pestle and mortar is between 0.1mm to 0.15mm. Spare components are available and are completely interchangeable.

DWK Life Sciences

Capacity	Size	Pestle L x o.d.	Mortar L x o.d.	PK	Cat. No.
ml		mm	mm		
0.5	18	130 x 3	80 x 12	1	9.651 689
1	19	154 x 5	95 x 12	1	9.651 690
3	20	154 x 5	115 x 12	1	9.651 691
5	21	215 x 6	140 x 15	1	9.651 692
8	22	212 x 6	150 x 19	1	9.651 693
17	23	266 x 6	175 x 25	1	9.651 694
45	24	269 x 6	220 x 32	1	9.651 695

Shakers, Disruptor Genie® analog/digital

The patented Disruptor Genie® provides a multi-directional action, which simultaneously agitates and vortexes at high speed, dramatically increasing cell disruption or sample resuspension efficiency.

Scientific Industries

- Dramatically increased sample disruption efficiency. Ideal for difficult glass bead procedures (Glass beads - please order separately), cell disruption/homogenisation of yeast, bacteria, plant and animal tissues and pellet resuspensions or anything that requires extremely violent, high-speed agitation.
- Patented multi-directional action simultaneously agitates and vortexes at high-speed producing greater yields in less time
- Hands-Free disruption of up to twelve 1.5ml or 2.0ml microtubes with timer from 0 to 15 minutes (Disruptor Genie® analog), 0 to 99 minutes (Disruptor Genie® digital) or continuous operation
- Performance comparable to expensive ultrasonic cell disruptors/homogenisers.
- Suitable for use in cold rooms or incubators

Supplied with: Disruptor Genie, tube holder for 12 tubes, pop-off cup

Specifications

Speed	
Disruptor Genie® analog:	2850rpm
Disruptor Genie® digital:	1000 to 2850rpm
Dimensions (W x D x H):	122 x 165 x 190mm
Weight:	4.3kg
Supply requirements:	220V 50Hz, 250mA

Type	Connector	PK	Cat. No.
Disruptor Genie® analog	EU	1	9.730 115
Disruptor Genie® analog	CH	1	9.730 117
Disruptor Genie® digital	EU	1	6.253 276
Disruptor Genie® digital	CH	1	9.730 119

Further models can be found in our online shop.

Accessories for Disruptor Genie®

Description	PK	Cat. No.
Microtube Holder for 12 x 1.5 or 2.0ml tubes	1	6.253 281
0.1mm Disruptor Beads, 375g	1	9.730 100
0.5mm Disruptor Beads, 375g	1	9.730 101

1



2



3

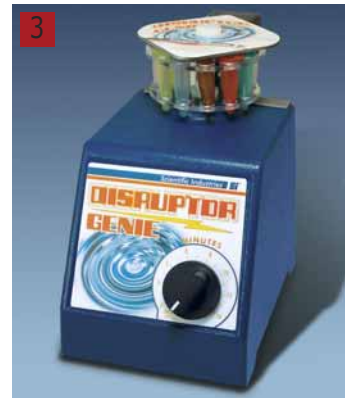

9.730 115

4



6.253 276

5



6.253 281



1 2 Microbiological monitoring of water: MBS I system and membranes

The MBS I filtration system is designed for laboratories that handle high numbers of samples for microbiological quality control. It consists of a membrane dispenser, a funnel dispenser, and a 2-place filter AS220 manifold. AS220 Filtration Manifold and Filtration funnels AS220 is a two-place stainless-steel filtration manifold, which can be joined together (maximum of 3 manifolds). This simple manifold can be used with 47mm or 50mm filtration membranes. *Whatman*

- Waste reduction - because PP funnels can be autoclaved up to 50 times
- Time saving - No need to flame in between filtrations
- Easy handling
- Cost saving - 20 PP funnels are enough for 1000 analyses
- Reduces cross-contamination

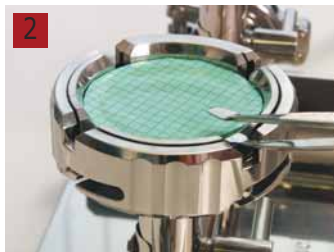

Description	PK	Cat. No.
2-place vacuum manifold AS 220	1	6.231 788
Automatic dispenser for funnels	1	6.231 860
Funnels 100 ml, PP, autoclavable	20	7.616 566
Funnels 350 ml, PP, autoclavable	20	6.801 571
Autoclaving bags	20	7.608 012
Membran-Butler manual	1	6.225 967
Steel frit with ring for AS220	1	6.801 981



3 Biosart®100 monitors

Filtration unit for use with a Sartorius vacuum manifold or direct attachment to a special vacuum pump. Biosart® 100 Monitors have been specifically designed for the microbiological testing of pharmaceuticals, food, beverages, water and other liquids. These sterile disposable units with built-in membrane filter and cellulose pad are ready to use. After filtration, just remove the 100ml funnel to convert the monitor into a petri dish. Culture media for wetting the pad are available in individually sterilised, convenient plastic ampoules. Biosart® 100 Monitors are ready to use filter units designed to fit onto the receivers of a vacuum manifold. For use with Biosart® 100 culture media. *Sartorius Lab Instruments*

Type	Diam. mm	Pore size µm	Colour Filter / Grid	PK	Cat. No.
K	47	0.45	white / black	48	9.049 300
K	47	0.45	grey / white	48	9.049 315
ACK	47	0.20	white / black	48	9.049 311
ACK	47	0.45	white / black	48	9.049 312
ACK	47	0.45	green / dark green	48	9.049 313
ACK	47	0.45	grey / white	48	9.049 304
Adapter for BioSart	55	-	-	1	9.049 320

ACK= individually sterile packed. K= sterile.



4 Filter funnel, Biosart®250

For microbiological and analytical quality assurance in industry. 250ml sterile plastic funnels reduce process time in colony and particle analysis. For use with Sartorius membrane filters and Sartorius cardboard culture plates. *Sartorius Lab Instruments*

Note: BioSart 250 funnels can also be adapted to fit single filter holders or filtration manifolds.

Type	PK	Cat. No.
BioSart 250 disposable funnel, sterile	50	9.049 340
BioSart 250 disposable funnel, sterile, individually packed	50	9.049 341



5 Membrane Filter Microsart® @filter units, CN

Microsart® @filter 100 filter units are a sterile and ready-to-use combination of funnel made of PP with 47 mm diameter, filter base and gridded membrane in one unit. They have been specifically developed for the detection and enumeration of microorganisms in pharmaceuticals, cosmetics, food, beverages, water and other liquids. The membrane filters can also be used in conjunction with Sartorius Stedim Biotech nutrient board discs. *Sartorius Lab Instruments*



Danger

H phrases: H228

Pore size µm	Colour Filter / Grid	PK	Cat. No.
0.20	white / black	60	6.258 123
0.45	white / black	60	7.657 646
0.45	white / black	24	6.280 425
0.45	grey / white	60	4.652 481

1 Plastic Funnels, Microsart®, PP

The sterile plastic funnels with 47 mm diameter allow quick performance of the filtrations required in the routine testing of water, food and beverages, pharmaceutical and cosmetic products. A Sartorius Stedim Biotech gridded membrane is placed on a stainless steel filter support and a Microsart® Funnel is simply and practically fitted on and the sample is filtered by vacuum. *Sartorius Lab Instruments*

- Click-Fit closure for optimum sealing
- Graduation with markings for exact volume dosing

Volume ml	PK	Cat. No.
100	100	7.659 614
250	96	7.671 690



2 Disposable Analytical Filters Nalgene™, sterile

Single-use filterware. Analytical filterware provides precise, easy-to-use systems for the recovery of microorganisms and particulates for QC testing and research. *Thermo Scientific*

- Disposable, easy-to-use, pre-assembled sterile filter units and funnels
- Easy-to-remove triton-free cellulose nitrate (CN) membranes
- 0.2 µm CN membrane is suitable for sterility testing
- 0.45 µm CN gridded membrane is certified for water quality testing



H phrases: H228

Type	Volume ml	Membrane diam. mm	Pore size µm	Grid	Colour	PK	Cat. No.
Filter funnel	150	47	0.45	black	white	1	9.046 077
Filter funnel	250	47	0.20	-	white	1	7.047 680
Filter funnel	250	47	0.45	black	white	1	7.047 681
Filter funnel	250	47	0.45	black	grey	50	6.273 013
Filter unit	150	47	0.20	-	white	1	9.046 081
Filter unit	150	47	0.45	black	white	1	9.046 082

3 Membrane filters Type 130, cellulose nitrate

Gray membrane (after wetting, black) with white grid, for detection of yeasts and molds, particle count and microscopy, individually, sterile packaged/non sterile. *Sartorius Lab Instruments*



H phrases: H228

Diam. mm	Pore size µm	Sterile	PK	Cat. No.
50	0.65	+	1000	7.017 078
47 for SMART Filter Dispenser	0.45	+	3	7.054 644
47	0.65	+	100	9.054 122
47	0.45	+	100	9.054 132
50	0.45	+	100	9.054 133
50	0.45	-	100	9.054 139

Other types available on request.

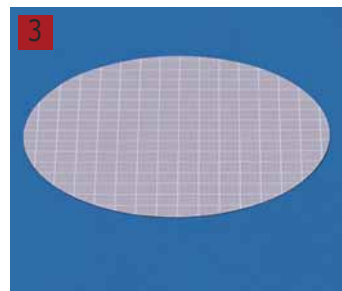

4 Membrane filters type 138, cellulose nitrate

Green membrane with dark-green grid, providing optimal contrast to light-colored or transparent bacteria colonies, individually, sterile packaged/non sterile. *Sartorius Lab Instruments*



H phrases: H228

Diam. mm	Pore size µm	Sterile	PK	Cat. No.
47	0.45	+	100	9.054 202
50	0.45	+	100	9.054 203

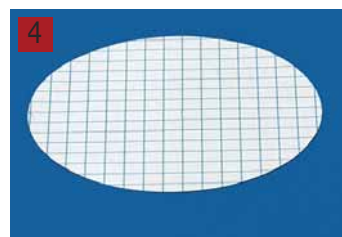



1 Haemocytometer cover glasses

Quality A, ground edges.

Menzel

Width mm	Length mm	Thickness mm	PK	Cat. No.
22	22	0.4	10	6.073 041
24	24	0.4	10	6.313 619
26	20	0.4	10	6.314 328

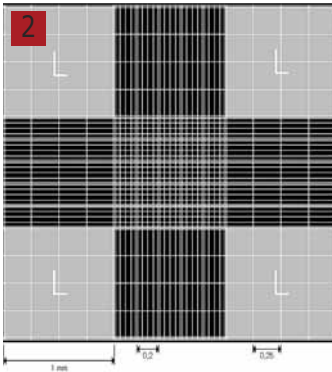

2 Counting chamber, Improved Neubauer, bright line

Bright line. With double ruling. Calibratable. Same counting grid as the Improved Neubauer cell, but with rhodium coated chamber base. Rulings are engraved into the Rhodium layer and appear bright under normal microscope settings. By altering the contrast it is possible to reverse the image under the microscope to make the rulings appear brighter or darker as required.

BRAND

Description	PK	Cat. No.
Without snap-on clips	1	7.020 271



3 Hand tally counter

Use for counting blood cells, bacterial colonies, drops of liquid, or any repetitive event. Tallies up to 9999. Features a quick-reset knob, lens window for easy reading, and finger ring for a secure grip. Sturdy, chrome-finished, metal housing. Dimensions: 46mm diameter x 41mm W.

Heathrow Scientific

Description	PK	Cat. No.
Hand tally counter	1	6.237 971



4 Tally counter, digital

Effective and practical counter with a sturdy, chrome finished housing. Ideal for counting blood cells, bacterial colonies, drops of liquid or any other repetitive step with a tally level up to 9999. TALLY COUNTER - "handy" Features a quick-reset knob, lens window for easy reading, and a finger ring for a secure grip.

ISOLAB

Description	PK	Cat. No.
Tally counter	1	6.267 411



5 Colony counter eCount™

Multi-function electronic counter with a Sharpie® pen for marking Petri dishes to prevent missing or double-counting colonies. Light, ergonomic body is balanced for easy manipulation. For easy counting of bacteria and mould fungus colonies. Counting control via membrane keys.

Heathrow Scientific

- Incl. thumb button which allows you to use the eCount as a digital tally counter
- Count up, then count down verification
- Display the total and keep in the memory up to 32 separate counts
- Disable the counter so you can write totals and notes
- Verify each count with either a bleep or LED Flash
- 5 years warranty (excludes battery)

Type	PK	Cat. No.
Colony counter eCount™ incl. Sharpie® pen black, fine-point and stand	1	9.521 783
Replacement pens Sharpie®, black fine-point	12	9.521 787
Replacement pens Sharpie® Set, black, lime, navy, orange, purple, sky blue, and turquoise, fine and extra fine point	8	7.656 684

1 Colony Counter SC6PLUS, manual

- Pressure sensitive counting
- Pressure can be adjusted
- Audible confirmation
- Choice of light or dark background
- Bright white energy saving LED lighting
- Average count facility
- With BioCote® antimicrobial protection
- Connectivity to printer or computer

Stuart



Scope of supply: Device with two Wolffhuegel graticules and dish centering adapters to facilitate use with 50 to 90 mm dishes.

Please order magnifiers and printers separately.

Specification

Digital display:	3 digit LED
Lighting:	White LED
Magnifier glass:	1.7x and 3x (option)
Counter:	0 to 999
Petri dishes:	diam. 50 to 90 mm
Dimensions (W x D x H):	310 x 300 x 140 mm
Weight:	1.5 kg
Power supply:	120-230 V, 50/60 Hz, 70 W
Warranty:	3 years

Type	PK	Cat. No.
SC6PLUS	1	9.645 280

Accessories for Colony Counter SC6+

Stuart

Description	PK	Cat. No.
Accessory printer with power supply	1	9.950 399
Magnifiers 1.7x	1	9.645 281
Magnifiers 3x	1	6.223 318
Wolffhuegel graticule/segmentation discs for colony counter	10	6.238 272
Centering adapter	2	6.242 195
Protective discs	5	6.241 644

2 Colony counter Scan® 100

Scan® 100 is a high-tech manual colony counter remarkable for its user-friendly functions and ergonomics. A LED lighting system with Dark Field technology gives an accurate and contrasted view of the colonies. The integrated USB port allows export of the results to guarantee traceability and to reduce time of counting and reporting. Touch screen, volume and light intensity are easily adjustable. For all petri dishes from 55mm up to 150mm. Adapted to any kind of pen. *interscience*

Magnifying lens with flexible arm - please order separately.



Type	PK	Cat. No.
Scan® 100	1	6.237 952
Magnifying lens flexible arm	1	7.920 048



1 schuett count Colony Counter

Designed for reliable and efficient counting of bacterial colonies and bacteriophage plaques growing on nutrient agar or nutrient discs/filter disks in Petri dishes. Provides ergonomic and relaxed working.

schuett-biotec

- For Petri dishes with Ø 90 mm (Ø 60 or 150 mm optional)
- Individually adjustable lighting, pressure sensitivity of the counter plate and volume
- LED lighting technology, absolutely glarefree and gentle on the eyes
- Three types of illumination: from below, from the side and incident light (optional)
- High colony transparency and differentiation (agar or nutrient discs/filter), even with transparent colonies
- No heating of the samples
- Natural colour reproduction
- Easy counting by marking the colonies (with any felt pen) on the petri dish
- Acoustic counter control (with volume control)
- 4-digit LED-display (0 - 9999), clearly arranged foil keypad
- Average count calculation, data transfer via USB to PC. Imported in Excel, for further processing, storage and printing

Scope of supply: For 90mm dia. Petri dishes: adapter (transparent) for illumination from below, adapter (black/white) for illumination from side, contrast disc (black), USB-cable, marker-pen with holder.

For enumeration of more than 50 Petri dishes per day, we recommend: schütt colonyQuant automatic colony counter (sample chamber, PC/laptop, software-license): The schuett colonyQuant is equipped with a high-resolution auto focus/auto-zoom color camera. Evaluation of Petri dishes with agar Petri film, filters or nutrient pads, spiral plating or Hemmhof analysis. Storage of counting methods, documentation of results.

Suitable for automatic counting and documentation of Petri dishes or nutrient pads, covered with smallest colonies (min. 0.05 mm diameter), mixed cultures. Connection to existing LIM system possible. Test evaluation of customer-specific plates in the customer's own laboratory possible before purchase.

Type	PK	Cat. No.
schuett count colony counter, 100-240 V	1	9.521 940

2 Accessories for schuett count Colony counter

schuett-biotec

Type	Figure	PK	Cat. No.
Magnifier 3 x (100mm dia.)		1	9.521 941
Magnifier 6-8 x (60mm dia.)		1	9.521 942
LED overhead lamp		1	9.521 943
Spiral-Plater Disc, black/white	A	1	9.521 946
Wolffhügel Disc, black/white	A	1	9.521 947
Counting needle	B	1	9.521 948
Adapter for Petri dishes, 50 to 60mm dia.	C	1	9.521 944
Adapter for Petri dishes, 140 to 150mm dia.	D	1	9.521 945

Adapter for other petri dishes sizes on request.

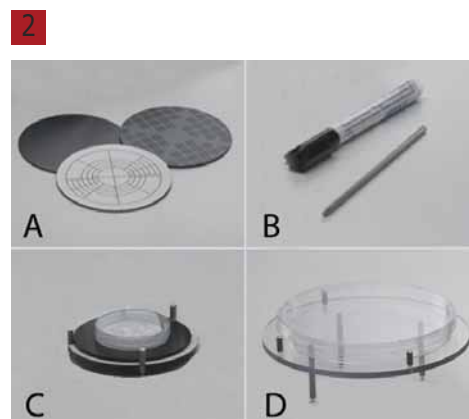

Automatic Colony counter Scan® 300, 500 and 1200

Scan® 300 is an automatic colony counter that includes the essential features for Petri dish counting. *interscience*
It is specifically adapted to the usual media in food microbiology (PCA, MRS...). With a CCD camera with 1 Megapixel - zoom x 28. It counts colonies on a Petri dish in less than half a second, with a minimum colony size of 0.1 mm. For the detection of colonies on round pour, surface, spiral and circle mode plated dishes Ø 55 - 90 mm.

Scan® 500 is a high-tech automatic colony counter. It counts colonies on a Petri dish in less than half a second and gives you quick, accurate, complete and traceable reading of the results. With its CCD camera and a powerful software, it connects to a PC via a Firewire connection automatically export results to Excel.

Scan® 1200 is a high resolution automatic colony counter that offer quick, and traceable counting results. Widely used in food microbiology, it counts colonies and automatically saves all data to Excel. Equipped with a digital camera and a powerful software, it connects to a PC via a Firewire connection. Scan® 1200 counts all colonies, even on smallest poured, spread and Spiral® Petri dishes; on PetriFilm™ and RIDA™ Count/Sanita-kun™, on filtration membrane and Compact Dry™.

1

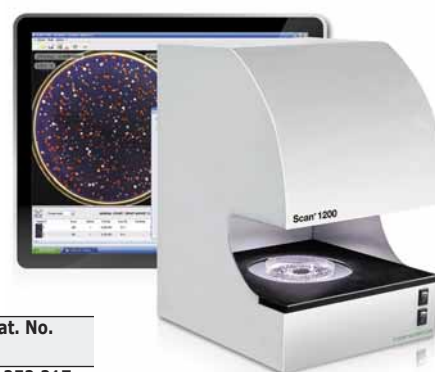

9.521 960

Type	PK	Cat. No.
Scan® 300	1	6.252 217
Scan® 500	1	6.237 357
Scan® 1200	1	9.521 960 1

2 Colony Counter Scan® 4000, automatic

2

Scan® 4000 is an ultra HD automatic colony counter and inhibition zone reader for high resolution *interscience*
color reading of colonies and inhibition zones. Adapted to all sizes of Petri dishes and all media, its lighting system guarantees a great user comfort, high accuracy and excellent reproducibility. Automatic lighting system with 6 combinations, top and/or bottom light, white or black background. Automatic counting and inhibition zone measurement with manual control

- All stainless steel body
- Counting: 1000 colonies per second
- Minimum size of colony: 0.05 mm
- Color detection: 7 colors on the same dish
- Long-life white LEDs/Dark Field
- Counting on e.g. Petri dishes 55 to 150 mm, PetriFilm™ and other plates
- Inhibition zone reading on 90 to 100 mm round dishes and 120 mm square dishes
- Maximum number of antibiotics: up to 16 antibiotics on a square 120 mm dish
- Reading time: measurement of 16 inhibition zones between 2 and 4 seconds maximum
- Automatic separation of confluent colonies
- Results: Scan® file, PDF report, jpeg, png, bmp, Excel™
- LIMS and USB connection
- Software available in English, French, Spanish, Japanese, Chinese, Russian



Specifications

Camera:	Color HD CCD camera and digital zoom x64
Camera Resolution:	5 mega-pixels
Lighting:	LED/Dark field
Min. colony size:	0.05 mm
Counter:	1000 colonies per second
Culture dishes:	55 to 150 mm, 90 to 100 mm round dishes, 120 mm square dishes
Dimensions (W x D x H):	470 x 470 x 640 mm
Weight:	24.4 kg
Power supply:	100-240 V, 50/60 Hz

Type	PK	Cat. No.
Colony Counter Scan® 4000	1	6.281 917

Microbiology/ATP detection-Hygiene monitoring

1



1 Luminometer Clean-Trace™ LM1

Simple, quick and reliable hand held diagnostic tool to verify cleaning effectiveness and capture, store and manage data for later analysis.

3M Deutschland

- Compact and easy-to-use
- Rapid results allow immediate corrective action
- To be used with the dry swabs 3M™ Clean-Trace™ UXL100, AQT200 and AQF100

Type	PK	Cat. No.
Clean-Trace™ LM1	1	4.665 172

2



2 Dry swabs for Luminometer 3M™ Clean-Trace™ NG3/LM1

3M Deutschland

H phrases: H412

Type	Description	PK	Cat. No.
Clean-Trace™ ATP UXL100	Dry swabs for surfaces	100	6.243 230
Clean-Trace™ Water AQF100	Dry swabs, free ATP	100	6.261 832
Clean-Trace™ Water Plus AQT200	Dry swabs, total ATP	100	6.261 831

3



3 Allergenic test

Optionally in a plastic or in 96 Wells/Kit

3M Deutschland

Lateral flow device in a plastic casset, 25 devices individually packed.
One foil bag with a plate of 96 removable antibody coated wells.

Description	PK	Cat. No.
L25WAL Walnut Rapid LFD, pack of 25 Tests	25	4.665 443
L25HZL Hazelnut Rapid LFD, pack of 25 Tests	25	4.665 444
L25PST Pistachio Rapid LFD, pack of 25 Tests	25	4.665 445
L25EGG Egg white Rapid LFD, pack of 25 Tests	25	4.665 446
L25GLU Gluten Rapid LFD, pack of 25 Tests	25	4.665 447
L25ALM Almond Rapid LFD, pack of 25 Tests	25	4.665 448
L25MLK Milk Rapid LFD, pack of 25 Tests	25	4.665 449
L25PNT Peanut Rapid LFD, pack of 25 Tests	25	4.665 450
L25SOY Soy Rapid LFD, pack of 25 Tests	25	4.665 451
L25COC Coconut Rapid LFD, pack of 25 Tests	25	4.665 452
L25FSH Fish Rapid LFD, pack of 25 Tests	25	4.665 453
L25CHW Cashew Rapid LFD, pack of 25 Tests	25	4.665 454
E96MOL Mollusk ELISA, 96 WELLS/KIT	1	4.665 455
E96CHW Cashew ELISA, 96 WELLS/KIT	1	4.665 456
E96ALM Almond ELISA, 96 WELLS/KIT	1	4.665 457
E96MLK Milk ELISA, 96 WELLS/KIT	1	4.665 458
E96BZL Brazil Nut ELISA, 96 WELLS/KIT	1	4.665 459
E96PEC Pecan ELISA, 96 WELLS/KIT	1	4.665 460
E96MUS Mustard ELISA, 96 WELLS/KIT	1	4.665 461
E96PNT Peanut ELISA, 96 WELLS/KIT	1	4.665 462
E96CAS Casein ELISA, 96 WELLS/KIT	1	4.665 463
E96CRU Crustacean ELISA, 96 WELLS/KIT	1	4.665 464
E96EGG Egg white ELISA, 96 WELLS/KIT	1	4.665 465
E96PST Pistachio ELISA, 96 WELLS/KIT	1	4.665 466
E96SES Sesame ELISA, 96 WELLS/KIT	1	4.665 467
E96SOY Soy ELISA, 96 WELLS/KIT	1	4.665 468
E96FSH Fish ELISA, 96 WELLS/KIT	1	4.665 469
E96HZL Hazelnut ELISA, 96 WELLS/KIT	1	4.665 470
E96MAC Macadamia KIT, 96 WELLS/KIT	1	4.665 471

LLG-Dry swabs, sterile

Description	Ext. diam. mm	Length mm	PK	Cat. No.
with Cotton tip, in PP test tube	12	150	1000	6.272 800
with Rayon tip and plastic stick, in PP test tube	12	150	1000	6.272 801
with Cotton tip and wooden stick, individually wrapped		150	1000	9.404 004
with Rayon tip and plastic stick, in PP test tube, individually wrapped	12	150	150	9.404 005
with Rayon tip and plastic stick, individually wrapped		150	1000	9.404 006
with clear Amies medium, Rayon tip and plastic stick, in PP test tube	12	150	150	9.404 007

1



9.404 005

2



9.404 006

3 Air sampler, Airport MD8 airborne bacteria sampler

AirPort MD8 is a new portable air bacteria sampler for the pharmaceutical and food and beverage industries, hospitals, environmental protection and for industrial safety.

Sartorius Lab Instruments

AirPort MD8 has the following benefits:

- Battery-powered and portable for lab or field use
- Battery status display guarantees constant performance during sampling
- Ergonomic, smooth design, surfaces can be disinfected
- Choice of sampling selection, either by total volume or measurement duration



Specifications:

Volume flow control:	Volume flow can be set to three levels using integral hydrometric manometer: 30 L/min., 40 L/min. and 50 L/min.
Fixed sample volumes:	25, 50, 100, 250, 500, 750 and 1000 litres Sample volume can also be adjusted in 5 litre increments
Battery:	NiMH 16.8 Volt/3800 mAh
Running time with a full battery charge:	approx. 4.5 hours
Charging time:	approx. 4.5 hours if battery flat
Noise level:	Using gelatin membrane filters, 48 dB(A)
Weight:	2.5 kg
Dimensions (L x W x H):	300 x 135 x 165 mm
Filter size:	80 mm dia., area 38.5 cm ²

Type	PK	Cat. No.
AirPort MD8	1	9.841 605

4 Disposable gelatin units for air sampler Airport MD8

Gelatine filter disposable units are individually sterile packed, ready-to-connect units consisting of gelatine filter and holder.

Sartorius Lab Instruments

Specifications:

Filter size:	80 mm dia., area 38.5 cm ²
Pore size:	3 µm
Reaction in water:	soluble
Flow capacity (air):	per cm ² : 2.7 l/min. at ΔP 0.05 bar
Environment:	Temperature max. 30°C, humidity max. 85%
Retention:	1. Bac subtilis niger 99.9995% retention at 0.25 m/s flow rate 2. Coli Phages T3 99.94 % retention at 80% rel. humidity and 0.3 m/s flow rate
Sterilization:	sterilisable with gamma radiation



Description	PK	Cat. No.
Gelatin membrane filter, individual pack	10	9.841 615
Gelatin membrane filter, three-pack	10	9.841 616
Adapter	1	9.841 617



1 LLG-Histology cassettes with detachable lid

For routine tissue and biopsy processing and embedding.
 Made of Polyoxymethylene (POM). 100 % resistant to the chemical action of histological solvents.
 With detachable lid (unassembled). Special design for easy frequent opening and closing, as well as easy and safe lid removal/insertion without any danger of specimen loss.
 With two large labeling areas on the cassette sides and a standard 45 °C front writing area adaptable to most cassette labelers.
 Fine square pores (0.9 x 0.9 mm) for an optimal fluid exchange and proper drainage.

Colour	Width mm	Depth mm	Height mm	PK	Cat. No.
blue	28	40	7	500	9.160 841
green	28	40	7	500	9.160 842
pink	28	40	7	500	9.160 843
white	28	40	7	500	9.160 844
yellow	28	40	7	500	9.160 845



2 3 Histology cassettes, POM

Tissue embedding cassettes for paraffin inclusions. With clip-on lid that breaks when closing, which allows an easy removal.

Kartell

Colour	Dimensions (W x D x H) mm	PK	Cat. No.
white	28 x 40 x 6.8	500	6.207 173
blue	28 x 40 x 6.8	500	6.280 220
yellow	28 x 40 x 6.8	500	6.284 765
red	28 x 40 x 6.8	500	6.284 766
green	28 x 40 x 6.8	500	6.284 767
pink	28 x 40 x 6.8	500	6.226 853
white	28 x 40 x 13.6	100	7.910 449
blue	28 x 40 x 13.6	100	6.284 771
yellow	28 x 40 x 13.6	100	6.269 288
green	28 x 40 x 13.6	100	6.284 772
pink	28 x 40 x 13.6	100	6.284 773



4 Sponge for Histology cassettes

Synthetic sponge with a calibrated porosity that can easily be inserted into the tissue embedding cassettes. Very useful for small specimens in biopsy tests.

Kartell

Colour	Dimensions (W x D x H) mm	PK	Cat. No.
Blue	32 x 26 x 2.5	500	6.284 768



5 Embedding rings

Suitable for the processing and histological inclusion of pieces in paraffin.
 Ideal for the storage and the identification of tissue samples.
 Dimensions (W x D x H): 28 x 40 x 11 mm.

Kartell

Colour	PK	Cat. No.
White	500	6.284 760
Blue	500	6.284 761
Yellow	500	6.284 762
Green	500	6.284 763
Pink	500	6.284 764



6 Metal trays for Histology

Made of stainless steel for easy removal of paraffin inclusions: they allow a precise location of the specimen into the paraffin.

Kartell

External dimensions (W x D x H) mm	PK	Cat. No.
52 x 35 x 11.6	10	6.285 347
52 x 35 x 11	10	6.285 348

1 Drawer boxes Styrokay

White modular drawer box with 6 drawers for histology cassettes, documents and small laboratory utensils.

styro GmbH

- Including inscription labels
- 49 histology cassettes per drawer
- 294 histology cassettes per box

Type	Internal dimensions (W x D x H) mm	External dimensions (W x D x H) mm	PK	Cat. No.
Drawer cabinet with 6 drawers without insert	230 x 318 x 45	270 x 345 x 340	1	4.662 136
Drawer cabinet with 6 drawers with insert	230 x 318 x 45	270 x 345 x 340	1	4.662 137

Suitable accessories can be found in our online shop.



Rotary Microtomes RAZOR/RAZOR-e

Rotary Microtoms with disposable blades for paraffin sections for routine and research. Micro and coarse advance movements in enclosed housing. Coarse advance left side. Optimum specimen guidance by maintenance-free cross roller guides. Safety lock on hand wheel. Section thickness adjustment from 0.5 µm to 60 µm in defined steps. Precise guide way and clamping device for knifeholder with optimum sliding capability and prism guide.

Micros Austria

Manual Rotary Microtome RAZOR:

The rotation of the hand wheel is light and smooth and ensures an ergonomic handling of the instrument, which greatly reduces the operators intensity in the sectioning job. The hand wheel locking is conveniently integrated in the wheel and is designed for one thumb use. The compact ergonomical design offers space for using different application tools.

Fully automatic Rotary Microtome RAZOR-e

Offers great user benefit and gives superior comfort to the operator. The perfectly ergonomic arrangements of the control elements enable an effortless handling of the microtome. Automatic trimming in 3 steps: 1:10 µm, 2:20 µm, 3:30 µm. The powerful cutting motor drive with safety function ensures high section stability and precision. Hand wheel lock conveniently integrated locking lever on the hand wheel. Emergency shut down button. With the emergency shut down button the slicing process can be stopped immediately.

Scope of supply: Microtome Base with Knife Holder Base, Disposable Blade Holder Basic, Changeable clamping plate, Adapter Piece (fixed), Universal Cassette Clamp, Wooden Transport Box, 50 Microtome Blades MS100

The microtome blades MS200 (article no.: 6.270 924) and other suitable blades are available as accessories.

Specifications

Vertical stroke:	70 mm
Horizontal stroke:	40 mm
Section thickness:	0.5 to 60 µm
Section thickness setting:	0.5 to 2 µm, 0.5 µm increments 2 to 10 µm, 1 µm increments 10 to 20 µm, 2 µm increments 20 to 60 µm, 5 µm increment
Coarse advance:	manually by hand wheel left side
Object orientation:	X- and Y-axes 8°, Z-axes 360°
Object retraction:	on upward movement 80 µm
RAZOR-e only:	
Trimming function:	1:10 µm, 2:20 µm, 3:30 µm
Cutting Count:	integrated, LCD-display

Type	Dimensions (W x D x H) mm	Weight kg	PK	Cat. No.
Rotary Microtome RAZOR, manual	460 x 460 x 280	36	1	6.270 919
Rotary Microtome RAZOR-e, fully automatic	460 x 550 x 280	45	1	6.270 920



6.270 919



6.270 920

Accessories for Rotary Microtomes RAZOR

Micros Austria

Description	PK	Cat. No.
Microtome knife type C, stainless steel 16 cm	1	6.270 921
Knife, tungsten carbide, 16 cm	1	6.270 923
Knife box, plastic for s knife 10 to 16 cm	1	6.270 922
Blade holder adapter for knife holder, Low Profile	1	6.270 932
Blade holder adapter for knife holder, High Profile	1	6.270 933

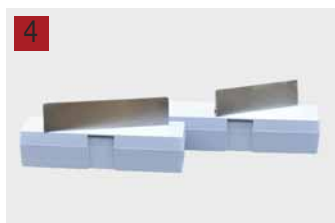

6.270 921

1

6.270 924

Blades for Microtoms, stainless steel

MS200: Universal blade with plasma coating for daily routine, suitable for all types of tissue. Especially suitable for ribbon sectioning, excellent sharpness, even with very thin cuts.

Micros Austria

Allrounder with unique hardened blade cutting edge, excellent durability.

MS300: Very sharp blade with plasma coating, especially recommended for cutting bone tissue. Also perfect for all other tissue types as well as for ribbon sectioning.

MS100: For daily routine like ribbon and thin sectioning. Excellent sharpness and durability. All-purpose, even for difficult tissue. High-quality stainless steel, extra hard teflon coated.

MS33: Blade for applications where extremely thin, high-quality sections are required. Suitable also for skin biopsy. Short trimming time and increased durability.

MS24: For hard tissue, but also for soft tissue and biopsies. Excellent long life and sharpness, very suitable for ribbon sectioning.

HP (High Profile Plasma): Excellent references for cryostat and ribbon sectioning.

Special hardened blade with plasma coating, short trimming time, excellent durability.

2

6.310 681

Type	Description	Width	Length	Thickness	Angle	PK	Cat. No.
		mm	mm	mm			
MS200	Low Profile	8	80	0.25	35	50	6.270 924
MS300	Low Profile	8	80	0.25	35	50	6.310 681
MS100	Low Profile	8	80	0.25	35	50	6.270 928
MS33	Low Profile	8	80	0.25	30	50	6.270 926
MS24	Low Profile	8	80	0.25	35	50	6.270 927
HP	High Profile Plasma	14	80	0.32	35	50	4.670 750

3

6.270 930

Trimming Knives

For cutting tissue samples without causing deformation for large tissue blocks.

Micros Austria

Type	Angle	Width	Length	Thickness	PK	Cat. No.
		mm	mm	mm		
MM 130	22	18	130	0.25	50	6.270 930
MM 130TEST	22	18	130	0.25	5	6.270 948
MM 260	22	18	260	0.25	50	6.270 931
MM 260TEST	22	18	260	0.25	5	6.290 364

4

Handles for Trimming Knives

Micros Austria

Description	PK	Cat. No.
Handle for Trimming Knife 260 mm	1	4.665 355
Handle for Trimming Knife 130 mm	1	6.310 432

5

5 Tissue Vial CryoELITE®, sterile

The CryoELITE® Tissue Vials are specifically designed for tissue collection, transport and storage. *DWK Life Sciences*

Different from cells and biofluids, tissue specimens have particular requirements for cryogenic storage. Offering researchers a uniform vial able to maintain sample integrity while maximizing storage capacity and organization, the CryoELITE Tissue Vials feature a wide-mouth opening, 5mL capacity and high integrity closure. The CryoELITE Tissue Vial offers researchers who work with tissue samples ease of use, convenience and security. The CryoELITE® Tissue Vials are manufactured from low binding, cryogenicgrade virgin polypropylene that meets the USP Class VI classification. Lot tested and certified to be free of pyrogens, RNase/DNase and endotoxins, the vials have a sample capacity of 5mL and a storage temperature range of -156°C to 121°C. The externally threaded cap provides a seal that exceeds DOT and IATA classifications for diagnostic specimens and their transport and is capable of maintaining a secure closure during freeze/thaw procedures. The vials have a flat bottom and a stippled external surface to promote easier handling.

- Lot certified RNase/DNase and Endotoxin Free providing assurance of product integrity
- Cap seal exceeds DOT and IATA regulations ensuring ultimate protection of samples during transportation and demanding freeze-thaw handling
- Wide mouth for insertion and removal of tissue with forceps
- 5 ml volume for use with tissue sections
- Directional indicators to allow orientation of tissue within the vial

Description	PK	Cat. No.
Tissue Vial CryoELITE®, 5 ml, sterile	250	4.658 776

1 Scalpels, disposable Cutfix®

Sterile. For cleaner, smoother, more accurate incisions.

B. Braun Deutschland

- Excellent cutting ability of stainless steel blade
- Ergonomic solid plastic handle
- Ready for use
- Complete range of blades for every incision
- Individually packed precision knife with cap
- Total length about 150 mm depending on the blade shape and length

Type	PK	Cat. No.
10	10	9.409 804
11	10	9.409 805
12	10	9.409 806
15	10	9.409 807
20	10	9.409 808
21	10	9.409 809
22	10	9.409 810
23	10	9.409 813
24	10	9.409 814



Scalpel handles, stainless steel

For interchangeable, disposable blades using the BAYHA interlocking system. Blades insert into the side of the handle. Scalpel handle (Cat. No. 9.409 846) and protective sheath (Cat. No. 9.409 850) not suitable for sterile processing.

Bayha

Type	Length mm	PK	Cat. No.
Scalpel handle	130	1	9.409 841
Scalpel handle	130	1	6.237 129
Scalpel handle	200	1	6.510 723
Scalpel handle	160	1	9.409 844
Scalpel with hollow handle	150	1	9.409 845
Scalpel handle with plastic grip	160	1	9.409 846
Protective sheath		1	9.409 850

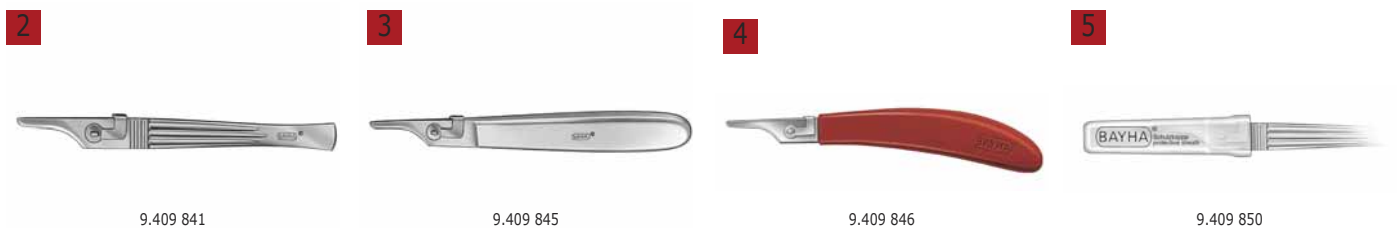

6 Scalpel blades, non-sterile

For scalpel handles using the BAYHA interlocking system. Sterile scalpel blades are available on request, except type S01 and 18R.

Bayha

Type	PK	Cat. No.
11	12	9.409 911
12	12	6.253 719
15	12	9.409 915
16	12	9.409 916
18	12	9.409 918
19	12	9.409 919
20	12	9.409 920
21	12	9.409 921
22	12	9.409 922
23	12	9.409 923
24	12	9.409 924
26	12	9.409 926
27	12	9.409 927
28	12	9.409 928
29	12	9.409 929
18R*	12	6.268 399
S01*	12	9.409 930



*Special scalpel blade acute

Further models can be found in our online shop.

Histology/Scalpels-Dissecting sets

1



1 Dissecting needles

Wironit. CrNi 18/12. Length 50mm.

Hammacher

Description	PK	Cat. No.
Lancet-shaped	1	9.160 040
Straight, sharp	1	9.160 030
Curved, sharp	1	9.160 035
Semi-lancet	10	9.160 036
Spatula	10	9.160 037

2



2 Dissecting needles

With plastic or metal handle.
Length 140mm.

Hammacher

Type	Description	PK	Cat. No.
Plastic	Pointed, straight	1	9.160 070
Plastic	Pointed, curved	1	9.160 072
Plastic	Lancet shaped	1	9.160 075
Metal	Pointed, straight	1	9.160 090
Metal	Pointed, curved	1	9.160 092
Metal	Lancet shaped	1	9.160 095

3



9.160 020

Dissecting needle holder

Wironit CrNi 18/12. For specimen loops and dissecting needles up to max. diam. 1.0mm.

Hammacher

Type	Length mm	PK	Cat. No.
Wironit shaft with plastic handle	240	1	9.160 020
Aluminium shaft with plastic handle	240	1	9.160 022
Wironit shaft with aluminium handle	170	1	9.160 025

4



4 Blood lancets Solofix®, sterile

For single use. Sharp, flexible lancet made of V2A supra steel.
Optimal insertion depth 3.8mm.

B. Braun Deutschland

Type	PK	Cat. No.
Solofix® 200	200	9.409 820
Solofix® 500	500	6.309 148

➔ Disposal Container please see page 261.

5



5 Dissecting Set, 8 pieces, stainless steel

- 1 Scissors, sharp
- 1 Forceps, blunt
- 1 Scalpel with blade 35 mm
- 1 Scalpel with blade 45 mm
- 1 Dressing scissors
- 1 Forceps, sharp
- 1 Dissecting needle
- 1 Lancet

Bochem

Description	PK	Cat. No.
Dissecting set, 8 pieces	1	6.800 729

1 Dissecting set for students

Comprises:
 1 x scalpel handle No. 3
 5 x sterile, disposable scalpel blades for above
 1 pair of preparation scissors
 1 pair of fine, sharp forceps
 1 x lancet needle
 1 x dissection needle

Hammacher

Type	PK	Cat. No.
HSO 130-00	1	9.160 200



➔ More cutlery please see our webshop.

2 3 Paraffin Section Flotation Bath, MH8517

The Paraffin Section Flotation Bath is designed to assist with the handling of paraffin wax samples in histology and pathology laboratories. It is essentially a hot distilled water floating bath that allows for the meticulous manipulation and location of sections onto glass slides. This Apparatus achieves a stable 45 °C using 2.25 litres of water within 40 minutes. The stability and accuracy have been improved due to the change of control which now also allows the user to set the temperature as opposed to the arbitrary power, thereby reducing the risk of overheating sections. It has a PTFE black interior and powder-coated aluminium exterior, which makes it virtually maintenance-free, extremely easy to clean and allows for improved visibility of floating sections. The lid is not included and can be ordered separately.

Electrothermal

Capacity: 2.5 l
 Temperature: 30 to 70 °C
 Temperature Stability: ±0.5 °C
 Bath material: Aluminium base with PTFE coated interior
 Dimensions (D x W x H): 330 x 330 x 140 mm
 Weight: 2.7 kg
 Heater Power: 240 W

Type	PK	Cat. No.
MH8517	1	6.268 889
Lid for MH8517	1	6.289 180



4 Paraffin Wax Dispenser MH8524

The Paraffin Wax Dispenser delivers quickly and conveniently on-demand molten wax, e.g. for histological applications. It is designed for melting up to 6 kg of pelletised wax at a time, and has a large 7.5 l capacity tank.

Electrothermal

- Anti-microbial coating (Ag+) to inhibit growth of bacteria
- Safety features include over-temperature cut-out at 120 °C
- Heated tap and inner filter screen (0.5 mm mesh) to prevent blockages
- Non-drip lever tap
- Small footprint

Specifications

Capacity: 7.5 l
 Temperature: Ambient ... 70 °C
 Display: Digital
 Resolution/Accuracy: 1 °C/±1 °C
 Material: Stainless steel
 Heater Power: 480 W
 Dimensions (W x D x H): 181 x 500 x 455 mm
 Weight: 7 kg
 Power supply: 220-240 V, 50/60 Hz

Type	PK	Cat. No.
MH8524	1	6.291 401



1



1 Microscope slide drying bench, MH 6616

Slide Drying Bench aids in the preparation of microscope slides at the specimen mounting stage. *Electrothermal*
It complements both the Paraffin Wax Dispenser and the Paraffin Section Flotation Bath to provide a complete set of paraffin wax sampling equipment for the modern laboratory. Accepting up to 50 slides (26 x 76mm), it has the facility for drying slides in different orientations- across the drying support bars, angled from the bars, or flat without the bars.

- Up to 50 slides capacity
 - Slides can be arranged on the bench in different orientations
 - Built-in energy regulator controlling temperature up to 100 °C
- Material: Base and top powder-coated aluminium
 Max Element Temperature: 100 °C
 Dimensions (D x W x H): 180 x 390 x 95 mm
 Weight: 1.8 kg
 Electric Requirement: 230 V, 50/60Hz, 150 W

Type	PK	Cat. No.
Microscope slide drying bench, MH 6616	1	9.770 106
Spare heating element	1	9.770 108

2



2 PARAPLAST® Tissue-embedding wax

Granules for embedding tissue. PARAPLAST PLUS® additionally contains dimethyl sulphoxide (DMSO) which improves speed and penetration into tissue samples. Melting point: 55 - 57 °C.

Type	Capacity kg	PK	Cat. No.
PARAPLAST®	1	1	9.170 015
PARAPLAST®	5	1	6.255 599
PARAPLAST PLUS®	1	1	9.170 020

3



3 EUKITT® Mounting medium

EUKITT® mounting media are characterized by fast curing, crystal-clear optics, low fluorescence, *ORSAtec GmbH*
ideal refractive index, good fluidity and low shrinkage. The preparations are stable over many years without cracking and discoloration. EUKITT® mounting media are colorless and do not change shape, structure or color of the material to be examined. No self-fluorescence under UV light! Delivered in wide neck, unbreakable aluminium bottles.

EUKITT®: Gold-standard mounting medium. Particularly preferred for use in coverslippers. EUKITT® resists heat, cold (-17 °C), humidity, daylight and UV light and preserves the original preparations for an unlimited period. Drying time: 20 minutes.

EUKITT® neo Spezial: Fast drying, xylene free mounting medium. Can be directly applied on EtOH or *i*-PrOH. Washing with xylene can be omitted. Modern formulation approach using a sustainable, renewable raw material as a solvent. Pleasant odour. Drying time: 15 minutes.

EUKITT® UV R: Curing with a single click. Mounting medium which is very quickly cured by UV-light. Only 50% of the amount of standard mounting media are needed. EUKITT® UV R can be directly applied on EtOH or *i*-PrOH and does not present any health risks. Suitable for all tissue types. Curing time: 10 to 30 seconds.



Warning

H phrases: H226|H312|H315|H319|H335|H373

Type	Capacity ml	Refractive index n (20 °C)	Viscosity range mPas	Min. shelf life	PK	Cat. No.
EUKITT®	100	1.49	250 ... 450	3 years	1	6.272 068
EUKITT®	500	1.49	250 ... 450	3 years	1	6.272 069

You can find ordering information for all articles described above as well as other articles online.

1 Histofluid mounting medium

1

Histofluid is a water-clear adhesive of acrylic resins dissolved in xylene. It hardens fast and due to its optical properties suits perfectly well for embedding microscopic preparations. Shortly after having covered a preparation it can already be examined and filed. Histofluid may also be used to firmly lock and seal bottle caps.

Marienfeld



- long storing or temperature changes do not cause fissures or deformations in Histofluid layers
- does not turn yellowish when being exposed to UV-radiation
- does not fluoresce
- does not form bubbles
- even sensitive colorations are preserved due to its acid number = 0
- refractive index of 1.5 (nD 20 °C) is adjusted to the microscope slide and cover glass
- water-repellent and dissolves in, for example, xylene, acetone, chloroform, dioxan and toluol
- can be stored in sealed bottles for an unlimited period
- filled into special bottles designed for hazardous materials and bearing the UN code

Due to its solvent contents Histofluid is flammable and, therefore, considered as hazardous. So it has to be specially packed and shipped according to the international transport regulations. Before ordering please carefully check your country's import regulations and ensure a smooth transport according to the IMO (International Maritime Organization). Any cost that might arise additionally for documents, reloading, returns etc. will be at your expense.



Warning

H phrases: H226|H312+H332|H315|H319|H335|H373|EUH208

Description	Capacity ml	PK	Cat. No.
Histofluid mounting medium	500	1	9.160 899

2 Histological staining solutions

Stains are delivered in 1000 ml bottles. Each bottle is sufficient for 1500 up to 2500 specimens. They can be used for clinical diagnostics.

ORSAtec GmbH

Harris' hematoxylin solution (Papanicolaou's solution 1a): The cytological staining technique developed by Papanicolaou is still the standard method in cancer and hormone cycle diagnosis. By using the classical Harris' hematoxylin solution (Papanicolaou's solution 1a), excellent nuclear staining can be achieved in 3 to 5 minutes. Nuclei are stained blue, dark violet to black. Density (20 °C): 1.04 g/cm³. pH value (20 °C): 2.3 to 2.8. C.I. 75290: 5.3 g/l. Al₂(SO₄)₃ x 18 H₂O: 67 g/l

Mayer's hemalum solution: This solution does not need to be filtrated prior use and the dye is oxidized in a controlled manner, which renders the results robust and allows a brilliant differentiation of the stained structures. Nuclei are intensive blue, cytoplasm is grey-blue. Density (20 °C): 1.05 g/cm³. pH value (20 °C): 1.8 to 2.2. C.I. 75290: 4.4 g/l. Al₂(SO₄)₃ x 18 H₂O: 28 g/l. C₆H₆O₇ x H₂O: 0.5 g/l

0.2% EOSIN Y solution alcoholic: A ready-to-use solution that can be used for routine staining in the hematoxylin-eosin staining process (H&E) of sample material of human origin. Due to the hematoxylin solution, the nuclei will appear blue to dark violet in color and the Eosin Y solution will stain the cytoplasm and intercellular substances red-orange.



Warning

H phrases: H226

Type	PK	Cat. No.
EOSIN (0.2% alcoholic), 1 Liter	1	6.272 067

You can find ordering information for all articles described above as well as other articles online.





1 LLG-Microcentrifuge tubes, PP



LLG Microtubes cover standard volumes for a variety of sample tests. They are available in 0.5ml, 1.5ml and 2.0ml volumes. These standard Microtubes withstand high centrifugal forces, are temperature and chemically-resistant and guaranteed leak-free. An innovative and modern new generation of Microtubes with new features. Perfect sealing qualities, excellent chemical stability and optimal construction materials guarantee even better resistance to centrifugal and chemical forces. Easy to open and to close thanks to the improved lid geometry. For visual volume control the 1.5ml tubes are equipped with graduations at 0.5ml, 1.0ml and 1.5ml. The 2.0ml tubes have graduations at 0.5ml, 1.0ml, 1.5ml and 2.0ml. The 0.5ml tubes have no graduations. Certified DNase-, RNase- and pyrogen-free.

Clear, in bags. Suitable for microbiology. Guaranteed metal-free.

Specifications

Autoclavability

Temperature: 121 °C
 Pressure: 1.05 bar or 15 psi
 Time: 20 min or less

Centrifugation

Fixed angle rotor: 25000 x g
 Swing out rotor: 70000 x g

Form	Volume ml	Max. rcf	PK	Cat. No.
conical	0.5	20000	1000	9.409 023
conical	1.5	25000	1000	9.409 024
round	2.0	25000	1000	9.409 025

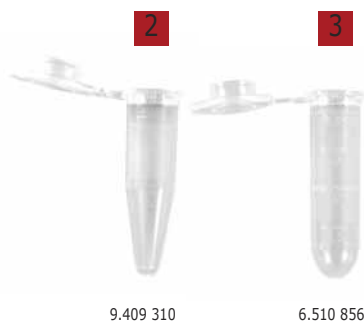

2 Reaction tubes, PP



Ratiolab

Translucent polypropylene (PP), natural colour

- tight sealing cap
- safe and easy to be opened and closed

Capacity ml	Max. rcf x g	PK	Cat. No.
0.5	18000	1000	6.085 184
1.5	10000	1000	9.409 310
2.0	25000	1000	6.510 856



4 Reaction tubes, with attached lid



BRAND

PP. High clarity. Frosted marking area and approximate graduations. Tight fitting attached lid provides leak-free seal, yet reopens easily. Uniform lid-thickness ensures trouble-free piercing. Can be centrifuged up to 20000 xg rcf. at 20°C for max. 20min. Autoclavable at 121°C (2bar), acc. DIN EN 285.

*BIO-CERT® products are sterile, free of endotoxins, DNA, RNase and ATP.



Capacity ml	Colour	Diam. mm	Height mm	Lid	PK	Cat. No.
1,5	clear	10.75	40.80	+	500	9.409 301
1,5*	clear	10.75	40.80	+	450	7.200 414
2,0	clear	10.70	41.15	+	500	9.409 303

1 Microcentrifuge tubes, PP, with lid closure



BRAND

These new 0.5, 1.5 and 2.0ml microcentrifuge tubes are available with an additional lid closure to achieve especially effective sealing and prevent accidental opening.

- Autoclavable at 121 °C (2 bar), acc. to DIN EN 285
- Centrifugeable up to 20000xg
- Free of RNase, DNase, DNA and endotoxins
- Produced under cleanroom conditions, ISO 14 644-1, Class 8
- Made from high-quality medical-grade polypropylene
- Subdivisions for reading the approximate volume
- Frosted labelling surfaces on the lid and tube

Capacity ml	Diam. mm	Height mm	PK	Cat. No.
0.5	10.00	30.0	500	6.266 733
1.5	10.75	40.8	1000	6.257 318
2.0	12.80	40.0	500	6.266 734



Micro tubes with screw caps

Screw cap micro tubes are ideal for storage of serums and blood samples, and for boiling, centrifugation, etc. BRAND

Quality features:

- Available in different formats, designs and quality grades.
- Micro tubes of PP and screw caps of PE or PP are precisely matched to ensure a secure seal. Available screw caps: screw cap with sealing cone, screw cap with silicone seal or tamper-evident screw cap with silicone seal.
- Cap inserts for coding, available in a variety of colors.
- Fast opening and closing with 1¼ turn of cap.
- Micro tubes with ring stands (self-standing) can be placed in suitable racks without the use of both hands.
- Micro tubes without ring stand (round bottom) withstands RCF up to 17 000 g at 20 °C, for 20 min.
- Dimensions: outer Ø 11 mm, height 47 mm.

2 Micro tubes, PP, with attached screw cap, PE, with sealing cone

PP, ungraduated, screw cap PE. Operating range: -90 °C to +100 °C. Available separately: colored cap inserts (PP) for identification. BRAND

Description	Capacity ml	PK	Cat. No.
self-standing	0.5	1000	6.701 485
self-standing	1.5	1000	7.079 677
round-bottom	1.5	1000	7.300 156
self-standing	2.0	1000	7.300 197
round-bottom	2.0	1000	7.510 076



3 Micro tubes, PP, with attached screw cap, PP, with silicone seal



BRAND

PP, graduated, screw cap PP. Frosted marking area. Operating range: -196 °C to +121 °C. Autoclavable at 121 °C (2 bar), acc. DIN EN 285. Available separately: colored cap inserts (PP) for identification.

Description	Volume ml	Grad. ml	External dimensions (Ø x H) mm	Max. rcf	PK	Cat. No.
self-standing	0.5*		13 x 44	17000	1000	6.802 474
self-standing	1.5	1.0	13 x 44	17000	1000	7.070 048
round-bottom	1.5	1.0	13 x 44	20000	1000	7.076 849
self-standing	2.0	1.2	13 x 44	17000	1000	7.300 124
round-bottom	2.0	1.2	13 x 44	20000	1000	7.300 580



*non-graduated

General Consumables/Micro Tubes

1

2

1 2 Microtubes, PP, detached screw-cap, PP

BRAND



- Graduated
- Sterile (SAL 10⁶)
- With frosted marking area
- Operating range: -196 °C to +121 °C
- Autoclavable at 121°C (2 bar), acc. to DIN EN 285
- Sterile
- DNA, DNase, and RNase-free
- Endotoxin-free, non-mutagenic, non-toxic

Volume ml	With	Description	External dimensions (Ø x H) mm	Max. rcf	PK	Cat. No.
0.5*	self-standing	With silicone seal	13 x 44	17000	500	6.401 078
1.5	self-standing	With silicone seal	13 x 44	17000	500	4.000 236
1.5	round-bottom	With silicone seal	13 x 44	20000	500	7.300 006
2.0	self-standing	With silicone seal	13 x 44	17000	500	7.602 492
2.0	round-bottom	With silicone seal	13 x 44	20000	500	7.612 290
0.5*	self-standing	With tamper-evident screw cap, with silicone seal	13 x 44	17000	500	9.284 164
1.5	self-standing	With tamper-evident screw cap, with silicone seal	13 x 44	17000	500	6.251 643
1.5	round bottom	With tamper-evident screw cap, with silicone seal	13 x 44	20000	500	6.251 644
2.0	self-standing	With tamper-evident screw cap, with silicone seal	13 x 44	17000	500	9.284 165
2.0	round bottom	With tamper-evident screw cap, with silicone seal	13 x 44	20000	500	9.284 166

*non-graduated

3

4

3 4 Micro tubes, PP, without screw cap

BRAND



- Non-sterile
- Operating range: -196 °C to +121 °C
- Autoclavable at 121 °C (2 bar), acc. DIN EN 285
- Coloured screw caps and cap inserts available as accessories

Volume ml	With	Description	Max. rcf	PK	Cat. No.
0.5	self-standing	Ungraduated	17000	1000	9.284 167
1.5	self-standing	Ungraduated	17000	1000	9.284 168
1.5	round bottom	Ungraduated	20000	1000	9.284 169
2.0	self-standing	Ungraduated	17000	1000	6.251 980
2.0	round bottom	Ungraduated	20000	1000	9.284 170
0.5	self-standing	Ungraduated, with frosted marking area	17000	1000	4.000 234
1.5	self-standing	Graduated, with frosted marking area	17000	1000	6.801 871
1.5	round-bottom	Graduated, with frosted marking area	20000	1000	6.802 032
2.0	self-standing	Graduated, with frosted marking area	17000	1000	6.401 135
2.0	round-bottom	Graduated, with frosted marking area	20000	1000	6.401 081

5

5 Screw caps, PP for Micro tubes

BRAND



Colour	Sterile	Description	PK	Cat. No.
White	-	With silicone seal	1000	6.901 915
Blue	-	With silicone seal	1000	4.000 235
Red	-	With silicone seal	1000	6.801 872
Green	-	With silicone seal	1000	6.401 082
Yellow	-	With silicone seal	1000	6.401 134
Transparent	-	With tamper-evident screw cap, with silicone seal	1000	6.266 735
Blue	-	With tamper-evident screw cap, with silicone seal	1000	6.266 736
Green	-	With tamper-evident screw cap, with silicone seal	1000	6.266 737
Purple	-	With tamper-evident screw cap, with silicone seal	1000	6.266 738
Red	-	With tamper-evident screw cap, with silicone seal	1000	6.266 739
Yellow	-	With tamper-evident screw cap, with silicone seal	1000	6.266 740

1 Standard reaction tubes, 3810 X, PP



Eppendorf AG

- Flat, frosted cap and marking patch on the body of the tube provide generous space for labelling
- Simplified opening and closing due to improved neck/cap geometry
- Graduated from 0.1 to 1.5ml on the tube body
- Autoclavable when open (at 121°C for 20mins.)
- Can be centrifuged up to 30000 xg in fixed angle rotors (up to 70000 xg in swing-out rotors)
- Compatible with Micropestle

Colour	Capacity ml	PK	Cat. No.
transparent*	1.5	1000	6.700 374
transparent	1.5	1000	9.409 317
blue	1.5	1000	9.409 337
yellow	1.5	1000	9.409 338
green	1.5	1000	9.409 339
red	1.5	1000	9.409 347

* PCR clean



2 DNA LoBind Tubes



Eppendorf AG

- less than 1% loss of DNA/RNA at low concentrations and critical conditions (high salt, short DNA-fragments)
- no surface coating, e.g. silicone
- free of DNA, DNase, RNase and PCR inhibitors (PCR clean)
- novel PP, manufactured under optimized conditions
- available as 0.5ml, 1.5ml and 2.0ml Safe-Lock tubes
- highly transparent
- excellent centrifugation durability (up to 18000xg)

Capacity ml	PK	Cat. No.
0.5	250	9.409 324
1.5	250	9.409 326
2.0	250	9.409 327



3 Protein LoBind Tubes



Eppendorf AG

- minimum protein loss (less than 3%, BSA 1µg/ml)
- no surface coating, e.g. silicone
- free of DNA, DNase, RNase and PCR inhibitors (PCR clean)
- novel PP manufactured under optimized conditions
- available as 0.5ml, 1.5ml and 2.0ml Safe-Lock tubes
- highly transparent
- excellent centrifugation durability (up to 18000xg)

Capacity ml	PK	Cat. No.
0.5	100	9.409 328
1.5	100	9.409 329
2.0	100	9.409 330



General Consumables/Micro Tubes

1



1 2 Safe-lock reaction tubes, PP

Eppendorf AG



- A small clasp on the patented cap locking device clips onto the rim of the tube
- Autoclavable when open (121°C, 20min.)
- Can be opened and closed easily with one hand
- With frosted labelling area.
- The clasp on the cap prevents the lid springing open accidentally (e.g. when heating)
- Excellent mechanical stability for centrifugation
- Graduated
- Safe-lock reaction vessels are also available in Eppendorf Biopur® Quality
- 0.5ml and 1.5ml capacity Safe-lock reaction vessels can be centrifuged up to 30 000 x g

2



Colour	Capacity ml	PK	Cat. No.
Transparent	0.5	500	9.409 320
Yellow	0.5	500	9.409 354
Red	0.5	500	9.409 355
Blue	0.5	500	9.409 352
Green	0.5	500	9.409 353
Amber	0.5	500	9.409 356
Transparent	1.5	1000	9.409 331
Yellow	1.5	1000	9.409 332
Red	1.5	1000	9.409 333
Blue	1.5	1000	9.409 334
Green	1.5	1000	9.409 335
Amber	1.5	1000	9.409 336
Transparent	2.0	1000	9.409 341
Yellow	2.0	1000	9.409 342
Red	2.0	1000	9.409 343
Blue	2.0	1000	9.409 344
Green	2.0	1000	9.409 345
Amber	2.0	1000	9.409 346
Assorted colours	0.5	500	9.409 357
Assorted colours	1.5	1000	9.409 358
Assorted colours	2.0	1000	9.409 359

3



3 4 Safe-lock reaction tubes, Biopur®, sterile

Eppendorf AG

Comply with the exacting requirements set by the medical, pharmaceutical and food industries, molecular biology and cell technology.

- Sterile
- Free from pyrogens, RNase, DNA and ATP
- Independently checked and certified by an external laboratory.
- Individually blister-packed

4



Capacity ml	PK	Cat. No.
0.5	50	9.283 516
1.5	100	9.283 517
2.0	100	9.283 518

5



5 Reaction tubes PCR clean Safe-Lock

Eppendorf AG



Capacity ml	Colour	PK	Cat. No.
0.5	transparent	500	7.400 114
1.5	transparent	1000	7.400 585
2.0	transparent	1000	6.092 988

LLG-Centrifuge tubes, 5ml, PP



The LLG-Centrifuge tubes, 5ml, represent the perfect solution for all laboratory applications requiring incubation, centrifugation and sample handling in an intermediate volume range. Available in clear, and amber for use with light sensitive samples, and as an assorted colour pack (green, blue, yellow and red).

- Max. 25.000 x g, suitable for high speed centrifugation
- Graduations every 0.25 ml for easy volume estimation
- A flat, frosted cap and large writing pad for sample labeling and identification
- Autoclavable
- Fits all rotors and racks that hold 15 ml conical tubes, no adapters needed
- Certified free of RNase and DNase



Description	Package contents	PK	Cat. No.
Clear	1 bag of 250 pieces	250	6.281 113 1
Colour assortment green, yellow, red, blue	4 bags of 50 pieces (1 colour per bag)	200	6.281 114 2
Amber	1 bag of 250 pieces	250	6.281 115 2

Eppendorf Tubes® 5.0 mL, PP

Eppendorf AG



- Simple, practical and ergonomic single-hand operation. Large labelling area.
- Lid design: Hinged lid for minimized sample evaporation during storage and incubation in a wide range of temperatures from -86°C to 80°C
- Certified purity: Available in lot-tested and certified Eppendorf Quality, PCR clean, Sterile and Eppendorf Biopur® purity levels
- Maximum safety and stability for centrifugation up to 25 000 x g.
- Compatible with accessories for conical 15 ml tubes - many existing adapters and racks can be used.
- Available in Eppendorf LoBind® material for maximum recovery of valuable samples

The Starter Pack comprises:

- 400 Eppendorf Tubes® 5.0 mL, PCR clean (Certified purity grade)
- 8 universal adapters for rotors with bores for 15 ml conical tubes
- 2 Tube Racks 5.0 mL (16 spaces; white)
- Free of human DNA, free of DNase and RNase, free of PCR inhibiting agents.
- For PCR preparations or any reactions where DNase or RNase could interfere with the reaction or analysis.

From 80°C on, please use the Tube Clip opener Cat. No. 9.409 294.

Description	Package contents	PK	Cat. No.
Eppendorf Tubes® 5.0 mL, Eppendorf Quality™	2 bags of 100	200	9.409 277 4
Eppendorf Tubes® 5.0 mL, PCR clean	2 bags of 100	200	9.409 278
Eppendorf Tubes® 5.0 mL, Sterile	10 bags of 20	200	9.409 279
Eppendorf Tubes® 5.0 mL, Biopur®	bag of 50, single packed	50	9.409 288
Eppendorf Protein LoBind Tube, PCR clean	2 bags of 50	100	9.409 289
Eppendorf Protein LoBind Tube, PCR clean	2 bags of 100	200	4.665 939
Eppendorf DNA LoBind Tube, PCR clean	4 bags of 50	200	9.409 290
Eppendorf DNA LoBind Tube, PCR clean	2 bags of 100	200	4.665 938
Eppendorf Tubes® 5.0 mL, Eppendorf Quality™, amber (light protection)	2 bags of 100	200	6.265 214 5
Eppendorf Tubes® 5.0 mL, amber (light protection), Sterile	2 bags of 100	200	4.665 937
Tube Clip, Eppendorf Quality™		10	9.409 294 6
5.0 mL Starter Pack, PCR clean	2 Packs with 2 bags of 100 each, 2 Racks (16 spaces each), 8 Universal adapters	1	9.409 291 7
Eppendorf Tubes® 5.0 mL, Forensic DNA Grade	4 bags of 50	200	6.287 838
Eppendorf Tubes® 5.0 mL, Forensic DNA Grade, single packed	4 bags of 50	200	6.287 839



1



1 Eppendorf Tubes® 25 ml, PP

NEW

Eppendorf AG



Transparent. For cell culture applications, sample preparations, storage and transport of samples. The SnapTec™ cap version allows single-handed opening and closing for quick liquid extraction or addition. Also available with HDPE screw cap.

- Conical
- Single-Handed Operation
- Tightness from -86 °C to 100 °C
- Max. RZB 17000 x g
- Lower height than 15 ml/50 ml conical tubes
- The SnapTec tubes are autoclavable

Starter pack 1: 200 Eppendorf Conical Tubes® 25 ml with snap cap SnapTec™, PCR clean, 4 single tube stands, 6 adapters for rotors with bore for 50 ml conical tubes

Starter pack 2: 200 Eppendorf Conical Tubes® 25 ml with screw cap, PCR clean, 4 single tube stands, 6 adapters for rotors with bore for 50 ml conical tubes

Description	PK	Cat. No.
Starter pack 1	1	6.311 419
Starter pack 2	1	4.669 460

2



2 Micro test tubes and racks, PP, 1.2 ml

BRAND



Suitable for biological examination, e.g. PCR, cell uptake studies, RIA, EIA, etc. Functional design for storing, freezing and transporting reagents and samples. Compatible with standard microtitre plates and suitable for work with multi-channel pipettes.

- 8 x 12 configuration
- Alphanumeric identification system
- Tubes and rack are autoclavable at 121 °C (2 bar), according to DIN EN 285
- Tube dimensions: 8.8mm external Ø, height 45mm
- Suitable for storage up to -80°C
- Test tube capacity 1.2ml (1.1ml when capped)
- Individual tube or 8-tube strips available
- With PE cap (not autoclavable)

Type	PK	Cat. No.
Rack with 96 single test tubes, non-sterile, PP	10	9.407 605
Rack with 12 x 8-tube strips, non-sterile, PP	10	9.407 606
Test tubes, single, non-sterile, loose, PP	960	9.407 607
8-tube strips, non-sterile, loose, PP	120	9.407 608
Lid, single, non-sterile, loose, PE	960	9.407 609
8-cap strip, non-sterile, loose, PE	120	9.407 610
Rack with grid, non-sterile (empty), PP	10	9.407 611

➔ Further Centrifuge tubes - please see page 688.



1 2 3 LLG-Test and centrifuge tubes rimmed, PS or PP

- Made of ultra clear virgin polypropylene or virgin polystyrene
- Polystyrene tubes are transparent. Polypropylene tubes are opaque, break-resistant
- Tubes with cap are ethylene oxide sterilized
- With label

LLG-Dual-Position Caps for test- and centrifuge tubes, PE

- For culture tubes with an O.D. of 12 mm and 17 mm
- 2 locking positions possible:
 - Closed , but gas exchange is still possible for aerobic growth conditions
 - Hermetically sealed for anaerobic growth conditions, for storage or despatch of samples or for centrifugation

Description	Capacity	Diam.	Height	Material	Max. rcf	Max. temp. °C	PK	Cat. No.
	ml	mm	mm					
with rim	4	12	75	PS	1400	80	500	6.265 657
with rim	4	12	75	PP	3000	120	500	6.265 658
with rim	12	17	100	PS	3000	80	250	6.265 659
with rim	12	17	100	PP	5500	120	250	6.265 660
with dual-position-cap, sterilized	4	12	75	PS	1400	80	500	6.265 661
with dual-position-cap, sterilized	4	12	75	PP	3000	120	500	6.265 662
with dual-position-cap, sterilized	12	17	100	PS	3000	80	500	6.265 663
with dual-position-cap, sterilized	12	17	100	PP	5500	120	500	6.265 664
dual-position-cap		12		PE	-		1000	6.265 665
dual-position-cap		17		PE	-		1000	6.265 666



4 LLG-Centrifuge Tubes economy, PP



- With flat PE caps
- With conical bottom (15 and 50 ml) or with self-standing bottom (50 ml)
- Easy-to-read black volume graduations
- With a large frosted writing area
- Engraved graduation at the conical bottom of each tube
- Max. rotate speed up to 12000 x g for conical bottom tubes and 6000 x g for self-standing tubes
- Autoclavable at 121 °C and freezable to -80 °C
- Leak-proof
- Free of heavy metals, pyrogens and endotoxins
- DNase/RNase-free
- Aseptically or sterile



Capacity ml	Description	Form	Height mm	Diam. mm	PK	Cat. No.
15	Sterile, in bag of 25 pieces	conical	119.6	17	500	4.668 482
50	Sterile, in bag of 25 pieces	conical	113.9	30	500	4.668 483
50	Sterile, in bag of 25 pieces	with rim	116.5	30	500	4.668 486
15	Aseptically, bulk pack	conical	119.6	17	500	6.270 403
50	Aseptically, bulk pack	conical	113.9	30	500	6.270 404
50	Aseptically, bulk pack	with rim	116.5	30	500	6.270 405

General Consumables/Centrifugation Tubes

1



1 LLG-Centrifuge tubes, PP



Polypropylene tubes with very good thermal, mechanical and chemical stability. With screw closures. Sterile tubes with screwed-on closure. Packed in boxes or bags. With graduations and labelling area.

Centrifugation capacity (Max. RCF): 6000 x g
Height: 120 mm

Description	Form	Capacity ml	Diam. mm	PK	Cat. No.
sterile, single packed*	conical	15	17	50	9.316 062
aseptic, bulk pack	conical	15	17	50	6.263 886
big pack	conical	15	17	500	9.316 063
sterile, single packed*	conical	50	30	50	9.316 064
big pack	conical	50	30	500	9.316 065
aseptic, bulk pack	conical	50	30	50	6.263 887
sterile, single packed*	with rim	50	30	50	9.316 067
big pack, bulk pack	with rim	50	30	50	4.008 506
aseptic, bulk pack	with rim	50	30	50	6.263 888

*Cytotoxicity-free, DNase/RNase- and human DNA-free.

2



2 Eppendorf Tubes 15 mL and 50 mL, PP, with screw cap, HDPE

For cell culture applications, sample preparation and storage of samples and solutions.

Eppendorf AG

- Conical
- Temperature resistant from -86 °C to 100 °C
- Max. RZB 19500 x g

Nominal capacity ml	Description	Colour	Sterile	Package contents	PK	Cat. No.
15	Pyrogen-, DNase-, RNase- and DNA-free	clear	+	10 bags of 50 pieces	200	4.664 663
50	Pyrogen-, DNase-, RNase- and DNA-free	amber	+	8 bags of 25 pieces	200	4.664 664
15	Pyrogen-, DNase-, RNase- and DNA-free	clear	+	10 bags of 50 pieces	500	6.266 822
50	Pyrogen-, DNase-, RNase- and DNA-free	clear	+	20 bags of 25 pieces	500	6.266 823
15	Protein LoBind, PCR clean	clear	-	4 bags of 50 pieces	200	6.274 362
50	Protein LoBind, PCR clean	clear	-	4 bags of 50 pieces	200	6.274 363
15	DNA LoBind, PCR clean	clear	-	4 bags of 50 pieces	200	6.285 440
50	DNA LoBind, PCR clean	clear	-	4 bags of 50 pieces	200	6.285 441
15	Forensic DNA Grade, individual packed	clear	-	100 pieces	100	6.287 840
50	Forensic DNA Grade, individual packed	clear	-	48 pieces	48	6.287 841

3



7.657 835

4



7.657 836

Centrifuge tubes, black, PP, sterile



Heathrow Scientific



For light-sensitive samples. With graduations and writing area. Certified DNase, RNase and pyrogen-free. Autoclavable.

Nominal capacity ml	Sterile	Colour	Package contents	PK	Cat. No.
15	+	black	10 bags of 50	500	7.657 835 3
50	+	black	20 bags of 25	500	7.657 836 4

1 Deep-well storage plates, 96-well, PP NEW



Suitable for test preparation and for storage and transport of samples.

- Clear
- Produced under clean room conditions
- Compatible with automated systems
- Round well bottom (U)
- RNase und DNase free

Nominal capacity ml	Sterile	PK	Cat. No.
1.1	-	50	6.313 390
2.0	-	25	6.313 389



2 LLG-Sealing mats for Deep well plates, 96-well

- for sample storage
- alphanumeric grid
- thermoplastic elastomer
- flexible with end tabs

Description	Material	PK	Cat. No.
Square nodules	Silicone	50	6.313 395
Round nodules	Silicone	50	6.313 397



3 Deep Well Plates Nunc™, 96-well, PP



Thermo Scientific

The plates are suitable for sample collection, storage, combinatorial chemistry, substance libraries, bacteria and yeast cultures and as collection plates for Nunc filter plates. They are resistant to most chemicals, solvents and alcohols used in combinatorial chemistry.

- Colour natural
- With shared wall technology
- Round bottom reduces fluid retention

Nominal capacity ml	Sterile	PK	Cat. No.
1	+	50	4.008 844
1	-	50	6.305 666

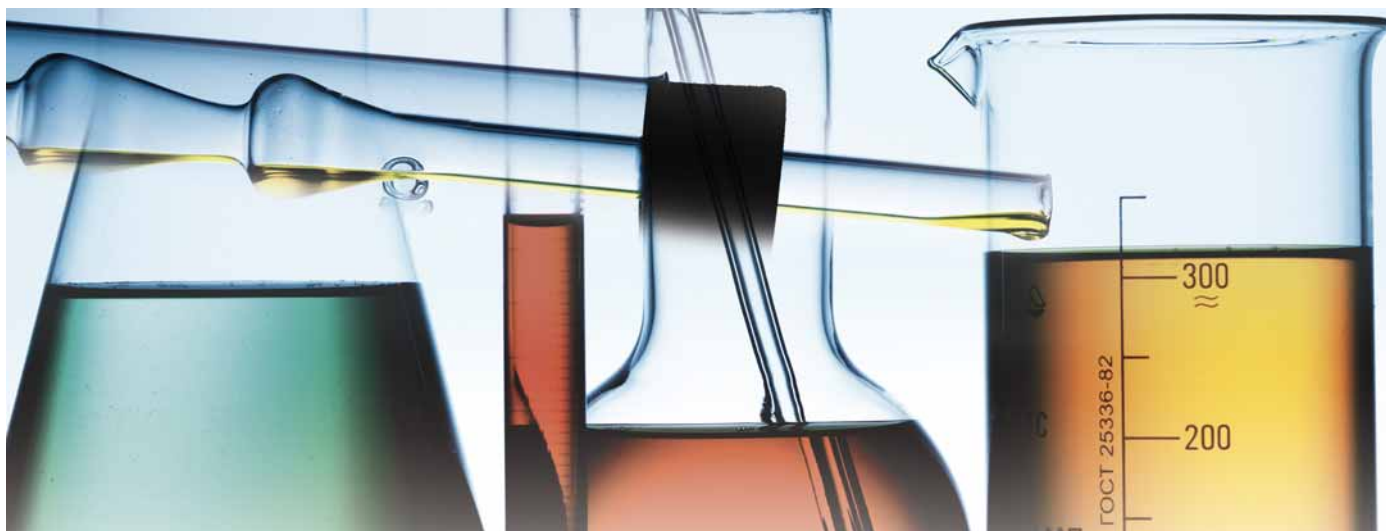

General Consumables/Deep-well plates



1 2 Deep-well plate system, Riplate®

Riplate® round wells - Standard in Multifunction

Ritter

Raised wells reduce the risk of cross-contamination and increase the security of hot sealing or sealing with adhesive foils. Riplate® 1ml is ideal for use in a thermocycler or for defrosting of samples in a hot-water bath. The U-shaped well bottom reduces the death-volume.

Riplate® square wells - For a Maximum in Capacity

Riplate® SW have been developed for optimal use of capacity when it comes to sample storage. Due to the SBS-format the outside dimensions of Riplate® are given. Form follows function: the construction of cavities is crucial for a maximum absorption of liquids.

Riplate® medio - Saves 50% of Storage Capacity

Due to the compact construction of Riplate® medio less than 50% stacking size is needed. Higher well rims allow an airtight closure or sealing of Riplate® medio. The alphanumeric marking allows registration and identification of single assays.

Riplate® 384 - Optimized for Smaller Volumes

Available in PS and PP for automated screening and storage systems. Alphanumeric marking for identification of samples. Round cavities for reduced capillary forces. With flat well-bottom - ideal for microscopic and optical applications.

Field of application: screening, sample storage et al. Ritter Riplate® systems are in line with the SBS-standard and are suitable for automation systems with corresponding closing- and sealing-mechanism.

Type	PK	Cat. No.
Round well 96, PS - 1ml, U-shaped well-bottom	20	9.284 250
Round well 96, PP - 1ml, U-shaped well-bottom	20	9.284 251
Round well 96, PP - 2ml, U-shaped well-bottom	20	9.284 300
Square-well 96, PP - 2ml, U-shaped well-bottom	20	9.284 252
Cap mat for Square well 96, 2ml	100	9.284 209
Square-well 48, PP - 5ml, V-shaped well-bottom	20	9.284 260
Cap mat for Square well 48, 5ml	100	9.284 228
Square-well 24, PP - 10ml, V-shaped well-bottom	20	7.635 031
384-well Plate PP	100	9.284 256
384-well Plate PS, clear	100	9.284 257
384-well Plate PS, white	100	9.284 258
384-well Plate PS, black	100	9.284 259
Deep-well 96, PP - 1.0ml medio	32	9.284 295
Deep-well 96, PP - 0.5ml medio	40	9.284 296
Square-well 96, PP - 2ml, sterile	10	9.284 297
Square-well 48, PP - 5ml, sterile	10	9.284 298
Square-well 24, PP - 10ml, sterile	10	9.284 299



7.632 508



6.237 242

Deep Well Plates, 96/48-well, PP



Ratiolab

Deep-well plates from Ratiolab are available as standard or low profile version with different volumes from 1.2 to 4.6 ml for each well.

- Available with U-bottom (low profile + standard) and as V-bottom version
- SBS standard micro test plate format
- Wells with significantly larger cross section for reduced cross-contamination
- Improved visual control due to clear polypropylene
- 1.2 ml low profile is about half as high as conventional deep-well plates
- 30 % less storage space when using low profile plates
- Autoclavable at 121 °C, 20 min
- Temperature resistant to -80 °C
- 8 x 12 wells with alphanumeric code in micro test plate format
- Precise design, for use in automatic pipetting systems for High Throughput Screening (HTS)
- Optimum space for bar code labels on the side walls
- Space-saving and stackable

Type	Volume ml	Bottom shape	Package contents	PK	Cat. No.
96-well, low profile	1.2	U	10 bags of 5	50	7.632 508
96-well	1.2	U	10 bags of 5	50	4.653 801
96-well	2.0*	V	10 bags of 5	50	6.237 242
48-well	3.5	U	10 bags of 5	50	4.665 841
48-well	4.6*	U	10 bags of 5	50	4.665 842

* with square opening

1 Deep well plates

Developed for a range of uses, e.g. High-Throughput Screening (HTS), general analysis which requires a master reservoir plate, cell and tissue culture, sample storage, etc. Deep well plates can be used with all leading robotic systems and other autosampling devices.

BRAND

- Capacities: 96 well: 0.5ml, 1.1ml, (1ml with lid), 1.2ml or 2.2ml (2ml with lid), 384 well: 0.3ml
- U-bottom wells
- Low Profile and Standard profile
- 96 well: 12 x 8 array, 384 well: 24 x 16 array
- High chemically-resistant polypropylene (e.g.: against DMSO, phenol, chloroform)
- ANSI/SLAS format
- Alphanumeric well coding
- Plates suitable for freezing down to -80°C (PP) or -20°C (PS)
- One notched corner ensures correct orientation.
- Stackable
- DNA-, RNase-, DNase -free



Description	PK	Cat. No.
Deep well plate, 1.2 ml, 96 well, PP, non-sterile, low profile	50	4.007 852
Deep well plate, 1.2 ml, 96 well, PP, non-sterile, high wells	32	9.407 624
Deep well plate, 0.3 ml, 384 well, PP, non-sterile, standard	48	9.407 622
Deep well plate, 0.5 ml, 96 well, PP, non-sterile, standard	48	9.407 618
Deep well plate, 1.1 ml, 96 well, PP, non-sterile, standard	24	9.407 614
Deep well plate, 1.1 ml, 96 well, PS, non-sterile, standard	32	9.407 619
Deep well plate, 2.2 ml, 96 well, PP, non-sterile, standard	24	9.407 615

2 Sealing mats

Cover mats reduce the maximum volume of wells, but improve sealing and reduce sample evaporation. Adhesive sealing films can also be used.

BRAND



Description	PK	Cat. No.
Cover mat for 0.3 ml 384-well plates (standard), silicone, non-sterile	50	9.407 623
Cover mat for 0.5 ml 96-well plates (standard), PP, non-sterile	50	9.407 621
Cover mat for 1.1 ml 96-well plates (standard), mod. PE, non-sterile	24	9.407 616
Cover mat for 1.2 ml 96-well plates (low profile), TPE, non-sterile	50	4.007 853
Cover mat for 2.2 ml 96-well plates (standard), EVA, non-sterile	24	9.407 617
Sealing foil, gas-permeable, non-sterile	100	9.407 620



General Consumables/Deep-well plates

1



4.655 301

Deep-Well Plates, 96/384-well, PP



Eppendorf AG

High-performance plates for manual or automated applications. Suitable for sample storage and preparation, bacteria and yeast cultivation, DNA and RNA isolation, protein analysis and plasmid purification.

- Clear wells
- Frame, white or coloured
- High-contrast, alphanumeric lettering
- Autoclavable (121 °C, 20 min)
- Centrifugation resistance up to 6000 × g
- Rounded RecoverMax®-Well-Design
- Elevated well frames for reliable sealing, even with heat sealing
- Stackable
- PCR clean: free of human DNA, DNase, RNase and PCR inhibitors or sterile
- Available with bar code (on request)

2



4.655 304

3



4.655 305

4



6.243 984

Type	Capacity µl	Colour	Sterile	PK	Cat. No.
96-well	500	white	+	40	4.655 301
96-well	500	white	+	120	4.655 313
96-well	500	yellow	+	40	6.233 985
96-well	500	green	+	40	4.655 302
96-well	500	blue	+	40	6.233 986
96-well	1000	white	+	80	4.655 314
96-well	1000	white	+	20	7.638 886
96-well	1000	yellow	+	20	7.638 887
96-well	1000	green	+	20	7.638 888
96-well	1000	blue	+	20	7.638 889
96-well	2000	white	+	20	4.655 303
96-well	2000	white	+	80	7.671 104
96-well	2000	yellow	+	20	4.655 304
96-well	2000	green	+	20	4.655 305
96-well	2000	blue	+	20	6.243 984
384-well	200	white	+	40	4.655 335
384-well	200	white	+	120	4.655 338
96-well, PCR clean	500	white	-	40	6.236 383
96-well, PCR clean	500	white	-	120	4.655 310
96-well, PCR clean	500	yellow	-	40	4.655 296
96-well, PCR clean	500	green	-	40	4.655 297
96-well, PCR clean	500	blue	-	40	4.655 298
96-well, PCR clean	1000	white	-	20	4.655 299
96-well, PCR clean	1000	white	-	80	4.655 311
96-well, PCR clean	1000	yellow	-	20	4.655 300
96-well, PCR clean	1000	green	-	20	6.234 018
96-well, PCR clean	1000	blue	-	20	6.241 252
96-well, PCR clean	2000	white	-	20	6.232 501
96-well, PCR clean	2000	white	-	80	4.655 312
96-well, PCR clean	2000	yellow	-	20	6.233 418
96-well, PCR clean	2000	green	-	20	6.233 420
96-well, PCR clean	2000	blue	-	20	6.233 421
384-well, PCR clean	200	white	-	40	4.655 334
384-well, PCR clean	200	white	-	120	4.655 337

Vials	1420
General information vials and caps.....	1420
Autosampler Compatibility List	1421
Authentic 1:1 size drawings of all vials	1428
Septa and cap recommendation.....	1433
Vials, Septa	1435
Accessories.....	1451
NMR/EPR	1452
Tubes.....	1452
Accessories.....	1453
Syringes	1454
Microlitre Syringes	1454
Disposable syringes	1460
Sample preparation	1463
SPE	1463
Syringe filters	1468
Liquid chromatography	1472
HPLC columns	1472
HPLC-Accessories	1473
Glass columns.....	1475
Solvent storage/handling	1477
Gas chromatography	1484
Gas generators.....	1484
GC columns	1488
GC reagents.....	1490
GC consumables.....	1491
Thin-layer chromatography	1495
Plates	1495
Chambers.....	1498
Detection	1499
Accessories.....	1500

General information about vials and caps

Technical Information – Vials

In chromatography a broad variety of glass or plastic vials are used as sample containers for analysis usage. As they are mainly used within autosamplers or any other automatic instrument, strict obedience of all dimensions is crucial for a trouble-free run. Besides these physical properties the vials also have to fulfill requirements regarding inertness and cleanliness, as otherwise analysis results may be incorrect. LLG Labware consider the physical and chemical demands in their production process by various implementations:

Almost all vials are made out of 1st hydrolytic class glass. First hydrolytic class glass is very hard and has a low expansion coefficient even at high temperature variations. It shows an excellent chemical resistance to acidic and neutral solutions, and even to alkaline solutions due to its relatively low Alkali content. Higher density of the glass surface offers a higher hydrolytic resistance. Clear Glass of 1st hydrolytic class is differentiated by 33 expansion (Type 1, Class A) and 51 expansion glass (Type 1, Class B), whereas amber is generally worldwide only available as 51 expansion glass. The indicated lower expansion coefficient of 33 implies that this harder clear glass has to be processed at higher temperatures. These amount to approx. 1,200°C for 33 expansion glass in comparison to only approx. 1,000°C for glass of 51 expansion. In the USA typically clear glass in 33 expansion and amber glass in 51 expansion is used, whereas in Europe solely 51 expansion glass is processed. From a quality point of view both types of glass are equally suitable for usage in chromatography, as they both are glasses of 1st hydrolytic class.

Technical Information – Seals

Seals are the assembled combination of a cap and a septa. To carry out a correct analysis, it is important that besides the vial the seal is also inert and uncontaminated. The closures sold by LLG Labware are automatically assembled and packed according to internally defined conditions of the supplier. Photocells check the side-orientation of the liner, so that it is ensured that the PTFE lamination is always directed towards the sample to build an inert barrier between sample and carrier material of the septa. A gauge control ensures that not more or less than one septa is installed. The final seals are automatically counted – and not weighed – by automates to guarantee quantity obedience. They are packed in tamper-proof evident zip-lock bags that allow easy identification of the content due to the transparent PE material. The zip-lock enables resealing of the bag to avoid any contamination of the closures during consumption. The batch number of the manufactured seal is printed on each PE-bag for traceability.

Technical Information – Septa

The right choice of septa depends on the application. Almost all septa are laminated on one side with PTFE, which has a high chemical resistance and forms an inert barrier between sample and carrier material of the septa. The carrier materials have different physical and chemical properties, such as temperature resistance, resealability properties, cleanliness, hardness, thickness, etc.

The individual conditions of the customer's application aim at the specific characteristics of the carrier material, e.g.:

Multiple injection?	Temperature?			Thin, fragile needle?	Blunt, thick needle?	Critical analysis?	Low coring?
	-40°C up to 120°C	-40°C up to 110°C	-60°C up to 200°C				
↓ good resealability properties necessary	↓ Natural Rubber/TEF; Butyl/PTFE	↓ Red Rubber/PTFE	↓ Silicone/PTFE	↓ soft and thin septa required	↓ Slitted/pre-cut liner as penetration aid (HPLC)	↓ very clean liner required	↓ Both sided PTFE laminated liners required
↓ Natural Rubber/TEF				↓ e.g. Silicone/PTFE	↓ e.g. 08 02 0039	↓ Silicone/PTFE septa	↓ PTFE/Silicone/PTFE PTFE/Butyl/PTFE

LLG - Vials and autosamplers: compatibility chart

Agilent
Alternative LLG Labware products for use on Agilent GC, HPLC and Headspace instruments.

Agilent GC Products						
	Crimp Neck ND 8	Agilent Art.-No.	Screw Neck ND9	Agilent Art.-No.	Crimp Neck ND11	Agilent Art.-No.
Vials	4.001 554	5180-0841	9.003 448	5182-0714	6.291 635	5181-3375
			4.662 800	5182-0715	6.290 019	5182-0543
			4.662 801	5182-0716	6.291 636	5181-3376
			4.008 249	5183-2030	4.008 255	9301-1388
			6.266 869			
			6.260 742			
			6.260 743			
Micro-Inserts			7.401 744	5183-2085	7.401 744	5183-2085
			6.093 247	5181-1270	6.093 247	5181-1270
			4.008 196	5181-3377	4.008 196	5181-3377
Seals	9.003 444	5180-0842	4.008 228	5182-0717	6.291 637	5181-1210
			7.615 161	5182-0720	9.003 446	5182-0552
			4.008 218	5182-0723	7.050 759	5181-1211
			4.008 216	5182-0717	4.001 564	5188-5386
			4.008 214	5185-5823	9.003 441	5181-1210

Agilent HPLC Products						
	Screw Neck ND9	Agilent Art.-No.	Crimp Neck ND11	Agilent Art.-No.	Snap Ring ND11	Agilent Art.-No.
Vials	9.003 448	5182-0714	6.291 635	5181-3375	6.073 833	5182-0544
	4.662 800	5182-0715	6.290 019	5182-0543	6.270 176	5182-0546
	4.662 801	5182-0716	6.291 636	5181-3376	6.270 177	5182-0545
	6.266 869					
	6.260 742					
	6.260 743					
	4.008 249	5183-2030	4.008 255	9301-1388	4.008 255	5188-6593
Micro-Inserts	7.401 744	5183-2085	7.401 744	5183-2085	7.401 744	5183-2085
	6.093 247	5181-1270	6.093 247	5181-1270	6.093 247	5181-1270
	4.008 196	5181-3377	4.008 196	5181-3377	4.008 196	5181-3377
Seals	4.008 228	5182-0717	6.291 637	5181-1210	4.008 257	5182-3458
	7.615 161	5182-0720	9.003 446	5182-0552	4.008 258	5182-0541
	4.008 218	5182-0723	7.050 759	5181-1211	4.008 259	5182-0566
	4.008 216	5182-0717	4.001 564	5188-5386	4.008 256	5183-4511
	4.008 214	5185-5823	9.003 441	5181-1210		
	4.008 215	5185-5824	4.001 555			
	4.001 521	5183-2076				

Agilent Headspace Products				
	Headspace Screw ND 18 (Combi Pal + G 1888A)	Agilent Art.-No.	Headspace Crimp Neck ND 20	Agilent Art.-No.
Vials	9.003 466	5188-5392	7.050 285	5182-0838
	6.290 106	5188-6538	9.003 452	5182-0837
	4.008 270	5188-2753	7.401 840	5183-4474
	4.678 396	5188-6537		
	7.401 840	5183-4474		
Seals	4.008 268	5188-2759	4.001 557	5183-4479
			9.003 460	5183-4477
			9.003 453	5183-4474

Autosampler compatibility chart

The autosampler compatibility chart generally shows the most typical LLG-Labware vials and closures for usage on instruments of different manufacturers. Additionally the corresponding part number of the manufacturer is indicated. Beside these there also may be further products in our catalogue which may technically and functionally be suitable. We will gladly recommend other suitable products. If applicable for a manufacturer, each table has been divided by the application HPLC, GC and Headspace. We generally recommend asking for cost-free samples for testing purposes. We kindly ask for your understanding that we do not take any guarantee for the correctness nor for the completeness of the data indicated here.

LLG - Vials and autosamplers: compatibility chart

CTC Analytics

Alternative LLG Labware products for use on CTC Analytics GC, HPLC and Headspace instruments.

CTC Analytics GC Products

	Crimp Neck ND 8	CTC Art.-No.	Screw Neck ND9	CTC Art.-No.	Crimp Neck ND11	CTC Art.-No.
Vials	4.001 554		9.003 448		6.291 635	
	6.235 606		4.662 800		6.290 019	
	4.001 515		4.662 801		6.291 636	
	6.902 044		4.008 249		4.008 255	
	4.008 202		6.266 869			
	4.008 203		6.260 742			
			6.260 743			
Micro-Inserts			7.401 744		7.401 744	
			6.093 247		6.093 247	
			4.008 196		4.008 196	
Seals	9.003 444		4.008 228		4.001 564	GC PAL
	4.008 198		7.615 161		9.003 446	
			4.001 521		7.050 759	
			4.008 218			
			4.008 215			

CTC Analytics HPLC Products

	Crimp Neck ND 8	CTC Art.-No.	Screw Neck ND9	CTC Art.-No.	Crimp Neck ND11	CTC Art.-No.	Snap Ring ND11	CTC Art.-No.
Vials	4.001 554		9.003 448		6.291 635		6.073 833	
	6.235 606		4.662 800		6.290 019		6.270 176	
	4.001 515		4.662 801		6.291 636		6.270 177	
	6.902 044		4.008 249		4.008 255		4.008 255	
	4.008 202		6.266 869					
	4.008 203		6.260 742					
			6.260 743					
Micro-Inserts			7.401 744		7.401 744		7.401 744	
			6.093 247		6.093 247		6.093 247	
			4.008 196		4.008 196		4.008 196	
Seals	9.003 444		4.008 228		6.291 637		4.008 258	
	4.008 198		7.615 161		9.003 446		4.008 259	
			4.001 521		7.050 759			
			4.008 218					
			4.008 215					

CTC Analytics Headspace Products

	Headspace Screw Neck ND 18 (Combi Pal)	CTC Art.-No.	Headspace Crimp Neck ND 20 (Combi Pal)	CTC Art.-No.
Vials	9.003 466		7.850 009	
	6.290 106		9.003 453	
	4.008 270			
	4.678 396			
Seals	4.008 268		7.850 010	
	6.241 111		6.234 541	

LLG - Vials and autosamplers: compatibility chart

Dionex

Alternative LLG Labware products for use on Dionex HPLC instruments.

Dionex HPLC Products

	Crimp Neck ND 8	Dionex Art.-No.	Screw Neck ND8	Dionex Art.-No.	Screw Neck ND9	Dionex Art.-No.	Crimp Neck ND11	Dionex Art.-No.	Snap Ring ND11	Dionex Art.-No.
Vials	4.008 206		9.003 481		9.003 448		6.291 635		6.073 833	
	6.235 606		7.613 087		4.662 800		6.290 019		6.270 176	
	4.001 554		9.003 480		4.662 801		6.291 636		6.270 177	
			6.290 228		4.008 249		4.008 255		4.008 255	
					6.266 869					
					6.260 742					
					6.260 743					
Micro-Inserts			7.401 066		7.401 744		7.401 744		7.401 744	
			4.001 556		6.093 247		6.093 247		6.093 247	
			4.008 194		4.008 196		4.008 196		4.008 196	
Seals	4.008 200		4.008 209		4.008 228		6.291 637		4.008 257	
	9.003 444		9.003 484		7.615 161		9.003 446		4.008 258	
			6.232 178		4.001 521		7.050 759		4.008 259	
					4.008 214		4.001 555		4.008 256	
					4.008 215					

Autosampler compatibility chart

The autosampler compatibility chart generally shows the most typical LLG-Labware vials and closures for usage on instruments of different manufacturers. Additionally the corresponding part number of the manufacturer is indicated. Beside these there also may be further products in our catalogue which may technically and functionally be suitable. We will gladly recommend other suitable products.

If applicable for a manufacturer, each table has been divided by the application HPLC, GC and Headspace. We generally recommend asking for cost-free samples for testing purposes.

We kindly ask for your understanding that we do not take any guarantee for the correctness nor for the completeness of the data indicated here.

LLG - Vials and autosamplers: compatibility chart

PerkinElmer

Alternative LLG Labware products for use on Agilent GC, HPLC and Headspace instruments.

PerkinElmer GC Products

	Crimp Neck ND 8	PerkinElmer Art.-No.	Screw Neck ND9	PerkinElmer Art.-No.	Screw Neck ND10	PerkinElmer Art.-No.	Crimp Neck ND11	PerkinElmer Art.-No.
Vials	6.235 606	N9302136	9.003 448	N9306201	6.242 103		6.291 635	N9301385
	9.003 427	N9301069	4.662 800	N9306201	7.615 715		6.290 019	N9301385
			4.008 247	N9306220	6.280 951		6.291 636	N9302680
			4.662 801	N9306220				
			6.266 869					
		6.260 742						
		6.260 743						
Micro-Inserts			6.093 247	N9300703	6.093 247	N9300703	6.093 247	N9300703
			4.008 196	N9300704	4.008 196	N9300704	4.008 196	N9300704
Seals	4.001 558	N9302140	4.008 228	N9306200	4.008 234	N9306205	7.060 469	N9306230
	9.003 443	03300806	7.615 161	N9306202	4.008 235	N9306205	6.291 637	N9306015
	4.008 200	03300806	4.008 214	N9306202			4.001 522	N9302684
							7.300 348	N9302685
							6.900 233	N9302686
						9.003 446	N9306228	
						7.050 759	N9306229	

PerkinElmer HPLC Products

	Crimp Neck ND 8	PerkinElmer Art.-No.	Screw Neck ND9	PerkinElmer Art.-No.	Screw Neck ND10	PerkinElmer Art.-No.	Crimp Neck ND11	PerkinElmer Art.-No.	Snap Ring ND11	PerkinElmer Art.-No.
Vials	6.235 606	N9302136	9.003 448	N9306201	6.242 103		6.291 635	N9301385	6.073 833	N9303418
			4.662 800	N9306201	7.615 715		6.290 019	N9301385	6.270 176	
			4.008 247	N9306220	6.280 951		6.291 636	N9302680	6.270 177	
			4.662 801	N9306220						
			6.266 869							
		6.260 742								
		6.260 743								
Micro-Inserts			6.093 247	N9300703	6.093 247	N9300703	6.093 247	N9300703	6.093 247	N9300703
			4.008 196	N9300704	4.008 196	N9300704	4.008 196	N9300704	4.008 196	N9300704
Seals	9.003 443	03300806	4.008 228	N9306200	4.008 234	N9306205	7.060 469	N9306230	6.073 555	N9303417
	4.008 200	03300806	7.615 161	N9306202	4.008 235	N9306205	6.291 637	N9306015	4.001 544	N9303419
			4.008 214	N9306202	4.008 237	N9306052	4.001 522	N9302684	4.008 256	N9303416
			4.001 521	N9306203			7.300 348	N9302685		
							6.900 233	N9302686		
						9.003 446	N9306228			
						7.050 759	N9306229			
						4.001 555				

PerkinElmer Headspace Products

	Headspace Screw Neck ND 18 CTC Combi Pal + Turbo Matrix™ HS16+40	PerkinElmer Art.-No.	Headspace Screw Neck ND20 CTC Combi PAL	PerkinElmer Art.-No.	Headspace Screw Neck ND20 Turbo Matrix™ HS 16, 40 + 110 *** not suitable for TurboMatrix™ 110	PerkinElmer Art.-No.
Vials	9.003 466	N6356479	7.850 009	N6356478	7.052 186 ***	N9302134
	6.290 106		9.003 453	N6356471	7.060 463	N9306079
	4.008 270	N9306075			4.008 281	N9303349
	4.678 396					
Seals	4.008 268	N9306077	7.850 010	N6356559	4.001 557	N9306266
	6.241 111	N6356475	6.234 541	N6356566	9.003 455	N9306266
			6.902 419	N6356562	4.008 276	N9306266
			6.229 635	N6356560	9.003 456	B0104241
			4.001 548	N6356560	7.050 286	B0104242
					7.060 477	B0110728
				7.060 433	B0038137	

LLG - Vials and autosamplers: compatibility chart

Shimadzu

Alternative LLG Labware products for use on Shimadzu GC, HPLC and Headspace instruments.

Shimadzu GC Products

	Crimp Neck ND 8	Shimadzu Art.-No.	Screw Neck ND9	Shimadzu Art.-No.	Screw Neck ND10	Shimadzu Art.-No.	Crimp Neck ND11	Shimadzu Art.-No.	Screw Neck ND13	Shimadzu Art.-No.
Vials	4.001 554		9.003 448		6.242 103		6.291 635	980-01705	9.003 482	
	4.001 515		4.008 247				6.290 019		7.058 142	
	6.902 044		4.008 249				6.291 636			
	4.008 202		6.266 869				4.008 255			
	4.008 203		6.260 742							
			6.260 743							
Micro-Inserts			7.401 744	980-04987	7.401 744	980-04987	7.401 744	980-04987	7.055 486	
			6.093 247	980-01707	6.093 247	980-01707	6.093 247	980-01707		
			4.008 196		4.008 196		4.008 196			
Seals	9.003 444		7.615 161		4.008 234		4.001 564	0980-01706	7.510 053	
	4.008 198		4.008 218		4.008 235		9.003 446			
			4.008 214		4.008 236		7.050 759			

Shimadzu HPLC Products

	Crimp Neck ND 8	Shimadzu Art.-No.	Screw Neck ND9	Shimadzu Art.-No.	Screw Neck ND10	Shimadzu Art.-No.	Crimp Neck ND11	Shimadzu Art.-No.	Snap Ring ND 11	Shimadzu Art.-No.
Vials	4.001 554		9.003 448		6.242 103		6.291 635	980-01705	6.073 833	
			4.008 247				4.001 565			
			4.008 249				4.001 516			
			6.266 869							
			6.260 742							
			6.260 743							
Micro-Inserts			7.401 744	980-04987	7.401 744	980-04987	7.401 744	980-04987	7.401 744	980-04987
			6.093 247	980-01707	6.093 247	980-01707	6.093 247	980-01707	6.093 247	980-01707
			4.008 196		4.008 196		4.008 196		4.008 196	
Seals	9.003 444		7.615 161		4.008 234		6.291 637	0980-01706	4.008 256	
	4.008 198		4.008 222		4.008 235		9.003 446		6.292 212	
	4.008 200		4.008 224		4.008 237		4.001 555		4.001 544	
			4.008 225						4.008 258	
			4.008 214							
			4.001 521							
			4.008 223							
			4.008 226							
			4.008 215							
			4.008 221							

Shimadzu Headspace Products

	Screw Neck ND 18 (AOC 5000)	Shimadzu Art.-No.	Headspace ND 18 (AOC 5000)	Shimadzu Art.-No.	Headspace ND 18 (HTA200H)	Shimadzu Art.-No.
Vials	9.003 466	980-00247	7.850 009	980-00664	7.050 285	
	4.008 270	961-00915	9.003.453	980-00111	9.003 453	980-00111
Seals	4.008 268	961-00914	7.850 010	961-01256	9.003 460	
	6.241 111	980-01708	6.234 541	980-03372	9.003 434	
			6.229 635	980-00112		
			4.001 548	980-00112		

Autosampler compatibility chart

The autosampler compatibility chart generally shows the most typical LLG-Labware vials and closures for usage on instruments of different manufacturers. Additionally the corresponding part number of the manufacturer is indicated. Beside these there also may be further products in our catalogue which may technically and functionally be suitable. We will gladly recommend other suitable products.

If applicable for a manufacturer, each table has been divided by the application HPLC, GC and Headspace. We generally recommend asking for cost-free samples for testing purposes.

We kindly ask for your understanding that we do not take any guarantee for the correctness nor for the completeness of the data indicated here.

LLG - Vials and autosamplers: compatibility chart

Thermo Scientific

Alternative LLG Labware products for use on Thermo Scientific GC, HPLC and Headspace instruments.

Thermo Scientific GC Products

	Crimp Neck ND 8	Thermo Scientific Art.-No.	Screw Neck ND8	Thermo Scientific Art.-No.	Screw Neck ND9	Thermo Scientific Art.-No.	Crimp Neck ND11	Thermo Scientific Art.-No.
Vials	9.003 427	60180-707	9.003 481	60180-508	9.003 448	60180-723	6.291 635	60180-701
	4.001 554		7.613 087		4.662 800	60180-509	6.290 019	60180-502
	6.235 606		9.003 480	60180-560	4.008 247	60180-724	7.089 998	60180-702
	4.008 206	60180-505	6.290 228		4.662 801	60180-561	6.291 636	
	4.001 515				6.266 869			
	6.902 044				6.260 742			
	4.008 202				6.260 743			
	4.008 203							
Micro-Inserts			7.401 066	60180-265	7.401 744		7.401 744	
			9.003 435		6.093 247	60180-734	6.093 247	60180-734
			4.001 556	60180-721	4.008 196	60180-735	4.008 196	60180-735
			4.008 194	60180-722	4.001 547	60180-266	4.001 547	60180-266
Seals	9.003 443		4.008 209		4.008 228	60180-728	4.001 564	GC PAL
	4.008 200		9.003 484	60180-719	7.615 161	60180-729	9.003 441	
	9.003 444	60180-525	4.008 207		4.008 218		7.060 469	
	4.008 198				4.008 214		6.291 637	60180-705
							9.003 446	60180-706
							7.050 759	

Thermo Scientific HPLC Products

	Crimp Neck ND 8	Thermo Scientific Art.-No.	Screw Neck ND8	Thermo Scientific Art.-No.	Screw Neck ND9	Thermo Scientific Art.-No.	Crimp Neck ND11	Thermo Scientific Art.-No.	Snap Ring ND 11	Thermo Scientific Art.-No.
Vials	4.001 554		9.003 481	60180-508	9.003 448	60180-723	6.291 635		6.073 833	60180-740
			7.613 087		4.662 800	60180-509	6.290 019	60180-502	6.270 176	
	4.008 206	60180-505	9.003 480	60180-560	4.008 247	60180-724	7.089 998		6.270 177	60180-711
	4.001 515		6.290 228		4.662 801	60180-561	6.291 636			
	6.902 044				6.266 869					
	4.008 202				6.260 742					
	4.008 203				6.260 743					
Micro-Inserts			7.401 066	60180-265	7.401 744		7.401 744		7.401 744	
			9.003 435		6.093 247	60180-734	6.093 247	60180-734	6.093 247	60180-734
			4.001 556	60180-721	4.008 196	60180-735	4.008 196	60180-735	4.008 196	60180-735
			4.008 194	60180-722	4.001 547	60180-266	4.001 547	60180-266	4.001 547	60180-266
Seals	9.003 443	60180-708	4.008 209		4.008 228	60180-728	9.003 441		4.008 256	
	4.008 200		9.003 484	60180-719	7.615 161	60180-729	7.060 469		6.242 212	
	9.003 444	60180-525	4.008 207		4.008 218		6.291 637	60180-705	4.001 544	
	4.008 198				4.008 214		9.003 446	60180-706	4.008 258	60180-713
							7.050 759		4.008 261	
									4.008 257	60180-712

Thermo Scientific Headspace Products

	Headspace Screw Neck ND 18 (Combi Pal)	Thermo Scientific Art.-No.	Headspace Crimp Neck ND 20 (Combi Pal)	Thermo Scientific Art.-No.	Headspace Crimp Neck ND 20 (HS850/HS2)	Thermo Scientific Art.-No.
Vials	9.003 466		7.850 009	60180-740	7.850 009	60180-504
	6.290 106		9.003.453	60180-506	9.003 453	60180-506
	4.008 270					
	4.678 396					
Seals	4.008 268		7.850 010		9.003 434	60180-511
	6.241 111		6.234 541	60180-520	9.003 454	60180-513
			6.229 635		4.001 549	60180-513
			4.001 548			

LLG - Vials and autosamplers: compatibility chart

VWR (Merck / Hitachi)

Alternative LLG Labware products for use on VWR (Merck / Hitachi) HPLC instruments.

VWR (Merck / Hitachi) HPLC Products												
	Crimp Neck ND 8	VWR (Merck) Art.-No.	Screw Neck ND8	VWR (Merck) Art.-No.	Screw Neck ND9	VWR (Merck) Art.-No.	Crimp Neck ND11	VWR (Merck) Art.-No.	Snap Ring ND11	VWR (Merck) Art.-No.	Screw Neck ND13	VWR (Merck) Art.-No.
Vials	6.235 606	548-0078	9.003 481	548-0018	9.003 448	548-0028	6.291 635	548-0003	6.073 833	548-0011	9.003 482	548-0051
	4.001 554	548-0080	7.613 087	548-0420	4.662 800	548-0029	6.290 019	548-0004	6.270 176	548-0422	6.267 117	548-0509
			9.003 480	548-0448	4.662 801	548-0030	6.291 636	548-0005	6.270 177	548-0012	9.003 549	548-0052
			6.290 228	548-0019	4.008 249	548-0081	4.008 255	548-1442	4.008 255	548-1442	9.003 549	548-0510
				6.266 869	548-1523							
				6.260 742	548-1524							
				6.260 743	548-1525							
Micro-Inserts			7.401 066	548-0020	7.401 744	548-0006	7.401 744	548-0006	7.401 744	548-0006	7.055 486	548-0093
			9.003 435	548-0308	6.093 247	548-0002	6.093 247	548-0002	6.093 247	548-0002		
			4.001 556	548-0083	4.008 196	548-0001	4.008 196	548-0001	4.008 196	548-0001		
			4.008 194	548-0780								
Seals	9.003 444	548-0040	4.008 209	548-3322	4.008 228	548-0896	6.291 637	548-3272	4.008 258	548-0432	7.510 053	548-0054
	4.008 198	548-0038	9.003 484	548-0024	7.615 161	548-0085	9.003 446	548-0009	4.008 259	548-0434		
			6.232 178	548-0834	4.001 521	548-0088	7.050 759	548-0007				
					4.008 218	548-0087						
				4.008 215	548-0373							

Waters

Alternative LLG Labware products for use on Waters HPLC instruments.

Waters HPLC Products										
	Screw Neck ND9	Waters Art.-No.	Screw Neck ND10	Waters Art.-No.	Snap Ring ND11	Waters Art.-No.	Screw Neck ND13	Waters Art.-No.	Shell Vials ND8	Waters Art.-No.
Vials	9.003 448		6.242 103	WAT063300	6.073 833		9.003 482	186000840	7.300 174	WAT025054C
	4.662 800	186000273	7.615 715		6.270 176	WAT094219	9.003 549	186001135	4.008 205	WAT025053C
	4.662 801	186000848	6.280 951		6.270 177	WAT094220				
	4.008 249				4.008 255					
	4.008 250									
	4.008 252									
	6.266 869									
	6.260 742									
	6.260 743									
	7.401 744		7.401 744		7.401 744		7.055 486	WAT015199		
6.093 247	WAT094170	6.093 247	WAT094170	6.093 247	WAT094170					
4.008 196		4.008 196		4.008 196						
4.008 214	186000274	6.291 637	WAT058874	4.008 258	186000303	7.510 053	186000841			
4.008 215	186000305	9.003 446		6.242 212	186000304					
		7.050 759								

Autosampler compatibility chart

The autosampler compatibility chart generally shows the most typical LLG-Labware vials and closures for usage on instruments of different manufacturers. Additionally the corresponding part number of the manufacturer is indicated. Beside these there also may be further products in our catalogue which may technically and functionally be suitable. We will gladly recommend other suitable products.

If applicable for a manufacturer, each table has been divided by the application HPLC, GC and Headspace. We generally recommend asking for cost-free samples for testing purposes.

We kindly ask for your understanding that we do not take any guarantee for the correctness nor for the completeness of the data indicated here.

14. Chromatography

Vials/Authentic 1:1 size drawings of all vials

LLG - Flasks types

Crimp Neck ND8



4.001 554 6.235 606 9.003 427 4.008 206 4.008 202 4.008 203 4.001 515 6.902 044

Screw Neck ND8, small opening



9.003 481 9.003 480 7.613 087 6.290 288 4.001 563

Screw Neck ND10, wide opening

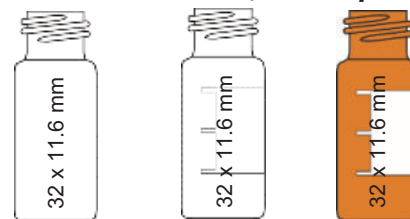

6.242 103 7.615 715 6.280 951

Short Thread ND9

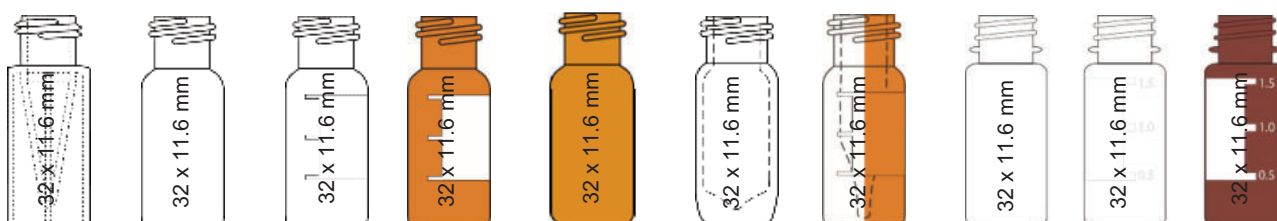

4.008 262 9.003 448 4.662 800 4.662 801 4.008 247 4.008 249 4.008 250
4.008 252 6.266 869 6.260 742 6.260 743

Crimp / Snap Neck ND11



6.291 635 6.290 019 6.291 636 4.001 516 4.001 565 4.008 251
4.008 255 7.085 511 7.089 998

LLG - Flasks types

Micro-Inserts for wide opening

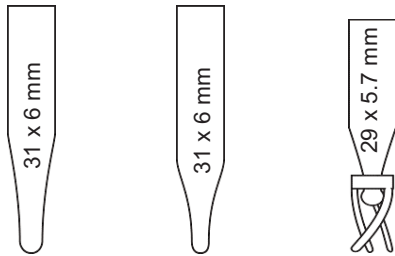

7.401 744 4.001 547 6.093 247

Micro-Inserts for small opening

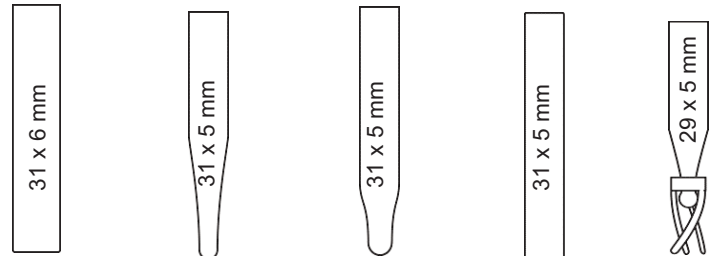

4.008 196 7.401 066 9.003 435 4.008 194 4.001 556

Screw Neck ND13

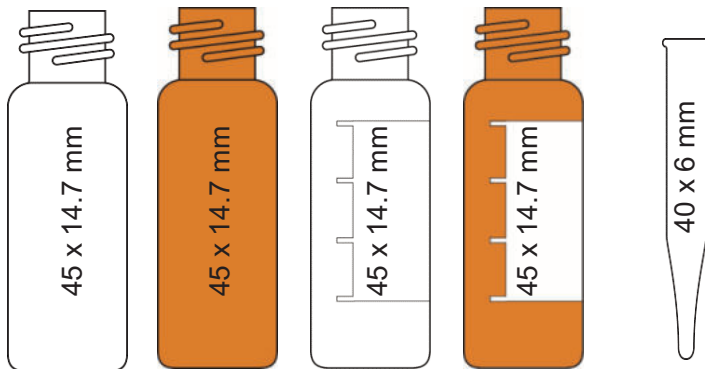

9.003 482 7.058 142 6.267 117 9.003 549 7.055 486

Snap Ring ND11



6.073 833 6.270 176 6.270 177

Shell Vials, 1 ml (Insert)

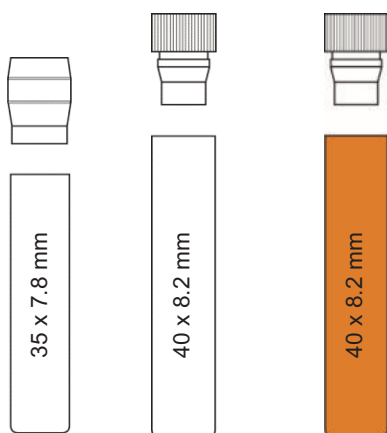

7.612 017 7.300 174 4.008 205

Shell Vials, 2 ml

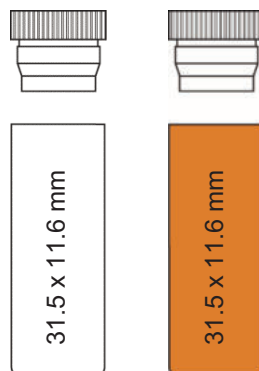

4.008 248 6.226 501

Shell Vials, 4 ml (Insert)

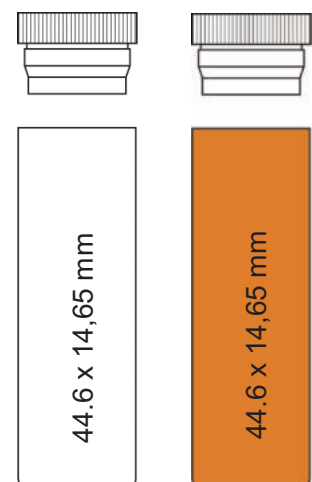

6.280 950 6.227 544

14. Chromatography

Vials/Authentic 1:1 size drawings of all vials

LLG - Flasks types

Storage Vials ND13, ND 15, ND18

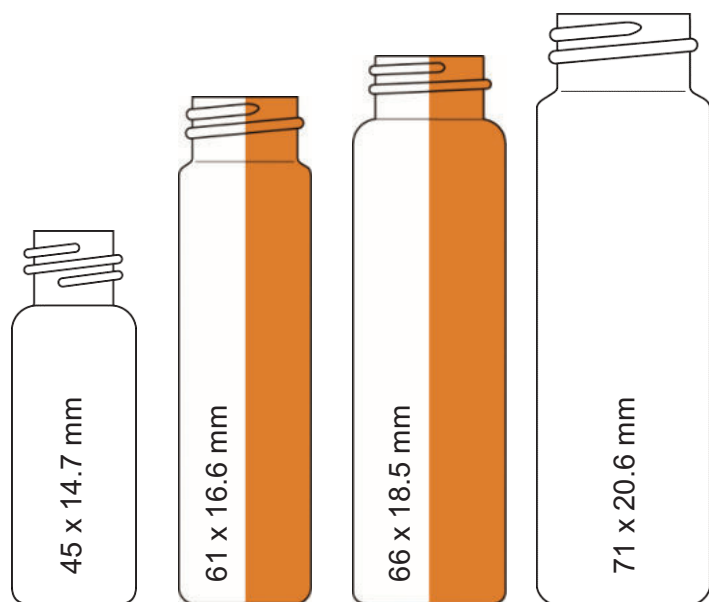

9.003 482 6.280 953 6.280 952 6.280 954

Headspace ND 18

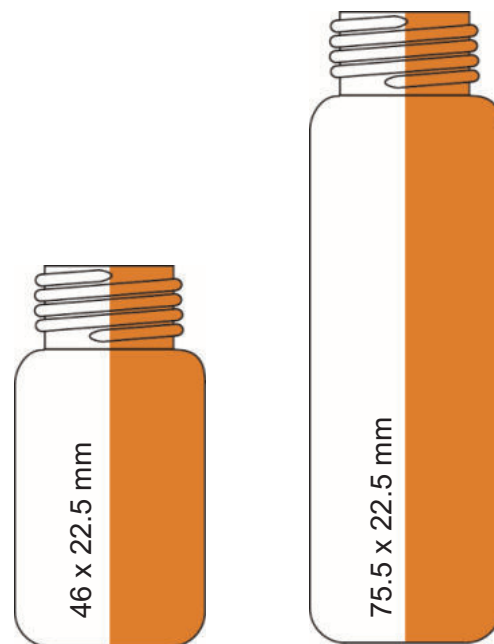

9.003 466 4.008 270
6.227 874 4.678 396

Snap Cap Vials



7.051 404 6.803 717 4.008 282 7.090 616

LLG - Flasks types

Headspace ND 20

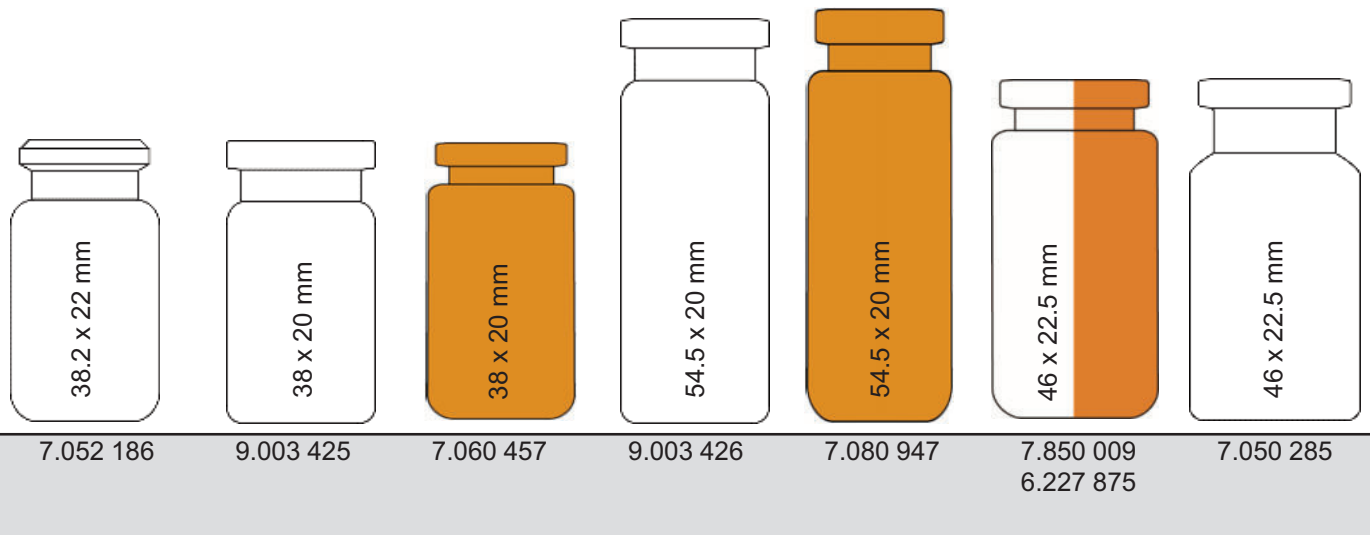

Headspace ND 20

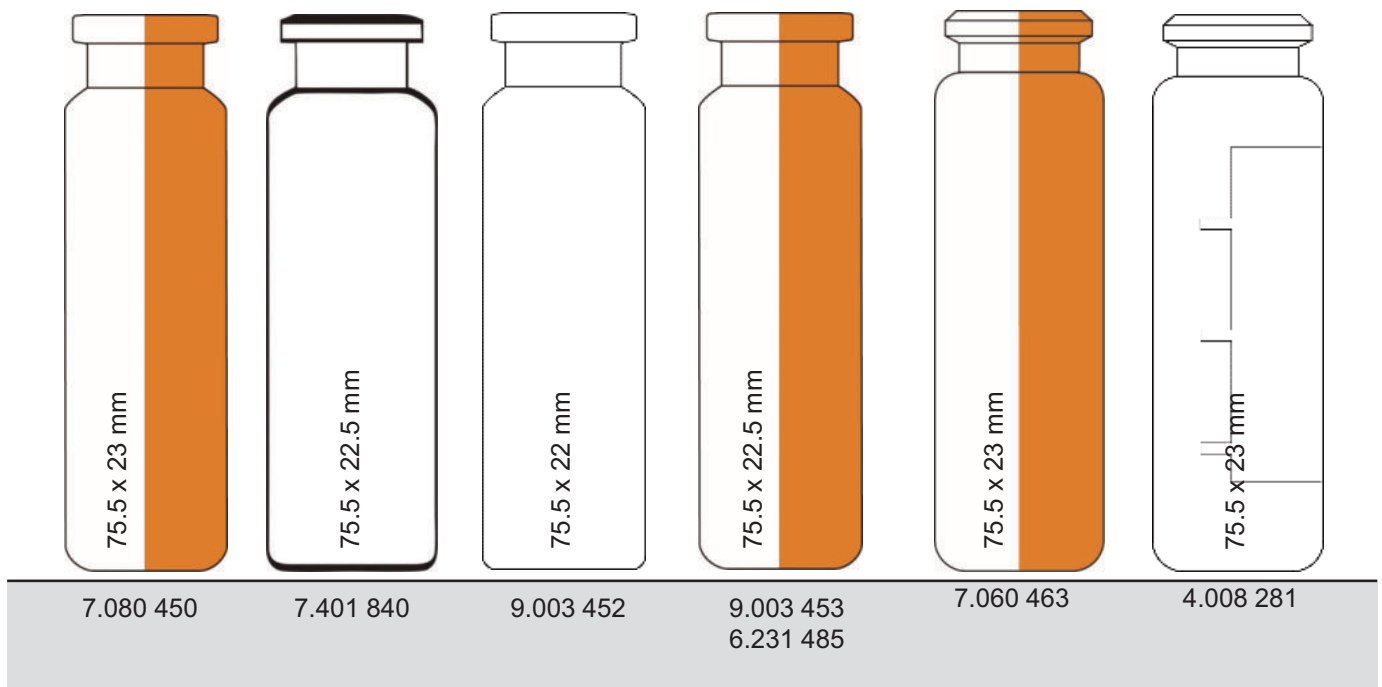

LLG - Flasks types

EPA-Screw Neck Vials ND24

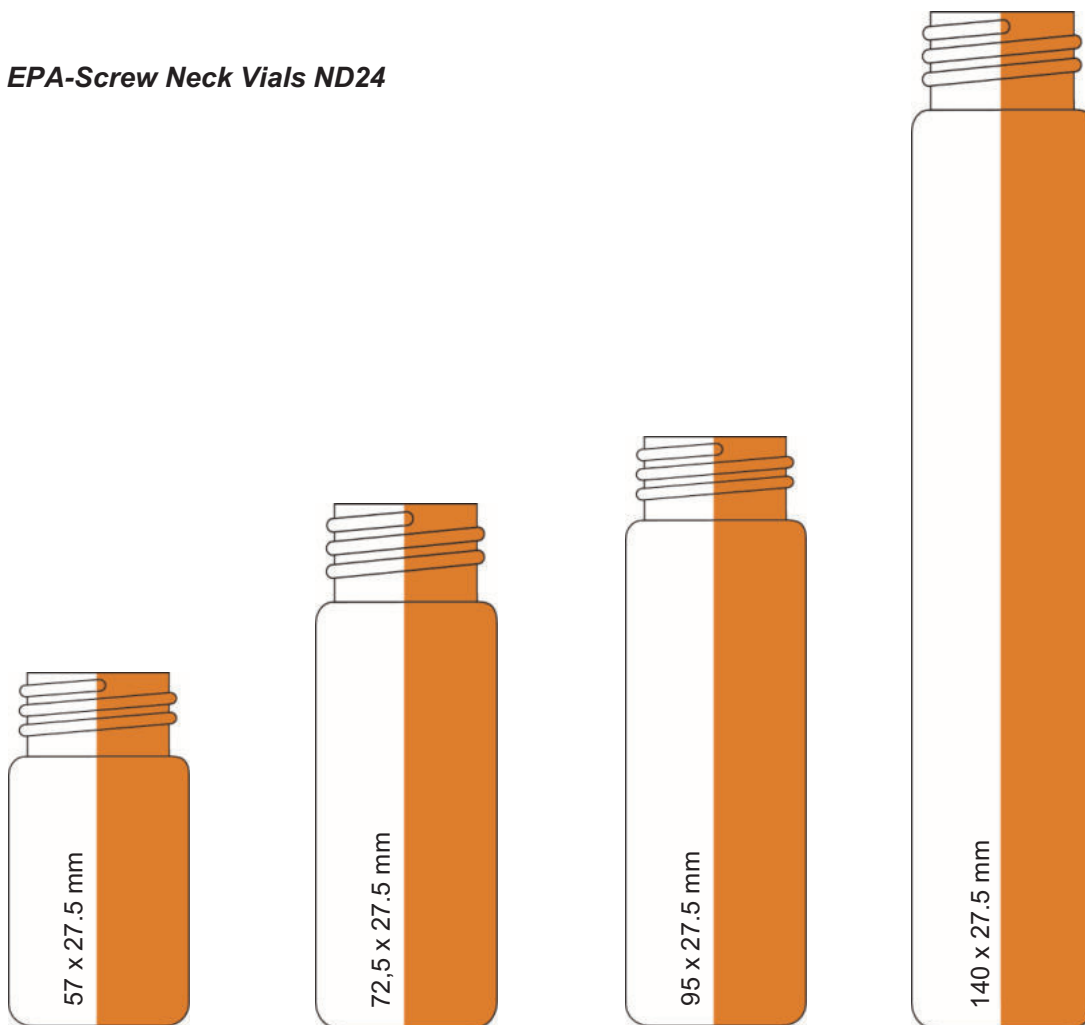

4.008 204 4.008 298	6.267 124 6.267 125	4.008 297 4.008 299	6.267 126 6.267 127
------------------------	------------------------	------------------------	------------------------

Crimp Neck ND 20

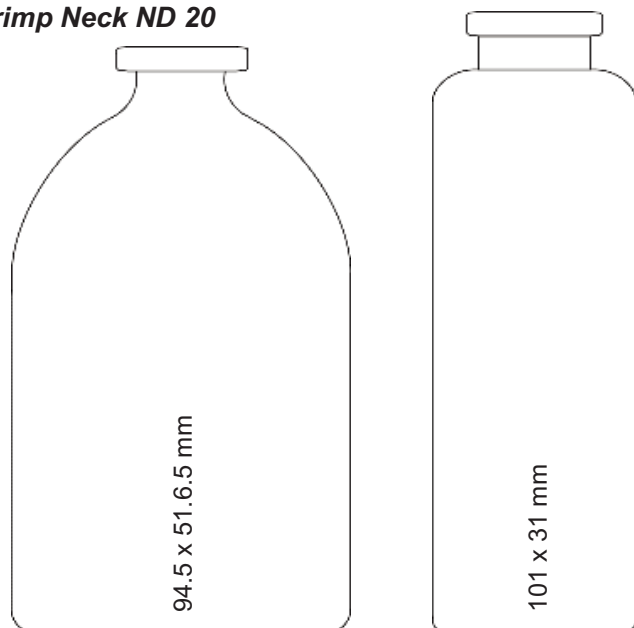

6.231 858	7.060 459
-----------	-----------

LLG - Cap types

Aluminum Crimp Caps, centre hole

				
Size	8 mm	11 mm	13 mm	20 mm
Size centre hole Material Lacquer	4 mm centre hole Aluminum clear	5.5 mm centre hole Aluminum clear, red, blue, green, gold	6 mm centre hole Aluminum clear, red, blue, green, gold	10 mm centre hole Aluminum plain, red, blue, green, gold

Special Aluminum Crimp Caps







						
Size	11 mm	13 mm	13 mm	20 mm	20 mm	20 mm
Type of Cap Material Lacquer Special features	Centre hole Cap Aluminum clear with roll groove	Centre Tear Off Cap Aluminum clear, red, blue, green, gold	Complete Tear Off Cap Aluminum clear, red, blue, green, gold	Centre Tear Off Cap Aluminum clear, red, blue, green, gold	Complete Tear Off Cap Aluminum clear, red, blue, green, gold	Headspace Cap* Aluminum clear

Headspace Cap:* This cap has the function of a pressure release cap and is designed with special scorelines whose bridges break open at an internal vial pressure of 3.0 ± 0.5 bar to let the excess pressure escape. It is comparable with the three component PerkinElmer Headspace Closure (Aluminum Crimp Cap with slits, metal star washer, liner with ears) which offers the same effect with a different technical design.

Magnetic Caps, centre hole

							
Size	9 mm Screw Cap	11 mm Crimp Cap	20 mm Crimp Cap	20 mm Crimp Cap	20 mm Bimetal Crimp Cap	18 mm Screw Cap	18 mm Screw Cap
Size centre hole Application Material Lacquer	6 mm centre hole (GC) PP Screw Cap blue/ magn. overcap gold GC PAL Thermo Scientific TriPlus	5 mm centre hole (GC) magnetic gold GC PAL, Thermo Scientific Tri Plus	5 mm centre hole (HS) magnetic gold CE HS250/500/HS800, CTC 500 Fisons HS250/500 HS800	8 mm centre hole (HS) magnetic Gold CTC Combi PAL	8 mm centre hole (HS) Alu/magnetic red CTC Combi PAL	8 mm centre hole (Universal) (Headspace/SPME) magnetic silver CTC Combi PAL PerkinElmer Agilent G1888A	Closed top Universal Screw Cap silver

PE-Caps for Crimp Necks

						
Size	8 mm	9 mm	11 mm	13 mm	22 mm	22 mm
Approp. Vial Size Cap Size centre hole Material, colour	For Crimp Neck ND8 8 mm with thinned penetration point PE, blue	For Crimp Neck ND8 9 x 5.9 mm 4 mm centre hole PE, transparent	For Crimp Neck and Snap Ring ND11 11 mm with thinned penetration point PE, blue	For Crimp Neck ND11 13 x 7.5 mm 4.5 mm centre hole PE, transparent	For HS Neck ND20 22 x 8.4 mm 4.3 mm centre hole PE, transparent Only for bevelled tops	For Crimp Neck ND20 22 x 9.1 mm 4.3 centre hole or 6 mm centre hole PE, transparent only for flat DIN Crimp Necks!

The drawings of the caps are not actual size. They should only visualize the special features of certain types of caps.

LLG - Cap types

Screw Caps

				
Size	8 mm	9 mm	10 mm	13 mm
Approp. Vial Thread Cap Design Size centre hole Material, colour	Screw Neck Vials ND8 8-425 thread Closed or open top 5.5 mm centre hole PP, black or white	Short Thread Vials ND9 short thread, Closed or open top 6 mm centre hole PP, black, transparent, blue, red, yellow, green	Screw Neck Vials ND10 10-425 thread, Closed or open top 7 mm centre hole PP, black	Screw Neck Vials ND12 13-425 thread, Closed or open top 8.5 mm centre hole PP, black, white
				
Size	15 mm	18 mm	20 mm	24 mm
Approp. Vial Thread Cap Design Size centre hole Material, colour	Screw Neck Vials ND15 15-425 thread, Closed or open top, 9 mm centre hole PP, black, white	Screw Neck Vials ND18 18-400 thread, Closed or open top 12 mm centre hole PP, black	Screw Neck Vials ND20 20-400 thread, Closed or open top, PP, white	Screw Neck Vials ND24 24-400 thread, Closed or open top 12.5 mm centre hole PP, white

PE-Plugs for Shell Vials

						
Size	8 mm	8 mm	8 mm	8 mm	12 mm	15 mm
Vial/Plug combination Plug Size Material, colour Special Features	Plug 6 mm PE, transparent	Plug 8 mm PE, blue	Plug 8 mm PE, transparent with insertion barrier for Micro-Inserts	Plug 8 mm PE, transparent without insertion barrier for Micro-Inserts	Plug 12 mm PE, transparent	Plug 15 mm PE, transparent

Snap Ring Caps

	
Size	11 mm
Approp. Vial Cap Design Size centre hole Material Colour	Snap Ring Vials ND11 open top 6 mm centre hole PE transparent*, blue*, red, yellow, green

Snap Caps







			
Size	18 mm	22 mm	28 mm
Approp. Vial Cap Design Size Cap Material Colour	Snap Cap Vials ND18 closed top 19.8 x 5.2 mm PE transparent	Snap Cap Vials ND22 closed top 23.5 x 5.5 mm PE transparent	Snap Cap Vials ND28 closed top 29.7 x 5.6 mm PE transparent

- available as a hard or soft PE Caps
- Hard Cap: tighter, but not so easy to push on or to remove
- Soft Cap: convenient in handling, but not as tight





The drawings of the caps are not actual size. They should only visualize the special features of certain types of caps.

Product Information – Sample Requests – Price Enquiries?
Our Customer Service Team is always at your disposal for further questions.





LLG-Crimp Neck Micro-Vials ND8

						
Capacity ml	0.2	0.3	0.6	0.6	1.2	1.2
o.d. x Height mm	5.5 x 31.5	5.5 x 31.5	7 x 40	7 x 40	8.2 x 40	8.2 x 40
Colour	clear	clear	clear	amber	clear	amber
Form	conical	round bottom	conical	conical	flat bottom	flat bottom
PK	100	100	100	100	100	100
Cat. No.	6.235 606	4.001 554	4.001 515	6.902 044	4.008 206	6.266 864





LLG-Aluminium Crimp Caps ND8, ready assembled

	Caps	Septa	Hardness	Thickness mm	PK	Cat. No.
	Aluminium, silver, center hole	Natural rubber, red-orange / TEF transparent	60° shore A	1.0	100	9.003 443
	Aluminium, silver, center hole	Red Rubber / PTFE beige	45° shore A	1.0	100	4.008 200
	Aluminium, silver, center hole	Silicone white / PTFE red	45° shore A	1.3	100	9.003 444
	Aluminium, silver, center hole	PTFE red / Silicone white, slit	45° shore A	1.3	100	6.266 865
	Aluminium, silver, center hole	PTFE red / Silicone white / PTFE red	45° shore A	1.0	100	4.008 198









LLG-Screw Neck Vials ND8, small opening

				
Capacity ml	1.5	1.5	1.5	1.1
o.d. x Height mm	11,6 x 32	11,6 x 32	11,6 x 32	11,6 x 32
Colour	clear	amber	amber, labeling field	clear
Form	flat bottom	flat bottom	flat bottom	conical
PK	100	100	100	100
Cat. No.	9.003 481	9.003 480	6.290 228	4.001 563





LLG-Micro-Inserts for Screw Vials ND8, small opening

				
Capacity ml	0.1	0.1	0.1	0.2
o.d. x Height mm	5 x 31	5 x 31	5 x 29	5 x 31
Colour	clear	clear	clear	clear
Form	conical, 15mm tip	conical, 9mm tip	with plastic spring	flat bottom
PK	100	100	100	100
Cat. No.	7.401 066	9.003 435	4.001 556	4.008 194

LLG-PP Screw Seals ND8, ready assembled, and empty Screw Caps ND8

	Caps	Septa	Hardness	Thickness mm	PK	Cat. No.
	black, centre hole	Natural rubber red-orange / TEF transparent	60° shore A	1.3	100	6.266 866
	black, closed	Natural rubber red-orange / TEF transparent	60° shore A	1.3	100	6.266 867
	black, centre hole	Red Rubber / PTFE beige	45° shore A	1.0	100	4.008 209
	black, closed	Red Rubber / PTFE beige	45° shore A	1.0	100	4.008 210
	black, centre hole	Silicone white / PTFE red	45° shore A	1.3	100	9.003 484
	black, centre hole	Silicone white / PTFE red, slit	45° shore A	1.3	100	6.232 178
	black, centre hole	PTFE red / Silicone white / PTFE red	45° shore A	1.0	100	4.008 207
	black, centre hole	no liner	-	-	100	7.060 421
	black, closed	no liner	-	-	100	7.075 960

LLG Septa for Screw Caps ND8

	Septa	Hardness	Thickness mm	PK	Cat. No.
	PTFE virginal, white	53° shore D	0.25	100	7.085 238
	Red Rubber / PTFE beige	45° shore A	1.00	100	4.008 197
	Silicone white / PTFE red	45° shore A	1.30	100	7.060 419
	Silicone white / PTFE blue, slit	55° shore A	0.90	100	7.085 892







1 LLG-2in1 KITS with Screw Neck Vials ND8 (small opening)

2in1 KITS contain 100 vials (1.5 ml) and 100 closures in an orange PP-Box. As both components are always required at the same time, 2in1 KITS are a convenient way to obtain and store all required items for analysis. All advantages of the individual components (cleanroom packaging of the vials, recloseability of the packaging, etc.) remain unchanged.

Any other combination of vial and seal as a 2in1 KIT available.



Type	Description	Capacity ml	Cover type	PK	Cat. No.
2in1 Kit	clear	1.5	Screw Cap, black, hole, Silicon white / PTFE red	100	6.238 965
2in1 Kit	amber	1.5	Screw Cap, black, hole, Silicon white / PTFE red	100	9.003 557
2in1 Kit	amber, labelling field	1.5	Screw Cap, black, hole, Silicon white / PTFE red	100	9.003 558
2in1 Kit	clear, labelling field	1.5	Screw Cap, black, hole, Silicon white / PTFE red	100	9.003 559
3in1 Kit	clear	1.5	Screw Cap, black, hole, Silicon white / PTFE blue, slitted (Septa unassembled)	100	6.223 506

LLG-Short Thread Vials ND9, wide opening





					
Capacity	1.5	1.5	1.5	1.5	1.5
o.d. x Height	11.6 x 32	11.6 x 32	11.6 x 32	11.6 x 32	11.6 x 32
Colour	clear	clear, labelling field flat bottom	amber	amber, labelling field flat bottom	transparent, with filling lines, PE concave bottom
Form	flat bottom	flat bottom	flat bottom	flat bottom	flat bottom
PK	100	100	100	100	100
Cat. No.	9.003 448	4.662 800	4.008 247	4.662 801	6.313 423

LLG-Short Thread Vials economy ND9, wide opening





Hydrolytical class 1, expansion 70.

		
Capacity	1.5	1.5
o.d. x Height	11.6 x 32	11.6 x 32
Colour	clear	amber
Form	flat bottom	flat bottom
PK	1000	1000
Cat. No.	6.273 634	6.273 635

LLG-Short Thread Vials ND9, wide opening, Micro-Vials

					
Capacity	1.1	0.9	0.2	0.2	0.3
o.d. x Height	11.6 x 32	11.6 x 32	11.6 x 32	11.6 x 32	11.6 x 32
Colour	clear	clear	clear	clear	transparent
Form	flat bottom, 15µl funnel in solid glas bottom	flat bottom, 1µl funnel in solid glas bottom	flat bottom with integrated 0.2mL insert	TPX®, flat bottom with integrated 0.2mL insert	PP, with inner cone
PK	100	1000	100	100	100
Cat. No.	4.008 249	7.970 595	4.008 250	6.266 868	4.008 262

Inserts for LLG-Short Thread Vials ND9, wide opening

				
Capacity	0.2	0.1	0.1	0.1
o.d. x Height	6 x 31	6 x 31	6 x 31	5.7 x 29
Colour	clear	clear	clear	clear
Form	flat bottom	conical 15mm tip	conical 12mm tip	with plastic spring
PK	100	100	100	100
Cat. No.	4.008 196	7.401 744	4.001 547	6.093 247

LLG-PP Short Thread Seals ND9, ready assembled



	Caps	Septa	Hardness	Thickness mm	PK	Cat. No.
	transparent, centre hole	Natural rubber, red-orange / TEF transparent	60° shore A	1.00	100	6.266 872
	blue, centre hole	Natural rubber, red-orange / TEF transparent	60° shore A	1.00	100	6.266 883
	transparent, centre hole	Red Rubber / PTFE beige	45° shore A	1.00	100	4.008 229
	blue, centre hole	Red Rubber / PTFE beige	45° shore A	1.00	100	4.008 228
	blue closed	Red Rubber / PTFE beige	45° shore A	1.00	100	4.008 230
	transparent, centre hole	Silicone white / PTFE red	55° shore A	1.00	100	7.076 778
	black, centre hole	Silicone white / PTFE red	55° shore A	1.00	100	4.008 225
	green, centre hole	Silicone white / PTFE red	55° shore A	1.00	100	4.008 224
	blue closed	Silicone white / PTFE red	55° shore A	1.00	100	4.008 227
	transparent, centre hole	Silicone white / PTFE blue, slit	55° shore A	1.00	100	7.200 809
	blue, centre hole	Silicone white / PTFE blue, slit	55° shore A	1.00	100	4.001 521
	black, center hole	Silicone white / PTFE blue, slit	55° shore A	1.00	100	4.008 226
	blue, centre hole	PTFE red / Silicone white / PTFE red	45° shore A	1.00	100	4.008 218
	blue, centre hole	PTFE virginal, white	53° shore D	0.25	100	4.008 221
	blue closed	PTFE virginal, white	53° shore D	0.25	100	7.930 366
	blue, centre hole	PTFE red / Silicone white	45° shore A	1.00	100	6.291 638

LLG-PP UltraBond*Short Thread Seals ND9

	Caps	Septa	Hardness	Thickness mm	PK	Cat. No.
	Ultrabond* Seal blue, center hole	Red Rubber / PTFE beige	45° shore A	1.0	100	4.008 216
	Ultrabond* Seal blue, center hole	Silicone beige / PTFE white	45° shore A	1.3	100	4.008 214
	Ultrabond* Seal blue, center hole	Silicone beige / PTFE white, slit	45° shore A	1.3	100	4.008 215

*Cap+Liner form an inseparable unit, so that the liner cannot be pushed into the vial even with a blunt needle

LLG-Septa for Thread Screw Caps ND9

Septa	Hardness	Thickness mm	PK	Cat. No.
 Silicone white / PTFE red	55° shore A	1.00	100	4.008 212
 PTFE virginal, white	53° shore D	0.25	100	4.008 211

1 LLG-2in1 KITS with Short Thread Vials ND9 (wide opening)

2in1 KITS contain 100 vials (1.5 ml) and 100 closures in an orange PP-Box. As both components are always required at the same time, 2in1 KITS are a convenient way to obtain and store all required items for analysis. All advantages of the individual components (cleanroom packaging of the vials, recloseability of the packaging, etc.) remain unchanged.

Any other combination of vial and seal as a 2in1 KIT available.

1







Description	Cover type	PK	Cat. No.
clear	Short Thread Cap, transparent, hole, natural rubber / PP red-orange	100	7.620 724
clear	Short Thread Cap, blue, hole, Silicon white / PTFE red	100	9.003 560
clear	Short Thread Cap, blue, hole, Silicon white / PTFE blue, slitted	100	7.621 765
clear	Short Thread Cap, black, hole, Silicon white / PTFE blue, slitted	100	4.663 293
clear	Short Thread Cap, transparent, hole, Silicon white / PTFE red	100	9.003 561
clear, labelling field	Short Thread Cap, blue, hole, Silicon white / PTFE blue, slitted	100	9.003 562
clear, labelling field	UltraClean Short Thread Cap, blue, hole, Silicon white / PFE red	100	7.970 892
clear, labelling field	UltraBond Short Thread Cap, blue, hole, Silicon beige / PTFE white, slitted	100	6.266 923
amber, labelling field	UltraBond Short Thread Cap, blue, hole, Silicon beige / PTFE white, slitted	100	9.003 563
amber, labelling field	UltraClean Short Thread Cap, blue, hole, Silicon white / PFE red	100	6.266 871







LLG-Screw Neck Vials ND10, wide opening and Micro-Inserts

Capacity ml	o.d. x Height mm	Colour	Form	PK	Cat. No.
0.1	5.7 x 29	clear	with plastic spring	100	6.093 247
0.1	6 x 31	clear	conical, 15mm tip	100	7.401 744
0.2	6 x 31	clear	flat bottom	100	4.008 196
1.5	11.6 x 32	clear	flat bottom	100	6.242 103
1.5	11.6 x 32	clear, labeling field	flat bottom	100	6.285 536
1.5	11.6 x 32	amber, labeling field	flat bottom	100	6.280 951

LLG-PP Screw Seals ND10



Caps	Septa	Hardness	Thickness mm	PK	Cat. No.
 black, center hole	Natural Rubber red-orange / TEF transparent	60° shore A	1.3	100	6.267 111
 black, closed	Natural Rubber red-orange / TEF transparent	60° shore A	1.3	100	6.267 112
 black, center hole	Silicone white / PTFE red	45° shore A	1.3	100	4.008 235
 black, center hole	Silicone white / PTFE blue, slit	55° shore A	1.5	100	4.008 237
 black, center hole	PTFE red / Silicone white / PTFE red	45° shore A	1.0	100	4.008 236

LLG Crimp Neck Vials ND11, small and wide opening (flat bottom)









						
Capacity	1.5	1.5	1.5	1.5	1.5	1.5
o.d. x Height	11.6 x 32	11.6 x 32	11.6 x 32	11.6 x 32	11.6 x 32	11.6 x 32
Colour	clear	clear	amber	amber	amber, labeling field	clear, labeling field
Form	small opening	wide opening	wide opening	small opening	wide opening	wide opening
PK	100	100	100	100	100	100
Cat. No.	7.085 511	6.291 635	6.263 047	7.089 998	6.291 636	6.290 019

LLG Crimp Neck Vials economy ND11, wide opening





Hydrolytical class 1, expansion 70.

		
Capacity	1.5	1.5
o.d. x Height	11.6 x 32	11.6 x 32
Colour	clear	amber
Form	flat bottom	flat bottom
PK	1000	1000
Cat. No.	6.273 632	6.273 633

LLG-Micro Inserts for Crimp Neck Vials ND11

								
Capacity	0.1	0.1	0.1	0.2	0.1	0.1	0.1	0.2
o.d. x Height	5 x 31	5 x 31	5 x 29	5 x 31	6 x 31	6 x 31	5,7 x 29	6 x 31
Colour	clear	clear	clear	clear	clear	clear	clear	clear
Form	for small opening, conical, 15mm tip	for small opening, conical, 9mm tip	for small opening, with plastic spring	for small opening, flat bottom	for wide opening, conical, 15mm tip	for wide opening, conical, 12mm tip	for wide opening, with plastic spring	for wide opening, flat bottom
PK	100	100	100	100	100	100	100	100
Cat. No.	7.401 066	9.003 435	4.001 556	4.008 194	7.401 744	4.001 547	6.093 247	4.008 196

LLG-Micro Crimp Neck Vials ND11

						
Capacity	1.1	1.1	1.1	1.1	0.3	0.2
o.d. x Height	11,6 x 32	11,6 x 32	11,6 x 32	11,6 x 32	11,6 x 32	11,6 x 32
Colour	clear	clear	clear	amber	clear	amber
Form	flat bottom, 15 µl funnel in solid glass bottom	conical	conical with a round pedestal glass plate	conical with a round pedestal glass plate	flat bottom, integrated 0.3mL insert	flat bottom, with integrated 0.2 mL insert
PK	100	100	100	100	100	100
Cat. No.	4.001 565	4.001 516	4.008 253	4.008 254	4.008 255	4.008 251

LLG-Aluminium Crimp Seals ND11, ready assembled

	Caps	Septa	Hardness	Thickness mm	PK	Cat. No.
	aluminium, silver, centre hole	Natural rubber red-orange / TEF transparent	60° shore A	1.00	100	9.003 441
	aluminium, silver, centre hole	Natural rubber / Butyl red-orange / TEF transparent	45° shore A	1.00	100	7.060 469
	aluminium, green, centre hole	Natural rubber / Butyl red-orange / TEF transparent	45° shore A	1.00	100	4.001 522
	aluminium, blue, centre hole	Natural rubber / Butyl red-orange / TEF transparent	45° shore A	1.00	100	6.900 233
	aluminium, silver, centre hole	Silicone white / PTFE red	45° shore A	1.30	100	9.003 446
	aluminium, silver, centre hole	Silicone white / PTFE blue, cross-slit	55° shore A	1.50	100	4.001 555
	magnetic , gold, centre hole	Silicone white / PTFE red	45° shore A	1.30	100	4.001 564
	aluminium, silver, centre hole	PTFE virginal, white	53° shore D	0.25	100	4.001 559
	aluminium, silver, centre hole	PTFE red / Silicone white / PTFE red	45° shore A	1.00	100	7.050 759
	aluminium, silver, centre hole	Red Rubber / PTFE beige	45° shore A	1.00	100	6.291 637

LLG-Septa for Crimp Caps ND11









	Septa	Hardness	Thickness mm	PK	Cat. No.
	PTFE virginal, white	53° shore D	0.25	100	4.001 535
	Red Rubber / PTFE beige	45° shore A	1.00	100	4.008 238
	Silicone white / PTFE red	45° shore A	1.30	100	7.054 037
	PTFE red / Silicone white / PTFE red	45° shore A	1.00	100	6.801 244

LLG-Snap Ring Vials ND11, wide opening and Micro-Inserts

As an alternative to snap ring seals, snap ring vials and micro-vials ND11 can also be sealed with crimp seals ND11 since the two snap ring lips have the same height as a crimp neck.

Capacity	1.5	1.5	1.5	0.3	0.3	0.1	0.1	0.2	
o.d. x Height	11.6 x 32	11.6 x 32	11.6 x 32	11.6 x 32	11.6 x 32	6 x 31	5.7 x 29	6 x 31	
Colour	clear	clear,	amber,	clear	clear, PP	clear	clear	clear	
Form	flat bottom	flat bottom, labeling field	flat bottom, labeling field	flat bottom, integrated 0.3mL insert	flat bottom, integrated 0.3mL insert	conical, 15mm tip	with plastic spring	flat bottom	
PK	100	100	100	100	100	100	100	100	
Cat. No.	6.073 833	6.270 176	6.270 177	4.008 255	6.267 115	7.401 744	6.093 247	4.008 196	

LLG-PE Snap Ring Seals ND11, ready assembled

	Caps	Septa	Hardness	Thickness mm	PK	Cat. No.
	transparent, PE centre hole	Natural Rubber red-orange / TEF transparent	60° shore A	1.0	100	6.267 116
	transparent, centre hole	Red Rubber / PTFE beige	45° shore A	1.0	100	4.008 261
	blue, centre hole	Red Rubber / PTFE beige	45° shore A	1.0	100	4.008 257
	transparent, centre hole	Silicone white / PTFE red	45° shore A	1.3	100	4.001 544
	transparent, centre hole	Silicone white / PTFE blue, cross-slit	55° shore A	1.0	100	4.008 256
	snap ring cap, blue, centre hole	Silicone white / PTFE blue, cross-slit	55° shore A	1.0	100	6.242 212
	transparent, centre hole	PTFE red / Silicone white / PTFE red	45° shore A	1.0	100	6.073 555
	blue, centre hole	PTFE red / Silicone white / PTFE red	45° shore A	1.0	100	4.008 259
	transparent, PE centre hole	Red Rubber / TEF transparent	60° shore A	1.0	100	6.291 662

1

1 LLG-2in1 KITS with crimp neck vials ND11 (wide opening)

2in1 KITS contain 100 vials (1.5 ml) and 100 closures in an orange PP-Box. As both components are always required at the same time, 2in1 KITS are a convenient way to obtain and store all required items for analysis. All advantages of the individual components (cleanroom packaging of the vials, recloseability of the packaging, etc.) remain unchanged.

Any other combination of vial and seal as a 2in1 KIT available.



Description	Cover type	PK	Cat. No.
clear	Crimp Cap, silver, hole, Natural Rubber red-orange / TEF transparent	100	6.257 139
clear	Crimp Cap, silver, hole, Natural Rubber / Butyl red-orange / TEF transparent	100	9.003 564
clear, labelling field	Crimp Cap, silver, hole, Natural Rubber / Butyl red-orange / TEF transparent	100	9.003 565
amber, labelling field	Crimp Cap, silver, hole, Natural Rubber red-orange / TEF transparent	100	9.003 566
clear	Crimp Cap, silver, hole, Silicon white / PTFE red	100	6.238 979
clear	Crimp Cap, silver, hole, natural rubber red-orange / TEF transparent	100	6.282 841

1 LLG-2in1 KITS with snap ring vials ND11 (wide opening)

2in1 KITS contain 100 vials and 100 closures in an orange PP-Box. As both components are always required at the same time, 2in1 KITS are a convenient way to obtain and store all required items for analysis. 2in1 KITS are available for any type of 1.5 ml (32 x 11.6 mm) with an appropriate seal. All advantages of the individual components (cleanroom packaging of the vials, recloseability of the packaging, etc.) remain unchanged.

Any other combination of vial and seal as a 2in1 KIT available.



Description	Cover type	PK	Cat. No.
clear	Snap caps transparent, hole, Silicon white / PTFE red	100	4.661 002

LLG Crimp neck vials ND13

Capacity	ml	Image	PK	Cat. No.
o.d. x Height	mm		2	
Colour		16 x 32	1000	6.228 969
Form		clear flat bottom		
			4	
		14,7 x 45	1000	9.003 535
		clear flat bottom		







LLG-Aluminium Crimp Seals ND13, ready assembled and empty Crimp Caps ND13

Caps	Septa	Hardness	Thickness mm	PK	Cat. No.
	Pharma-Fix-Septa (Butyl/PTFE)	50° shore A	2	100	7.060 475
	Pharma-Fix-Septa (Butyl/PTFE)	50° shore A	2	1000	6.283 313
	-	-	-	100	6.801 727



LLG-Screw Neck Vials and appropriate Micro-Insert

Capacity	ml	Image	PK	Cat. No.
o.d. x Height	mm		100	9.003 482
Colour		4.0 14,7 x 45 clear	100	6.267 117
Form		flat bottom	100	7.058 142
		clear, labelling field flat bottom	1000	9.003 549
		amber, labelling field flat bottom	100	6.313 424
		PP, transparente	100	7.055 486
		flat bottom		
			100	
		0.3 6 x 40 clear	100	
		conical, metal spring necessary (6.267 118)		



LLG-PP Screw Seals ND13, ready assembled and empty Screw Caps ND13

	Caps	Septa	Hardness	Thickness mm	PK	Cat. No.
	black, centre hole	Red Rubber / PTFE beige	45° shore A	1.0	100	6.242 468
	black, closed top	Red Rubber / PTFE beige	45° shore A	1.0	100	4.008 267
	black, centre hole	Silicone creme / PTFE red	55° shore A	1.5	100	7.510 053
	black, closed top	Silicone creme / PTFE red	55° shore A	1.5	100	6.242 267
	black, centre hole				100	7.071 151
	black, closed top				100	7.060 437
	black, closed top	Butyl red / PTFE grey	55° shore A	1.3	100	4.678 390





LLG-Septa for Screw Caps ND13

	Septa	Hardness	Thickness mm	PK	Cat. No.
	Red Rubber / PTFE beige	45° shore A	1.00	100	4.008 264
	Silicone creme / PTFE red	55° shore A	1.50	100	4.008 263
	PTFE virginal, white	53° shore D	0.25	100	7.058 143





LLG-Screw Neck Vials for Storage Purposes ND 15, ND 18

Capacity o.d. x Height Colour Form	ml mm			
		8 16,6 x 61 clear ND15, flat bottom	12 18,5 x 66 clear ND15, flat bottom	16 20,6 x 71 clear ND18, flat bottom
PK		100	100	100
Cat. No.		6.280 953	6.280 952	6.280 954

LLG-Screw Seals for Screw Neck Vials ND 15, ND 18

	Caps	Septa	Hardness	Thickness mm	PK	Cat. No.
	ND15 cap, black, closed top	Butyl red / PTFE grey	55° shore A	1.6	100	4.678 391
	ND15 cap, black, 9 mm hole	Silicon white/ PTFE red	45° shore A	1.3	100	4.678 392
	ND18 cap, black, 12 mm hole	Butyl red / PTFE grey	55° shore A	1.6	100	6.267 121
	ND18 cap, black, closed top	Butyl red / PTFE grey	55° shore A	1.6	100	6.272 871

LLG-Shell Vials with PE cap (fire-polished neck) ND8, ND12, ND15

					
Capacity	1	1	2	4	4
o.d. x Height	8.2 x 40	8.2 x 40	11.6 x 31.5	14.65 x 44.60	14.65 x 44.60
Colour	clear	amber	clear	clear	PP, transparent
Form	ND8, flat bottom	ND8, flat bottom	ND12, flat bottom	ND15, flat bottom	ND15, flat bottom
PK	100	100	100	100	100
Cat. No.	7.300 174	4.008 205	4.008 248	6.280 950	6.283 263

LLG Plugs, PE

For	PK	Cat. No.
 ND8	100	7.300 175
 ND12	100	4.008 265





Shell Vials, with PE lamella plug



- With 8 mm PE lamella plug, transparent
- Without insertion barrier



		
Capacity	1	1
o.d. x Height	8,2 x 40	8,2 x 40
Colour	clear	amber
PK	100	100
Cat. No.	6.313 421	6.313 422

LLG-Snap Cap Vials ND18 and ND22, without lid

				
Capacity	5	10	15	25
o.d. x Height	20 x 40	22 x 50	26 x 48	26 x 65
Colour	clear	clear	clear	clear
Form	ND18, flat bottom	ND18, flat bottom	ND22, flat bottom	ND22, flat bottom
PK	100	100	100	100
Cat. No.	7.051 404	6.803 717	4.008 282	7.090 616





LLG Snap Caps ND18 and ND22, LDPE

For sealing of snap ring vials.





For	PK	Cat. No.
 ND18	100	6.051 403
 ND22	100	7.090 617

Vials/Vials, Septa

LLG-Headspace-Precision Thread Vials ND18

Capacity o.d. x Height	ml mm				
Colour		clear	amber	clear	amber
Form		rounded bottom	rounded bottom	rounded bottom	rounded bottom
PK		100	100	100	100
Cat. No.		9.003 466	6.290 106	4.008 270	4.678 396

LLG-Magnetic Universal Screw Seals ND18 for Precision Thread Vials ND18

	Caps	Septa	Hardness	Thickness mm	PK	Cat. No.
	silver, center hole	Butyl red / PTFE grey	55° shore A	1.6	100	4.008 269
	silver, center hole	Silicone blue transparent/ PTFE white	45° shore A	1.3	100	6.241 111
	silver, center hole	Silicone white / PTFE blue	55° shore A	1.5	100	4.008 268
	silver, without hole	Butyl red / PTFE grey	55° shore A	1.6	100	6.262 513
	silver, without hole	Silicone white / PTFE red UltraClean	45° shore A	1.3	100	6.267 122

1









1 LLG-Headspace wash kit with crimp neck vials

NEW







The KITs include 25 crimp neck vials (10 ml) with PE snap cap and Silikon/PTFE septum (Y-slitted), in a storage box made of PP.

Type	PK	Cat. No.
LLG-Headspace Wash Kit	25	6.313 420







LLG-Headspace-Vials ND20 (5ml and 10ml)

Capacity o.d. x Height	ml mm								
Colour		clear	amber	clear	clear	clear	amber	clear	clear
Form		flat bottom flat DIN crimp neck	flat bottom flat DIN crimp neck	rounded bottom bevelled HS crimp neck	flat bottom bevelled HS crimp neck	flat bottom flat DIN crimp neck	flat bottom flat DIN crimp neck	flat bottom flat DIN crimp neck	rounded bottom bevelled HS crimp neck
For		Varian	Varian	PerkinElmer	Metrohm	Varian	Varian	DANI, Agilent	CTC, Varian
PK		100	100	100	100	100	100	100	100
Cat. No.		9.003 425	7.060 457	7.052 186	4.008 285	9.003 426	7.080 947	7.050 285	7.850 009



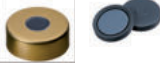



LLG-Headspace-Vials ND20 (20ml and 50 ml)

Capacity	ml							
o.d. x Height	mm	20 23.25 x 75.5	20 23.25 x 75.5	20 22.5 x 75.5	20 22.5 x 75.5	20 23 x 75.5	20 23 x 75.5	50 31 x 101
Colour		clear	amber	clear	clear	clear	clear, with label	clear
Form		flat bottom flat DIN crimp neck	flat bottom flat DIN crimp neck	flat bottom flat DIN crimp neck	rounded bottom flat DIN crimp neck	rounded bottom bevelled HS crimp neck PerkinElmer	rounded bottom bevelled HS crimp neck PerkinElmer	flat bottom flat DIN crimp neck
For				DANI, Agilent	CTC, Varian			
PK		100	100	100	100	100	100	100
Cat. No.		7.401 840	7.080 450	9.003 452	9.003 453	7.060 463	4.008 281	7.060 459

LLG-Crimp Seals ND20, Aluminium, ready assembled

	Caps	Septa	Hardness	Thickness mm	PK	Cat. No.
	silver, center hole	Butyl red / PTFE grey	50° shore A	3.0	100	9.003 454
	silver, center hole	Butyl grey / PTFE grey	50° shore A	3.0	100	4.001 549
	silver, center hole	Pharma-Fix-Septa Butyl/PTFE	50° shore A	3.0	100	9.003 430
	gold, center hole	Pharma-Fix-Septa Butyl/PTFE	50° shore A	3.0	100	4.008 275
	silver, center hole	Silicone blue / PTFE colourless	45° shore A	3.0	100	9.003 434
	silver, center hole	-	-	-	100	7.060 477
	silver, center hole	Silicone white / PTFE beige	45° shore A	3.2	100	9.003 460

LLG-Headspace Seals ND20 (Pressure Release Caps), Aluminium, ready assembled

	Caps	Septa	Hardness	Thickness mm	PK	Cat. No.
	silver, centre hole	Butyl red / PTFE grey	50° shore A	3.0	100	9.003 455
	silver, centre hole	Butyl grey / PTFE grey	50° shore A	3.0	100	4.001 557
	silver, centre hole	Pharma-Fix-Septa Butyl/PTFE	50° shore A	3.0	100	4.008 276
	silver, centre hole	Silicone blue transp. / PTFE transparent	45° shore A	3.0	100	7.050 286
	silver, centre hole	Silicone white / PTFE beige	45° shore A	3.2	100	9.003 456
	silver, centre hole	no liner			100	4.008 271

LLG-Crimp Seals ND20 (Center Tead Off Caps), Aluminium, ready assembled

	Caps	Septa	Hardness	Thickness mm	PK	Cat. No.
	gold	Pharma-Fix-Septa Butyl/PTFE	50° shore A	3	100	9.003 445

Vials/Vials, Septa

1

1



LLG-Crimp Seals ND20 (Center Tead Off Caps), Aluminium, unassembled

Caps	Septa	Hardness	Thickness mm	PK	Cat. No.
silver	Butyl stopper, grey	50° shore A	3	100	6.270 720
silver				100	6.270 721





LLG-Crimp Seals ND20 (Complete Tear Off Caps), Aluminium, ready assembled

Caps	Septa	Hardness	Thickness mm	PK	Cat. No.
 silver	Pharma-Fix-Septa Butyl/PTFE	50° shore A	3	100	7.060 471





LLG-Crimp Seals ND20 (Complete Tear Off Caps), Aluminium, unassembled

Caps	Septa	Hardness	Thickness mm	PK	Cat. No.
 silver	Butyl stopper, grey	37° shore A	3	100	7.060 479
 silver	-	-	-	100	7.056 751







LLG-Bimetal Crimp Seals ND20, ready assembled, magnetic

Caps	Septa	Hardness	Thickness mm	PK	Cat. No.
 red/silver, centre hole	Butyl grey / PTFE grey	50° shore A	3.0	100	9.003 457
 red/silver, centre hole	Silicone blue transp. / PTFE transparent	45° shore A	3.0	100	6.234 541
 red/silver, centre hole	Silicone white / PTFE beige	45° shore A	3.2	100	9.003 458
 red/silver, centre hole (no liner)				100	4.008 272







LLG-Steel Crimp Seals ND20, ready assembled, magnetic

Caps	Septa	Hardness	Thickness mm	PK	Cat. No.
 gold, center hole 8 mm	Butyl red / PTFE grey	50° shore A	3	100	4.001 548
 gold, center hole 8 mm	Butyl grey / PTFE grey	50° shore A	3	100	6.229 635
 gold, center hole 8 mm	Pharma-Fix-Septa Butyl/PTFE	50° shore A	3	100	6.902 419
 gold, center hole 8 mm	Silicone blue transp./ PTFE transparent	45° shore A	3	100	7.850 010
 gold, center hole 8 mm (no liner)				100	7.625 012



LLG-PE Caps ND20, transparent and appropriate Septa

Caps		Septa	Hardness	Thickness mm	PK	Cat. No.
	PE cap, transparent 22.00 x 8.40mm for HS crimp neck 4.3mm centre hole	Natural rubber red- orange/ TEF transparent	60° shore A	1.3	1000	9.003 543
	PE cap, transparent 22.00 x 8.40mm for HS crimp neck 4.3mm centre hole	Butyl red / PTFE grey	55° shore A	1.3	1000	9.003 544
	PE cap, transparent 22.00 x 9.10mm for DIN crimp neck 4.3mm centre hole	Butyl red / PTFE grey	55° shore A	1.3	1000	9.003 545
	height 8.4mm, for HS crimp neck, 4.3mm centre hole (no liner)				100	6.227 768
	height 9.1mm, for DIN crimp neck, 4.3mm centre hole (no liner)				100	7.052 184
		Butyl red / PTFE grey	55° shore A	1.3	100	7.060 425
		Natural rubber red- orange/ TEF transparent	45° shore A	1.3	100	7.051 039

LLG-Septa for Crimp Caps ND20

Septa	Hardness	Thickness mm	PK	Cat. No.
 Butyl red / PTFE grey	50° shore A	3.0	100	7.060 427
 Butyl grey / PTFE grey	50° shore A	3.0	100	4.008 273
 Pharma-Fix- Septa Butyl/PTFE	50° shore A	3.0	100	7.071 063
 Silicone blue transp./ PTFE transparent	45° shore A	3.0	100	4.008 274
 Silicone white / PTFE beige	45° shore A	3.2	100	7.050 202
 Silicone white / Aluminium foil silver	50° shore A	3.0	100	4.001 550

LLG Stoppers ND20

Description	PK	Cat. No.
 butyl grey	100	7.060 433
 Brombutyl, freeze drying stopper	100	6.313 419
 bromine butyl, grey	100	6.313 445

1 LLG-Crimp Neck Vial ND20 for the doping control

100 mL crimp neck vial, 51.6 x 94.5mm, clear, flat bottom, flat DIN crimp neck.









Description	PK	Cat. No.
Vials only	88	6.231 858
Cap	100	7.060 471











14. Chromatography

Vials/Vials, Septa

LLG-Screw Neck Vials ND24 (EPA Vials)

Capacity o.d. x Height Colour Form	ml mm								
		20 27.5 x 57 clear flat bottom	20 27.5 x 57 amber flat bottom	30 27.5 x 72.5 clear flat bottom	30 27.5 x 72.5 amber flat bottom	40 27.5 x 95 clear flat bottom	40 27.5 x 95 amber flat bottom	60 27.5 x 140 clear flat bottom	60 27.5 x 140 amber flat bottom
PK		100	100	100	100	100	100	100	100
Cat. No.		4.008 204	4.008 298	6.267 124	6.267 125	4.008 297	4.008 299	6.267 126	6.267 127

LLG-PP Screw Seals ND24 (UltraBond Seals and ready assembled Seals ND24), PP Screw Caps ND24 (empty) and Septa ND22

	Caps	Septa	Hardness	Thickness mm	PK	Cat. No.
	white, closed	Butyl red / PTFE gray (mounted)	55° shore A	2.5	100	4.678 395
	UltraBond*, white, center hole	Silicone white / PTFE beige	45° shore A	3.2	100	4.008 293
	UltraBond*, white, closed top	Silicone white / PTFE beige	45° shore A	3.2	100	4.008 292
	white, closed	Silicone white / PTFE beige (mounted)	45° shore A	3.2	1000	9.003 541
	white, center hole	no liner			100	4.008 295
	white, closed top	no liner			100	4.008 296
		Silicone white / PTFE beige	45° shore A	3.2	100	4.008 291
		Butyl red / PTFE gray	55° shore A	2.5	1000	9.003 542

*Cap+Liner form an inseparable unit, so that the liner cannot be pushed into the vial even with a blunt needle



LLG-Crimping Tools ND8/ND11/ND13/ND20

Stainless steel crimping Tools ND11, ND13, ND20 for cleanroom use available on request.

1



9.003 471

Description	Size	PK	Cat. No.
Manual crimper for 8 mm aluminium caps	ND8	1	9.003 470
Manual decapper for 8 mm aluminium caps	ND8	1	9.003 511
Manual crimper, height adjustable, for 11 mm aluminium crimp caps	ND11	1	9.003 471
Manual decapper for 11 mm aluminium crimp caps	ND11	1	9.003 367
Manual crimper, height adjustable, for 13 mm aluminium crimp caps	ND13	1	9.003 473
Manual crimper, height adjustable, for 13 mm flip top/flip off caps	ND13	1	4.008 266
Manual decapper for 13 mm aluminium crimp caps	ND13	1	9.003 368
Manual crimper, height adjustable, for 20mm aluminium crimp caps	ND20	1	9.003 475
Manual crimper, height adjustable, for 20mm flip top/flip off caps	ND20	1	4.008 278
Manual decapper for 20mm aluminium crimp caps	ND20	1	9.003 369

2 LLG-Rack for Vials, PP

For all 1.5 and 4 ml vials. For up to 50 vials, blue, stackable.

For vials	Dimensions (W x D x H) mm	PK	Cat. No.
1.5 ml	200 x 105 x 17	1	7.970 861
4.0 ml	230 x 117 x 28	1	6.280 873

2



LLG-Storage Boxes, PP

Suitable for storage in the fridge.

For	Colour	Bottle size	Dimensions (l x w x h)	Array	PK	Cat. No.
		ml	mm			
ND8, 9, 10, 11	blue	1,5 / 2,0	130 x 130 x 45	9 x 9*	1	9.405 750
ND8, 9, 10, 11	orange	1,5 / 2,0	130 x 130 x 45	9 x 9*	1	9.405 751
ND8, 9, 10, 11	yellow	1,5 / 2,0	130 x 130 x 45	9 x 9*	1	9.405 753
ND8, 9, 10, 11	green	1,5 / 2,0	130 x 130 x 45	9 x 9*	1	9.405 754
ND13	red	4,0	130 x 130 x 52	7 x 7*	1	9.405 756
ND20	blue	5 / 10 / 20	130 x 130 x 102	5 x 5	1	4.001 528
ND8, 9, 10, 11	neon-green	1,5 / 2,0	67 x 67	4 x 4	1	9.405 760
ND8, 9, 10, 11	neon-pink	1,5 / 2,0	67 x 67	4 x 4	1	9.405 761
ND8, 9, 10, 11	blue	1,5 / 2,0	67 x 67	4 x 4	1	9.405 762
ND8, 9, 10, 11	transparent	1,5 / 2,0	67 x 67	4 x 4	1	9.405 765

* With alphanumeric coding on the edge and the bottom of each cavity.

3

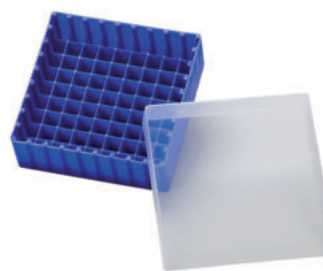

9.405 750

4 Water, ultra pure

Water for a variety of applications in analytical chemistry.
H₂O - LF < 1 µS/cm - 0.4 µm, UV filtered.

NEW

CHEM-LAB n.v.

4



Type	Nominal capacity ml	PK	Cat. No.
Water, ultra pure	5000	1	4.675 028



1 NMR tubes, diameter 3 and 5 mm borosilicate glass 3.3, standard

The NMR tubes are produced with high precision. They are suitable for routine measurements, high-throughput measurements or NMR systems with autosampler at measurement frequencies up to 600 MHz. The tubes are manufactured from borosilicate glass 3.3 which is conform to USP Type I and ASTM E438, Type I, Class A. Please order closing caps separately.

Hilgenberg

Outer diam. mm	Int. diam. mm	Length mm	Wall thickness mm	PK	Cat. No.
2.95 ± 0.03	2.36 ± 0.03	178	0.29	50	6.281 792
2.95 ± 0.03	2.36 ± 0.03	203	0.29	50	6.281 793
4.95 ± 0.05	4.19 ± 0.05	178	0.38	100	9.400 310
4.95 ± 0.05	4.19 ± 0.05	203	0.38	100	9.400 311



2 NMR Tubes, diameter 5 mm, borosilicate glass 3.3, High Precision



The High Precision NMR tubes are manufactured with high accuracy and excellent straightness and concentricity. They are particularly suitable for quantitative measurements and measurements in spectrometers with high measurement frequencies above 600 MHz up to the highest available field strengths above 1 GHz. The tubes are made of borosilicate glass 3.3, which complies with USP Type I and ASTM E438, Type I, Class A requirements. NMR tubes are supplied without caps, please order caps separately.

Hilgenberg

Outer diam. mm	Int. diam. mm	Length mm	Wall thickness mm	PK	Cat. No.
4.97 ± 0.025	4.2 ± 0.025	178	0.385	10	4.672 069
4.97 ± 0.013	4.2 ± 0.013	178	0.385	10	4.672 070



3 NMR tubes, diameter 3 and 5 mm, borosilicate glass 3.3, with UV protection



These tubes coloured by silver ion diffusion are particularly suitable for handling UV-sensitive substances. The tubes are manufactured from borosilicate glass 3.3 which is conform to USP Type I and ASTM E438, Type I, Class A. They are supplied with a green cap.

Hilgenberg

Outer diam. mm	Int. diam. mm	Length mm	Wall thickness mm	PK	Cat. No.
2.95 ± 0.03	2.36 ± 0.03	178	0.29	1	4.672 071
4.95 ± 0.05	4.19 ± 0.05	178	0.38	1	4.672 072



4 NMR Tubes, 5 mm, Wilmad®, High Throughput

Bel-Art Products

The thin-walled high-throughput Wilmad® NMR Tubes have an average camber of 60 microns to guarantee spectral quality for small molecule (MW <250) samples up to 600 MHz. Designed for routine use in most low to mid field NMR spectrometers.

External diameter: 4.947 ± 0.019 mm
 Internal diameter: 4.1 mm
 Wall thickness: 0.43 mm

Type	Length mm	Camber µm	PK	Cat. No.
High Throughput	178	60	100	6.287 509
High Throughput	178	60	50	6.287 510
High Throughput	203	60	100	6.287 511
High Throughput	203	60	50	6.287 512

1 NMR tubes, 5mm, DURAN®, three accuracy classes

NMR tubes are available, according to requirement, in three accuracy classes. The correct tube can be selected depending on magnetic field and spin. The tubes are noteworthy for their close tolerances and accuracy, especially to their straightness, wall thickness and wall thickness distribution. Consequently, quick and accurate test results are achievable.

DWK Life Sciences

Type Economic:

The disposable for economical use in fully automatic sample dispensers or where high throughputs are involved.
- Applicable until 300 MHz

Type Professional:

For professional use in industry and research in the medium and high resolution area of NMR spectroscopy.
- Applicable until 400 MHz

Type Scientific:

For scientific use with high value samples and optimum substance exploitation in the highest resolution range of NMR spectroscopy.
- Applicable until 500 MHz

Please order closing caps separately.



Type	Outer diam. mm	Int. diam. mm	Length mm	PK	Cat. No.
Economic	4,95 +/- 0,05	4,20 +/- 0,05	178	1	7.083 596
Professional	4,97 +/- 0,025	4,20 +/- 0,025	178	1	7.083 595
Scientific	4,97 +/- 0,013	4,20 +/- 0,025	178	1	7.084 720

2 EPR sample tubes, quartz glass

These EPR tubes are manufactured from upmarket quartz glass with only slightest amounts of paramagnetic trace elements. The tubes are delivered single packed and sealed in plastic foil.

Hilgenberg



Outer diam. mm	Int. diam. mm	Wall thickness mm	Length mm	PK	Cat. No.
2.95	2.35	0.30	250	10	6.285 950
3.95	3.35	0.30	250	10	6.285 951
4.95	4.19	0.38	250	10	6.285 952

3 NMR brushes

For cleaning NMR tubes.



DWK Life Sciences



Length mm	PK	Cat. No.
250	5	4.669 337

4 Closing caps for 3 and 5 mm NMR and EPR tubes

The closing caps are made of resilient plastic and are available in two sizes fitting for 3 mm and 5 mm NMR tubes as well as EPR tubes with this respective size. Available in different colours.

Hilgenberg



For	Colour	PK	Cat. No.
3 mm tubes	red	50	6.282 148
3 mm tubes	green	50	6.282 149
3 mm tubes	yellow	50	6.282 150
3 mm tubes	blue	50	6.282 151
5 mm tubes	red	100	9.400 312
5 mm tubes	green	100	9.400 313
5 mm tubes	yellow	100	9.400 314
5 mm tubes	black	100	9.400 315
5 mm tubes	blue	100	9.400 316



1 Septum caps for 5 mm NMR tubes

NEW
Hilgenberg

The septum caps are available with slotted or unslotted septum. This allows the addition of substances into the closed tube for titration experiments without having to open the tube.

Description	PK	Cat. No.
Septum natural rubber red / TEF transparent, 60° shore A 1.3 mm, without slot	100	9.783 365
Septum silicone white / PTFE blue, 55° shore A 0.9 mm, with slot	100	4.672 073



2 NMR Tube Rack, PP



Polypropylene rack with carrying handles features an upper deck with holes and a lower deck support for tube ends. Stackable. For 72 (6 x 12) tubes with 3 or 5mm diameter. Autoclavable.

Type	Dimensions (W x D x H) mm	PK	Cat. No.
NMR Tube Rack	210 x 110 x 220	1	9.301 065

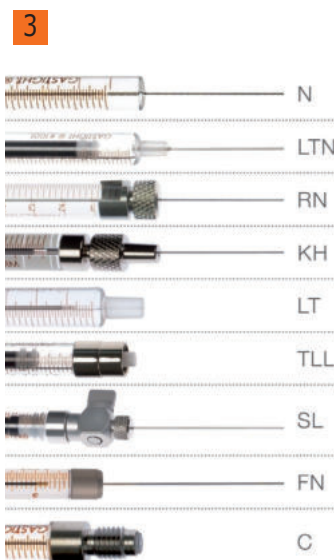

3 Syringe Terminations

N, NR (Cemented Needle, Rheodyne)

Needles are cemented into the glass syringe barrel at a point corresponding to the zero graduation mark. NR stands for syringes with Rheodyne specified needles.

LTN (Luer Tip Cemented Needle)

Needles are cemented into the conical glass luer tip of the barrel at a point corresponding to the zero graduation mark.

SN (Special Needle)

Hamilton offers customized syringes with special needles and state the following details: needle length, gauge, point style, and whether they are electro-tapered. Example of a correct specification: 701 SN, 70mm, gauge 25, point style 3, not electro-tapered. Without these details the corresponding standard syringe 701 N will be supplied.

RN (Removable Needle)

Removable needles sit precisely to the zero graduation mark of the syringe. Allows the use of different specification needles on the same syringe barrel.

KH (Knurled Hub)

Knurled hub is used on 7000 Series syringes. The attachment of a spacer enables repeatable depth injections.

LT (Luer Tip)

Ground glass syringe barrel with a male luer taper accepts most hypodermic needles. Use Kel-F hub needles and connectors for a tight seal.

TLL, TLLX (PTFE Luer-Lock)

Male luer taper with nickel-plated brass hub accepts, and locks in place, luer hub needles and connectors. The X-style plunger stop incorporates a 6-32 UNC female thread on the end of the stop to allow the attachment to drive arm mechanisms, such as on the MicroLab 500 Series diluters/dispensers.

SL (SampleLock)

On/Off syringe valve with RN needle is cemented to a syringe barrel. Used for headspace, environmental sample collection and storage, pre-pressurization of gaseous samples for GC analysis, and sample spiking.

FN (Fixed Needle)

Found on PALSystem C-Line and X-Type autosampler syringes.

C (ChemSeal)

1/4"-28 UNF, male fitting. Used in low volume applications where system dead volumes need to be minimized.

1 Microlitre syringes, Needle Types

Point Style 2 (pst2): 12° bevelled non-coring needle point recommended for septum penetration. Ideal for gas chromatographic applications.

Hamilton

Point Style 3 (pst3): Blunt needle point (90°) for use with HPLC injection valves. Also recommended for applications where exact dosing is required (e.g. thin layer chromatographs).

Point Style 4 (pst4): 10-12° bevelled needle point recommended for life science applications; sharp point for animal injection.

Point Style 5 (pst5): Conical needle with side port for penetration of septa, thin-gauged vinyls and plastics without coring; minimizes septum damage

Point Style AS (pstAS): Special conical style needle point (8° taper) designed to withstand the demands of multiple injections; exclusively used on GC autosampler syringes

1



2 Microlitre syringes, 700 series, with cemented needle (N)

With cemented needle (N, NR). NR stands for syringes with Rheodyne specified needles. Plungers are individually fitted, therefore cannot be interchanged and are not available as replacement parts. Needle length 51 mm.

Hamilton

Type	Capacity µl	Gauge	Point style	PK	Cat. No.
75 N	5	26s	2 (GC)	1	9.221 001
701 N	10	26s	2 (GC)	1	9.221 002
701 N	10	26s	2 (GC)	6	9.221 010
702 N	25	22s	2 (GC)	1	9.221 003
705 N	50	22s	2 (GC)	1	9.221 004
710 N	100	22s	2 (GC)	1	9.221 005
725 N	250	22s	2 (GC)	1	9.221 006
750 N	500	22	2 (GC)	1	9.221 007
75 N	5	26s	3 (HPLC)	1	9.221 011
701 N	10	26s	3 (HPLC)	1	9.221 012
702 NR	25	22s	3 (HPLC)	1	9.221 013
705 NR	50	22s	3 (HPLC)	1	9.221 014
710 NR	100	22s	3 (HPLC)	1	9.221 015
725 NR	250	22	3 (HPLC)	1	9.221 016
750 N	500	22	3 (HPLC)	1	6.055 335
701 N	10	26s	5	1	6.800 518
750 N	500	22	5	1	6.801 651

2



Microlitre syringes, 700 series, for removable needles (RN) or (LT)

With removable needles (RN), or luer tip (LT). Plungers are individually fitted, therefore cannot be interchanged and are not available as replacement parts.

Hamilton

Type	Capacity µl	Gauge	Point style	Needle length mm	PK	Cat. No.
75 RN	5	26s	2 (GC)	51	1	9.221 080
701 RN	10	26s	2 (GC)	51	1	9.221 081 3
701 RN	10	26s	2 (GC)	51	6	6.059 899
702 RN	25	22s	2 (GC)	51	1	9.221 082
705 RN	50	22s	2 (GC)	51	1	9.221 083
710 RN	100	22s	2 (GC)	51	1	9.221 084
725 RN	250	22s	2 (GC)	51	1	9.221 085
750 RN	500	22s	2 (GC)	51	1	9.221 086
701 LT*	10				1	9.221 021 4
702 LT*	25				1	9.221 022
705 LT*	50				1	9.221 023
710 LT*	100				1	9.221 024
725 LT*	250				1	9.221 025
750 LT*	500				1	9.221 026

* Needle - please order separately.

3

4



9.221 081

9.221 021



1 Microlitre syringes, 1700 series, with TLLX and gas tight

NEW

Glass barrel with PTFE-coated plunger and seal, and Luer lock outlet. With 6-32 UNC female thread. Allows attachment to drive arm mechanisms, e.g. Microlab 500 Series diluters/dispensers. Gas-tight microlitre syringe without needle. TLLX= Plunger stop fitted to prevent damage to the PTFE seal. Prevents the plunger tip from reaching the end of the syringe.

Hamilton

Type	Capacity	Grad.	PK	Cat. No.
	μl	μl		
1702 TLLX	25	0,25	1	9.221 300
1705 TLLX	50	0,5	1	9.221 305
1710 TLLX	100	1	1	9.221 310
1725 TLLX	250	2,5	1	9.221 315
1750 TLLX	500	5	1	9.221 320



2 Microlitre syringes, 800 series, with cemented (N) or removable needles (RN)

With metal handle. Plungers are individually fitted, therefore cannot be interchanged and are not available as replacement parts. Cemented needles (N) or removable needle (RN).

Hamilton

Type	Capacity	Gauge	Point style	Needle length	PK	Cat. No.
	μl			mm		
85 N	5	26s	2	51	1	9.221 105
801 N	10	26s	2	51	1	9.221 110
802 N	25	22s	2	51	1	9.221 111
805 N	50	22s	2	51	1	9.221 112
810 N	100	22s	2	51	1	9.221 113
85 RN	5	26s	2	51	1	9.221 115
801 RN	10	26s	2	51	1	9.221 116
802 RN	25	22s	2	51	1	9.221 117
805 RN	50	22s	2	51	1	9.221 118
810 RN	100	22s	2	51	1	9.221 119
825 RN	250	22s	2	51	1	9.221 120
85 RN*	5				1	6.803 384
801 RN*	10				1	6.222 013
810 RN*	100				1	6.231 153
85 RN B/P	5				1	6.232 019
801 RN B/P	10				1	9.221 172

* Needle - please order separately.



3 Microlitre syringes, 1700 series, with removable needle (RN)

NEW

Glass barrel with PTFE-coated plunger. Gas-tight microlitre syringes with removable needle (RN). Gaseous samples can be safely and conveniently transported and stored in sample lock (SL) syringes. Needle length: 51 mm

Hamilton

Type	Capacity	Gauge	Point style	PK	Cat. No.
	μl				
1701 RN	10	26s	2 (GC)	1	9.221 487 3
1702 RN	25	22s	2 (GC)	1	9.221 488
1705 RN	50	22s	2 (GC)	1	9.221 489
1710 RN	100	22s	2 (GC)	1	9.221 490
1725 RN	250	22s	2 (GC)	1	9.221 491
1750 RN	500	22	2 (GC)	1	9.221 492
1702 RNR	25	22s	3 (HPLC)	1	6.090 258
1705 N	50	22s	3 (HPLC)	1	6.070 203
1705 RNR	50	22s	3 (HPLC)	1	6.053 755
1710 N	100	22s	3 (HPLC)	1	6.058 898
1710 RNR	100	22s	3 (HPLC)	1	6.800 114
1725 N	250	22s	3 (HPLC)	1	6.801 772
1725 RNR	250	22	3 (HPLC)	1	7.200 577
1750 RNR	500	22	3 (HPLC)	1	6.077 387



4 Microlitre syringes, 1000 series, with cemented needle (N)

With PTFE plunger seal. Gastight microlitre syringes with cemented-in needles (N). Needle length: 51 mm

Hamilton

Type	Capacity	Gauge	Point style	PK	Cat. No.
	μl				
1001 LTN	1000	22	3 (HPLC)	1	6.800 149
1001 LTN	1000	22	2 (GC)	1	9.221 470 4
1002 LTN	2500	22	2 (GC)	1	9.221 475
1005 LTN	5000	22	3 (HPLC)	1	7.631 831
1005 LTN	5000	22	2 (GC)	1	9.221 480
1005/RN	5000	22	2 (GC)	1	9.221 495
1010 LTN	10000	22	2 (GC)	1	9.221 485

Microlitre syringes, 1700 series, with cemented needle (N)



1

With PTFE plunger seal. Gastight microlitre syringes with cemented-in needles (N).
Needle length: 51 mm

Hamilton

Type	Capacity µl	Gauge	Point style	PK	Cat. No.
1701 N	10	26s	2 (GC)	1	9.221 448 1
1702 N	25	22s	3 (HPLC)	1	6.083 932
1702 N	25	22s	5	1	7.630 609
1702 N	25	22s	2 (GC)	1	9.221 449
1705 N	50	22s	2 (GC)	1	9.221 450
1710 N	100	22s	2 (GC)	1	9.221 455
1725 N	250	22s	2 (GC)	1	9.221 460
1750 LTN	500	22	2 (GC)	1	9.221 465



9.221 448

2 Microlitre syringes, 7000 series

2

The end of the plunger has a tungsten wire extension that fits the entire length of the needle all the way to the tip, resulting in a zero dead volume syringe.

Hamilton

Type	Capacity µl	Gauge	Point style	Needle length mm	PK	Cat. No.
7000.5 KH	0.5	25	2	70	1	6.700 111
7001 KH	1.0	25	2	70	1	9.221 121
7101 KH	1.0	22	2	70	1	6.802 391
7002 KH	2.0	25	2	70	1	6.204 624
7102 KH	2.0	23	2	70	1	6.801 037
7105 KH	5.0	24	2	70	1	9.221 125
7000.50C KH	0.5	32	3	100	1	9.221 590
7000.5 KH	0.5	25	3	70	1	9.221 126
7001 KH	1.0	25	3	70	1	6.802 598
7101 KH	1.0	22	3	70	1	9.221 131
7002 KH	2.0	25	3	70	1	9.221 122
7102 KH	2.0	23	3	70	1	9.221 132
7105 KH	5.0	24	3	70	1	6.050 160



3 Microlitre syringes Neuros™

3

Hamilton Neuros™ syringe technology provides unprecedented functionality for controlled injections e.g. of tissues and animals. An industry first, the Neuros™ accurately dispenses 50 nL to 100 µL of liquid through an ultrafine needle protected by a custom-designed sleeve. Developed specifically for the neurosciences, the Neuros minimizes injection site damage by increasing needle rigidity and delivering a microvolume of liquid to an exact location.

Hamilton

- Adjustable needle exposure of 0 to 20 mm
- Almost no dead volume
- Needle rigidity improves insertion path accuracy
- Minimal tissue damage reduces injection variability
- Reduced sample loss saves money and materials
- Fine gauge needle creates smaller injection sites
- Compatibility with most infusion pumps and stereotaxic holders means an easy integration into existing processes
- Also available as beveled 12° point (point style 4)

Needle length: 0 to 20 mm

Type	Capacity µl	Point style	Gauge	PK	Cat. No.
NRS7000.5 KH	0.5	3 (HPLC)	32	1	6.287 163
NRS7001 KH	1	3 (HPLC)	32	1	7.671 735
NRS7002 KH	2	3 (HPLC)	30	1	6.287 164
NRS75 RN	5	3 (HPLC)	33	1	7.642 505
NRS1701 RN*	10	3 (HPLC)	33	1	6.258 819
NRS1702 RN*	25	3 (HPLC)	33	1	6.287 165
NRS1705 RN*	50	3 (HPLC)	33	1	6.287 166
NRS1710 RN*	100	3 (HPLC)	33	1	6.287 167

*gastight syringes



➔ Microlitre syringes for GC-autosamplers please see page 1493.



9.221 002

Microlitre syringes for GC-autosamplers A

With cemented needle (N) for GC-autosamplers Agilent 7670 A, 7671 A, 7672 A.
With fixed needle (FN) for CTC GC PAL system autosamplers.

Hamilton

Syringe types with Special needle (SN) available on request.
Needle length: 51 mm

Type	Capacity µl	Gauge	Point style	PK	Cat. No.
1701 N	10.0	26s	2 (GC)	1	9.221 448
701 N	10.0	26s	2 (GC)	1	9.221 002 1
75 FN CTC	5.0	26s	AS	1	6.304 828
701 FN CTC	10.0	26s	2 (GC)	1	6.301 578
701 FN CTC	10.0	26s	AS	1	6.303 229
7701.2 CTC	1.2	26s	AS	1	6.900 991
1702 FN CTC Slim Line*	25.0	26s	AS	1	9.221 040
1702 FN CTC	25.0	26s	AS	1	6.239 337
1710 FN CTC	100.0	26s	AS	1	6.206 124
1725 FN CTC	250.0	26s	AS	1	6.239 360 2
1750 FN CTC	500.0	26s	AS	1	9.221 041

*Slim Line=Glass barrel outer diameter 6.6 mm



6.239 360



7.636 288

Microlitre Syringe for GC-Autosampler

With cemented-in needles (N) for autosamplers Agilent 7673 - 7683, 6850 ALS and with fixed needle (FN) for CTC GC PAL instruments.

Hamilton

Syringe types with special needle (SN) available on request.

Type	Capacity µl	Needle length mm	Gauge	Point style	PK	Cat. No.
701 FN CTC	10	51	23s	2 (GC)	1	9.221 063
701 FN CTC	10	51	23s	AS	1	7.636 288 3
701 N	10	43	23s	AS	1	9.221 196 4
701 N	10	43	23s	AS	6	6.050 224
701 N	10	43	26s	AS	1	6.090 815
701 N	10	43	26s	AS	6	6.072 828



9.221 196



5

5 6 GC-Syringes PAL Headspace®

HD syringe: High Dynamic plunger has been optimised for higher throughput in the headspace technique.
Novel metal spring allows working with enhanced tightness over a large temperature range. Which results in increased accuracy and reproducibility of your headspace GC analysis.

Hamilton

HDHT syringe: Unique cement-free snap-on connection. The syringe is chemically inert and temperature stable up to 200 °C which broadens the range of possible applications.

Type	Capacity µl	Gauge	Point style	PK	Cat. No.
1001 HD	1000	23	5	1	6.200 515
1001 HDHT	1000	23	5	1	6.287 990
1001 HD	1000	26	5	1	6.303 926
1002 HD	2500	23	5	1	6.201 089
1002 HD	2500	26	5	1	6.801 137
1002 HDHT	2500	23	5	1	7.910 699



6



7

7 Microlitre syringe X-Type for PAL autosamplers

With deactivated needle and glass barrel for inert liquid path and enhanced lifetime.
Near zero carryover.

Hamilton

Needle length: 51 mm

Type	Capacity µl	Gauge	Point style	PK	Cat. No.
1702	25	22s	3 (HPLC)	1	6.256 766
1705	50	22s	3 (HPLC)	1	9.221 061
1710	100	22	3 (HPLC)	1	9.221 062
1710	100	22s	3 (HPLC)	1	6.260 430

1 2 LLG-Glass-Syringes, borosilicate glass

With brown graduations. Sterilisable up to 134 °C.

Capacity ml	Material Cone	Nozzle type	PK	Cat. No.
1	Glass	Luer-Slip	1	6.272 088
2	Glass	Luer-Slip	1	6.272 089
5	Glass	Luer-Slip	1	6.272 090
10	Glass	Luer-Slip	1	6.272 091
20	Glass	Luer-Slip	1	6.272 092
50	Glass	Luer-Slip	1	6.272 093
1	Metal	Luer-Lock	1	6.272 094
2	Metal	Luer-Lock	1	6.272 095
5	Metal	Luer-Lock	1	6.272 096
10	Metal	Luer-Lock	1	6.272 097
20	Metal	Luer-Lock	1	6.272 098
50	Metal	Luer-Lock	1	6.272 099



3 All-glass syringes Dosys™, borosilicate glass 3.3



Socorex

The reusable borosilicate glass syringes offer superior chemical and heat shock resistance. A precious, low cost alternative to disposable plastic syringes, complementing the self-refilling models in many applications.

- Precision-machined plunger and barrel,
- Excellent fitting and liquid tightness (not gas tight)
- Permanent, high visibility graduations
- Autoclavable at 121 °C/250 °F

Capacity ml	Grad. ml	Material Cone	Nozzle type	PK	Cat. No.
0.1 - 1	0.05	Glass	Luer	3	6.253 931
0.2 - 5	0.2	Glass	Luer	3	6.261 028
1 - 10	0.2	Glass	Luer	3	6.261 029
1 - 20	1	Glass	Luer	2	6.235 425
1 - 30	2	Glass	Luer	2	7.658 119
10 - 100	10	Glass	Luer	1	6.254 727
0.1 - 1	0.05	Metal	Luer-Lock	3	6.902 600
0.5 - 2	0.1	Metal	Luer-Lock	3	6.902 601
0.2 - 5	0.2	Metal	Luer-Lock	3	6.902 602
1 - 10	0.2	Metal	Luer-Lock	3	6.902 603
1 - 20	1	Metal	Luer-Lock	2	6.902 604
1 - 30	2	Metal	Luer-Lock	2	7.658 120
1 - 50	2	Metal	Luer-Lock	1	6.902 605
10 - 100	10	Metal	Luer-Lock	1	6.241 758
10 - 150	10	Metal	Luer-Lock	1	6.261 030
10 - 200	10	Metal	Luer-Lock	1	6.261 031
10 - 250	10	Metal	Luer-Lock	1	6.241 759



Syringes, FORTUNA OPTIMA®, Glass



Poulsen & Graf

Made of soda lime glass. With centre glass or metal luer nozzle (Luer or Luer-Lock). Only plungers and barrels with identical lot numbers are interchangeable (between identical capacity syringes). Autoclavable up to +134 °C. The amber graduation is acid and alkali resistant. Only for technical purposes.

Capacity ml	Material Cone	Nozzle type	PK	Cat. No.
1	Metal	Luer-Lock	1	9.222 061
2	Metal	Luer-Lock	1	9.222 062
5	Metal	Luer-Lock	1	9.222 065
10	Metal	Luer-Lock	1	9.222 070 4
20	Metal	Luer-Lock	1	9.222 072
50	Metal	Luer-Lock	1	9.222 075
1	Glass	Luer	1	9.222 021
2	Glass	Luer	1	9.222 022
5	Glass	Luer	1	9.222 025
10	Glass	Luer	1	9.222 030
20	Glass	Luer	1	9.222 032 5
50	Glass	Luer	1	9.222 035



9.222 070



9.222 032

1

1 LLG-Disposable syringes, 3-parts, PP, non-sterile, bulk

- Barrel: PP, Plunger: PP and Polyisoprene rubber
- Smooth flow, tight, high transparency barrel
- Latex-free, pyrogen-free, DEHP-free, non-toxic
- Defined safety stop to avoid accidental pull-out of plunger
- Suitable for all syringe filters with Luer connection
- Non-sterile, bulk packed in box of 500
- Luer-Lock according to DIN EN 1707
- Luer-Slip according to DIN EN 20594-1

Capacity ml	Nozzle type	PK	Cat. No.
2	Luer-Slip	500	6.267 267
5	Luer-Slip	500	6.267 268
10	Luer-Slip	500	6.267 269
20	Luer-Slip	500	6.267 270
2	Luer-Lock	500	6.286 616
5	Luer-Lock	500	6.286 617
10	Luer-Lock	500	6.286 618
20	Luer-Lock	500	6.286 619

2

4.665 978

Disposable Syringes HSW NORM-JECT®, 2-part, sterile

 Disposable syringes HSW NORM-JECT® with PP barrel, and PE piston.
Luer or Luer-Lock nozzle.

B. Braun Melsungen

- Smooth flow, tight, high transparency barrel
- No rubber, styrene or DEHP, latex- and silicone-oil-free
- Sterile, individually blister strip packed
- Defined position of the plunger at volume "0" to feel when plunger is completely inserted
- According to ISO 7886-1
- Defined safety stop to avoid accidental pull-out of plunger

3

4.665 915

Capacity ml	Nozzle type	PK	Cat. No.
1	Luer-Slip	100	4.665 985
2	Luer-Slip	100	4.665 978 2
5	Luer-Slip	100	4.665 979
10	Luer-Slip	100	4.665 986
20	Luer-Slip	100	4.665 952
2	Luer-Lock	100	4.665 915 3
5	Luer-Lock	100	4.665 947
10	Luer-Lock	100	4.665 916
20 (24)	Luer-Lock	100	4.665 917

4

4 Disposable Syringes HSW HENKE-JECT®, 2-part, non-sterile

Disposable syringes with PP barrel, and PE piston. Luer-Slip or Luer-Lock nozzle.

Henke-Sass Wolf

- Wipe-resistant scale
- Transparent cylinder
- Pyrogen-free, non-toxic and PVC-free

Capacity ml	Nozzle type	PK	Cat. No.
1	Luer-Slip	100	4.669 386
5	Luer-Slip	100	4.669 387
2	Luer-Slip	100	4.669 388
10	Luer-Slip	100	4.669 389
20	Luer-Slip	100	4.669 390
30	Luer-Slip	50	4.669 391
50	Luer-Slip	30	4.669 392
2	Luer-Lock	100	4.669 393
5	Luer-Lock	100	4.669 394
10	Luer-Lock	100	4.669 395
20	Luer-Lock	100	4.669 396
30	Luer-Lock	50	4.669 397
50	Luer-Lock	30	4.669 398

1 Disposable Syringes HSW HENKE-JECT®, 2-part, sterile

Disposable syringes with PP barrel, and PE piston. Luer-Slip or Luer-Lock nozzle.

Henke-Sass Wolf

- Sterile, individually blister strip packed
- Wipe-resistant scale
- Transparent cylinder
- Pyrogen-free, non-toxic and PVC-free

Capacity ml	Nozzle type	PK	Cat. No.
30	Luer-Slip	50	9.410 025
50	Luer-Slip	30	9.410 050
30	Luer-Lock	50	6.250 019
50	Luer-Lock	30	6.286 307



2 Disposable syringes SOFT-JECT®, 3-part, sterile

- Barrel: PP, Plunger: PP and polyisoprene rubber
- Luer tip
- Smooth flow, tight, high transparency barrel
- Safe plunger backstop
- Latex free, pyrogen-free, DEHP free, non-toxic
- Sterile, individually blister strip packed
- According to ISO 7886-1

B.Braun Melsungen

Capacity ml	Nozzle type	PK	Cat. No.
1	Luer	100	4.665 988
3	Luer	100	4.665 990
5	Luer	100	4.665 991
10	Luer	100	4.665 953
20	Luer	100	4.665 981



3 Syringes BD Discardit™ II, disposable, 2-piece, PP/PE, sterile

Clear barrel for perfect visualisation of syringe contents.

Becton Dickinson

- 2-piece syringes with Luer-Tip
 - Smooth plunger movement, reduced sliding force
 - Retaining ring: prevents accidental plunger rod withdrawal
 - Leak-tight: Tested in compliance with ISO 7886-1
 - Scale marking: accurate graduation suited to user's needs
 - Design of finger grip flanges ensure stability and comfort during injection
 - Ergonomically designed plunger for single-handed operation
 - Barrel material: Polypropylene
 - Plunger material: Polyethylene
 - Plunger lubricant: Oleamide
 - Colour-coded packing units
 - Sterilization method: Ethylene oxide
 - Silicone oil-free
 - Sterile single packing, single use, latex-free, PVC-free
- For pressure applications we recommend three-part syringes.

Capacity ml	Nozzle type	Grad. ml	PK	Cat. No.
2	concentric	0.1	100	6.052 153
5	eccentric	0.2	100	7.619 784
10	eccentric	0.5	100	9.410 403
20	eccentric	1.0	80	6.052 157



4 Disposable syringes, 3-piece, PP, sterile

3-part: cylinder, piston and separate seal. With Luer nozzle. Without needle. Supplied sterile, individually pouch-sealed in outer boxes.

Volume ml	Nozzle type	Grad. ml	Description	PK	Cat. No.
30	eccentric	1.00	with Luer nozzle	60	9.410 431
50/60	eccentric	1.00	with Luer nozzle	60	9.950 301
50/60	centric	1.00	with BD Luer-Lok™ nozzle	60	6.050 099
50/60	centric	1.00	-	60	6.305 235
100	centric	2.00	Luer adapter	50	6.287 774
10	centric	0.50	-	100	6.050 096
2	centric	-	with Luer nozzle	100	6.274 591
1	centric	0.01	TBC, Luer	120	6.280 595



1



1 2 Disposable Syringes Omnifix® Solo, 3-piece

- Material: Polypropylene, Plunger backstop: Polyisoprene
- Plunger backstop with smooth double sealing ring for slow aspiration and injection of small sample quantities
- Highly transparent barrel with black graduations (in ml) for ideal readability, permanent marking
- Safe plunger backstop for easy aspiration to the maximum volume
- Inside siliconized
- Luer Slip to put on the needle, centric or eccentric or Luer Lock conus, centric
- Latex- and PVC-free
- Sterile, single packed
- Manufactured according to EN ISO 7886-1

B. Braun Deutschland

2



Capacity ml	Nozzle type	Grad. ml	PK	Cat. No.
3	Luer slip, centric	0.1	100	6.238 513
5	Luer slip, eccentric	0.2	100	6.301 853
10	Luer slip, eccentric	0.5	100	7.079 506
20	Luer slip, eccentric	1.0	100	6.084 306
30	Luer slip, eccentric	1.0	100	6.303 643
50	Luer slip, eccentric	1.0	100	4.665 914
3	Luer lock, centric	0.1	100	6.238 514
5	Luer lock, centric	0.2	100	6.081 232
10	Luer lock, centric	0.5	100	6.085 753
20	Luer lock, centric	1.0	100	6.083 393
30	Luer lock, centric	1.0	100	6.300 903
50	Luer lock, centric	1.0	100	4.665 943

3



3 Disposable needles, PP/Stainless steel, sterile

With Luer push-on fitting for use with disposable syringes.
Supplied sterile in boxes of 100. Colour-coded.

Diam. mm	Length mm	Gauge	Colour	PK	Cat. No.
0.8	40	21 x 1 1/2"***	green	100	9.950 305
0.6	25	23 x 1"	blue	100	9.950 306
0.5	16	25 x 5/8"	orange	100	9.950 307
0.9	25	20 x 1"***	yellow	100	9.950 304
1.1	40	19 x 1 1/2"	ivory	100	9.950 303
1.2	40	18 x 1 1/2"*	pink	100	9.950 302

* is a thin wall needle with a short bevel.
**are intravenous thin wall needles.

4



4 Disposable needles Sterican® for neural therapy

- Thin-walled needles, made of stainless, chromium-nickel steel, with smooth surface with light silicone coating
- Minimal pain upon puncture
- Transparent Luer-Lock plastic hub, made of Polypropylene (needle hub), color-coded hub conforms to ISO 6009

B. Braun Deutschland

Gauge	Diam. mm	Length mm	Colour	PK	Cat. No.
21 x 4 3/4"	0.8	120	green	100	6.200 419
23 x 2 3/8"	0.6	60	blue	100	6.053 289
23 x 3 1/8"	0.6	80	blue	100	7.200 183

5



5 Single-use hypodermic needles, Sterican®

- In accordance with ISO 7864 and DIN 13097
- Thin-walled needles
- Made of stainless, chromium-nickel steel
- Smooth surface with light silicone coating
- Minimal pain upon puncture
- Transparent Luer-Lock plastic hub
- Made of Polypropylene (needle hub)
- Box of 100 pieces

B. Braun Deutschland

Gauge	Diam. mm	Colour	Length mm	PK	Cat. No.
20 x 1 1/2"	0.90	yellow	40	100	6.080 870
21 x 1 1/2"	0.80	green	40	100	6.076 221
22 x 1 1/4"	0.70	black	30	100	6.076 115
23 x 1 1/4"	0.60	blue	30	100	7.079 505
23 x 1"	0.60	blue	25	100	6.202 748
24 x 1"	0.55	purple	25	100	6.070 095
26 x 1"	0.45	brown	25	100	6.078 182
27 x 3/4"	0.40	grey	20	100	6.071 758

1 Empty columns CHROMABOND®, PP

Empty CHROMABOND® column (PP) for SPE, one PE-filter element is already inserted in the column.

MACHERY-NAGEL

Capacity ml	PK	Cat. No.
1	100	4.003 522
3	50	7.510 238
6	30	7.510 090
15	20	4.003 555
30	20	4.003 592
45	20	4.003 584
70	20	4.003 521
150	20	4.003 631

1

**2 CHROMABOND® C₁₈**

Octadecyl modified silica phase for SPE, not endcapped

MACHERY-NAGEL

Base material silica, pore size 60Å, particle size 45µm for C₁₈, specific surface 500m²/g, pH stability 2 to 8 octadecyl phases, not endcapped, carbon content 14% possesses more free silanols (SiOH), which allow secondary interactions with polar groups of the analytes.

Recommended applications: non-polar compounds, pesticides.

Capacity ml	Capacity mg	PK	Cat. No.
1	100	100	6.226 798
3	200	50	9.003 487
3	500	50	9.003 488
6	500	30	6.902 222
6	2000	30	4.003 512
6	1000	30	6.234 031
15	2000	20	4.003 464
45	5000	20	6.700 747
70	10000	10	4.003 561
3	500	250	4.003 433
6	500	250	4.003 435
6	1000	250	4.003 437

2

**3 CHROMABOND® SiOH**

Unmodified silica phase for SPE

MACHERY-NAGEL

Unmodified, weakly acidic silica, pore size 60Å, particle size 45µm, specific surface 500m²/g, pH stability 2 to 8, very polar, adsorbs humidity from air, for this reason it should be kept well closed and if necessary dried before use due to its high affinity for polar compounds it should not be conditioned with polar (e.g. methanol) or water-containing solvents.

Recommended applications: aflatoxins, chloramphenicol, pesticides, steroids, vitamins.

Capacity ml	Capacity mg	PK	Cat. No.
1	100	100	6.225 223
3	200	50	4.003 547
3	500	50	7.085 047
6	500	30	6.801 894
6	1000	30	4.003 481
6	2000	30	4.003 498
15	2000	20	4.003 550
45	5000	20	4.003 605
70	10000	10	6.202 850
150	50000	10	4.003 630
3	500	250	4.003 477
6	1000	250	4.003 482
6	2000	250	4.003 499

3

**4 CHROMABOND® Na₂SO₄/Florisil®**

Combination phase for SPE of hydrocarbons from water acc. to DIN H53/ISO DIS 9377-4

MACHERY-NAGEL

Special combination phase of sodium sulphate and Florisil®.

Recommended application: hydrocarbons from drinking, surface and waste waters.

Volume ml	Capacity ml / mg	PK	Cat. No.
6	2000 / 2000	30	4.003 558
6*	2000 / 2000	30	6.900 415
6*	2000 / 2000	250	4.003 559

4



*Glass columns

Sample preparation/SPE

1

1 CHROMABOND® HR-X

Spherical, hydrophobic polystyrene-divinylbenzene resin for SPE

MACHEREY-NAGEL

Hydrophobic polystyrene-divinylbenzene copolymer pH stability 1 to 14. High-purity material with highest reproducibility and lowest blank values due to a novel manufacturing process, spherical particles 85µm; pore size 55 to 60Å. Very high surface 1000m²/g; capacity 390mg/g (caffeine in water). Excellent recovery rates especially for the enrichment of pharmaceuticals/active ingredients due to the spherical structure of the particles, very homogeneous surface, and optimised pore structure.

Recommended applications: pharmaceuticals/active ingredients from tablets, creams and water/waste water, drugs and pharmaceuticals from urine, blood, serum and plasma trace analysis of pesticides.

Capacity ml	Capacity mg	PK	Cat. No.
1	30	30	4.003 808
3	60	30	4.003 811
1	100	30	4.003 809
3	200	30	4.003 805
6	200	30	4.003 814
3	500	30	4.003 813
6	500	30	4.003 817
15	500	20	4.003 819
15	1000	20	4.003 820
3	200	250	4.003 806
6	200	250	4.003 815

Cartridges in further sizes and phases of the HR-X product range available on request.

2

2 CHROMABOND® Florisil®

Magnesium silicate for SPE

MACHEREY-NAGEL

Matrix magnesium silicate (MgO to SiOH 15:85), high purity, particle size 150 to 250µm.

Recommended application: organic tin compounds, aliphatic carboxylic acids, PCB, PAH.

Volume ml	Capacity mg	PK	Cat. No.
3	200	50	4.003 624
3	500	50	4.003 488
6	500	30	4.003 557
6	1000	30	6.224 842
6	1000	250	4.003 489
6*	1000	30	4.003 490

*Glass columns

3

3 CHROMABOND® XTR

Kieselguhr phase for liquid-liquid extraction

MACHEREY-NAGEL

Base material coarse-grained kieselguhr, large pore size, high pore volume, constantly high batch-to-batch quality, pH working range 1 to 13.

Application: liquid-liquid extraction of highly viscous aqueous solutions such as physiological fluids (blood, plasma, and serum) in clinical chemistry, dyes in textiles, environmental and food analysis.

Glass columns available on request.

Capacity ml	Capacity g	Max. load with aqueous solution ml	PK	Cat. No.
3	0.5	0.5	50	4.003 646
6	1.0	1.0	30	4.003 636
6	1.0	1.0	250	4.003 637
15	3.0	3.0	30	4.003 638
30	4.5	5.0	30	6.205 372
45	8.3	10.0	30	4.003 647
70	14.5	20.0	30	6.225 180
70	14.5	20.0	100	4.003 648
150	37.5	50.0	10	4.003 650

1 CHROMAFIX® C₁₈**Octadecyl modified silica phase for SPE, not endcapped**

MACHEREY-NAGEL

Base material silica, pore size 60Å, particle size 45µm for C₁₈, specific surface 500m²/g, pH stability 2 to 8 octadecyl phases, not endcapped, carbon content 14% possesses more free silanols (SiOH), which allow secondary interactions with polar groups of the analytes.

Recommended applications: non-polar compounds, pesticides.

Size	Capacity mg	PK	Cat. No.
S	240	50	7.083 665
M	480	50	7.079 617
L	950	50	4.003 838

1

**2 CHROMABOND® C₁₈ ec****Octadecyl modified silica phase for SPE, endcapped**

MACHEREY-NAGEL

Base material silica, pore size 60Å, particle size 45µm for C₁₈ ec, 100µm for C₁₈ ec f (for fast flow), specific surface 500m²/g, pH stability 2 to 8. Octadecyl phases, endcapped, carbon content 14% very non-polar, hydrophobic interactions with a wide variety of organic compounds. Advantageous for clean-up of samples with large structural variations (polarity differences).

Recommended applications: non-polar compounds, aflatoxins, amphetamines, antibiotics, antiepileptics, barbiturates, caffeine, drugs, preservatives, fatty acids, nicotine, PAHs, pesticides, PCBs, heavy metals, vitamins. Very well suited for desalting of samples.

Capacity ml	Capacity mg	PK	Cat. No.
1	100	100	4.003 442
3	200	50	4.003 444
3	500	50	4.003 448
6	500	30	4.003 451
6	1000	30	4.003 454
6	2000	30	6.701 243
15	2000	20	4.003 603
45	5000	20	4.003 604
70	10000	10	4.003 560
3	500	250	4.003 446
6	500	250	4.003 450
6	1000	250	4.003 452

BIGpacks: 4.003 446/4.003 450/4.003 452

2

**3 CHROMABOND® NH₂/C₁₈****Combination phase for SPE analysis of PAH from water containing humic acids**

MACHEREY-NAGEL

Special combination phase: aminopropyl phase for removal of interfering humic acids, octadecyl phase for enrichment of PAH.

Recommended application: PAH from water containing humic acids.

Capacity ml	Capacity ml / mg	PK	Cat. No.
6	500 / 500	30	6.228 257
6	500 / 1000	30	4.003 675

Glass columns available on request.

3

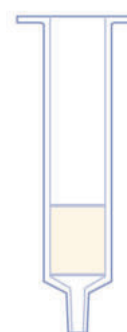
**4 CHROMABOND® SB****Quaternary ammonium modified silica anion exchanger for SPE (SAX)**

MACHEREY-NAGEL

Base material silica, pore size 60Å, particle size 45µm, specific surface 500m²/g, pH stability 2 to 8. Silica modified with quaternary amine. Strongly basic anion exchanger (capacity ~ 0.3meq/g). Not suited for very strong anions such as sulphonic acids, because these are difficult to elute.

Recommended application: organic acids, caffeine, saccharin.

Capacity ml	Capacity mg	PK	Cat. No.
1	100	100	4.003 486
3	200	50	4.003 580
3	500	50	7.075 759
6	500	30	4.003 614
6	1000	30	6.206 234
3	500	250	4.003 487

BIGpacks: 4.003 487

4



1



1 CHROMABOND® Easy

Polar modified polystyrene-divinylbenzene copolymer with a weak anion exchanger

MACHEREY-NAGEL

Specific surface 650 to 700 m²/g, particle size 80µm, pore size 50 Å, pH stability 1 to 14. Due to bifunctional modification much more hydrophilic than conventional polystyrene-divinylbenzene polymers and thus easily wettable with water.

Recommended applications: polar herbicides/pesticides from water (acidic, neutral, basic), polar phenols from water, polyaromatic compounds, polychlorinated biphenyls, drug analysis from urine, blood, serum, plasma pharmaceuticals/active ingredients from tablets, creams.

Due to the bifunctional modification CHROMABOND® Easy is considerably more hydrophilic than conventional polystyrene-divinylbenzene polymers and thus easily wettable with water. The Easy effect: Aqueous samples can be loaded directly without preconditioning! This means that little or even no conditioning is needed, in contrast to standard SPE materials, where recovery rates normally decrease, in the worst case down to zero! Depending on the separation task conditioning may be required and is recommended for method development. A positive side effect of the excellent wettability: there is no decrease of recovery rates, if the cartridge runs dry, therefore automation is easier or, in some cases compared to silica materials, only feasible with CHROMABOND® Easy, because a permanent vacuum can be used without supervision.

Further advantages of using a polymeric material:

- high surface, this means very high binding capacity (2 - 5 times higher than silica-based adsorbents)
- less adsorbent is needed in the cartridge (without losing sensitivity or recovery)
- faster analysis, because the height of the adsorbent bed can be reduced
- acidic or basic solvents (e. g. TFA) do not destroy the phase, or lead to unintended side products

Because of the polar modification the material is suitable for a broad range of compounds (acidic, neutral, basic, polar and nonpolar substances). Highly reproducible recovery rates can be obtained, even if the cartridge runs dry (especially advantageous when using 96-well plates, where stopcocks are not available!)

Capacity ml	Capacity mg	PK	Cat. No.
1	30	30	4.003 719
3	60	30	4.003 721
3	200	30	6.226 452
6	200	30	6.234 375
3	500	30	4.003 728
6	500	30	6.224 850
15	500	20	4.003 726
3	200	250	4.003 723
6	200	250	4.003 724

BIGpacks: 4.003 723/4.003 724

2

2 CHROMABOND® vacuum manifolds and accessories

For simultaneous preparation of up to 12 or 24 samples, replacement parts and accessories for special applications

MACHEREY-NAGEL

Vacuum manifold complete consists of: glass cabinet with lid and lid gasket, removable needles on lower side of lid, vacuum gauge, control valve, valves and caps, variable rack.

Description	PK	Cat. No.
Gaskets for lid with 12 positions	2	6.801 608
Luer fittings for lid, female	12	4.003 534
Luer fittings for lid, male	12	4.003 535
Valves, plastic	12	7.089 161
Stainless steel needles	12	7.079 432
Products for protection from cross contamination valve, brass, tarnished	1	4.003 538
Products for protection from cross contamination valve as above	12	7.089 162
Products for protection from cross contamination stainless steel connectors	12	7.079 431
Tubing adaptor for 1,3 and 6 ml polypropylene columns (PTFE)	4	6.900 713
Drying attachment	1	4.672 182
Vacuum manifold for 12 columns or cartridges	1	6.274 944
Vacuum manifold for 24 columns or cartridges	1	6.275 025

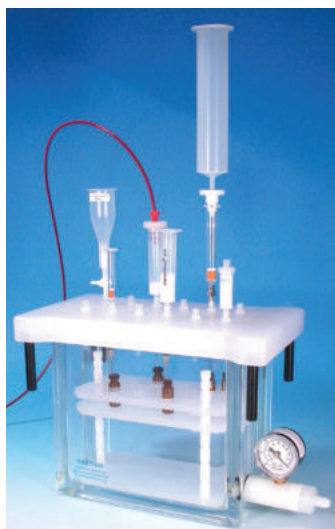

1 Copure® QuEChERS extraction kits

NEW

1

Extraction and clean-up mixtures for sample preparation in the pesticide analysis of vegetable foodstuffs according to EN 15662 using GC/MS or LC/MS after acetonitrile extraction and purification using the dispersive SPE-QuEChERS method.

The samples are first extracted with Mix A. Purification is done with one of the following mixtures:

- **Mix B** (Clean-up mixture for fruits and vegetables with low fat content, e.g. apples, strawberries)
- **Mix C** (Clean-up mixture for fruits and vegetables with high fat content, containing oil/wax, e.g. avocados)
- **Mix D** (Clean-up mixture for moderately chlorophyll/carotenoid-containing fruits and vegetables, e.g. carrots, salad)
- **Mix E** (Clean-up mixture for fruits and vegetables with high chlorophyll/carotenoid content, e.g. sweet peppers, spinach)

If required, add ceramic homogenising beads for better mixing.

- **Mix A contains a bag with the required amount of mixture and a 50 ml empty tube**
- **Mix B, C, D and E are pre-weighed into a 15 ml tube**



Type	Capacity ml	Composition	PK	Cat. No.
Mix A	50	4 g MgSO ₄ , 1 g NaCl, 1 g Trisodium citrate, 0.5 g Disodium citrate	50	4.669 294
Mix B	15	0.15 g PSA, 0.9 g MgSO ₄	50	4.669 295
Mix C	15	0.15 g PSA, 0.15 g C18, 0.9 g MgSO ₄	50	4.669 296
Mix D	15	0.15 g PSA, 0.015 g GCB, 0.9 g MgSO ₄	50	4.669 297
Mix E	15	0.15 g PSA, 0.045 g GCB, 0.9 g MgSO ₄	50	4.669 298
Ceramic homogenising beads			100	4.669 299

2 SPE phases for food analysis

QuEChERS method and pre-mixes

Within a few years after its development by Anastassiades et al. the QuEChERS method has gained a leading position for determination of pesticide residues in food by GC-MS or LC-MS allowing rapid and cheap clean-up of strong matrix-contaminated samples.

Standard clean-up of food samples

10 g sample are homogenised with 10 ml acetonitrile. After adding the internal standard the sample is shaken with 4 g MgSO₄ and 1 g NaCl and afterwards centrifuged. 1 ml of the supernatant is spiked with 25 mg CHROMABOND® Diamino and 150 mg MgSO₄ and shaken again. After centrifugation the supernatant is injected into the GC/MS.



3 CHROMABOND® QuEChERS extraction buffer mixes/clean-up mixes

Extraction mixtures for sample preparation for determination of pesticides in food samples.

MACHEREY-NAGEL

MACHEREY-NAGEL offers a number of individually weighed and pre-mixed buffers and extraction mixtures, specially composed for different sample matrices.

Mix I and Mix II are extraction mixtures, Mix III to Mix VI are clean-up mixtures.

The food samples will be extracted with either Mix I or Mix II.

Afterwards they will be purified with one of the following mixtures:

- Mix III (samples with low fat content; e.g. apples, strawberries),
- Mix IV (moderate content of chlorophyll and carotinoids; e. g. carrots, lettuce),
- Mix V (high content of chlorophyll and carotinoids; e. g. bell peppers, spinach),
- Mix VI (high fat content; e. g. avocados).

Every mix is prepacked in a 15 ml centrifuge tube. Pack of 50 pieces.

Description	Capacity ml	Composition	PK	Cat. No.
Mix I Citrat-Extraction-Mix	15	4g MgSO ₄ , 1g NaCl, 0.5g Na ₂ H citrate 1.5 H ₂ O, 1g Na ₂ citrate, 2 H ₂ O	50	4.003 824
Mix II Acetat-Extraction-Mix	15	6g MgSO ₄ , 1.5g Na acetate	50	4.003 825
Mix III Diamino Clean-up Mix	15	0.15g CHROMABOND® Diamino with 0.9g MgSO ₄	50	4.003 826
Mix IV Diamino/Carbon Clean-up Mix	15	0.15g CHROMABOND® Diamino with 0.9g MgSO ₄ and 15mg Carbon	50	4.003 827
Mix V Diamino/Carbon Clean-up Mix	15	0.15g CHROMABOND® Diamino with 0.9g MgSO ₄ and 45mg Carbon	50	4.003 829
Mix VI Diamino/C ₁₈ ec Clean-up Mix	15	0.15g CHROMABOND® Diamino with 0.9g MgSO ₄ and 150mg C ₁₈ ec	50	4.003 828

3



Chemical compatibility of filter materials

The following table lists the chemical compatibility of our CHROMAFIL® materials. The chemical compatibility depends on several parameters such as time, pressure, temperature and concentration.

In most cases, CHROMAFIL® filters will have only short contact with a solvent. In these cases they may be used despite of limited compatibility.

For example, a PTFE filter with PP housing does not liberate any UV-detectable substances during filtration of 5 ml THF, although PP shows only limited resistance towards THF.

Solvent	Material									
	MV	CA	RC	PA	PTFE	PVDF	PES	PET	GF	PP
Acetaldehyde	⊖	⊖	⊕	⊙	⊕	⊕		⊕	⊕	⊙
Acetic acid, 100 %	⊖	⊖	⊖	⊖	⊕	⊕	⊕	⊕	⊕	⊕
Acetone	⊖	⊖	⊕	⊕	⊕	⊖	⊖	⊕	⊕	⊕
Acetonitrile	⊖	⊖	⊕	⊕	⊕	⊕	⊕	⊕	⊕	⊕
Ammonia, 25 %	⊖	⊖	⊙	⊖	⊕	⊕	⊕	⊙	⊕	⊕
Benzene	⊕	⊕	⊕	⊕	⊕	⊙		⊕	⊕	⊙
<i>n</i> -Butanol	⊕	⊕	⊕	⊙	⊕	⊕	⊕	⊕	⊕	⊕
Cyclohexane	⊕	⊕	⊕	⊙	⊕	⊕	⊕	⊕	⊕	⊕
Dichloromethane	⊕	⊖	⊕	⊖	⊕	⊕	⊖	⊕	⊕	⊖
Diethyl ether	⊙	⊙	⊕	⊕	⊕	⊕	⊕	⊕	⊕	⊙
Dimethylformamide	⊖	⊖	⊙	⊕	⊕	⊖	⊖	⊕	⊕	⊕
1,4-Dioxane	⊖	⊖	⊕	⊕	⊕	⊙	⊖	⊕	⊕	⊙
Ethanol	⊖	⊕	⊕	⊕	⊕	⊕	⊕	⊕	⊕	⊕
Ethyl acetate	⊖	⊖	⊕	⊕	⊕	⊕	⊕	⊕	⊕	⊙
Ethylene glycol	⊙	⊙	⊕	⊕	⊕	⊕	⊕	⊕	⊕	⊕
Formic acid, 100 %	⊕	⊖	⊙	⊖	⊕	⊕	⊕	⊙	⊕	⊕
Hydrochloric acid, 30 %	⊖	⊖	⊖	⊖	⊕	⊕	⊕	⊖	⊕	⊕
Methanol	⊖	⊖	⊕	⊕	⊕	⊕	⊕	⊕	⊕	⊕
Nitric acid, 65 %	⊖	⊖	⊖	⊖	⊙	⊙		⊙	⊕	⊖
Oxalic acid, 10 % aqueous	⊕	⊖	⊕	⊖	⊕	⊕		⊕	⊕	⊕
Petroleum ether	⊕	⊕	⊕	⊕	⊕	⊕	⊕	⊕	⊕	⊕
Phosphoric acid, 80 %	⊖	⊖	⊙	⊖	⊕	⊙		⊕	⊕	⊕
Potassium hydroxide, 1 mol/l	⊖	⊖	⊙	⊕	⊕	⊙	⊕	⊙	⊕	⊕
2-Propanol	⊕	⊕	⊕	⊕	⊕	⊕	⊕	⊕	⊕	⊕
Sodium hydroxide, 1 mol/l	⊖	⊖	⊙	⊕	⊕	⊙	⊙	⊙	⊙	⊕
Tetrachloromethane	⊕	⊖	⊕	⊕	⊕	⊙		⊕	⊕	⊙
Tetrahydrofuran	⊖	⊖	⊕	⊙	⊕	⊕	⊖	⊕	⊕	⊙
Toluene	⊕	⊖	⊕	⊕	⊕	⊕	⊕	⊕	⊕	⊙
Trichloroethene	⊕	⊕	⊕	⊙	⊕	⊕		⊕	⊕	⊙
Trichloromethane	⊕	⊖	⊕	⊖	⊕	⊕	⊖	⊕	⊕	⊖
Urea	⊕	⊕	⊕	⊕	⊕	⊕		⊕	⊕	⊕
Water	⊕	⊕	⊕	⊕	⊕	⊕	⊕	⊕	⊕	⊕
Xylene	⊕	⊕	⊕	⊕	⊕	⊙		⊕	⊕	⊙

Data not guaranteed. ⊕ resistant, ⊖ not resistant, ⊙ limited resistance

MV = cellulose mixed esters, CA = cellulose acetate, RC = regenerated cellulose, PA = polyamide, PTFE = polytetrafluoroethylene (Teflon), PVDF = polyvinylidene difluoride, PES = polyethersulfone, PET = polyester, GF = glass fibre, PP = polypropylene (housing material)

1 LLG-Syringe Filters SPHEROS

Cost-effective syringe filters for filtration of a broad variety of solvents and aqueous or inorganic solutions. These syringe filters cover most applications in HPLC, pharmaceutical, environmental, biotechnology, and food and beverage testing laboratories.

- Robust Polypropylene housing
- Multifunctional syringe filters with female Luer-Lock inlet and male Luer-Slip outlet
- Suitable for all syringes with Luer connection
- Sterile or non-sterile
- Sterile products in individual hard blister packaging and dispenser box



2 3 LLG Syringe Filters SPHEROS, Cellulose Acetate

Hydrophilic membrane for filtration of aqueous liquids. Low protein binding capacity. Especially suitable for biological macromolecules, water soluble oligomers and polymers. With female Luer-Lock inlet and male Luer-Slip outlet. Sterile products in individual hard blister packaging and dispenser box.

Filter diam.	Pore size	Housing	Sterile	PK	Cat. No.
mm	µm				
13	0.22	PP, red	-	100	6.272 802
13	0.45	PP, red	-	100	6.272 803
25	0.22	PP, red	-	50	6.272 804
25	0.22	PP, red	-	500	4.668 145
25	0.45	PP, red	-	50	6.272 805
25	0.45	PP, red	-	500	4.668 146
13	0.22	PP, red	+	100	6.272 806
13	0.45	PP, red	+	100	6.272 807
25	0.22	PP, red	+	45	6.272 808
25	0.45	PP, red	+	45	6.272 809

2



3



4 LLG Syringe Filters SPHEROS, PES

Hydrophilic membrane for aqueous and polar organic solutions with low protein binding capacity. Especially suited for sterile filtration of solutions and media in cell culture as well as for ion chromatography and organic acids. With female Luer-Lock inlet and male Luer-Slip outlet. Sterile filters individually packed in a hard blister package.

Filter diam.	Pore size	Housing	Sterile	PK	Cat. No.
mm	µm				
25	0.22	PP, green	-	50	6.272 640
25	0.45	PP, green	-	50	6.272 641
25	0.22	PP, green	+	45	6.272 642
25	0.45	PP, green	+	45	6.272 643

4



5 LLG Syringe Filters SPHEROS, Nylon

Hydrophilic membrane for filtration of aqueous and organic/aqueous liquids with medium polarity. Very good chemical resistance to esters, alkaline solutions and alcohols. With female Luer-Lock inlet and male Luer-Slip outlet.

Filter diam.	Pore size	Housing	Sterile	PK	Cat. No.
mm	µm				
13	0.22	PP, pink	-	100	6.272 810
13	0.45	PP, pink	-	100	6.272 811
25	0.22	PP, pink	-	50	6.272 812
25	0.22	PP, pink	-	500	4.668 147
25	0.45	PP, pink	-	50	6.272 813
25	0.45	PP, pink	-	500	4.668 148

5



6 LLG Syringe Filters SPHEROS, PTFE

Hydrophobic membrane for filtration of non-polar liquids and gases. Very good chemical resistance to all kinds of solvents and alkaline solutions. With female Luer-Lock inlet and male Luer-Slip outlet.

Filter diam.	Pore size	Housing	Sterile	PK	Cat. No.
mm	µm				
13	0.22	PP, white	-	100	6.272 816
13	0.45	PP, white	-	100	6.272 817
25	0.22	PP, white	-	50	6.272 818
25	0.22	PP, white	-	500	4.668 149
25	0.45	PP, white	-	50	6.272 819
25	0.45	PP, white	-	500	4.668 150

6



LLG-Syringe Filters

We offer a line of syringe filters especially designed to provide efficient filtration of a broad variety of fluids, solvents, aqueous or inorganic solutions. Our syringe filters cover most applications in HPLC, pharmaceutical, environmental, biotechnology and food and beverage testing laboratories.

- Housing injected in Polypropylene or MABS
- Multifunctional Syringe filters equipped with Luer-Lock connections on both sides or female Luer-Lock input and male Luer-Slip output
- Suitable for all syringes with Luer connection
- Pre-sterilised or non-sterile
- Sterile products in individual hard blister
- Superior pressure stability

1 2 3 LLG Syringe Filter CA, Cellulose acetate

Hydrophilic membrane for filtration of aqueous solutions.

This membrane features excellent shape stability in aqueous solutions and a very low binding capacity for proteins (21µg per 25 mm Filter). Ideal for use with biological macromolecules, water soluble oligomers and polymers. With Luer-Lock input and Luer-Lock or Luer-Slip output.

Type	Filter diam. mm	Pore size µm	Housing	PK	Cat. No.
non sterile	13	0.20	Acrylic, blue	500	9.055 500
non sterile	13	0.45	Acrylic, yellow	500	9.055 502
non sterile	13	0.80	Acrylic, green	500	9.055 504
non sterile	25	0.20	Acrylic, blue	500	9.055 501
non sterile	25	0.45	Acrylic, yellow	500	9.055 503
non sterile	25	0.80	Acrylic, green	500	7.970 389
sterile	13	0.20	Acrylic, blue	50	9.055 510
sterile	13	0.45	Acrylic, yellow	50	9.055 512
sterile	13	0.80	Acrylic, green	50	6.285 694
sterile	25	0.20	Acrylic, blue	50	9.055 511
sterile	25	0.45	Acrylic, yellow	50	9.055 513
sterile	25	0.80	Acrylic, green	50	6.285 699
sterile	25	0.20	Acrylic, transparent*	50	6.285 703
sterile	25	0.45	Acrylic, transparent*	50	6.285 704
sterile	25	0.80	Acrylic, transparent*	50	6.285 705

*Luer-Slip output

1



2



3



4



4 LLG Syringe Filter NY, Nylon/Polyamide

This is a rather hydrophilic membrane; it is recommended for filtration of aqueous and organic/aqueous medium polar liquids.

Excellent chemical compatibility with esters, bases and alcohols. With Luer-Lock input and Luer-Slip output.

Type	Filter diam. mm	Pore size µm	Housing	PK	Cat. No.
non sterile	13	0.22	PP	500	9.055 520
non sterile	13	0.45	PP	500	9.055 522
non sterile	25	0.22	PP	500	9.055 521
non sterile	25	0.45	PP	500	9.055 523
sterile	25	0.22	Acrylic	50	6.285 707
sterile	25	0.45	Acrylic	50	6.285 708

1 LLG Syringe Filter PE, Polyethylene

Universal filter membrane for all analytical requirements. For aqueous and aggressive organic solvent filtration. Wide application in sample preparation, Ion chromatography. With Luer-Lock input and Luer-Slip output.

Type	Filter diam.	Pore size	Housing	PK	Cat. No.
	mm	µm			
non sterile	13	0.2	PP	500	9.055 540
non sterile	13	0.5	PP	500	9.055 542
non sterile	25	0.2	PP	500	9.055 541
non sterile	25	0.5	PP	500	9.055 543

1



2 LLG Syringe Filter RC, Regenerated cellulose

Hydrophilic membrane features very low adsorption. It is recommended for filtration of aqueous and organic/aqueous liquids.

For filtration of polar and medium polar liquids. With Luer-Lock input and Luer-Slip output.

Type	Filter diam.	Pore size	Housing	PK	Cat. No.
	mm	µm			
non sterile	13	0.20	PP	500	9.055 530
non sterile	13	0.45	PP	500	9.055 532
non sterile	25	0.20	PP	500	9.055 531
non sterile	25	0.45	PP	500	9.055 533

2



3 LLG Syringe Filter PTFE, Polytetrafluorethylene

Hydrophobic membrane. Ideal for filtration of non-polar liquids and gases. It is very resistant to various solvents as well as acids and bases. With Luer-Lock input and Luer-Slip output.

Type	Filter diam.	Pore size	Housing	PK	Cat. No.
	mm	µm			
non sterile	13	0.20	PP	500	7.970 402
non sterile	13	0.45	PP	500	7.970 385
non sterile	25	0.20	PP	500	9.055 535
non sterile	25	0.45	PP	500	6.255 331

3



4 LLG Syringe Filter PVDF, Polyvinylidene fluoride

Hydrophilic membrane for aqueous polar and light unpolar solutions. Very low protein binding High flow rates ideal for use with biological macromolecules, water soluble oligomers and polymers. With Luer-Lock input and Luer-Slip output.

Type	Filter diam.	Pore size	Housing	PK	Cat. No.
	mm	µm			
non sterile	13	0.20	PP	500	7.970 258
non sterile	13	0.45	PP	500	9.055 534
non sterile	25	0.20	PP	500	7.970 387
non sterile	25	0.45	PP	500	7.970 286
sterile	13	0.20	Acrylic	50	6.285 697
sterile	13	0.45	Acrylic	50	6.285 698
sterile	25	0.20	Acrylic	50	6.258 299
sterile	25	0.45	Acrylic	50	6.285 702

4



5 LLG Syringe Filter GF, Glass-fibre

Hydrophilic membrane suitable for pre-filtration. They can be used for solutions with high particulate loads or for highly viscous solutions (e.g. soil samples, fermentation broths) either alone or in combination with other filters. With Luer-Lock input and Luer-Slip output.

Type	Filter diam.	Pore size	Housing	PK	Cat. No.
	mm	µm			
non sterile	25	0.7	PP	500	9.055 550
non sterile	25	1.0	PP	500	9.055 551
non sterile	25	1.2	PP	500	9.055 552
non sterile	25	3.1	PP	500	9.055 553

5





1 Preparative HPLC columns Nucleosil® 100-5 C₁₈

Grain size 5 µm, pore dia. 100 Å. Octadecyl phase, endcapped, 15% C.

MACHEREY-NAGEL

Type	Description	Column length mm	PK	Cat. No.
2 mm i.d.	EC- column	125	1	9.003 866
2 mm i.d.	EC- column	250	1	9.003 871
3 mm i.d.	EC- column	125	1	9.003 867
3 mm i.d.	EC- column	250	1	9.003 872
4 mm i.d.	EC- column	125	1	9.003 868
4 mm i.d.	EC- column	250	1	9.003 873
4.6 mm i.d.	EC- column	125	1	9.003 869
4.6 mm i.d.	EC- column	150	1	9.003 870
4.6 mm i.d.	EC- column	250	1	9.003 874

Further products can be found in our online shop.

2



2 EC analytical columns NUCLEODUR® 100-3 C₁₈ ec, 3 µm

Octadecyl phases, 17.5 % C, particle size 3 µm.

MACHEREY-NAGEL

Int. diam. mm	Length mm	PK	Cat. No.
2.0	50	1	4.004 375
3.0	50	1	4.004 376
4.0	50	1	4.004 377
4.6	50	1	4.004 378
4.6	100	1	4.006 933
2.0	125	1	9.003 796
3.0	125	1	9.003 797
4.0	125	1	9.003 798
4.6	125	1	9.003 799
4.6	150	1	9.003 800
2.0	250	1	9.003 801
3.0	250	1	9.003 802
4.0	250	1	9.003 803
4.6	250	1	9.003 804

3



3 EC analytical columns NUCLEODUR® 100-5 C₈ ec, 5 µm

Octyl phases, 10.5 % C, particle size 5 µm.

MACHEREY-NAGEL

Int. diam. mm	Length mm	PK	Cat. No.
2.0	50	1	4.004 521
3.0	50	1	4.004 522
4.0	50	1	4.004 523
4.6	50	1	4.004 524
2.0	125	1	4.004 525
3.0	125	1	4.004 526
4.0	125	1	4.004 527
4.6	125	1	4.004 528
4.6	150	1	4.004 529
2.0	250	1	4.004 530
3.0	250	1	4.004 531
4.0	250	1	4.004 532
4.6	250	1	6.228 531

4



4 EC analytical columns NUCLEODUR® 100-5 C₁₈ ec, 5 µm

Octadecyl phases, 17.5 % C, particle size 5 µm

MACHEREY-NAGEL

Int. diam. mm	Length mm	PK	Cat. No.
2.0	50	1	4.004 368
3.0	50	1	4.004 369
4.0	50	1	4.004 370
4.6	50	1	4.004 371
4.6	100	1	4.006 934
2.0	125	1	9.003 816
3.0	125	1	9.003 817
4.0	125	1	9.003 818
4.6	125	1	9.003 819
4.6	150	1	9.003 820
2.0	250	1	9.003 821
3.0	250	1	9.003 822
4.0	250	1	9.003 823
4.6	250	1	9.003 824

1 VarioPrep preparative columns NUCLEODUR® 100-5 C₁₈ ec, 5 µm

Octadecyl phases, 17.5 % C. Particle size 5 µm

MACHEREY-NAGEL

Int. diam. mm	Length mm	PK	Cat. No.
10	250	1	4.004 752

1



2 Tubing, PEEK

For use in LC, LCMS and automation technology. The polyetheretherketone (PEEK) tubing are a flexible alternative to stainless steel tubing in high pressure applications.

Trajan Scientific

The tubing are color coded to industry standards for easy identification of the inner diameter.

They are inert to most commonly used solvents. Exceptions are very caustic reagents, strong acids and bases.

- Smooth inner surface
- Good chemical resistance
- Bio-inert and biocompatible
- Operating temperature up to max. 100 °C
- Pressure stable up to 480 bar (7000 psi, 48000 kPa)

Int. diam. mm	Ext. diam. mm	Length m	Colour	PK	Cat. No.
0.13	1.6	1.5	red	1	4.662 782
0.18	1.6	1.5	yellow	1	4.662 783
0.25	1.6	1.5	blue	1	4.662 784
0.13	1.6	3	red	1	4.662 785
0.18	1.6	3	yellow	1	4.662 786
0.25	1.6	3	blue	1	4.662 787
0.13	1.6	15	red	1	4.662 788
0.18	1.6	15	yellow	1	4.662 789
0.25	1.6	15	blue	1	4.662 790
0.13	1.6	30.5	red	1	4.662 791
0.18	1.6	30.5	yellow	1	4.662 792
0.25	1.6	30.5	blue	1	4.662 793

2



3 Accessories for PEEK Tubing

Fingertight fittings for HPLC tubing made of PEEK.

Trajan Scientific

Type	Pressure max. bar	PK	Cat. No.
1/16" ... 10-32 UNF	345	10	4.664 157
1/32" ... 10-32 UNF (long)	345	10	4.664 158
1/32" ... 10-32 UNF	345	10	4.664 159
1/32" ... 6-40 UNF	190	5	4.664 160

3



4 HPLC column thermostat Jetstream II Plus

Peltier heating/cooling thermostat with a temperature range of 5-85 °C. Big compartment room for 4-5 HPLC columns with a length of 350-400 mm as well as space for valves, precolumns and column switch valves. Programmable via alphanumeric keyboard or RS 232 interface. The temperature control allows isothermal steps and linear gradients for up to 99 temperatures. With two-way forced-air circulation and double sensor reference technology, that means very good temperature distribution, temperature stability and repeatability.

VDS optilab

- For horizontal and vertical use
- Independent from room temperature due to Peltier elements
- Autocalibration and temperature correction via keyboard
- Permanent display of set/actual temperature
- Safety switch-off for thermal protection of the columns, selectable sensitivity
- Leak detector with acoustic warning signal and device switch-off, selectable sensitivity
- Continuous monitoring of all functions with overload protection
- LCD display

Specifications

Operating temperature range:	5 ... 85 °C
Temperature accuracy:	±0.5 K
Temperature stability:	±0.15 K
Temperature gradient:	1 K/2 min
Dimensions (W x H x D):	135 x 450 x 310 mm
Weight:	11 kg
Power supply:	100 ... 245 V, 50/60 Hz

Type	PK	Cat. No.
Jetstream II Plus	1	4.663 363

4



1

1 Sample Concentrators SBHCONC/1

A sample concentrator is a fast and convenient way of concentrating multiple samples in a block heater at once. Utilising a simple gas delivery system the sample concentrator passes an inert gas over the surface of the samples via stainless steel needles. This in combination with the heat from the block heater below produces ideal conditions for fast, efficient evaporation. *Stuart*

- Gas reservoir located on adjustable stand for accurate height control
- Needles available with 76 and 127 mm length
- Needles available with PTFE-coating for corrosive solutions
- Compatible with Stuart SBH130D/3 and SBH200D/3 Block heaters

Scope of supply: Gas reservoir and stand

Please order Dry block, inserts and needles separately.

Type	PK	Cat. No.
SBHCONC/1	1	6.235 249

Accessories for Sample Concentrators SBHCONC/1

Stuart

Description	PK	Cat. No.
Gas chamber sealing pad	1	7.910 023
Needles, stainless steel, 76 mm	100	6.235 631
Needles, stainless steel, 127 mm	100	6.235 250
Needles, PTFE-coated, 76 mm	100	6.236 370
Needles, PTFE-coated, 127 mm	100	6.252 395

2

2 LLG-Test tubes, soda-lime glass

Test tubes with round bottom. Hydrolytic resistance: Class HGB 3 acc. to ISO 719, Type III acc. to C - USP.

Diam. mm	Length mm	PK	Cat. No.
8	70	100	6.201 034
10	100	100	6.801 073
12	100	100	7.607 198
14	130	100	6.800 620
16	130	100	6.800 382
16	160	100	7.600 405
20	180	100	7.607 778
25	150	50	6.800 621
30	200	50	7.600 324
30	100	100	6.267 806
15	100	100	7.651 872
16	120	100	7.651 871
18	130	100	7.652 552



1 Chromatographic columns, PTFE-/or Valve Stopcock, borosilicate glass 3.3

Chromatography columns with socket and with frit. Manufactured from borosilicate glass 3.3 which is resistant to heat and almost all chemicals. NS necks are in compliance with DIN 12242 standards.

ISOLAB

Description	Int. diam. mm	Length mm	PK	Cat. No.
without frit NS 14/23	10	200	1	4.008 398
without frit NS 29/32	20	400	1	4.008 399
without frit NS 29/32	30	600	1	4.008 400
with frit (P=1) NS 14/23	10	200	1	4.008 401
with frit (P=1) NS 14/23	10	300	1	4.008 402
with frit (P=1) NS 14/23	15	200	1	4.008 403



Chromatographic columns, PTFE- or Valve Stopcock, DURAN® tubing

Made of DURAN® tubing. Chromatography columns with sintered frit, porosity 0.

Lenz

Available in three versions:

- with beaded rim and PTFE stopcock
- with NS socket and PTFE stopcock
- with NS socket and needle-valve stopcock (bore 0 - 2.5 mm)

Description	Capacity ml	Int. diam. mm	Length mm	Stopcock	PK	Cat. No.
beaded rim	35	15	200	PTFE	1	6.205 017
beaded rim	125	20	400	PTFE	1	6.202 416 2
beaded rim	430	30	600	PTFE	1	6.202 417
beaded rim	1000	40	800	PTFE	1	6.202 418
socket NS 14/23	8	10	100	PTFE	1	6.225 859
socket NS 14/23	15	10	200	PTFE	1	9.025 912
socket NS 14/23	23	10	300	PTFE	1	9.025 913
socket NS 14/23	35	15	200	PTFE	1	9.025 914
socket NS 14/23	35	15	200	Valve	1	6.223 574
socket NS 29/32	125	20	400	PTFE	1	6.203 961
socket NS 29/32	430	30	600	PTFE	1	6.303 297

2

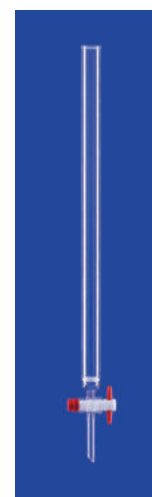

6.202 416

3 Chromatographic columns, DURAN® tubing

Made of DURAN® tubing. Basic chromatographic columns with indentations above the stopcock for placing a cotton plug, with NS socket, with PTFE stopcock and retaining device.

Lenz

Description	Capacity ml	Int. diam. mm	Length mm	PK	Cat. No.
with NS 14/23 socket	15	10	200	1	9.025 932
with NS 14/23 socket	35	15	200	1	6.235 814
with NS 29/32 socket	125	20	400	1	9.025 934
with NS 29/32 socket	430	30	600	1	9.025 936
with NS 29/32 socket	1000	40	800	1	9.025 938

3

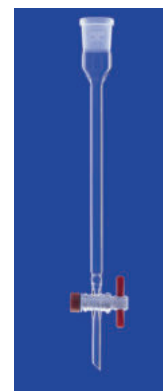

➔ Stands and fittings - please see page 179.

4 Seasand for Chromatographic columns

Acid washed, calcined. Pack of 1000 g.

MACHEREY-NAGEL

Description	PK	Cat. No.
Seasand, acid washed, calcined, pack of 1000 g	1	6.700 265

4



5 Glass wool

Extra fine. In packs as outlined below.

Capacity g	PK	Cat. No.
1000	1	9.114 310

5



1

1 Quartz wool

Silica. Fibre thickness 4 µm to 12 µm.

proQuarz

Capacity g	PK	Cat. No.
500	1	9.114 331

Quartz Sand

BÜCHI

Granulation	Weight kg	PK	Cat. No.
0,3 - 0,9 mm	2,5	2500	6.059 700

2

2 Silica adsorbents for low pressure column chromatography

Standard silica 60, pore size ~ 60 Å; pore volume ~ 0.75 ml/g; spec. surface BET ~ 500 m²/g, *MACHERY-NAGEL*
 highly porous, amorphous silicic acid in the form of hard, opalescent particles, prepared by precipitation of water glass with sulphuric acid. Silica FIA for the fluorescence indicator adsorption procedure for the determination of hydrocarbon groups in the testing of liquid fuels in accordance with DIN 51791 and ASTM D 1319-58T. The FIA method determines saturated hydrocarbons, olefins and aromatic hydrocarbons of a sample chromatographically by adsorption and desorption in a column filled with FIA silica, in the presence of a fluorescent dye mixture. Further silica adsorbentson request.

Description	Particle size	Weight kg	PK	Cat. No.
Silica 60, 0.015 - 0.04 mm	-	1	1	4.004 999
Silica 60, 0.015 - 0.04 mm	-	5	1	4.005 001
Silica 60, 0.015 - 0.04 mm	-	25	1	4.005 000
Silica 60, 0.04 - 0.063 mm	230 - 400 mesh	1	1	4.004 968
Silica 60, 0.04 - 0.063 mm	230 - 400 mesh	5	1	4.004 970
Silica 60, 0.04 - 0.063 mm	230 - 400 mesh	25	1	4.004 969
Silica 60 M, 0.04 - 0.063 mm	230 - 400 mesh	1	1	4.004 971
Silica 60 M, 0.04 - 0.063 mm	230 - 400 mesh	5	1	4.004 973
Silica 60 M, 0.04 - 0.063 mm	230 - 400 mesh	25	1	4.004 972
Silica 60, 0.05 - 0.1 mm	130 - 270 mesh	1	1	4.004 974
Silica 60, 0.05 - 0.1 mm	130 - 270 mesh	5	1	4.004 976
Silica 60, 0.05 - 0.1 mm	130 - 270 mesh	25	1	4.004 975
Silica 60, 0.063 - 0.2 mm	70 - 230 mesh	1	1	4.004 957
Silica 60, 0.063 - 0.2 mm	70 - 230 mesh	5	1	4.004 959
Silica 60, 0.063 - 0.2 mm	70 - 230 mesh	25	1	4.004 958
Silica 60, < 0.063 mm	+ 230 mesh	1	1	4.004 977
Silica 60, < 0.063 mm	+ 230 mesh	5	1	4.004 979
Silica 60, < 0.063 mm	+ 230 mesh	25	1	4.004 978
Silica 60, 0.2 - 0.5 mm	35 - 70 mesh	1	1	4.004 962
Silica 60, 0.2 - 0.5 mm	35 - 70 mesh	5	1	4.004 964
Silica 60, 0.2 - 0.5 mm	35 - 70 mesh	25	1	4.004 963
Silica 60, 0.5 - 1.0 mm	18 - 35 mesh	1	1	4.004 965
Silica 60, 0.5 - 1.0 mm	18 - 35 mesh	5	1	4.004 967
Silica FIA fine	0.071 - 0.16 mm	1	1	4.004 980
Silica FIA coarse	0.071 - 0.63 mm	1	1	4.004 981

3

3 Aluminium oxide adsorbents for low pressure column chromatography

Aluminium oxides produced by dehydration of different aluminium hydroxides, *MACHERY-NAGEL*
 e. g. hydrargillite between 400 and 500°C, activity grade I, particle size 50 to 200µm, specific surface (BET) ~ 130m²/g.

Type	Range pH	Weight kg	PK	Cat. No.
Aluminium oxide 90 basic	9,5 ± 0,3	1	1	4.004 934
Aluminium oxide 90 neutral	7 ± 0,5	1	1	6.231 726
Aluminium oxide 90 acidic	4 ± 0,3	1	1	4.004 939
Aluminium oxide 90 basic	9,5 ± 0,3	5	1	4.004 936
Aluminium oxide 90 neutral	7 ± 0,5	5	1	4.004 938
Aluminium oxide 90 acidic	4 ± 0,3	5	1	4.004 941
Aluminium oxide 90 basic	9,5 ± 0,3	25	1	4.004 935
Aluminium oxide 90 neutral	7 ± 0,5	25	1	4.004 937
Aluminium oxide 90 acidic	4 ± 0,3	25	1	4.004 940

1 HPLC bottles, DURAN® complete system 4-port screw cap



DWK Life Sciences

For sterile transfer of media or for feeding solvent to HPLC instruments. The bottle is pressure/vacuum resistant from -1 to +1.5 bar (tested by TÜV in accordance with EN 1596, GS marked). Complete with a 4-port screw cap (autoclavable, reusable) made from PP, 4 connection screw caps (black, M8 thread) and silicone seal. Suitable for tube diameters of 1.6mm and 3.2mm. Spare parts are available individually. Further connection system components for the GL45 thread are available upon request (Tubing not included). Neutral/Type I glass acc. to USP/EP. With Retrace Code (Batch Identification), with certificate available via the internet. Autoclavable.

Capacity ml	PK	Cat. No.
500	1	9.072 526
1000	1	9.072 525



2 HPLC reservoir bottles DURAN®, borosilicate 3.3 glass, with conical base



DWK Life Sciences

The DURAN® reservoir bottles have been designed for use in high-performance liquid chromatography (HPLC) and allows longer, uninterrupted analyses. A central cavity in the bottom of the bottle allows mobile phases and solvents to be dispensed without tilting the bottle. Side vent hole in the base for ultrasonic bath degassing, or water drainage after cleaning. Screw caps HPLC (PTFE, GL 45, 3 ports) available as accessories.

- GL 45 Thread
- ISO 3585
- Type I neutral glass, by USP/EP
- With Retrace Code and certificate for manufacturing lot traceability
- Available in four sizes: 1, 2, 5, or 10 Litres
- 5 and 10 litre bottles can accommodate magnetic stirring bars
- Durable white enamel volume graduations
- Autoclavable at 121°C or 134°C

Nominal capacity ml	Diam. mm	Height mm	Neck thread GL	PK	Cat. No.
1000	110	295	45	1	4.665 543
2000	145	309	45	1	4.665 544
5000	190	386	45	1	4.665 545
10000	235	481	45	1	4.665 546



3 4 Flexible connecting system for DURAN® GL 45 flasks



DWK Life Sciences

For safe transfer of liquid media within a closed and sterile system (evaporation is reduced).

- Screw closure GL 45 with two, three or four ports GL 14 thread
- Autoclavable
- Temperature resistant up to max. 140 °C
- Flexible modular system
- Sterile pressure equalisation is possible through use of a membrane filter
- Unused ports can be provided with a blind cap



Description	PK	Cat. No.
Screw cap GL 45, 2 ports x GL 14	1	6.227 780
Screw cap GL 45, 3 port x GL 14	1	7.623 018
Screw cap GL 45, 4 ports (4 x M8 screw caps, 12 x silicone seals)	1	6.226 328
Screw cap GL 14 for tubing connector	1	6.227 781
Screw cap, PBT with PTFE coated seal, GL 14, red	1	7.623 838
Liner for GL 14 screw cap, 1.6 mm i.d. hole	1	6.229 494
Liner for GL 14 screw cap, 3 mm i.d. hole	1	6.229 495
Liner for GL 14 screw cap, 3.2 mm i.d. hole	1	6.230 213
Liner for GL 14 screw cap, 6 mm i.d. hole	1	6.227 782
Pressure equalising set, for 2- and 3-Port screw cap, incl. 0.2 µm membrane filter, GL 14	1	6.228 023
Pressure equalising set, 4-Port screw cap, incl. 0.2 µm membrane filter	1	6.226 915
Spare set for HPLC screw cap	1	6.226 329
Membrane filter for pressure equalisation, 0,2 µm	1	6.230 844

1

6.313 835

b.safe-Caps, GL45, PPS

NEW

b.safe

Screw cap for thread GL 45 made of PPS, freely turnable distributor body made of PTFE with female threads UNF 1/4" 28 G for connecting capillary tubing (O. D. 3.2 mm) or a b.safe air valve.

Scope of supply:

Cap A: 2 x connections, 1 x fitting (PFA), 1 x air valve

Cap B: 3 x connections, 2 x fittings (PFA), 1 x blind fitting (PFA), 1 x air valve

Cap C: 4 x connections, 3 x fittings (PFA), 2 x blind fittings (PFA), 1 x air valve

Type	Thread	PK	Cat. No.
A	GL 45	1	6.313 834
B	GL 45	1	6.313 835 1
C	GL 45	1	6.313 836

2

2 Air valves, PP

NEW

b.safe

Red/yellow. With connecting thread UNF 1/4" 28G. Filter membrane made of PTFE/PP with a porosity of 1 µm and integrated non-return valve made of silicone. With service life indicator.

Diam.	Life time	PK	Cat. No.
mm			
20	6 months	2	6.313 842
20	6 months	10	6.313 843
20	6 months	50	6.313 844

3

6.313 837

WasteCaps, GL 45, PPS

NEW

b.safe

Screw cap for thread GL 45 made of PPS, freely turnable distributor body made of PTFE with female threads: UNF 1/4" 28 G for connecting capillary tubing (O. D. 1.6, 2.3 or 3.2 mm) or NPT 1/8" for a hose connector for flexible tubing with I.D. 6.4 or 9 mm, GL 14 for connecting a b.safe exhaust filter (not included).

Scope of supply:

Cap A: Connections: 3 x UNF 1/4" 28G, 1 x GL 14, Fittings: 3 x 1.6 mm, 3 x 2.3 mm, 2 x 3.2 mm, 2 x blind fittings

Cap B: Connections: 2 x UNF 1/4" 28G, 1 x NPT 1/8", 1 x GL 14, Fittings: 2 x 1.6 mm, 2 x 2.3 mm, 2 x 3.2 mm, 1 x hose connector, 2 x blind fittings

Type	Thread	PK	Cat. No.
A	GL 45	1	6.313 837 3
B	GL 45	1	6.313 838

4

6.313 840

Exhaust Filter, PP

NEW

b.safe

Lid with integrated ventilation openings and service life indicator. The filling of activated carbon is protected by two porous membranes made of PE. This allows an unobstructed flow of exhaust air, solvents are adsorbed by the activated carbon and only filtered air streams out.

Type	Life time	Neck thread GL	PK	Cat. No.
SMALL	3 months	14	2	6.313 839
MEDIUM	6 months	14	2	6.313 840 4
LARGE	6 months	14	2	6.313 841

b.safe-Caps Starter Boxes, GL 45, PPS



1

Initial equipment for HPLC with b.safe-Caps for bottles with thread GL 45. Furthermore fittings for easy connection of capillary tubing, blind fittings for closing unused connections and air valves for a trouble-free withdrawal of solvents are included.

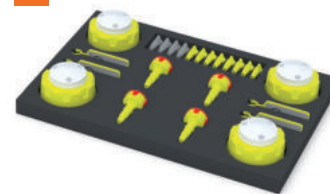

6.313 846

Scope of supply:

Starter Box 1:

- 3 x b.safe-Cap GL 45 with 2 connections UNF 1/4" 28G
- 1 x b.safe-Cap GL 45 with 3 connections UNF 1/4" 28G
- 4 x Air valve with service life indicator
- 5 x Fittings yellow for tubing O.D. 3.2 mm
- 1 x Blind fitting

Starter Box 2:

- 4 x b.safe-Cap GL 45 with 3 connections UNF 1/4" 28G
- 8 x Air valve with service life indicator
- 4 x Fittings yellow for tubing O.D. 3.2 mm
- 4 x Blind fittings

Type	Thread	PK	Cat. No.
Starter Box 1	GL 45	1	6.313 845
Starter Box 2	GL 45	1	6.313 846 1

2 3 SafetyCaps Generation 2.0 for HPLC solvent supply

Maximum safety for HPLC solvent supply. The integrated air valve (B) blocks hazardous vapours and cleans the inflowing air (M) from dust and dirt particles.

S.C.A.T.

2

- Protection against escaping solvent vapours
- Solvents (L) und and mixtures remain clean and stable
- No twisted tubing, easy container exchange
- No air intake in to the HPLC system
- Reproducible analytical results through stable mobile phase
- Use the supplied blind plugs to tighten connections which are temporarily inactive or not in use
- Air valve (B) with PTFE filter (G) and Luer-Lock adapter (A)
- Valve membrane (H) optimized for analytical and preparative flow rates
- Improved PFA fittings (C)
- Body (D/I) made of medical grade PTFE, food safe, FDA conform
- Screw cap (F) made of PPS, autoclavable/sterilisable up to 200 °C
- PTFE and PPS with excellent chemical resistance and flammability classification V-0 (UL-94)
- Insertion label (E) for individual inscription
- Improved FKM seal (J) for stable fit on any bottle
- Improved ergonomics and construction (K)

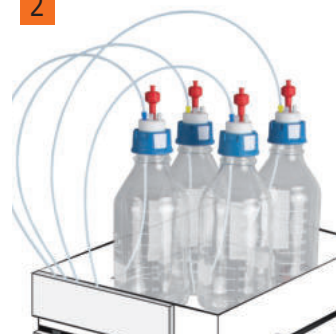

3

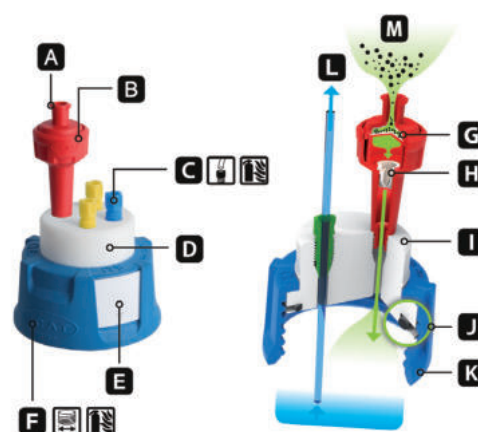

4 SafetyCaps Generation 2.0, GL 45



4

Safe solvent supply. With integral air filter vent. For maximum efficiency, we recommend that the vent is changed every 6 months. The filter membrane absorbs dust and dirt particles to protect your solvent reservoirs. The vent is universally suitable for all SafetyCaps. It also works with your current SafetyCaps, simply replace the old vent with the new one.

Description	Connections	Thread	PK	Cat. No.
SafetyCaps I (V 2.0)	1 capillary (3.2mm o.d.)	GL 45	1	4.669 370
SafetyCaps II (V 2.0)	2 capillaries (3.2mm o.d.)	GL 45	1	4.669 371
SafetyCaps III (V 2.0)	3 capillaries (3.2mm o.d.)	GL 45	1	4.669 372
SafetyCaps IV (V 2.0)	4 capillaries (3.2mm o.d.)	GL 45	1	4.669 373
SafetyCaps VI (V 2.0)	6 capillaries (3.2mm o.d.)	GL 45	1	4.669 374



1

1 Air valves Generation 2.0 for SafetyCaps

NEW

S.C.A.T.

- Thread size UNF 1/4" 28G
- Luer Lock adapter
- PTFE Filter
- Valve membrane blocks vapours and opens at negative pressure
- It is recommended to replace the valve every 6 months

Type	Flow rate amount ml/min	PK	Cat. No.
Air valves 2.0	400	1	4.669 375
Air valves 2.0 (refill pack of 10)	400	10	4.669 376
Air valves 2.0 (refill pack of 50)	400	50	4.669 377

2

4.669 378

HPLC starter kits Generation 2.0, GL 45

NEW

S.C.A.T.

- Complete set for one HPLC system with up to 4 solvent reservoirs
- Price advantage compared to ordering piece by piece
- Suitable for all current HPLC systems
- Use the supplied blind plugs to tighten connectors which are temporarily inactive or not in use

Contents of the different sets:

HPLC SafetySet 1: 3 x SafetyCaps I (V 2.0), 1 x SafetyCap II (V 2.0), 1 x blind plug UNF 1/4" 28G, 4 x air valve

HPLC SafetySet 2: 4 x SafetyCaps II (V 2.0), 4 x blind plug UNF 1/4" 28G, 4 x air valve

HPLC SafetySet 3: 4 x SafetyCaps III (V 2.0), 8 x blind plug UNF 1/4" 28G, 12 x fitting 1.6 mm, 12 x fitting 2.3 mm, 12 x fitting 3.2 mm, 4 x air valve, 8 x insertion label

3

4.678 694

Type	PK	Cat. No.
HPLC safety set 1	1	4.669 378 2
HPLC safety set 2	1	4.669 379
HPLC safety set 3	1	4.678 694 3

4

9.139 809

7 SafetyWasteCaps for HPLC waste

Collect fluid waste safely for protection of health and environment: SafetyWasteCaps block hazardous solvent vapours and provide safe pressure equalisation within the waste container. Due to high end materials, the caps are chemically resistant even against aggressive organic solvents.

S.C.A.T.

- The exhaust filter (A) catches escaping solvent vapours (B)
- The active carbon (C) provides an active filtering surface of 1.200m²/g - optimised for solvent vapours
- Pre-filter (D) for optimised air flow
- Afterfilter (E) provides safe enclosure and keeps the filter clean
- Tubing and capillaries remain safely fixed (F)
- No twisted tubing, freely rotatable cap enables easy container exchange (G)

5

9.139 867

- Body (H) made of medical grade PTFE, food safe, FDA conform
- Screw cap (G) made of PPS, autoclavable/sterilisable up to 200 °C
- PTFE and PPS material provides excellent chemical resistance and flammability classification V-0 (UL-94)
- Improved FKM seals (I) for maximum tightness
- Improved PFA fittings (F)
- Improved ergonomics, stable construction

6

6.314 960

Further thread sizes and configurations are available on demand. Fittings for capillary/tubing connections are included in delivery. Please choose a filter size and order your exhaust filter separately (see chapter "Exhaust Filters for SafetyWasteCaps").

Thread	Connection diam. outside	Connection diam. inside	PK	Cat. No.
S40/GL40	2 x 2,3 / 3,2 mm	1 x 6,4 ... 9,0 mm	1	9.139 896
S40/GL40	3 x 2,3 / 3,2 mm	-	1	7.628 820
GL 45	2 x 2,3 / 3,2 mm	1 x 6,4 ... 9,0 mm	1	9.139 809 4
GL 45	3 x 2,3 / 3,2 mm	-	1	9.139 806
GL 45	4 x 2,3 / 3,2 mm	1 x 6,4 ... 9,0 mm	1	6.312 280
S51	2 x 2,3 / 3,2 mm	1 x 6,4 ... 9,0 mm	1	4.005 583
S55	2 x 2,3 / 3,2 mm	1 x 6,4 ... 9,0 mm	1	4.005 584
S60/61	3 x 2,3 / 3,2 mm	-	1	9.139 867 5
S60/61	2 x 2,3 / 3,2 mm	1 x 6,4 ... 9,0 mm	1	9.139 868
S60/61*	3 x 1,6 / 3 x 2,3 / 3 x 3,2 mm	3 x 6,4 ... 9,0 mm	1	6.314 960 6
S70/71	2 x 2,3 / 3,2 mm	1 x 6,4 ... 9,0 mm	1	4.005 585
S90	4 x 2,3 / 3,2 mm	1 x 6,4 ... 9,0 mm	1	9.139 870

* contains blind plugs and tube connectors

7

1 | 2 Exhaust filters for SafetyWasteCaps 2.0

NEW

The exhaust filter cleans the exhaust air of the HPLC waste containers. It protects operators and environment from harmful solvent vapours. The S.C.A.T. active carbon is optimised to adsorb organic solvents, and offers an active filtering surface of 1200 m²/g. The splash guard avoids contamination of the filter by dripping or spilled liquids. Depending on the required capacity, 3 different filter sizes with different service lives are available.

S.C.A.T.

Description	Filter size	Life time	Neck thread GL	PK	Cat. No.
With interchangeable label + splash guard	M	6 months	14	1	4.669 380 3
Supply pack with interchangeable label + splash guard	M	6 months	14	2	4.669 381
With change indicator + splash guard	M	6 months	14	1	4.669 382 4
Supply pack with change indicator + splash guard	M	6 months	14	2	4.669 383



5 Thread adapters for SafetyCaps/SafetyWasteCaps, female/male thread

Use SafetyCaps and SafetyWasteCaps also for bottles with GL40 or GL38 thread. Further adapters in different thread sizes are available on request.

S.C.A.T.

Thread inside	Thread outside	Material	Colour	PK	Cat. No.
GL38	GL45	PTFE	white	1	9.139 882
S40/GL40	GL45	PTFE	white	1	9.139 883
S3B	GL45	PTFE	white	1	4.005 456
GL45	S55	PTFE	white	1	4.005 791
S42	GL45	PP	clear	1	4.005 950



Tube fittings for the tube connector Safety Waste Caps

Connectors for variable tube connector sizes on Safety Waste Caps. Further configurations available on request.

S.C.A.T.

Description	Int. diam. mm	Material	PK	Cat. No.
Tube fitting, curved	6,4-9,0	PP	1	7.940 304 6
Tube fitting, straight	3,0-4,0	PP	1	4.005 558
Tube fitting, straight for capillary connector	6,0-8,0	PP	1	4.005 793 7
Tube fitting, angled	9,5-10,0	PP	1	4.005 556



10 SafetyWasteCaps with safety funnel for liquid waste

The safety funnel with shut-off valve is operated manually during the disposal of liquids. The safety funnel with automatic closure shuts the container automatically when releasing the button. In both versions, the port for the exhaust filter is integrated for optimum protection against vapors. Each cap is equipped with variable connections for capillaries and tubes. Further thread sizes with safety funnel are available on request.

S.C.A.T.

Please choose a filter size and order your exhaust filter separately (see chapter "Exhaust filters for SafetyWasteCaps").

Thread	Connection diam. outside	Connection diam. inside	PK	Cat. No.
S50	2x 2.3/3.2 mm	-	1	9.139 874
S55	2x 2.3/3.2 mm	-	1	9.139 875
S51*	2x 2.3/3.2 mm	1x 6.4-9.0 mm	1	6.266 051 8
S51	2x 2.3/3.2 mm	1x 6.4-9.0 mm	1	6.264 449
S60/61	2x 2.3/3.2 mm	-	1	9.139 876 9

* with shut-off valve.



14. Chromatography

Liquid chromatography/Solvent storage/handling

1



4.005 613

2 SafetyWasteCaps with mechanical level control

The red floater is immediately visible when the container has reached the critical fill level. Perfect for canisters of opaque material, where the fill level is not visible from the outside.

S.C.A.T.

- Approved S.C.A.T. technology of the SafetyWasteCaps
- Different thread sizes
- Connections for capillaries and tubings
- Mechanical or electronic (E) level control
- With connection for S.C.A.T. exhaust filters

Please choose a filter size and order your exhaust filter separately (see chapter "Exhaust filters for SafetyWasteCaps").

Further thread sizes are available on request.

2



Thread	Connection diam. outside	Connection diam. inside	PK	Cat. No.
S55	2x 2.3/3.2 mm	1x 6.4-9.0 mm	1	4.005 612
S60/61	2x 2.3/3.2 mm	1x 6.4-9.0 mm	1	4.005 613 1
S90	4x 2.3/3.2 mm	1x 6.4-9.0 mm	1	4.005 616
B83	4x 2.3/3.2 mm	1x 6.4-9.0 mm	1	4.005 717

Collectors for tube connector for SafetyWasteCaps

Collectors for additional parts to add more tubings and capillaries. Delivered with fittings. Further configurations available on request.

S.C.A.T.

Description	Material	PK	Cat. No.
3 x connectors (90°) for 3 capillaries diam. 2.3/3.2mm o.d.	PTFE/PFA/PP	1	9.139 888 3
3 x connectors (90°) for 2 capillaries diam. 2.3/3.2mm o.d. and 1 tubing diam. 6.4-9.0mm i.d.	PTFE/PFA/PP	1	4.005 859 4
3 x connectors (straight) for 3 capillaries diam. 6.4mm i.d.	PTFE/PP	1	6.262 289 5
2 x connectors (90°) for 3 tubings diam. 6.4-9.0mm i.d.	PTFE/PP	1	4.005 865 6
2 x connectors (straight) for 2 capillaries diam. 2.3/3.2mm o.d.	PTFE/PFA	1	4.005 866
3 x connectors (straight) for 3 capillaries diam. 2.3/3.2mm o.d.	PTFE/PFA	1	4.005 860
8 x connectors (straight) for 8 capillaries diam. 2.3/3.2mm o.d.	PTFE/PFA	1	9.139 889
8 x connectors (straight) for 7 capillaries diam. 2.3/3.2mm o.d. and 1 tubing diam. 6.4mm i.d.	PTFE/PFA/PP	1	4.005 976 7

3



9.139 888

4



4.005 859

5



6.262 289

6



4.005 865

7



4.005 976

We can **supply** this
manufacturer's
 whole
product range !



1 Fittings and Ferrules for capillary connector for SafetyCaps/SafetyWasteCaps

Fittings with integrated ferrule for SafetyCaps and SafetyWasteCaps.
Use the blind plugs to tighten connectors which are temporarily inactive or not in use.

S.C.A.T.

Description	Material	Colour	Outer diam. mm	PK	Cat. No.
Fittings for capillaries	PFA	green	1.6	5	6.241 792
Fittings for capillaries	PTFE	white	1.6	10	4.005 444
Fittings for capillaries	PFA	violet	2.3	5	6.255 961
Fittings for capillaries	PTFE	white	2.3	10	4.005 445
Fittings for capillaries	PFA	black	3.2	5	9.042 891
Fittings for capillaries	PFA	blue	3.2	5	9.042 892
Fittings for capillaries	PFA	yellow	3.2	5	9.042 893
Fittings for capillaries	PTFE	white	3.2	10	4.005 446
Fittings for capillaries	PTFE	white	4.76 (3/16")	1	4.005 448
Fittings for capillaries	PTFE	white	6.35 (1/4")	1	4.005 447
Blind plugs for capillary connections	PFA	neutral	1.6/2.3/3.2	10	9.139 890 ²
Blind plugs for capillary connections	PTFE	white	4.76	5	4.005 945
Blind plugs for capillary connections	PTFE	white	4.76	10	4.005 880
Blind plugs for charcoal filter connections	PTFE/VITON	white/black	-	1	4.005 504 ³
Blind plug for tubing connection	PTFE	white	-	1	4.005 883 ⁴



5 Inlet filter for solvents

HPLC solvent filters for 3.2mm OD tubing.

S.C.A.T.

Description	PK	Cat. No.
HPLC solvent filter, PP, for 1/8" dia. (3.2mm o.d.)	5	4.005 890
HPLC solvent filter, PFA/PTFE, for 1/8" (3.2mm o.d.)	5	4.005 891



6 Flanged Tubing, PTFE, PA

Flanged PTFE tubing with black tube end fittings UNF 1/4" 28 G made of PP and washers made of PA. The tubing is ready for use. Temperature resistant from 0 to +100 °C, pressure resistant up to 30 bar, universal chemical resistance.

BOLA

Int. diam. mm	Ext. diam. mm	Overall length mm	PK	Cat. No.
0.8	1.6	100	1	6.231 140
0.8	1.6	250	1	6.078 162
0.8	1.6	750	1	6.263 025
0.8	1.6	1000	1	6.801 712
1.6	3.2	100	1	6.262 704
1.6	3.2	250	1	6.237 591
1.6	3.2	500	1	6.071 880
1.6	3.2	750	1	6.258 092

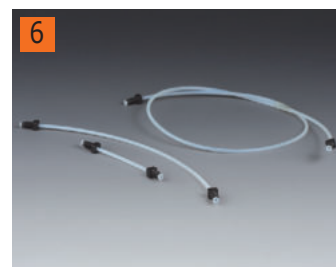

7 8 Multiple bottle distributors, HDPE

The S.C.A.T. system for solvent safety remains permanently closed, the "safety chain" is not interrupted during the rinsing process of the HPLC system. After the analysis has been completed, the system is cleanly returned to its original state.

S.C.A.T.

- Up to 4 SafetyCaps can be installed on the rinsing bottle
- Simple and safe handling due to firmly seated capillaries
- GLS 80 (w) thread
- 4 x GL 45 (m) connections
- Electrically conductive

Connections	Material	PK	Cat. No.
4 x GL 45	HDPE	1	4.665 768



1

1 Hydrogen generator Precision Hydrogen SL

NEW

Peak Scientific

The smallest hydrogen generator from the Precision Hydrogen SL line, safely and continuously produces laboratory-grade hydrogen, with a purity of 99.9995 %, for GC-FID. This generator comes in a choice of manual water fill, auto water fill or with pressurised water fill.

- Minimal hydrogen storage in the system
- Very low maintenance requirements
- Auto-shutdown fail-safe

Specifications

Purity:	99.9995 %
Max. pressure:	6.9 bar
Required water quality:	<1.0 µS/cm
Gas connection:	1 x 1/8" Swagelok compression fitting
Permissible ambient temperature:	10 ... 35 °C
Dimensions (W x D x H):	160 x 355 x 250 mm
Weight:	8.0 kg
Power supply:	100 ... 240 V, 50/60 Hz
Warranty:	2 years

Type	Description	Flow rate L / min.	Colour	PK	Cat. No.
SL 100	With manual water fill	100	black	1	4.678 137
SL 100	With manual water fill	100	white	1	4.678 138
SL 100	With auto water fill	100	black	1	4.678 139
SL 100	With auto water fill	100	white	1	4.678 140
SL 100	With pressurised water fill	100	black	1	4.678 141
SL 100	With pressurised water fill	100	white	1	4.678 142
SL 200	With manual water fill	200	black	1	4.678 143
SL 200	With manual water fill	200	white	1	4.678 144
SL 200	With auto water fill	200	black	1	4.678 145
SL 200	With auto water fill	200	white	1	4.678 146
SL 200	With pressurised water fill	200	black	1	4.678 147
SL 200	With pressurised water fill	200	white	1	4.678 148

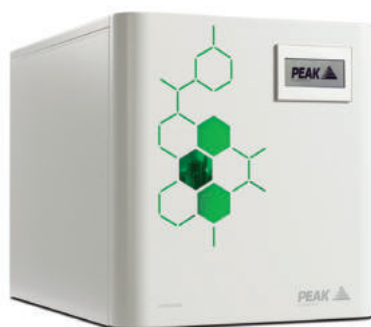
2

2 Hydrogen generators Precision Hydrogen

NEW

Peak Scientific

For the safe and continuous production of hydrogen with a purity of 99.9995% for GC and GC/MS.

- On-demand generation of high-purity hydrogen as detector gas for the FID
- Compact, modular and stackable system
- Hydrogen production from deionised water using proton exchange membrane
- Internal leakage detection with automatic switch-off function
- Minimal hydrogen storage in the system
- Front LED touch screen with status display
- Can be individually combined with PEAK zero nitrogen and zero air systems
- Systems are available with different flow rates
- Very low maintenance requirements
- 3 years warranty on the hydrogen cell

Scope of supply: Hydrogen generator, 1 m Tygon® tubing, Deioniser column refill, barbed hose fitting, mains power cable for EU, UK and US, 2 x transit plugs

Specifications

Purity:	99.9995 %
Max. pressure:	6.9 bar/100 psi
Required water quality:	<1.0 µS/cm
Gas connection:	1/8" Swagelok
Permissible ambient temperature:	10 ... 35 °C
Dimensions (W x D x H):	380 x 540 x 406 mm
Power supply:	110/230 V, 50/60 Hz
Warranty:	3 years (cell)/1 year (device)

Type	Flow rate L / min.	Weight kg	PK	Cat. No.
Precision Hydrogen 100	0.10	29	1	4.669 273
Precision Hydrogen 200	0.20	29	1	4.669 274
Precision Hydrogen 300	0.30	29	1	4.669 275
Precision Hydrogen 450	0.45	29	1	4.669 276
Precision Hydrogen 1200	1.20	38	1	4.669 277

1 Nitrogen generators Precision Nitrogen**NEW****1**

Peak Scientific

Nitrogen generators for the GC. For safe and continuous production of nitrogen with a purity of 99.9995%.

- On-demand generation of nitrogen as purge gas and for sample preparation in standard analyses
- Compact, modular and stackable system
- Constant and uniform supply for reliable and reproducible analyses
- Can be individually combined with PEAK hydrogen and zero air generators
- No contamination of the system
- Very fast start time and rapid achievement of the required operating purity
- Available with different flow rates
- Generator for headspace requirements available, compatible with most headspace samplers
- Very low maintenance requirements

Scope of supply: Nitrogen generator, 1 m PTFE tubing, 1/4" compression fitting, 1/8" compression fitting, mains power cable for EU, UK and US

**Specifications**

Purity:	99.9995 %
Gas connection:	1/4"
Permissible ambient temperature:	5 ... 35 °C
Dimensions (W x D x H):	380 x 540 x 256 mm
Power supply:	110/230 V, 50/60 Hz
Warranty:	1 year

Type	Flow rate L / min.	Pressure max. bar	Weight kg	PK	Cat. No.
Precision Nitrogen 250	0.25	5.5 (80 psi)	21	1	4.669 267
Precision Nitrogen 600	0.60	5.5 (80 psi)	21	1	4.669 268
Precision Nitrogen 1000	1.00	5.5 (80 psi)	26	1	4.669 269

2 Zero Air generators Precision Zero Air**NEW****2**

Peak Scientific

Generates clean, dry and hydrocarbon-free air for FIDs in GC. Also meets the purity requirements for trace analysis.

- Fail-safe, continuous generation of zero air
- Hydrocarbon content <0.05 ppm
- Modular design and combination option with other PEAK Precision devices
- Minimal maintenance
- No replacement of the catalyst chamber required
- Compatible with the Precision Air Compressor
- Status display

Scope of supply: Zero air generator, 3 m PTFE tubing, 1/4" compression fitting, 1/8" compression fitting, mains power cable for EU, UK and US

**Specifications**

Hydrocarbon content:	<0.05 ppm
Permissible ambient temperature:	5 ... 35 °C
Power supply:	110/230 V, 50/60 Hz
Warranty:	1 year

Type	Flow rate L / min.	Pressure max. bar	Weight kg	External dimensions (W x D x H) mm	PK	Cat. No.
Precision Zero Air 1.5L	1.5	5.5 (80 psi)	16	380 x 540 x 156	1	4.669 281
Precision Zero Air 3.5L	3.5	5.5 (80 psi)	16	380 x 540 x 156	1	4.669 282
Precision Zero Air 7L	7.0	5.5 (80 psi)	25	380 x 540 x 256	1	4.669 283
Precision Zero Air 18L	18.0	5.5 (80 psi)	25	380 x 540 x 256	1	4.669 284
Precision Zero Air 30L	30.0	6.9 (100 psi)	41	380 x 540 x 405	1	4.669 285

1

1 Air compressor for GC

NEW

For compressed air supply of Precision nitrogen and zero air generators for the GC.

Peak Scientific

- For simultaneous supply of nitrogen and zero air generators in one stack
- Can be stacked and combined with all Precision modules
- Very quiet and low-vibration operation
- With maintenance and repair status displays

Scope of supply: 3 m PTFE tubing, 2 x 1/4" compression fitting, 1/4" tee compression fitting, 2.5 mm hex key, mains power cable for EU, UK and US

Specifications:

Max. pressure:	8.27 bar/120 psi
Gas connection:	1/4"
Permissible ambient temperature:	5 ... 35 °C
Dimensions (W x D x H):	380 x 540 x 406 mm
Weight:	42 kg
Power supply:	208 ... 230 V, 50/60 Hz
Warranty:	1 year

Type	PK	Cat. No.
Precision Air Compressor	1	4.669 286

2

2 Gas chromatography flow meter GF500

Carl Stuart Limited

Convenient digital flow meter for the simple, accurate and repeatable measurement of flow in gas chromatographs. User friendly, handy design. Can be used with the carrier gases Air, Hydrogen, Nitrogen, Helium, Carbon dioxide, Argon and Argon/Methane. OLED display shows flow rate and further information. With pressure and temperature compensation. Suitable for columns with diameters of 100, 180, 200, 250, 320, 450, 530 and 750 µm.

- Measurement of flow rate, linear velocity and split ratio
- High resolution
- 25 point calibration, traceable to National Standards
- Rechargeable battery
- Auto power off

Scope of supply: Flow meter with case, tubings, tubing adapter fittings, tubing clips, tie-wraps, universal charger with USB connector, operation manual, calibration certificate.

Please order adapters for direct connection to the detector separately.

Specifications

Range:	0... 500 ml/min. (0... 300 ml CO ₂)
Accuracy:	0.4 ml/min./±2.5 %
Resolution:	0.1 ml/min.
Operating temperature:	15... 35 °C, calibrated at 21±2 °C
Inlet pressure:	max. 175 kPa
Dimensions:	68 x 30 x 130 mm
Weight:	150 g

Type	PK	Cat. No.
GF500 flow meter set	1	4.661 928

3

4.661 930

Accessories for gas chromatography flow meters GF500/GF1000

Adapters for detectors and other accessories.

Carl Stuart Limited

Type	PK	Cat. No.
Adapter for FID detectors	1	4.661 929
Adapter for ECD detectors	1	4.661 930 3
Adapter for TCD detectors	1	4.661 931
Adapter for NPD detectors	1	4.661 932
Split vent adapter	1	4.661 933
Calibration for GF500	1	4.661 935
Calibration for GF1000	1	6.276 162

1 Gas chromatography flow meter GF1000



1

Carl Stuart Limited

Very robust, portable device for measuring the flow rate of gas chromatographs and for calibrating air sampling canisters. Measurement is performed in real time, allowing simultaneous flow and pressure measurement to improve validation efficiency. Reduces downtime.

- For real-time measurement of more than 30 common gases over a wide range
- Check the volume flow, mass flow, pressure and temperature at the inlet and detector outlet of the GC
- Flow calibration with NIST-traceable accuracy
- Immediately ready for use after switching on, measurement completed within 20 seconds
- Fast response time of 10 ms
- TFT display
- RS232 interface for data transfer
- 18 hours battery life

Scope of supply: GC flow meter, hard-shell carrying case, spare tubings, tubing connector fittings, power supply with adapters for EU, UK, CH and US



Specifications

Range:	0.1 ... 1000 ml/min
Accuracy:	±0.8 % of reading, 0.2 % of full scale
Resolution:	0.1 ml/min
Turn-down Ratio:	200:1
Operating temperature:	-10 ... 60 °C
Inlet pressure:	max. 1000 kPa (145 psi)
Dimensions:	60 x 170 x 24 mm
Weight:	450 g

Type	PK	Cat. No.
GF1000 flow meter set	1	6.276 103

2 Gas filters



2

Trajan Scientific

Gas filters are an essential part of GC analysis as contaminants in gases can significantly impact the quality of results. Oxygen, hydrocarbons and moisture can lead to problems such as noisy baselines, moisture entering the GC column and excessive bleed. The gas filter kit consists of a gas filter and a connection unit.

- Fast stabilization times
- The gas filter system consists of two key parts: the filters and the connecting unit
- The connecting unit has inlet and outlet connectors for the gas lines
- The connecting unit can be bench or wall-mounted
- Can be used in combination with other filters
- Indicator color change tells you when to change your filter



Type	Description	PK	Cat. No.
Gas filter carrier gas	Removes water, oxygen and organic compounds	1	4.676 268
Gas filter moisture	Removes water, oil and other foreign material	1	4.676 270
Gas filter oxygen	Removes oxygen as well as traces of sulfur and chlorine compounds	1	4.676 271
Kit gas filter carrier gas	Removes water, oxygen and organic compounds, incl. connection unit	1	4.676 269

3 Gas filters big trap



3

Trajan Scientific

Gas filters are an essential part of your GC analysis as contaminants in gases can significantly impact the quality of results. Oxygen, hydrocarbons and moisture can lead to problems such as noisy baselines, moisture entering the GC column and excessive bleed.

- Heavy-walled aluminium tube
- High capacity filters
- Sintered stainless steel frits prevent particulate contamination

Specifications

Volume:	750 cm ³
Pressure rating:	up to 17.2 bar

Type	PK	Cat. No.
Universal	1	4.676 267



1

1 Optima® WAX capillary columns for GC

polyethylene glycol 20000 daltons

MACHEREY-NAGEL

USP G16
 polar phase
 recommended for solvent analysis and alcohols
 suitable for aqueous solutions
 similar phases: Premabond® CW 20 M , DB-Wax, Supelcowax, HP-Wax, HP-INNOWAX, Rtx-Wax, CP-Wax 52 CB, Stabilwax, 007-CW, BP20, AT-Wax, ZB-Wax

max. temperature for isothermal operation 240°C, max. temperature for short isotherms in a temperature programme: 250°C, for 0.53 mm ID columns the max. temperatures are 220 and 240°C, resp.

Int. diam. mm	Ext. diam. mm	Film thickness µm	Length m	PK	Cat. No.
0.25	0.4	0.25	25	1	9.003 762
0.25	0.4	0.25	30	1	9.003 763
0.32	0.5	0.25	30	1	9.003 767
0.32	0.5	0.50	30	1	9.003 771
0.53	0.8	1.00	25	1	4.003 175
0.53	0.8	1.00	30	1	4.003 176
0.53	0.8	2.00	30	1	4.003 174

Custom-made columns to your specifications available on request.

Each column is individually tested and supplied with test certificate and test chromatogram, but without fittings or ferrules. Column ends are melted or closed with septa. Additionally, we supply the corresponding test mixture with each column.

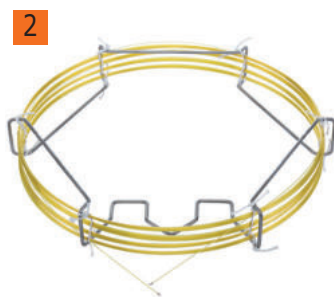
2

2 OPTIMA® 5 MS Accent capillary columns for GC

silarylene phase

MACHEREY-NAGEL

- With polarity similar to a 5 % diphenyl -95 % dimethylpolysiloxane phase.
- USP G27, G36
- Lowest column bleed, nonpolar phase, ideal for ion trap and quadrupol MS detectors solvent rinsing for removal of impurities applicable
- Application areas: all-round phase for environmental analyses, trace analyses, EPA methods, pesticides, PCB, food and drug analyses

similar phases: DB-5 MS, HP-5 MS, Ultra-2, Equity-5, CP-Sil 8 CB low bleed/MS, Rtx-5SIL-MS, Rtx-5 MS, 007-5 MS, BPX5, MDN-5S, AT-5 MS, VF-5 MS

Max. temperature for isothermal operation: 340 °C,
 Max. temperature for short isotherms in a temperature programme: 360 °C
 for cloumns with film thicknesses > 5.5 µm the max. temperatures are 320 and 340 °C

Int. diam. mm	Ext. diam. mm	Film thickness µm	Length m	PK	Cat. No.
0.25	0.4	0.25	30	1	4.003 017
0.25	0.4	0.50	30	1	4.003 019
0.25	0.4	1.00	30	1	4.003 021
0.32	0.5	0.25	30	1	4.003 009
0.32	0.5	0.50	30	1	4.003 013

Each column is individually tested and supplied with test certificate and test chromatogram, but without fittings or ferrules. Column ends are melted or closed with septa, and thus protected from atmospheric oxygen.

Additionally, we supply the corresponding test mixture with each column.

3

3 Capillary columns GC BPX70

70% Cyanopropyl Polysilphenylene-siloxane. Able to be solvent rinsed.
 Industry standard column for fatty acid methyl esters, carbohydrates, pharmaceuticals, GC/MS applications. Suitable alternative to: DB-23, Rtx-2330, SP-2330, CP-Sil 88, SP2380, HP-23.

Trajan Scientific

Int. diam. mm	Length m	Film thickness µm	Temp. range °C	PK	Cat. No.
0.10	10	0.20	50 °C... 250 / 260 °C	1	6.205 237
0.22	25	0.25	50 °C... 250 / 260 °C	1	6.227 373
0.22	50	0.25	50 °C... 250 / 260 °C	1	6.205 238
0.22	60	0.25	50 °C... 250 / 260 °C	1	6.205 239
0.25	60	0.25	50 °C... 250 / 260 °C	1	7.625 713
0.25	120	0.25	50 °C... 250 / 260 °C	1	6.206 833
0.32	60	0.25	50 °C... 250 / 260 °C	1	6.205 100

1 Capillary columns GC BP5MS



5% Phenyl Polysilphenylene-siloxane. For 5% GC-MS analysis and general purpose MS analysis. Suitable replacement for: DB-5ms, ZB-5ms, Rxi-5Sil MS, VF-5ms, CP-Sil 8 CB.

Trajan Scientific

Int. diam. mm	Length m	Film thickness μm	Temp. range $^{\circ}\text{C}$	PK	Cat. No.
0.25	30	0.25	-40 ... 330 / 350	1	4.676 266



2 Capillary columns HT5

5% Phenyl Polycarborane siloxane. Ultra-high temperature columns for simulated distillation applications, general hydrocarbon profiles, pesticides, herbicides and for GCMS applications.

Trajan Scientific

Int. diam. mm	Length m	Film thickness μm	Temp. range $^{\circ}\text{C}$	PK	Cat. No.
0.22	25	0.1	10 $^{\circ}\text{C}$... 380 / 400 $^{\circ}\text{C}$	1	4.667 654
0.25	15	0.1	10 $^{\circ}\text{C}$... 380 / 400 $^{\circ}\text{C}$	1	6.205 471
0.32	12	0.1	10 $^{\circ}\text{C}$... 380 / 400 $^{\circ}\text{C}$	1	6.234 302



3 Capillary columns HT8/Fast PCB

8 % Phenyl Polycarborane-siloxane. Ultra high temperature columns for polychlorinated biphenyl compounds (PCB), nitro-substituted aromatics, polynuclear aromatic hydrocarbons, pesticides and herbicides.

Trajan Scientific

Int. diam. mm	Length m	Film thickness μm	Temp. range $^{\circ}\text{C}$	Type	PK	Cat. No.
0.10	10	0.10	-20 $^{\circ}\text{C}$... 360 / 370 $^{\circ}\text{C}$	Fast PCB	1	6.233 627
0.22	25	0.25	-20 $^{\circ}\text{C}$... 360 / 370 $^{\circ}\text{C}$	HT8	1	6.205 318
0.25	30	0.25	-20 $^{\circ}\text{C}$... 360 / 370 $^{\circ}\text{C}$	HT8	1	6.207 027
0.25	60	0.25	-20 $^{\circ}\text{C}$... 360 / 370 $^{\circ}\text{C}$	HT8-PCB GC	1	4.676 265



4 Capillary columns SolGel-Wax

Polyethylene Glycol (PEG) in a SolGel matrix. Suitable replacement for: DB-Wax, Rtx- Wax, Stabilwax, HP20M, HP-Wax, HP-INNOWax, Supelcowax-10, AT-Wax, Nukol, CP, Wax 52CB, VB-WAX, ZB-WAX.

Trajan Scientific

- Robust high-temperature column.
- Polar phase
- Low bleed and inert

Int. diam. mm	Length m	Film thickness μm	Temp. range $^{\circ}\text{C}$	PK	Cat. No.
0.25	30	0.25	30 $^{\circ}\text{C}$... 260 / 280 $^{\circ}\text{C}$	1	6.225 943
0.32	30	0.50	30 $^{\circ}\text{C}$... 260 / 280 $^{\circ}\text{C}$	1	6.227 192
0.53	30	0.50	30 $^{\circ}\text{C}$... 260 / 280 $^{\circ}\text{C}$	1	6.202 376



5 Capillary columns GC BPX5

5% Phenyl Polysilphenylene-siloxane. General purpose GC column for routine gas chromatographic analyses. Suitable replacement for: DB-5, DB-5ms, DB-5.625, XTI-5, Rtx-5ms, Ultra-2, HP-5, HP-5MS, HP5-TA, SPB-5, MDN-5S, CP-Sil8CB, Rxt-Sil 5MS, AT-5ms, VB-5, ZB-5, VF-5ms.

Trajan Scientific

- Very low bleed
- Non-polar
- Extremely inert

Int. diam. mm	Length m	Film thickness μm	Temp. range $^{\circ}\text{C}$	PK	Cat. No.
0.22	30	0.25	-40 $^{\circ}\text{C}$... 360 / 370 $^{\circ}\text{C}$	1	6.226 218
0.22	50	0.25	-40 $^{\circ}\text{C}$... 360 / 370 $^{\circ}\text{C}$	1	7.639 635
0.25	30	0.25	-40 $^{\circ}\text{C}$... 360 / 370 $^{\circ}\text{C}$	1	6.089 900
0.25	30	1.00	-40 $^{\circ}\text{C}$... 360 / 370 $^{\circ}\text{C}$	1	6.226 546
0.25	60	1.00	-40 $^{\circ}\text{C}$... 360 / 370 $^{\circ}\text{C}$	1	6.234 303
0.32	12	0.25	-40 $^{\circ}\text{C}$... 360 / 370 $^{\circ}\text{C}$	1	6.204 980
0.32	25	0.25	-40 $^{\circ}\text{C}$... 360 / 370 $^{\circ}\text{C}$	1	6.225 537
0.32	30	0.25	-40 $^{\circ}\text{C}$... 360 / 370 $^{\circ}\text{C}$	1	6.205 532
0.32	60	0.25	-40 $^{\circ}\text{C}$... 360 / 370 $^{\circ}\text{C}$	1	7.672 518
0.32	50	0.50	-40 $^{\circ}\text{C}$... 360 / 370 $^{\circ}\text{C}$	1	6.205 984
0.32	12	1.00	-40 $^{\circ}\text{C}$... 360 / 370 $^{\circ}\text{C}$	1	7.635 438



1

1 Capillary, fused silica

Trajan Scientific

Type	Column ID mm	Column OD mm	Length m	PK	Cat. No.
Phenyl deactivated fused silica	0.53	0.68	5	1	6.260 570
Methyl deactivated fused silica	0.53	0.68	5	1	6.284 960
Non deactivated fused silica	0.05	0.22	10	1	6.225 566
Non deactivated fused silica	0.10	0.363	10	1	7.670 948

2

2 Silylation reagents - MSTFA

N-methyl-N-trimethylsilyl-trifluoroacetamide

MACHEREY-NAGEL

 m.w. 199.1, Bp 70°C (75mm Hg), density $d_{20^{\circ}/4^{\circ}} = 1.11$

 MSTFA: R' = CF₃, R'' = CH₃

the most volatile trimethylsilyl amide available

very strong TMS donor which does not cause any noticeable fouling of the FID burning chamber even after long-time measuring series. The already good solution characteristics can be improved by addition of submolar quantities of protic solvents (e.g. TFA for extremely polar compounds such as hydrochlorides) or pyridine (e.g. for carbohydrates).

Warning

H phrases: H226|H302|H315|H319

Description	Capacity ml	PK	Cat. No.
MSTFA	1	20	7.055 892
MSTFA	10	1	6.704 091
MSTFA	10	5	6.085 475
MSTFA	50	6	6.227 450
MSTFA	100	6	4.001 493

Due to their purpose, derivatisation reagents are very reactive substances. For this reason they should be stored cool and protected from moisture.

The derivatisation reagents are supplied in vials with crimp caps for easy access with a syringe. Vials with pierced sealing disks have limited stability and should be used soon.

3

3 4 Silylation reagents - BSTFA, SILYL-991

MACHEREY-NAGEL

N,O-bis-trimethylsilyl-trifluoroacetamide

 m.w. 257.4, Bp 40°C (12mm Hg), density $d_{20^{\circ}/4^{\circ}} = 0.961$

 BSTFA: R = CF₃ powerful trimethylsilyl donor with approximately the same donor strength as the non-fluorinated analogue BSA

advantage of BSTFA over BSA: greater volatility of its reaction products (particularly useful for GC of some lower boiling TMS amino acids.

BSTFA is nonpolar (less polar than MSTFA), and can be mixed with acetonitrile for improved solubility. For silylating fatty acid amides, hindered hydroxyls and other compounds, which are difficult to silylate (like secondary alcohols and amines), we recommend BSTFA + 1% trimethylchlorosilane (TMCS), available under the designation SILYL-991.

Warning

H phrases: H226|H315|H319

4

Description	Capacity ml	PK	Cat. No.
BSTFA	1	20	4.001 486
BSTFA	10	1	6.803 320
BSTFA	10	5	4.001 487
SILYL-991 (BSTFA - TMCS (99:1))	1	20	4.001 511
SILYL-991 (BSTFA - TMCS (99:1))	50	1	4.001 510

Due to their purpose, derivatisation reagents are very reactive substances. For this reason they should be stored cool and protected from moisture.

The derivatisation reagents are supplied in vials with crimp caps for easy access with a syringe. Vials with pierced sealing disks have limited stability and should be used immediately.

5

5 Alkylation reagents for GC - Trimethylsulphonium hydroxide

MACHEREY-NAGEL

TMSH (0.2M in methanol) M.G. 94.06

Danger

H phrases: H225|H301|H311|H331|H370

Description	Capacity ml	PK	Cat. No.
TMSH	1	10	7.086 147
TMSH	1	20	7.083 308
TMSH	10	5	4.001 512

1 Manual Microlitre syringes

Type A: Standard plunger protection syringe
 Type B: Guided plunger syringe

Trajan Scientific

Type	Capacity µl	Needle length mm	Gauge	Needle Typ	PK	Cat. No.
A	5	50	26 (0.47)	fixed	1	6.204 040
B	5	50	26 (0.47)	removable	1	6.050 958

1



Inlet Liner and o-rings for Agilent GC

Inlet Liner for Agilent 5890, 6850, 6890, 7890 und HP4890.
 Trajan's SGE inlet liners come as a complete, single packed unit.

Trajan Scientific

- 5 or 25 packs, individually packed
- Complete with instrument appropriate o-rings and sealing rings
- Each pack is supplied with quality test results

Description	Ext. diam. mm	Int. diam. mm	Length mm	PK	Cat. No.
Split, Straight-through Liner	6.3	4.0	78.5	5	7.653 145 2
Split, with Quartz wool	6.3	4.0	78.5	5	9.003 576
Split / Splitless with Single Taper	6.3	4.0	78.5	5	9.003 579
Split / Splitless with Single Taper (Quartz Wool)	6.3	4.0	78.5	5	6.236 751 3
Split/Splitless FocusLiner®	6.3	4.0	78.5	5	6.223 552
Split/Splitless FocusLiner®	6.3	4.0	78.5	25	6.239 332
Split/Splitless Tapered Focus Liner®	6.3	4.0	78.5	5	6.223 553 4
Split/Splitless Tapered Focus Liner®	6.3	4.0	78.5	25	9.003 572
Split/Splitless FAST FocusLiner®	6.3	2.3	78.5	5	6.223 554
Split/Splitless Tapered FAST FocusLiner®	6.3	2.3	78.5	5	9.003 586
Split/Splitless Recessed Gooseneck (Quartz Wool)	6.3	4.0	78.5	5	9.003 588 5
ConnectTite™ Liner Bottom Hole	6.3	4.0	78.5	5	9.003 587
Viton o-ring, suitable for liners with OD 6.3 mm	6.3	4.0	78.5	10	9.221 277
UI Liner, with Quartz wool	6.3	4.0	78.5	5	6.287 548

2

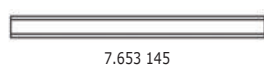

7.653 145

3



6.236 751

4



6.223 553

5

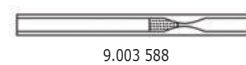

9.003 588

Inlet Liner for Thermo GC

Liners come individually packed complete with instrument appropriate o-rings and sealing rings.
 Each pack is supplied with quality test results. Further liners und pack sizes available on request.

Trajan Scientific

Description	Ext. diam. mm	Int. diam. mm	Length mm	PK	Cat. No.
Split FocusLiner (for use with 50 mm Needle)	8.0	5,0	105	5	6.265 466 6
Splitless FocusLiner (for use with 50mm Needle)	8.0	5,0	105	5	6.265 467 7
Splitless with Single Taper	8.0	5,0	105	5	6.265 468 8
Splitless, Straight-through Liner	8.0	3,0	105	5	6.265 469
Split, Straight-through Liner	8.0	5,0	105	5	6.265 470 9
Trace 2000 PTV Liner	2.7	1,75	120	5	7.630 911

6



6.265 466

7



6.265 467

8



6.265 468

9



6.265 470

Inlet Liner for Shimadzu GC

Liners come individually packed complete with instrument appropriate o-rings and sealing rings.
 Each pack is supplied with quality test results. Further liners und pack sizes available on request.

Trajan Scientific

Description	Ext. diam. mm	Int. diam. mm	Length mm	PK	Cat. No.
Split / Splitless Tapered FocusLiner™	5	3.4	95	5	6.228 225 10
Split / Splitless with middle gooseneck for GC-2010 (SPL-2010)	5	3.4	95	5	6.265 475
Split, Straight-through Liner	5	3.4	95	5	6.265 473 11
Split / Splitless with Single Taper	5	3.4	95	5	6.265 474 12

10



6.228 225

11



6.265 473

12



6.265 474

14. Chromatography

Gas chromatography/GC consumables



6.206 049

Inlet Liner for Perkin-Elmer GC

Inlet Liner for Perkin-Elmer Autosystem and Clarus 500, 600. SGE's inlet liners come as a complete, single packed unit. 5 or 25 packs, individually packed. Complete with instrument appropriate o-rings and sealing rings. Each pack supplied with quality test results.

Trajan Scientific

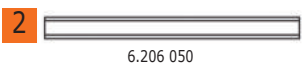

6.206 050



9.003 568

Description	Ext. diam. mm	Int. diam. mm	Length mm	PK	Cat. No.
Split / Splitless Focus Liner	6.2	4	92.0	5	6.206 049 1
Split / Splitless Tapered Focus Liner	6.2	4	92.0	5	9.003 567
Split straight through liner	6.2	4	92.0	5	6.206 050 2
Split / Splitless Focus Liner for PSS Injector	4.0	2	86.2	5	9.003 568 3
PTV liner with 0.25 mm ID restriction	2.0	1	88.0	5	9.003 569



4 Ferrules for Agilent GC

High quality ferrules made of 100% Graphite or 15% Graphite/85% Vespel

Trajan Scientific

Type A: 15% Graphite/85% Vespel, for injectors and detectors at atmospheric pressure (e.g. FID)

Type B: 15% Graphite/85% Vespel, for GC-MS interface connection

Type C: 100% Graphite, for injectors and detectors at atmospheric pressure (not for GC-MS)

Type	Column ID mm	Ferrule ID mm	PK	Cat. No.
A	0,1 - 0,25	0.4	10	6.223 558
A	0,32	0.5	10	9.221 278
A	0,53	0.8	10	9.221 279
B	0,1 - 0,25	0.4	10	6.088 109
B	0,32	0.5	10	6.059 976
B	0,53	0.8	10	6.059 977
C	0,1 - 0,32	0.5	10	7.652 355
C	0,45 - 0,53	0.8	10	9.221 280



5 Ferrules for Perkin-Elmer GC

High quality ferrules made of 100% Graphite or 15% Graphite/85% Vespel

Trajan Scientific

Type A - 15% Graphite/85% Vespel, for injectors and detectors at atmospheric pressure (e.g. FID)

Type C - 100% Graphite, for injectors and detectors at atmospheric pressure (not for GC-MS)

Type	Column ID mm	Ferrule ID mm	PK	Cat. No.
A	0,1 - 0,25	0.4	10	6.088 109
A	0,32	0.5	10	6.059 976
A	0,53	0.8	10	6.059 977
A	0,45 - 0,53	0.8	10	6.281 660
C	0,1 - 0,32	0.5	10	9.221 284
C	0,45 - 0,53	0.8	10	9.221 285



4.668 494



4.668 495

GC Septa

High performance septa, suitable for injector temperatures up to 320 °C.

La-Pha-Pack

- Good penetration and re-sealing properties (low fragmentation)
- Long lifetime
- Ultra low bleeding
- Ready to use, no further pre-treatment necessary
- No sticking to hot surfaces, easily exchangeable
- Standard dimensions for all common gas chromatographs
- For other gas chromatography models on request

Diam. mm	For	PK	Cat. No.
9.5	All Shimadzu models	50	4.668 494 6
11.0	e.g. Agilent 5700 / 5800	50	4.668 495 7
12.5	e.g. Agilent 5890 / 6850 / 6890, Varian 3300 / 3400	50	4.668 496
12.5	e.g. Tracor 220, 222	50	4.668 497
17.0	e.g. Thermo Trace, Fisons 8000 series	50	4.668 498

➔ Consumables from other GC manufacturers on request

1 Septa for Agilent GC

All Septa are made with a high grade silicone material to minimize needle coring. These new materials meet or exceed industry standards, giving you reassurance in the quality of your work. All of these Septa are durable with excellent resealing properties and excellent solvent resistance.

Trajan Scientific

GP = General Purpose Silicone Septa for non-demanding routine applications up to 200°C.
 EC = High Temperature Silicone Septa, for significantly longer injection life, low bleed and low injection port adhesion.
 MN = High Temperature Premium Silicone Septa for autosamplers, up to 400 injections per septum.
 HT = BTO Silicone Septa, Bleed and temperature optimized, combined with outstanding mechanical properties.

Also available: Septa for instruments from Perkin-Elmer, Shimadzu, Thermo and Varian/Bruker.



Diam.	Temp.	Material	PK	Cat. No.
mm	max. °C			
5.0	275	GP	50	9.003 590
5.0	350	MN	50	9.003 591
9.5	275	GP	50	6.224 189
9.5	350	EC	25	9.003 592
9.5	400	HT	25	9.003 593
11.0	275	GP	50	6.085 419
11.0	350	EC	25	9.003 594
11.0	350	MN	48	6.255 348
11.0	400	HT	25	9.003 595
12.5	275	GP	48	6.087 242
12.5	350	EC	25	9.003 597
12.5	400	HT	25	9.003 596

2 Syringes for GC autosampler from Agilent

GC syringes for Agilent autosampler 7673, 7683 and 6850

Trajan Scientific

- With fixed or removable needle
- Two different needle diameter and tapered needles
- High reproducibility, low carry-over

Capacity	Needle length	Gauge (OD)	Needle Typ	PK	Cat. No.
µl	mm	mm			
5	42	23-26s (0.63/0.47)	fixed	1	9.221 270
5	42	23-26s (0.63/0.47)	fixed	6	6.204 103
10	42	23-26s (0.63/0.47)	fixed	1	6.226 427
10	42	23-26s (0.63/0.47)	fixed	6	6.254 971
10 (Gas tight)	42	23-26s (0.63/0.47)	fixed	1	9.221 271
10 (Gas tight)	42	23-26s (0.63/0.47)	fixed	6	9.221 272
5	42	26 (0.47)	fixed	1	6.203 350
5	42	26 (0.47)	fixed	6	6.205 076
5	42	23 (0.63)	fixed	1	9.221 273
5	42	23 (0.63)	fixed	6	6.072 528
10	42	26 (0.47)	fixed	1	9.221 274
10	42	26 (0.47)	fixed	6	6.206 502
10	42	23 (0.63)	fixed	1	6.089 587
10	42	23 (0.63)	fixed	6	6.050 962
0.5	42	26 (0.47)	removable	1	6.228 788
0.5	42	23 (0.63)	removable	1	9.221 275
1	42	23 (0.63)	removable	1	9.221 276



3 Syringes for GC autosampler from CTC

Syringes for CTC Analytics CombiPal and GC PAL.

Trajan Scientific

- With fixed or removable needle
- Two different needle diameters (needle tip: cone)
- High reproducibility, low carry-over

Capacity	Needle length	Gauge (OD)	Needle Typ	PK	Cat. No.
µl	mm	mm			
10	50	26 (0,47)	fixed	1	7.671 795



1

1 Syringes for GC autosampler from CTC/Thermo

Syringes for CTC Analytics CombiPal and GC PAL.

Trajan Scientific

- With fixed or removable needle
- Two different needle diameters (needle tip: cone)
- High reproducibility, low carry-over
- Type A for Thermo TriPlus, Type B for Thermo TriPlus AS3000, AS2000, AS200/80

Type	Capacity µl	Needle length mm	Gauge (OD) mm	Needle Typ	PK	Cat. No.
A	5	50	23 (0,63)	fixed	1	7.607 298
A	5	50	26 (0,47)	fixed	1	7.900 714
A	10	50	23 (0,63)	fixed	1	7.656 984
A	10	50	23 (0,63)	fixed	1	7.607 297
B	10	50	26 (0,47)	fixed	1	7.639 848
A	10	50	23 (0,63)	fixed	6	9.221 291
A	10	50	26 (0,47)	fixed	1	7.631 444
A	10	50	26 (0,47)	fixed	6	7.612 636
A	10	50	26 (0,47)	removable	1	7.628 769
B*	10	50	26 (0,47)	removable	1	6.269 487
A	10 (Gas tight)	50	26 (0,47)	fixed	1	9.221 289
A	10 (Gas tight)	50	26 (0,47)	fixed	6	9.221 290
A	10 (Gas tight)	50	26 (0,47)	removable	1	7.629 523
A	25 (Gas tight)	50	23 (0,63)	fixed	1	7.628 136

*also for Bruker (Varian)

2

2 Syringes for GC autosampler from Shimadzu

For Shimadzu AOC14, AOC17 and AOC20. Needle tip: cone.

Trajan Scientific

Capacity µl	Needle length mm	Gauge (OD) mm	Needle Typ	PK	Cat. No.
5	42	23 (0.63)	fixed	1	6.205 990

3



3 Syringes for GC autosampler from Perkin-Elmer

GC syringes for all Perkin-Elmer autosampler e.g. Clarus.

Trajan Scientific

- With fixed or removable needle
- Two different needle diameter
- All needles are 70 mm long with a cone point style
- High reproducibility, low carry-over.

Capacity µl	Needle length mm	Gauge (OD) mm	Needle Typ	PK	Cat. No.
5	70	23 (0.63)	fixed	1	9.221 282
5	70	26 (0.47)	fixed	1	9.221 281
5 (Gas tight)	70	23 (0.63)	fixed	1	6.204 955
5 (Gas tight)	70	26 (0.47)	fixed	1	9.221 283

 Consumables from other GC manufacturers on request

Ready-to-use layers for TLC

Support materials for TLC ready-to-use layers

Glass plates: glass, ~ 1.3 mm thick, high requirements for weight, packaging and storage, ideal torsional strength, high temperature stability, susceptible to breakage, can not be cut with scissors, high resistance against solvents, mineral acids and conc. ammonia, suitability for aqueous detection reagents depends on the phase

POLYGRAM®: polyester, ~ 0.2 mm thick, low requirements for weight, packaging and storage, low torsional strength, max. 185°C temperature stability, not susceptible to breakage, can be cut with scissors, high resistance against solvents, mineral acids and conc. ammonia, very suitable for aqueous detection reagents

ALUGRAM®: aluminium, ~ 0.15 mm thick, low requirements for weight, packaging and storage, relatively high torsional strength, high temperature stability, not susceptible to breakage, can be cut with scissors, high resistance against solvents, low resistance against mineral acids and conc. ammonia, limited suitability for aqueous detection reagents

SIL G unmodified standard silica layers for TLC, glass plates/ POLYGRAM®

Glass plates, POLYGRAM®, ALUGRAM®

- Silica 60
- Specific surface (BET) ~500 m²/g
- Mean pore size 60 Å
- Specific pore volume 0.75 ml/g
- Particle size 5 to 17 µm
- Standard grade
- Thickness of layer for analytical plates 0.25 mm, for preparative plates 0.5 and 1 mm
- For 2 mm preparative layers a slightly coarser material is used, indicators: manganese activated zinc silicate with green fluorescence for short-wave UV (254 nm)
- Binders: highly polymeric products, which are stable in almost all organic solvents and resistant towards aggressive visualisation reagents
- Binder system for Polygram® sheets is also completely stable in purely aqueous eluents
- Available as glass plates, Polygram polyester sheets and Alugram aluminium sheets
- Available with or without fluorescent indicator (UV 254)

MACHEREY-NAGEL



4.004 850

Type	Plate format cm	Gel thickness mm	PK	Cat. No.
Glass plates SIL G-25 UV ₂₅₄	2.5 x 7.5	0,25	100	4.004 850 1
Glass plates SIL G-25	5 x 10	0,25	50	6.230 729
Glass plates SIL G-25 UV ₂₅₄	5 x 10	0,25	50	4.004 848
Glass plates SIL G-25	5 x 10	0,25	200	4.004 847
Glass plates SIL G-25 UV ₂₅₄	5 x 10	0,25	200	4.004 849
Glass plates SIL G-25	5 x 20	0,25	100	4.004 846
Glass plates SIL G-25 UV ₂₅₄	5 x 20	0,25	100	6.232 660
Glass plates SIL G-25 UV ₂₅₄	10 x 10	0,25	25	9.003 474
Glass plates SIL G-25	10 x 20	0,25	50	6.227 917
Glass plates SIL G-25 UV ₂₅₄	10 x 20	0,25	50	6.230 274
Glass plates SIL G-25	20 x 20	0,25	25	9.003 491
Glass plates SIL G-25 UV ₂₅₄	20 x 20	0,25	25	9.003 492
Glass plates SIL G-100	20 x 20	1,00	15	4.004 853
Glass plates SIL G-100 UV ₂₅₄	20 x 20	1,00	15	7.300 555
Glass plates SIL G-200	20 x 20	2,00	12	6.224 417
Glass plates SIL G-200 UV ₂₅₄	20 x 20	2,00	12	4.004 854
POLYGRAM® polyester sheets SIL G	2.5 x 7.5	0,20	200	4.004 827
POLYGRAM® polyester sheets SIL G UV ₂₅₄	2.5 x 7.5	0,20	200	4.004 826
POLYGRAM® polyester sheets SIL G	4 x 8	0,20	50	4.004 825
POLYGRAM® polyester sheets SIL G UV ₂₅₄	4 x 8	0,20	50	9.003 493
POLYGRAM® polyester sheets SIL G	5 x 20	0,20	50	6.803 651
POLYGRAM® polyester sheets SIL G UV ₂₅₄	5 x 20	0,20	50	9.003 476
POLYGRAM® polyester sheets SIL G	20 x 20	0,20	25	6.202 190
POLYGRAM® polyester sheets SIL G UV ₂₅₄	20 x 20	0,20	25	9.003 494
POLYGRAM® polyester sheets SIL G	40 x 20	0,20	25	4.004 822
POLYGRAM® polyester sheets SIL G UV ₂₅₄	40 x 20	0,20	25	4.004 824
ALUGRAM® aluminium sheets SIL G UV ₂₅₄	2.5 x 7.5	0,20	200	4.005 043
ALUGRAM® aluminium sheets SIL G UV ₂₅₄	4 x 8	0,20	50	9.003 496
ALUGRAM® aluminium sheets SIL G	5 x 7.5	0,20	20	4.005 042
ALUGRAM® aluminium sheets SIL G UV ₂₅₄	5 x 7.5	0,20	20	6.227 948
ALUGRAM® aluminium sheets SIL G	5 x 10	0,20	50	6.802 883
ALUGRAM® aluminium sheets SIL G UV ₂₅₄	5 x 10	0,20	50	9.003 477
ALUGRAM® aluminium sheets SIL G	5 x 20	0,20	50	7.084 918
ALUGRAM® aluminium sheets SIL G UV ₂₅₄	5 x 20	0,20	50	9.003 478
ALUGRAM® aluminium sheets SIL G	10 x 20	0,20	20	4.005 052
ALUGRAM® aluminium sheets SIL G UV ₂₅₄	10 x 20	0,20	20	6.233 568
ALUGRAM® aluminium sheets SIL G	20 x 20	0,20	25	7.059 745
ALUGRAM® aluminium sheets SIL G UV ₂₅₄	20 x 20	0,20	25	9.003 497
ALUGRAM® aluminium sheets Xtra SIL G UV ₂₅₄	4 x 8	0,20	50	6.259 756
ALUGRAM® aluminium sheets Xtra SIL G UV ₂₅₄	5 x 10	0,20	50	7.638 354
ALUGRAM® aluminium sheets Xtra SIL G UV ₂₅₄	20 x 20	0,20	25	6.242 312
ALUGRAM® aluminium sheets Xtra SIL G	20 x 20	0,20	25	9.003 465

1

1 ADAMANT unmodified standard silica layers for TLC

Silica 60, specific surface (BET) $\sim 500\text{m}^2/\text{g}$, mean pore size 60\AA , specific pore volume 0.75ml/g , particle size 5 to $17\mu\text{m}$. Outstanding hardness and abrasion resistance due to an optimized binder system. Increased separation efficiency due to an optimized particle size distribution. High suitability for trace analyses resulting from a UV indicator with brilliance and a low-noise background of the layer.

MACHEREY-NAGEL

Available as glass plates with or without fluorescent indicator (UV254).

Type	Plate format cm	Gel thickness mm	PK	Cat. No.
ADAMANT UV254	2.5 x 7.5	0.25	100	4.005 060
ADAMANT	5 x 10	0.25	50	4.005 067
ADAMANT UV254	5 x 10	0.25	50	4.005 061
ADAMANT	5 x 10	0.25	200	4.005 068
ADAMANT UV254	5 x 10	0.25	200	4.005 062
ADAMANT UV254	5 x 20	0.25	100	4.005 063
ADAMANT	10 x 10	0.25	25	4.005 069
ADAMANT UV254	10 x 10	0.25	25	4.005 064
ADAMANT UV254	10 x 20	0.25	50	4.005 065
ADAMANT	20 x 20	0.25	25	4.005 070
ADAMANT UV254	20 x 20	0.25	25	4.005 066

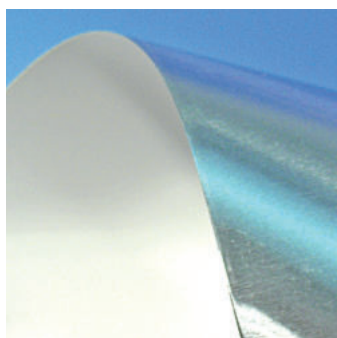
2

2 RP-18 W/UV254 octadecyl-modified nano silica layers for HPTLC
ALUGRAM®

MACHEREY-NAGEL

base material: Nano-K silica 60, specific surface (BET) $\sim 500\text{m}^2/\text{g}$, mean pore size 60\AA , specific pore volume 0.75ml/g , particle size 2 to $10\mu\text{m}$; for preparative plates (1 mm thickness of layer) standard silica 60, particle size 5 to $17\mu\text{m}$, pH stability 2 to 10 indicator: acid-resistant product with a pale blue fluorescence for short-wave UV (254nm); UV-absorbing substances appear as dark-blue to black spots on a light-blue background; partial octadecyl modification, wettable with water, carbon content 14%. 18-100 normal phase or reversed phase separation modes with eluents from anhydrous solvents to mixtures with high concentrations of water (see figure); the relative polarity of the eluent determines the polarity of the layer.

Recommended application: aminophenols, barbiturates, preservatives, nucleobases, polycyclic aromatic hydrocarbons, steroids, tetracyclines, plasticizers (phthalates).

Available as glass plates with or without fluorescent indicator (UV254).

Glass plates available on request.

Type	Plate format cm	Gel thickness mm	PK	Cat. No.
ALUGRAM® aluminium sheets RP-18 W UV ₂₅₄	4 x 8	0.15	50	7.400 375
ALUGRAM® aluminium sheets RP-18 W UV ₂₅₄	5 x 10	0.15	50	6.901 143
ALUGRAM® aluminium sheets RP-18 W UV ₂₅₄	5 x 20	0.15	50	4.005 046
ALUGRAM® aluminium sheets RP-18 W UV ₂₅₄	10 x 10	0.15	25	4.005 047
ALUGRAM® aluminium sheets RP-18 W UV ₂₅₄	20 x 20	0.15	25	6.704 046

3

3 TLC plates, Silica gel 60 F 254

Plate format cm	Gel thickness mm	Material	PK	Cat. No.
5 x 7,5	0,25	Aluminium	20	9.130 060
5 x 10	0,25	Aluminium	50	9.130 059
20 x 20	0,25	Aluminium	25	9.130 058
10 x 20	0,25	Glass	50	9.130 051
2,5 x 7,5	0,25	Glass	100	9.130 056
2,5 x 7,5	0,25	Glass	500	9.130 057
5 x 20	0,25	Glass	100	9.130 052
5 x 10	0,25	Glass	200	9.130 054
5 x 10	0,25	Glass	25	9.130 055
5 x 20	0,25	Glass	25	9.130 053
20 x 20	0,25	Glass	25	9.130 050
20 x 20	0,25	Plastic	25	9.130 063

1 Cellulose MN 300, TLC-ready-to-use plates cellulose coated

The primary field of application is the partition chromatography of polar substances such as amino acids, carboxylic acids or carbohydrates. The TLC-plates are available as glass plates, POLYGRAM® polyester sheets and ALUGRAM® aluminium sheets.

MACHEREY-NAGEL



- Fiber length (95 %) 2-20 µm
- Average degree of polymerization 400-500
- Specific surface according to Blaine 15000 cm²/g
- ≤ 20 ppm Fe, 6 ppm Cu, 7 ppm P
- Dichloromethane extract ≤ 0.25 %
- Residue on ignition at 850 °C ≤ 1500 ppm
- Available with or without fluorescent indicator (UV 254)

Type	Plate format cm	Gel thickness mm	PK	Cat. No.
Glass plates CEL 300-10	20 x 20	0.10	25	4.004 835
Glass plates CEL 300-10 UV ₂₅₄	20 x 20	0.10	25	7.510 059
Glass plates CEL 300-25	20 x 20	0.25	25	4.004 836
Glass plates CEL 300-25 UV ₂₅₄	20 x 20	0.25	25	6.231 713
Glass plates CEL 300-50	20 x 20	0.50	20	4.004 838
Glass plates CEL 300-50 UV ₂₅₄	20 x 20	0.50	20	4.004 839
POLYGRAM® CEL 300	4 x 8	0.10	50	7.053 700
POLYGRAM® CEL 300	20 x 20	0.10	25	7.053 593
POLYGRAM® CEL 300 UV ₂₅₄	5 x 20	0.10	50	4.004 804
POLYGRAM® CEL 300 UV ₂₅₄	20 x 20	0.10	25	7.400 578
ALUGRAM® CEL 300	4 x 8	0.10	50	4.005 049
ALUGRAM® CEL 300	20 x 20	0.10	25	6.093 621
ALUGRAM® CEL 300 UV ₂₅₄	5 x 20	0.10	50	4.005 051
ALUGRAM® CEL 300 UV ₂₅₄	20 x 20	0.10	25	4.005 050

2 3 Chromatography paper/Ion exchange papers

Whatman chromatography papers are the most widely used papers for chromatography worldwide.

Whatman

This acceptance and usage reflects the purity, high quality and consistency of Whatman papers.

These qualities are relied upon by chromatographers and essential to successful reproducible chromatography.

Whatman chromatography paper media are made from specially selected cotton cellulose. They are rigorously quality controlled for characteristics important to the chromatographer and to ensure uniformity within the grade.

1 Chr world standard chromatography paper. A smooth surface, 0.18 mm thick with a linear flow rate (water) of 130 mm/30 min. Good resolution for general analytical separations.

3MM Chr widely used as a blotting paper, 3MM Chr is used in both electrophoresis and for general chemistry. A medium thickness paper (0.34 mm) used extensively for general chromatography and electrophoresis. Flow rate is 130 mm/30 min.

3 Chr medium thickness paper (0.34 mm) with a flow rate of 130 mm/30 min. For general applications with medium/heavy solute loadings. Frequently used for separation of inorganic compounds and for electrophoresis.

17 Chr thick (0.92 mm) and highly absorbent paper with a very high flow rate of 190 mm/30 min. Suitable for the heaviest loadings and ideal for preparative paper chromatography and electrophoresis.

Ion exchange paper

SG81: A unique paper (0.27 mm thick) combining cellulose and large pore silica gel. Suitable for separations in which both partition and adsorption are important, including the separation of phospholipids, steroids, phenols and dyes. Flow rate is 110 mm/30 min.



Dimensions mm	Grade	PK	Cat. No.
100 x 300	1 CHR	100	9.950 308
200 x 200	1 CHR	100	9.950 309
250 x 250	1 CHR	100	9.950 310
460 x 570	1 CHR	100	9.950 311
200 x 200	3MM CHR	100	9.950 312
315 x 355	3MM CHR	100	9.950 313
460 x 570	3 CHR	100	9.950 314
460 x 570	3MM CHR	100	9.950 371
580 x 680	3MM CHR	100	9.950 315
460 x 570	4 CHR	100	9.950 316
460 x 570	17 CHR	25	9.950 317
460 x 570	SG81	25	9.950 319

1

1 Chromatography paper, reels

Chromatography Paper 1 CHR

Whatman

The standard chromatography paper. Good resolution for general analytical separations. Pure cellulose. Thickness 0.18mm. Capillary rise (water) 130mm/30 min.

Chromatography Paper 3MM CHR

Used in electrophoresis, in general chemistry and as blotting paper. Pure cellulose. Thickness 0.34mm. Capillary rise (water) 130mm/30 min.

Width mm	Length m	Grade	PK	Cat. No.
10	100	1 CHR	1	9.950 322
20	100	1 CHR	1	9.950 323
30	100	1 CHR	1	9.950 324
40	100	1 CHR	1	9.950 325
50	100	1 CHR	1	9.950 326
100	100	1 CHR	1	9.950 328
150	100	1 CHR	1	9.950 329
20	100	3MM CHR	1	9.950 327
100	100	3MM CHR	1	9.950 330
150	100	3MM CHR	1	9.950 331
190	100	3MM CHR	1	9.950 332
230	100	3MM CHR	1	9.950 333
270	100	3MM CHR	1	9.950 334

2

2 Aluminium oxide layers for TLC

Standard, rigid TLC plates in a choice of media, backing materials, and with dimensions as outlined below.

MACHEREY-NAGEL

Type	Plate format cm	Path length mm	PK	Cat. No.
POLYGRAM® aluminium oxide*	20 x 20	0.2	25	9.003 495
ALUGRAM® aluminium oxide*	20 x 20	0.2	25	9.003 498
POLYGRAM® polyester films	4 x 8	0.2	50	7.079 169

*with 254 nm UV indicator

3

3 Chromatography Paper

Hahnemühle

Recommended for chromatographic analysis and preparations.

- Made from pure linters with an α -cellulose content of > 98%
- High-performance resolution and wet strength
- The fibres are oriented in predominantly one direction
- Thicker papers allow higher sample volumes
- Lower capillary rises offer higher resolutions

Type	Description	Weight g / m ²	Dimensions mm	PK	Cat. No.
2668	preparative, fast	320	580 x 600	50	4.006 052
2727	preparative, fast	320	190 x 190	100	6.254 968
2043A	analytical, fast	90	460 x 570	100	4.006 117
2043A	analytical, fast	90	580 x 600	100	4.006 118
2043B	analytical, fast	120	460 x 570	100	4.006 119

4

4 Standard separating chamber

Flat chamber floor with glass ridge, for all TLC plates up to 200 mm x 200 mm.

Filter paper for gas space saturation to optimize the separation results is available.

Other separating chambers available on request.

Type	PK	Cat. No.
Separating chamber 200 x 200 mm with glass lid	1	6.311 891
Filter paper for chamber saturation	25	9.020 179

1 Simultaneous developing chamber and DC accessories

MACHEREY-NAGEL

Type	PK	Cat. No.
DC simultaneous chamber for up to 5 plates, 20cm x 20cm	1	9.003 500
Laboratory atomiser, glass with rubber bulb	1	4.004 909
Glass capillary 1µl	150	7.056 849
Outlining templates	2	4.004 903
Chromatography Paper MN 260, 7.5cm x 17cm (for saturating)	100	4.004 907



2 Nano separating chambers, with knob/ stainless lid

The nano separating chamber was developed for the preferred plate format of 100 mm high and have all the advantages of standard separating chambers.

Type	PK	Cat. No.
Separating chamber 100 x 100 mm with glass lid	1	6.311 892



3 Dipping chamber, glass insert

- For TLC plates
- Highly-resistant glass
- Clear width 5 mm
- Small volume of reagent required

biostep

Type	PK	Cat. No.
For TLC plates up to 100 x 100 mm, reagent required approx. 25 ml	1	9.022 160
For TLC plates up to 200 x 100 mm, reagent required approx. 50 ml	1	9.022 161
For TLC plates up to 200 x 200 mm, reagent required approx. 100 ml	1	9.022 162



4 H separating chamber

The H separating chambers make optimum use of HPTLC gel layer advantages. Small particle size 5µm, stringently controlled pore size and distribution, and more theoretical bases. Excellent value for money and can be supplied for time and cost saving in 50mm x 50mm plate format or traditional 100mm x 100mm format. Optimum separations are achieved even on the shortest runs.

biostep

Type	Width mm	Length mm	PK	Cat. No.
H separation chamber	50	50	1	9.023 150
H separation chamber	100	100	1	9.023 160
Frit rods		50	5	9.023 955
Cover plate	50	50	1	9.023 956
Cover plate	100	100	1	9.023 957



5 Chromatography sprayer SG e1

Spraying with powerful and quiet pump. The finest spray is produced even when the battery power is low. Liquids, up to the viscosity of light oil, can be finely sprayed at the touch of a button. Particle diameter 5µm to 10µm with a throughput of 20ml/min. based on water. The reservoir bottle for the spray reagent is made of borosilicate glass. The bottle is screwed into the high-grade PTFE nozzle and can be changed in seconds. With quick-charging dock as a storage base. Overload protection enables continuous storage of the sprayer in the charging station. Supplied with battery, battery charger, bottle and nozzle.

Type	PK	Cat. No.
SG e1	1	9.539 045
Reagent reservoir, 50 ml	10	9.539 046



6 Special atomiser, with rubber blowball

With rubber blowball for nebulising reagents. Can be connected to other compressed air supplies.

Type	PK	Cat. No.
Special atomiser	1	9.024 000



14. Chromatography

Thin-layer chromatography/Detection-Accessories



1 TLC sprayer

Versatile sprayer with gas cartridge for spraying reagents and other liquids. Spray pressure: constant 4.4 bar. Eco-friendly propellant mixture of dimethyl ether, propane and isobutane. Sufficient for approx. 500 ml of liquid. Easy to clean: unscrew cartridge, immerse uptake into vessel containing cleaning fluid and spray until the spray is free of residues.

Haubold Technik

Propellants: dimethyl ether, isobutane, propane.

Delivery incl. propellant cartridge (94 g), 170 ml glass reservoir bottle, suction tube and screw cap.



Danger

H phrases: H222|H229

Description	PK	Cat. No.
TLC sprayer	1	7.054 135



2 Test tube atomiser, glass

Glass atomiser for nebulising small amounts of reagents. Atomiser can be inserted in a 12ml test tube with a ground joint and held in position with a spring clip.

Type	PK	Cat. No.
Test tube atomiser	1	9.023 990



3 UV irradiation system BIO-LINK

- Compact and powerful, ideal for a broad range of applications
- Precise measurement and control technology, non-ageing UV sensors
- Choice for irradiation parameter energy or time
- Easy operation: Programme memory, storage of the last parameters, programme resumes after opening of the door, auto-restart after power failure
- Secure and stable construction, very easy to use
- Easy exchange of the UV tubes for wavelength change

Vilber Lourmat

Dimensions (W x D x H)

Housing: 350 x 360 x 305 mm
Interior: 260 x 330 x 145 mm

Type	Description	Wave-length nm	Tubes W	PK	Cat. No.
BLX-254	UV crosslinker	254	5 x 8	1	9.971 923

Other models available on request.

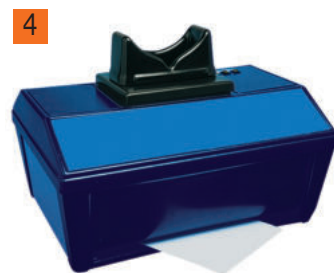

4 TLC Viewing cabinets

Model CN-6:

- For one or two UV hand lamps model BVL-6; choice of combined wavelengths 254 nm, 312 nm and 365 nm
- Cabinet dimensions (W x D x H): 300 mm x 280 mm x 240 mm

Vilber Lourmat

Model CN-15:

- Integral high intensity UV lamps, extra large capacity; easy access also for large samples; white-light bulb for normal observation
- Removable bottom panel
- Cabinet dimensions (W x D x H): 505 mm x 415 mm x 280 mm

Type	Description	Wave-length nm	Tubes W	PK	Cat. No.
CN-6	without UV handlamps	-	-	1	9.971 926
CN-15.LC*	with integrated UV tubes and white-light source	365 / 254	4 x 15	1	9.971 927

* Other models available on request.



5 Laboratory dryer HT0141

Power: approx. 2100 W. 2 speed settings, 3 temperature settings with cold air-stream button. Metallic paint housing. Air-inlet grill detachable for cleaning. cable retracts at the touch of a button. Weight: 594 g.

Type	PK	Cat. No.
HT 0141	1	6.268 487

Reusable garments	1502
Overalls, coats	1502
Surgical masks, hoods, sleeves	1503
Accessories.....	1504
Disposable garments	1504
Overalls, coats	1504
Surgical masks, hoods, sleeves	1507
Overshoes, overboots, socks	1508
Eye protection	1510
Cleanroom goggles	1510
Gloves and fingercots	1512
Nitrile gloves.....	1512
Latex gloves	1517
Polychloroprene gloves	1521
PE, PVC, PU gloves	1523
Coated gloves	1523
Undergloves.....	1524
Finger cots	1524
Skin protection and care.....	1525
Wipes and swabs	1526
Dry wipes	1526
Swabs.....	1530
Cleaning rollers	1532
Paper and documentation	1533
Paper, notebooks, pencils.....	1533
Tapes.....	1535
Cleaning equipment and tools	1537
Cleaning systems, stainless steel	1537
Cleaning systems, plastic.....	1538
Mop holders and covers.....	1539
Facility	1542
Mats and floor coverings.....	1542
Trolleys, dispensers.....	1545
Wardrobes	1548
Gowning benches	1549
ESD products	1550
ESD-gloves and fingercots	1550
ESD-mats and pads	1550

Cleanroom Classifications

ISO Classification Number	0.1 µm	0.2 µm	0.3 µm	0.5 µm	1.0 µm	5.0 µm	SI	English Former FED-STD-209E
ISO Class 1	10	2						
ISO Class 2	100	24	10	4	8			
ISO Class 3	1,000	237	102	35	83		M 1.5	1
ISO Class 4	10,000	2,370	1,020	352	832	29	M 2.5	10
ISO Class 5	100,000	23,700	10,200	3,520	8,320	293	M 3.5	100
ISO Class 6	1,000,000	237,000	102,000	35,200	83,200	2,930	M 4.5	1,000
ISO Class 7				352,000	832,000	29,300	M 5.5	10,000
ISO Class 8				3,520,000	8,320,000	293,000	M 6.5	100,000
ISO Class 9				35,200,000	83,200,000	2,930,000		

1



1

Overall for clean room ASPURE, lateral zip, polyester

The overall is available in four different colour versions. Falling of hair, dust and other particles is prevented by double sleeves. In the area of the sleeves, the waist and the lower hem rubber bands are incorporated.

AS ONE

- Oblique lateral zip
- Anti-static protection
- With conductive yarn
- Suitable for clean room class ISO 5
- Surface resistance: $10^6 - 10^8 \Omega$

For cleanroom use this garment has to be washed according to required cleanroom class.

Size	Colour	PK	Cat. No.
XS	white	1	4.659 040
S	white	1	4.659 041
M	white	1	4.659 042
L	white	1	4.659 043
XL	white	1	4.659 044
XS	blue	1	4.659 045
S	blue	1	4.659 046
M	blue	1	4.659 047
L	blue	1	4.659 048
XL	blue	1	4.659 049

2



2

Overall for cleanroom, front zip, polyester

The polyester overall is available in two different colour versions. In the area of the sleeves and the backward waist rubber bands are incorporated.

AS ONE

- Vertical front zip
- With conductive yarn
- Suitable for cleanroom class ISO 5
- Surface resistance: $10^5 - 10^8 \Omega$

For cleanroom use this garment has to be washed according to required cleanroom class.

Size	Colour	PK	Cat. No.
XS	white	1	4.659 050
S	white	1	4.659 051
M	white	1	4.659 052
L	white	1	4.659 053
XL	white	1	4.659 054
XS	blue	1	4.659 055
S	blue	1	4.659 056
M	blue	1	4.659 057
L	blue	1	4.659 058
XL	blue	1	4.659 059

1 Laboratory coat ASPURE, for cleanroom, Polyester, with zip

- Available in two different colour versions
- With incorporated rubber bands at the cuffs
- Anti-static protection
- With conductive yarn
- Surface resistance: 10⁶ - 10⁸Ω

AS ONE

Size	Colour	PK	Cat. No.
XS	white	1	4.663 097
S	white	1	4.663 098
M	white	1	4.663 099
L	white	1	4.663 100
XL	white	1	4.663 101
XS	blue	1	4.663 102
S	blue	1	4.663 103
M	blue	1	4.663 104
L	blue	1	4.663 105
XL	blue	1	4.663 106



2 Hood for cleanroom, polyester

- Hood made of 100 % polyester
- Available with and without brim
 - Washable
 - With conductive yarn
 - Suitable for cleanroom class ISO 5
 - Surface resistance: 10⁶ - 10⁸Ω

AS ONE

For cleanroom use this garment has to be washed according to required cleanroom class.

Description	Size	Colour	PK	Cat. No.
Without brim	S/M	white	1	4.659 060
Without brim	L/XL	white	1	4.659 061
Without brim	S/M	blue	1	4.659 062
Without brim	L/XL	blue	1	4.659 063
With brim	S / M	green	1	4.663 048
With brim	L / XL	green	1	4.663 049
With brim	S / M	pink	1	4.663 050
With brim	L / XL	pink	1	4.663 051



3 Hood and mask for cleanroom

- Hood and fitting mask for cleanroom use
- Fixing of mask with Velcro closure
 - Anti-static protection
 - With conductive yarn
 - Universal size
 - Suitable for cleanroom class ISO 5

AS ONE

For cleanroom use this garment has to be washed according to required cleanroom class.

Description	Colour	PK	Cat. No.
Hood	white	1	4.659 064
Hood	blue	1	4.659 065
Mask	white	1	4.659 066
Mask	blue	1	4.659 067



15. Cleanroom

Reusable garments/Accessories-Disposable garments/Overalls, coats

Clean Room Bags, PVC

This cleanroom bag is made of transparent PVC allowing an easy view into the bag. Pockets for smaller items and holder for pens. Strap made of 100 % polyester.

AS ONE

Description	Dimensions mm	PK	Cat. No.
Shoulder bag	400 x 300 x 90	1	4.659 069 1
Belt bag	250 x 160 x 60	1	4.663 612 2



4.659 069



4.663 612

Clean Room Bag, polyester

The clean room bag type A1584 can be used to store small items and S1717 is with handle and can be used to store shoes and overalls for cleanrooms.

AS ONE

- Anti-static protection
- Surface resistance: $10^6 - 10^8 \Omega$

Type	Dimensions mm	Description	PK	Cat. No.
A1584	220 x 310 x 55		1	4.663 613 3
S1717	300 x 360 x 55	with handle	1	4.663 614 4



4.663 613



4.663 614



5 Protection Coverall Kimtech™ A8

Kimberly-Clark

EN 1149



The non-sterile A8 cleanroom coveralls are made from ultra-light and breathable SMS material. The unhooded design has a high neck collar for added protection, and the coveralls are suitable for ISO 7 and 8 (Grade C and D) cleanrooms.

- PPE Cat III according to Regulation (EU) 2016/425
- Type 6 limited chemical splash protection
- Type 5 particle protection
- EN1149-5:2008 antistatic clothing

Size	PK	Cat. No.
S	25	6.272 177
M	25	6.272 178
L	25	6.272 179
XL	25	6.272 180
2XL	25	6.272 181
3XL	25	6.272 182

1 2 Disposable Coverall BioClean™, with collar/hood, sterile

- Low linting, anti-static CleanTough™ Fabric
- Sterilized by Gamma irradiation
- Compatible to ISO-Class 4
- Anti-static properties
- Manufactured in a holding facility
- Zip front with flap cover
- Elasticated back, cuffs and ankles
- Available in sizes ranging from S through 4XL
- ASTM F739-12 Tested
- HELMKE DRUM Tested
- Low-particulate
- Sterility Assurance Level 10⁻⁶

Nitritex Ltd

Triple packaged, 1 piece per sealed inner PE bag, 1 inner bag per sealed outer PE bag, 20 outer bags per lined carton (20 pieces)/20 bags for S-XXL, 15 bags up to 3XL

Material: Clean-Tough
Mass: 60 g/m²

Size	Description	Sterile	PK	Cat. No.
S	with collar	-	20	4.661 457
M	with collar	-	20	4.661 458
L	with collar	-	20	4.661 459
XL	with collar	-	20	4.661 460
XXL	with collar	-	20	4.661 461
XXXL	with collar	-	15	4.661 462
XXXXL	with collar	-	15	4.661 463
S	with hood	-	20	4.661 464
M	with hood	-	20	4.661 465
L	with hood	-	20	4.661 466
XL	with hood	-	20	4.661 467
XXL	with hood	-	20	4.661 468
XXXL	with hood	-	15	4.661 469
XXXXL	with hood	-	15	4.661 470
S	with collar	+	20	4.661 478
M	with collar	+	20	4.661 479
L	with collar	+	20	4.661 480
XL	with collar	+	20	4.661 481
XXL	with collar	+	20	4.661 482
XXXL	with collar	+	15	4.661 483
XXXXL	with collar	+	15	4.661 484
S	with hood	+	20	4.661 485
M	with hood	+	20	4.661 486
L	with hood	+	20	4.661 487
XL	with hood	+	20	4.661 488
XXL	with hood	+	20	4.661 489
XXXL	with hood	+	15	4.661 490
XXXXL	with hood	+	15	4.661 491



3 Disposable Chemical Protection Coverall uvex 4B

Material: polyethylene-laminate

uvex

- colour white/orange
- excellent wearer comfort due to the breathable, light and flexible material
- self-adhesive zipper flap and taped seams ensure optimum protection against penetration by liquid aerosols and solid particles
- the hood is easily compatible with filtering face masks
- middle finger loops prevent sleeves from sliding up
- silicone free
- suitable for cleanroom environment (Class 7, ISO 14644-1)
- chemical protection: personal protective equipment category 3, EN 14605(Type 4), EN ISO 13982-1(Type 5), EN 13034(Type 6), EN 1149-5, EN 14126

Size	PK	Cat. No.
S	5	9.414 100
M	5	9.414 101
L	5	9.414 102
XL	5	9.414 103
XXL	5	9.414 104
XXXL	5	9.414 105



Disposable garments/Overalls, coats

1



1 Disposable coverall Tyvek® IsoClean® with collar, sterile

DuPont™ Tyvek® IsoClean® unhooded coverall with bound neck, model IC 183 B WH DS. Available in sizes S to 3XL. Clean-processed and gamma-sterilized. Bound internal seams. Elasticated waist at back for good fit. Tyvek® covered elasticated thumb loops. Tunnelled elastication at wrists and ankles. Front zipper closure. Storm flap.

DuPont de Nemours

- This garment is not CE certified as chemical protective clothing
- Certified according to Regulation (EU) 2016/425
- Clean-processed and sterilised by gamma-irradiation to SAL of 10⁻⁶ (ISO 11137-1)
- Full traceability on all sterilized apparel with certificates of sterility available
- Suitable for use in GMP class A/B (ISO Class 5) clean rooms
- Chemical protective clothing, Category III, Type 5-B and 6-B
- EN 14126 (barrier to infective agents), EN 1073-2 (protection against radioactive contamination)

Size	PK	Cat. No.
S	1	6.312 080
M	1	6.312 081
L	1	6.312 082
XL	1	6.312 083
XXL	1	6.312 084
XXXL	1	6.312 085

2



2 Disposable Laboratory Coat BioClean-D™

- PPE Category 3 Type PB[6]
- Press stud fastening
- Open cuff style
- Three pockets
- Back split
- Processed in an NEBB certified ISO Class 4 environment
- Antistatic, low-linting BioClean-D CleanTough™

Nitritex Ltd

Triple packaged, 1 piece per sealed inner PE bag, 1 inner bag per sealed outer PE bag, 30 outer bags per lined carton (30 pieces)

Size	Colour	PK	Cat. No.
S	white	30	4.661 471
M	white	30	4.661 472
L	white	30	4.661 473
XL	white	30	4.661 474
XXL	white	30	4.661 475

3



3 Laboratory coat Kimtech™ A7 P+, PP

EN 1149



- Certified PPE Cat III acc. to directive 89/686/EEC
- Type 6 limited chemical splash protection
- Micro-organism protection tested
- EN1149-1:1995 Antistatic clothing
- High performance chemical resistant fabric
- Low lint fabric, Helmke Drum Category II
- 99% particle and bacterial filtration efficiency
- Individually packed, 15 p. in an outer package for ISO 7 Grade C areas
- Silicon-Free
- Abrasion-resistant film-coated polypropylene
- Mandarin collar
- Elastic cuff, thumb-loops and extra-length arms
- High strength triple stitched seams

Kimberly-Clark

Size	PK	Cat. No.
S	15	4.653 906
M	15	4.653 907
L	15	4.653 908
XL	15	4.653 909
XXL	15	4.653 910

1 Disposable Masks ASPURE, without nose clip

Material : PP/PE and loops made of polyester. AS ONE
 - 2-ply
 - Packing: 40 x 50 pieces

Type	Dimensions (D x W) mm	PK	Cat. No.
Disposable masks	180 x 90	2000	4.663 608



2 Disposable masks ASPURE for Cleanroom, PP

Elastic straps are made of low particle material (Urethane), nose clip made of polyethylene. High collection efficiency because of its 3 layer structure. AS ONE
 - Packed in cleanroom
 - Suitable for cleanroom class ISO 5
 - Packing: 40 x 50 pieces

Type	Dimensions (D x W) mm	PK	Cat. No.
Disposable mask	180 x 95	2000	4.659 068



3 Disposable Masks ASPURE, for Cleanroom, sterile

Gamma sterilized disposable masks with ear loops. AS ONE
 - 3-ply
 - Individually packed in cleanroom
 - Suitable for cleanroom class ISO 5
 - Packing: 20 x 50 pieces

Type	Dimensions (D x W) mm	PK	Cat. No.
Disposable masks	180 x 95	1000	4.663 609



4 Disposable mask for Cleanroom Kimtech™ M3, sterile

White sterile pleated style mask, with 18cm ties; silicone and latex free. Great comfort by flexible fit features and BICOSOF*inner fabric. Kimberly-Clark
 Kimtech™ M3 Sterile Masks offer advanced levels of process protection and comfort, help to reduce the possible risk of contamination and are suitable for use in EU GMP ISO 5 class A environments. Validated to sterility assurance level 10⁻⁶ and supported with technical information for compliance.
 Ideal for use in sterile pharmaceutical manufacturing.
 Manufactured in FDA compliant facility.
 Individually packed, 20 packs per sealed wallet and 10 wallets per double bag, with case liner for added protection.



Description	Cleanroom Class	PK	Cat. No.
Mask, white with ties	ISO 5	200	4.652 644
Mask, white with ear loops	ISO 5	200	6.253 164



Disposable garments/Surgical masks, hoods, sleeves-Overshoes, overboots, socks

1



1 Hood Tyvek® IsoClean®, sterile

DuPont™ Tyvek® IsoClean® hood with ties, model IC 668 B WH CS. Sterile hood available in white and in one size. Full face opening with loops and ties. Tyvek® garments are composed of flash spun high density polyethylene, providing an ideal balance of protection, durability and comfort. Tyvek® is permeable to both air and water vapour, yet repels water-based liquids and aerosols. It offers an excellent barrier against fine particles and fibres (down to 1 micron in size) and is ultra-low-linting. Silicon non-added. Garments and accessories made of Tyvek® IsoClean® are used in the biotech, pharmaceutical, medical device manufacturing and electronics industries, as well as in other critical or controlled environments.

DuPont de Nemours

- This accessory is not CE certified as chemical protective clothing
- Clean laundered and gamma-sterilised
- Suitable for use in cleanroom class ISO 5 and higher
- Sterility assurance level (SAL) of 10⁻⁶
- Bound seams: tightly sewn seam is covered with garment fabric to reinforce seam protection and reduce potential for liquid and particle penetration
- Full traceability on all sterilized apparel with certificates of sterility available
- Box of 100 p., single packed

Colour	PK	Cat. No.
white	100	9.390 071

2



2 Disposable Sleeve Guard BIOCLEAN-D™, sterile/non sterile

Offering comfort, protection and quick and simple donning, the single use BioClean-D™ Disposable Sleeve Covers are constructed from antistatic lightweight low-linting CleanTough material, featuring elasticated openings for a firm fit.

Nitritex Ltd

- PPE Cat 3 Type PB [6]
- ISO Class 4
- Bound seams with single needle stitching
- Lightweight low-linting CleanTough material

Sterile: 1 pair per inner bag, 15 inner bags per outer bag, 6 outer bags (90 pairs) per lined carton
 Non-Sterile: 30 pieces per inner bag, 1 inner bag per outer bag, 6 outer bags (180 pieces) per lined carton

Length mm	Sterile	PK	Cat. No.
500	-	180	4.661 477
500	+	90	4.661 493

3



4.661 494

Disposable Overshoes BioClean, PP

- Slip-resistant sole
- Elastomer coating over non-woven spunbonded polypropylene
- ISO Class 5 Compatible
- Thickness: 0.14 mm
- Type BESD - ESD performance
- 100 pieces per sealed inner PE bag/4 outer bags per lined carton (400 pieces)

Nitritex Ltd

Type	Size mm	Colour	PK	Cat. No.
BESD	400	white	400	4.661 494
NSO	400	white	400	4.661 495
NSO	457	white	400	4.661 496

1 2 Overshoes for dispenser HYGOMAT

- 6257285:**
- Polypropylene nonwoven, CPE coated, white
 - Waterproof sole
 - Very slip resistant
 - Perfect for smooth surface

Mensch

- 6257286:**
- PP overshoe with CPE sole, blue
 - Polypropylene nonwoven
 - At the top nonwoven, at the bottom strong waterproof CPE sole
 - Very tearproof and slip resistant

- 6257287:**
- CPE (Cast Polyethylene), blue
 - Strong quality, approx. 60 micron
 - Light protection against liquids

- 6257288:**
- Polypropylene nonwoven, blue
 - At the bottom structure made of CPE
 - Permeable to air and light slip resistant
 - For dry areas

Length mm	PK	Cat. No.
440	80	6.257 285
440	70	6.257 286
470	110	6.257 287
460	100	6.257 288



3 Overshoe dispenser HYGOMAT COMFORT/CLEANROOM

- no electrical power needed
- easy to use, no need for bending over
- easy and quick handling
- with handrail for extra comfort
- capacity: two packs of overshoes
- with window for easy control of rest capacity
- refilled with overshoes within seconds
- weight: 21 kg

Mensch

Description	PK	Cat. No.
Overshoes dispenser HYGOMAT COMFORT, 740 x 300 x 730 mm	1	6.257 283
Overshoes dispenser HYGOMAT CLEANROOM, stainless steel, 740 x 300 x 730 mm	1	6.269 779



4 Disposable Overboot Tyvek® IsoClean®

DuPont™ Tyvek® IsoClean® overboot, model IC 458 B WH 00. Overboot available in white and in sizes M and L. Fixation ties. Tunnelled elastics at ankles and gripper slip-retardant full sole. Tyvek® garments and accessories are composed of flash spun high density polyethylene, providing an ideal balance of protection, durability and comfort. Tyvek® is permeable to both air and water vapour, yet repels water-based liquids and aerosols. It offers an excellent barrier against fine particles and fibres (down to 1 micron in size) and is ultra-low-linting. Silicon non-added. Garments and accessories made of Tyvek® IsoClean® are used in the biotech, pharmaceutical, medical device manufacturing, electronics industries and as well in industrial applications.

DuPont de Nemours

- This accessory is not CE certified as chemical protective clothing
- Not clean laundered, not sterilised
- Suitable for use in cleanroom class ISO 6 and higher
- Bound seams: tightly sewn seam is covered with garment fabric to reinforce seam protection and reduce potential for liquid and particle penetration
- Box of 100 p.



Description	Colour	PK	Cat. No.
M	white	100	9.390 076
L	white	100	9.390 077

Disposable garments/Overshoes, overboots, socks-Eye protection/Cleanroom goggles



1 Disposable Socks ASPURE, Polyester

- Suitable for cleanroom
- One size
- Total length: 400 mm
- Packing: 100 pairs

AS ONE

Type	PK	Cat. No.
Disposable socks	100	4.663 598



2 LLG-Safety Eyeshields *basic*



- CE approved to EN166 and EN170
- Perfect for visitors as well as over goggles for spectacles wearers
- Integrated side lens with venting, 180° visual field
- Frame made of tested hypo-allergenic material
- 100% UV protection (up to 380 nm)
- Weight: 43g

Colour	Lens	PK	Cat. No.
Clear	Clear, uncoated, 2-1.2 U 1 F CE	10	9.006 002



3 Safety Eyeshields uvex super fit CR 9178



uvex

- Professional protection of products and humans
- First autoclavable protective spectacle with anti-fog effect
- Sterile eye protection in every situation
- Autoclavable at least 10 times, 121°C, 20 minutes
- Innovative design for maximum functionality and wearer comfort
- Non-allergenic material which is free of harmful substances
- Ultra-thin wraparound lens
- Lightest safety spectacle in the world
- EN 166
- UV 400
- Weight 21 g

Coating uvex supravision clean.

Colour	Lens	Coating	PK	Cat. No.
white/light blue	UV 400, 2C-1,2 W 1 FTKN DIN CE	uvex supravision CR	1	7.982 028



4 Overgoggles uvex super f OTG CR 9169



uvex

- Professional protection of products and humans
- First autoclavable protective overspec with anti-fog effect
- Sterile eye protection in every situation
- Autoclavable at least 10 times, 121 °C, 20 minutes
- Innovative design for maximum functionality and wearer comfort
- Overspecs with unrestricted lateral vision
- Also suitable for use over prescription spectacles
- Non-allergenic material which is free of harmful substances
- Ultra-modern lens technology
- Extremely flexible soft ear pieces
- EN 166
- UV 400
- Weight 37 g

Coating uvex supravision clean.

Colour	Lens	Coating	PK	Cat. No.
white/light blue	clear, UV 400, 2C-1,2	uvex supravision clean	1	6.268 419

1 Panoramic Eyeshield uvex ultrasonic CR 9302

1



uvex

- Professional protection of products and humans
- First autoclavable protective goggle with anti-fog effect
- Sterile eye protection in every situation
- Autoclavable at least 10 times, 121 °C, 20 minutes
- Innovative design, maximum functionality, wearer comfort
- Ultra-light goggle with panorama lens, duo component technology and adjustable silicone headband
- Indirect ventilation ensures a pleasant and comfortable interior environment
- Easy lens replacement
- Flexible soft components
- Wide panoramic field of vision
- Non-allergenic material which is free of harmful substances
- EN 166
- UV 400
- Weight 98 g



Coating uvex supravision clean.

Colour	Lens	Coating	PK	Cat. No.
white	clear /UV 2-1,2	uvex supravision clean	1	6.262 943

2 Panoramic Eyeshield 619

2



UNIVET

- Panoramic Eyeshield designed for use in rooms with controlled contaminations (sterile and clean rooms) or in aseptic conditions. Its soft structure supports multiple cycles of steam, gamma or beta sterilization without perceptible changes.
- Sterilizable through autoclave with steam
 - New elastic strap in antistatic silicone
 - Innovative quick elastic band adjustment system
 - Available with direct and indirect ventilation



Colour	Description	Lens	PK	Cat. No.
blue	elastic headband, directly ventilation	clear / 2C-1.2 U 1 B CE	1	6.286 799
blue	elastic headband, indirectly ventilation	clear / 2C-1.2 U 1 B CE	1	6.286 800

We can **supply** this
manufacturer's
whole
product range !





1 Cleanroom Gloves, BioClean BIOTAC, Nitrile

Nitritex Ltd

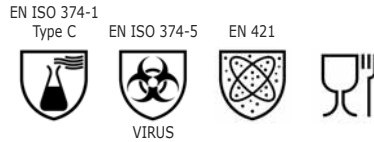

- Low particulate count
- Powder-free
- Latex-free
- AQL 1.5
- Finger-textured
- Ambidextrous
- Excellent ESD properties
- Easy double-donning
- Chemical resistant
- Compatibility ISO Class 5
- Colour: white
- Carton with 10 bags with 100 pieces

According to EN ISO 374-1:2016/Type C, EN ISO 374-5:2016, EN 421, Suitable for food handling.

Packaging:

100 pieces per sealed plastic inner bag, 1 inner bag per sealed outer bag, 10 outer bags per inner carton bag

Size	Length mm	PK	Cat. No.
XS	300	1000	4.661 373
S	300	1000	4.661 374
M	300	1000	4.661 375
L	300	1000	4.661 376
XL	300	1000	4.661 377



2 Cleanroom Gloves AdvanTech529, nitrile

MAPA



Reinforced mechanical resistance for short-term operations. Manufacturing process guarantees a very low level of contaminants: rates of particles, powder-free, non-volatile residue, extractables; compatible with ISO 5 class (Class M3.5 for International system). 100% nitrile formula enables anti-static properties. Protection against accidental chemical splashes. Recommended for people who are sensitive to the proteins in natural latex. Thickness: 0.1 mm. Packaging: 100 gloves/bag

- **Cat. III**

According to EN ISO 374-1:2016/Type B, EN ISO 374-5:2016, EN 421

Size	Length mm	PK	Cat. No.
6	300	100	6.270 501
7	300	100	6.270 502
8	300	100	6.270 503
9	300	100	6.270 504
10	300	100	6.270 505

1 Disposable Gloves Touch N Tuff®, Nitrile

Ansell

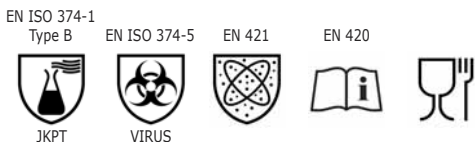

Disposable Nitrile Glove for Controlled Environments

- High Puncture Resistance
- Enhanced Levels of Safety & Comfort
- Type I Allergy Protection
- Clean
- Suitable for cleanroom environment ISO Class 5
- Acid resistance, Chemical handling
- AQL 1.5 (EN374)
- Cat. III Low Chemical resistant
- 100% nitrile, powdered, teal green
- Box with 100 gloves

Packaging: 50 gloves packed in a vacuum-sealed in an unprinted polybag, two bags of 50 gloves per master polybag.

According to EN ISO 374-1:2016/Type B, EN ISO 374-5:2016, EN 421, EN 420 Suitable for food handling.



Size	Length mm	PK	Cat. No.
S	300	100	7.940 295
M	300	100	7.940 296
L	300	100	7.940 297

2 Cleanroom Gloves Nitrilite® Silky, nitrile

Ansell

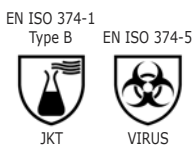

Produced in a controlled powder-free environment, they feature low levels of extractable and particles for excellent product protection. The 100 % nitrile polymer prevents the risk of allergies related to latex proteins for the wearer. It also provides exceptional chemical and puncture resistance for further safety. All this, added to optimal electrical properties, makes Nitrilite® gloves ideal for a wide range of industrial sectors.

- AQL of 1.5
- **Cat. III**

Packaging: 50 gloves vacuumsealed in an unprinted polybag, two bags of 50 gloves per master polybag. All packaging and labeling is printed with IPA-resistant ink. The gloves are doublebagged for superior contamination control. Packed in a ISO Class 5 cleanroom.

According to EN ISO 374-1:2016/Type B, EN ISO 374-5:2016



Size	Length mm	PK	Cat. No.
S	300	100	6.253 290
M	300	100	6.253 291
L	300	100	6.253 292
XL	300	100	6.253 293
XXL	300	100	6.262 160

1 2 Cleanroom Gloves, Kimtech™ G3, nitrile

Kimberly-Clark

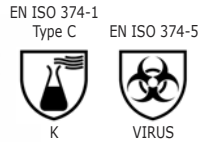

Kimtech™ G3 Cleanroom Gloves offer advanced levels of process protection and comfort in ISO 3 or higher cleanrooms.

- Ambidextrous gloves
- Beaded cuff
- Textured fingertips
- Powder-free
- Silicone free
- AQL 1.5
- **Cat III**
- Double lined bags for added protection 10 x 100 pieces.

According to EN ISO 374-1:2016/Type C, EN ISO 374-5:2016.



Size	Length mm	PK	Cat. No.
XS	300	1000	6.264 543
S	300	1000	7.625 756
M	300	1000	7.625 757
L	300	1000	6.242 757

3 Cleanroom Gloves, BioClean NERVA, Nitrile

Nitritex Ltd

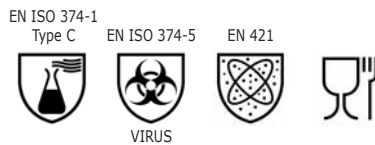

- Elbow length protection
- Low particulate count
- Powder-free
- Latex-free
- AQL 0.65
- Textured
- Ambidextrous
- Excellent ESD properties
- Easy double-donning
- Chemical resistant
- Compatibility ISO Class 4
- Colour: white
- Carton with 10 bags with 100 pieces

According to EN ISO 374-1:2016/Type C, EN ISO 374-5:2016, EN 421, Suitable for food handling.

Packaging:

100 pieces per sealed plastic inner bag, 1 inner bag per sealed outer bag, 10 outer bags per inner carton bag

Size	Length mm	PK	Cat. No.
S	400	1000	4.661 387
M	400	1000	4.661 388
L	400	1000	4.661 389
XL	400	1000	4.661 390

1 Cleanroom Gloves, BioClean EXCELL™, Nitrile, sterile

1

Nitritex Ltd

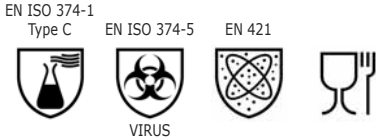

- Low particulate count
- Powder-free
- Latex-free
- AQL 1.5
- Textured
- Hand specific
- Excellent ESD properties
- Chemical resistant
- Compatibility ISO Class 4
- Colour: white
- Carton with 20 bags with 10 pairs

According to EN ISO 374-1:2016/Type C, EN ISO 374-5:2016, EN 421, Suitable for food handling.

Packaging: 1 pair per plastic bag, 1 plastic bag per particle-free EasyTear™ bag, 10 pairs per sealed outer bag, 20 outer bags per inner carton bag

Size	Length mm	PK	Cat. No.
6	300	200	4.661 412
6,5	300	200	4.661 413
7	300	200	4.661 414
7,5	300	200	4.661 415
8	300	200	4.661 416
8,5	300	200	4.661 417
9	300	200	4.661 418
10	300	200	4.661 419

2 3 Cleanroom Gloves, Kimtech™ G3 Sterile Sterling™, nitrile, sterile

2

Kimberly-Clark

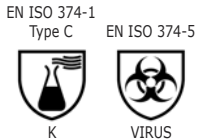

Kimtech™ G3 Sterile Sterling™ Nitrile Gloves offer improved performance and comfort and are better for the environment.

- Recommended for ISO Class 5 or higher cleanroom environments
- Meets AQL of 1.5 or better
- Contain no natural rubber latex reducing the potential for TYPE I glove-associated reactions
- Powder-free
- Static dissipative in use
- Safe handling of objects due to improved and consistent grip
- Hand specific
- Walleled & pouched in polyethylene for cleanroom use
- Packaged for aseptic donning
- **Cat. III**
- Box of 10 x 30 pairs. Individually packed per pair

According to EN ISO 374-1:2016/Type C, EN ISO 374-5:2016

Size	Length mm	PK	Cat. No.
6	300	300	6.264 797
6,5	300	300	6.264 798
7	300	300	6.264 799
7,5	300	300	4.652 645
8	300	300	6.265 200
8,5	300	300	6.265 201
9	300	300	6.265 202
10	300	300	6.265 203

3



15. Cleanroom

Gloves and fingercots/Nitrile gloves

1 2 Cleanroom Gloves, Kimtech™ G3, nitrile, sterile

Kimberly-Clark

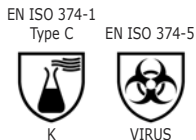

Kimtech™ G3 Sterile White Nitrile gloves provide enhanced sterile cleanroom protection for a wide range of contaminants. With a textured finish and skin-friendly nitrile composition, the hand-specific sterile gloves protect users and processes alike.

- ISO16604 virus resistant.
- Sterile Validated to SAL 10⁻⁶
- Available as one pair of hand specific gloves
- Beaded cuff for added strength
- Fully textured palm and fingertips
- Combining enhanced grip with easy double donning
- Powder-free
- Comfortable fit, with silicone free formulation
- Individually packed in sterile wallets 10 x 20 pairs



According to EN ISO 374-1:2016/Type C, EN ISO 374-5:2016.

Size	Length mm	PK	Cat. No.
6	300	200	6.257 260
6,5	300	200	6.240 584
7	300	200	6.265 204
7,5	300	200	6.240 077
8	300	200	6.230 011
8,5	300	200	6.252 634
9	300	200	6.235 083
10	300	200	6.265 205

3 Disposable Gloves Touch N Tuff®, Nitrile, sterile

Ansell

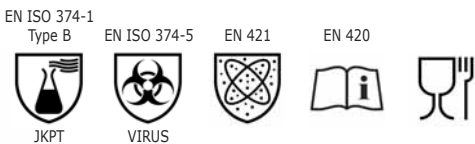

Disposable Nitrile Glove for Controlled Environments

- High Puncture Resistance
- High level of comfort
- Type I Allergy Protection
- Clean
- Suitable for cleanroom environment ISO Class 5
- Acid resistance, Chemical handling
- AQL 1.5 (EN374)
- Cat. III Low Chemical resistant
- Each glove is post cleaned, single pair packed and sterilize

Packaging: one pair per poly wallet, sealed in a poly envelope; 10 pairs per sealed polybag; 5 sealed polybags per master bag; 4 master bags per case liner; 200 pairs per carton.

According to EN ISO 374-1:2016/Type B, EN ISO 374-5:2016, EN 421, EN 420 Suitable for food handling.

Size	Length mm	PK	Cat. No.
6,5 - 7	300	200	6.273 808
7,5 - 8	300	200	6.273 809
8,5 - 9	300	200	6.273 824
9,5 - 10	300	200	6.273 825

1 Cleanroom Gloves, BioClean N-PLUS™, Nitrile, sterile

1

EN ISO 374-1
Type C EN ISO 374-5 EN 421

Nitritex Ltd



- Elbow length protection
- Low particulate count
- Powder-free
- Latex-free
- AQL 0.65
- Textured
- Hand specific
- Excellent ESD properties
- Chemical resistant
- Compatibility ISO Class 4
- Colour: white
- Carton with 20 bags with 10 pairs

According to EN ISO 374-1:2016/Type C, EN ISO 374-5:2016, EN 421, Suitable for food handling.

Packaging: 1 pair per plastic bag, 1 plastic bag per particle-free EasyTear™ bag, 10 pairs per sealed outer bag, 20 outer bags per inner carton bag

Size	Length mm	PK	Cat. No.
6	400	200	4.661 436
6,5	400	200	4.661 437
7	400	200	4.661 438
7,5	400	200	4.661 439
8	400	200	4.661 440
8,5	400	200	4.661 441
9	400	200	4.661 442
10	400	200	4.661 443

2 Cleanroom Gloves, BioClean LEGACY™, latex

2

EN ISO 374-1
Type C EN ISO 374-5 EN 421

Nitritex Ltd

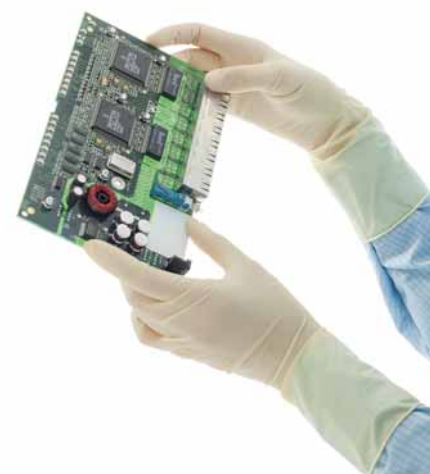

- Ambidextrous
- Powder-free
- AQL 0.65
- Textured
- Easy double-donning
- Chemical resistant
- Compatibility ISO Class 4
- Colour: natural
- Carton with 10 bags with 100 pieces

According to EN ISO 374-1:2016/Type C, EN ISO 374-5:2016, EN 421, Suitable for food handling.

Packaging: 100 pieces per sealed plastic inner bag, 1 inner bag per sealed outer bag, 10 outer bags per inner carton bag

Size	Length cm	PK	Cat. No.
XS	30	1000	4.661 378
S	30	1000	4.661 379
M	30	1000	4.661 380
L	30	1000	4.661 381
XL	30	1000	4.661 382



1 Cleanroom Gloves, BioClean LEGION™, latex

Nitritex Ltd

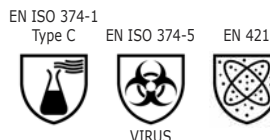

- Elbow length protection
- Ambidextrous
- Powder-free
- AQL 1.5
- Textured
- Easy double-donning
- Chemical resistant
- Compatibility ISO Class 5
- Colour: natural
- Carton with 10 bags with 100 pieces

According to EN ISO 374-1:2016/Type C, EN ISO 374-5:2016, EN 421, Suitable for food handling.

Packaging:

100 pieces per sealed plastic inner bag, 1 inner bag per sealed outer bag, 10 outer bags per inner carton bag

Size	Length mm	PK	Cat. No.
S	400	1000	4.661 383
M	400	1000	4.661 384
L	400	1000	4.661 385
XL	400	1000	4.661 386



2 Disposable Gloves AccuTech® 91-250, latex

Ansell



AccuTech® 91-250 has an inner silicone coating that facilitates easy donning and double-gloving. The cuff is slightly thicker, nicely fitting over the garment. The 91-250 glove is comprised of a specific formulation of latex that provides increased flexibility and elasticity. The glove's thinner fingertips, combined with the bisque finish, provide greater sensitivity, increased handling precision and dexterity. Suitable for cleanroom class ISO 5.

Color: Natural

- Powder-Free
- AQL of 1.0
- **Cat. III**

Packaging: The glove is packaged one pair per poly wallet, sealed in a poly envelope; 10 pairs per sealed polybag; 5 sealed polybags per master polybag; 4 master polybags per lined carton; 200 pairs per carton. All packaging is printed with cleanroom-compatible IPA-resistant ink. The gloves are triple-bagged for superior contamination control. The polybags have an easy-tear opening.

According to EN ISO 374-1:2016/Type B, EN ISO 374-5:2016, EN 420.

Size	Length mm	PK	Cat. No.
6	300	200	4.665 389
6,5	300	200	4.665 395
7	300	200	4.665 390
7,5	300	200	4.665 391
8	300	200	4.665 392
8,5	300	200	4.665 393
9	300	200	4.665 394

1 Cleanroom Gloves, BioClean ADVANCE™, latex, sterile

1

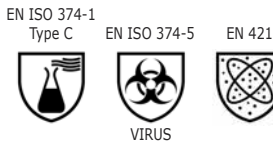

Nitritex Ltd



- Low particulate count
- Powder-free
- AQL 0.65
- Textured
- Hand specific
- Easy double-donning
- Chemical resistant
- Compatibility ISO Class 4
- Colour: natural
- Carton with 20 bags with 10 pairs

According to EN ISO 374-1:2016/Type C, EN ISO 374-5:2016, EN 421, Suitable for food handling.

Packaging: 1 pair per plastic bag, 1 plastic bag per particle-free EasyTear™ bag, 10 pairs per sealed outer bag, 20 outer bags per inner carton bag

Size	Length mm	PK	Cat. No.
6	300	200	4.661 396
6,5	300	200	4.661 397
7	300	200	4.661 398
7,5	300	200	4.661 399
8	300	200	4.661 400
8,5	300	200	4.661 401
9	300	200	4.661 402
10	300	200	4.661 403

2 3 Cleanroom Gloves Kimtech™ G3, latex, sterile

2

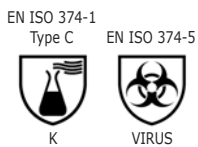

Kimberly-Clark



- Recommended for ISO Class 5 or higher cleanroom environments
- Natural rubber latex for tactile sensitivity and comfort
- Beaded cuff, for added strength and ease in donning
- Textured palms and fingers
- Powder free-minimising contamination and the drying effects of powder on skin
- Hand specific
- Low protein and low endotoxin levels
- Walleled and pouched in polyethylene for cleanroom use
- **Cat. III Low Chemical resistant.**
- AQL 1.5
- Manufactured in accordance with Quality System ISO 9001
- Box of 10 x 20 pairs. Individually packed per pair.

According to EN ISO 374-1:2016/Type C, EN ISO 374-5:2016.

Size	Length mm	PK	Cat. No.
6	300	200	4.652 643
6,5	300	200	6.267 248
7	300	200	6.267 249
7,5	300	200	6.267 250
8	300	200	6.267 251
8,5	300	200	6.237 698
9	300	200	6.267 252
10	300	200	6.267 253

3





1 Cleanroom Gloves, BioClean EXTRA™, latex, sterile

Nitritex Ltd



- Elbow length protection
- Low particulate count
- Powder-free
- AQL 1.5
- Textured
- Ambidextrous
- Easy double-donning
- Chemical resistant
- Compatibility ISO Class 4
- Colour: natural
- Carton with 20 bags with 10 pairs

According to EN ISO 374-1:2016/Type C, EN ISO 374-5:2016, EN 421, Suitable for food handling.

Packaging: 1 pair per plastic bag, 1 plastic bag per particle-free EasyTear™ bag, 10 pairs per sealed outer bag, 20 outer bags per inner carton bag

Size	Length mm	PK	Cat. No.
S	400	200	4.661 420
M	400	200	4.661 421
L	400	200	4.661 422
XL	400	200	4.661 423



2 Disposable Gloves AccuTech® 91-2225, latex, sterile

Ansell



AccuTech 91-225 gloves are made of a specific formulation of the latex that provides increased flexibility and elasticity. The optimised thickness of the latex, combined with the bisque finish, provides outstanding fingertip sensitivity plus increased handling precision and dexterity. This makes these gloves ideal for intricate handling operations. Suitable for cleanroom class ISO 5.

- Color: Natural
- Powder-Free
 - AQL of 1.0
 - **Cat. III**

Packaging: The glove is packaged one pair per poly wallet, sealed in a poly envelope; 10 pairs per sealed polybag; 5 sealed polybags per master polybag; 4 master polybags per lined carton; 200 pairs per carton. All packaging is printed with cleanroom-compatible IPA-resistant ink. The gloves are triple-bagged for superior contamination control. The polybags have an easy-tear opening.

According to EN ISO 374-1:2016/Type B, EN ISO 374-5:2016, EN 420

Size	Length mm	PK	Cat. No.
6	300	200	4.665 384
7	300	200	4.665 383
8	300	200	4.665 386

1 Cleanroom Gloves, BioClean FUSION™, Polychloroprene

Nitritex Ltd

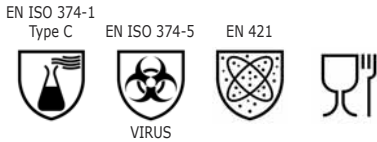

- Ambidextrous
- Powder-free
- Latex-free
- AQL 0.65
- Finger-textured
- Excellent ESD properties
- Easy double-donning
- Chemical resistant
- Compatibility ISO Class 4
- Colour: green
- Carton with 10 bags with 100 pieces

According to EN ISO 374-1:2016/Type C, EN ISO 374-5:2016, EN 421, Suitable for food handling.

Packaging:

100 pieces per sealed plastic inner bag, 1 inner bag per sealed outer bag, 10 outer bags per inner carton bag

Size	Length mm	PK	Cat. No.
XS	300	1000	4.661 368
S	300	1000	4.661 369
M	300	1000	4.661 370
L	300	1000	4.661 371
XL	300	1000	4.661 372



2 Cleanroom Gloves, BioClean FUSION™, polychloroprene, sterile

Nitritex Ltd



- Ambidextrous
- Powder-free
- Latex-free
- AQL 0.65
- Finger-textured
- Excellent ESD properties
- Easy double-donning
- Chemical resistant
- Compatibility ISO Class 4
- Colour: green
- Carton with 20 bags with 10 pairs

According to EN ISO 374-1:2016/Type C, EN ISO 374-5:2016, EN 421, Suitable for food handling.

Packaging: 1 pair per plastic bag, 1 plastic bag per particle-free EasyTear™ bag, 10 pairs per sealed outer bag, 20 outer bags per inner carton bag

Size	Length mm	PK	Cat. No.
5	300	200	4.661 451
6	300	200	4.661 452
7	300	200	4.661 453
8	300	200	4.661 454
9	300	200	4.661 455
10	300	200	4.661 456



1
1 Chemical Protection Gloves DermaShield®, Polychloroprene

Ansell

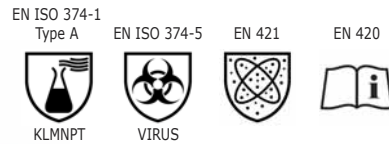

Made of polychloroprene, DermaShield® is free of latex, proteins and accelerators, it minimises both Type I and Type IV allergies associated with natural rubber. The beaded cuff prevents the glove from rolling down, providing increased protection.

- AQL 0.65 (EN374) - Ideal Application - Handling of cytostatics
- Suitable for cleanroom environment ISO Class 5
- **Cat. III**
- DermaShield® 73-711 sterile
- DermaShield® 73-721 non-sterile, for controlled environments

Packaging: The glove is packaged one pair per poly wallet, sealed in a poly envelope; 10 pairs per sealed polybag; 5 sealed polybags per master polybag; 4 master polybags per lined carton; 200 pairs per carton.

According to EN ISO 374-1:2016/Type A, EN ISO 374-5:2016, EN 421, EN 420.

Thickness: 0.175 mm
 Colour: green

Type	Size	Sterile	Length mm	PK	Cat. No.
73-721	6	-	310	200	4.664 500
73-721	6,5	-	310	200	4.664 501
73-721	7	-	310	200	4.664 502
73-721	7,5	-	310	200	4.664 503
73-721	8	-	310	200	4.664 504
73-721	8,5	-	310	200	4.664 505
73-721	9	-	310	200	4.664 506
73-711	6	+	310	200	4.664 507
73-711	6,5	+	310	200	4.664 508
73-711	7	+	310	200	4.664 509
73-711	7,5	+	310	200	4.664 510
73-711	8	+	310	200	4.664 484
73-711	8,5	+	310	200	4.664 485
73-711	9	+	310	200	4.664 486

2
2 Chemical Protection Gloves AdvanTech 517, Tri-Polymer

MAPA

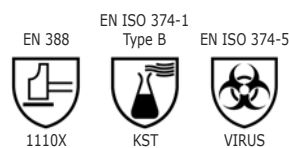

A tripolymer exclusive that offers 100% comfort for optimal mechanical and chemical resistance. Excellent resistance and strong chemical protection against a great number of chemical products: exclusive AdvanTech formula made from a mix of natural latex, neoprene and nitrile. Manufacturing process guarantees a very low level of contaminants: rates of particles, non-volatile residue, extractables. Compatible with ISO 5 class (Class M3.5 for International system). Wide cuff for double-gloving.

- **Cat. III**
- Thickness: 0.5 mm
- Packed per pair

Size	Length mm	PK	Cat. No.
6	360	1	6.304 079
7	360	1	6.303 886
8	360	1	6.303 887
9	360	1	6.281 467
10	360	1	6.281 468

1 Disposable Gloves, ASPURE, Seamless, PU

- Material: moisture permeable PU (polyurethane), back/polyester
- Ambidextrous
- Powder free
- Thickness: approx. 0.3 mm
- Clean Pack: Cleanroom clean with pure water
- Suitable for cleanroom environment ISO Class 5
- 1 bag with 10 pairs

AS ONE



This article is not CE certified as chemical protective glove !

Size	Length mm	PK	Cat. No.
XS	240	10	4.662 514
S	250	10	4.662 513
M	260	10	4.662 512
L	280	10	4.662 511
XL	300	10	4.662 510

2 PU Coated Gloves, nylon

The PU-coated nylon gloves are processed on the cuffs in a fraying preventing way.

AS ONE

- Very flexible
- Lint-free
- PU coated fingertips or coated palm
- Particularly handy and suitable for handling smooth and slippery objects
- Colour coding of the cuffs
- Pack of 10 pairs



Size	Description	Colour	PK	Cat. No.
XS	palm PU-coated	yellow	10	4.662 544
S	palm PU-coated	white	10	4.659 030
M	palm PU-coated	green	10	4.659 029
L	palm PU-coated	grey	10	4.659 028
XL	palm PU-coated	brown	10	4.659 027
XS	fingertips PU-coated	yellow	10	4.662 543
S	fingertips PU-coated	white	10	4.659 034
M	fingertips PU-coated	green	10	4.659 033
L	fingertips PU-coated	grey	10	4.659 032
XL	fingertips PU-coated	brown	10	4.659 031

3 Gloves ASPURE, PU-coated, nylon

- Exceptionally durable anti-slip PU (polyurethane) coating edge from fraying
- PU coated fingertips or coated palm
- Stretchy and fit perfectly
- Colour coding of the cuffs
- Bag with 10 pairs

AS ONE



Size	Description	Colour	PK	Cat. No.
XS	palm PU-coated	orange	10	4.662 554
S	palm PU-coated	white	10	4.662 553
M	palm PU-coated	green	10	4.662 552
L	palm PU-coated	grey	10	4.662 551
XL	palm PU-coated	yellow	10	4.662 550

4 Gloves ASPURE, PU-coated

- Exceptionally durable anti-slip PU (polyurethane) coating
- Overlock type
- The polyester material is exceptionally breathable
- PU coated fingertips or coated palm
- Stretchy and fit perfectly
- Colour coding of the cuffs
- Bag with 30 x 10 pairs

AS ONE



Size	Description	Colour	PK	Cat. No.
XS	fingertips PU-coated	yellow	300	4.662 559
S	fingertips PU-coated	white	300	4.662 558
M	fingertips PU-coated	green	300	4.662 557
L	fingertips PU-coated	grey	300	4.662 556
XL	fingertips PU-coated	brown	300	4.662 555
XS	palm PU-coated	yellow	300	4.662 564
S	palm PU-coated	white	300	4.662 563
M	palm PU-coated	green	300	4.662 562
L	palm PU-coated	grey	300	4.662 561
XL	palm PU-coated	brown	300	4.662 560

Gloves and fingercots/Undergloves-Finger cots

1 Undergloves white, polyester or nylon

- The hem on the wrist is overlapped to prevent the edge from fraying
- Exceptionally breathable
- Stretchy and fit perfectly
- Colour Detection of the cuffs
- Carton with 30 x 10 pairs

AS ONE

Size	Material	Colour	PK	Cat. No.
XS	polyester	yellow	300	4.662 515
S	polyester	white	300	4.659 021
M	polyester	green	300	4.659 020
L	polyester	grey	300	4.659 019
XL	polyester	brown	300	4.659 018
XS	nylon	yellow	300	4.662 516
S	nylon	white	300	4.659 025
M	nylon	green	300	4.659 024
L	nylon	grey	300	4.659 023
XL	nylon	brown	300	4.659 022



2 Undergloves Half Finger, Nylon

- 100% nylon
- Ambidextrous
- Semi-finger-fitting
- Suitable for operations which require a high tactile sensation on the fingertips
- For any handshape
- High tensile strength
- Universal size suitable for S-L
- Packaging 30 x 10 pairs

AS ONE

Size	PK	Cat. No.
S - L	300	4.659 026



3 Finger Cots, latex

Finger cots, made of latex, rolled, sizes 2-5, powderfree.

Size	PK	Cat. No.
2 (S)	100	6.205 860
3 (M)	100	6.086 994
4 (L)	100	6.086 996
5 (XL)	100	6.205 722



4 Finger Cots "High Grip", natural rubber

The finger cots made of antistatic natural rubber, with a thickness of min. 0.09 mm, are ideal for applications where the highest precision and fingertip sensation is required. Due to microtexturing, they are also especially handy.

AS ONE

- Surface resistance: 10^{10} - $10^{12} \Omega$

Size	Length	Description	Package contents	PK	Cat. No.
	mm				
M	65	natural rubber, rolled edge	20 x 1440 pieces	28800	4.675 453
L	65	natural rubber, rolled edge	20 x 1440 pieces	28800	4.675 454

1 **Cleansing Lotion ECOSAN**

Neutral cleansing syndet, also suitable for the food industry. *Peter Greven*

- transparent skin wash
- colorant-free
- soap- and alkali-free
- skin neutral pH value
- fragrance-free
- HACCP-compliant

Capacity ml	Description	PK	Cat. No.
1000	Neptune Bottle	6	6.291 684

1



2 **Cleansing Foam STEPHALEN® OPTI FOAM** **NEW**

Perfume and fragrance-free cleansing foam with OptiTens®. *Peter Greven*

- Contains rice protein
- Without colorants
- Free from soaps and alkali
- With skin-neutral pH value
- HACCP conform

Capacity ml	Description	PK	Cat. No.
1000	Neptune bottle	1	6.312 145

2



3 **Skin Protection Cream CUREA SOFT**

White, quickly absorbed skin care cream. Due to containing the naturally moisture-binding ingredient urea and the skin care substance bisabolol. CUREA SOFT supports the regeneration process of previously damaged skin. CUREA SOFT has a highly efficient and lasting skin care effect. *Peter Greven*

- O/W emulsion
- Silicone-free
- pH-neutral

Capacity ml	Description	PK	Cat. No.
100	Tube	1	6.240 906
100	Tube, fragrance-free	1	6.312 146
1000	Neptune bottle	1	6.291 688
1000	Neptune bottle, fragrance-free	1	6.312 054

3



NEPTUNE dispenser system TOUCHLESS

Universal dispenser with 5-in-1 technology: reliable dispensing of liquid soaps, foam, spray, alcohol gel and hand cleansers. *Peter Greven*

- made of plastic or stainless steel
- completely hygienic system as there is no contact between product and dispenser
- adjustable dispensing frequency (1 - 3 times)
- sturdy design
- optionally lockable
- drip tray available on request

The dispenser NEPTUNE TOUCHLESS STAINLESS STEEL is available as single unit in a cardboard box, incl. wall-mounting material. For using the touch-free dispenser, 4 batteries (Type C, 1.5V) are needed, which are **NOT** included in the delivery.

4



6.291 690

5



6.291 691

Type	For dispensing bottles ml	PK	Cat. No.
Dispenser plastic, white	1000 ml Neptune-bottle	1	6.291 690
Dispenser stainless-steel	1000 ml Neptune-bottle	1	6.291 691

15. Cleanroom Wipes and swabs/Dry wipes



1 Cleanroom Wipers ASPURE, polyester

The polyester long fibers reduce the generation of lint.
 - 100 % Polyester
 - Laser cutting
 - Double packed
 - Weight: 120 g/m² ± 5 %
 - Water absorbency: ≥ 280 ml/m²
 - Clean Pack: Cleanroom cleaned with ultrapure water

AS ONE

Dimensions mm	Cleanroom Class	Package contents	PK	Cat. No.
102 x 102	ISO 5	8 x 600 pieces	4800	4.663 627
152 x 152	ISO 5	24 x 150 pieces	3600	4.663 628
229 x 229	ISO 5	8 x 150 pieces	1200	4.663 629



2 Cleanroom Wipers ASPURE, polyester

Extremely low particle number and evaporation residues. Laser-cutting techniques minimise the formation of dust and lint on cutting edges. The use of polyester long fibers prevents the generation of lint.
 - Knitted made of 100 % polyester
 - Lasercut
 - Cleaned with ultrapure water
 - Double packed

AS ONE

Dimensions mm	Cleanroom Class	Package contents	PK	Cat. No.
102 x 102	ISO 5	10 x 600 pieces	6000	4.663 630
152 x 152	ISO 5	20 x 150 pieces	3000	4.663 631
229 x 229	ISO 5	1 x 150 pieces	150	4.659 070



3 Cleanroom Wipers ASPURE, polyester

Lower particle count, less evaporation residue, and fewer detected ions. The polyester long fibers and heatcut reduce the generation of lint.
 - 100 % Polyester
 - Heat cutting
 - Double packed
 - Weight: 130 g/m²
 - Thickness: 540 µm
 - Water Absorbency: 330 g/m²
 - Clean Pack: Cleanroom cleaned with ultrapure water

AS ONE

Dimensions mm	Cleanroom Class	Package contents	PK	Cat. No.
102 x 102	ISO 5	10 x 300 pieces	3000	4.663 632
152 x 152	ISO 5	15 x 150 pieces	2250	4.663 633
229 x 229	ISO 5	8 x 150 pieces	1200	4.663 634
229 x 610	ISO 5	8 x 30 pieces	240	4.663 650



4 Cleanroom Wipers ASPURE, polyester

Lower particle count, less evaporation residue, and fewer detected ions. The polyester long fibers and heatcut edges reduce the generation of lint.
 - 100 % Polyester
 - Heat cutting
 - Weight: 168 g/m²
 - Thickness: 570 µm
 - Water Absorbency: 370 g/m²
 - Clean Pack: Cleanroom clean with ultrapure water

AS ONE

Dimensions mm	Cleanroom Class	Package contents	PK	Cat. No.
102 x 102	ISO 5	8 x 300 pieces	2400	4.663 635
152 x 152	ISO 5	15 x 150 pieces	2250	4.663 636
229 x 229	ISO 5	8 x 150 pieces	1200	4.663 637

1 Cleanroom Wipers ASPURE, polyester, sterilized AS ONE

The wipers are packed in Class ISO 4 clean room environment.

- 2-layers structure of polyester fiber
- 100 % Polyester
- Gammasterilized
- Clean Pack: Cleanroom clean with ultrapure water

Dimensions mm	Cleanroom Class	Package contents	PK	Cat. No.
229 x 229	ISO 5	15 x 50 pieces	750	4.663 638



2 Cleanroom wipes Clino® CR One Way Premium, microfiber Pfennig Reinigungstechnik

One-way cleanroom wipes for all smooth surfaces in clean rooms, made of polyester continuous filament, knitted, edges cut

- Good folding properties and extremely low particle content
- Very good absorption properties
- Washed and packed in ISO 4 clean room
- Weight: 136 g/m²
- Double packed

Type	Dimensions mm	Cleanroom Class	Sterile	PK	Cat. No.
Purity 7225 SE	300 x 300	ISO 4 - 8	-	75	4.667 997
Purity 7225 GR	300 x 300	ISO 4 - 8	+	100	4.672 241



3 Cleanroom wipes Clino® CR Extreme XCPP, Polyester Pfennig Reinigungstechnik

Cleanroom wipes for all smooth surfaces in clean rooms, made of polyester endless filament, knitted, two-layer structure ultrasonically welded, edges laser-cut and sealed.

- Very high absorbency
- Ensure very low particle emission
- Very soft, high abrasion resistance
- Washed and packed in ISO 4 clean room
- Double packed
- Weight 241 g/m²

Dimensions mm	Cleanroom Class	PK	Cat. No.
300 x 300	ISO 4 - 8	100	4.667 985



4 Cleanroom Wipers ASPURE AS ONE

- PURE-3: 30 % Polyester, 57 % Rayon, 13 % Polyethylen
- AS-3R: 30 % Polyester, 70 % Rayon
- Quattro folded

Type	Dimensions mm	Package contents	PK	Cat. No.
PURE-3	200 x 250	30 x 100 pieces	3000	4.663 644
AS-3R *	250 x 250	30 x 100 pieces	3000	4.663 645

* Solvent resistance



5 Cleanroom Wipers ASPURE, polyester/rayon AS ONE

Cleanroom wipes made of nonwoven fabric.

- 30 % polyester/70 % rayon
- Quattro folded
- Weight: 30 g/m²
- Thickness: 360 µm
- Water absorbency: 226 g/m²

Dimensions mm	Cleanroom Class	Package contents	PK	Cat. No.
250 x 250	ISO 6	30 x 100 wipes	3000	4.659 073



15. Cleanroom Wipes and swabs/Dry wipes

1



1 Cleanroom Wipes Sontara® MicroPure, polyester/cellulose

Sontara® MicroPure nonwoven styles (woodpulp/polyester) are engineered for cleanroom use and combine absorbency of a natural fibre with the cleanliness and strength of a synthetic fibre in the same fabric. No binders or chemical treatments are used to manufacture them. The high cleanliness and purity are ensured by low extractable level and ion content as well as extremely low particle generation by the material itself. The fabric styles offer high particle and liquid absorbency due to their cellulose content.

Sontara

Type	Dimensions mm	Cleanroom Class	PK	Cat. No.
Sontara® MicroPure 100	305 x 305	ISO 5 + 6	150	9.390 185
Sontara® MicroPure 100	224 x 224	ISO 5 + 6	300	9.390 186
Sontara® MicroPure AP	305 x 305	ISO 6 - 9	150	9.390 187
Sontara® MicroPure AP	224 x 224	ISO 6 - 9	300	9.390 188
Sontara® MicroPure SV	305 x 305	ISO 7 - 9	250	9.390 189
Sontara® MicroPure SV	224 x 224	ISO 7 - 9	500	9.390 190

2



2 Cleanroom Wipes Bemcot®



Bemcot® is a fibre fleece made of 100% cellulose, made of cotton recycling material, without chemical additives and binding agents.

AS ONE

- Lint free
- Chemical resistant
- High Absorbency
- High wear resistance
- Sterilization possible by steam
- Easy disposal by incineration, without release of toxic gases

Type	Cleanroom Class	Dimensions mm	Package contents	PK	Cat. No.
Bemcot® M-3II	6 - 8	250 x 250	30 x 100 wipes	3000	6.292 207
Bemcot® M-1	6 - 8	150 x 150	40 x 150 wipes	6000	6.292 208
Bemcot® Super CN	5- 6	240 x 300	20 x 50 wipes	1000	6.292 209
Bemcot® TR-7F	6	250 x 250	20 x 150 wipes	3000	6.292 210
Bemcot® EA-8	8	300 x 250	30 x 100 wipes	3000	6.292 211
Bemcot® AZ-8	6 - 8	300 x 250	30 100 wipes	3000	6.292 212

3



3 Cleanroom Wipers ASPURE, cupro

- 100 % Cupro, very fine cellulose fibers
- adhesive-free
- Solvent resistance
- Quattro folded

AS ONE

Dimensions mm	Package contents	PK	Cat. No.
210 x 220	20 x 150 pieces	3000	4.663 643

4



4 Cleanroom Wipes ASPURE, polyester/nylon

Good dust suppression and wiping efficiency due to split fiber.

AS ONE

- Knitted made of 87 % polyester/13 % nylon
- Lasercut
- Double packed
- Weight: 130 g/m²
- Thickness: 360 µm
- Water absorbency: > 195 g/m²
- Clean Pack: Cleanroom clean with ultrapure water

Dimensions mm	Cleanroom Class	PK	Cat. No.
102 x 102	ISO 5	600	4.663 618
152 x 152	ISO 5	150	4.663 619
229 x 229	ISO 5	150	4.659 072

1 Cleanroom Wipers ASPURE, Polyester/nylon

Split fibers ensure a good wiping ability. AS ONE

- 75 % Polyester/25 % Nylon
- Laser cutting
- Double packed
- Weight: > 175 g/m²
- Thickness: > 320 µm
- Water absorbency: > 320 g/m²
- Clean Pack: Cleanroom clean with ultrapure water



Dimensions mm	Cleanroom Class	PK	Cat. No.
102 x 102	ISO 5	300	4.663 620
152 x 152	ISO 5	150	4.663 621
229 x 229	ISO 5	150	4.663 622

2 Cleanroom Wipes ASPURE, polyester/nylon

Split fibers ensure an good wiping ability. AS ONE

- Knitted made of 80 % polyester/20 % nylon
- Heat cut
- Double packed
- Weight: 210 ±10 g/m²
- Thickness: 410 ±30 µm
- Water Absorbency: >412.32 g/m²
- Clean Pack: Cleanroom clean with ultrapure water



Dimensions mm	Cleanroom Class	PK	Cat. No.
152 x 152	ISO 5	100	4.663 626
229 x 229	ISO 5	100	4.659 071

3 Cleanroom Wipers ASPURE, polyester/nylon

Split fibers ensure a good wiping ability. AS ONE

- 70 % Polyester/30 % Nylon
- Heat cutting
- Double packed
- Weight: > 210 g/m²
- Thickness: > 390 µm
- Water absorbency: > 300 g/m²
- Clean Pack: Cleanroom clean with ultrapure water



Dimensions mm	Cleanroom Class	PK	Cat. No.
102 x 102	ISO 5	100	4.663 623
152 x 152	ISO 5	100	4.663 624
229 x 229	ISO 5	100	4.663 625

4 Cleanroom dustcloth ASPURE

- Polyester 67%, Nylon 33% AS ONE

- Heat cutting
- Weight: 210 g/m²

For cleanroom use this dustcloth has to be washed according to required cleanroom class.



Dimensions mm	Cleanroom Class	Package contents	PK	Cat. No.
200 x 200	ISO 5	50 x 10 pieces	10	4.663 651

15. Cleanroom

Wipes and swabs/Dry wipes-Swabs



1 Cleanroom wipes Clino® CR One Way Profi, microfibre

One-way cleanroom wipes for all smooth surfaces in clean rooms, made of PE/PA microfibre, woven, edges ultrasonically sealed.

Pfennig Reinigungstechnik

- High absorbency
- For clean rooms up to class ISO 4
- High abrasion resistance
- Weight: 9 g/wipe
- Double packed

Dimensions	Cleanroom Class	PK	Cat. No.
mm			
300 x 300	ISO 4 - 8	150	4.667 999



2 Cleanroom wipes Clino® CR One Way Premium, microfibre

One-way cleanroom wipes for all smooth surfaces in clean rooms, made of PE microfibre, double-knitted manufacturing method with hot cut edges.

Pfennig Reinigungstechnik

- High residue-free capacity of particulate and organic contaminants such as dust and oily residues
- For very high sensitive surfaces
- For clean rooms up to class ISO 4
- Weight: 19.5 g/wipe
- Double packed

Dimensions	Cleanroom Class	PK	Cat. No.
mm			
300 x 300	ISO 4 - 8	150	4.667 998



4.667 994

Cleanroom wipes Clino® CR Pouch, pre-soaked

One-way cleanroom wipes for all smooth surfaces in clean rooms, made of polyester continuous filament, knitted, edges cut.

Pfennig Reinigungstechnik

- Cleanroom cloth, pre-soaked with 70% IPA and 30% DI-water
- Controlled consumption
- Ready for immediate use
- Low aerosol release compared to spraying process
- Conveniently packed in reclosable bags
- Weight: 37 g/m²
- Double packed

Type	Dimensions	Cleanroom Class	Sterile	PK	Cat. No.
	mm				
VS-Pro Pouch	230 x 280	ISO 5 - 8	+	30	4.667 994
Pouch	230 x 280	ISO 5 - 8	-	30	4.667 995

4 Swabs

Swabs with paper shafts and cotton head on both ends.

AS ONE

Type	Length	Head size	Package contents	PK	Cat. No.
	mm	mm			
round	76	3,6 x 15	100 x 25 pieces	2500	4.659 081
round	76	2,7 x 12	200 x 25 pieces	5000	4.659 082
round	78	4,7 x 15	50 x 25 pieces	1250	4.659 086
pointed	75	3,0 x 12	200 x 25 pieces	5000	4.659 083
pointed	77	2,8 x 14	200 x 25 pieces	5000	4.659 084
pointed	78	4,7 x 13	50 x 25 pieces	1250	4.659 085
round	148	4,7 x 15	10 x 100 pieces	1000	4.663 663
straight, one-sided, aluminium shaft	151	1,25 x 12	1 x 100 pieces	100	4.663 664

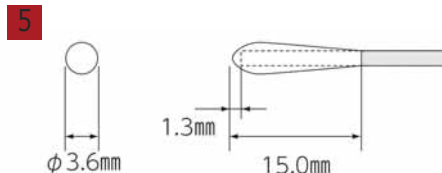

4.659 081

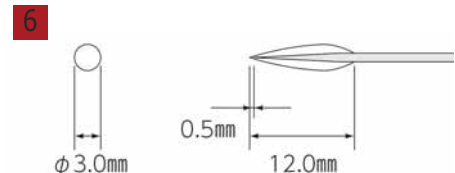

4.659 083

1 Cleanroom-Swabs

Cleanroom Swabs with polypropylene shaft and rounded head made of almost particle-free polyurethane or polyester. Packed dustfree in a cleanroom.

AS ONE



Length mm	Head size mm	Material Head	Material shaft	Cleanroom Class	Package	PK	Cat. No.
125	12,7 x 25	PU-foam	PP	ISO 5	double packed	100	4.659 074
125	12,7 x 25	Polyester	PP	ISO 5	double packed	100	4.659 075
162	6,8 x 16,8	PU-foam	PP	ISO 5	double packed	100	4.659 076
162	6,8 x 16,8	Polyester	PP	ISO 5	double packed	100	4.659 077
70	4.0 x 12.0	Polyester	PP	ISO 5	1 x 100 pcs.	100	4.659 078
70	3.5 x 11.0	PU-foam	PP	ISO 5	1 x 100 pcs.	100	4.659 079
70	3,5 x 11,0	Polyester	PP	ISO 5	1 x 100 pcs.	100	4.678 156

2 Precision-Swabs

Precision-swabs are engineered for use in a variety of environments and applications. They are ideal for use with cleaner degreasers, head cleaners, flux removers and other solvents for fast, precision cleaning.

Ideal-tek



Wrapped foam swabs

- Durable wrapped foam swabs designed for precise applications.
- Good particle entrapment and work well as solvent applicators
- Small tips allow use in very tight tolerance areas
- Wrapped foam delivers superior abrasion resistance for removal of tough contaminants
- Pointed end works especially well as a pick.

Sealed polyester swabs

- Very clean and durable all-purpose swabs
- Featuring either knit or nonwoven fabric heads, these swabs are acid and solvent resistant
- Sealed edges build in high strength with no loose fibers or particulates
- Ideal for tough scrubbing around raised shapes
- Cleanroom process gives the lowest ionic, non-volatile residue and particle contaminants.

Sealed foam swabs

- Economical general purpose swabs
- Best solvent retention
- Excellent particle entrapment
- The open cell structure gives the best solvent holding ability of any style of swab
- Free of adhesives or binders that could contaminate your process
- Fiberless construction does not generate particles.
- Suitable for ISO Class 4 Cleanrooms and higher

Length mm	Head size mm	Head	Material Head	Material shaft	Cleanroom Class	PK	Cat. No.
150	4,7 x 5,4	rounded	Polyester/Nylon	PP	ISO 4	125	4.655 171
70	3,7 x 3,7	wrapped, pointed	PU-foam	Nylon	ISO 4	125	6.266 882
70	2,4 x 3,0	rounded	Polyester	PP	ISO 4	125	6.266 884
70	1,6 x 3,0	rounded	Polyester	PP	ISO 4	125	6.266 885
70	1,0 x 3,0	rounded	Polyester	PP	ISO 4	125	6.266 886
70	3,3 x 3,5	rounded	PU-foam	PP	ISO 4	125	6.266 887
80	2,7 x 3,3	pointed	PU-foam	PP	ISO 4	125	6.266 888
68	2,5 x 3,0	rounded	PU-foam	PP	ISO 4	125	6.266 889

3 Cell pen swabs ASPURE

- Head made of ultrafine foam, PE
- Shaft made of PP
- Less dust than cotton swabs
- Replaceable head

AS ONE



Type	Head size mm	Length mm	PK	Cat. No.
Pen type, soft type	Ø 5 mm x 16 mm	125	500	4.663 652
Pen type, hard type	Ø 5 mm x 16 mm	125	500	4.663 653
45 degrees soft type	Ø 5 mm x 16 mm	125	500	4.663 654
45 degrees hard type	Ø 5 mm x 16 mm	125	500	4.663 655

Suitable accessories can be found in our online shop.

Wipes and swabs/Swabs-Cleaning rollers



4.663 660



4.663 661



4.663 662



4.663 662

Clean Swabs for cleanroom ASPURE

The low-dust head is welded to the main body. Head material : Polyester/nylon - microfiber.

AS ONE

Head size	Length	Cleanroom Class	PK	Cat. No.
mm	mm			
1.25 x 18.5	146	ISO 5	10	4.663 660
1.25 x 15	101	ISO 5	10	4.663 661
1.25 x 19.5	150	ISO 5	10	4.663 662

4 Sticky Swabs, ESD

Sticky Swabs - ESD safe cleaning stems: Dustfree sticky swabs are specially used and designed for a high degree dust-free environment (class10-100). Anti-static treatment can safely dissipate electrostatic charge. Sticky swabs are applicable for manufacturing and assembling static sensitive products. Property: ESD safe, good absorption, soft and good tenacity, excellent agility, non-volatile, environment-friendly, no thrill odor.

Ideal-tek

Material:

Tip: PVAC (Polyvinyl acetate), Ethyl acetate - Isopentyl acetate

Handle: PVC

Description	Cleanroom Class	PK	Cat. No.
1 mm Ø	ISO 1-2	25	6.272 061
2 mm Ø	ISO 1-2	25	6.272 062
3 mm Ø	ISO 1-2	25	6.272 063
Kit, box of 75 swabs mixed (25 x 1mm, 25 x 2 mm, 25 x 3 mm)	ISO 1-2	1	6.272 064



5 Adhesive Rolls ASPURE, PE

The PE film reduces particles considerably. The role can be mounted hanging to remove dust from the fingertips.

AS ONE

- Thickness: 50 µm/layer
- Adhesive power: 500 ±100 g/25 mm
- Inner diameter: 38 mm
- Handle is optional

Dimensions (D x W) mm	PK	Cat. No.
100 x 18000	10	4.663 667
200 x 18000	10	4.663 668



6 Adhesive Rolls ASPURE, antistatic, nonwoven fabric

AS ONE

- Film: nonwoven fabric, core: PE
- Anti-static protection
- Surface resistance: 10¹¹ Ω
- Thickness: 150 ±10 µm
- Adhesive power: 500 ±100 g/25 mm
- Inner diameter: 76 ±0.5 mm
- Handle is optional

Dimensions (D x W) mm	PK	Cat. No.
80 x 10000	12	4.663 671
160 x 20000	8	4.663 672
320 x 20000	1	4.663 673

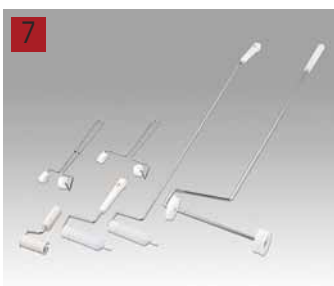

7 Handles for adhesive rolls ASPURE

Adhesive rolls are an option.

AS ONE

For	Material	Stem length mm	PK	Cat. No.
Roll width 80 mm	Grip Iron	350	1	4.663 679
Roll width 160 mm	Grip Iron	270	1	4.663 680
Roll width 80 mm	Grip ABS resin	175	1	4.663 681
Roll width 160 mm	Grip PE	275	1	4.663 682
Roll width 160 mm	Grip PE	1015	1	4.663 683
Roll width 320 mm	Grip PP	990	1	4.663 684

Wipes and swabs/Cleaning rollers-Paper and documentation/Paper, notebooks, pencils

1 Handcleaner Rolls ASPURE

The rollers are made of silicone rubber and are adhesive-free.

AS ONE

Dimensions (D x W) mm	Size	Material	PK	Cat. No.
180 x 170	Roll 152 x Ø 30 mm	Frame made of ABS resin	1	4.663 685
42 x 118	Roll 30 x Ø 20 mm	Frame made of aluminium	1	4.663 686
Ø 5 x 125	Head 15 x Ø 5 mm	Frame made of PE	1	4.663 687



4.663 685

3 Transfer Sheets Paper for handcleaner rolls ASPURE

Paper type:

- Unwoven fabric film, adhesive paper
- Adhesive strength standard: 1200 g/25 mm
- Adhesive strength split: 800 g/25 mm
- Sheet thickness: 230 µm

AS ONE

Film Type

- PE Film, acrylic adhesive paper
- Adhesive strength: 600 g/25 mm
- Sheet thickness: 80 µm



Type	Dimensions (D x W) mm	PK	Cat. No.
Paper type standard	240 x 330	500	4.663 697
Paper type split	240 x 165	500	4.663 698
Film type	195 x 335	500	4.663 699

4 Cleanroom Papers ASPURE

- Non-dusting
- Recyclable
- 72 g/m²
- Cellulose, water-soluble resin polymer
- Suitable for cleanroom class ISO 5

AS ONE

Size	Colour	Cleanroom Class	PK	Cat. No.
A4	blue	ISO 5	2500	4.663 782



5 Cleanroom papers ASPURE

The cleanroom papers are available in 5 different colours.

AS ONE

- 72 g/m²
- Cellulose, water-soluble resin polymer
- Suitable for cleanroom class ISO 5
- Surface resistance: <10¹¹Ω
- Packed dustfree in cleanroom

Size	Colour	Cleanroom Class	PK	Cat. No.
A4	blue	ISO 5	2500	4.659 102
A4	white	ISO 5	2500	4.659 103
A4	pink	ISO 5	2500	4.663 783
A4	yellow	ISO 5	2500	4.663 784
A4	green	ISO 5	2500	4.663 785
A3	blue	ISO 5	1250	4.659 104
A3	green	ISO 5	1250	4.663 787
B4	blue	ISO 5	1250	4.663 788



15. Cleanroom

Paper and documentation/Paper, notebooks, pencils



1 Cleanroom Papers ASPURE, economy

The cleanroom papers are available in 5 different colours. AS ONE

- 68 g/m²
- Cellulose, water-soluble resin polymer
- Anti-static protection
- Surface resistance: <math><10^{11}</math>Ω
- Packed dust free in cleanroom

Size	Colour	PK	Cat. No.
A4	blue	2500	4.663 789
A4	white	2500	4.663 790
A4	pink	2500	4.663 791
A4	yellow	2500	4.663 792
A4	green	2500	4.663 793
A3	blue	1250	4.663 794
A3	green	1250	4.663 795
A5	blue	5000	4.663 796
B4	blue	1250	4.663 797



2 Cleanroom Papers ASPURE, sterilized

AS ONE

- Dust-free
- Recyclable
- 72 g/m²
- Cellulose, water-soluble resin polymer
- Suitable for cleanroom class ISO 5
- Gammasterilized
- Packed dust free in cleanroom

Size	Colour	Cleanroom Class	PK	Cat. No.
A4	blue	ISO 5	2500	4.663 798
A4	white	ISO 5	2500	4.663 799



3 Cleanroom Notebook

Notebook suitable for use in Cleanrooms. 64 pages of white paper, horizontally lined. AS ONE

- Surface resistance: <math><10^{11}</math> Ω
- 72 g/m²
- Recyclable
- Packed dust free in cleanroom

Type	PK	Cat. No.
Cleanroom notebook	10	4.659 105



4 Cleanroom marker, edding 8011

For permanent marking of special cleanroom and laminated papers in dust-free environments. Edding

- Smudge-proof and waterproof
- Can be removed from most slides using isopropanol
- Ready to use
- Round tip
- Without any added xylene or toluene

Colour	Line width mm	PK	Cat. No.
black	0.6	10	6.284 876
blue	0.6	10	6.286 142

1 Adhesive Tape, PVC AS ONE

PET-coated Adhesive PVC-tape with water-soluble adhesive.
Available in different widths and colours.

- Easy to remove without stains
- Thickness: 0.14 mm
- Core: PE
- Packed dust free in a cleanroom

Width mm	Length m	Colour	PK	Cat. No.
12	33	red	10	4.659 106
12	33	blue	10	4.659 107
12	33	yellow	10	4.659 108
12	33	green	10	4.659 109
12	33	white	10	4.659 110
25	33	red	10	4.659 111
25	33	blue	10	4.659 112
25	33	yellow	10	4.659 113
25	33	green	10	4.659 114
25	33	white	10	4.659 115
50	33	red	5	4.659 117
50	33	blue	5	4.659 118
50	33	yellow	5	4.659 119
50	33	green	5	4.659 120
50	33	white	5	4.659 121



2 ASPURE ESD Line Tape, PVC AS ONE

PVC-tape with PET coating

- Core: PE
- Surface resistance value : $10^{5-6}\Omega$
- Thickness : 0.13 mm
- anti-static protection
- No ESD logo on black/yellow tape
- Packed dust free in a cleanroom

Width mm	Length m	Colour	PK	Cat. No.
50	33	yellow	5	4.663 858
50	33	white	5	4.663 859
50	33	red	5	4.663 860
50	33	blue	5	4.663 861
50	33	green	5	4.663 862
50	33	black/yellow	5	4.663 863



3 ESD Floor Marking Tape, PVC AS ONE

- Material: PVC, PET coated
- Core: PE
- black/yellow
- Thickness : 0.142 mm
- Packed dust free in a cleanroom

Width mm	Length m	PK	Cat. No.
50	33	5	4.659 122



4 Pure Seal Tape ASPURE, PTFE AS ONE

For filling gaps in water or air supply piping in cleanrooms

- Operating temperature limit: -100 °C ... 250 °C
- 1 g/m²

Width mm	Length m	Colour	PK	Cat. No.
13	15	white	6	4.663 847



15. Cleanroom

Paper and documentation/Tapes



1 Antistatic Double-Sided Tape ASPURE, PE

Double-sided polyester tape that maintains antistatic effect.

AS ONE

- Core: PE
- Surface resistance value : $10^9 \Omega$
- Thickness : 0.05 mm

Width mm	Length m	PK	Cat. No.
25	50	1	4.663 869
50	50	1	4.663 870
25	50	10	4.663 871
50	50	5	4.663 872



2 Conductive Double-Sided Tape ASPURE, PE

Double-sided nonwoven tape that maintains antistatic effect.

AS ONE

- Core: PE
- Surface resistance value : $0.05 \Omega/\text{cm}^2$
- Thickness : 0.05 mm

Width mm	Length m	PK	Cat. No.
25	50	1	4.663 873
50	50	1	4.663 874
25	50	10	4.663 875
50	50	5	4.663 876



3 Device Protection Film ASPURE, PE

- Water soluble adhesive
- Low-dust resin core with chamfered edges
- Thickness : 50 μm

AS ONE

Width mm	Length m	Colour	PK	Cat. No.
510	100	transparent	5	4.663 848
1020	100	transparent	2	4.663 849
510	100	blue	5	4.663 850
1020	100	blue	2	4.663 851



1 Cleaning trolleys Clino® CR mini EM-GMP1, stainless steel



Pfennig Reinigungstechnik

1



Impregnation system for 10 mops, for highly sensitive areas, including disposal. The small, compact CR mini cleaning unit was constructed in such a manner that it can be moved with the mop frame.

- Cleaning method: EasyMop GMP with a system box certified for areas under sterile conditions
- Single-stage wiping process
- Base modul electropolished
- ISO class 3
- GMP class A/B
- Autoclavable

Scope of delivery: Basic module mini made of stainless steel suitable for cleanrooms, autoclavable special castors (100 mm), system box EasyMop GMP, 9-litre stainless steel container MopTen for mop release.

Type	Dimensions (W x D x H) mm	PK	Cat. No.
Clino® CR mini EM-GMP1	530 x 430 x 430	1	4.667 989

2 Cleaning trolleys Clino® CR1 FP-GMP/Clino® CR3 FP-GMP with flat wringer Ringo GMP®, stainless steel



Pfennig Reinigungstechnik

2



4.667 992

For highly sensitive areas, with disposal.

- Cleaning method: Certified flat wringer Ringo GMP for sterile areas
- Changing between single and dual-stage wiping process
- ISO class 3
- GMP class A/B
- Autoclavable

Scope of delivery (Clino® CR1 FP-GMP): Basic module small, made of stainless steel suitable for cleanrooms, autoclavable special castors (100 mm), flat wringer Ringo GMP®, 25-litred stainless steel container, 35-litred stainless steel container, 9-litred stainless steel container.

Scope of delivery (Clino® CR3 FP-GMP): Basic module large, made of stainless steel suitable for cleanrooms, autoclavable special castors (100 mm), flat wringer Ringo GMP®, 2 x 25-litred stainless steel container, 2 x 9-litred stainless steel container.

Type	Dimensions (W x D x H) mm	PK	Cat. No.
Clino® CR1 FP-GMP*	530 x 740 x 700	1	4.667 993
Clino® CR3 FP-GMP	530 x 860 x 1090	1	4.667 992

* Base modul electropolished

3 Cleaning trolleys Clino® CR4 EM-GMP, stainless steel



Pfennig Reinigungstechnik

3



The modular design system suitable for the cleanroom, for use in highly sensitive areas.

- Cleaning method: EasyMop GMP with system box certified for areas under sterile conditions
- ClinoLink: Cleanroom-suitable connection system für individual attachment of accessory parts
- Single-stage wiping process
- Base module electropolished
- ISO class 3
- GMP class A/B
- Autoclavable

Scope of supply: Basic module medium, made of stainless steel suitable for cleanrooms, autoclavable special castors (100 mm), 2 system boxes EasyMop GMP stainless steel, 2 x 4 l stainless steel container, 1 x 35 l stainless steel container, 1 x 9 l stainless steel container

Type	Dimensions (W x D x H) mm	PK	Cat. No.
Clino® CR4 EM-GMP	630 x 610 x 1020	1	4.667 988

Cleaning equipment and tools/Cleaning systems, plastic

1



1 Cleaning trolleys Clino® CR mini EM-CR1, stainless steel

Impregnation system for 12 mops, for use in non-sterile areas. The small, compact CR mini cleaning unit was constructed in such a manner that it can be moved with the mop frame.

Pfennig Reinigungstechnik

- Cleaning method: EasyMop CR with ergonomically optimised system box
- Single-stage wiping process
- Base modul electropolished
- ISO class 7
- GMP class C

Scope of delivery: Basic module mini made of stainless steel suitable for cleanrooms, electrically conductive special castors (100 mm), 2 blue system boxes EasyMop, grey tray for system box EasyMop.

Type	Dimensions (W x D x H) mm	PK	Cat. No.
Clino® CR mini EM-CR1	520 x 430 x 450	1	4.667 990

2



2 Cleaning trolleys Clino® CR4 EM-CR, stainless steel



Pfennig Reinigungstechnik

The cleanroom-suitable modular design system for highly sensitive areas that do not require sterility.

- Cleaning method: EasyMop CR with ergonomically optimised system box
- Cloth impregnation for surface cleaning in PlusBox
- ClinoLink: Cleanroom-suitable connection system für individual attachment of accessory parts
- Single-stage wiping process
- Base module and castors electrically conductive
- ISO class 7
- GMP class C
- Autoclavable

Scope of supply: Basic module medium, made of stainless steel suitable for cleanrooms, electrically conductive special castors (100 mm), 2 blue system boxes EasyMop CR, 2 PlusBoxes, 1 grey tray for system boxes, 1 x 35 l und 1 x 5 l plastic container

Type	Dimensions (W x D x H) mm	PK	Cat. No.
Clino® CR4 EM-CR	630 x 610 x 1020	1	4.667 987

3



3 Cleaning trolleys Clino® CR6 FP with flat wringer, stainless steel



Pfennig Reinigungstechnik

3-bucket system with four buckets for surface cleaning and supply articles.

- Cleaning method: flat wringer Clino stainless steel
- Changing between single and dual-stage wiping process
- Basic module and castors electrically conductive
- ISO class 7
- Autoclavable

Scope of supply: Basic module large made of stainless steel suitable for cleanrooms, autoclavable special castors (100 mm), flat wringer Clino stainless steel, 3 x 15 l plastic bucket (blue) with stainless steel handle, 4 x 6 l plastic bucket (blue) with stainless steel handle

Type	Dimensions (W x D x H) mm	PK	Cat. No.
Clino® CR6 FP	540 x 800 x 1020	1	4.667 991

1 Mop covers King CR, single-use

1

Suitable for all standard cleanroom and pharmaceutical floors and for the single-stage wiping process.

Pfennig Reinigungstechnik

- 100 % polyester
- ISO class 3
- GMP class C
- Autoclavable
- Suitable for cytosstatica areas
- Very high-quality, cleanroom-suitable processing
- Pre-washed, single double packaged



Dimensions (D x W) mm	Weight g	Sterile	auto-clavable	PK	Cat. No.
400 x 120*	50	+	-	1	4.668 013
400 x 120	50	-	+	1	4.668 014

* gamma-sterilised

2 Mop covers Clino One Way Ultra PW/Clino One Way Ultra PW/I, single-use

2

For all standard cleanroom and pharmaceutical floors.

Pfennig Reinigungstechnik

- 100 % PES microfiber with special structure for optimum particle absorption
- ISO class 5
- GMP class A/B
- Very high-quality processing suitable for clean rooms
- Particularly smooth-running and effective due to soft bristles
- Pre-washed and single double packaged



Type	Dimensions (D x W) mm	Weight g	Sterile	PK	Cat. No.
Clino One Way Ultra PW-I*	400 x 120	55	+	5	4.668 011
Clino One Way Ultra PW	400 x 120	55	-	5	4.668 012

* gamma-sterilised

3 Mop covers MicroSicuro, PES

3

The germ reduction of bacteria, yeast fungus and mould of over 99 % will be reached by using water. Suitable for grey areas, all smooth and structured hard floors, safety tiles, dry cleaning and single-stage wiping.

Pfennig Reinigungstechnik

- 100 % PES High-tech microfiber, with soft bristle
- Washable up to 95 °C
- Suitable for low temperature dryer
- ISO class 9



Dimensions (D x W) mm	Weight g	PK	Cat. No.
400 x 120	130	1	4.668 007

4 Mop covers MicroSicurofor CR/A, PES, multiple-use

4



Pfennig Reinigungstechnik

Eliminates 99.9 % of all particles in single-step technique. For all standard cleanroom and pharmaceutical and perforated floors and safety tiles.

- 100 % PES-microfiber with special soft bristle
- Washable up to 95 °C
- Suitable for high dryer temperatures
- ISO class 5
- GMP class A/B
- Autoclavable up to 50 preparation cycles
- Desinfectant proof
- Resistant to gamma rays



Dimensions (D x W) mm	Weight g	PK	Cat. No.
400 x 120	110	1	4.668 008

Cleaning equipment and tools/Mop holders and covers

1



1 Mop covers MicroMopp standard CR/A, PES, multiple-use

Pfennig Reinigungstechnik



For all standard cleanroom and pharmaceutical floors and for single-stage wiping process.

- 100 % PES microfibre (polyester microloops) with polypropylene bristle
- Washable up to 95 °C
- Suitable for medium dryer temperatures
- ISO class 7
- GMP class C
- Autoclavable
- Not suitable for chlorinated disinfectants

Dimensions (D x W) mm	Weight g	PK	Cat. No.
400 x 120	110	1	4.668 009

2



2 Mop covers King CR, multiple-use

Pfennig Reinigungstechnik



Eliminates 99.9 % of all particles in single-step technique. For all standard cleanroom and pharmaceutical floors.

- 100 % PES microfiber yarn in high-tech-finish suitable for cleanrooms
- Hollow-knitted bagging with sealed edges
- Washable up to 95 °C
- Suitable for high dryer temperatures
- ISO class 5
- GMP class A/B
- Autoclavable up to 50 processing cycles
- Disinfectant proof
- Resistant to gamma rays
- Optimised for the flat wringer Ringo GMP
- Minimal amount of particle emission

Dimensions (D x W) mm	Weight g	PK	Cat. No.
400 x 120	140	1	4.668 010

3



3 Mop frames, stainless steel, invers

Pfennig Reinigungstechnik

- In particular for single-use mop
- Stainless steel plate on the bottom
- With Clino Connect Lock
- Not suitable for flat wringer
- Autoclavable
- Suitable for all PPS mop handles

Width mm	PK	Cat. No.
400	1	4.668 006

1 Mop frame Clino® Synchro CR and Clino® Synchro Hybrid

1



Pfennig Reinigungstechnik

The mop frames made of autoclavable technical high-performance plastics (Clino® Synchro CR) or in combination with stainless steel (Clino® Synchro Hybrid), especially for clean rooms, are easy to clean. They are suitable for detachment with MopDrop CR and impregnation with EasyMop®.

- Clino® Synchro Hybrid with metal wings made of V4A stainless steel
- With locking system Clino Connect Lock
- Can be opened by hand and foot
- Symmetrical opening for easier mop pick up
- 100 % contact surface
- Autoclavable
- Suitable for all PPS mop handles



Type	Dimensions (D x W) mm	Weight g	PK	Cat. No.
Clino® Synchro CR	400 x 100	372	1	4.668 001
Clino® Synchro Hybrid	400 x 100	475	1	4.668 005

2 Mop frames with handle, stainless steel, invers

2



Pfennig Reinigungstechnik

One-piece mop frames for clean rooms. Handle and handle pick-up made of one piece. They are suitable impregnation with EasyMop® and flat wringer Ringo®.

- Smooth processing
- GMP-conform
- Autoclavable



Length mm	Width mm	PK	Cat. No.
1600	400	1	4.668 004

3 Mop system IsoClean

NEW

3



Pfennig Reinigungstechnik

IsoClean mini Mop system for cleanroom-compatible cleaning of safety cabinets and isolators.

- Heat-stable special quality plastic
- Autoclavable
- With ClinoConnect Lock
- Suitable for all PPS mop handles

- Mop Clino One Way Ultra Mini PW-I
- single-use
 - pre-washed
 - gamma irradiated incl. certification
 - GMP class A/B
 - ISO class 5
 - 4 pieces double packed



5

4.671 402

4



4.671 401

Type	Width mm	Length mm	PK	Cat. No.
Mop ClinoOneWay Ultra Mini	70	190	4	4.671 401
Mop holder Clino CR	50	190	1	4.671 402
Mop holder Clino GMP	50	190	1	4.671 404

Cleaning equipment and tools/Mop holders-Facility/Mats and floor coverings

Telescopic handles



Pfennig Reinigungstechnik

- Suitable for all PPS mop handles
- Autoclavable

Description	Material	Length mm	PK	Cat. No.
With tilting lever, with sleeve and quick-release fastener	* Aluminium	1000 ... 1800	1	4.668 000
With tilting lever	Stainless steel	1000 ... 1800	1	4.668 003

* for ClinoConnect and ClinoConnect Lock



4.668 000



2 | 3 Adhesive Mats Sticky Mat

The Sticky Mat provides a fast, convenient, reliable way to clean shoe soles or other items before entering a clean and sanitary area. Sticky Mats significantly reduce traffic-borne contaminants.

Ergomat A/S

Each Sticky Mat consists of a stack of tear-off adhesive polyethylene sheets, effectively capturing dirt and dust from foot-traffic and equipment wheels before they enter controlled environments. A clear release sheet protects the top sheet of the sticky mat until it is ready to use. The corner tabs are consecutively numbered to show the number of remaining sheets, thereby helping you to keep track of the number of sheets remaining and preventing multiple sheets being removed at once.



Ergomat White Sticky Mats are produced in an 46 x 114 cm sheet, sold in pads of 30 sheets, with 10 pads per box (300 sheets total.)

Description	Colour	PK	Cat. No.
Frame for Cleanroom mats Sticky Mat	grey	1	6.272 245
1 mat of 30 sheets	white	10	6.272 241
1 mat of 30 sheets	blue	10	6.272 242
Set of 10 mats of 30 sheets + 1 frame	white	1	6.272 243
Set of 10 mats of 30 sheets + 1 frame	blue	1	6.272 244

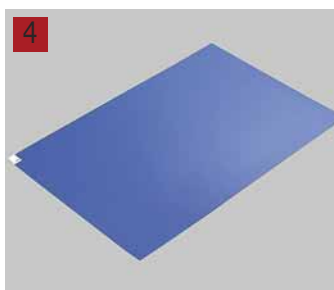

4 | 5 Sticky Mats ASPURE, LDPE

Removes dust and dirt from shoe soles in different adhesive levels with a thickness of 45 µm per layer.

AS ONE

- With count-up tag
- Water-soluble adhesive
- 1 carton with 10 mats, 30 layers



Type	Colour	Dimensions (D x W) mm	Thickness µm	PK	Cat. No.
Strong adhesive	blue	450 x 900	45	10	4.663 708
Strong adhesive	blue	600 x 900	45	10	4.663 709
Strong adhesive	blue	600 x 1200	45	10	4.663 710
Strong adhesive	white	450 x 900	45	10	4.663 711
Strong adhesive	white	600 x 900	45	10	4.663 712
Strong adhesive	white	600 x 1200	45	10	4.663 713
Medium adhesive	green	600 x 900	45	10	4.663 714
Medium adhesive	blue	450 x 900	40	10	4.663 715
Medium adhesive	blue	600 x 900	40	10	4.663 716
Medium adhesive	blue	600 x 1200	40	10	4.663 717
Medium adhesive	white	450 x 900	40	10	4.663 718
Medium adhesive	white	600 x 900	40	10	4.663 719
Medium adhesive	white	600 x 1200	40	10	4.663 720

1 Adhesive Mats ASPURE, MDPE

Removes dust and dirt from shoe soles in different adhesive levels with a thickness of 35 µm per layer. AS ONE
 If the top adhesive mat is soiled, you can simply remove this layer and work directly on the next one of the stack.
 The number of remaining mats on the stack is indicated by the number in the corner.
 1 carton with 10 mats, 30 layers or 1 carton with 6 mats, 60 layers

Type	Colour	Dimensions (D x W) mm	Thickness µm	PK	Cat. No.
Strong adhesive, 30 layers	blue	450 x 900	35	10	4.663 721
Strong adhesive, 30 layers	blue	600 x 900	35	10	4.663 722
Strong adhesive, 30 layers	blue	600 x 1200	35	10	4.663 723
Medium adhesive, 30 layers	blue	380 x 700	35	10	4.663 724
Medium adhesive, 30 layers	blue	450 x 900	35	10	4.659 087
Medium adhesive, 30 layers	blue	600 x 900	35	10	4.659 088
Medium adhesive, 30 layers	blue	600 x 1200	35	10	4.659 089
Medium adhesive, 30 layers	white	450 x 900	35	10	4.659 092
Medium adhesive, 30 layers	white	600 x 900	35	10	4.659 090
Medium adhesive, 30 layers	white	600 x 1200	35	10	4.659 091
Weak adhesive, 60 layers	blue	450 x 900	35	6	4.663 725
Weak adhesive, 60 layers	blue	600 x 900	35	6	4.663 726
Weak adhesive, 60 layers	blue	600 x 1200	35	6	4.663 727

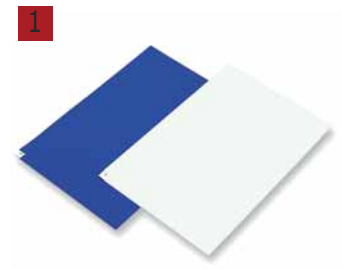

2 Sticky Mats ASPURE, LDPE

Removes dust and dirt from shoe soles. AS ONE
 - Anti-static protection on each layer
 - Surface resistance: 10⁹ - 10⁹ Ω
 - With count-up tag with a tickness of 45 µm per layer
 - Water-soluble adhesive
 - 1 carton with 10 mats, 30 layers

Colour	Dimensions (D x W) mm	Thickness µm	PK	Cat. No.
blue	450 x 900	45	10	4.663 728
blue	600 x 900	45	10	4.663 729
blue	600 x 1200	45	10	4.663 730

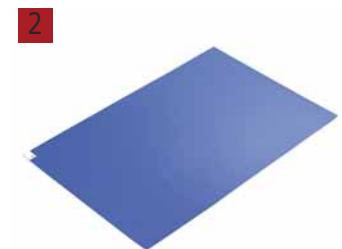

3 Adhesive Mats ASPURE, MDPE

If the top adhesive mat is soiled, you can simply remove this layer and work directly on the next one of the stack. The number of remaining mats on the stack is indicated by the number in the corner. 30 layers. AS ONE
 - Medium or weak adhesive
 - Antistatic
 - Surface resistance: 10⁹ - 10¹¹ Ω
 - With serial layer number (count-down), with a tickness of 35 µm per layer
 - Water soluble adhesive
 - 1 carton with 10 mats, 30 layers or 1 carton with 6 mats, 60 layers

Type	Colour	Dimensions (D x W) mm	Thickness µm	PK	Cat. No.
Medium adhesive, 30 layers	white	450 x 900	35	10	4.659 093
Medium adhesive, 30 layers	white	600 x 900	35	10	4.659 094
Medium adhesive, 30 layers	white	600 x 1200	35	10	4.659 095
Medium adhesive, 30 layers	blue	450 x 900	35	10	4.659 096
Medium adhesive, 30 layers	blue	600 x 900	35	10	4.659 097
Medium adhesive, 30 layers	blue	600 x 1200	35	10	4.659 098
Weak adhesive, 60 layers	blue	450 x 900	35	6	4.663 731
Weak adhesive, 60 layers	blue	600 x 900	35	6	4.663 732
Weak adhesive, 60 layers	blue	600 x 1200	35	6	4.663 733



4 Sticky Mats ASPURE, MDPE, antibacterial

Removes dust and dirt from shoe soles. AS ONE
 - Medium adhesive
 - With count-up tag
 - Water-soluble adhesive
 - 1 carton with 6 mats, 30 layers

Colour	Dimensions (D x W) mm	Thickness µm	PK	Cat. No.
green	450 x 900	35	6	4.663 736
green	600 x 900	35	6	4.663 737
green	600 x 1200	35	6	4.663 738

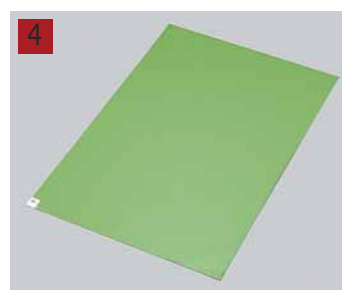



1 Undermat for Sticky Mats ASPURE

Frame for sticky mats in different sizes.

AS ONE

Material	Dimensions (D x W) mm	For	PK	Cat. No.
Plastic	550 x 1000	450 x 900	1	4.663 742
Plastic	700 x 1000	600 x 900	1	4.663 743
Plastic	700 x 1300	600 x 1200	1	4.663 744
Rubber	575 x 1025	450 x 900	1	4.659 099
Rubber	725 x 1025	600 x 900	1	4.659 100
Rubber	725 x 1325	600 x 1200	1	4.659 101



2 Adhesive mat Nomad™ 4300

Ideal for areas with increased demand for air purity . The adhesive layer on the Nomad™ mat collects when crossing all dust particles from the boots and binds them so that they cannot be spread . It does not have to be cleaned , if necessary the used adhesive layer is removed and a new layer is available.

3M Deutschland

The silicone-free and residue-free mat can easily be fixed on the floor.

- Consists of multiple , adhesive coated , clear polyethylene layers , which are attached on a vinyl backing
- For use in the entrance to sterile rooms (Cleanroom conditions), or requirements of highest hygiene
- 40 layers, numbered
- Removable disposable mat
- Easy to install
- Can be walked and driven on without any problems
- Very good removal and retention of dirt particles

Type	Colour	Dimensions mm	PK	Cat. No.
ADHWS45	white	450 x 1150	6	7.634 641
ADHWS60	white	600 x 1150	6	6.267 066
ADHBU60	blue	600 x 1150	6	6.267 065
ADHWS90	white	900 x 1150	6	6.267 903



3 4 Sticky Mats ASPURE, PU, wipeable

Removes dust and dirt from shoe soles.
Adhesiveness can be restored by wiping with water

AS ONE

- Antibacterial
- Wipeable



Dimensions (D x W) mm	Thickness mm	PK	Cat. No.
450 x 900	3	1	4.663 739
600 x 900	6	1	4.663 740
900 x 1200	6	1	4.663 741

1 2 Mat Infinity Smooth/Infinity Smooth ESD/Infinity Smooth Deluxe

Polyurethane anti-fatigue mat. Due to its closed surface the Infinity Smooth Mat is very easy to clean and has a very good chemical and UV resistance (except for organic solvents).

Ergomat A/S

- Solid workstation mat with filled nubs
- Dimensions 600 x 900 mm
- Shaped bevelled edges
- Silicone und Latex-free
- Anti-static properties
- Suitable for use in cleanrooms of class ISO 5
- 6 years warranty



Description	Colour	Height mm	PK	Cat. No.
Infinity Smooth	black	11	1	9.106 360
Infinity Smooth	white	11	1	9.106 361
Infinity Smooth	silver	11	1	9.106 362
Infinity Smooth	blue	11	1	9.106 363
Infinity Smooth ESD	black	11	1	9.106 364
Infinity Smooth ESD	white	11	1	9.106 366
Infinity Smooth ESD	silver	11	1	9.106 367
Infinity Smooth ESD	blue	11	1	9.106 365
Infinity Smooth Deluxe	black	15	1	9.106 368
Infinity Smooth Deluxe	stainless	15	1	9.106 369
Infinity Smooth Deluxe	silver	15	1	9.106 370
Infinity Smooth Deluxe	blue	15	1	9.106 371



3 Transport Trolley, stainless steel

Transport trolley made of stainless steel. Rugged construction made from two tubular steel bar push handles, Ø 25 mm with welded deep drawn shelves with elevated perimeter flange inbetween. Shelves are bevelled by 35 mm all over, with flat safety return to the inside. Chassis with 4 swivel castors, 2 of them with brake, Ø 125 mm, antistatic. Massive plastic bumper protect against damage.

Specifications

- Max. load per shelf: 40 kg
- Shelf dimensions: 800 x 500 mm
- External dimensions (W x D x H): 895 x 595 x 950 mm

Description	Load capacity	PK	Cat. No.
	kg		
2 shelves, stainless steel case, 4 wheels	80	1	6.291 558
3 shelves, stainless steel case, 4 wheels	120	1	6.290 737



15. Cleanroom

Facility/Trolleys, dispensers

Cleanroom Transport Trolley

- Material stainless steel (1.4301/AISI 304)
- Functional surfaces in KEK-Finish
- Shelves with a smooth surface or shelves with punched holes (ø 10 mm in 15 x 15 mm grid) to support the laminar flow of air
- Firmly welded
- Stabilized by reinforcement depending on design and dimensions
- Square profiles closed at the top with plastic caps
- 4 castors electrically conductive, 2 of them lockable

KEK

Description	Width mm	Depth mm	Height mm	PK	Cat. No.
with smooth shelf	800	600	1000	1	4.661 688
with smooth shelf	1000	600	1000	1	4.661 689
with smooth shelf	1200	600	1000	1	4.661 690
with perforated shelf	800	600	1000	1	4.661 691 1
with 2 smooth shelves	800	600	1000	1	4.661 692
with 2 smooth shelves	800	600	1000	1	4.661 693
with 3 smooth shelves	800	600	1000	1	4.661 694 2
with 3 smooth shelves	800	600	1000	1	4.661 695 3



4.661 691



4.661 694



4.661 695

Dispenser box

- Material stainless steel (1.4301/AISI 304)
- Functional surfaces in KEK-Finish
- To dispense of disposable items (hoods, gloves, etc.)
- 1 - 4 boxes
- Hinged lid with bow handle for filling
- Viewing slots on the front to monitor the filling level
- Embossed removal opening
- Removable drip tray arranged under the removal opening
- 2 mounting holes on the back for wall mounting

KEK

Type	Description	Width mm	Depth mm	Height mm	PK	Cat. No.
SPB-1-HIG	1 box	200	200	600	1	4.661 672
SPB-2-HIG	2 boxes	400	200	600	1	4.661 673
SPB-3-HIG	3 boxes	600	200	600	1	4.661 674
SPB-4-HIG	4 boxes	800	200	600	1	4.661 675 4



4.661 675

Laboratory Chair Labsit



Labsit is the new chair for all kinds of laboratories. Its intelligent Flex function offers comfort and laboratory ergonomics with minimal adjustments required. Labsit has all the properties required for laboratory work and, at the same time, it is light and universally applicable. Labsit is therefore a laboratory specialist and all-rounder all in one.

- Minimal joints: Hygienic design for easy cleaning and disinfection.
- Resistant to disinfectants and chemicals: Resistant to all of the usual disinfectants and chemicals.
- Seat upholstery made of artificial leather (soft and comfortable, washable and antibacterial) or soft-touch PU foam (extremely robust, washable and antibacterial) in black.
- Suitable for cleanrooms: Certified for the use in cleanrooms category 3 in accordance with ISO 14644-1.
- Adheres to biosafety level BSL1, BSL2 and BSL3 of the Directive for Biological Agents, GMP-conform.
- The backrest made of plastic with its 3D-Flex function automatically adapts to the movements of the user and therefore follows the upper body when leaning back or turning sideways.
- The Flex function on the front edge of the seat supports the forward-angled working which is typical for laboratory work.
- Its low weight and integrated handle provide maximum mobility and easy handling in the laboratory.
- Seat height adjustment by gas spring.
- Solid polished aluminium star base, flat design.
- The chrome-plated foot ring for the high chairs provides support through the wide tread area and can be easily and quickly adjusted in height.
- With certificate "Tested Safety" (GS mark).
- 10 years warranty, Made in Germany.

Accessories: Armrests (pair). Lab-Clip: The intelligent Lab-Clip enables Labsit to be easily, individually and quickly labelled, this creates order. Can be added or removed any time.

Type	Material	Description	Seat height adjustment	Colour	PK	Cat. No.	
			mm				
Lab Chair	Artificial Leather	Castors	450-650	Blue	1	6.287 729 1	
Lab Chair	Artificial Leather	Castors	450-650	Anthracite	1	6.287 730	
Lab Chair	Artificial Leather	Castors	450-650	Orange	1	6.287 731	
Lab Chair	PU Foam	Castors	450-650	Blue	1	6.287 732	
Lab Chair	PU Foam	Castors	450-650	Anthracite	1	6.287 733	
Lab Chair	PU Foam	Castors	450-650	Orange	1	6.287 734	
Lab Chair	Artificial Leather	Glides, Foot Ring	520-770	Blue	1	6.287 735	
Lab Chair	Artificial Leather	Glides, Foot Ring	520-770	Anthracite	1	6.287 736	
Lab Chair	Artificial Leather	Glides, Foot Ring	520-770	Orange	1	6.287 737 2	
Lab Chair	PU Foam	Glides, Foot Ring	520-770	Blue	1	6.287 738	
Lab Chair	PU Foam	Glides, Foot Ring	520-770	Anthracite	1	6.287 739	
Lab Chair	PU Foam	Glides, Foot Ring	520-770	Orange	1	6.287 740	
Lab Chair	Artificial Leather	Stop and Go Gastors, Foot Ring	560-810	Blue	1	6.287 741	
Lab Chair	Artificial Leather	Stop and Go Gastors, Foot Ring	560-810	Anthracite	1	6.287 742	
Lab Chair	Artificial Leather	Stop and Go Gastors, Foot Ring	560-810	Orange	1	6.287 743	
Lab Chair	Artificial Leather	Stop and Go Gastors, Foot Ring	560-810	Anthracite	1	6.310 404	
Lab Chair	PU Foam	Stop and Go Gastors, Foot Ring	560-810	Blue	1	6.287 744	
Lab Chair	PU Foam	Stop and Go Gastors, Foot Ring	560-810	Anthracite	1	6.287 745 3	
Lab Chair	PU Foam	Stop and Go Gastors, Foot Ring	560-810	Orange	1	6.287 746	
Armrests					1	6.287 748	
Clip		writable			1	6.287 749 4	



6.287 729



6.287 737



6.287 745



6.287 749



1 Hanger racks, stainless steel

With casters made of nylon urethane, with stopper, Ø 50 mm.

AS ONE

Dimensions (W x D x H) mm	PK	Cat. No.
1200 x 400 x 2000	1	4.663 777
1500 x 400 x 2000	1	4.663 778
1800 x 400 x 2000	1	4.663 779

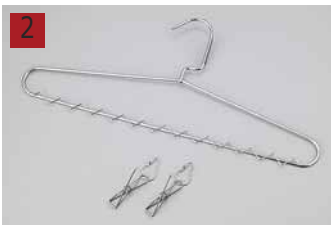

2 3 Hangers, stainless steel

- Hangers with name tags
- Hooks for hanging masks and gloves

AS ONE



Type	Dimensions (D x W) mm	PK	Cat. No.
Hangers	420 x 178.5	10	4.663 780
Hooks	-	6	4.663 781



4 Cleanroom Wall-Mounted Wardrobe

Wardrobe consisting of a base frame and coat hangers.

KEK

- Material stainless steel (1.4301/AISI 304)
- Firmly welded hangers
- Base frame made of square tube
- Square profiles with plastic caps (black) closed
- Prepared for on-site wall mounting
- 4 with plastic caps (black) closed mounting holes
- Without fastening material
- Variants with 7, 8, 9, 10, 11 coat hangers

Width mm	Depth mm	Height mm	Description	PK	Cat. No.
800	500	305	7 coat hangers	1	4.661 723
900	500	305	8 coat hangers	1	4.661 724
1000	500	305	9 coat hangers	1	4.661 725
1100	500	305	10 coat hangers	1	4.661 726
1200	500	305	11 coat hangers	1	4.661 727



5 Cleanroom Wardrobe

Wardrobe consisting of a base frame and coat hangers.

KEK

- Material stainless steel (1.4301/AISI 304)
- Firmly welded hangers
- Base frame made of square tube
- Crossbar for stabilization
- Square profiles with plastic caps (black) closed at the top
- Floor leveling with disc feet made of CNS (±10 mm)
- Variants with 9, 12, 15 coat hangers

Width mm	Depth mm	Height mm	Description	PK	Cat. No.
1000	500	2000	9 coat hangers	1	4.661 720
1300	500	2000	12 coat hangers	1	4.661 721
1600	500	2000	15 coat hangers	1	4.661 722

1 2 Sit-Over Benches, melamine

Sit-Over-Bench consisting of seating area, compartments for shoes and plinth.

KEK

- Material: melamine coated chipboard (V20)
- Color: white and grey
- Surface: matt
- Single sided version or double sided version
- three rows

Width mm	Depth mm	Height mm	Description	Colour	PK	Cat. No.
820	450	600	Single sided version, 9 compartments	white	1	4.661 737
820	450	600	Single sided version, 9 compartments	grey	1	4.661 738
1090	450	600	Single sided version, 12 compartments	white	1	4.661 739
1090	450	600	Single sided version, 12 compartments	grey	1	4.661 740
1360	450	600	Single sided version, 15 compartments	white	1	4.661 741
1360	450	600	Single sided version, 15 compartments	grey	1	4.661 742
820	600	600	Double sided version, 9 compartments per side	white	1	4.661 743
820	600	600	Double sided version, 9 compartments per side	grey	1	4.661 744
1090	600	600	Double sided version, 12 compartments per side	white	1	4.661 745
1090	600	600	Double sided version, 12 compartments per side	grey	1	4.661 746
1360	600	600	Double sided version, 15 compartments per side	white	1	4.661 747
1360	600	600	Double sided version, 15 compartments per side	grey	1	4.661 748

1

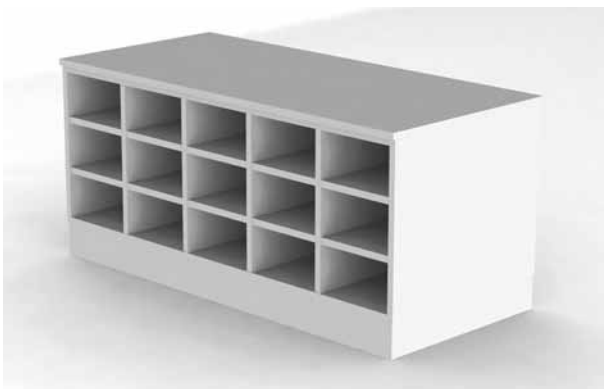

2

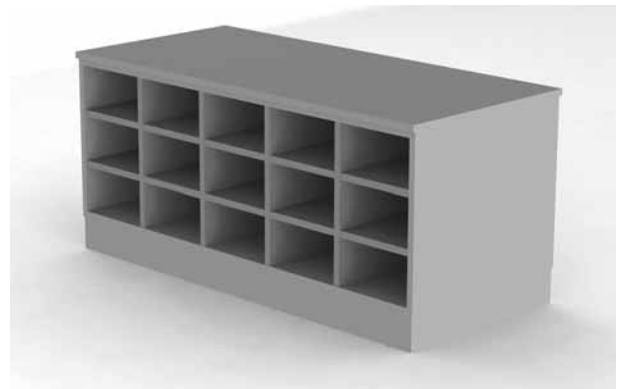

3 4 Sit-Over Benches, stainless steel

Sit-Over-Bench consisting of seating area, compartments for shoes and plinth.

KEK

- Material: AISI 304
- Working surfaces: KEK-Finish
- Single sided version with rear panel or double sided version
- Shoe boxes in three rows

Width mm	Depth mm	Height mm	Description	PK	Cat. No.
820	450	600	Single sided version, 9 compartments	1	4.661 728
1090	450	600	Single sided version, 12 compartments	1	4.661 729
1360	450	600	Single sided version, 15 compartments	1	4.661 730
820	600	600	Double sided version, 9 compartments per side	1	4.661 731
1090	600	600	Double sided version, 12 compartments per side	1	4.661 732
1360	600	600	Double sided version, 15 compartments per side	1	4.661 733

Further models can be found in our online shop.

3



4



ESD products/ESD-gloves and fingertots-ESD-mats and pads

1

1 Conductive Gloves ASPURE LINE, Anti-static, white, Nylon

- Material: Nylon
- Colour coding of the cuffs
- Surface resistance value : $10^6 - 10^8 \Omega$
- Bag with 10 pairs

AS ONE

Size	Colour	PK	Cat. No.
S	white	10	4.662 696
M	green	10	4.662 695
L	grey	10	4.662 694
XL	yellow	10	4.662 693

2

2 3 Conductive Finger cots ASPURE, anti-static, latex

- Material: latex
- Cut edge or Roll type
- Powder-free
- Fingertip embossed processing
- Thickness: approx. 0.10 mm
- Surface resistance: $10^6 - 10^8 \Omega$

AS ONE

3

Size	Length mm	Description	Package contents	PK	Cat. No.
S	61	Roll type	carton with 10 x 1440 pieces	14400	4.662 758
M	61	Roll type	carton with 10 x 1440 pieces	14400	4.662 759
L	61	Roll type	carton with 10 x 1440 pieces	14400	4.662 760
S	61	Roll type	1 pack with 1440 pieces	1440	4.662 761
M	61	Roll type	1 pack with 1440 pieces	1440	4.662 762
L	61	Roll type	1 pack with 1440 pieces	1440	4.662 763

4

4 ESD sheets ASPURE

For installation to work tables, protection shelves and mats that require anti-static measures. Electrostatic charges as high as 20000 volts can be reduce to safe level in a matter of seconds.

AS ONE

- Front: Nitril rubber, static electricity diffusion
- Back: Nitril rubber, conductive
- Resistant to oils, greases, and generic solvents
- Surface resistance front: $10^{8-9} \Omega$
- Surface resistance back: $10^{4-5} \Omega$

Colour	Dimensions (D x W) mm	Thickness mm	PK	Cat. No.
green	600 x 10000	2	1	4.663 745
gray	600 x 10000	2	1	4.663 746
green	900 x 10000	2	1	4.663 747
gray	900 x 10000	2	1	4.663 748
green	1200 x 10000	2	1	4.663 749
gray	1200 x 10000	2	1	4.663 750
green	1000 x 10000	2	1	4.663 751
gray	1000 x 10000	2	1	4.663 752
ivory	1000 x 10000	2	1	4.663 753
glossy green	1000 x 10000	2	1	4.663 754
glossy light green	1000 x 10000	2	1	4.663 756

Further products can be found in our online shop.

Legal measurement units are compulsory in legal and official use

Parameter	Name	Unit and conversion factor	Comments
Activity, radioactive	Becquerel	1 Bq = 1/s	SI Unit
	Curie	1 Ci = 3.7×10^{10} /s	
Equivalent dose	Sievert	1 Sv = 1 J/kg	SI Unit
	Röntgen equivalent man	1 rem = 10^{-2} J/kg	
Work, mechanical	Joule	$J = 1 \text{ N} \times \text{m} = 1 \text{ kg} \times \text{m}^2/\text{s}^2$	SI Unit
	Erg	1 erg = 10^{-7} J	
Illumination	Lux	1 lx = 1 lm/m ²	SI Unit
	Nox	1 nx = 10^{-3} lx	
Unit of power of a lens system	Dioptre	1 dpt = 1/m	also known as refractive power
Density	-	kg/m ³	SI Unit; measurement is usually given in g/ml or g/cm ³
Rotation, specific	-	Degrees x m ² /kg	SI Unit; measurement is usually given in degrees; rotation value of 1 g of substance in 1 ml of solution in a 10 cm long tube
	-	Degrees x dm ⁻¹ x g ⁻¹ x ml	
Number of revolutions	Revolutions per second	1 s ⁻¹ = 1 Hz	SI Unit
	Revolutions per minute	1 min ⁻¹ = 1 UpM = 1/60 s ⁻¹ = 1 min ⁻¹ = rpm	
Pressure	Pascal	1 Pa = 1 N/m ²	SI Unit; see also "Conversion of Imperial units into metric units" table
	Bar	1 bar = 10 ⁵ Pa	
	physical atmosphere	1 atm = 1.01325 x 10 ⁵ Pa	
	technical atmosphere	1 at = 1 kp/cm ²	
	techn. atmosph. overpressure	ato = atm + 1	
	Metres water column	1 mWS = 9.790 x 10 ³ Pa	
Energy	Joule	1 J = 1 N x m = 1 kg x m ² /s ² = 1 W x s	SI Unit
	Electronvolt	1 eV = 1.60219 x 10 ⁻¹⁹ J	
Absorbed dose	Calorie	1 cal = 4.1868 J	SI Unit
	Gray	1 Gy = 1 J/kg	
	Rad	1 rd = 0.01 J/kg	
Absorbed dose / rate	Rem	1 rem = 0.01 J/kg	SI Unit
	-	1 Gy/s = 1 W/kg	
Extinction coefficient, molar	-	l/mol x cm	also known as spectral absorption measure (DIN) or decadic absorptivity (IUPAC)
	-	l/g x cm	
Field strength, electric	-	l/g x cm	SI Unit
	Volt per metre	1 V/m = 1 m x kg/(s ³ x A) = 1 W/(A x m)	
magnetic	Ampere per metre	1 A/m	SI Unit
	Oersted	1 Oe = $\frac{10^3}{4\pi}$ A/m	
Area	Square metre	1 m ² = 1 m x 1 m = 1 sq. m	SI Unit
	Are	1 a = 10 ² m ²	
	Hectare	1 ha = 10 ⁴ m ²	
Flow, magnetic	Weber	1 Wb = 1 V x s	SI Unit
	Maxwell	1 M = 10 ⁻⁸ Wb	
Flow density, electric	Coulomb per square metre	C/m ²	SI Unit
	Tesla	1 T = 1 Wb/m ² = 1 V x s/m ²	
	Gauss	1 G = 10 ⁻⁴ T	

Parameter	Name	Unit and conversion factor	Comments
Frequency	Hertz	1 Hz = 1 s ⁻¹ 1 s ⁻¹ = 1 Hz	SI unit for periodic operations
Velocity	Metre per second Kilometre per hour	m/s 1 km/h = 0.27 m/s	SI unit
Inductance, electromagnetic	Henry Internat. Henry	1 H = 1 Wb/A = 1 V x s/A = 1 W x s/A ² = 1 Ω x s 1 H _{int} = 1.00049 H	SI unit
Ion dose	Coulomb per kilogram Röntgen	C/kg 1 R = 2.58 x 10 ⁻⁴ C/kg	SI unit
Capacitance, electric	Farad internat. Farad	1 F = 1 C/V = 1 A ² x s/W = 1 s/Ω 1 F _{int} = 0.99951 F	SI unit
Force	Newton Pond Dyn	1 N = 1 kg x m/s ² 1 P = 9.807 x 10 ⁻³ N 1 dyn = 10 ⁻⁵ N	SI unit
Charge, electric	Coulomb	1 C = 1 A x s = 1 J/V	SI unit
Length	Metre Micrometre Ångström Femtometre (Fermi) Inch	1 m 1 μ = 10 ⁻⁶ m 1 Å = 10 ⁻¹⁰ m 1 f = 10 ⁻¹⁵ m 1" = 25.4 mm	SI basic unit
Power	Watt Horsepower	1 W = 1 J/s 1 PS = 0.735 kW	SI unit
Conductance, related to length	Siemens per centimetre	1 S/cm = 1 Ω ⁻¹ x cm ⁻¹	SI unit
Conductance, electric	Siemens	1 S = 1 Ω ⁻¹	SI unit
Luminance	Candela per square metre Nit Stilb Lambert	1 cd/m ² 1 nt = 1 cd/m ² 1 sb = 1 cd/cm ² 1 la = $\frac{1}{\pi}$ sb = $\frac{1}{\pi}$ cd/cm ²	SI unit
Luminous radiation, specific	Lumen per square metre Phot	1 lm/m ² 1 ph = 1 lm/m ²	SI unit
Luminous intensity	Candela Hefner candle Internat. candle	1 cd 1 HK = 0.903 cd 1 IK = 1.019 cd	SI basic unit
Luminous Flux	Lumen	1 lm = 1 sr x cd = 1 cd	SI unit
Mass (Weight read from scales)	Kilogram Gram Ton Metric carat Atomic mass unit Dalton	1 kg 1 g = 10 ⁻³ kg 1 t = 10 ³ kg 1 Kt = 0.2 g 1 u = 1 amu = 1.6605 x 10 ⁻²⁷ kg 1 Dalton = 1.6602 x 10 ⁻²⁷ kg	SI basic unit For precious stones only
Voltage, electric	Volt Internat. Volt	1 V = 1 J/C = 1 W/A V _{int} = 1.00034 V	SI unit, also electric potential
Amount of substance	Mol Mol quantity Gram molecule Gram atom Gram equivalent	1 mol 1 Mol 1 Mol 1 Tom 1 Val	SI basic unit
Amount of substance fraction	- - Mole fraction	mol/mol % -	also known as amount fraction

Parameter	Name	Unit and conversion factor	Comments
Amount of substance concentration	Molarity	1 mol/l	
	Molality	1 mol/kg	
	Normality	1 N	
Current electrical	Ampere	1 A = 1 C/s	SI basic unit
	Internat. Ampere	1 A _{int} = 1.000291 A	
Temperature	Kelvin	K = °C + 273.15	SI basic unit
	Degrees Celsius	°C = K - 273.15	
	Degrees Kelvin	°K = K	
	Degrees Fahrenheit	°F = 1.8 K - 459.4	
	Degrees Rankine	°Rank = 1.8 K	
	Degrees Reaumur	°R = 1.25 °C	
Viscosity, dynamic	-	1 Pa x s = 1 N x s x m ² = 1 kg/s x m	SI unit
	Poise	1 P = 0.1 Pa x s	
kinematic	-	m ² /s	SI unit
	Stokes	1 St = 1 cm ² /s	
Volumes	Cubic metre	1 m ³ = 1 m x 1 m x 1 m = 1 cbm	SI unit
	Litre	1 l = 10 ⁻³ m ³ = 1 cdm	
	Solid cubic metre	1 Fm = 1 m ³	
	Stacked cubic metre	1 Rm = 1 m ³	
	Standard cubic metre	1 Nm = 1 m ³	
Volume flow rate	-	1 m ³ /s = 10 ³ l/s	SI unit
Volume flow	-	1 l/s = 10 ⁶ mm ³ /s	
Heat	Joule	1 J = 1 N x m = 1 W x s	SI unit
	Calorie	1 cal = 4.187 J	
Resistance, electrical	Ohm	1 Ω = 1 V/A = 1 W/A ² = 1 kg x m ² /s ³ x A ²	SI unit
	Internat. Ohm	1 Ω _{int} = 1.00079 Ω	
specific	-	1 Ω x mm ² /m	
Angle, plane	Radian	1 rad = 1 m/1 m = 57°17'45"	Supplementary SI unit (plane angle = relationship of an arc to the radius of a circle)
	Round angle	1 round ang. = 2π rad = 360°	
	Degree	1° = $\frac{\pi}{180}$ rad	
	Minute	1' = (1/60)°	
	Second	1" = (1/60)'	
	Gon	1 gon = $\frac{\pi}{180}$ rad	
solid	Steradian	1 sr = 1 m ² /1 m ²	Supplementary SI unit; solid angle = relationship of the area of the surface of the sphere cut off by this angle to the square of the radius of the sphere SI basic unit
Time	Second	1 s = 1 sec	
	Minute	1 min = 60 s = 1 min	
	Hour	1 h = 60 min	
	Day	1 d = 24 h	

Conversion of Imperial units into metric units

Parameter	Unit	Symbol	Conversion		Comments
Length	inch	in	1 in	= 2.54 cm	
	foot	ft	1 ft	= 0.305 m	
	yard	yd	1 yd	= 0.914 m	
	mile	mi	1 mi	= 1.609 km	
Area	square inch	in ²	1 in ²	= 6.452 cm ²	
	square foot	ft ²	1 ft ²	= 9.290 dm ²	
	square yard	yd ²	1 yd ²	= 0.836 m ²	
	square mile	mi ²	1 mi ²	= 2.590 km ²	
Volume	cubic inch	in ³	1 in ³	= 16.39 cm ³	
	cubic foot	ft ³	1 ft ³	= 28.31 dm ³	
	cubic yard	yd ³	1 yd ³	= 0.765 m ³	
Measure for liquids	minim		1 minim	= 59.19 mm ³	for GB
	minim		1 minim	= 61.61 mm ³	for USA
	fluid ounce	ozfl	1 ozfl	= 28.41 cm ³	for GB
	fluid ounce	ozfl	1 ozfl	= 29.57 cm ³	for USA
	liquid pint	pt	1 pt	= 568.3 cm ³	for GB
	liquid pint	pt	1 pt	= 473.2 cm ³	for USA
	liquid quart	qt	1 qt	= 1.136 dm ³	for GB
	liquid quart	qt	1 qt	= 946.4 cm ³	for USA
	gallon	gal	1 gal	= 4.546 dm ³	for GB
	gallon	gal	1 gal	= 3.785 dm ³	for USA
Measure for dry substances	barrel		1 barrel	= 159.0 dm ³	for oil
	dry pint		1 dry pint	= 550.6 cm ³	for USA
	dry quart		1 dry quart	= 1.101 dm ³	for USA
	dry barrel		1 dry barrel	= 115.6 dm ³	for USA
Mass (Weight)	grain	gr	1 gr	= 64,80 mg	
	dram	dr	1 dr	= 1.772 g	
	ounce	oz	1 oz	= 28.35 g	
	pound	lb	1 lb	= 453.6 g	
	quarter	qr	1 qr	= 12.70 kg	for GB
	cental	ctl	1 ctl	= 45.36 kg	for GB
	(long) hundredweight	cwt	1 cwt	= 50.80 kg	for GB
	short hundredweight	sh cwt	1 sh cwt	= 45.36 kg	for USA
	(long) ton	tnl	1 tnl	= 1016 kg	for GB
	short ton	tnsh	1 tnsh	= 907.2 kg	
	pennyweight	dwt	1 dwt	= 1.555 g	for precious stones and metals
	troy ounce	oztr	1 oztr	= 31,10 g	for GB
troy ounce	ozt	1 ozt	= 31,10 g	for USA	
Density	pound/cubic foot	lb/ft ²	1 lb/ft ²	= 0,016 g/cm ³	
	pound/cubic inch	lb/in ²	1 lb/in ²	= 27,68 g/cm ³	
	pound/cubic yard	lb/yd ²	1 lb/yd ²	= 0,593 kg/m ³	
Pressure	pound/square inch (p.s.i.)	lb/in ²	1 lb/in ²	= 6,895 · 10 ⁻² bar	
	pound/square foot	lb/ft ²	(1 p.s.i.)	= 6,895 · 10 ⁻² bar	
	inch Hg	in Hg	1 in Hg	= 4,788 · 10 ⁻⁴ bar	
	inch WS	in WS	1 in WS	= 3,337 · 10 ⁻² bar	
				= 2,487 · 10 ⁻³ bar	

Plastic Materials

The careful evaluation of material requirements by the user is absolutely necessary. The following recommendations from technical literature and/or the raw material manufacturers themselves only offer information to allow decisionmaking. They do not replace, under any circumstances, qualification tests by the user, who must be familiar with the respective application conditions in each case.

Plastics have become generally accepted as an alternative material to glass within the laboratory. Physical and chemical characteristics vary strongly. Application conditions decide which plastic is suitable. There are various influences: Exposure period and concentration of chemicals involved, temperature load, sterilization requirement, mechanical load, aging, e.g. by the effect of cleaning agents or by other environmental factors.

Abbreviations of the most important plastics, acc. to DIN 7728

ABS	Acrylo-Butadiene-Styrene-Copolymer	PBTP	Polybutylene terephthalate
ACL	Acetal (Polyoxymethylene)	PE-HD	High density polyethylene
CA	Cellulose acetate	PE-LD	Low density polyethylene
CN	Cellulose nitrate	PETP	Polyethylene terephthalate
CP	Cellulose propionate	PFA	Perfluoralkoxylalkane
ECTFE	Ethylene-Chlorotrifluoroethylene-Copolymer	PMMA	Polymethylmethacrylate
ETFE	Ethylene-Tetrafluoroethylene-Copolymer	PMP	Polymethylpentene (TPX®)
FEP	Tetrafluoroethylene-Perfluoropropylene	POM	Polyoxymethylene
GF	Glass-fibre, Glass-fibre reinforced	PP	Polypropylene
NBR	Nitrile rubber	PPO	modified Polyphenylene oxide
NR	Natural rubber	PS	Polystyrol
NYL	Nylon (Polyamide)	PSE	Polysulphone
PA	Polyamide (Nylon)	PTFE	Polytetrafluoroethylene
PAN	Polyacrylonitrile	PUR	Polyurethane
PC	Polycarbonate	PVC	Polyvinyl chloride
PCTFE	Polychlorotrifluoroethylene	SAN	Styrene-Acrylnitrile-Copolymer
PE	Polyethylene	SB	Styrene-Butadiene-Copolymer (Impact-resistant PS)
		SI	Silicone rubber
		TFE	Teflon® (Tetrafluoroethylene, PTFE)

Physical characteristics

	Operating temperature max. °C	Brittle point temperature °C	Density ca. g/cm ³	Flexibility	Transparency
ABS	85	-40	1.05	rigid	none
ECTFE/ETFE	150	-100	1.70	moderate	opaque
FEP/PFA	205/250	-270	2.15	moderate	opaque
NR	70	-40	1.2	excellent	none
PA	90	0	1.13	rigid	opaque
PC	130	-130	1.20	rigid	total
PE-HD	105	-50	0.95	rigid	opaque
PE-LD	80...90	-50	0.92	excellent	opaque
PMMA	65...95	-50	1.18	rigid	total
PMP (TPX®)	175	0	0.83	rigid	total
POM	85	-40	1.42	good	none
PP	135	0	0.90	rigid	opaque
PPO, mod.	150	-40	1.08	good	none
PS	70	-20	1.05	rigid	total
PTFE	270	-270	2.17	excellent	none
PVC	80	-20	1.35	rigid	total or coloured
SAN	70	-40	1.03	rigid	total
SI	180	-60	1.1	excellent	opaque

Sterilization stability of major plastics (without warranty)

Only sterilize carefully cleaned vessels, rinsed with distilled water.
Always remove closures!

	Steam sterilization 121°C, up to 20 min acc. DIN	°-Radiation 25 kGy	Gas (Ethylene oxide)	Chemical (Formalin, Ethanol)
ABS	no	no	yes	yes
ECTFE/ETFE	yes	no	yes	yes
FEP/PFA/PTFE	yes	no	yes	yes
NR	no	no	yes	yes
PA	no	yes	yes	yes
PC	yes ¹⁾	yes	yes	yes
PE-HD	no	yes	yes	yes
PE-LD	no	yes	yes	yes
PMMA	no	yes	no	yes
PMP (TPX®)	yes	yes	yes	yes
POM	no	no	yes	yes
PP	yes	no	yes	yes
PPO, mod.	yes	no	yes	yes
PS	no	yes	no	yes
PVC	no ²⁾	no	yes	yes
SAN	no	no	yes	yes
SI	yes	no	yes	yes

¹⁾ Loss of rigidity is possible.

²⁾ Some exceptions possible.

Chemical resistance of major plastics in relation to substance groups (without warranty)

Plastics are divided into the following three groups according to their chemical stability:

- A** = very good chemical stability.
Constant exposure to the medium does not cause damage to the plastic over 30 days.
The plastic can remain resistant for years.
- B** = good to fair chemical stability.
Constant exposure to the medium causes slight damage/change within the period of 7 to 30 days.
Some of these changes are partially reversible (radiation, softening, reductions in rigidity, discoloration).
- C** = low chemical stability.
Not suitable for prolonged exposure to the medium. Damage can occur immediately
(reduction in rigidity, deformation, discoloration, increased porosity, dissolving)!

Substance group	ABS	ECTFE ETFE	NR	PA	PC	PE-HD	PE-LD	PMMA	PMP (TPX®)	POM	PP	PPO	PS	PTFE FEP PFA	PVC	SAN	SI
at 20 °C																	
Acids																	
weak, dilute	B	A	B	B	B	A	A	C	A	C	A	B	B	A	A	B	B
highly conc.	C	A	C	C	C	A	A	C	A	C	A	C	B	A	A	C	C
oxidising acids																	
Oxidisers	C	B	C	C	C	B	B	C	B	C	B	C	C	A	C	C	C
Caustic solutions (lyes)	B	A	A	B	C	A	A	A	A	A	A	A	A	A	A	A	A
Alcohols, aliphatic	A	A	A	B	A	A	A	C	A	A	A	B	A	A	A	A	A
Ketones	C	B	C	A	C	B	B	C	B	A	B	C	C	A	C	C	C
Aldehydes	C	A	B	B	B	A	A	B	B	B	A	B	C	A	C	C	B
Esters	C	A	B	A	C	B	B	B	B	C	B	C	C	A	C	C	B
Hydrocarbons																	
aliphatic	C	A	C	A	B	A	B	A	B	A	A	A	C	A	A	C	C
aromatic	C	A	C	A	C	A	B	C	C	A	B	B	C	A	C	C	C
halogenated	C	A	C	B	C	B	C	C	C	A	B	B	C	A	C	C	C
Ether	C	A	C	A	C	B	C	C	C	A	B	C	C	A	C	C	C

2mag

-Magnetic stirrers / Hotplates451,455,457,459-460,477

3M Deutschland

-Breathing protection206,208-212
 -Ear protection214-215
 -Eye protection197-199,202
 -Facility1544
 -General laboratory aids165
 -Microbiology1362,1396
 -Sampling561
 -Steam sterilisers Autoclaves1206,1208
 -Thermometers389
 -Waste disposal263

A**A&D Inst.**

-Balances358,374

Ahlstrom-Munksjö

-Filtration708
 -Genomics1300

AHN

-Photometers1146

Amarell

-Climate and environment measurement418
 -Thermometers390,395
 -Timing416

Analox Sensor Technology

-Sample preparation1217

Ansell

-Gloves225,228-230
 -Gloves and fingercots1513,1516,1518,1520,1522
 -Protective clothing250

Anton Paar

-Density determination429-430
 -Refractometers1131
 -Viscosity determination435

Arctiko

-Cooling772,774,782,785

Argos Technologies

-Cooling793
 -Shakers and mixers533

AS ONE

-Disposable garments1507,1510
 -ESD products1550
 -Facility1542-1544,1548
 -Gloves and fingercots1523-1524
 -Microscopy1108
 -Paper and documentation1533-1536
 -Reusable garments1502-1504
 -Sampling562
 -Wipes and swabs1526-1533

asecos

-Furniture284,287-293

ATAGO

-pHmeasurement300
 -Photometers1135
 -Refractometers1126-1128,1130,1134
 -Viscosity determination433

B**Bandelin**

-Mixing, Homogenisation610-614
 -Ultrasonic cleaners596,1185,1187-1193

BartelsRieger

-Breathing protection207,210,212-213
 -Firstaid253

Bayha	
-Histology	1401
Becton Dickinson	
-Syringes	1461
behr	
-Distillation, synthesis	638
-Heating	845
-Magnetic stirrers / Hotplates	476
-Sample analysis	1250-1253,1259-1260,1262,1267-1274
-Sample preparation	1217-1220
-Vessels	48,60,70
-Water purification	1278-1279,1281
Bel-Art Products	
-Balances.....	384
-Cell Culture	1343
-Cooling	793-794
-Distillation, synthesis	643
-Furniture	280
-General laboratory aids.....	166-167,190
-Gloves	239-240
-Microscopy	1117
-NMR/EPR	1452
-Sampling	549
-Steam sterilisers Autoclaves	1206
-Thermometers.....	396
-Tools	120,130
-Tubing.....	152,162
-Vessels	39
-Volumetric apparatus	914
-Waste disposal	259,262
Bemis Company	
-General laboratory aids	193
Bimos	
-Furniture.....	276-277
BINDER	
-Cooling.....	772
-Heating	853,855-857,862,867-868,871,877,900-902
Biochrom	
-Photometers	1137,1142-1144,1146
biostep	
-Thinlayer chromatography	1499
BioTek a part of Agilent	
-Photometers	1144-1146
Bochem	
-General laboratory aids	175-183,185-186
-Grinding	566
-Heating.....	142-144
-Histology	1402
-Pipettes.....	945
-Tools	115-120,128-130,133-135
-Tubing	163
-Vessels.....	16,18,55,106-107,115
Böttger	
-Vessels	47
BOLA	
-Distillation, synthesis	633,648,652
-Filtration	750-751
-Liquid chromatography	1483
-Magnetic stirrers / Hotplates	477
-Overhead stirrers	489,496
-Tubing	149,156-158
-Vessels	69
BP	
-Protective clothing	246
Brady	
-General laboratory aids	171-172

BRAND

-Cell Culture	1338
-Cooling	755,760,794
-Density determination	427
-Dispensing	78,1004-1005,1016-1019
-Distillation, synthesis	649-650
-General Consumables	1297,1406-1408,1412,1417
-Genomics	1293-1297,1299
-Grinding	565
-Magnetic stirrers / Hotplates	476-477
-Microbiology	1374
-Microscopy	1114,1124
-Photometers	1158-1160
-Pipettes	928-930,932-936,940-941,946-948,952-954,978
-Proteomics	1297,1316-1317
-Separating, centrifuging	689,694,696
-Titration	1021,1023,1025-1028,1030
-Tools	123
-Trace analysis	1223,1226,1228
-Tubing	159-161
-Vessels	16,28,33,39,45,102
-Volumetric apparatus	910-913,915-917,919-923,925
-Water jet pumps	1060
B. Braun	
-Breathing protection	206
-Cleaning implements	1179
-Disinfection	1162-1163,1166
-Gloves	218-219
-Histology	1401-1402
-Syringes	1460-1462
-Waste disposal	261
b.safe	
-Liquid chromatography	1478-1479
B-SAFETY	
-Firstaid	254-257
Buddeberg	
-Distillation, synthesis	653
-Heating	840
-Overhead stirrers	490-492
BÜCHI	
-Liquid chromatography	1476
-Rotary evaporators	659-660
Bühler	
-Shakers and mixers	509-510,514-517,538-539
Bürkle	
-Cleaning implements	1184
-Cooling	790
-Firstaid	255
-Pipettes	943
-Pumps	1037-1042
-Sample analysis	1261
-Sampling	543-548,551-553,555-559
-Titration	1024
-Tools	120-124,136,139
-Trace analysis	557-558
-Tubing	152,158,163-164
-Vessels	45,49,57,59-60,85,95-97,102,109-110
-Waste disposal	263

C**Campingaz**

-Cooling	790-791
-Heating	141

Carl Stuart Limited

-Gas chromatography	1486-1487
---------------------------	-----------

CertoClav

-Steam sterilisers Autoclaves	1197-1200
-------------------------------------	-----------

CHEM-LAB

-Genomics.....	1300
-Sample analysis.....	1236
-Vessels.....	1451

Cleaver Scientific

-Genomics.....	1305-1312
-Proteomics.....	1321-1326

Colder Products

-Tubing.....	153-156
--------------	---------

Cole-Parmer

-Pumps.....	1044-1045,1048-1050,1054
-------------	--------------------------

CRC

-Disinfection.....	1173
-General laboratory aids.....	170,194

Crystal Technology

-Cooling.....	795
---------------	-----

D

Deutsch & Neumann

-Filtration.....	746,750-751
-General laboratory aids.....	191
-Pipettes.....	942
-Rotary evaporators.....	662
-Sample analysis.....	1275
-Titration.....	1028
-Tubing.....	146-147,149
-Vessels.....	29,31

Dino-Lite

-Material testing.....	440
-Microscopy.....	440,1105-1106

Dostmann electronic

-Climate and environment measurement.....	422-423
-Thermometers.....	392,400,402-404,409,411-413
-Timing.....	416-417

Dr. Weigert

-Disinfection.....	1162,1164,1167-1171
--------------------	---------------------

Dräger

-Sample preparation.....	1212-1216
--------------------------	-----------

Dülabo Laborgeräte

-Pumps.....	1044
-------------	------

DuPont de Nemours

-Disposable garments.....	1506,1508-1509
-Protective clothing.....	247,250-251

DWK Life Sciences

-Accessories.....	1077
-Cell Culture.....	1335,1340
-Desiccators.....	1081-1083
-Distillation, synthesis.....	630,632,644,647-648,651,655
-Filtration.....	743,746-749,751-752
-Heating.....	145
-Histology.....	1400
-Liquid chromatography.....	1477
-Microbiology.....	1364-1365,1370-1371,1374-1376,1387-1389
-Microscopy.....	1122
-NMR/EPR.....	1453
-Separating, centrifuging.....	688,690
-Steam sterilisers Autoclaves.....	1206-1207
-Titration.....	1022
-Trace analysis.....	1231
-Vessels.....	13-14,19-22,26-27,43,62-70

E**ebro**

-Conductivity measurement	329,331
-pHmeasurement	300,302-303
-Sample analysis.....	1237
-Thermometers	391,393-394,397-399,401,403,405-408,410-411

ECOSAFE

-Furniture.....	282-283
-----------------	---------

Edding

-General laboratory aids	172-173
-Paper and documentation.....	1534
-Tools	129

Electrothermal

-Analytical instruments and systems.....	444
-Heating	143
-Histology	847-849
-Histology	1403-1404

Eppendorf

-Dispensing	1006-1007
-General Consumables	692-693,1409-1410,1414,1418
-Genomics	1294,1296-1297,1314
-Heating	896
-Photometers.....	1157,1159
-Pipettes.....	972-978,995-998
-Separating, centrifuging	668,681-686,692
-Shakers and mixers.....	504,531-532
-Vessels	34

Ergomat

-Facility.....	1542,1545
-Furniture	278

Eschenbach

-Optical instruments.....	1094-1096
---------------------------	-----------

ESCO

-Cell Culture.....	1357-1359
-Furniture.....	284-286
-Genomics.....	1305
-Heating	875

evoqua

-Water purification	1281,1289-1290
---------------------------	----------------

Exacta Optech

-Optical instruments	1096
-Photometers.....	1135
-Refractometers	1133

F**Fritsch**

-Grinding	580,586-590
-Sieving	593,598

Fryka-Kältetechnik

-Cooling	775,777-778,781,783
-Temperature regulators	825

G**Gerber**

-Sample analysis	1275-1277
------------------------	-----------

Gestigkeit

-Heating	839,844-845,902
----------------	-----------------

Glasfirn Gießen

-Pipettes.....	941
----------------	-----

Glindemann

-Distillation, synthesis	652
--------------------------------	-----

Gorr

-Furniture	294
-Transport.....	271

Grant	
-Cell Culture.....	1351-1352
-Genomics.....	1305
-Heating.....	505,830-831,836-837,878,892-893
-Microbiology.....	1379
-Photometers.....	1143
-Separating, centrifuging.....	667,669
-Shakers and mixers.....	499,505,508,521-523,528-529,533-534,539-540
-Temperature regulators.....	799-800,813-814
Greiner Bio-One	
-Microbiology.....	1365
-Separating, centrifuging.....	693,695
Grün-Pumps	
-Pumps.....	1040-1041
GVS	
-Filtration.....	739
-Proteomics.....	1323
H	
H+H System	
-Cooling.....	786
Hahnemühle	
-Filtration.....	707-708,714,720
-Proteomics.....	1322
-Sample analysis.....	1267
-Thinlayer chromatography.....	1498
Hailo	
-Furniture.....	278
Haldenwanger	
-Filtration.....	749
-Grinding.....	565
-Microscopy.....	1121
-Tools.....	117
-Vessels.....	105-107,112-114
Hamilton	
-Microfluidics.....	1058
-Syringes.....	1455-1458
Hammacher	
-Histology.....	1402-1403
-Microbiology.....	1369
-Tools.....	118-119,125,127,135
Hanhart	
-Timing.....	416-417
Hartmann	
-Cleaning implements.....	1180
-Disinfection.....	1163-1164
Harvard Apparatus	
-Genomics.....	1315
Haubold Technik	
-Thinlayer chromatography.....	1500
Heathrow Scientific	
-Cooling.....	36,757-759,761-763,765,793
-General Consumables.....	1414
-General laboratory aids.....	169-170,173,191
-Genomics.....	1298-1299
-Gloves.....	231,239
-Microbiology.....	1392
-Microscopy.....	1115,1117,1119-1121,1123
-Pipettes.....	944,950-951,968,1000-1001
-Safety containers.....	264
-Separating, centrifuging.....	666
-Shakers and mixers.....	507
-Tools.....	123
-Vessels.....	23,34-36,38-39
Hecht	
-Microscopy.....	1107,1115,1118,1122
-Vessels.....	27

Heidolph	
-Diaphragm pumps.....	1069,1072
-Heating	878
-Magnetic stirrers / Hotplates.....	449,452,469
-Overhead stirrers	488-489,495
-Pumps.....	1051-1052
-Rotary evaporators	661
-Shakers and mixers.....	499,503,521,526,534-535,540
Heinz Herenz	
-Microbiology	1368
-Tools	137
Hellma Analytics	
-Photometers	1151-1156,1160
Henke-Sass Wolf	
-Syringes	1356,1460
Hermle	
-Separating, centrifuging	675-680
Hilgenberg	
-NMR/EPR	1452-1454
-Pipettes	936,942
Hirschmann	
-Cell Culture	1345
-Dispensing	1014,1020
-Microbiology.....	1373-1374
-Pipettes.....	927,929-931,933,935,940,946-947
-Pumps.....	1046
-Titration	1021-1022,1024,1026,1029-1030
-Volumetric apparatus.....	910-912,917,919-922,924
HMC-EUROPE	
-Steam sterilisers Autoclaves.....	1203-1205
Honeywell Safety Products	
-Eye protection.....	205
HORO	
-Heating	143
Huber	
-Temperature regulators.....	801-802,804,814-817,822-824,827-828
Hülden	
-Tools	131
Hünersdorff	
-Vessels	61,99
I	
IBI Scientific	
-Genomics.....	1301
-Shakers and mixers	524,526
Icecatch	
-Cooling	791-792
Ideal-tek	
-Microscopy	1108
-Tools.....	127-128,133-135,137
-Wipes and swabs	1531-1532
IKA	
-Grinding.....	575-579
-Heating.....	839-840,843,858,885-886,895-896
-Magnetic stirrers / Hotplates	448-450,452-454,460,464-465,467,470-474
-Mixing, Homogenisation	490,603-605,607-609
-Overhead stirrers	479-483,486-487,489-490,494
-Rotary evaporators	656-658
-Separating, centrifuging	666,670
-Shakers and mixers	499-502,511-513,515-517,519,524,530,534,536,538
-Viscosity determination	435
interscience	
-Microbiology	1364,1393,1395
-Mixing, Homogenisation	614-616
-Steam sterilisers Autoclaves	1207

ISOLAB

-Balances.....	381
-Cell Culture.....	1347
-Cleaning implements.....	1182
-Cooling.....	762
-Density determination.....	427
-Distillation, synthesis.....	386,618-620,622-626,629,634-637,639-641
-Filtration.....	751
-General laboratory aids.....	167-169,178,184,186
-Genomics.....	1298
-Heating.....	144-145
-Liquid chromatography.....	1475
-Microbiology.....	1366,1392
-Optical instruments.....	1094
-Photometers.....	1160
-Pipettes.....	927,931,941,943,945
-Rotary evaporators.....	662
-Sample analysis.....	1261-1262,1267
-Sampling.....	564
-Titration.....	1021,1024-1025
-Tools.....	118-119,127,135-136
-Vessels.....	16,20-21,36-37,50,67,97,100-102,109
-Volumetric apparatus.....	910-911,913,916-918,923,926

J**Jenway**

-Photometers.....	1139-1142,1148
-------------------	----------------

Juchheim Laborgeräte

-General laboratory aids.....	177-178,180-182,184,186-187
-Heating.....	145

JULABO

-Heating.....	819,832-833,838
-Temperature regulators.....	805-811,817-820,824-826,828

Jutec

-Gloves.....	240
--------------	-----

K**Kaiser Fototechnik**

-Optical instruments.....	1096
---------------------------	------

Kartell

-Cleaning implements.....	1184
-Desiccators.....	1084
-Distillation, synthesis.....	628,649
-Filtration.....	750
-Histology.....	1398
-Microscopy.....	1119-1120,1123
-Photometers.....	1157
-Pipettes.....	944
-Safety containers.....	264
-Sample analysis.....	1261-1262
-Separating, centrifuging.....	695
-Tools.....	124,126
-Tubing.....	160-161
-Vessels.....	14,17,23,29,37,40,43,45,47,74,86,102,104,108,110
-Water jet pumps.....	1060

Kautex

-Vessels.....	48,54,57,61,74-75,77,80-83,87-90,93,95
---------------	--

KD Scientific

-Microfluidics.....	1055-1057
---------------------	-----------

KEK

-Facility.....	1546,1548-1549
----------------	----------------

Kern & Sohn

-Balances.....	354-355,357-361,363,367-369,375-376,380-381,384
-Microscopy.....	1101-1102,1104-1105
-Refractometers.....	1132

KGW

-Accessories	1075-1076
-Cooling	768-771

Kimberly-Clark

-Cleaning implements	1174-1175,1177-1179
-Disposable garments	247,1504,1507
-Gloves	219-220,226-227
-Gloves and fingercots	1514-1516,1519

KINEMATICA

-Grinding	567-568
-Mixing, Homogenisation	600-602

KNAUER

-Cell Culture	1344
---------------------	------

KNF

-Diaphragm pumps	1062,1066-1068,1070-1071
-Pumps	1053
-Rotary evaporators	659
-Vacuum controller	1080

Köttermann

-Furniture	280
------------------	-----

Korff

-General laboratory aids	189
--------------------------------	-----

A.KRÜSS Optronic

-Analytical instruments and systems	445
-Density determination	431
-Photometers	1136,1149
-Refractometers	1125,1129,1131-1133

L**La-Pha-Pack**

-Gas chromatography	1492
---------------------------	------

LABC-Labortechnik

-Desiccators	907
--------------------	-----

Labnet

-Genomics	1297,1308
-Heating	879-881,890
-Separating, centrifuging	665,668,670-672
-Shakers and mixers	503,518,523,528,530

LABORGERÄTESÜD

-Waste disposal	262
-----------------------	-----

Lamy Rheology

-Viscosity determination	434
--------------------------------	-----

Langkavel

-Transport	270
------------------	-----

LAUDA

-Heating	833,837
----------------	---------

Lenz

-Density determination	428
-Desiccators	1083
-Distillation, synthesis	618-634
-Liquid chromatography	1475
-Rotary evaporators	662-663
-Sample analysis	1267-1268
-Sampling	542
-Vessels	27,79,100

Liebherr

-Cooling	781,786-788
----------------	-------------

LLG Labware

-Analytical instruments and systems	443
-Balances	381-384
-Cell Culture	1343,1351
-Cleaning implements	230,1176,1178-1179,1183-1184
-Conductivity measurement	339
-Cooling	188,754,757-759,764
-Density determination	425
-Desiccators	1081,1084-1085
-Disinfection	1162

LLG Labware

-Dispensing	1002,1009
-Distillation, synthesis	650-651
-Ear protection	215
-Eye protection	51,196-197,202,205
-Filtration	699,710,716,729-731,741,743,745,749
-Furniture	272-274
-General Consumables	691,1415
-General laboratory aids	166,174-175,190,193
-Genomics	1292,1295-1296
-Gloves	217,220-222,230-231
-Grinding	565
-Heating	853,865,870,889
-Histology	1398
-Identification of hazards	253
-Magnetic stirrers / Hotplates	448,454,456,461-464,475
-Microbiology	874,1361,1364,1367-1368,1372,1387,1397
-Microscopy	1117,1119,1121-1122
-Optical instruments	1096
-Overhead stirrers	478
-pHmeasurement	296-297,299,309,315,324-325,328
-Photometers	1138,1157
-Pipettes	927,931,936,938-939,943,949-951,981-982,1000
-Piston pumps/Compressors	1061
-Protective clothing	245,247-252
-Pumps	1043
-Refractometers	1127
-Sample analysis	1238,1266
-Sampling	73,562
-Separating, centrifuging	664-665,690-691,694
-Shakers and mixers	497,514,522,527,533,535,537,539
-Syringes	1057,1460
-Thermometers	385-386,388,390,392
-Timing	414-415
-Tools	116,122,127-129,132,134-135,138
-Trace analysis	1223
-Transport	270
-Tubing	152
-Vacuum controller	1078
-Vessels	15,17,24,29,33,38,41-42,44,48-49,51,54,56,66,73,80
-Waste disposal	258,262

Lovibond®

-Conductivity measurement	332
-Cooling	787
-Heating	864
-Microbiology	864
-Multiparameter measurement	345-346
-Oxygen measurement	340
-pHmeasurement	306
-Photometers	1147
-Sample analysis	871,1235,1239-1244,1249-1250,1258,1263

Ludwig Schneider

-Density determination	426
-Thermometers	386-388,391,394,399

Lutz Pumpen

-Pumps	1041-1042
--------------	-----------

M**Maassen**

-Laboratory presses	599
---------------------------	-----

MACHEREY-NAGEL

-Balances	382
-Filtration	700,711-712,718,736-739
-Gas chromatography	1488,1490
-Liquid chromatography	1472-1473,1475-1476
-pHmeasurement	296-298
-Sample analysis	1236-1237

MACHEREY-NAGEL	
-Sample preparation.....	1463-1467
-Thinlayer chromatography.....	1495-1499
MANITOWOC®	
-Cooling.....	789
MAPA	
-Gloves.....	232,234-235,237-238,241
-Gloves and fingercoats.....	1512,1522
Marienfeld	
-Histology.....	1405
-Microbiology.....	1375
Melitta	
-General laboratory aids.....	192
Memmert	
-Heating.....	834-835,854-855,863,866-867,872-874,876,898-899
Mensch	
-Protective clothing.....	252
Menzel	
-Microscopy.....	1116-1118
Merck	
-Sample analysis.....	1236
Messner	
-Heating.....	852
Mettler-Toledo Online	
-Conductivity measurement.....	330-331,334-336,338
-Density determination.....	428,431
-Multiparameter measurement.....	353
-Oxygen measurement.....	340,344
-pHmeasurement.....	304-305,308,312-314,319-323,326-327
-Refractometers.....	1129
Micros Austria	
-Histology.....	1399-1400
Miele	
-Disinfection.....	1168,1171-1172
-Washers, disinfectors.....	1195-1196
Motic	
-Material testing.....	441-442
-Microscopy.....	442,1097-1100,1103-1105,1107
N	
Nabertherm	
-Heating.....	903-907
NanoEn Tek	
-Cell Culture.....	1341
-Microscopy.....	1115
Nasco	
-Sampling.....	560-561
Nitritex	
-Disposable garments.....	1505-1506,1508
-Gloves and fingercoats.....	1512,1514-1515,1517-1521
Nordiclab	
-Cooling.....	773,779-780
NORMAX	
-Sample analysis.....	1235
Normensand	
-Sieving.....	595
O	
OHAUS	
-Balances.....	355-357,361-362,364,370-373,377-378
-Heating.....	882-883,891
-Magnetic stirrers / Hotplates.....	470
-Shakers and mixers.....	498,503,505,509,512,519,525,529
ORSAtec	
-Histology.....	1404-1405

P

PCRmax	
-Genomics.....	1304
Peak Scientific	
-Gas chromatography.....	1484-1486
Peter Greven	
-Gloves and fingercots.....	1525
-Skin protection.....	244
PFAUDLER NORMAG	
-Distillation, synthesis.....	644
Pfennig Reinigungstechnik	
-Cleaning equipment and tools.....	1537-1542
-Wipes and swabs.....	1527,1530
Phoenix Instrument	
-Shakers and mixers.....	506,518
PolyScience	
-Heating.....	830
-Temperature regulators.....	796,798,812-813,821
Poulten & Graf	
-Dispensing.....	1011-1012
-Pipettes.....	935
-Syringes.....	1459
proQuarz	
-Liquid chromatography.....	1476
-Vessels.....	104,113

R

Ratiolab	
-Cooling.....	760
-General Consumables.....	1406,1416
-Genomics.....	1296
-Photometers.....	1158
-Pipettes.....	945,983
-Vessels.....	47
-Waste disposal.....	260
Raypa	
-Steam sterilisers Autoclaves.....	1200-1202
Reagecon	
-Analytical instruments and systems.....	443
-Cell Culture.....	1344
-Conductivity measurement.....	339
-Density determination.....	429
-pHmeasurement.....	325,327-328
-Photometers.....	1149
-Proteomics.....	1325
-Refractometers.....	1134
-Sample analysis.....	1235,1253,1265,1277
Rehau	
-Tubing.....	148
REPLIGEN	
-Proteomics.....	1329-1331
Retsch	
-Grinding.....	571-574,581,583-585,590
-Sieving.....	591-592,594-595,598
Rettberg	
-Distillation, synthesis.....	643
Ritter	
-Dispensing.....	1002-1003
-General Consumables.....	1416
-Genomics.....	1302
-Pipettes.....	999
-Steam sterilisers Autoclaves.....	1208
ROBU	
-Filtration.....	745-748
Rötzmeier	
-Safety containers.....	268-269

RSG

-Heating	145
-Tools	115,117-118,125
-Vessels	55,100,108

S**SAF Wärmetechnik**

-Heating	846-851
----------------	---------

Saint Gobain

-Pumps	1047
-Sample preparation	542
-Trace analysis	1221-1226,1228-1233
-Tubing	150-152
-Vessels	30

Sartorius Lab Instruments

-Balances	365-366,369-371,374-375,378-379
-Diaphragm pumps	1066
-Filtration	709,714-716,721-724,727-728,734-736,740-743
-Microbiology	1363,1390-1391,1397
-Pipettes	960-962,990-991
-Proteomics	1327-1328
-Water purification	1284

SAUTER

-Climate and environment measurement	421-422
-Material testing	437-439

S.C.A.T.

-Liquid chromatography	1479-1483
-Safety containers	265-268

Scherf

-Balances	381
-Vessels	24-26

SCHOTT

-Microscopy	1111-1113
-------------------	-----------

Schülke & Mayr

-Disinfection	1164-1166,1173
---------------------	----------------

schuett-biotec

-Cell Culture	1352
-Microbiology	1369,1376-1378,1381-1382,1386-1387,1394
-Tubing	153
-Vessels	28-29

Scientific Industries

-Heating	881
-Microbiology	1389
-Shakers and mixers	501,504,506,508

Scilabware

-Microbiology	1371
---------------------	------

Scotsman / HIBU

-Cooling	789
----------------	-----

Semperit

-Gloves	228
---------------	-----

SI Analytics

-Conductivity measurement	334,337
-Multiparameter measurement	347
-pHmeasurement	307,309,317-319,324,326,328
-Titration	1031-1036
-Viscosity determination	433,436

SICCO

-Desiccators	1086-1090
-Furniture	281

Sigma-Laborzentrifugen

-Separating, centrifuging	673-674
---------------------------------	---------

Simon Keller

-Microbiology	1381
---------------------	------

SNOL

-Heating	903,905
----------------	---------

Socorex	
-Dispensing	1005,1008,1013
-Pipettes	939,955-960,980,988-989
-Steam sterilisers Autoclaves	1210
-Syringes	1459
Söhngen	
-Firstaid	257-258
Sonation	
-Ultrasonic cleaners	1192
Sontara	
-Cleaning implements	1177
-Wipes and swabs	1528
Stakpure	
-Water purification	1280-1283
Starlight Opto-Electronics	
-Microscopy.....	1109-1110
Starna Scientific	
-Photometers.....	1150
Storopack Deutschland	
-Cooling.....	792
Stuart	
-Analytical instruments and systems	444,446
-Heating	841-843,884,894
-Liquid chromatography	1474
-Magnetic stirrers / Hotplates.....	450,460,466,474
-Microbiology.....	1393
-Sample analysis.....	1263
-Shakers and mixers.....	507,511,515,520,525,535-537
styro	
-Histology	1399

T

Taiwan Dry Tech	
-Desiccators	1086
Techne	
-Genomics	1302-1303
Testo	
-Climate and environment measurement	420,424
-Thermometers.....	389-390,395-397,401,404,407,410
TFA Dostmann	
-Climate and environment measurement	418-419
-Thermometers.....	390-391,401,408
-Timing.....	417
-Tools	132
THARMAC	
-Cell Culture.....	1349-1350
Thermo Scientific	
-Cell Culture.....	876,1332-1337,1339-1340,1342,1346-1348,1354-1356,1359
-Conductivity measurement.....	329-330,338
-Cooling	755-756,761-762,765-769,779,782-785,794-795
-Desiccators	1085
-Disinfection	1165
-Distillation, synthesis	640
-General Consumables	1415
-Heating	829,859-861,865,869,872,875-876,887-888
-Magnetic stirrers / Hotplates	456
-Microbiology.....	1365,1369,1372,1391
-Multiparameter measurement.....	345
-pHmeasurement.....	300-304,310,324
-Pipettes.....	937-938,963-971,991-995,1001
-Proteomics.....	1318-1320
-Sample analysis.....	1264
-Sampling	562
-Separating, centrifuging	687,693,696-698
-Shakers and mixers	510,513
-Trace analysis.....	1226-1227,1229

Thermo Scientific

- Vessels.....40,43,46,58,76-77,84,90-91,93
- Water purification1285-1288

TQC

- Sieving.....593

Trajan Scientific

- Gas chromatography1487-1494
- Liquid chromatography1473

Transport Control

- Thermometers.....389

U**Unigloves**

- Breathing protection206
- Disinfection1162
- Gloves217-219,223-224
- Protective clothing251

UNIVET

- Eye protection1511

Usbeck

- Furniture294
- General laboratory aids178-179,181-182,184-185,187
- Heating139,141-142,144
- Tools.....116,130
- Vessels32,108
- Water jet pumps1060

uvex

- Breathing protection207-208
- Disposable garments1505
- Ear protection214-215
- Eye protection199-204,1510-1511
- Gloves233-238,240
- Protective clothing245

V**VACUUBRAND**

- Cell Culture1353
- Diaphragm pumps1063-1065,1070-1071,1073
- Rotary vane pumps.....1074-1075
- Vacuum controller.....1078-1080

VDS optilab

- Liquid chromatography1473

Velp Scientifica

- Heating870
- Magnetic stirrers / Hotplates449-450,453,465,468,473
- Mixing, Homogenisation.....599
- Overhead stirrers482,485
- Sample analysis.....1257
- Shakers and mixers498

Vikan

- Cleaning implements.....1180-1182

Vilber Lourmat

- Genomics1310-1311,1313
- Thinlayer chromatography1500

VITLAB

- Dispensing1010
- Titration.....1025,1029
- Tools.....137-138
- Trace analysis1221-1227,1229-1230
- Vessels15,17-18,21,47,54-55,67,85,91-94,97,99,101,107
- Volumetric apparatus914-915,925-926

VmP Vertrieb

- General laboratory aids173

Voltronic

- General laboratory aids187
- Tools132

W

Wagner & Munz
 -Analytical instruments and systems.....446

WARING®
 -Grinding566

WATER-i.d.
 -Sample analysis.....1238

Welch Vacuum
 -Diaphragm pumps1065-1066
 -Piston pumps/Compressors1061
 -Rotary vane pumps1074

Werner Dorsch
 -Furniture278
 -Optical instruments1094
 -Tools126,129

Whatman
 -Balances.....382
 -Filtration701-706,711-713,717,719,721-726
 -General laboratory aids190
 -Microbiology1390
 -Microscopy.....442,1107
 -Proteomics1322
 -Sample analysis.....1266
 -Thinlayer chromatography1497-1498

Windaus-Labortechnik
 -Sample analysis.....1262
 -Sampling554-555

WLD-TEC
 -Microbiology.....1380,1382-1385

WTW®
 -Conductivity measurement.....332-333,337,339
 -Multiparameter measurement348-349,351-352
 -Oxygen measurement.....341-344
 -pHmeasurement305-306,311,315-317,322-324,326-328
 -Sample analysis1245-1249,1254-1257,1259,1264-1265

Württ. Allplastik
 -Waste disposal260

Z

Zirbus Technology
 -Laboratory Freeze drying1091-1092

Bestellnummernindex - Numerical index - Index numérique - Índice Numérico - Índice numerico - Indeks numerów katalogowych - Указатель по номерам

2.600 069	381	4.001 544	1442	4.003 647	1464	4.005 000	1476	4.006 223	707	4.007 819	283	4.008 299	1450	4.008 471	132
2.600 069	1183	4.001 547	1437	4.003 648	1464	4.005 001	1476	4.006 224	707	4.007 849	922	4.008 300	918	4.008 472	132
4.000 014	1023	4.001 547	1440	4.003 650	1464	4.005 042	1495	4.006 225	707	4.007 850	922	4.008 301	918	4.008 473	132
4.000 015	1023	4.001 548	1448	4.003 675	1465	4.005 043	1495	4.006 226	707	4.007 852	1417	4.008 302	918	4.008 474	132
4.000 030	940	4.001 549	1447	4.003 719	1466	4.005 046	1496	4.006 227	707	4.007 853	1417	4.008 303	923	4.008 475	132
4.000 031	940	4.001 550	1449	4.003 721	1466	4.005 047	1496	4.006 228	707	4.007 886	978	4.008 306	923	4.008 476	132
4.000 032	940	4.001 554	1435	4.003 723	1466	4.005 049	1497	4.006 229	707	4.007 894	1293	4.008 311	1021	4.008 477	132
4.000 033	940	4.001 555	1441	4.003 724	1466	4.005 050	1497	4.006 260	707	4.007 895	1293	4.008 312	1025	4.008 478	132
4.000 034	940	4.001 556	1435	4.003 726	1466	4.005 051	1497	4.006 261	707	4.007 896	1295	4.008 313	186	4.008 479	132
4.000 047	941	4.001 556	1440	4.003 728	1466	4.005 052	1495	4.006 262	707	4.007 897	1295	4.008 314	1024	4.008 480	132
4.000 051	941	4.001 557	1447	4.003 805	1464	4.005 060	1496	4.006 263	707	4.007 899	1295	4.008 315	1024	4.008 481	132
4.000 052	941	4.001 559	1441	4.003 806	1464	4.005 061	1496	4.006 264	707	4.007 900	1295	4.008 316	1024	4.008 482	132
4.000 053	941	4.001 563	1435	4.003 808	1464	4.005 062	1496	4.006 266	707	4.007 901	1295	4.008 317	1024	4.008 483	132
4.000 074	919	4.001 564	1441	4.003 809	1464	4.005 063	1496	4.006 267	707	4.007 902	1295	4.008 318	1024	4.008 484	132
4.000 108	1228	4.001 565	1440	4.003 811	1464	4.005 064	1496	4.006 268	707	4.007 918	1030	4.008 322	941	4.008 485	132
4.000 109	1228	4.003 009	1488	4.003 813	1464	4.005 065	1496	4.006 269	707	4.007 942	578	4.008 323	941	4.008 486	177
4.000 110	1228	4.003 013	1488	4.003 814	1464	4.005 066	1496	4.006 271	707	4.008 061	500	4.008 324	941	4.008 487	177
4.000 111	1228	4.003 017	1488	4.003 815	1464	4.005 067	1496	4.006 272	707	4.008 062	500	4.008 327	427	4.008 488	178
4.000 114	1226	4.003 019	1488	4.003 817	1464	4.005 068	1496	4.006 273	707	4.008 065	500	4.008 328	427	4.008 489	178
4.000 115	1226	4.003 021	1488	4.003 819	1464	4.005 069	1496	4.006 274	707	4.008 075	886	4.008 329	427	4.008 490	179
4.000 116	1226	4.003 174	1488	4.003 820	1464	4.005 070	1496	4.006 275	707	4.008 077	886	4.008 341	645	4.008 491	179
4.000 121	1226	4.003 175	1488	4.003 824	1467	4.005 078	1237	4.006 277	707	4.008 087	467	4.008 342	645	4.008 492	179
4.000 122	1228	4.003 176	1488	4.003 825	1467	4.005 079	1237	4.006 278	707	4.008 090	467	4.008 343	645	4.008 493	179
4.000 140	1228	4.003 401	738	4.003 826	1467	4.005 092	1237	4.006 279	707	4.008 093	467	4.008 344	645	4.008 494	179
4.000 141	1228	4.003 402	738	4.003 827	1467	4.005 099	1236	4.006 280	707	4.008 113	472	4.008 345	645	4.008 501	463
4.000 142	1228	4.003 405	736	4.003 828	1467	4.005 101	1236	4.006 395	708	4.008 136	657	4.008 360	386	4.008 501	477
4.000 234	1408	4.003 406	736	4.003 829	1467	4.005 444	1483	4.006 396	708	4.008 137	454	4.008 360	645	4.008 506	691
4.000 235	1408	4.003 407	736	4.003 838	1465	4.005 445	1483	4.006 441	714	4.008 142	464	4.008 361	646	4.008 506	1414
4.000 236	1408	4.003 409	737	4.004 368	1472	4.005 446	1483	4.006 442	714	4.008 194	1435	4.008 362	646	4.008 510	102
4.000 237	1297	4.003 410	737	4.004 369	1472	4.005 447	1483	4.006 443	714	4.008 194	1440	4.008 364	646	4.008 512	145
4.000 237	1317	4.003 411	738	4.004 370	1472	4.005 448	1483	4.006 444	714	4.008 196	1437	4.008 365	646	4.008 552	1333
4.000 238	1317	4.003 412	738	4.004 371	1472	4.005 456	1481	4.006 445	714	4.008 196	1439	4.008 366	646	4.008 574	1320
4.000 239	1317	4.003 413	738	4.004 375	1472	4.005 504	1483	4.006 446	714	4.008 196	1441	4.008 367	646	4.008 586	1318
4.000 240	1317	4.003 414	738	4.004 376	1472	4.005 556	1481	4.006 447	714	4.008 196	1440	4.008 369	646	4.008 599	1320
4.000 241	1317	4.003 415	738	4.004 377	1472	4.005 558	1481	4.006 448	714	4.008 197	1436	4.008 370	626	4.008 606	1318
4.000 242	1317	4.003 416	737	4.004 378	1472	4.005 583	1480	4.006 449	714	4.008 198	1435	4.008 371	626	4.008 613	1318
4.000 243	1317	4.003 417	737	4.004 521	1472	4.005 584	1480	4.006 450	714	4.008 200	1435	4.008 372	626	4.008 625	1333
4.000 256	1317	4.003 418	737	4.004 522	1472	4.005 585	1480	4.006 451	714	4.008 204	1450	4.008 373	662	4.008 637	46
4.000 257	1317	4.003 419	736	4.004 523	1472	4.005 593	267	4.006 452	714	4.008 205	1445	4.008 375	662	4.008 649	1318
4.000 258	1317	4.003 420	736	4.004 524	1472	4.005 602	267	4.006 453	714	4.008 206	1435	4.008 377	623	4.008 650	1318
4.000 259	1317	4.003 421	736	4.004 525	1472	4.005 612	1482	4.006 454	714	4.008 207	1436	4.008 378	623	4.008 660	1318
4.000 260	1317	4.003 422	736	4.004 526	1472	4.005 613	1482	4.006 455	714	4.008 209	1436	4.008 379	618	4.008 669	562
4.000 261	1317	4.003 423	739	4.004 527	1472	4.005 616	1482	4.006 456	714	4.008 210	1436	4.008 380	618	4.008 715	1339
4.000 262	1317	4.003 424	737	4.004 528	1472	4.005 671	267	4.006 457	714	4.008 211	1439	4.008 381	618	4.008 721	1340
4.000 275	1316	4.003 425	737	4.004 529	1472	4.005 682	267	4.006 458	714	4.008 212	1439	4.008 382	618	4.008 748	1319
4.000 276	1316	4.003 426	737	4.004 530	1472	4.005 683	267	4.006 459	714	4.008 214	1438	4.008 383	618	4.008 750	46
4.000 277	1316	4.003 427	738	4.004 531	1472	4.005 717	1482	4.006 461	714	4.008 215	1438	4.008 384	618	4.008 767	1339
4.000 279	1316	4.003 429	738	4.004 532	1472	4.005 791	1481	4.006 462	714	4.008 216	1438	4.008 385	618	4.008 768	1318
4.000 281	1316	4.003 430	738	4.004 532	1473	4.005 793	1481	4.006 463	714	4.008 218	1438	4.008 386	620	4.008 779	1340
4.000 282	1316	4.003 431	738	4.004 804	1497	4.005 794	268	4.006 464	714	4.008 221	1438	4.008 387	620	4.008 780	1339
4.000 329	1338	4.003 433	1463	4.004 822	1495	4.005 859	1482	4.006 465	714	4.008 224	1438	4.008 388	620	4.008 786	1340
4.000 330	1338	4.003 435	1463	4.004 824	1495	4.005 860	1482	4.006 466	714	4.008 225	1438	4.008 390	622	4.008 789	1319
4.000 331	1338	4.003 437	1463	4.004 825	1495	4.005 865	1482	4.006 467	714	4.008 226	1438	4.008 391	622	4.008 802	1318
4.000 332	1338	4.003 442	1465	4.004 826	1495	4.005 866	1482	4.006 468	714	4.008 227	1438	4.008 392	622	4.008 806	1340
4.000 333	1338	4.003 444	1465	4.004 827	1495	4.005 880	1483	4.006 469	714	4.008 228	1438	4.008 393	622	4.008 808	1319
4.000 334	1338	4.003 446	1465	4.004 835	1497	4.005 883	1483	4.006 473	714	4.008 229	1438	4.008 394	622	4.008 814	756
4.000 335	1338	4.003 448	1465	4.004 836	1497	4.005 890	1483	4.006 474	714	4.008 230	1438	4.008 395	622	4.008 816	1332
4.000 336	1338	4.003 450	1465	4.004 838	1497	4.005 891	1483	4.006 475	714	4.008 235	1439	4.008 396	622	4.008 817	1319
4.000 337	1338	4.003 451	1465	4.004 839	1497	4.005 945	1483	4.006 476	714	4.008 236	1439	4.008 397	144	4.008 819	1320
4.000 338	1338	4.003 452	1465	4.004 846	1495	4.005 950	1481	4.006 480	714	4.008 237	1439	4.008 398	1475	4.008 821	756
4.000 339	1338	4.003 454	1465	4.004 847	1495	4.005 954	267	4.006 481	714	4.008 238	1441	4.008 399	1475	4.008 824	46
4.000 343	1338	4.003 464	1463	4.004 848	1495	4.005 955	267	4.006 482	714	4.008 247	1437	4.008 400	1475	4.008 825	46
4.000 344	1338	4.003 477	1463	4.004 849	1495	4.005 976	1482	4.006 483	714	4.008 248	1445	4.008 401	1475	4.008 832	1319
4.000 345	1338	4.003 481	1463	4.004 850	1495	4.006 047	708	4.006 484	714	4.008 249	1437	4.008 402	1475	4.008 833	1319
4.000 346	1338	4.003 482	1463	4.004 853	1495	4.006 052	1498	4.006 485	714	4.008 250	1437	4.008 403	1475	4.008 834	1319
4.000 347	1338	4.003 486	1465	4.004 854	1495	4.006 062	708	4.006 614	720	4.008 251	1440	4.008 405	637	4.008 835	1319
4.000 363															

Bestellnummernindex - Numerical index - Index numérique - Índice Numérico - Índice numerico - Indeks numerów katalogowych - Указатель по номерам

4.009 192	869	4.012 235	1253	4.654 558	757	4.658 058	868	4.658 378	767	4.658 699	175	4.658 846	963	4.659 052	1502
4.009 193	869	4.012 236	1253	4.655 160	1205	4.658 059	857	4.658 379	767	4.658 700	175	4.658 848	963	4.659 053	1502
4.009 206	859	4.012 324	1325	4.655 162	1205	4.658 060	857	4.658 380	767	4.658 704	962	4.658 849	963	4.659 054	1502
4.009 207	859	4.012 501	1325	4.655 164	1205	4.658 061	857	4.658 398	766	4.658 705	962	4.658 850	963	4.659 055	1502
4.009 208	859	4.012 513	1325	4.655 166	1205	4.658 062	805	4.658 399	766	4.658 706	962	4.658 854	284	4.659 056	1502
4.009 209	859	4.012 517	1325	4.655 171	1531	4.658 066	826	4.658 400	766	4.658 707	962	4.658 855	1304	4.659 057	1502
4.009 210	859	4.012 525	1325	4.655 191	497	4.658 070	826	4.658 401	766	4.658 708	962	4.658 856	1304	4.659 058	1502
4.009 211	859	4.012 527	1325	4.655 243	1297	4.658 071	1070	4.658 402	766	4.658 709	962	4.658 857	1304	4.659 059	1502
4.009 212	860	4.012 529	1325	4.655 267	1296	4.658 073	24	4.658 403	766	4.658 710	962	4.658 858	1304	4.659 060	1503
4.009 213	860	4.012 531	1325	4.655 268	1296	4.658 074	24	4.658 404	766	4.658 711	962	4.658 859	1304	4.659 061	1503
4.009 214	860	4.012 533	1325	4.655 269	1296	4.658 075	24	4.658 405	766	4.658 712	962	4.658 860	1304	4.659 062	1503
4.009 215	860	4.012 977	1045	4.655 270	1296	4.658 076	24	4.658 406	766	4.658 713	962	4.658 861	1304	4.659 063	1503
4.009 216	860	4.012 988	601	4.655 271	1296	4.658 077	24	4.658 407	766	4.658 714	962	4.658 862	1304	4.659 064	1503
4.009 217	860	4.012 995	602	4.655 272	1296	4.658 078	24	4.658 412	766	4.658 715	962	4.658 863	1304	4.659 065	1503
4.009 218	860	4.012 999	602	4.655 296	1418	4.658 079	24	4.658 413	766	4.658 716	962	4.658 864	1304	4.659 066	1503
4.009 219	860	4.013 004	602	4.655 297	1418	4.658 080	24	4.658 414	766	4.658 717	962	4.658 911	280	4.659 067	1503
4.009 220	860	4.013 016	602	4.655 298	1418	4.658 081	24	4.658 415	766	4.658 718	962	4.658 912	280	4.659 068	1507
4.009 221	860	4.013 055	602	4.655 299	1418	4.658 082	24	4.658 416	766	4.658 719	962	4.658 913	280	4.659 069	1504
4.009 222	860	4.013 056	602	4.655 300	1418	4.658 083	24	4.658 417	766	4.658 720	962	4.658 914	280	4.659 070	1526
4.009 223	860	4.013 057	602	4.655 301	1418	4.658 084	24	4.658 418	766	4.658 721	962	4.658 915	280	4.659 071	1529
4.009 224	861	4.013 060	602	4.655 302	1418	4.658 085	24	4.658 419	766	4.658 722	962	4.658 916	280	4.659 072	1528
4.009 225	861	4.013 061	602	4.655 303	1418	4.658 086	24	4.658 420	766	4.658 723	961	4.658 917	280	4.659 073	1527
4.009 226	861	4.013 062	602	4.655 304	1418	4.658 088	24	4.658 425	766	4.658 724	961	4.658 918	280	4.659 074	1531
4.009 227	861	4.013 064	602	4.655 305	1418	4.658 089	24	4.658 426	766	4.658 725	961	4.658 919	280	4.659 075	1531
4.009 228	861	4.013 065	602	4.655 310	1418	4.658 090	24	4.658 443	852	4.658 726	961	4.658 920	280	4.659 076	1531
4.009 229	861	4.013 069	602	4.655 311	1418	4.658 091	24	4.658 450	1231	4.658 727	961	4.658 966	280	4.659 077	1531
4.009 230	861	4.013 070	602	4.655 312	1418	4.658 092	24	4.658 455	1308	4.658 741	1340	4.658 967	280	4.659 078	1531
4.009 231	861	4.013 072	602	4.655 313	1418	4.658 093	24	4.658 462	367	4.658 742	1340	4.658 968	280	4.659 079	1531
4.009 232	861	4.652 481	1390	4.655 314	1418	4.658 094	24	4.658 575	387	4.658 743	1340	4.658 969	280	4.659 081	1530
4.009 233	861	4.652 483	962	4.655 334	1418	4.658 095	25	4.658 576	387	4.658 745	1340	4.658 970	280	4.659 082	1530
4.009 234	861	4.652 643	1519	4.655 335	1418	4.658 096	25	4.658 577	387	4.658 747	1340	4.658 971	280	4.659 083	1530
4.009 235	861	4.652 644	1507	4.655 337	1418	4.658 097	25	4.658 578	387	4.658 749	1340	4.658 972	280	4.659 084	1530
4.009 236	861	4.652 645	1515	4.655 338	1418	4.658 098	25	4.658 579	387	4.658 752	1340	4.658 973	280	4.659 085	1530
4.009 237	861	4.652 699	380	4.656 042	685	4.658 099	25	4.658 580	387	4.658 753	1340	4.658 974	280	4.659 086	1530
4.009 238	861	4.652 716	575	4.656 051	26	4.658 100	25	4.658 581	387	4.658 754	1340	4.658 975	280	4.659 087	1543
4.009 239	861	4.652 757	1243	4.656 091	604	4.658 101	25	4.658 582	387	4.658 776	1400	4.658 976	280	4.659 088	1543
4.009 239	869	4.652 758	1353	4.656 096	609	4.658 102	25	4.658 583	387	4.658 777	1340	4.658 977	280	4.659 089	1543
4.009 240	861	4.652 768	65	4.656 097	609	4.658 103	25	4.658 584	387	4.658 778	1340	4.658 978	280	4.659 090	1543
4.009 240	869	4.652 769	65	4.656 098	609	4.658 104	25	4.658 585	387	4.658 779	1340	4.658 979	280	4.659 091	1543
4.009 241	861	4.652 770	65	4.656 099	609	4.658 105	25	4.658 586	387	4.658 780	1340	4.658 980	280	4.659 092	1543
4.009 241	869	4.652 771	65	4.656 100	609	4.658 106	25	4.658 605	813	4.658 781	1340	4.658 982	285	4.659 093	1543
4.009 246	861	4.652 772	65	4.657 434	35	4.658 107	25	4.658 606	812	4.658 782	1340	4.658 983	285	4.659 094	1543
4.009 246	869	4.652 773	65	4.657 440	1047	4.658 108	25	4.658 611	813	4.658 783	1305	4.658 984	285	4.659 095	1543
4.009 247	861	4.652 776	64	4.657 466	1102	4.658 109	25	4.658 612	813	4.658 784	1357	4.658 985	285	4.659 096	1543
4.009 247	869	4.652 777	64	4.657 658	1102	4.658 110	25	4.658 613	813	4.658 785	1358	4.658 986	285	4.659 097	1543
4.009 248	861	4.652 779	64	4.657 659	1102	4.658 111	25	4.658 614	813	4.658 786	1357	4.658 987	285	4.659 098	1543
4.009 248	869	4.652 793	1374	4.657 660	1102	4.658 112	25	4.658 615	812	4.658 787	966	4.658 988	1305	4.659 099	1544
4.009 249	861	4.652 794	1374	4.657 661	1102	4.658 113	26	4.658 616	812	4.658 788	966	4.658 989	285	4.659 100	1544
4.009 250	861	4.653 450	379	4.657 752	1132	4.658 114	26	4.658 617	813	4.658 789	966	4.658 990	285	4.659 101	1544
4.009 251	861	4.653 626	758	4.657 806	1104	4.658 115	26	4.658 618	813	4.658 790	966	4.658 991	285	4.659 102	1533
4.009 327	887	4.653 682	757	4.657 985	808	4.658 116	26	4.658 619	813	4.658 791	966	4.658 992	285	4.659 103	1533
4.009 330	887	4.653 801	1416	4.657 986	808	4.658 117	26	4.658 620	812	4.658 792	966	4.658 996	285	4.659 104	1533
4.009 332	887	4.653 858	265	4.657 987	808	4.658 118	26	4.658 621	813	4.658 793	966	4.658 997	285	4.659 105	1534
4.009 333	887	4.653 906	247	4.657 988	808	4.658 119	26	4.658 622	813	4.658 794	966	4.658 998	1305	4.659 106	1535
4.009 334	887	4.653 906	1506	4.657 989	808	4.658 120	26	4.658 623	812	4.658 795	966	4.658 999	1357	4.659 107	1535
4.009 335	887	4.653 907	247	4.657 990	808	4.658 121	26	4.658 624	813	4.658 796	966	4.659 000	1357	4.659 108	1535
4.009 336	887	4.653 907	1506	4.657 991	808	4.658 122	26	4.658 625	813	4.658 797	966	4.659 001	1357	4.659 109	1535
4.009 337	887	4.653 908	247	4.657 992	808	4.658 123	26	4.658 635	798	4.658 798	966	4.659 002	1357	4.659 110	1535
4.009 338	887	4.653 908	1506	4.657 993	808	4.658 124	26	4.658 639	796	4.658 799	966	4.659 003	1357	4.659 111	1535
4.009 339	887	4.653 909	247	4.657 994	808	4.658 125	26	4.658 640	796	4.658 800	966	4.659 004	1359	4.659 112	1535
4.009 340	887	4.653 909	1506	4.657 995	808	4.658 126	26	4.658 641	796	4.658 801	966	4.659 005	1359	4.659 113	1535
4.009 506	888	4.653 910	247	4.657 996	808	4.658 127	26	4.658 642	796	4.658 802	966	4.659 006	1358	4.659 114	1535
4.010 033	1360	4.653 910	1506	4.657 997	809	4.658 128	26	4.658 643	796	4.658 803	966	4.659 007	1357	4.659 115	1535
4.010 047	1360	4.653 935	607	4.657 998	809	4.658 129	26	4.658 644	796	4.658 804	966	4.659 008	1357	4.659 117	1535
4.010 048	1360	4.653 943	576	4.657 999	809	4.658 130	26	4.658 645	796	4.658 805	966	4.659 009	1357	4.659 118	1535
4.010 229	887	4.653 944	575	4.658 000	809	4.658 131	26	4.658 646	796	4.658 806	966	4.659 010	1358	4.659 119	1535
4.010 230	887	4.653 952	937	4.658 001	809	4.658 132	26	4.658 647	796	4.658 807	966	4.659 011	1358	4.659 120	1535
4.010 231	887	4													

Bestellnummernindex - Numerical index - Index numérique - Índice Numérico - Indice numerico - Indeks numerów katalogowych - Указатель по номерам

4.659 480	882	4.660 912	1350	4.661 443	1517	4.661 837	261	4.662 358	996	4.662 843	156	4.663 098	1503	4.663 352	863
4.659 481	519	4.660 915	1350	4.661 451	1521	4.661 838	261	4.662 359	996	4.662 844	156	4.663 099	1503	4.663 353	863
4.659 482	529	4.660 916	1350	4.661 452	1521	4.661 839	261	4.662 361	997	4.662 845	154	4.663 100	1503	4.663 354	863
4.659 483	529	4.660 917	1350	4.661 453	1521	4.661 842	972	4.662 363	997	4.662 846	155	4.663 101	1503	4.663 355	863
4.659 491	891	4.660 918	1350	4.661 454	1521	4.661 843	972	4.662 364	997	4.662 847	154	4.663 102	1503	4.663 356	863
4.659 494	891	4.660 919	1350	4.661 455	1521	4.661 844	972	4.662 365	997	4.662 848	155	4.663 103	1503	4.663 357	863
4.659 495	891	4.660 920	1350	4.661 456	1521	4.661 845	972	4.662 366	997	4.662 849	155	4.663 104	1503	4.663 358	863
4.659 496	891	4.660 923	1350	4.661 457	1505	4.661 846	972	4.662 367	997	4.662 850	155	4.663 105	1503	4.663 359	538
4.659 498	498	4.660 924	1350	4.661 458	1505	4.661 847	972	4.662 368	997	4.662 851	154	4.663 106	1503	4.663 360	539
4.659 499	498	4.661 002	1443	4.661 459	1505	4.661 848	972	4.662 369	997	4.662 852	155	4.663 193	995	4.663 363	1473
4.659 500	498	4.661 005	223	4.661 460	1505	4.661 849	972	4.662 370	997	4.662 853	155	4.663 195	898	4.663 380	526
4.659 501	498	4.661 006	223	4.661 461	1505	4.661 850	972	4.662 373	997	4.662 854	155	4.663 220	806	4.663 401	166
4.659 506	503	4.661 009	223	4.661 462	1505	4.661 851	972	4.662 380	997	4.662 855	154	4.663 221	811	4.663 402	166
4.659 507	503	4.661 010	223	4.661 463	1505	4.661 852	972	4.662 385	974	4.662 856	155	4.663 222	811	4.663 403	166
4.659 810	883	4.661 011	223	4.661 464	1505	4.661 853	972	4.662 386	974	4.662 857	155	4.663 223	811	4.663 404	166
4.659 811	883	4.661 012	223	4.661 465	1505	4.661 854	975	4.662 387	974	4.662 858	154	4.663 224	811	4.663 405	166
4.659 812	883	4.661 013	223	4.661 466	1505	4.661 855	975	4.662 388	974	4.662 859	155	4.663 225	820	4.663 406	166
4.659 813	883	4.661 014	223	4.661 467	1505	4.661 856	975	4.662 389	974	4.662 860	154	4.663 226	820	4.663 407	166
4.659 814	883	4.661 030	223	4.661 468	1505	4.661 857	975	4.662 390	974	4.662 861	155	4.663 227	820	4.663 408	166
4.659 815	883	4.661 031	223	4.661 469	1505	4.661 858	975	4.662 391	974	4.662 862	155	4.663 228	820	4.663 409	166
4.659 816	883	4.661 032	223	4.661 470	1505	4.661 859	975	4.662 392	974	4.662 863	154	4.663 229	820	4.663 410	166
4.659 817	883	4.661 033	223	4.661 471	1506	4.661 928	1486	4.662 393	973	4.662 864	155	4.663 230	820	4.663 411	166
4.659 818	883	4.661 034	223	4.661 472	1506	4.661 929	1486	4.662 394	973	4.662 865	155	4.663 231	820	4.663 412	166
4.659 819	883	4.661 058	224	4.661 473	1506	4.661 930	1486	4.662 395	973	4.662 866	154	4.663 232	820	4.663 413	166
4.659 820	883	4.661 100	465	4.661 474	1506	4.661 931	1486	4.662 396	973	4.662 867	155	4.663 233	806	4.663 414	166
4.659 835	891	4.661 160	942	4.661 475	1506	4.661 932	1486	4.662 397	973	4.662 868	155	4.663 234	811	4.663 415	166
4.659 836	891	4.661 162	682	4.661 477	1508	4.661 933	1486	4.662 398	973	4.662 869	155	4.663 235	811	4.663 416	166
4.659 837	891	4.661 164	682	4.661 478	1505	4.661 935	1486	4.662 399	973	4.662 870	154	4.663 236	811	4.663 417	166
4.659 838	891	4.661 166	682	4.661 479	1505	4.661 941	973	4.662 400	973	4.662 871	155	4.663 237	811	4.663 418	166
4.659 839	891	4.661 168	682	4.661 480	1505	4.661 946	1106	4.662 401	973	4.662 872	155	4.663 238	820	4.663 419	166
4.659 840	891	4.661 175	1218	4.661 481	1505	4.661 947	1106	4.662 402	973	4.662 873	154	4.663 239	820	4.663 420	166
4.659 841	891	4.661 188	1055	4.661 482	1505	4.661 948	1106	4.662 403	973	4.662 874	155	4.663 240	820	4.663 421	166
4.659 842	891	4.661 250	257	4.661 483	1505	4.661 949	1106	4.662 404	973	4.662 875	154	4.663 241	820	4.663 422	166
4.659 843	891	4.661 308	1309	4.661 484	1505	4.661 950	1106	4.662 405	973	4.662 876	155	4.663 242	820	4.663 423	166
4.659 846	891	4.661 309	1309	4.661 485	1505	4.661 951	1106	4.662 406	973	4.662 877	154	4.663 243	820	4.663 424	166
4.659 847	891	4.661 311	1321	4.661 486	1505	4.661 952	1106	4.662 407	973	4.662 878	154	4.663 244	820	4.663 598	1510
4.659 849	891	4.661 312	1324	4.661 487	1505	4.661 996	656	4.662 408	973	4.662 879	155	4.663 245	820	4.663 608	1507
4.659 851	891	4.661 323	900	4.661 488	1505	4.662 011	493	4.662 409	977	4.662 880	155	4.663 246	806	4.663 609	1507
4.659 852	891	4.661 324	900	4.661 489	1505	4.662 063	899	4.662 410	977	4.662 881	155	4.663 247	811	4.663 612	1504
4.659 856	891	4.661 325	900	4.661 490	1505	4.662 064	899	4.662 411	977	4.662 882	155	4.663 248	811	4.663 613	1504
4.659 875	891	4.661 326	900	4.661 491	1505	4.662 065	899	4.662 412	977	4.662 883	155	4.663 249	811	4.663 614	1504
4.659 876	891	4.661 331	1369	4.661 493	1508	4.662 066	899	4.662 413	977	4.662 884	155	4.663 250	811	4.663 618	1528
4.659 877	891	4.661 347	250	4.661 494	1508	4.662 112	229	4.662 414	977	4.662 885	155	4.663 251	820	4.663 619	1528
4.659 878	891	4.661 348	250	4.661 495	1508	4.662 113	229	4.662 510	1523	4.662 886	154	4.663 252	820	4.663 620	1529
4.659 879	891	4.661 349	250	4.661 496	1508	4.662 114	229	4.662 511	1523	4.662 887	155	4.663 253	820	4.663 621	1529
4.660 518	905	4.661 350	250	4.661 671	445	4.662 115	229	4.662 512	1523	4.662 888	155	4.663 254	820	4.663 622	1529
4.660 583	668	4.661 351	250	4.661 672	1546	4.662 116	229	4.662 513	1523	4.662 889	154	4.663 255	820	4.663 623	1529
4.660 584	668	4.661 352	250	4.661 673	1546	4.662 117	229	4.662 514	1523	4.662 890	154	4.663 256	820	4.663 624	1529
4.660 585	668	4.661 353	250	4.661 674	1546	4.662 136	1399	4.662 515	1523	4.662 891	153	4.663 257	820	4.663 625	1529
4.660 586	668	4.661 354	250	4.661 675	1546	4.662 137	1399	4.662 516	1524	4.662 892	154	4.663 258	820	4.663 626	1529
4.660 587	681	4.661 368	1521	4.661 688	1546	4.662 140	288	4.662 543	1523	4.662 893	153	4.663 259	820	4.663 627	1526
4.660 588	681	4.661 369	1521	4.661 689	1546	4.662 141	288	4.662 544	1523	4.662 894	153	4.663 261	858	4.663 628	1526
4.660 589	682	4.661 370	1521	4.661 690	1546	4.662 142	288	4.662 550	1523	4.662 895	153	4.663 262	858	4.663 629	1526
4.660 590	682	4.661 371	1521	4.661 691	1546	4.662 143	288	4.662 551	1523	4.662 896	154	4.663 289	92	4.663 630	1526
4.660 591	682	4.661 372	1521	4.661 692	1546	4.662 144	288	4.662 552	1523	4.662 897	153	4.663 290	92	4.663 631	1526
4.660 592	682	4.661 373	1512	4.661 693	1546	4.662 145	288	4.662 553	1523	4.662 898	154	4.663 291	92	4.663 632	1526
4.660 593	682	4.661 374	1512	4.661 694	1546	4.662 146	288	4.662 554	1523	4.662 899	153	4.663 292	92	4.663 633	1526
4.660 594	682	4.661 375	1512	4.661 695	1546	4.662 147	288	4.662 555	1523	4.662 900	154	4.663 293	1439	4.663 634	1526
4.660 595	682	4.661 376	1512	4.661 720	1548	4.662 164	1104	4.662 556	1523	4.662 901	153	4.663 294	1177	4.663 635	1526
4.660 596	682	4.661 377	1512	4.661 721	1548	4.662 221	1079	4.662 557	1523	4.662 902	153	4.663 295	1177	4.663 636	1526
4.660 606	685	4.661 378	1517	4.661 722	1548	4.662 230	553	4.662 558	1523	4.662 903	154	4.663 307	1003	4.663 637	1526
4.660 610	685	4.661 379	1517	4.661 723	1548	4.662 231	553	4.662 559	1523	4.662 904	153	4.663 308	1003	4.663 638	1527
4.660 611	685	4.661 380	1517	4.661 724	1548	4.662 232	553	4.662 560	1523	4.662 905	154	4.663 309	1003	4.663 643	1528
4.660 615	685	4.661 381	1517	4.661 725	1548	4.662 233	553	4.662 561	1523	4.662 906	153	4.663 310	1003	4.663 644	1527
4.660 617	685	4.661 382	1517	4.661 726	1548	4.662 234	974	4.662 562	1523	4.662 907	154	4.663 311	1003	4.663 645	1527
4.660 620	685	4.661 383	1518	4.661 727	1548	4.662 244	616	4.662 563	1523	4.662 908	153	4.663 312	1003	4.663 650	1526
4.660 622	683	4.661 384	1518	4.661 728	1549	4.662 294	1070	4.662 564	1523	4.662 909	153				

Bestellnummernindex - Numerical index - Index numérique - Índice Numérico - Índice numerico - Indeks numerów katalogowych - Указатель по номерам

4.663 713	1542	4.664 238	669	4.665 062	562	4.665 544	1477	4.665 953	1461	4.666 448	1000	4.667 926	782	4.668 149	729
4.663 714	1542	4.664 254	868	4.665 063	562	4.665 545	1477	4.665 978	1460	4.666 449	1000	4.667 927	782	4.668 149	1469
4.663 715	1542	4.664 278	91	4.665 064	562	4.665 546	1477	4.665 979	1460	4.666 450	1000	4.667 956	1289	4.668 150	729
4.663 716	1542	4.664 281	91	4.665 065	562	4.665 590	438	4.665 981	1461	4.666 451	1000	4.667 959	1289	4.668 150	1469
4.663 717	1542	4.664 282	91	4.665 066	562	4.665 591	438	4.665 985	1460	4.666 452	1000	4.667 960	789	4.668 153	704
4.663 718	1542	4.664 283	91	4.665 067	562	4.665 610	608	4.665 986	1460	4.666 453	1121	4.667 961	789	4.668 154	704
4.663 719	1542	4.664 317	435	4.665 068	562	4.665 611	501	4.665 988	1461	4.666 454	1121	4.667 962	789	4.668 155	704
4.663 720	1542	4.664 342	524	4.665 069	562	4.665 612	450	4.665 989	1294	4.666 455	1121	4.667 963	789	4.668 156	704
4.663 721	1543	4.664 343	524	4.665 070	562	4.665 663	480	4.665 990	1461	4.666 456	1121	4.667 970	1256	4.668 157	704
4.663 722	1543	4.664 344	526	4.665 071	562	4.665 708	675	4.665 991	1461	4.666 457	1121	4.667 980	1000	4.668 158	704
4.663 723	1543	4.664 345	526	4.665 072	963	4.665 733	228	4.666 015	129	4.666 458	1121	4.667 985	1527	4.668 159	704
4.663 724	1543	4.664 346	526	4.665 073	963	4.665 744	13	4.666 032	1196	4.666 496	616	4.667 987	1538	4.668 160	704
4.663 725	1543	4.664 347	863	4.665 074	963	4.665 745	13	4.666 032	1196	4.666 529	1104	4.667 988	1537	4.668 161	704
4.663 726	1543	4.664 397	857	4.665 075	963	4.665 746	13	4.666 033	1196	4.666 530	1104	4.667 989	1537	4.668 162	704
4.663 727	1543	4.664 420	100	4.665 076	963	4.665 747	13	4.666 034	1196	4.666 536	498	4.667 990	1538	4.668 163	704
4.663 728	1543	4.664 457	762	4.665 087	608	4.665 748	13	4.666 034	1196	4.666 537	498	4.667 991	1538	4.668 184	1324
4.663 729	1543	4.664 484	1522	4.665 172	1396	4.665 749	13	4.666 052	564	4.666 540	391	4.667 992	1537	4.668 229	615
4.663 730	1543	4.664 485	1522	4.665 196	856	4.665 750	13	4.666 071	1113	4.666 541	391	4.667 993	1537	4.668 242	357
4.663 731	1543	4.664 486	1522	4.665 208	479	4.665 751	13	4.666 072	1113	4.666 542	391	4.667 994	1530	4.668 243	357
4.663 732	1543	4.664 493	1053	4.665 284	901	4.665 752	13	4.666 076	1113	4.666 543	391	4.667 995	1530	4.668 244	357
4.663 733	1543	4.664 500	1522	4.665 286	901	4.665 753	13	4.666 077	680	4.666 553	485	4.667 997	1527	4.668 245	357
4.663 736	1543	4.664 501	1522	4.665 322	60	4.665 754	13	4.666 083	680	4.666 554	485	4.667 998	1530	4.668 246	357
4.663 737	1543	4.664 502	1522	4.665 324	1259	4.665 755	14	4.666 085	661	4.666 555	485	4.667 999	1530	4.668 247	357
4.663 738	1543	4.664 503	1522	4.665 325	1259	4.665 756	14	4.666 086	661	4.666 556	482	4.668 000	1542	4.668 248	357
4.663 739	1544	4.664 504	1522	4.665 326	1259	4.665 757	14	4.666 090	661	4.666 683	449	4.668 001	1541	4.668 249	357
4.663 740	1544	4.664 505	1522	4.665 327	1259	4.665 758	14	4.666 091	661	4.666 684	450	4.668 003	1542	4.668 250	357
4.663 741	1544	4.664 506	1522	4.665 328	1259	4.665 759	14	4.666 095	661	4.666 685	453	4.668 004	1541	4.668 251	357
4.663 742	1544	4.664 507	1522	4.665 329	60	4.665 760	14	4.666 096	661	4.666 710	599	4.668 005	1541	4.668 252	357
4.663 743	1544	4.664 508	1522	4.665 330	60	4.665 761	14	4.666 100	661	4.666 714	498	4.668 006	1540	4.668 253	357
4.663 744	1544	4.664 509	1522	4.665 331	60	4.665 762	14	4.666 101	661	4.666 720	468	4.668 007	1539	4.668 254	357
4.663 745	1550	4.664 510	1522	4.665 332	60	4.665 763	130	4.666 107	661	4.666 728	599	4.668 008	1539	4.668 255	357
4.663 746	1550	4.664 539	122	4.665 333	60	4.665 768	1483	4.666 108	661	4.666 733	468	4.668 009	1540	4.668 256	357
4.663 747	1550	4.664 540	122	4.665 336	1039	4.665 771	968	4.666 117	661	4.666 790	1257	4.668 010	1540	4.668 259	357
4.663 748	1550	4.664 541	122	4.665 337	1039	4.665 773	968	4.666 118	661	4.666 791	1257	4.668 011	1539	4.668 264	372
4.663 749	1550	4.664 563	772	4.665 345	139	4.665 774	968	4.666 151	1177	4.666 793	870	4.668 012	1539	4.668 265	372
4.663 750	1550	4.664 575	189	4.665 353	1073	4.665 775	968	4.666 171	1180	4.666 794	870	4.668 013	1539	4.668 266	372
4.663 751	1550	4.664 579	532	4.665 355	1400	4.665 797	616	4.666 172	1180	4.666 795	870	4.668 014	1539	4.668 267	372
4.663 752	1550	4.664 579	897	4.665 366	209	4.665 805	251	4.666 173	1180	4.666 796	870	4.668 033	1109	4.668 268	372
4.663 753	1550	4.664 580	198	4.665 367	209	4.665 818	1297	4.666 174	1180	4.666 797	870	4.668 034	1109	4.668 269	372
4.663 754	1550	4.664 581	198	4.665 368	209	4.665 819	1297	4.666 175	1180	4.666 810	1257	4.668 035	1109	4.668 270	372
4.663 756	1550	4.664 582	198	4.665 369	209	4.665 820	936	4.666 176	1180	4.666 811	1257	4.668 036	1109	4.668 271	372
4.663 777	1548	4.664 583	198	4.665 370	209	4.665 821	936	4.666 177	1180	4.666 812	1257	4.668 045	1109	4.668 272	372
4.663 778	1548	4.664 584	198	4.665 371	209	4.665 841	1416	4.666 178	1180	4.666 813	1257	4.668 046	1109	4.668 273	372
4.663 779	1548	4.664 585	198	4.665 372	209	4.665 842	1416	4.666 179	1180	4.667 502	506	4.668 057	1109	4.668 274	372
4.663 780	1548	4.664 586	198	4.665 373	209	4.665 843	680	4.666 180	1180	4.667 503	506	4.668 058	1109	4.668 275	372
4.663 781	1548	4.664 587	198	4.665 374	209	4.665 845	678	4.666 181	1181	4.667 504	506	4.668 059	1109	4.668 276	372
4.663 782	1533	4.664 590	657	4.665 375	209	4.665 848	795	4.666 182	1181	4.667 505	173	4.668 060	1109	4.668 277	372
4.663 783	1533	4.664 591	658	4.665 376	209	4.665 848	1300	4.666 183	1181	4.667 506	173	4.668 061	1109	4.668 278	372
4.663 784	1533	4.664 592	658	4.665 383	1520	4.665 849	795	4.666 184	1181	4.667 507	173	4.668 062	1109	4.668 279	361
4.663 785	1533	4.664 593	658	4.665 384	1520	4.665 849	1300	4.666 185	1181	4.667 508	173	4.668 063	1109	4.668 280	361
4.663 787	1533	4.664 594	658	4.665 386	1520	4.665 850	795	4.666 186	1181	4.667 509	173	4.668 064	1109	4.668 281	361
4.663 788	1533	4.664 595	658	4.665 389	1518	4.665 850	1300	4.666 187	1181	4.667 510	173	4.668 065	1109	4.668 282	361
4.663 789	1534	4.664 596	657	4.665 390	1518	4.665 851	795	4.666 188	1181	4.667 511	173	4.668 066	1109	4.668 283	361
4.663 790	1534	4.664 597	658	4.665 391	1518	4.665 851	1300	4.666 189	1181	4.667 512	173	4.668 067	1109	4.668 284	361
4.663 791	1534	4.664 598	201	4.665 392	1518	4.665 852	795	4.666 190	1181	4.667 513	173	4.668 073	1110	4.668 285	361
4.663 792	1534	4.664 600	203	4.665 393	1518	4.665 852	1300	4.666 231	1181	4.667 514	172	4.668 074	1110	4.668 286	361
4.663 793	1534	4.664 603	325	4.665 394	1518	4.665 853	795	4.666 232	1181	4.667 524	649	4.668 075	1110	4.668 287	361
4.663 794	1534	4.664 620	208	4.665 395	1518	4.665 853	1300	4.666 233	1181	4.667 525	649	4.668 076	1110	4.668 288	361
4.663 795	1534	4.664 621	208	4.665 400	278	4.665 854	795	4.666 234	1181	4.667 526	649	4.668 077	1110	4.668 289	361
4.663 796	1534	4.664 622	208	4.665 401	278	4.665 854	1300	4.666 235	1181	4.667 527	649	4.668 078	1110	4.668 290	361
4.663 797	1534	4.664 626	286	4.665 402	278	4.665 855	795	4.666 236	1181	4.667 528	649	4.668 079	1110	4.668 291	361
4.663 798	1534	4.664 627	438	4.665 403	278	4.665 855	1300	4.666 237	1181	4.667 529	649	4.668 080	1110	4.668 292	361
4.663 799	1534	4.664 642	822	4.665 404	278	4.665 856	795	4.666 238	1181	4.667 530	1196	4.668 085	1110	4.668 293	361
4.663 847	1535	4.664 658	262	4.665 406	278	4.665 856	1300	4.666 239	1181	4.667 530	1196	4.668 086	1110	4.668 295	881
4.663 848	1536	4.664 659	262	4.665 407	244	4.665 857	795	4.666 240	1181	4.667 531	23	4.668 087	1110	4.668 296	881
4.663 849	1536	4.664 660	262	4.665 408	244	4.665 857	1300	4.666 246	1182	4.667 532	23	4.668 088	1110	4.668 297	881
4.663 850	1536	4.664 663	1414	4.665 443	1396	4.665 858	795	4.66							

Bestellnummernindex - Numerical index - Index numérique - Índice Numérico - Índice numerico - Indeks numerów katalogowych - Указатель по номерам

4.668 483	691	4.669 129	365	4.669 339	22	4.669 551	569	4.670 748	1325	4.670 989	1289	4.671 780	1046	4.672 217	319
4.668 483	1413	4.669 132	365	4.669 340	22	4.669 552	569	4.670 749	1310	4.670 990	1289	4.671 781	1046	4.672 218	319
4.668 486	691	4.669 133	365	4.669 341	22	4.669 553	569	4.670 750	1400	4.671 320	510	4.671 782	1046	4.672 219	319
4.668 486	1413	4.669 136	365	4.669 342	22	4.669 554	569	4.670 758	545	4.671 321	510	4.671 783	1046	4.672 220	319
4.668 494	1492	4.669 137	365	4.669 343	22	4.669 555	569	4.670 759	136	4.671 322	510	4.671 809	152	4.672 221	319
4.668 495	1492	4.669 140	365	4.669 344	22	4.669 556	569	4.670 760	136	4.671 323	510	4.671 810	783	4.672 222	319
4.668 496	1492	4.669 141	365	4.669 345	22	4.669 557	569	4.670 761	136	4.671 324	510	4.671 820	138	4.672 223	319
4.668 497	1492	4.669 144	365	4.669 346	22	4.669 558	569	4.670 762	136	4.671 325	510	4.671 820	550	4.672 224	319
4.668 498	1492	4.669 145	365	4.669 347	22	4.669 559	569	4.670 763	136	4.671 326	510	4.671 821	138	4.672 225	319
4.668 520	561	4.669 148	365	4.669 348	22	4.669 560	569	4.670 764	136	4.671 327	510	4.671 821	550	4.672 226	1262
4.668 551	1200	4.669 149	365	4.669 349	22	4.669 561	569	4.670 765	136	4.671 328	510	4.671 822	91	4.672 227	644
4.668 552	575	4.669 152	365	4.669 370	1479	4.669 562	569	4.670 766	136	4.671 329	510	4.671 829	1146	4.672 230	644
4.668 556	127	4.669 153	365	4.669 371	1479	4.669 563	569	4.670 767	136	4.671 330	510	4.671 830	1146	4.672 231	644
4.668 557	750	4.669 156	365	4.669 372	1479	4.669 564	569	4.670 768	1038	4.671 331	510	4.671 831	1146	4.672 241	1527
4.668 558	750	4.669 157	365	4.669 373	1479	4.669 565	569	4.670 769	1038	4.671 332	510	4.671 832	1146	4.672 242	243
4.668 559	750	4.669 160	365	4.669 374	1479	4.669 566	569	4.670 771	121	4.671 333	510	4.671 854	374	4.672 243	243
4.668 560	750	4.669 161	365	4.669 375	1480	4.669 567	569	4.670 772	121	4.671 334	510	4.671 855	374	4.672 244	243
4.668 561	133	4.669 164	365	4.669 376	1480	4.669 568	569	4.670 773	121	4.671 335	510	4.671 856	374	4.672 245	243
4.668 562	133	4.669 165	369	4.669 377	1480	4.669 587	582	4.670 774	121	4.671 336	510	4.671 954	580	4.672 246	243
4.668 563	133	4.669 168	369	4.669 378	1480	4.669 588	582	4.670 775	121	4.671 337	510	4.671 955	580	4.672 247	243
4.668 564	133	4.669 173	365	4.669 379	1480	4.669 589	582	4.670 776	121	4.671 338	510	4.671 956	580	4.672 248	243
4.668 566	133	4.669 176	365	4.669 380	1481	4.669 590	582	4.670 777	121	4.671 339	510	4.671 957	580	4.672 249	243
4.668 571	133	4.669 177	365	4.669 381	1481	4.669 591	582	4.670 778	121	4.671 340	510	4.671 958	580	4.672 250	243
4.668 572	133	4.669 180	365	4.669 382	1481	4.669 592	582	4.670 779	121	4.671 341	510	4.671 959	580	4.672 251	243
4.668 573	127	4.669 181	365	4.669 383	1481	4.669 593	582	4.670 780	121	4.671 378	645	4.671 960	580	4.672 252	243
4.668 574	128	4.669 184	365	4.669 386	1460	4.669 594	582	4.670 781	121	4.671 386	654	4.671 961	580	4.672 253	243
4.668 575	128	4.669 202	903	4.669 387	1460	4.669 595	582	4.670 782	121	4.671 387	654	4.671 962	580	4.672 254	243
4.668 576	128	4.669 203	903	4.669 388	1460	4.669 596	582	4.670 783	121	4.671 388	654	4.671 963	588	4.672 255	243
4.668 577	128	4.669 204	903	4.669 389	1460	4.669 597	582	4.670 784	121	4.671 389	654	4.671 964	588	4.672 256	243
4.668 578	128	4.669 205	903	4.669 390	1460	4.669 598	582	4.670 785	121	4.671 390	663	4.671 965	588	4.672 257	243
4.668 579	128	4.669 206	903	4.669 391	1460	4.669 599	582	4.670 786	121	4.671 401	1541	4.671 967	589	4.672 259	132
4.668 580	198	4.669 207	903	4.669 392	1460	4.669 600	582	4.670 787	121	4.671 402	1541	4.671 968	892	4.672 261	1349
4.668 581	198	4.669 208	903	4.669 393	1460	4.669 601	582	4.670 788	121	4.671 404	1541	4.671 969	892	4.672 262	1349
4.668 582	198	4.669 209	903	4.669 394	1460	4.669 602	582	4.670 789	122	4.671 415	781	4.671 970	892	4.672 263	1349
4.668 583	198	4.669 210	903	4.669 395	1460	4.669 603	582	4.670 790	122	4.671 416	781	4.671 971	892	4.672 264	1349
4.668 584	198	4.669 211	905	4.669 396	1460	4.669 630	573	4.670 791	122	4.671 417	745	4.671 972	892	4.672 265	1349
4.668 585	198	4.669 212	905	4.669 397	1460	4.670 345	1073	4.670 792	122	4.671 418	747	4.671 973	669	4.672 266	1349
4.668 586	198	4.669 213	905	4.669 398	1460	4.670 373	1074	4.670 793	122	4.671 419	747	4.671 974	1379	4.672 267	1349
4.668 587	198	4.669 214	905	4.669 399	615	4.670 378	1074	4.670 794	122	4.671 421	747	4.671 975	1379	4.672 268	1349
4.668 590	772	4.669 215	905	4.669 400	615	4.670 384	1074	4.670 795	122	4.671 422	747	4.671 980	1352	4.672 269	1349
4.668 591	772	4.669 216	905	4.669 401	615	4.670 386	1075	4.670 796	122	4.671 423	747	4.671 981	669	4.672 270	1349
4.668 614	1137	4.669 217	905	4.669 402	615	4.670 410	1353	4.670 797	122	4.671 424	747	4.672 019	1127	4.672 271	1349
4.668 615	1137	4.669 218	905	4.669 403	615	4.670 413	1353	4.670 798	122	4.671 425	747	4.672 062	33	4.672 272	1349
4.668 624	1143	4.669 219	905	4.669 404	805	4.670 415	1353	4.670 799	122	4.671 426	747	4.672 063	33	4.672 273	1350
4.668 629	1143	4.669 220	903	4.669 405	810	4.670 417	1353	4.670 800	122	4.671 427	747	4.672 064	33	4.672 274	1350
4.668 630	1143	4.669 221	903	4.669 460	693	4.670 420	1064	4.670 801	122	4.671 428	747	4.672 065	33	4.672 275	1350
4.668 640	389	4.669 222	903	4.669 460	1412	4.670 423	1064	4.670 802	122	4.671 429	747	4.672 067	33	4.672 276	1350
4.668 641	389	4.669 223	903	4.669 470	742	4.670 425	1065	4.670 803	122	4.671 442	92	4.672 068	33	4.672 277	1350
4.668 642	389	4.669 224	903	4.669 471	742	4.670 427	1064	4.670 804	122	4.671 443	92	4.672 069	1452	4.672 278	1350
4.668 643	389	4.669 225	903	4.669 472	742	4.670 437	1065	4.670 805	122	4.671 444	92	4.672 070	1452	4.672 279	1350
4.668 673	1099	4.669 226	903	4.669 473	742	4.670 442	1073	4.670 806	122	4.671 445	92	4.672 071	1452	4.672 280	1350
4.668 674	1099	4.669 227	903	4.669 474	742	4.670 445	1073	4.670 807	122	4.671 446	92	4.672 072	1452	4.672 281	1350
4.668 716	1099	4.669 228	903	4.669 475	742	4.670 449	1073	4.670 808	122	4.671 448	997	4.672 073	1454	4.672 282	1350
4.668 775	981	4.669 229	905	4.669 476	742	4.670 456	1073	4.670 809	122	4.671 454	997	4.672 074	942	4.672 283	1350
4.668 776	981	4.669 230	905	4.669 477	742	4.670 463	1073	4.670 810	122	4.671 456	997	4.672 075	942	4.672 284	1350
4.668 777	981	4.669 231	905	4.669 478	742	4.670 470	1073	4.670 811	122	4.671 478	998	4.672 076	942	4.672 285	1350
4.668 778	981	4.669 232	905	4.669 479	742	4.670 478	1070	4.670 812	122	4.671 480	998	4.672 077	936	4.672 286	1350
4.668 779	981	4.669 233	905	4.669 480	742	4.670 483	1064	4.670 813	96	4.671 525	504	4.672 078	936	4.672 287	1350
4.668 780	981	4.669 234	905	4.669 481	742	4.670 487	1064	4.670 814	97	4.671 599	92	4.672 079	1162	4.672 291	833
4.668 781	981	4.669 235	905	4.669 482	742	4.670 492	1064	4.670 816	504	4.671 600	92	4.672 094	207	4.672 292	833
4.668 782	981	4.669 236	905	4.669 483	742	4.670 495	1065	4.670 817	504	4.671 601	92	4.672 096	207	4.672 293	833
4.668 783	981	4.669 237	905	4.669 484	742	4.670 500	1065	4.670 818	504	4.671 602	92	4.672 098	1070	4.672 294	833
4.668 784	981	4.669 246	1341	4.669 485	742	4.670 506	1073	4.670 823	508	4.671 603	92	4.672 099	1070	4.672 295	833
4.668 785	981	4.669 248	1071	4.669 486	742	4.670 516	1073	4.670 824	508	4.671 604	92	4.672 100	1070	4.672 296	833
4.668 786	981	4.669 258	584	4.669 511	1309	4.670 518	1073	4.670 826	508	4.671 605	92	4.672 102	1065	4.672 297	833
4.668 787	981	4.669 267	1485	4.669 516	579	4.670 525	1073	4.670 827	508	4.671 606	92	4.672 103	1065	4.672 298	833
4.668 788	981	4.669 268	1485	4.669 517	579	4.670 527	1073	4.670 829	508	4.671 607	92	4.672 104	1065	4.672 299	837
4.668 789	981	4.669													

Bestellnummernindex - Numerical index - Index numérique - Índice Numérico - Índice numerico - Indeks numerów katalogowych - Указатель по номерам

4.672 374	1062	4.672 535	1331	4.672 690	200	4.675 377	1279	4.675 535	1354	4.676 159	672	4.678 102	1150	4.678 396	1446
4.672 375	1067	4.672 536	1331	4.672 691	204	4.675 378	1269	4.675 536	1354	4.676 160	672	4.678 103	1150	4.678 447	286
4.672 376	1067	4.672 537	1331	4.672 692	203	4.675 384	1269	4.675 537	1354	4.676 161	672	4.678 104	1150	4.678 448	286
4.672 377	931	4.672 538	1331	4.672 693	236	4.675 390	1235	4.675 538	1354	4.676 162	672	4.678 105	1150	4.678 449	286
4.672 378	931	4.672 539	1331	4.672 694	236	4.675 391	1235	4.675 539	1354	4.676 163	881	4.678 106	1150	4.678 450	286
4.672 379	931	4.672 540	1331	4.672 695	236	4.675 392	1235	4.675 540	1354	4.676 164	881	4.678 107	1150	4.678 451	286
4.672 380	931	4.672 541	1331	4.672 696	236	4.675 393	1235	4.675 541	1354	4.676 165	881	4.678 108	1150	4.678 452	286
4.672 381	931	4.672 542	877	4.672 697	236	4.675 394	1235	4.675 542	1355	4.676 166	881	4.678 109	1150	4.678 453	286
4.672 382	931	4.672 542	1331	4.672 698	236	4.675 395	1235	4.675 543	1355	4.676 167	881	4.678 110	1150	4.678 454	286
4.672 383	931	4.672 543	877	4.672 699	236	4.675 396	1235	4.675 544	1355	4.676 168	881	4.678 111	1150	4.678 455	286
4.672 387	74	4.672 543	1331	4.672 700	200	4.675 397	1235	4.675 545	1355	4.676 169	881	4.678 112	1150	4.678 456	286
4.672 388	74	4.672 544	877	4.672 715	487	4.675 398	1235	4.675 546	1355	4.676 170	881	4.678 113	1150	4.678 457	286
4.672 389	74	4.672 544	1331	4.672 719	487	4.675 399	1235	4.675 547	1355	4.676 171	881	4.678 114	1150	4.678 458	286
4.672 390	74	4.672 545	877	4.672 743	607	4.675 400	1235	4.675 548	1355	4.676 172	879	4.678 115	1150	4.678 459	286
4.672 391	74	4.672 545	1331	4.672 774	608	4.675 401	1235	4.675 549	1355	4.676 174	284	4.678 116	1150	4.678 460	286
4.672 392	74	4.672 546	877	4.672 775	608	4.675 402	1235	4.675 550	1355	4.676 195	1357	4.678 117	1150	4.678 461	286
4.672 393	47	4.672 546	1331	4.672 776	608	4.675 403	1235	4.675 551	1355	4.676 196	1357	4.678 118	1150	4.678 462	286
4.672 394	47	4.672 547	877	4.672 777	608	4.675 404	1235	4.675 552	1355	4.676 197	1357	4.678 119	1150	4.678 463	286
4.672 395	47	4.672 547	1331	4.672 783	453	4.675 405	429	4.675 553	1355	4.676 198	1357	4.678 120	1150	4.678 464	286
4.672 396	47	4.672 548	877	4.672 809	1086	4.675 406	429	4.675 554	1355	4.676 199	1357	4.678 121	1150	4.678 465	286
4.672 397	47	4.672 548	1331	4.672 810	1086	4.675 407	429	4.675 555	1355	4.676 202	1358	4.678 122	1150	4.678 466	286
4.672 424	773	4.672 549	877	4.672 811	1086	4.675 408	429	4.675 556	1355	4.676 203	1358	4.678 123	1150	4.678 467	286
4.672 425	773	4.672 549	1331	4.674 933	241	4.675 409	429	4.675 557	1356	4.676 244	437	4.678 124	1150	4.678 468	286
4.672 426	773	4.672 550	877	4.674 934	241	4.675 410	429	4.675 558	1356	4.676 245	437	4.678 125	1150	4.678 469	286
4.672 427	773	4.672 550	1331	4.674 935	241	4.675 411	429	4.675 559	1356	4.676 246	437	4.678 126	1258	4.678 470	286
4.672 428	773	4.672 553	1342	4.674 936	238	4.675 414	429	4.675 560	1356	4.676 247	437	4.678 130	997	4.678 471	286
4.672 429	773	4.672 554	1342	4.674 938	953	4.675 416	1325	4.675 561	1356	4.676 248	437	4.678 134	293	4.678 472	286
4.672 430	780	4.672 555	1342	4.674 945	997	4.675 426	52	4.675 562	1356	4.676 249	437	4.678 137	1484	4.678 473	286
4.672 431	780	4.672 556	1342	4.674 952	35	4.675 450	695	4.675 563	1356	4.676 250	437	4.678 138	1484	4.678 474	286
4.672 432	780	4.672 557	1342	4.674 953	35	4.675 452	1214	4.675 564	1356	4.676 251	437	4.678 139	1484	4.678 475	286
4.672 433	780	4.672 558	1342	4.674 970	1144	4.675 453	1524	4.675 565	1356	4.676 252	421	4.678 140	1484	4.678 476	286
4.672 434	780	4.672 559	1342	4.674 973	1146	4.675 454	1524	4.675 566	1356	4.676 253	439	4.678 141	1484	4.678 477	286
4.672 435	780	4.672 560	1342	4.674 974	1144	4.675 455	1202	4.675 567	1356	4.676 254	439	4.678 142	1484	4.678 478	286
4.672 436	779	4.672 561	1342	4.674 978	1146	4.675 456	1202	4.675 568	1356	4.676 255	439	4.678 143	1484	4.678 479	286
4.672 437	780	4.672 562	1342	4.674 979	396	4.675 457	1202	4.675 569	1356	4.676 256	439	4.678 144	1484	4.678 480	286
4.672 438	780	4.672 563	1342	4.674 982	39	4.675 469	756	4.675 570	1356	4.676 265	1489	4.678 145	1484	4.678 481	286
4.672 439	780	4.672 564	937	4.674 983	39	4.675 470	756	4.675 571	1355	4.676 266	1489	4.678 146	1484	4.678 482	286
4.672 440	780	4.672 565	937	4.674 984	39	4.675 471	756	4.675 572	1355	4.676 267	1487	4.678 147	1484	4.678 483	286
4.672 441	780	4.672 566	937	4.674 985	39	4.675 472	756	4.675 573	1355	4.676 268	1487	4.678 148	1484	4.678 484	286
4.672 442	779	4.672 567	937	4.674 986	39	4.675 473	756	4.675 574	1355	4.676 269	1487	4.678 156	1531	4.678 485	286
4.672 443	779	4.672 568	937	4.674 987	39	4.675 474	756	4.675 575	1355	4.676 270	1487	4.678 159	91	4.678 486	286
4.672 444	780	4.672 569	937	4.675 024	259	4.675 475	756	4.675 576	1355	4.676 271	1487	4.678 160	91	4.678 487	286
4.672 445	780	4.672 570	937	4.675 028	1451	4.675 476	756	4.675 577	1355	4.678 019	918	4.678 161	91	4.678 488	286
4.672 446	780	4.672 571	937	4.675 029	1300	4.675 477	756	4.675 578	1355	4.678 020	918	4.678 162	91	4.678 489	286
4.672 447	780	4.672 572	937	4.675 043	236	4.675 478	756	4.675 579	1355	4.678 021	918	4.678 163	91	4.678 490	286
4.672 448	780	4.672 573	937	4.675 044	236	4.675 479	756	4.675 580	1355	4.678 022	918	4.678 164	91	4.678 491	286
4.672 449	780	4.672 574	937	4.675 045	236	4.675 480	756	4.675 581	1355	4.678 023	918	4.678 165	91	4.678 492	286
4.672 450	780	4.672 575	842	4.675 220	906	4.675 481	756	4.675 582	1355	4.678 024	918	4.678 166	91	4.678 493	286
4.672 451	780	4.672 576	842	4.675 221	906	4.675 482	1369	4.675 583	1372	4.678 025	918	4.678 195	473	4.678 532	649
4.672 452	780	4.672 577	842	4.675 222	907	4.675 483	1369	4.675 584	1372	4.678 026	918	4.678 196	473	4.678 533	649
4.672 453	780	4.672 578	842	4.675 228	821	4.675 484	1369	4.675 585	1372	4.678 027	918	4.678 197	138	4.678 534	649
4.672 457	780	4.672 579	466	4.675 229	821	4.675 485	1335	4.675 586	1372	4.678 028	918	4.678 197	550	4.678 535	649
4.672 458	780	4.672 580	466	4.675 230	821	4.675 486	1335	4.675 587	1346	4.678 029	918	4.678 198	138	4.678 536	649
4.672 459	780	4.672 581	466	4.675 231	821	4.675 487	1335	4.675 588	1346	4.678 030	918	4.678 198	550	4.678 537	649
4.672 460	780	4.672 582	466	4.675 232	821	4.675 488	1336	4.675 589	1346	4.678 031	918	4.678 202	172	4.678 538	649
4.672 461	780	4.672 583	466	4.675 233	821	4.675 489	1335	4.675 590	1346	4.678 032	918	4.678 204	346	4.678 539	649
4.672 462	780	4.672 584	466	4.675 234	821	4.675 490	1335	4.675 591	1346	4.678 033	918	4.678 205	346	4.678 540	649
4.672 463	780	4.672 585	466	4.675 235	199	4.675 491	1335	4.675 592	1346	4.678 034	918	4.678 206	346	4.678 541	649
4.672 493	450	4.672 586	466	4.675 298	1105	4.675 492	1335	4.675 593	1346	4.678 035	918	4.678 215	306	4.678 542	649
4.672 494	450	4.672 602	872	4.675 299	1105	4.675 493	1336	4.675 594	1346	4.678 036	917	4.678 216	306	4.678 543	649
4.672 495	450	4.672 603	872	4.675 300	905	4.675 494	1335	4.675 600	1355	4.678 037	917	4.678 217	306	4.678 544	649
4.672 496	450	4.672 604	865	4.675 301	1310	4.675 495	1335	4.675 617	1333	4.678 038	1347	4.678 221	340	4.678 545	649
4.672 497	450	4.672 605	687	4.675 302	1310	4.675 496	1336	4.675 618	1333	4.678 039	1347	4.678 222	340	4.678 546	649
4.672 498	450	4.672 606	687	4.675 303	1311	4.675 497	1335	4.675 619	1333	4.678 040	1347	4.678 226	332	4.678 547	649
4.672 499	842	4.672 607	687	4.675 304	1311	4.675 498	1335	4.675 620	1333	4.678 041	1347	4.678 227	332	4.678 548	649
4.672 500	842	4.672 608	687	4.675 306	1311	4.675 499	1335	4.675 621	1333	4.678 042	564	4.678 228	332	4.678 549	649
4.672 501	842	4.672 619	1359	4.675 307	1311	4.675 500	1336	4.675 622	1333	4.678 043	564				

Bestellnummernindex - Numerical index - Index numérique - Índice Numérico - Índice numerico - Indeks numerów katalogowych - Указатель по номерам

4.678 596	650	6.052 545	147	6.059 800	933	6.073 041	1392	6.077 390	147	6.081 539	1385	6.091 294	192	6.201 960	734
4.678 597	650	6.052 587	164	6.059 874	1136	6.073 051	733	6.077 398	1214	6.081 654	758	6.091 369	324	6.202 021	182
4.678 598	650	6.052 588	164	6.059 899	1455	6.073 068	654	6.077 399	1215	6.081 670	179	6.091 529	432	6.202 135	716
4.678 599	650	6.052 589	164	6.059 920	113	6.073 104	1276	6.077 412	16	6.081 736	1385	6.091 843	562	6.202 172	828
4.678 600	650	6.052 590	164	6.059 957	144	6.073 106	1155	6.077 415	751	6.081 798	929	6.091 887	225	6.202 190	1495
4.678 601	650	6.052 591	164	6.059 976	1492	6.073 113	640	6.077 417	751	6.081 879	758	6.092 721	929	6.202 305	577
4.678 602	650	6.052 592	164	6.059 976	1492	6.073 163	427	6.077 445	147	6.082 435	1244	6.092 728	991	6.202 371	1374
4.678 603	650	6.052 593	164	6.059 977	1492	6.073 183	628	6.077 451	147	6.082 633	991	6.092 769	904	6.202 376	1486
4.678 604	650	6.052 594	164	6.059 977	1492	6.073 246	645	6.077 452	147	6.082 701	758	6.092 988	1410	6.202 380	649
4.678 605	650	6.052 595	164	6.060 303	118	6.073 253	141	6.077 556	116	6.082 974	141	6.092 997	553	6.202 382	211
4.678 606	650	6.052 596	164	6.060 304	118	6.073 260	640	6.077 624	147	6.082 990	644	6.093 022	688	6.202 386	654
4.678 607	650	6.052 598	164	6.060 305	118	6.073 271	477	6.077 689	117	6.083 078	771	6.093 232	655	6.202 416	1475
4.678 608	650	6.052 630	1215	6.060 324	117	6.073 292	1374	6.077 690	147	6.083 393	1462	6.093 247	1437	6.202 417	1475
4.678 609	651	6.052 763	1154	6.060 366	179	6.073 294	835	6.077 692	147	6.083 415	149	6.093 247	1439	6.202 418	1475
4.678 610	651	6.052 959	929	6.060 382	188	6.073 298	1275	6.077 706	177	6.083 463	1038	6.093 247	1441	6.202 427	1243
4.678 611	651	6.053 055	1154	6.060 786	1252	6.073 310	619	6.077 737	115	6.083 519	757	6.093 247	1440	6.202 446	654
4.678 612	651	6.053 239	118	6.060 787	1252	6.073 375	119	6.077 738	618	6.083 814	1058	6.093 260	1147	6.202 459	629
4.678 613	651	6.053 253	179	6.060 788	1252	6.073 469	78	6.077 745	185	6.083 925	965	6.093 322	1147	6.202 530	42
4.678 614	651	6.053 289	1462	6.060 789	1253	6.073 469	1020	6.077 767	118	6.083 932	1457	6.093 356	339	6.202 544	1244
4.678 615	651	6.053 291	1118	6.070 007	185	6.073 481	623	6.077 825	118	6.083 942	116	6.093 621	1497	6.202 636	1276
4.678 663	1323	6.053 310	253	6.070 009	1024	6.073 489	643	6.077 875	757	6.084 029	929	6.093 728	47	6.202 638	1276
4.678 664	1323	6.053 348	146	6.070 033	655	6.073 505	94	6.077 876	64	6.084 072	929	6.100 525	828	6.202 667	743
4.678 665	1323	6.053 546	1108	6.070 044	185	6.073 555	1442	6.077 882	751	6.084 147	157	6.100 527	828	6.202 713	933
4.678 666	1323	6.053 602	994	6.070 046	628	6.073 833	1441	6.077 925	116	6.084 197	178	6.100 528	828	6.202 714	933
4.678 667	1323	6.053 660	771	6.070 072	1024	6.074 044	178	6.078 107	446	6.084 306	1462	6.100 529	828	6.202 748	1462
4.678 668	1323	6.053 755	1456	6.070 079	115	6.074 169	381	6.078 136	143	6.084 320	768	6.100 530	828	6.202 804	622
4.678 669	1323	6.054 195	146	6.070 095	1462	6.074 169	1183	6.078 144	751	6.084 360	965	6.100 531	828	6.202 825	1374
4.678 670	1323	6.054 343	929	6.070 119	1171	6.074 178	446	6.078 145	751	6.084 361	965	6.100 532	828	6.202 839	757
4.678 671	1323	6.054 452	109	6.070 141	109	6.074 754	339	6.078 159	912	6.084 365	965	6.100 533	828	6.202 850	1463
4.678 672	1323	6.054 526	146	6.070 153	750	6.075 030	109	6.078 162	1483	6.084 496	432	6.100 534	828	6.202 868	933
4.678 673	1323	6.054 581	1212	6.070 155	185	6.075 034	147	6.078 174	1058	6.084 538	758	6.200 206	1212	6.202 988	622
4.678 674	1323	6.054 631	380	6.070 187	1213	6.075 473	1265	6.078 175	1047	6.084 555	395	6.200 208	213	6.203 014	622
4.678 675	1323	6.054 634	380	6.070 203	1456	6.075 746	695	6.078 182	1462	6.084 681	991	6.200 263	558	6.203 214	1258
4.678 676	1323	6.054 664	693	6.070 276	510	6.075 807	769	6.078 202	750	6.084 722	1153	6.200 303	200	6.203 226	1244
4.678 677	1323	6.054 710	147	6.070 277	510	6.075 814	893	6.078 270	116	6.084 736	110	6.200 316	212	6.203 235	956
4.678 678	1323	6.054 776	147	6.070 291	109	6.075 820	758	6.078 279	1216	6.084 856	395	6.200 335	109	6.203 256	1275
4.678 694	1480	6.054 780	1251	6.070 318	115	6.075 892	118	6.078 290	118	6.084 955	1374	6.200 336	109	6.203 263	622
4.678 809	877	6.054 809	381	6.070 401	1060	6.075 894	118	6.078 358	147	6.084 976	992	6.200 370	1185	6.203 284	1244
4.678 810	877	6.055 095	278	6.070 411	770	6.075 946	146	6.078 395	115	6.085 021	1368	6.200 383	1214	6.203 285	1244
4.678 811	877	6.055 100	1116	6.070 424	991	6.075 999	188	6.078 413	147	6.085 144	1368	6.200 394	545	6.203 327	718
4.678 812	877	6.055 115	432	6.070 440	983	6.076 057	253	6.078 446	45	6.085 184	1406	6.200 398	184	6.203 350	1493
6.005 795	114	6.055 129	110	6.070 485	118	6.076 115	1462	6.078 473	146	6.085 289	994	6.200 419	1462	6.203 402	936
6.005 993	112	6.055 199	1133	6.070 510	428	6.076 152	1039	6.078 500	947	6.085 341	147	6.200 432	912	6.203 415	625
6.006 036	106	6.055 292	109	6.070 518	147	6.076 184	188	6.078 584	147	6.085 419	1493	6.200 433	912	6.203 416	625
6.018 346	1028	6.055 335	1455	6.070 535	115	6.076 204	186	6.078 655	184	6.085 427	109	6.200 434	912	6.203 535	828
6.018 347	1028	6.055 461	45	6.070 542	654	6.076 221	1462	6.078 678	146	6.085 475	1490	6.200 438	1329	6.203 538	654
6.020 109	1124	6.055 472	929	6.070 548	771	6.076 243	29	6.078 740	771	6.085 561	993	6.200 447	624	6.203 543	1215
6.027 813	188	6.055 476	141	6.070 565	205	6.076 250	188	6.078 779	1154	6.085 753	1462	6.200 448	933	6.203 549	867
6.035 607	1281	6.055 561	1252	6.070 616	1108	6.076 279	117	6.078 858	749	6.085 775	16	6.200 496	911	6.203 560	381
6.035 609	1281	6.055 754	446	6.070 661	113	6.076 309	180	6.078 868	110	6.085 794	1215	6.200 515	1458	6.203 561	325
6.049 748	693	6.056 159	147	6.070 692	771	6.076 351	188	6.079 073	628	6.085 852	993	6.200 538	189	6.203 569	621
6.050 057	1114	6.056 160	147	6.070 786	188	6.076 356	49	6.079 079	758	6.085 914	145	6.200 595	192	6.203 571	621
6.050 096	1461	6.056 307	965	6.070 787	188	6.076 362	1212	6.079 121	750	6.085 976	192	6.200 639	947	6.203 572	621
6.050 099	1461	6.056 364	16	6.070 797	118	6.076 365	1214	6.079 139	1058	6.086 178	562	6.200 654	204	6.203 600	1275
6.050 132	66	6.056 365	16	6.071 718	147	6.076 374	496	6.079 156	1026	6.086 375	1154	6.200 675	618	6.203 803	1244
6.050 133	66	6.056 366	16	6.071 748	929	6.076 375	496	6.079 157	1026	6.086 397	147	6.200 677	624	6.203 812	674
6.050 151	1337	6.056 389	380	6.071 758	1462	6.076 481	993	6.079 278	1214	6.086 921	1147	6.200 760	179	6.203 851	991
6.050 155	1213	6.056 390	380	6.071 767	863	6.076 504	566	6.079 307	180	6.086 994	1524	6.200 774	835	6.203 870	16
6.050 160	1457	6.056 393	380	6.071 787	750	6.076 513	147	6.079 309	180	6.086 996	1524	6.200 782	663	6.203 889	745
6.050 224	1458	6.056 436	1047	6.071 788	750	6.076 518	109	6.079 397	929	6.087 044	558	6.200 783	395	6.203 948	647
6.050 553	1215	6.056 446	904	6.071 789	750	6.076 521	147	6.079 436	428	6.087 242	1493	6.200 838	162	6.203 961	1475
6.050 554	1214	6.056 477	432	6.071 792	635	6.076 525	180	6.079 458	622	6.087 538	633	6.200 882	147	6.203 996	718
6.050 562	45	6.056 580	1026	6.071 808	1058	6.076 532	633	6.079 464	113	6.087 581	566	6.200 910	144	6.204 040	1491
6.050 595	1107	6.056 774	1214	6.071 809	1058	6.076 543	118	6.079 513	66	6.087 623	745	6.200 955	929	6.204 073	1243
6.050 757	1215	6.056 820	929	6.071 810	1058	6.076 560	771	6.079 517	943	6.087 703	1216	6.200 957	947	6.204 103	1493
6.050 768	109	6.056 853	109	6.071 880	1483	6.076 598	183	6.079 530	1122	6.088 058	633	6.200 970	115	6.204 108	1244
6.050 803	147	6.056 856	621	6.071 888	182	6.076 621	179	6.079 568	566	6.088 059	633	6.200 977	170	6.204 134	40

Bestellnummernindex - Numerical index - Index numérique - Índice Numérico - Índice numerico - Indeks numerów katalogowych - Указатель по номерам

6.204 890	642	6.206 693	325	6.223 971	1336	6.226 179	37	6.228 513	358	6.230 277	826	6.232 327	231	6.234 218	1126
6.204 936	40	6.206 703	734	6.224 032	213	6.226 185	695	6.228 531	1472	6.230 295	1126	6.232 362	739	6.234 225	905
6.204 944	323	6.206 710	36	6.224 033	213	6.226 218	1489	6.228 560	1294	6.230 298	1126	6.232 384	24	6.234 247	688
6.204 945	328	6.206 710	762	6.224 111	735	6.226 261	158	6.228 624	64	6.230 315	718	6.232 389	738	6.234 251	768
6.204 955	1494	6.206 738	325	6.224 123	695	6.226 262	158	6.228 639	560	6.230 318	188	6.232 433	867	6.234 252	768
6.204 980	1489	6.206 755	126	6.224 148	234	6.226 301	768	6.228 676	993	6.230 322	325	6.232 433	898	6.234 253	768
6.204 985	1244	6.206 833	1488	6.224 187	237	6.226 302	768	6.228 679	993	6.230 350	1129	6.232 434	1127	6.234 254	768
6.205 017	1475	6.206 850	1062	6.224 187	381	6.226 307	1275	6.228 698	969	6.230 396	644	6.232 435	990	6.234 302	1489
6.205 063	108	6.206 856	104	6.224 189	1493	6.226 328	1477	6.228 699	969	6.230 410	990	6.232 481	1204	6.234 303	1489
6.205 076	1493	6.206 861	904	6.224 191	890	6.226 329	1477	6.228 700	969	6.230 416	1310	6.232 482	1204	6.234 320	204
6.205 081	935	6.206 884	993	6.224 194	631	6.226 331	718	6.228 701	969	6.230 433	1152	6.232 501	1418	6.234 347	1118
6.205 100	1488	6.206 902	1237	6.224 194	826	6.226 332	718	6.228 702	969	6.230 491	338	6.232 525	105	6.234 373	391
6.205 104	104	6.206 907	327	6.224 207	1008	6.226 427	1493	6.228 703	969	6.230 515	1081	6.232 548	737	6.234 375	1466
6.205 105	104	6.206 960	994	6.224 223	1297	6.226 445	323	6.228 704	969	6.230 526	1237	6.232 549	737	6.234 463	212
6.205 109	40	6.207 025	173	6.224 227	994	6.226 450	905	6.228 705	969	6.230 535	1008	6.232 574	565	6.234 464	212
6.205 110	40	6.207 027	1489	6.224 228	994	6.226 452	1466	6.228 706	971	6.230 605	624	6.232 575	1121	6.234 510	19
6.205 128	84	6.207 050	894	6.224 229	994	6.226 470	27	6.228 707	971	6.230 608	1214	6.232 577	565	6.234 511	359
6.205 144	990	6.207 066	446	6.224 230	994	6.226 546	1489	6.228 708	971	6.230 635	1244	6.232 602	143	6.234 515	933
6.205 165	1008	6.207 107	1189	6.224 231	991	6.226 552	1319	6.228 709	971	6.230 658	393	6.232 660	1495	6.234 530	1346
6.205 169	695	6.207 113	646	6.224 234	992	6.226 570	906	6.228 715	991	6.230 729	1495	6.232 716	379	6.234 541	1448
6.205 218	1231	6.207 119	1147	6.224 235	992	6.226 571	906	6.228 716	991	6.230 760	616	6.232 732	640	6.234 542	158
6.205 237	1488	6.207 120	1147	6.224 236	993	6.226 643	628	6.228 718	991	6.230 773	1189	6.232 794	735	6.234 545	728
6.205 238	1488	6.207 149	735	6.224 244	965	6.226 725	398	6.228 719	991	6.230 775	993	6.232 941	633	6.234 552	1253
6.205 239	1488	6.207 164	1336	6.224 287	615	6.226 741	317	6.228 721	994	6.230 826	624	6.233 012	1265	6.234 567	990
6.205 269	1244	6.207 171	398	6.224 318	79	6.226 757	624	6.228 740	994	6.230 832	260	6.233 030	695	6.234 568	990
6.205 314	338	6.207 173	1398	6.224 327	109	6.226 798	1463	6.228 742	994	6.230 835	922	6.233 078	857	6.234 576	1143
6.205 318	1489	6.207 176	642	6.224 347	990	6.226 802	189	6.228 743	994	6.230 844	1477	6.233 091	621	6.234 591	565
6.205 327	1264	6.207 191	40	6.224 367	1000	6.226 809	990	6.228 744	994	6.230 881	211	6.233 114	621	6.234 592	565
6.205 365	1235	6.207 196	446	6.224 368	1000	6.226 824	432	6.228 745	994	6.230 885	695	6.233 131	556	6.234 598	544
6.205 372	1464	6.207 217	828	6.224 373	1022	6.226 833	990	6.228 746	994	6.230 893	841	6.233 141	1148	6.234 641	325
6.205 412	339	6.207 280	695	6.224 397	642	6.226 853	1398	6.228 747	994	6.230 923	230	6.233 165	158	6.234 725	529
6.205 413	339	6.210 059	956	6.224 417	1495	6.226 915	1477	6.228 748	994	6.230 985	1127	6.233 172	737	6.234 735	758
6.205 415	339	6.210 064	147	6.224 460	40	6.226 934	1081	6.228 750	994	6.231 072	104	6.233 176	745	6.234 815	558
6.205 429	955	6.210 081	1215	6.224 461	40	6.226 935	1081	6.228 752	992	6.231 087	1346	6.233 196	380	6.234 817	673
6.205 430	955	6.210 121	496	6.224 842	1464	6.226 936	1081	6.228 753	992	6.231 115	113	6.233 200	633	6.234 818	673
6.205 458	543	6.210 129	339	6.224 850	1466	6.226 943	16	6.228 754	992	6.231 140	1483	6.233 275	619	6.234 831	144
6.205 471	1489	6.210 135	980	6.224 872	1066	6.227 063	1047	6.228 755	992	6.231 153	1456	6.233 306	1244	6.234 859	339
6.205 483	40	6.210 150	980	6.224 886	620	6.227 083	219	6.228 756	993	6.231 160	920	6.233 316	320	6.234 997	723
6.205 512	662	6.210 151	1149	6.224 893	989	6.227 097	213	6.228 757	993	6.231 173	354	6.233 319	1329	6.234 998	1253
6.205 532	1489	6.210 152	1149	6.224 896	398	6.227 120	741	6.228 758	993	6.231 216	108	6.233 324	1385	6.234 999	1253
6.205 559	428	6.210 153	1149	6.224 904	1275	6.227 149	565	6.228 762	1318	6.231 269	589	6.233 344	108	6.235 017	722
6.205 584	118	6.210 154	1149	6.224 905	1275	6.227 150	565	6.228 788	1493	6.231 283	472	6.233 381	318	6.235 042	94
6.205 674	695	6.210 168	627	6.224 906	1276	6.227 192	1489	6.228 807	1318	6.231 293	647	6.233 382	703	6.235 043	955
6.205 692	662	6.222 013	1456	6.224 912	968	6.227 200	906	6.228 823	1307	6.231 352	27	6.233 417	225	6.235 055	1147
6.205 694	621	6.222 104	654	6.224 913	1152	6.227 289	565	6.228 829	701	6.231 356	1058	6.233 418	1418	6.235 082	264
6.205 722	1524	6.222 130	1342	6.224 916	96	6.227 292	565	6.228 848	1299	6.231 359	1058	6.233 420	1418	6.235 083	1516
6.205 732	173	6.222 284	828	6.224 951	108	6.227 373	1488	6.228 893	757	6.231 389	235	6.233 421	1418	6.235 096	260
6.205 734	417	6.222 339	911	6.224 952	108	6.227 381	1354	6.228 898	248	6.231 425	235	6.233 440	1272	6.235 098	358
6.205 791	1244	6.222 402	115	6.224 985	941	6.227 431	623	6.228 923	835	6.231 427	616	6.233 463	905	6.235 155	237
6.205 839	695	6.222 441	1339	6.224 986	108	6.227 443	1081	6.228 924	835	6.231 447	235	6.233 465	300	6.235 155	381
6.205 840	1240	6.222 534	635	6.225 054	108	6.227 450	1490	6.228 969	1443	6.231 512	867	6.233 543	398	6.235 183	467
6.205 852	719	6.222 672	876	6.225 055	108	6.227 451	652	6.228 981	43	6.231 520	675	6.233 548	1317	6.235 187	397
6.205 860	1524	6.222 672	1334	6.225 059	339	6.227 452	652	6.228 982	43	6.231 539	489	6.233 568	1495	6.235 214	359
6.205 866	640	6.222 677	558	6.225 112	863	6.227 536	57	6.228 993	961	6.231 540	105	6.233 571	398	6.235 249	1474
6.205 965	662	6.222 688	867	6.225 141	108	6.227 656	339	6.228 995	961	6.231 541	749	6.233 602	214	6.235 250	1474
6.205 966	662	6.222 688	898	6.225 150	319	6.227 666	1151	6.229 038	1321	6.231 555	1151	6.233 613	359	6.235 261	150
6.205 982	432	6.222 763	1319	6.225 158	610	6.227 688	104	6.229 041	1354	6.231 576	517	6.233 627	1489	6.235 261	1057
6.205 984	1489	6.222 767	302	6.225 161	325	6.227 717	486	6.229 183	921	6.231 591	1127	6.233 664	890	6.235 293	1021
6.205 990	1494	6.222 805	1319	6.225 180	1464	6.227 761	540	6.229 184	921	6.231 607	359	6.233 690	416	6.235 314	1374
6.206 011	1148	6.222 839	718	6.225 217	990	6.227 768	1449	6.229 269	1171	6.231 685	358	6.233 695	990	6.235 370	959
6.206 032	1214	6.222 865	339	6.225 223	1463	6.227 780	1477	6.229 381	1323	6.231 686	1008	6.233 696	1369	6.235 385	325
6.206 034	1320	6.222 868	655	6.225 246	733	6.227 781	1477	6.229 382	593	6.231 713	1497	6.233 742	967	6.235 417	890
6.206 041	1237	6.222 876	316	6.225 256	104	6.227 782	1477	6.229 399	358	6.231 726	1476	6.233 743	967	6.235 425	1459
6.206 049	1492	6.222 886	45	6.225 263	828	6.227 799	1165	6.229 401	251	6.231 770	1384	6.233 744	967	6.235 556	358
6.206 050	1492	6.222 901	915	6.225 278	180	6.227 810	108	6.229 444	644	6.231 785	1317	6.233 745	967	6.235 565	990
6.206 124	1458	6.222 953	1336	6.225 298	1354	6.227 811	108	6.229 494	1477	6.231 788	1390	6.233 748	745	6.235 571	993
6.206 129	758	6.223 010	316	6.225 455	863	6.227 832	636	6.229 495	1477	6.231 790	1126	6.233 756	1317	6.235 603	

Bestellnummernindex - Numerical index - Index numérique - Índice Numérico - Índice numerico - Indeks numerów katalogowych - Указатель по номерам

6.236 112	662	6.237 622	35	6.239 177	105	6.240 992	1368	6.242 424	113	6.243 591	1275	6.251 474	106	6.253 894	762
6.236 223	900	6.237 627	1025	6.239 178	967	6.241 030	1121	6.242 463	1025	6.243 602	626	6.251 474	862	6.253 916	959
6.236 224	900	6.237 628	1028	6.239 195	118	6.241 034	1246	6.242 468	1444	6.243 603	626	6.251 480	158	6.253 917	959
6.236 239	637	6.237 648	184	6.239 206	715	6.241 035	1246	6.242 476	139	6.243 604	626	6.251 521	610	6.253 918	959
6.236 247	644	6.237 656	230	6.239 230	616	6.241 036	1246	6.242 476	549	6.243 606	623	6.251 590	1203	6.253 919	959
6.236 264	127	6.237 670	361	6.239 263	1164	6.241 090	615	6.242 495	663	6.243 607	623	6.251 593	268	6.253 920	959
6.236 287	150	6.237 684	230	6.239 273	1306	6.241 111	1446	6.242 530	1127	6.243 608	623	6.251 643	1408	6.253 921	959
6.236 287	1057	6.237 690	16	6.239 322	278	6.241 114	678	6.242 589	375	6.243 609	623	6.251 644	1408	6.253 922	959
6.236 293	886	6.237 691	16	6.239 332	1491	6.241 116	1025	6.242 606	1250	6.243 610	623	6.251 700	201	6.253 931	1459
6.236 303	618	6.237 692	16	6.239 337	1458	6.241 122	906	6.242 631	699	6.243 611	623	6.251 705	990	6.253 940	1147
6.236 317	639	6.237 698	1519	6.239 360	1458	6.241 127	1065	6.242 632	699	6.243 612	623	6.251 738	633	6.253 949	767
6.236 318	639	6.237 702	618	6.239 384	1131	6.241 130	164	6.242 633	716	6.243 613	623	6.251 768	1367	6.253 979	767
6.236 319	639	6.237 703	127	6.239 400	990	6.241 198	1012	6.242 668	699	6.243 614	623	6.251 868	1374	6.253 980	767
6.236 320	639	6.237 704	623	6.239 416	230	6.241 199	269	6.242 669	710	6.243 615	623	6.251 896	317	6.253 981	767
6.236 321	639	6.237 706	751	6.239 419	799	6.241 216	1025	6.242 670	710	6.243 616	620	6.251 896	734	6.253 982	767
6.236 328	40	6.237 707	751	6.239 438	919	6.241 225	1216	6.242 671	699	6.243 617	620	6.251 900	967	6.253 984	72
6.236 329	40	6.237 708	751	6.239 507	180	6.241 227	1216	6.242 672	699	6.243 618	620	6.251 939	501	6.254 014	375
6.236 330	40	6.237 711	662	6.239 531	188	6.241 234	1147	6.242 677	30	6.243 619	620	6.251 980	1408	6.254 092	21
6.236 331	968	6.237 738	1362	6.239 576	337	6.241 238	234	6.242 700	184	6.243 620	620	6.251 983	767	6.254 093	21
6.236 335	1364	6.237 788	1182	6.239 577	343	6.241 252	1418	6.242 701	177	6.243 633	320	6.252 007	1148	6.254 100	21
6.236 346	618	6.237 816	1275	6.239 613	904	6.241 255	381	6.242 703	179	6.243 664	662	6.252 022	302	6.254 101	21
6.236 347	620	6.237 840	757	6.239 618	828	6.241 274	368	6.242 704	145	6.243 665	662	6.252 026	324	6.254 102	21
6.236 355	851	6.237 850	566	6.239 724	1025	6.241 291	751	6.242 742	23	6.243 666	662	6.252 027	324	6.254 106	642
6.236 357	380	6.237 877	1339	6.239 754	38	6.241 351	237	6.242 742	811	6.243 667	662	6.252 036	303	6.254 108	641
6.236 370	1474	6.237 901	72	6.239 769	316	6.241 371	568	6.242 746	48	6.243 668	662	6.252 048	568	6.254 133	646
6.236 383	1418	6.237 902	1056	6.239 797	375	6.241 374	1297	6.242 747	710	6.243 669	635	6.252 072	716	6.254 169	398
6.236 446	604	6.237 952	1393	6.239 803	180	6.241 444	554	6.242 748	710	6.243 670	635	6.252 081	922	6.254 182	708
6.236 466	1371	6.237 958	1163	6.239 804	180	6.241 448	673	6.242 757	1514	6.243 673	640	6.252 153	96	6.254 192	1322
6.236 477	1094	6.237 965	1131	6.239 805	180	6.241 459	1297	6.242 769	857	6.243 682	135	6.252 154	96	6.254 233	1001
6.236 495	968	6.237 971	1115	6.239 812	637	6.241 474	345	6.242 774	642	6.243 690	184	6.252 166	96	6.254 234	1001
6.236 498	545	6.237 971	1392	6.239 822	180	6.241 499	904	6.242 784	94	6.243 692	178	6.252 178	313	6.254 275	162
6.236 499	361	6.237 972	1113	6.239 828	323	6.241 505	1047	6.242 786	701	6.243 700	1000	6.252 178	335	6.254 284	375
6.236 508	618	6.237 981	47	6.239 836	995	6.241 533	645	6.242 793	501	6.243 711	716	6.252 181	266	6.254 292	95
6.236 539	1333	6.237 998	851	6.239 883	410	6.241 602	427	6.242 808	737	6.243 752	757	6.252 217	1395	6.254 294	1353
6.236 577	635	6.238 005	455	6.239 884	410	6.241 603	427	6.242 811	1156	6.243 831	407	6.252 313	283	6.254 325	628
6.236 596	104	6.238 006	455	6.239 903	749	6.241 644	1393	6.242 844	338	6.243 865	565	6.252 363	139	6.254 337	1204
6.236 597	104	6.238 044	358	6.239 927	323	6.241 652	751	6.242 852	640	6.243 880	304	6.252 363	549	6.254 338	1204
6.236 598	104	6.238 066	990	6.239 985	214	6.241 661	265	6.242 855	265	6.243 905	140	6.252 364	734	6.254 364	981
6.236 599	104	6.238 106	967	6.240 037	677	6.241 671	639	6.242 856	265	6.243 905	1383	6.252 383	565	6.254 390	767
6.236 618	113	6.238 112	1240	6.240 039	1152	6.241 673	266	6.242 878	130	6.243 984	1418	6.252 384	565	6.254 394	1063
6.236 670	1362	6.238 115	1307	6.240 040	1152	6.241 690	1131	6.242 879	130	6.243 985	223	6.252 395	1474	6.254 446	44
6.236 683	132	6.238 121	996	6.240 063	905	6.241 715	627	6.242 923	375	6.243 986	223	6.252 455	634	6.254 472	395
6.236 719	363	6.238 122	47	6.240 077	1516	6.241 723	265	6.242 987	380	6.244 006	1382	6.252 583	1329	6.254 494	354
6.236 733	791	6.238 138	383	6.240 102	967	6.241 758	1459	6.243 010	23	6.244 006	1386	6.252 610	735	6.254 523	628
6.236 751	1491	6.238 139	383	6.240 150	375	6.241 759	1459	6.243 010	811	6.244 011	639	6.252 619	204	6.254 546	930
6.236 773	623	6.238 140	383	6.240 222	566	6.241 787	904	6.243 011	23	6.244 028	1333	6.252 634	1516	6.254 570	758
6.236 774	618	6.238 141	37	6.240 223	1207	6.241 792	1483	6.243 011	811	6.244 042	304	6.252 642	407	6.254 571	758
6.236 800	1040	6.238 169	381	6.240 342	636	6.241 795	990	6.243 018	398	6.244 044	628	6.252 678	407	6.254 572	758
6.236 821	701	6.238 170	381	6.240 360	967	6.241 814	918	6.243 019	398	6.244 067	496	6.252 725	311	6.254 573	1117
6.236 831	708	6.238 171	381	6.240 378	765	6.241 820	106	6.243 030	652	6.244 089	905	6.252 765	710	6.254 574	1117
6.236 840	1265	6.238 174	343	6.240 382	403	6.241 820	862	6.243 031	646	6.244 118	1094	6.252 823	501	6.254 575	1117
6.236 850	544	6.238 196	995	6.240 397	255	6.241 832	1289	6.243 032	647	6.244 589	386	6.252 857	935	6.254 577	35
6.236 854	383	6.238 197	995	6.240 397	254	6.241 832	1290	6.243 069	542	6.244 589	645	6.252 898	1223	6.254 578	35
6.236 916	225	6.238 199	995	6.240 397	254	6.241 855	708	6.243 069	1213	6.244 590	646	6.252 946	501	6.254 604	666
6.236 917	225	6.238 239	592	6.240 408	358	6.241 856	358	6.243 070	27	6.244 591	626	6.252 972	201	6.254 612	1113
6.236 921	1129	6.238 244	1112	6.240 412	639	6.241 859	695	6.243 104	630	6.244 592	626	6.253 024	43	6.254 687	767
6.236 954	627	6.238 272	1393	6.240 425	623	6.241 879	567	6.243 104	810	6.244 593	626	6.253 092	259	6.254 713	136
6.236 962	1244	6.238 319	990	6.240 426	618	6.241 880	567	6.243 105	630	6.244 594	626	6.253 093	259	6.254 719	823
6.237 000	950	6.238 320	990	6.240 465	259	6.241 881	567	6.243 105	810	6.245 034	1130	6.253 096	259	6.254 727	1459
6.237 001	950	6.238 345	618	6.240 471	138	6.241 895	113	6.243 106	630	6.245 038	630	6.253 137	558	6.254 782	1277
6.237 002	950	6.238 346	623	6.240 474	186	6.241 904	1024	6.243 106	810	6.245 052	1362	6.253 163	558	6.254 783	367
6.237 003	950	6.238 361	1331	6.240 475	1382	6.241 919	1058	6.243 107	630	6.246 006	663	6.253 164	1507	6.254 785	139
6.237 057	1305	6.238 362	1331	6.240 475	1386	6.241 927	1147	6.243 107	810	6.246 007	663	6.253 256	619	6.254 785	549
6.237 070	708	6.238 379	1253	6.240 479	717	6.241 936	711	6.243 114	631	6.246 008	663	6.253 276	1389	6.254 786	139
6.237 071	708	6.238 426	354	6.240 492	304	6.241 945	431	6.243 114	826	6.246 009	663	6.253 281	1389	6.254 786	549
6.237 129	1401	6.238 472	618	6.240 509	615	6.241 958	953	6.243 115	631	6.246 010	663	6.253 290	1513	6.254 839	1023
6.237 141	1143	6.238 473	1025	6.240 516	631	6.241 959	953	6.243 115	826	6.246 011	663	6.253 291	1513	6.254 865	823
6.237 145	157	6.238 474	1028												

Bestellnummernindex - Numerical index - Index numérique - Índice Numérico - Indice numerico - Indeks numerów katalogowych - Указатель по номерам

6.255 819	188	6.258 034	1305	6.260 043	758	6.261 959	42	6.263 457	478	6.263 661	533	6.265 027	551	6.265 623	317
6.255 819	787	6.258 092	1483	6.260 044	758	6.261 960	42	6.263 458	478	6.263 665	535	6.265 028	551	6.265 636	337
6.255 826	132	6.258 123	1390	6.260 046	758	6.261 977	1343	6.263 459	478	6.263 666	535	6.265 029	551	6.265 638	1367
6.255 833	678	6.258 150	624	6.260 091	758	6.262 080	304	6.263 460	889	6.263 670	853	6.265 030	551	6.265 639	1367
6.255 923	646	6.258 176	1112	6.260 422	922	6.262 099	47	6.263 461	889	6.263 671	853	6.265 031	551	6.265 640	1367
6.255 961	1483	6.258 218	1127	6.260 423	922	6.262 104	101	6.263 462	889	6.263 672	853	6.265 032	551	6.265 641	1367
6.256 027	1276	6.258 228	635	6.260 428	443	6.262 140	604	6.263 463	889	6.263 673	853	6.265 033	120	6.265 646	42
6.256 038	1329	6.258 234	602	6.260 430	1458	6.262 160	1513	6.263 464	889	6.263 675	853	6.265 034	120	6.265 647	42
6.256 041	768	6.258 235	1036	6.260 435	293	6.262 268	747	6.263 465	889	6.263 676	853	6.265 035	546	6.265 648	42
6.256 131	187	6.258 239	1115	6.260 453	199	6.262 275	983	6.263 466	889	6.263 677	853	6.265 036	546	6.265 649	42
6.256 301	1266	6.258 244	624	6.260 454	863	6.262 289	1482	6.263 467	889	6.263 678	853	6.265 037	551	6.265 649	563
6.256 325	223	6.258 266	568	6.260 459	561	6.262 306	1098	6.263 468	889	6.263 685	443	6.265 038	551	6.265 650	42
6.256 339	431	6.258 267	568	6.260 493	47	6.262 314	1276	6.263 469	889	6.263 686	443	6.265 039	551	6.265 650	563
6.256 388	93	6.258 268	600	6.260 495	575	6.262 319	187	6.263 482	527	6.263 690	299	6.265 040	551	6.265 651	42
6.256 393	284	6.258 269	602	6.260 509	602	6.262 337	791	6.263 483	527	6.263 691	299	6.265 041	551	6.265 651	563
6.256 423	995	6.258 271	602	6.260 542	560	6.262 343	983	6.263 484	527	6.263 692	299	6.265 042	551	6.265 652	42
6.256 437	710	6.258 273	602	6.260 543	560	6.262 379	106	6.263 485	527	6.263 693	299	6.265 043	551	6.265 652	563
6.256 440	469	6.258 299	731	6.260 544	561	6.262 379	862	6.263 486	527	6.263 694	299	6.265 044	551	6.265 653	42
6.256 441	469	6.258 299	1471	6.260 570	1490	6.262 417	290	6.263 487	527	6.263 695	299	6.265 045	120	6.265 653	563
6.256 482	719	6.258 335	489	6.260 573	1311	6.262 421	370	6.263 488	539	6.263 696	299	6.265 046	120	6.265 654	42
6.256 488	690	6.258 368	1134	6.260 676	1201	6.262 424	370	6.263 489	539	6.263 697	299	6.265 047	546	6.265 654	563
6.256 646	905	6.258 369	1134	6.260 677	1353	6.262 467	375	6.263 490	497	6.263 699	514	6.265 048	546	6.265 655	42
6.256 766	1458	6.258 373	1306	6.260 678	1353	6.262 477	384	6.263 491	497	6.263 700	514	6.265 049	551	6.265 655	563
6.256 805	345	6.258 375	1134	6.260 763	324	6.262 509	348	6.263 494	527	6.263 817	1164	6.265 050	551	6.265 656	42
6.256 809	508	6.258 376	1134	6.260 786	377	6.262 513	1446	6.263 495	527	6.263 842	406	6.265 051	551	6.265 656	563
6.256 816	508	6.258 408	286	6.260 874	1382	6.262 520	928	6.263 496	527	6.263 886	691	6.265 052	551	6.265 657	694
6.256 893	123	6.258 446	1013	6.260 903	251	6.262 521	928	6.263 497	527	6.263 886	1414	6.265 053	121	6.265 657	1413
6.256 893	552	6.258 527	536	6.260 922	567	6.262 522	928	6.263 498	527	6.263 887	691	6.265 054	121	6.265 658	694
6.256 894	123	6.258 570	1372	6.260 923	567	6.262 523	928	6.263 499	527	6.263 887	1414	6.265 055	551	6.265 658	1413
6.256 894	552	6.258 620	427	6.260 924	567	6.262 524	928	6.263 510	664	6.263 888	691	6.265 056	551	6.265 659	694
6.256 895	123	6.258 663	1127	6.260 925	567	6.262 525	928	6.263 511	664	6.263 888	1414	6.265 057	551	6.265 659	1413
6.256 895	552	6.258 682	624	6.260 926	567	6.262 526	928	6.263 515	664	6.263 897	673	6.265 058	551	6.265 660	694
6.256 896	123	6.258 683	632	6.260 928	292	6.262 527	928	6.263 516	664	6.263 911	980	6.265 059	121	6.265 660	1413
6.256 896	552	6.258 684	632	6.260 949	904	6.262 528	928	6.263 520	664	6.263 912	980	6.265 060	121	6.265 661	694
6.256 897	123	6.258 685	632	6.261 010	140	6.262 529	928	6.263 521	664	6.263 913	980	6.265 061	547	6.265 661	1413
6.256 897	552	6.258 692	641	6.261 010	1383	6.262 530	928	6.263 530	665	6.263 914	980	6.265 062	547	6.265 662	694
6.256 898	123	6.258 693	641	6.261 011	140	6.262 531	928	6.263 531	665	6.263 915	980	6.265 142	1134	6.265 662	1413
6.256 898	552	6.258 695	641	6.261 011	1383	6.262 532	928	6.263 535	665	6.264 000	1055	6.265 153	1202	6.265 663	694
6.256 954	66	6.258 697	641	6.261 028	1459	6.262 646	609	6.263 540	1043	6.264 055	781	6.265 178	879	6.265 663	1413
6.256 960	1309	6.258 698	641	6.261 029	1459	6.262 659	791	6.263 541	1043	6.264 057	348	6.265 179	879	6.265 664	694
6.256 961	1309	6.258 699	641	6.261 030	1459	6.262 660	791	6.263 542	1043	6.264 066	772	6.265 180	879	6.265 664	1413
6.256 963	1309	6.258 714	47	6.261 031	1459	6.262 685	898	6.263 543	1043	6.264 079	171	6.265 181	879	6.265 665	694
6.256 964	1309	6.258 794	53	6.261 033	602	6.262 704	1483	6.263 544	1043	6.264 087	1103	6.265 183	879	6.265 665	1413
6.256 965	1309	6.258 819	1457	6.261 058	1307	6.262 718	935	6.263 546	1043	6.264 147	446	6.265 184	879	6.265 666	694
6.257 002	363	6.258 821	25	6.261 152	367	6.262 810	788	6.263 547	1043	6.264 156	1045	6.265 200	1515	6.265 666	1413
6.257 034	201	6.258 822	25	6.261 212	1169	6.262 848	370	6.263 548	1043	6.264 198	420	6.265 201	1515	6.265 667	562
6.257 035	201	6.258 823	25	6.261 218	1013	6.262 862	674	6.263 550	1043	6.264 198	1213	6.265 202	1515	6.265 668	562
6.257 135	284	6.258 824	25	6.261 219	1013	6.262 867	983	6.263 551	1043	6.264 212	1134	6.265 203	1515	6.265 688	1003
6.257 139	1442	6.258 825	25	6.261 220	1013	6.262 868	983	6.263 552	1043	6.264 279	1322	6.265 204	1515	6.265 689	1003
6.257 142	363	6.258 826	25	6.261 221	1013	6.262 869	983	6.263 553	1043	6.264 316	828	6.265 205	1516	6.265 691	1003
6.257 162	616	6.258 827	25	6.261 222	1013	6.262 931	64	6.263 554	1043	6.264 322	1339	6.265 211	905	6.265 700	494
6.257 173	815	6.258 933	354	6.261 223	1013	6.262 932	64	6.263 560	205	6.264 323	1339	6.265 212	1157	6.265 701	604
6.257 184	1374	6.258 988	345	6.261 226	1383	6.262 943	1511	6.263 560	1185	6.264 449	1481	6.265 213	1157	6.265 732	119
6.257 202	757	6.258 999	823	6.261 238	283	6.262 966	716	6.263 570	865	6.264 452	445	6.265 214	692	6.265 733	43
6.257 218	640	6.259 057	422	6.261 313	911	6.262 991	302	6.263 571	865	6.264 468	788	6.265 214	1411	6.265 747	968
6.257 221	1368	6.259 079	880	6.261 314	911	6.263 025	1483	6.263 575	870	6.264 470	616	6.265 221	504	6.265 752	174
6.257 260	1516	6.259 080	880	6.261 315	911	6.263 037	330	6.263 580	1061	6.264 475	206	6.265 222	504	6.265 753	174
6.257 263	1309	6.259 082	880	6.261 316	911	6.263 047	1440	6.263 582	1078	6.264 543	1514	6.265 247	331	6.265 769	921
6.257 274	607	6.259 100	64	6.261 317	911	6.263 116	1208	6.263 585	1351	6.264 629	28	6.265 248	331	6.265 770	921
6.257 283	252	6.259 101	64	6.261 318	911	6.263 139	561	6.263 586	1351	6.264 631	206	6.265 249	331	6.265 771	921
6.257 283	1509	6.259 102	64	6.261 319	911	6.263 179	391	6.263 589	514	6.264 682	432	6.265 250	331	6.265 772	921
6.257 285	252	6.259 144	695	6.261 344	174	6.263 193	251	6.263 590	514	6.264 683	836	6.265 258	308	6.265 773	921
6.257 285	1509	6.259 209	1030	6.261 363	265	6.263 207	287	6.263 591	514	6.264 684	836	6.265 259	308	6.265 774	921
6.257 286	252	6.259 302	747	6.261 370	174	6.263 221	1312	6.263 592	514	6.264 685	836	6.265 260	308	6.265 775	921
6.257 286	1509	6.259 416	567	6.261 411	528	6.263 260	1134	6.263 593	514	6.264 686	837	6.265 261	308	6.265 798	758
6.257 287	252	6.259 417	567	6.261 420	962	6.263 282	554	6.263 594	514	6.264 687	837	6.265 262	308	6.265 799	758
6.257 287	1509	6.259 423	343	6.261 421	962	6.263 283	554	6.263 595	514	6.264 688	837	6.265 278	1312	6.265 800	758
6.257 288	252	6.259 428													

Bestellnummernindex - Numerical index - Index numérique - Índice Numérico - Índice numerico - Indeks numerów katalogowych - Указатель по номерам

6.266 243	772	6.266 867	1436	6.267 273	287	6.267 484	542	6.268 024	1238	6.269 371	659	6.270 348	283	6.271 008	1361
6.266 285	962	6.266 868	1437	6.267 275	287	6.267 484	1212	6.268 025	1238	6.269 400	93	6.270 366	221	6.271 009	1361
6.266 302	560	6.266 871	1439	6.267 277	287	6.267 485	542	6.268 048	1258	6.269 401	93	6.270 367	221	6.271 010	1361
6.266 303	560	6.266 872	1438	6.267 278	287	6.267 485	1212	6.268 091	1343	6.269 402	93	6.270 368	221	6.271 011	1361
6.266 304	560	6.266 873	134	6.267 279	293	6.267 486	542	6.268 092	1343	6.269 403	93	6.270 369	221	6.271 013	1361
6.266 305	560	6.266 874	134	6.267 293	1183	6.267 486	1212	6.268 093	1343	6.269 404	93	6.270 392	69	6.271 018	1361
6.266 306	898	6.266 875	134	6.267 294	1183	6.267 487	542	6.268 112	572	6.269 405	93	6.270 393	351	6.272 008	919
6.266 314	854	6.266 876	134	6.267 295	1183	6.267 487	1212	6.268 113	572	6.269 414	663	6.270 403	691	6.272 009	1297
6.266 315	363	6.266 877	134	6.267 296	1183	6.267 488	542	6.268 114	572	6.269 487	1494	6.270 403	1413	6.272 014	1317
6.266 337	867	6.266 878	134	6.267 297	1183	6.267 488	1212	6.268 116	572	6.269 500	1018	6.270 404	691	6.272 015	1338
6.266 417	1203	6.266 879	134	6.267 298	1183	6.267 489	542	6.268 117	572	6.269 501	1018	6.270 404	1413	6.272 016	1338
6.266 418	1203	6.266 880	134	6.267 315	585	6.267 489	1212	6.268 118	572	6.269 502	1018	6.270 405	691	6.272 017	1338
6.266 419	1203	6.266 881	134	6.267 317	476	6.267 490	542	6.268 119	572	6.269 503	1018	6.270 405	1413	6.272 018	1338
6.266 420	1203	6.266 882	1531	6.267 318	476	6.267 490	1212	6.268 120	572	6.269 504	1018	6.270 419	351	6.272 030	1302
6.266 423	968	6.266 883	1438	6.267 343	747	6.267 491	542	6.268 121	572	6.269 505	1018	6.270 420	951	6.272 031	1302
6.266 426	1195	6.266 884	1531	6.267 346	1223	6.267 491	1212	6.268 122	572	6.269 506	1018	6.270 421	951	6.272 032	1302
6.266 427	1195	6.266 885	1531	6.267 347	1223	6.267 492	542	6.268 123	572	6.269 507	1018	6.270 422	951	6.272 034	1304
6.266 428	1195	6.266 886	1531	6.267 348	1223	6.267 492	1212	6.268 124	572	6.269 508	551	6.270 423	951	6.272 047	135
6.266 429	1195	6.266 887	1531	6.267 353	1160	6.267 493	542	6.268 125	572	6.269 509	551	6.270 424	951	6.272 048	135
6.266 430	1195	6.266 888	1531	6.267 361	50	6.267 493	1212	6.268 126	572	6.269 510	551	6.270 425	951	6.272 049	134
6.266 431	1195	6.266 889	1531	6.267 362	109	6.267 494	542	6.268 127	572	6.269 511	551	6.270 426	951	6.272 050	134
6.266 432	1195	6.266 890	1214	6.267 363	109	6.267 494	1212	6.268 128	572	6.269 512	551	6.270 427	951	6.272 051	134
6.266 433	1195	6.266 893	364	6.267 364	109	6.267 495	542	6.268 129	572	6.269 513	551	6.270 443	1273	6.272 052	134
6.266 434	1195	6.266 904	1182	6.267 376	106	6.267 495	1212	6.268 130	572	6.269 514	551	6.270 479	262	6.272 053	134
6.266 435	1195	6.266 905	1135	6.267 377	106	6.267 496	542	6.268 193	370	6.269 515	551	6.270 501	1512	6.272 053	1325
6.266 436	1195	6.266 906	1130	6.267 378	106	6.267 496	1212	6.268 195	370	6.269 584	212	6.270 502	1512	6.272 060	1108
6.266 437	1196	6.266 907	1097	6.267 379	105	6.267 497	542	6.268 196	370	6.269 585	212	6.270 503	1512	6.272 061	1532
6.266 438	1196	6.266 908	1103	6.267 380	105	6.267 497	1212	6.268 198	370	6.269 586	212	6.270 504	1512	6.272 062	1532
6.266 439	1196	6.266 909	202	6.267 381	105	6.267 498	542	6.268 199	370	6.269 587	212	6.270 505	1512	6.272 063	1532
6.266 440	1196	6.266 910	405	6.267 382	111	6.267 498	1212	6.268 201	371	6.269 588	212	6.270 514	1335	6.272 064	1532
6.266 441	1196	6.266 911	405	6.267 383	111	6.267 499	542	6.268 202	371	6.269 589	212	6.270 531	66	6.272 067	1405
6.266 442	1196	6.266 912	406	6.267 384	111	6.267 499	1212	6.268 203	371	6.269 590	212	6.270 534	71	6.272 068	1404
6.266 443	1196	6.266 913	406	6.267 385	119	6.267 506	169	6.268 204	371	6.269 621	134	6.270 535	71	6.272 069	1404
6.266 444	1196	6.266 914	300	6.267 386	119	6.267 506	763	6.268 205	371	6.269 622	134	6.270 536	71	6.272 088	1057
6.266 448	1196	6.266 915	302	6.267 387	119	6.267 517	169	6.268 206	371	6.269 622	1325	6.270 548	309	6.272 088	1459
6.266 457	1196	6.266 923	1439	6.267 394	128	6.267 517	763	6.268 207	371	6.269 644	367	6.270 549	334	6.272 089	1057
6.266 458	1196	6.266 980	1112	6.267 395	152	6.267 518	169	6.268 208	364	6.269 657	32	6.270 566	507	6.272 089	1057
6.266 515	1008	6.266 981	1112	6.267 404	1183	6.267 518	763	6.268 210	364	6.269 685	916	6.270 569	170	6.272 090	1459
6.266 530	1138	6.266 984	642	6.267 406	1096	6.267 562	380	6.268 212	364	6.269 725	1111	6.270 572	446	6.272 090	1459
6.266 542	561	6.266 985	655	6.267 407	1094	6.267 578	1201	6.268 213	364	6.269 737	907	6.270 591	360	6.272 091	1057
6.266 568	1178	6.266 986	655	6.267 409	190	6.267 579	1200	6.268 215	364	6.269 737	1083	6.270 615	1308	6.272 091	1459
6.266 573	1353	6.266 990	1178	6.267 410	190	6.267 600	542	6.268 218	364	6.269 738	907	6.270 627	67	6.272 092	1057
6.266 574	1353	6.266 991	1178	6.267 411	1392	6.267 600	1212	6.268 220	364	6.269 738	1083	6.270 628	67	6.272 092	1459
6.266 590	555	6.267 058	1208	6.267 412	37	6.267 601	542	6.268 222	364	6.269 765	871	6.270 629	67	6.272 093	1057
6.266 611	831	6.267 059	1208	6.267 413	37	6.267 601	1212	6.268 223	364	6.269 767	1195	6.270 630	67	6.272 093	1459
6.266 640	249	6.267 061	1208	6.267 420	1232	6.267 602	542	6.268 225	364	6.269 768	667	6.270 631	67	6.272 094	1057
6.266 641	249	6.267 065	1544	6.267 421	1232	6.267 602	1212	6.268 226	364	6.269 779	252	6.270 632	241	6.272 094	1459
6.266 642	249	6.267 066	1544	6.267 422	1232	6.267 603	542	6.268 240	938	6.269 779	1509	6.270 633	241	6.272 095	1057
6.266 643	249	6.267 111	1439	6.267 423	1232	6.267 603	1212	6.268 240	1345	6.269 788	757	6.270 634	241	6.272 095	1459
6.266 644	249	6.267 112	1439	6.267 424	1224	6.267 606	1232	6.268 289	202	6.269 789	757	6.270 635	241	6.272 096	1057
6.266 645	307	6.267 115	1441	6.267 425	1224	6.267 608	1221	6.268 358	233	6.269 790	757	6.270 636	241	6.272 096	1459
6.266 646	307	6.267 116	1442	6.267 426	1224	6.267 609	1221	6.268 359	233	6.269 819	1362	6.270 637	241	6.272 097	1057
6.266 668	1175	6.267 117	1443	6.267 427	1224	6.267 610	1221	6.268 360	233	6.269 820	1362	6.270 638	241	6.272 097	1459
6.266 669	1175	6.267 121	1444	6.267 428	1224	6.267 611	1221	6.268 361	233	6.269 841	85	6.270 639	241	6.272 098	1057
6.266 670	1175	6.267 122	1446	6.267 429	1224	6.267 613	1221	6.268 389	1053	6.269 868	292	6.270 640	241	6.272 098	1459
6.266 671	1175	6.267 124	1450	6.267 430	1224	6.267 614	1221	6.268 391	1053	6.269 871	823	6.270 667	319	6.272 099	1057
6.266 672	1175	6.267 125	1450	6.267 431	1224	6.267 615	1221	6.268 393	1053	6.269 900	1238	6.270 720	1448	6.272 099	1459
6.266 673	1175	6.267 126	1450	6.267 432	1224	6.267 616	1221	6.268 399	1401	6.269 901	1238	6.270 721	1448	6.272 133	1283
6.266 674	1176	6.267 127	1450	6.267 433	1224	6.267 617	1221	6.268 419	1510	6.269 902	1238	6.270 726	1357	6.272 134	1283
6.266 675	1176	6.267 132	426	6.267 434	1224	6.267 618	1221	6.268 457	690	6.269 927	1238	6.270 828	1096	6.272 135	1283
6.266 676	1175	6.267 133	426	6.267 435	1224	6.267 619	1222	6.268 477	1100	6.269 936	1238	6.270 829	1096	6.272 136	1282
6.266 677	1175	6.267 134	426	6.267 436	1223	6.267 620	1222	6.268 478	1100	6.269 941	1238	6.270 830	900	6.272 137	1282
6.266 678	1175	6.267 135	426	6.267 437	1223	6.267 621	1222	6.268 487	139	6.269 943	1238	6.270 850	515	6.272 138	1282
6.266 679	945	6.267 136	426	6.267 438	1226	6.267 622	1222	6.268 487	1500	6.269 965	1238	6.270 862	1367	6.272 139	1282
6.266 680	945	6.267 137	426	6.267 439	1226	6.267 623	1222	6.268 500	1121	6.269 981	1238	6.270 863	1367	6.272 140	1282
6.266 681	945	6.267 138	426	6.267 440	1226	6.267 641	1289	6.268 605	679	6.270 012	1202	6.270 910	292	6.272 141	1282
6.266 682	945	6.267 139	426	6.267 441	1226										

Bestellnummernindex - Numerical index - Index numérique - Índice Numérico - Índice numerico - Indeks numerów katalogowych - Указатель по номерам

6.272 208	927	6.272 537	78	6.273 879	995	6.280 107	334	6.281 113	1411	6.281 845	330	6.282 777	1315	6.283 693	1145
6.272 209	927	6.272 562	1102	6.273 880	995	6.280 108	334	6.281 114	691	6.281 890	828	6.282 778	1315	6.283 694	787
6.272 210	927	6.272 569	378	6.273 881	995	6.280 109	334	6.281 114	1411	6.281 895	338	6.282 779	1315	6.283 706	351
6.272 211	927	6.272 603	440	6.273 897	751	6.280 111	304	6.281 115	691	6.281 917	1395	6.282 788	250	6.283 708	351
6.272 212	927	6.272 630	286	6.273 964	1130	6.280 112	304	6.281 115	1411	6.281 967	934	6.282 789	250	6.283 709	351
6.272 213	927	6.272 640	729	6.273 997	189	6.280 113	304	6.281 131	673	6.281 968	934	6.282 790	250	6.283 710	351
6.272 214	927	6.272 640	1469	6.274 030	1100	6.280 114	304	6.281 158	759	6.282 022	379	6.282 791	249	6.283 719	1045
6.272 215	927	6.272 641	729	6.274 041	1079	6.280 115	330	6.281 159	759	6.282 104	1362	6.282 792	249	6.283 762	999
6.272 216	927	6.272 641	1469	6.274 057	1315	6.280 116	330	6.281 160	759	6.282 108	42	6.282 793	249	6.283 763	999
6.272 224	436	6.272 642	729	6.274 088	604	6.280 117	330	6.281 161	759	6.282 108	563	6.282 794	252	6.283 764	999
6.272 235	898	6.272 642	1469	6.274 227	1164	6.280 118	340	6.281 163	759	6.282 144	1000	6.282 795	252	6.283 765	999
6.272 241	1542	6.272 643	729	6.274 262	877	6.280 119	340	6.281 166	759	6.282 145	1000	6.282 796	247	6.283 766	999
6.272 242	1542	6.272 643	1469	6.274 315	100	6.280 120	340	6.281 167	759	6.282 146	1000	6.282 797	251	6.283 768	999
6.272 243	1542	6.272 711	1307	6.274 342	611	6.280 155	1258	6.281 169	759	6.282 147	1000	6.282 798	251	6.283 770	999
6.272 244	1542	6.272 762	401	6.274 362	1414	6.280 201	1195	6.281 170	759	6.282 148	1453	6.282 799	251	6.283 773	999
6.272 245	1542	6.272 774	1204	6.274 363	1414	6.280 202	1196	6.281 172	759	6.282 149	1453	6.282 811	368	6.283 775	999
6.272 246	382	6.272 800	1397	6.274 373	1280	6.280 220	1398	6.281 173	759	6.282 150	1453	6.282 841	1442	6.283 777	999
6.272 247	382	6.272 801	1397	6.274 399	864	6.280 242	622	6.281 175	200	6.282 151	1453	6.282 843	679	6.283 779	999
6.272 248	382	6.272 802	729	6.274 399	1362	6.280 246	560	6.281 178	201	6.282 195	761	6.282 852	813	6.283 781	999
6.272 250	1209	6.272 802	1469	6.274 401	1113	6.280 268	871	6.281 268	561	6.282 267	1329	6.282 866	223	6.283 783	999
6.272 251	1209	6.272 803	729	6.274 454	1053	6.280 269	868	6.281 269	561	6.282 275	1009	6.282 919	351	6.283 784	999
6.272 252	1209	6.272 803	1469	6.274 501	575	6.280 284	857	6.281 344	356	6.282 276	1009	6.282 965	591	6.283 838	1107
6.272 253	1209	6.272 804	729	6.274 521	657	6.280 289	871	6.281 345	356	6.282 277	1009	6.282 978	351	6.283 846	591
6.272 254	1209	6.272 804	1469	6.274 532	868	6.280 290	868	6.281 346	356	6.282 278	1009	6.282 979	351	6.283 865	787
6.272 255	1209	6.272 805	729	6.274 555	1208	6.280 291	868	6.281 347	356	6.282 279	1009	6.282 980	351	6.283 866	787
6.272 256	1209	6.272 805	1469	6.274 591	1461	6.280 292	857	6.281 348	356	6.282 280	1009	6.283 036	262	6.283 913	53
6.272 257	1209	6.272 806	729	6.274 619	613	6.280 293	868	6.281 349	356	6.282 329	840	6.283 037	262	6.283 913	792
6.272 258	1209	6.272 806	1469	6.274 756	389	6.280 295	857	6.281 350	356	6.282 379	1045	6.283 062	857	6.283 914	53
6.272 259	1209	6.272 807	729	6.274 832	1070	6.280 296	857	6.281 351	356	6.282 405	321	6.283 064	1127	6.283 914	792
6.272 260	1209	6.272 807	1469	6.274 836	968	6.280 298	13	6.281 352	356	6.282 418	508	6.283 092	1134	6.283 967	1010
6.272 261	1209	6.272 808	729	6.274 868	665	6.280 318	174	6.281 353	356	6.282 424	25	6.283 100	1145	6.283 968	1010
6.272 262	1209	6.272 808	1469	6.274 875	501	6.280 319	174	6.281 354	356	6.282 436	406	6.283 101	1145	6.283 969	1010
6.272 263	1209	6.272 809	729	6.274 940	479	6.280 320	174	6.281 355	356	6.282 438	546	6.283 109	1145	6.283 970	1010
6.272 264	1209	6.272 809	1469	6.274 944	1466	6.280 321	174	6.281 356	356	6.282 439	546	6.283 118	876	6.283 971	1010
6.272 265	1209	6.272 810	729	6.274 985	830	6.280 325	174	6.281 357	356	6.282 440	546	6.283 119	876	6.283 972	1010
6.272 266	1209	6.272 810	1469	6.274 986	830	6.280 326	174	6.281 358	356	6.282 441	546	6.283 120	876	6.283 976	1010
6.272 267	1209	6.272 811	729	6.274 987	830	6.280 327	175	6.281 359	356	6.282 442	546	6.283 121	876	6.283 977	1010
6.272 268	1209	6.272 811	1469	6.274 988	830	6.280 330	290	6.281 360	356	6.282 443	546	6.283 206	453	6.283 978	1010
6.272 269	1209	6.272 812	729	6.274 989	830	6.280 334	1053	6.281 361	356	6.282 444	546	6.283 249	1042	6.283 979	1010
6.272 270	1209	6.272 812	1469	6.274 992	380	6.280 337	857	6.281 362	356	6.282 445	546	6.283 261	738	6.283 980	1010
6.272 271	1209	6.272 813	729	6.274 993	904	6.280 344	1238	6.281 363	356	6.282 446	546	6.283 263	1445	6.283 981	1010
6.272 272	1209	6.272 813	1469	6.275 022	772	6.280 362	857	6.281 364	356	6.282 447	557	6.283 264	1223	6.284 026	735
6.272 273	1209	6.272 816	729	6.275 025	1466	6.280 403	1024	6.281 365	356	6.282 448	557	6.283 265	1223	6.284 047	1214
6.272 274	1209	6.272 816	1469	6.275 026	644	6.280 404	1024	6.281 366	356	6.282 449	557	6.283 266	1223	6.284 078	489
6.272 275	1209	6.272 817	729	6.275 093	580	6.280 405	1024	6.281 378	1148	6.282 450	557	6.283 267	1223	6.284 083	438
6.272 276	1209	6.272 817	1469	6.275 186	901	6.280 425	1390	6.281 380	309	6.282 451	557	6.283 268	1223	6.284 102	1214
6.272 277	1209	6.272 818	729	6.275 188	901	6.280 429	1017	6.281 401	557	6.282 452	546	6.283 269	1223	6.284 110	1329
6.272 278	1209	6.272 818	1469	6.275 263	440	6.280 441	864	6.281 402	557	6.282 453	546	6.283 270	1227	6.284 111	1329
6.272 279	1209	6.272 819	729	6.275 263	1106	6.280 450	298	6.281 417	716	6.282 454	546	6.283 271	1227	6.284 162	1079
6.272 280	1209	6.272 819	1469	6.275 353	129	6.280 453	283	6.281 467	1522	6.282 455	546	6.283 272	1221	6.284 214	1305
6.272 281	1209	6.272 839	974	6.275 380	1055	6.280 456	1191	6.281 468	1522	6.282 456	546	6.283 273	1221	6.284 227	360
6.272 282	1209	6.272 840	974	6.275 393	355	6.280 506	745	6.281 479	26	6.282 457	546	6.283 274	1221	6.284 228	360
6.272 283	1209	6.272 841	974	6.275 416	355	6.280 588	674	6.281 511	1171	6.282 458	546	6.283 275	1221	6.284 229	43
6.272 284	1209	6.272 846	1148	6.275 417	355	6.280 595	1461	6.281 512	1168	6.282 459	546	6.283 276	1221	6.284 248	209
6.272 285	1209	6.272 871	1444	6.275 418	355	6.280 597	865	6.281 513	1171	6.282 460	546	6.283 277	1230	6.284 249	209
6.272 286	1210	6.272 895	857	6.275 419	355	6.280 645	1156	6.281 514	1171	6.282 461	546	6.283 278	1230	6.284 262	1217
6.272 287	1210	6.272 936	1200	6.275 420	355	6.280 680	1158	6.281 515	1171	6.282 488	1105	6.283 279	1230	6.284 263	1217
6.272 327	815	6.272 938	1200	6.275 421	355	6.280 728	821	6.281 516	1171	6.282 520	864	6.283 280	1230	6.284 264	1217
6.272 328	815	6.272 951	286	6.275 422	355	6.280 786	1344	6.281 517	1172	6.282 520	1362	6.283 281	1230	6.284 265	1217
6.272 329	814	6.272 953	286	6.275 423	355	6.280 788	1156	6.281 518	1172	6.282 521	864	6.283 282	1230	6.284 308	303
6.272 330	814	6.272 964	591	6.275 481	1112	6.280 859	259	6.281 519	1172	6.282 521	1362	6.283 283	1230	6.284 310	1344
6.272 331	814	6.272 965	246	6.275 482	1112	6.280 866	180	6.281 520	1172	6.282 522	864	6.283 296	518	6.284 369	905
6.272 332	801	6.272 966	246	6.275 499	357	6.280 873	1451	6.281 521	1172	6.282 522	1362	6.283 298	518	6.284 401	783
6.272 334	802	6.273 013	1391	6.275 587	368	6.280 874	812	6.281 522	1172	6.282 523	864	6.283 309	351	6.284 402	775
6.272 335	802	6.273 032	575	6.275 588	368	6.280 880	283	6.281 537	383	6.282 523	1362	6.283 313	1443	6.284 403	775
6.272 336	802	6.273 071	426	6.275 589	368	6.280 900	1278	6.281 538	1013	6.282 524	864	6.283 386	787	6.284 404	775
6.272 337	802	6.273 133	656	6.275 805	857	6.280 910	127	6.281 539	1013	6.					

Bestellnummernindex - Numerical index - Index numérique - Índice Numérico - Índice numerico - Indeks numerów katalogowych - Указатель по номерам

6.284 477	223	6.284 901	303	6.285 783	1105	6.286 226	290	6.286 763	764	6.287 311	737	6.287 740	275	6.288 696	976
6.284 478	223	6.284 902	310	6.285 802	575	6.286 248	324	6.286 764	168	6.287 312	737	6.287 740	1547	6.288 697	976
6.284 479	223	6.284 903	310	6.285 813	258	6.286 270	284	6.286 764	764	6.287 313	738	6.287 741	275	6.288 698	976
6.284 480	223	6.284 904	310	6.285 814	258	6.286 282	1381	6.286 765	168	6.287 314	738	6.287 741	1547	6.288 699	976
6.284 481	223	6.284 905	310	6.285 815	258	6.286 283	1381	6.286 765	764	6.287 329	1368	6.287 742	275	6.288 700	976
6.284 482	223	6.284 906	329	6.285 816	874	6.286 284	1381	6.286 766	168	6.287 339	739	6.287 742	1547	6.288 715	622
6.284 483	223	6.284 935	280	6.285 816	1365	6.286 285	1381	6.286 766	764	6.287 340	739	6.287 743	275	6.288 723	223
6.284 484	223	6.284 954	790	6.285 817	874	6.286 307	1356	6.286 767	168	6.287 341	739	6.287 743	1547	6.288 724	223
6.284 485	223	6.284 958	205	6.285 817	1365	6.286 307	1461	6.286 767	764	6.287 342	739	6.287 744	275	6.288 768	1003
6.284 486	223	6.284 960	1490	6.285 821	874	6.286 311	191	6.286 768	168	6.287 343	739	6.287 744	1547	6.288 852	824
6.284 487	223	6.284 968	1097	6.285 821	1365	6.286 312	191	6.286 768	764	6.287 344	739	6.287 745	275	6.288 857	824
6.284 488	223	6.284 969	1097	6.285 822	874	6.286 315	898	6.286 769	169	6.287 345	739	6.287 745	1547	6.288 854	824
6.284 489	223	6.285 006	960	6.285 822	1365	6.286 318	1102	6.286 769	764	6.287 346	739	6.287 746	275	6.288 856	824
6.284 490	223	6.285 049	402	6.285 823	874	6.286 324	1344	6.286 771	653	6.287 347	739	6.287 746	1547	6.288 857	824
6.284 491	223	6.285 151	436	6.285 823	1365	6.286 325	1344	6.286 773	601	6.287 348	739	6.287 747	276	6.288 859	824
6.284 492	223	6.285 189	509	6.285 824	874	6.286 326	1344	6.286 775	958	6.287 397	1144	6.287 748	275	6.288 861	824
6.284 493	223	6.285 190	517	6.285 824	1365	6.286 327	1344	6.286 777	1140	6.287 398	1144	6.287 748	1547	6.288 863	824
6.284 494	223	6.285 191	517	6.285 834	492	6.286 328	1344	6.286 789	1156	6.287 399	1146	6.287 749	275	6.288 864	824
6.284 495	223	6.285 207	135	6.285 840	1357	6.286 329	1344	6.286 790	1156	6.287 400	1146	6.287 749	1547	6.288 865	824
6.284 496	223	6.285 212	317	6.285 841	1357	6.286 330	1344	6.286 791	1156	6.287 401	1146	6.287 750	273	6.288 870	823
6.284 497	379	6.285 221	431	6.285 843	999	6.286 331	1344	6.286 792	1156	6.287 402	1146	6.287 751	273	6.288 956	274
6.284 504	314	6.285 222	431	6.285 844	999	6.286 332	1344	6.286 793	1151	6.287 413	717	6.287 752	273	6.288 957	274
6.284 505	314	6.285 223	431	6.285 869	921	6.286 333	1344	6.286 794	1151	6.287 426	1070	6.287 753	273	6.288 989	1200
6.284 512	353	6.285 224	431	6.285 884	1381	6.286 334	1344	6.286 795	1152	6.287 429	1068	6.287 754	273	6.289 099	1086
6.284 527	790	6.285 225	431	6.285 885	1381	6.286 335	1344	6.286 799	1511	6.287 436	884	6.287 755	273	6.289 108	34
6.284 537	553	6.285 226	431	6.285 887	1381	6.286 357	1357	6.286 800	1511	6.287 444	328	6.287 756	273	6.289 109	34
6.284 538	553	6.285 272	728	6.285 888	1381	6.286 375	1270	6.286 804	721	6.287 463	1199	6.287 757	272	6.289 110	34
6.284 539	553	6.285 291	1017	6.285 889	1381	6.286 380	1270	6.286 810	1236	6.287 481	675	6.287 758	272	6.289 111	34
6.284 540	553	6.285 336	716	6.285 890	1381	6.286 381	1270	6.286 811	1236	6.287 509	1452	6.287 759	272	6.289 112	34
6.284 541	551	6.285 347	1398	6.285 891	1381	6.286 408	49	6.286 812	1236	6.287 510	1452	6.287 760	272	6.289 147	144
6.284 542	551	6.285 348	1398	6.285 892	1381	6.286 409	49	6.286 813	1236	6.287 511	1452	6.287 774	1461	6.289 180	1403
6.284 543	123	6.285 431	229	6.285 897	1102	6.286 410	41	6.286 814	1236	6.287 512	1452	6.287 780	69	6.289 204	988
6.284 544	123	6.285 432	229	6.285 898	1102	6.286 411	41	6.286 815	1236	6.287 527	47	6.287 781	78	6.289 205	988
6.284 545	123	6.285 433	229	6.285 900	1102	6.286 412	41	6.286 816	1236	6.287 530	169	6.287 782	78	6.289 206	989
6.284 546	123	6.285 434	229	6.285 901	1102	6.286 413	41	6.286 817	1236	6.287 530	763	6.287 783	78	6.289 207	989
6.284 547	124	6.285 435	229	6.285 902	1104	6.286 414	41	6.286 818	1236	6.287 541	268	6.287 784	78	6.289 208	988
6.284 548	124	6.285 436	229	6.285 903	1104	6.286 415	41	6.286 819	1236	6.287 542	268	6.287 785	78	6.289 209	989
6.284 552	552	6.285 439	349	6.285 904	1104	6.286 416	41	6.286 820	1236	6.287 543	268	6.287 786	78	6.289 210	988
6.284 553	552	6.285 440	1414	6.285 906	1105	6.286 426	492	6.286 821	1236	6.287 544	1205	6.287 787	78	6.289 211	988
6.284 554	552	6.285 441	1414	6.285 907	1105	6.286 430	284	6.286 822	1236	6.287 548	1491	6.287 788	78	6.289 212	988
6.284 555	552	6.285 448	512	6.285 908	1105	6.286 453	433	6.286 823	1236	6.287 566	1214	6.287 789	78	6.289 213	988
6.284 556	552	6.285 460	237	6.285 913	1102	6.286 454	433	6.286 824	1236	6.287 567	1214	6.287 790	78	6.289 214	989
6.284 557	552	6.285 461	237	6.285 920	1105	6.286 455	433	6.286 834	169	6.287 568	1045	6.287 791	78	6.289 215	988
6.284 558	552	6.285 462	237	6.285 921	440	6.286 456	433	6.286 835	169	6.287 569	1045	6.287 792	78	6.289 216	988
6.284 559	547	6.285 463	238	6.285 922	440	6.286 457	433	6.286 836	169	6.287 570	1045	6.287 812	828	6.289 217	989
6.284 560	121	6.285 464	238	6.285 923	440	6.286 458	433	6.286 837	169	6.287 571	1045	6.287 813	75	6.289 218	989
6.284 561	121	6.285 465	238	6.285 924	440	6.286 459	1126	6.286 838	169	6.287 572	1045	6.287 814	75	6.289 219	988
6.284 562	124	6.285 489	324	6.285 925	440	6.286 460	1126	6.286 841	1261	6.287 577	1206	6.287 815	75	6.289 220	988
6.284 563	552	6.285 509	1016	6.285 926	440	6.286 461	1126	6.286 842	1261	6.287 585	1061	6.287 816	75	6.289 221	989
6.284 564	552	6.285 517	349	6.285 927	440	6.286 462	1135	6.286 844	1160	6.287 586	1061	6.287 820	673	6.289 223	988
6.284 565	552	6.285 528	214	6.285 928	440	6.286 463	1135	6.286 848	762	6.287 587	1061	6.287 822	1007	6.289 224	989
6.284 566	552	6.285 529	214	6.285 929	440	6.286 464	1135	6.286 850	1366	6.287 588	269	6.287 823	1007	6.289 225	988
6.284 567	552	6.285 530	214	6.285 930	440	6.286 465	1135	6.286 921	266	6.287 611	1352	6.287 824	1007	6.289 226	988
6.284 568	552	6.285 531	214	6.285 931	440	6.286 466	1135	6.286 923	702	6.287 612	1352	6.287 838	692	6.289 227	988
6.284 569	552	6.285 536	1439	6.285 932	440	6.286 468	1127	6.286 974	496	6.287 613	1352	6.287 838	1411	6.289 228	988
6.284 570	547	6.285 539	380	6.285 933	440	6.286 491	257	6.287 029	359	6.287 614	1352	6.287 839	692	6.289 229	988
6.284 571	121	6.285 586	710	6.285 934	440	6.286 492	257	6.287 085	1058	6.287 615	1378	6.287 839	1411	6.289 230	988
6.284 572	121	6.285 597	1289	6.285 935	1106	6.286 530	558	6.287 086	1058	6.287 658	814	6.287 840	1414	6.289 231	989
6.284 573	124	6.285 618	906	6.285 936	1106	6.286 539	292	6.287 087	1058	6.287 671	501	6.287 841	1414	6.289 232	989
6.284 607	963	6.285 619	1281	6.285 937	1106	6.286 540	292	6.287 088	1058	6.287 674	501	6.287 939	1128	6.289 233	989
6.284 614	961	6.285 620	1281	6.285 938	1106	6.286 541	292	6.287 089	1058	6.287 675	501	6.287 990	1458	6.289 234	989
6.284 633	544	6.285 621	1281	6.285 939	1106	6.286 542	292	6.287 090	1058	6.287 691	905	6.288 042	282	6.289 235	989
6.284 635	389	6.285 633	1290	6.285 940	1105	6.286 543	293	6.287 091	1058	6.287 692	900	6.288 043	282	6.289 236	989
6.284 640	170	6.285 634	1290	6.285 944	440	6.286 586	1374	6.287 092	1058	6.287 702	674	6.288 044	282	6.289 237	989
6.284 662	1247	6.285 635	1290	6.285 944	1106	6.286 593	51	6.287 093	1058	6.287 705	674	6.288 045	282	6.289 238	989
6.284 689	614	6.285 636	1290	6.285 946	1105	6.286 593	204	6.287 094	1058	6.287 709	674	6.288 046	282	6.289 239	989
6.284 693	566	6.285 637	1290	6.285 947	439	6.286 594	231	6.287 095	1058	6.287 713	674	6.288 047	282	6.289 240	

Bestellnummernindex - Numerical index - Index numérique - Índice Numérico - Índice numerico - Indeks numerów katalogowych - Указатель по номерам

6.290 142	301	6.291 333	1003	6.292 150	1001	6.304 322	225	6.311 086	238	6.312 228	300	6.313 766	554	6.323 052	245
6.290 214	599	6.291 334	1003	6.292 151	1001	6.304 378	828	6.311 087	238	6.312 243	260	6.313 789	857	6.324 668	202
6.290 215	599	6.291 335	1003	6.292 152	1001	6.304 822	1215	6.311 106	284	6.312 262	945	6.313 796	430	6.401 031	1275
6.290 219	599	6.291 336	1003	6.292 153	1001	6.304 828	1458	6.311 186	1256	6.312 280	1480	6.313 797	430	6.401 078	1408
6.290 220	599	6.291 337	1003	6.292 154	1001	6.304 882	980	6.311 247	1254	6.312 312	857	6.313 798	430	6.401 081	1408
6.290 221	599	6.291 338	1003	6.292 155	1001	6.304 933	157	6.311 248	1254	6.312 313	281	6.313 799	430	6.401 082	1408
6.290 228	1435	6.291 339	1003	6.292 157	1299	6.304 939	628	6.311 249	1256	6.312 314	281	6.313 800	1131	6.401 093	77
6.290 241	950	6.291 340	1003	6.292 158	1299	6.305 117	560	6.311 250	1254	6.312 381	953	6.313 801	1131	6.401 134	1408
6.290 246	950	6.291 341	1003	6.292 159	1299	6.305 235	1461	6.311 251	1255	6.312 417	286	6.313 802	1131	6.401 135	1408
6.290 247	950	6.291 342	1003	6.292 160	191	6.305 430	933	6.311 252	1255	6.312 440	135	6.313 803	429	6.401 199	1196
6.290 283	108	6.291 343	1003	6.292 161	191	6.305 666	1415	6.311 253	1255	6.312 441	125	6.313 804	429	6.401 203	623
6.290 324	1056	6.291 358	148	6.292 162	34	6.305 840	757	6.311 254	1255	6.312 442	125	6.313 805	429	6.401 212	117
6.290 331	974	6.291 359	148	6.292 163	34	6.305 865	1058	6.311 255	1256	6.312 443	118	6.313 808	435	6.401 224	428
6.290 364	1400	6.291 360	148	6.292 164	34	6.305 927	143	6.311 256	1256	6.312 450	196	6.313 809	435	6.401 235	212
6.290 428	438	6.291 361	148	6.292 165	34	6.306 078	828	6.311 259	1255	6.312 492	1239	6.313 810	435	6.401 256	178
6.290 477	951	6.291 401	1403	6.292 166	34	6.306 164	183	6.311 273	173	6.312 551	286	6.313 811	435	6.401 362	643
6.290 524	553	6.291 403	85	6.292 170	1360	6.306 275	621	6.311 291	669	6.312 571	876	6.313 812	435	6.401 390	185
6.290 525	553	6.291 404	85	6.292 172	1360	6.306 285	626	6.311 315	779	6.312 573	876	6.313 813	435	6.401 391	185
6.290 529	85	6.291 405	85	6.292 174	1360	6.306 286	621	6.311 317	779	6.312 578	875	6.313 816	801	6.401 428	624
6.290 544	857	6.291 406	85	6.292 175	228	6.306 510	1122	6.311 350	414	6.312 579	875	6.313 834	1478	6.401 432	654
6.290 570	495	6.291 407	85	6.292 176	228	6.306 550	655	6.311 351	414	6.312 665	129	6.313 835	1478	6.401 458	94
6.290 643	561	6.291 408	85	6.292 177	228	6.306 551	655	6.311 356	1056	6.312 879	1177	6.313 836	1478	6.401 505	757
6.290 645	999	6.291 409	85	6.292 178	228	6.306 619	835	6.311 382	1256	6.312 903	470	6.313 837	1478	6.401 549	115
6.290 651	999	6.291 413	92	6.292 207	1528	6.306 806	1058	6.311 419	693	6.312 904	470	6.313 838	1478	6.401 579	37
6.290 652	999	6.291 414	92	6.292 208	1528	6.307 040	647	6.311 419	1412	6.312 905	470	6.313 839	1478	6.401 582	40
6.290 653	999	6.291 415	92	6.292 209	1528	6.307 145	118	6.311 476	1235	6.312 923	270	6.313 840	1478	6.401 626	1365
6.290 654	999	6.291 416	92	6.292 210	1528	6.307 187	157	6.311 477	1235	6.312 924	270	6.313 841	1478	6.401 645	634
6.290 675	286	6.291 417	92	6.292 211	1528	6.307 233	980	6.311 478	1235	6.312 925	270	6.313 842	1478	6.401 676	739
6.290 709	1000	6.291 418	54	6.292 212	1528	6.307 252	178	6.311 479	1235	6.312 930	1283	6.313 843	1478	6.500 038	1319
6.290 737	1545	6.291 419	54	6.292 221	206	6.307 327	623	6.311 480	1235	6.312 931	1283	6.313 844	1478	6.510 003	994
6.290 742	1003	6.291 420	54	6.300 025	929	6.307 770	1319	6.311 510	479	6.312 964	723	6.313 845	1479	6.510 005	1365
6.290 771	1125	6.291 421	54	6.300 026	929	6.307 817	622	6.311 638	421	6.312 970	1374	6.313 846	1479	6.510 059	58
6.290 792	288	6.291 422	54	6.300 028	929	6.307 818	622	6.311 665	1070	6.312 988	898	6.313 863	786	6.510 118	189
6.290 853	792	6.291 473	359	6.300 066	95	6.307 819	622	6.311 675	1359	6.313 057	479	6.313 869	1102	6.510 172	1345
6.290 854	792	6.291 535	81	6.300 067	95	6.307 820	623	6.311 677	202	6.313 081	431	6.313 870	1102	6.510 180	912
6.290 868	196	6.291 536	81	6.300 104	1319	6.307 821	623	6.311 691	623	6.313 123	583	6.313 967	1142	6.510 181	912
6.290 896	834	6.291 537	75	6.300 151	640	6.307 822	623	6.311 698	228	6.313 125	584	6.313 968	1142	6.510 182	912
6.290 897	834	6.291 538	75	6.300 165	770	6.307 823	623	6.311 699	228	6.313 126	584	6.313 969	857	6.510 183	912
6.290 898	834	6.291 539	75	6.300 168	647	6.307 933	157	6.311 700	228	6.313 127	584	6.313 989	723	6.510 217	189
6.290 899	834	6.291 540	75	6.300 299	929	6.308 744	983	6.311 821	441	6.313 128	584	6.313 994	1200	6.510 242	857
6.290 900	834	6.291 543	1364	6.300 331	1244	6.308 831	980	6.311 824	260	6.313 129	584	6.314 040	1254	6.510 319	589
6.290 901	834	6.291 544	1364	6.300 334	1088	6.308 832	980	6.311 844	1200	6.313 130	584	6.314 041	1254	6.510 332	1332
6.290 902	772	6.291 545	1364	6.300 493	151	6.309 148	1402	6.311 871	510	6.313 131	584	6.314 042	1254	6.510 335	1345
6.290 909	676	6.291 546	1364	6.300 542	1058	6.309 953	718	6.311 880	513	6.313 132	584	6.314 043	1254	6.510 380	1155
6.290 910	676	6.291 547	1364	6.300 565	1214	6.310 019	906	6.311 881	513	6.313 133	584	6.314 044	1255	6.510 476	188
6.290 911	676	6.291 548	1364	6.300 696	1156	6.310 021	906	6.311 891	1498	6.313 134	584	6.314 045	1255	6.510 510	77
6.290 912	676	6.291 549	1364	6.300 788	110	6.310 023	906	6.311 892	1499	6.313 219	1259	6.314 046	1255	6.510 546	1339
6.290 917	1368	6.291 550	1364	6.300 903	1462	6.310 025	906	6.311 902	431	6.313 220	1268	6.314 047	1255	6.510 572	517
6.290 918	1368	6.291 551	1364	6.300 995	183	6.310 027	906	6.311 903	431	6.313 234	1074	6.314 060	589	6.510 709	1251
6.290 919	1368	6.291 552	1364	6.301 526	235	6.310 029	906	6.311 904	1149	6.313 274	323	6.314 255	857	6.510 723	1401
6.290 920	1368	6.291 553	1364	6.301 538	991	6.310 031	906	6.311 905	1149	6.313 297	1053	6.314 306	491	6.510 848	147
6.290 947	829	6.291 554	1364	6.301 574	162	6.310 033	906	6.311 906	1149	6.313 326	394	6.314 307	495	6.510 856	1406
6.290 968	829	6.291 558	1545	6.301 578	1458	6.310 035	906	6.311 907	1149	6.313 337	394	6.314 308	495	6.510 864	991
6.290 978	534	6.291 565	1280	6.301 604	991	6.310 037	906	6.311 908	1125	6.313 339	399	6.314 325	424	6.510 909	183
6.290 993	1074	6.291 566	1281	6.301 637	259	6.310 086	581	6.311 927	1075	6.313 342	394	6.314 326	436	6.700 111	1457
6.290 994	1074	6.291 567	1280	6.301 671	1318	6.310 090	288	6.311 932	1041	6.313 363	1096	6.314 327	1035	6.700 265	1475
6.290 995	1074	6.291 569	857	6.301 718	178	6.310 098	898	6.311 933	1041	6.313 389	1415	6.314 328	1118	6.700 320	1240
6.291 071	288	6.291 622	608	6.301 732	933	6.310 102	646	6.311 934	1041	6.313 390	1415	6.314 328	1392	6.700 374	1409
6.291 072	288	6.291 623	608	6.301 841	432	6.310 204	1003	6.311 937	1199	6.313 394	1295	6.314 339	1333	6.700 568	758
6.291 078	288	6.291 624	1016	6.301 853	1462	6.310 247	575	6.311 944	409	6.313 395	1415	6.314 340	1333	6.700 621	1243
6.291 079	288	6.291 635	1440	6.302 001	835	6.310 292	138	6.311 945	404	6.313 397	1415	6.314 452	723	6.700 747	1463
6.291 099	1128	6.291 636	1440	6.302 116	618	6.310 292	550	6.311 947	413	6.313 398	1296	6.314 459	1269	6.700 903	911
6.291 100	1128	6.291 637	1441	6.302 123	147	6.310 293	138	6.311 970	207	6.313 399	1296	6.314 551	997	6.701 105	1385
6.291 101	1128	6.291 638	1438	6.302 168	745	6.310 293	550	6.311 971	207	6.313 400	1296	6.314 566	432	6.701 243	1465
6.291 102	1128	6.291 640	1056	6.302 328	432	6.310 317	848	6.311 972	207	6.313 401	1292	6.314 706	69	6.701 260	673
6.291 103	1128	6.291 647	241	6.302 336	1354	6.310 318	848	6.311 973	207	6.313 402	1292	6.314 721	997	6.701 307	179
6.291 104	1128	6.291 648	241	6.302 391	904	6.310 319	848	6.312 033	210	6.313 403	1292	6.314 733			

Bestellnummernindex - Numerical index - Index numérique - Índice Numérico - Índice numerico - Indeks numerów katalogowych - Указатель по номерам

6.800 619	1214	6.802 657	24	6.901 670	339	7.010 153	744	7.019 393	694	7.053 349	755	7.078 351	644	7.210 063	1372
6.800 620	24	6.802 726	757	6.901 671	339	7.010 155	744	7.019 394	694	7.053 350	755	7.078 722	94	7.300 006	1408
6.800 620	1474	6.802 774	1243	6.901 743	43	7.010 157	744	7.019 395	694	7.053 593	1497	7.078 750	718	7.300 124	1407
6.800 621	24	6.802 809	45	6.901 758	157	7.010 158	744	7.019 396	694	7.053 700	1497	7.078 821	761	7.300 132	1246
6.800 621	1474	6.802 851	115	6.901 776	990	7.010 159	744	7.019 397	694	7.053 718	693	7.078 822	761	7.300 156	1407
6.800 626	1058	6.802 883	1495	6.901 799	623	7.010 160	744	7.019 398	694	7.053 930	44	7.078 912	728	7.300 174	1445
6.800 632	1088	6.802 901	339	6.901 807	557	7.010 161	744	7.019 622	476	7.053 933	44	7.079 006	712	7.300 175	1445
6.800 654	41	6.802 902	339	6.901 915	1408	7.010 166	744	7.019 623	476	7.054 037	1441	7.079 169	1498	7.300 197	1407
6.800 667	1087	6.802 957	632	6.902 044	1435	7.017 045	728	7.019 637	477	7.054 135	1500	7.079 366	755	7.300 202	109
6.800 729	1402	6.802 978	623	6.902 222	1463	7.017 048	728	7.019 638	477	7.054 161	23	7.079 380	715	7.300 223	263
6.800 733	185	6.802 999	1244	6.902 265	178	7.017 049	728	7.019 672	476	7.054 161	811	7.079 431	1466	7.300 224	263
6.800 771	771	6.803 027	844	6.902 303	1265	7.017 052	728	7.019 673	476	7.054 644	728	7.079 432	1466	7.300 349	755
6.800 824	1047	6.803 056	758	6.902 362	558	7.017 053	728	7.019 675	476	7.054 644	1391	7.079 463	715	7.300 358	715
6.800 848	1154	6.803 067	446	6.902 383	622	7.017 078	728	7.019 722	640	7.054 864	318	7.079 472	715	7.300 360	715
6.800 894	147	6.803 092	84	6.902 406	302	7.017 078	1391	7.019 920	101	7.055 116	85	7.079 496	185	7.300 388	1027
6.800 901	43	6.803 101	1339	6.902 419	1448	7.017 199	743	7.020 037	1060	7.055 383	107	7.079 505	1462	7.300 442	794
6.800 985	633	6.803 102	558	6.902 444	641	7.017 207	736	7.020 038	1060	7.055 486	1443	7.079 506	1462	7.300 555	1495
6.801 018	929	6.803 102	1234	6.902 445	641	7.017 212	735	7.020 105	1122	7.055 892	1490	7.079 535	183	7.300 557	755
6.801 019	929	6.803 126	980	6.902 461	990	7.017 213	735	7.020 111	1122	7.056 751	1448	7.079 547	1047	7.300 574	760
6.801 020	929	6.803 127	980	6.902 473	1226	7.017 296	743	7.020 270	1114	7.056 849	1499	7.079 563	1121	7.300 580	1407
6.801 021	929	6.803 130	740	6.902 504	723	7.017 297	743	7.020 271	1114	7.058 005	560	7.079 568	756	7.380 421	693
6.801 022	929	6.803 183	47	6.902 600	1459	7.017 319	741	7.020 271	1392	7.058 102	761	7.079 617	1465	7.380 422	693
6.801 023	929	6.803 185	991	6.902 601	1459	7.017 320	741	7.020 272	1114	7.058 103	761	7.079 677	1407	7.380 423	693
6.801 024	929	6.803 246	740	6.902 602	1459	7.017 321	741	7.020 277	1114	7.058 120	560	7.079 679	755	7.400 114	1410
6.801 037	1457	6.803 289	1243	6.902 603	1459	7.017 720	727	7.020 278	1114	7.058 142	1443	7.079 737	94	7.400 141	718
6.801 056	1244	6.803 320	1490	6.902 604	1459	7.017 726	724	7.020 281	1114	7.058 143	1444	7.079 766	715	7.400 160	145
6.801 073	24	6.803 323	688	6.902 605	1459	7.017 796	472	7.020 294	936	7.058 316	718	7.079 811	1374	7.400 375	1496
6.801 073	1474	6.803 324	688	7.008 136	323	7.017 797	472	7.020 295	936	7.058 640	94	7.079 854	63	7.400 417	104
6.801 103	995	6.803 325	688	7.008 185	316	7.018 326	1027	7.020 330	33	7.058 767	316	7.080 155	736	7.400 578	1497
6.801 137	1458	6.803 354	1022	7.008 211	326	7.018 327	1027	7.020 352	646	7.058 772	709	7.080 208	560	7.400 583	760
6.801 187	935	6.803 371	104	7.008 227	328	7.018 328	1027	7.021 151	100	7.059 541	1028	7.080 450	1447	7.400 585	1410
6.801 219	1153	6.803 384	1456	7.008 228	328	7.018 361	1023	7.021 152	100	7.059 572	147	7.080 947	1446	7.400 610	718
6.801 239	113	6.803 397	323	7.008 229	328	7.018 362	1023	7.021 153	100	7.059 654	101	7.081 774	1237	7.400 725	734
6.801 244	1441	6.803 543	621	7.008 230	328	7.018 363	1023	7.021 162	1122	7.059 745	1495	7.082 717	941	7.400 729	716
6.801 249	339	6.803 562	1336	7.008 231	328	7.018 365	1023	7.021 164	1122	7.059 778	326	7.083 308	1490	7.400 760	328
6.801 283	327	6.803 567	104	7.008 232	328	7.018 383	941	7.021 165	1122	7.059 804	718	7.083 428	1237	7.400 768	1028
6.801 322	141	6.803 624	791	7.008 258	342	7.018 384	941	7.021 170	1122	7.059 827	755	7.083 478	835	7.400 857	18
6.801 332	1152	6.803 651	1495	7.008 272	342	7.018 397	932	7.021 172	1122	7.059 854	560	7.083 522	761	7.401 066	1435
6.801 361	655	6.803 677	1231	7.008 273	343	7.018 398	932	7.021 486	64	7.059 855	560	7.083 595	1453	7.401 066	1440
6.801 459	1244	6.803 703	771	7.008 310	1257	7.018 413	932	7.021 545	24	7.060 298	701	7.083 596	1453	7.401 072	327
6.801 467	835	6.803 717	1445	7.008 312	1257	7.018 535	920	7.021 547	1375	7.060 419	1436	7.083 665	1465	7.401 744	1437
6.801 504	21	6.803 740	1275	7.008 397	1246	7.018 536	920	7.021 548	1375	7.060 421	1436	7.084 720	1453	7.401 744	1439
6.801 515	1039	6.803 751	1339	7.008 434	337	7.018 537	920	7.021 549	1375	7.060 425	1449	7.084 918	1495	7.401 744	1441
6.801 520	179	6.900 068	157	7.008 959	138	7.018 538	920	7.021 550	1375	7.060 427	1449	7.085 047	1463	7.401 744	1440
6.801 571	1390	6.900 098	200	7.008 959	550	7.018 539	920	7.021 595	95	7.060 433	1449	7.085 191	642	7.401 840	1447
6.801 608	1466	6.900 118	113	7.008 960	138	7.018 540	920	7.021 596	95	7.060 437	1444	7.085 238	1436	7.408 011	919
6.801 610	771	6.900 119	566	7.008 960	550	7.018 541	920	7.021 797	618	7.060 457	1446	7.085 372	44	7.500 007	1320
6.801 651	1455	6.900 157	628	7.008 961	138	7.018 542	920	7.021 838	621	7.060 459	1447	7.085 511	1440	7.500 023	735
6.801 655	755	6.900 171	995	7.008 961	550	7.018 543	920	7.021 840	621	7.060 463	1447	7.085 892	1436	7.510 044	342
6.801 670	1244	6.900 172	995	7.008 962	138	7.018 544	920	7.022 042	1022	7.060 469	1441	7.085 924	339	7.510 053	1444
6.801 671	1244	6.900 197	177	7.008 962	550	7.018 545	920	7.022 043	1022	7.060 471	1449	7.086 147	1490	7.510 059	1497
6.801 684	554	6.900 233	1441	7.008 966	18	7.018 546	920	7.022 044	1022	7.060 471	1448	7.087 938	94	7.510 076	1407
6.801 696	95	6.900 236	1193	7.008 967	18	7.018 549	920	7.022 224	644	7.060 475	1443	7.087 939	94	7.510 080	1246
6.801 707	758	6.900 300	170	7.008 968	18	7.018 550	920	7.022 240	752	7.060 477	1447	7.087 940	94	7.510 090	1463
6.801 712	1483	6.900 312	634	7.008 969	18	7.018 553	920	7.022 420	644	7.060 479	1448	7.089 161	1466	7.510 238	1463
6.801 727	1443	6.900 314	320	7.008 970	18	7.018 554	923	7.022 432	644	7.060 678	932	7.089 162	1466	7.510 242	912
6.801 771	43	6.900 348	510	7.008 971	18	7.018 555	923	7.023 176	433	7.060 691	915	7.089 804	342	7.510 300	496
6.801 772	1456	6.900 353	77	7.008 972	18	7.018 556	923	7.023 177	433	7.060 692	915	7.089 857	1257	7.510 391	953
6.801 774	118	6.900 361	757	7.008 973	18	7.018 557	923	7.023 178	433	7.060 693	915	7.089 998	1440	7.510 401	1047
6.801 789	757	6.900 409	1214	7.008 974	18	7.018 558	923	7.023 179	433	7.060 694	915	7.090 437	794	7.510 426	1024
6.801 844	558	6.900 411	633	7.008 975	18	7.018 559	923	7.027 746	1173	7.060 716	258	7.090 616	1445	7.510 427	1024
6.801 854	1372	6.900 415	1463	7.008 976	18	7.018 560	923	7.036 710	396	7.070 048	1407	7.090 617	1445	7.510 519	78
6.801 867	1152	6.900 428	180	7.008 977	18	7.018 561	923	7.036 711	396	7.070 780	318	7.095 411	179	7.510 519	1020
6.801 868	1152	6.900 429	180	7.008 978	18	7.018 562	923	7.036 852	389	7.071 063	1449	7.100 679	371	7.510 539	935
6.801 871	1408	6.900 430	180	7.008 989	97	7.018 563	923	7.036 853	389	7.071 109	716	7.190 001	24	7.510 657	147
6.801 872	1408	6.900 476	179	7.008 990	97	7.018 564	923	7.036 854	389	7.071 111	760	7.190 011	24	7.510 686	1333
6.801 879	427	6.900 480	1235	7.008 999	915	7.018 565	923	7.036 855	389	7.071 151	1444	7.190 021	24	7.510 775	113

Bestellnummernindex - Numerical index - Index numérique - Índice Numérico - Índice numerico - Indeks numerów katalogowych - Указатель по номерам

7.603 089	157	7.620 842	1387	7.631 961	936	7.652 409	1243	7.660 602	1172	7.930 366	1438	7.970 906	607	9.000 460	106
7.603 864	655	7.621 423	1045	7.631 964	604	7.652 552	24	7.660 686	1329	7.930 401	938	7.971 013	106	9.000 461	106
7.603 959	1339	7.621 456	554	7.631 971	610	7.652 552	1474	7.660 691	904	7.930 401	1345	7.971 013	862	9.000 462	106
7.604 011	78	7.621 719	768	7.632 002	1320	7.652 667	662	7.660 784	172	7.930 403	938	7.971 172	785	9.000 463	106
7.604 011	1020	7.621 765	1439	7.632 190	1118	7.653 010	192	7.660 786	172	7.930 403	1345	7.971 324	785	9.000 464	106
7.604 058	110	7.621 811	489	7.632 230	1368	7.653 077	337	7.660 787	172	7.939 181	286	7.971 350	412	9.000 465	106
7.604 078	147	7.622 377	553	7.632 508	1416	7.653 124	544	7.660 941	1173	7.939 201	286	7.971 434	557	9.000 470	106
7.604 109	755	7.622 477	547	7.632 543	40	7.653 145	1491	7.661 033	792	7.939 217	286	7.971 443	499	9.000 471	106
7.604 208	16	7.622 596	652	7.632 641	84	7.653 197	432	7.661 152	201	7.939 346	286	7.971 461	498	9.000 472	106
7.604 340	634	7.622 618	644	7.632 676	489	7.653 216	646	7.661 262	646	7.940 038	618	7.971 467	613	9.001 015	1037
7.604 410	213	7.622 619	644	7.632 839	733	7.653 217	646	7.661 308	1215	7.940 190	1053	7.971 473	736	9.001 018	1037
7.604 610	642	7.622 620	644	7.633 130	190	7.653 221	380	7.661 450	1243	7.940 228	1062	7.971 495	739	9.001 022	1037
7.604 787	722	7.622 636	711	7.633 673	192	7.653 222	380	7.661 472	991	7.940 294	841	7.971 555	1306	9.001 062	543
7.605 126	124	7.622 680	1215	7.633 920	354	7.653 223	380	7.661 767	1215	7.940 295	1513	7.971 615	699	9.001 075	564
7.605 462	294	7.622 794	1215	7.634 155	1337	7.653 251	256	7.661 827	1265	7.940 296	1513	7.971 642	745	9.001 076	564
7.605 523	107	7.623 018	1477	7.634 537	1296	7.653 307	204	7.661 828	1265	7.940 297	1513	7.971 698	677	9.001 077	564
7.605 582	185	7.623 040	1336	7.634 542	323	7.653 540	1126	7.662 035	1243	7.940 304	1481	7.971 768	823	9.001 078	564
7.606 129	109	7.623 390	361	7.634 612	1053	7.653 714	663	7.670 022	354	7.940 344	786	7.971 775	708	9.001 079	564
7.606 373	709	7.623 633	1368	7.634 641	1544	7.653 830	1246	7.670 460	604	7.940 456	380	7.971 823	1146	9.001 080	564
7.606 374	24	7.623 704	278	7.634 892	158	7.654 036	1215	7.670 597	361	7.940 554	214	7.980 024	1204	9.001 081	564
7.606 375	24	7.623 804	716	7.635 031	1416	7.654 045	113	7.670 865	1163	7.940 936	1256	7.980 025	1204	9.001 082	564
7.606 410	709	7.623 809	237	7.635 340	631	7.654 046	113	7.670 948	1490	7.940 950	1256	7.980 027	1204	9.001 083	564
7.606 811	758	7.623 809	381	7.635 340	826	7.654 081	640	7.671 016	1103	7.960 501	69	7.980 101	1205	9.001 084	564
7.606 907	654	7.623 810	237	7.635 438	1489	7.654 881	375	7.671 083	380	7.960 502	69	7.980 111	109	9.001 085	564
7.606 908	654	7.623 810	381	7.635 816	636	7.654 947	1169	7.671 104	1418	7.960 503	69	7.980 112	109	9.001 086	564
7.607 192	1114	7.623 838	1477	7.635 868	358	7.655 158	316	7.671 305	287	7.960 504	69	7.980 357	619	9.001 110	1037
7.607 198	24	7.623 881	237	7.635 908	643	7.655 178	375	7.671 311	276	7.960 505	69	7.980 358	619	9.001 111	1037
7.607 198	1474	7.623 881	381	7.636 288	1458	7.655 206	1183	7.671 498	64	7.960 506	69	7.980 484	1203	9.001 112	1038
7.607 297	1494	7.623 893	55	7.636 591	338	7.655 229	375	7.671 690	1391	7.960 507	69	7.980 485	1203	9.001 115	1038
7.607 298	1494	7.623 930	542	7.636 628	55	7.655 256	354	7.671 735	1457	7.960 508	69	7.980 791	624	9.001 118	1038
7.607 378	991	7.623 930	1213	7.637 101	1331	7.655 341	363	7.671 774	823	7.960 510	69	7.980 952	118	9.001 130	1037
7.607 778	24	7.623 956	25	7.637 102	1331	7.655 427	546	7.671 795	1493	7.960 512	69	7.980 963	426	9.001 132	1037
7.607 778	1474	7.624 042	45	7.637 244	1164	7.655 592	441	7.671 880	788	7.960 513	69	7.981 185	600	9.001 133	1037
7.607 913	624	7.624 247	1335	7.637 274	133	7.655 618	265	7.671 897	709	7.970 000	710	7.981 188	602	9.001 134	1040
7.608 012	1390	7.624 548	323	7.637 495	558	7.655 788	1215	7.671 903	1176	7.970 001	710	7.981 189	602	9.001 135	1038
7.608 143	380	7.624 578	324	7.637 496	558	7.655 865	405	7.672 009	318	7.970 002	710	7.981 287	1289	9.001 137	1038
7.608 144	318	7.624 685	894	7.638 234	199	7.655 972	1306	7.672 054	1385	7.970 032	710	7.981 345	560	9.001 138	1038
7.608 178	619	7.625 012	1448	7.638 354	1495	7.656 103	239	7.672 157	277	7.970 033	716	7.981 360	1025	9.001 210	1038
7.608 352	107	7.625 078	1368	7.638 423	158	7.656 106	363	7.672 290	841	7.970 045	710	7.981 381	1036	9.001 260	1039
7.608 467	1068	7.625 237	358	7.638 738	914	7.656 131	106	7.672 518	1489	7.970 057	710	7.981 548	1008	9.001 335	1039
7.609 731	28	7.625 555	237	7.638 886	1418	7.656 156	411	7.672 572	389	7.970 058	710	7.981 562	607	9.001 336	1039
7.609 930	1027	7.625 555	381	7.638 887	1418	7.656 611	367	7.672 754	1329	7.970 090	113	7.981 659	174	9.001 337	1039
7.609 951	1219	7.625 713	1488	7.638 888	1418	7.656 680	792	7.672 991	852	7.970 106	716	7.981 688	488	9.001 338	1039
7.610 567	755	7.625 756	1514	7.638 889	1418	7.656 681	792	7.673 115	1307	7.970 129	1126	7.982 028	1510	9.001 340	1038
7.610 631	629	7.625 757	1514	7.638 923	1086	7.656 684	173	7.673 256	173	7.970 134	699	7.982 409	745	9.001 341	1038
7.610 673	623	7.625 884	544	7.639 008	380	7.656 684	1392	7.673 349	805	7.970 139	699	7.982 553	768	9.001 345	1038
7.610 674	623	7.626 193	1100	7.639 227	290	7.656 739	256	7.673 361	432	7.970 147	1382	7.982 609	775	9.001 346	1042
7.611 570	1058	7.626 193	1103	7.639 613	1039	7.656 781	337	7.673 536	1329	7.970 184	640	7.982 708	961	9.001 347	1039
7.611 600	644	7.626 196	320	7.639 620	375	7.656 875	316	7.673 666	1023	7.970 224	227	7.982 838	1312	9.001 349	1040
7.611 951	1329	7.626 197	338	7.639 635	1489	7.656 917	375	7.673 667	1023	7.970 225	227	7.983 050	772	9.001 351	1040
7.612 023	1058	7.626 372	1152	7.639 691	290	7.656 984	1494	7.700 004	652	7.970 226	227	7.983 353	480	9.001 352	1040
7.612 290	1408	7.626 422	265	7.639 848	1494	7.657 006	655	7.700 009	1446	7.970 241	636	7.983 354	480	9.001 353	1040
7.612 465	55	7.626 604	404	7.639 994	575	7.657 015	1322	7.850 010	1448	7.970 258	731	7.983 628	1073	9.001 354	1040
7.612 486	1151	7.626 614	404	7.642 505	1457	7.657 074	218	7.900 140	589	7.970 258	1471	7.983 629	1073	9.001 355	1038
7.612 636	1494	7.626 766	1207	7.642 628	1113	7.657 096	708	7.900 153	835	7.970 266	699	7.983 641	892	9.001 356	1039
7.613 424	1374	7.626 860	679	7.642 673	1265	7.657 646	1390	7.900 288	876	7.970 267	699	7.983 642	892	9.001 357	1039
7.613 795	24	7.626 965	545	7.642 799	286	7.657 739	962	7.900 288	1334	7.970 268	699	7.983 643	892	9.001 358	1039
7.613 796	628	7.627 765	1368	7.643 148	1053	7.657 835	1414	7.900 289	876	7.970 269	699	7.983 695	1064	9.001 359	1039
7.614 642	624	7.627 795	786	7.643 634	360	7.657 836	1414	7.900 289	1334	7.970 271	710	7.984 151	821	9.001 362	1038
7.614 741	1374	7.627 832	363	7.643 731	406	7.657 837	1362	7.900 714	1494	7.970 273	21	9.000 032	104	9.001 363	1038
7.615 379	622	7.627 990	1053	7.644 255	1297	7.657 840	1385	7.900 725	135	7.970 278	637	9.000 034	104	9.001 364	1039
7.615 430	640	7.628 015	1372	7.644 433	322	7.657 852	655	7.900 874	823	7.970 286	731	9.000 038	104	9.001 365	1039
7.615 467	1368	7.628 136	1494	7.644 453	1316	7.657 874	962	7.910 013	1240	7.970 286	1471	9.000 041	104	9.001 366	1039
7.615 487	323	7.628 209	628	7.644 727	575	7.657 889	363	7.910 023	1474	7.970 339	716	9.000 044	104	9.001 367	1039
7.615 523	558	7.628 273	1368	7.644 728	575	7.658 006	318	7.910 025	928	7.970 385	731	9.000 049	104	9.001 368	1039
7.615 661	828	7.628 620	375	7.644 960	349	7.658 119	1459	7.910 047	1310	7.970 385	1471	9.000 054	104	9.001 369	1039
7.615 698	995	7.628 769	1494	7.644 987	360	7.658 120	1459	7.910 093	1127	7.970 387	731	9.000 059			

Bestellnummernindex - Numerical index - Index numérique - Índice Numérico - Índice numerico - Indeks numerów katalogowych - Указатель по номерам

9.003 033	1184	9.003 799	1472	9.005 209	235	9.005 541	216	9.010 475	1371	9.011 662	652	9.011 957	622	9.012 328	627
9.003 240	1184	9.003 800	1472	9.005 222	237	9.005 542	216	9.010 476	1371	9.011 663	652	9.011 958	622	9.012 329	627
9.003 305	1184	9.003 801	1472	9.005 222	381	9.005 543	216	9.010 477	1371	9.011 664	652	9.011 959	622	9.012 330	628
9.003 320	1184	9.003 802	1472	9.005 223	237	9.005 544	216	9.010 478	1371	9.011 665	652	9.011 960	622	9.012 333	628
9.003 344	1184	9.003 803	1472	9.005 223	381	9.005 545	216	9.010 481	1376	9.011 666	652	9.011 961	622	9.012 336	628
9.003 355	1184	9.003 804	1472	9.005 250	239	9.005 546	216	9.010 482	1376	9.011 667	652	9.011 962	622	9.012 337	628
9.003 366	1184	9.003 816	1472	9.005 260	239	9.005 547	216	9.010 512	1370	9.011 668	652	9.011 963	622	9.012 402	628
9.003 367	1451	9.003 817	1472	9.005 271	239	9.005 548	216	9.010 601	28	9.011 675	651	9.011 964	622	9.012 403	628
9.003 368	1451	9.003 818	1472	9.005 272	239	9.005 549	216	9.010 602	28	9.011 676	651	9.011 965	622	9.012 404	628
9.003 369	1451	9.003 819	1472	9.005 275	226	9.005 555	212	9.010 603	28	9.011 677	651	9.011 966	622	9.012 405	628
9.003 374	1184	9.003 820	1472	9.005 276	226	9.005 558	213	9.010 605	29	9.011 678	651	9.011 967	622	9.012 406	628
9.003 375	1184	9.003 821	1472	9.005 277	226	9.005 559	213	9.010 606	29	9.011 680	651	9.011 968	622	9.012 407	628
9.003 376	1184	9.003 822	1472	9.005 278	226	9.005 561	213	9.010 608	28	9.011 685	651	9.011 969	622	9.012 408	628
9.003 425	1446	9.003 823	1472	9.005 279	226	9.005 563	213	9.010 609	29	9.011 686	651	9.011 970	622	9.012 410	628
9.003 426	1446	9.003 824	1472	9.005 308	232	9.005 565	213	9.010 610	28	9.011 687	651	9.011 971	622	9.012 413	628
9.003 430	1447	9.003 866	1472	9.005 309	232	9.005 566	213	9.010 611	28	9.011 688	651	9.011 982	623	9.012 414	628
9.003 434	1447	9.003 867	1472	9.005 310	232	9.005 570	213	9.010 612	28	9.011 690	651	9.011 983	623	9.012 415	628
9.003 435	1435	9.003 868	1472	9.005 311	232	9.005 590	210	9.010 612	1375	9.011 693	651	9.011 984	623	9.012 416	628
9.003 435	1440	9.003 869	1472	9.005 312	224	9.005 592	210	9.010 613	28	9.011 694	651	9.011 985	623	9.012 417	628
9.003 441	1441	9.003 870	1472	9.005 313	224	9.005 593	210	9.010 613	1375	9.011 695	651	9.011 986	623	9.012 453	1232
9.003 443	1435	9.003 871	1472	9.005 314	224	9.005 594	210	9.010 614	29	9.011 696	651	9.012 001	624	9.012 456	1232
9.003 444	1435	9.003 872	1472	9.005 315	224	9.005 595	210	9.010 620	28	9.011 697	651	9.012 002	624	9.012 459	1232
9.003 445	1447	9.003 873	1472	9.005 339	218	9.005 596	210	9.010 620	1375	9.011 698	651	9.012 003	624	9.012 473	1231
9.003 446	1441	9.003 874	1472	9.005 340	218	9.005 681	208	9.010 632	793	9.011 740	645	9.012 006	624	9.012 476	1231
9.003 448	1437	9.003 901	152	9.005 341	218	9.005 750	207	9.010 633	793	9.011 750	645	9.012 008	624	9.012 501	637
9.003 452	1447	9.003 910	152	9.005 342	218	9.005 751	207	9.010 634	793	9.011 755	645	9.012 009	624	9.012 502	637
9.003 453	1447	9.003 911	152	9.005 343	218	9.005 752	207	9.010 635	793	9.011 760	645	9.012 010	624	9.012 505	637
9.003 454	1447	9.003 912	152	9.005 344	224	9.005 753	207	9.010 636	793	9.011 765	645	9.012 012	624	9.012 506	637
9.003 455	1447	9.003 913	152	9.005 345	224	9.005 754	207	9.010 637	793	9.011 766	645	9.012 013	624	9.012 506	640
9.003 456	1447	9.003 914	152	9.005 346	224	9.005 755	207	9.010 638	793	9.011 767	645	9.012 014	624	9.012 507	635
9.003 457	1448	9.004 006	425	9.005 347	224	9.006 001	196	9.010 639	793	9.011 783	651	9.012 015	624	9.012 509	635
9.003 458	1448	9.004 008	425	9.005 348	224	9.006 002	196	9.010 640	793	9.011 784	651	9.012 016	624	9.012 510	635
9.003 460	1447	9.004 010	425	9.005 349	217	9.006 002	203	9.010 641	793	9.011 785	651	9.012 017	624	9.012 517	636
9.003 465	1495	9.004 012	425	9.005 350	217	9.006 002	1510	9.010 691	793	9.011 786	651	9.012 018	624	9.012 522	636
9.003 466	1446	9.004 014	425	9.005 351	217	9.006 007	197	9.010 692	793	9.011 797	651	9.012 019	624	9.012 523	636
9.003 470	1451	9.004 016	425	9.005 352	217	9.006 008	197	9.010 693	793	9.011 797	663	9.012 021	620	9.012 524	636
9.003 471	1451	9.004 057	425	9.005 353	217	9.006 009	197	9.010 694	793	9.011 798	651	9.012 022	620	9.012 525	635
9.003 473	1451	9.004 060	425	9.005 362	224	9.006 127	197	9.010 770	945	9.011 798	663	9.012 023	620	9.012 526	635
9.003 474	1495	9.004 065	425	9.005 363	224	9.006 128	197	9.010 781	945	9.011 799	651	9.012 024	620	9.012 527	635
9.003 475	1451	9.004 108	425	9.005 364	224	9.006 129	197	9.010 782	945	9.011 799	663	9.012 101	629	9.012 528	635
9.003 476	1495	9.004 109	425	9.005 365	224	9.006 130	197	9.010 783	945	9.011 800	651	9.012 103	629	9.012 530	635
9.003 477	1495	9.004 110	425	9.005 390	219	9.006 132	197	9.010 784	945	9.011 800	663	9.012 121	629	9.012 533	635
9.003 478	1495	9.004 111	425	9.005 391	219	9.006 133	197	9.010 785	945	9.011 801	618	9.012 123	629	9.012 534	635
9.003 480	1435	9.004 112	425	9.005 392	219	9.006 370	220	9.010 790	945	9.011 802	618	9.012 138	629	9.012 535	637
9.003 481	1435	9.004 113	425	9.005 393	219	9.006 371	220	9.010 791	945	9.011 805	618	9.012 141	626	9.012 536	637
9.003 482	1443	9.004 114	425	9.005 394	219	9.006 372	220	9.010 792	945	9.011 810	618	9.012 143	626	9.012 537	637
9.003 484	1436	9.004 115	425	9.005 395	224	9.006 373	220	9.010 793	945	9.011 815	618	9.012 153	626	9.012 538	641
9.003 487	1463	9.004 153	426	9.005 396	224	9.006 374	220	9.010 794	945	9.011 827	619	9.012 161	652	9.012 539	641
9.003 488	1463	9.004 154	426	9.005 397	224	9.006 375	221	9.010 795	945	9.011 828	619	9.012 163	652	9.012 540	642
9.003 491	1495	9.004 155	426	9.005 398	224	9.006 376	221	9.010 800	945	9.011 829	619	9.012 182	625	9.012 541	642
9.003 492	1495	9.004 156	426	9.005 400	225	9.006 377	221	9.010 801	945	9.011 835	618	9.012 183	625	9.012 542	636
9.003 493	1495	9.004 157	426	9.005 401	225	9.006 378	221	9.011 009	57	9.011 840	618	9.012 184	645	9.012 543	636
9.003 494	1495	9.004 158	426	9.005 402	225	9.006 379	222	9.011 010	57	9.011 845	618	9.012 185	645	9.012 544	636
9.003 495	1498	9.004 159	426	9.005 403	225	9.006 380	222	9.011 025	57	9.011 850	618	9.012 186	645	9.012 545	635
9.003 496	1495	9.004 160	426	9.005 404	225	9.006 381	222	9.011 060	57	9.011 850	640	9.012 187	645	9.012 546	637
9.003 497	1495	9.004 161	426	9.005 405	220	9.006 382	222	9.011 069	57	9.011 855	618	9.012 188	645	9.012 547	635
9.003 498	1498	9.004 162	426	9.005 406	220	9.006 383	217	9.011 071	57	9.011 860	618	9.012 189	645	9.012 548	636
9.003 500	1499	9.004 163	426	9.005 407	220	9.006 384	217	9.011 072	57	9.011 864	618	9.012 190	645	9.012 611	627
9.003 511	1451	9.004 305	425	9.005 408	220	9.006 385	217	9.011 076	57	9.011 865	618	9.012 191	645	9.012 613	627
9.003 535	1443	9.004 310	425	9.005 409	220	9.006 386	217	9.011 078	57	9.011 866	618	9.012 193	629	9.012 621	627
9.003 541	1450	9.004 315	425	9.005 420	226	9.006 893	240	9.011 102	58	9.011 867	618	9.012 216	625	9.012 623	627
9.003 542	1450	9.004 320	425	9.005 421	226	9.010 012	1375	9.011 103	58	9.011 868	618	9.012 217	625	9.012 657	626
9.003 543	1449	9.004 330	425	9.005 422	226	9.010 013	1375	9.011 104	58	9.011 869	618	9.012 218	625	9.012 658	626
9.003 544	1449	9.004 340	425	9.005 423	226	9.010 014	1375	9.011 121	58	9.011 870	618	9.012 219	625	9.012 659	626
9.003 545	1449	9.004 350	425	9.005 424	226	9.010 016	1375	9.011 122	58	9.011 875	618	9.012 247	625	9.012 660	626
9.003 549	1443	9.004 370	425	9.005 427	231	9.010 018	1375	9.011 170	57	9.011 877	618	9.012 248	625	9.012 695	627
9.003 557	1436	9.005 008	253	9.005 446	242	9.010 019	1375	9.011 181	57	9.011 880	618	9.012 249	625	9.012 696	627
9.003 558	1436	9.005 009	253	9.005 44											

Bestellnummernindex - Numerical index - Index numérique - Índice Numérico - Índice numerico - Indeks numerów katalogowych - Указатель по номерам

9.012 932	187	9.013 735	1223	9.019 060	1182	9.032 739	769	9.040 206	54	9.040 862	339	9.041 542	322	9.042 725	1083
9.012 933	187	9.013 773	17	9.019 070	1182	9.032 740	771	9.040 212	54	9.040 863	339	9.041 543	322	9.042 730	1083
9.012 934	187	9.013 774	17	9.019 080	1182	9.032 741	771	9.040 216	54	9.040 864	339	9.041 544	322	9.042 740	1081
9.012 939	187	9.013 775	17	9.019 090	1182	9.032 742	770	9.040 325	55	9.040 865	325	9.041 545	322	9.042 741	1081
9.012 944	187	9.013 776	17	9.019 092	1182	9.032 743	770	9.040 330	55	9.040 866	325	9.041 553	319	9.042 742	1081
9.012 945	187	9.013 900	13	9.019 100	1182	9.032 920	130	9.040 332	55	9.040 867	325	9.041 555	319	9.042 743	1081
9.013 063	13	9.013 901	13	9.019 110	1175	9.032 930	130	9.040 335	55	9.040 868	325	9.041 560	320	9.042 751	1084
9.013 068	13	9.013 902	13	9.019 110	1182	9.032 932	130	9.040 336	166	9.040 869	325	9.041 583	344	9.042 753	1084
9.013 073	13	9.013 903	13	9.020 179	1498	9.033 121	51	9.040 337	166	9.040 870	324	9.041 584	344	9.042 755	1084
9.013 086	13	9.013 904	13	9.020 192	947	9.033 123	51	9.040 338	166	9.040 871	325	9.041 585	344	9.042 757	1084
9.013 163	14	9.013 905	13	9.020 193	947	9.033 124	51	9.040 339	166	9.040 872	315	9.041 590	323	9.042 759	1084
9.013 168	14	9.013 906	13	9.020 194	947	9.033 131	51	9.040 340	166	9.040 873	315	9.041 601	344	9.042 761	1084
9.013 192	1224	9.013 910	13	9.020 195	947	9.033 133	51	9.040 341	166	9.040 876	315	9.041 611	319	9.042 763	1085
9.013 208	15	9.013 911	13	9.020 196	947	9.033 134	51	9.040 342	166	9.040 877	315	9.041 611	321	9.042 765	1085
9.013 209	15	9.013 912	13	9.020 440	1122	9.033 141	51	9.040 343	166	9.040 881	315	9.041 613	319	9.042 767	1085
9.013 210	1225	9.013 913	13	9.022 160	1499	9.033 143	51	9.040 344	166	9.040 886	315	9.041 613	321	9.042 769	1085
9.013 211	1225	9.013 920	13	9.022 161	1499	9.033 144	51	9.040 345	166	9.040 890	316	9.041 634	321	9.042 801	1083
9.013 212	1225	9.013 921	13	9.022 162	1499	9.033 187	46	9.040 346	166	9.040 895	317	9.041 649	321	9.042 802	1083
9.013 213	1225	9.013 922	13	9.023 150	1499	9.033 201	44	9.040 347	166	9.040 896	317	9.041 650	321	9.042 803	1083
9.013 214	1225	9.013 923	13	9.023 160	1499	9.033 202	44	9.040 348	166	9.040 897	317	9.041 661	321	9.042 804	1083
9.013 215	1225	9.013 924	13	9.023 955	1499	9.033 211	44	9.040 349	166	9.040 904	339	9.041 662	321	9.042 805	1083
9.013 220	15	9.013 925	13	9.023 956	1499	9.033 212	44	9.040 350	166	9.040 905	339	9.041 669	321	9.042 810	1081
9.013 228	15	9.013 930	13	9.023 957	1499	9.033 213	44	9.040 351	166	9.040 906	339	9.041 721	323	9.042 811	1081
9.013 238	15	9.013 931	13	9.023 990	1500	9.033 230	46	9.040 352	166	9.040 907	339	9.041 723	323	9.042 812	1081
9.013 244	15	9.013 932	13	9.024 000	1499	9.033 231	46	9.040 353	166	9.040 911	325	9.041 725	323	9.042 815	1081
9.013 248	15	9.014 100	643	9.025 912	1475	9.033 232	46	9.040 379	166	9.040 913	325	9.041 730	323	9.042 850	265
9.013 254	15	9.015 757	1386	9.025 913	1475	9.033 233	46	9.040 380	166	9.040 915	325	9.041 731	323	9.042 860	265
9.013 256	15	9.018 294	142	9.025 914	1475	9.033 234	46	9.040 381	166	9.040 940	328	9.041 732	323	9.042 861	265
9.013 262	15	9.018 360	142	9.025 932	1475	9.033 235	46	9.040 389	167	9.040 942	328	9.041 733	323	9.042 862	265
9.013 264	15	9.018 361	141	9.025 934	1475	9.033 236	46	9.040 552	171	9.040 944	328	9.041 735	323	9.042 863	265
9.013 266	15	9.018 362	141	9.025 936	1475	9.033 237	46	9.040 553	171	9.040 945	328	9.041 736	323	9.042 864	265
9.013 270	15	9.018 363	141	9.025 938	1475	9.033 238	46	9.040 554	171	9.040 949	327	9.041 745	323	9.042 866	265
9.013 315	15	9.018 364	141	9.031 821	790	9.033 239	46	9.040 556	171	9.040 950	327	9.041 813	326	9.042 867	265
9.013 320	15	9.018 365	141	9.031 961	769	9.033 240	46	9.040 557	171	9.040 951	327	9.041 814	326	9.042 868	266
9.013 328	15	9.018 366	141	9.031 962	769	9.033 241	46	9.040 562	172	9.040 955	327	9.041 815	326	9.042 869	266
9.013 338	15	9.018 370	141	9.031 964	769	9.033 242	46	9.040 574	172	9.040 964	339	9.041 816	326	9.042 871	265
9.013 344	15	9.018 375	142	9.031 970	769	9.033 251	192	9.040 575	172	9.040 987	339	9.041 817	326	9.042 872	265
9.013 348	15	9.018 376	142	9.031 971	771	9.033 252	192	9.040 576	172	9.041 033	328	9.041 818	326	9.042 873	265
9.013 350	15	9.018 380	142	9.031 972	771	9.033 253	192	9.040 577	172	9.041 036	328	9.041 872	327	9.042 874	265
9.013 354	15	9.018 381	142	9.031 973	771	9.033 270	52	9.040 578	172	9.041 050	326	9.041 878	327	9.042 875	265
9.013 356	15	9.018 388	142	9.031 975	771	9.033 270	1325	9.040 579	172	9.041 051	326	9.042 006	1088	9.042 876	266
9.013 362	15	9.018 389	142	9.031 981	771	9.033 275	52	9.040 580	172	9.041 052	326	9.042 019	1081	9.042 880	265
9.013 364	15	9.018 510	140	9.031 982	771	9.033 275	1325	9.040 581	172	9.041 072	328	9.042 031	1081	9.042 881	265
9.013 366	15	9.018 510	1382	9.031 983	771	9.033 280	52	9.040 582	172	9.041 092	328	9.042 038	1081	9.042 882	265
9.013 370	15	9.018 511	140	9.031 984	771	9.033 280	1325	9.040 583	172	9.041 100	318	9.042 043	1081	9.042 891	1483
9.013 573	14	9.018 511	1382	9.031 985	771	9.033 285	52	9.040 584	172	9.041 105	318	9.042 047	1081	9.042 892	1483
9.013 574	14	9.018 512	140	9.031 986	771	9.033 285	1325	9.040 585	172	9.041 110	318	9.042 119	1082	9.042 893	1483
9.013 575	14	9.018 512	1383	9.032 011	770	9.033 286	52	9.040 586	171	9.041 112	318	9.042 131	1082	9.042 900	268
9.013 576	14	9.018 519	140	9.032 012	770	9.033 286	1325	9.040 612	168	9.041 120	318	9.042 132	1082	9.042 901	268
9.013 577	14	9.018 519	1383	9.032 013	770	9.033 287	52	9.040 614	168	9.041 140	318	9.042 138	1082	9.042 902	268
9.013 578	14	9.018 520	140	9.032 014	770	9.033 287	1325	9.040 616	168	9.041 141	318	9.042 139	1082	9.042 905	268
9.013 579	14	9.018 520	1383	9.032 015	770	9.033 288	52	9.040 618	168	9.041 142	318	9.042 143	1082	9.042 906	268
9.013 580	14	9.018 539	140	9.032 016	770	9.033 288	1325	9.040 620	168	9.041 143	318	9.042 144	1082	9.042 907	268
9.013 581	14	9.018 540	140	9.032 017	770	9.033 341	50	9.040 625	168	9.041 144	318	9.042 147	1082	9.042 910	269
9.013 591	17	9.018 549	139	9.032 018	770	9.033 342	50	9.040 635	168	9.041 146	317	9.042 148	1082	9.042 911	269
9.013 592	17	9.018 553	139	9.032 019	770	9.033 344	50	9.040 636	168	9.041 147	317	9.042 232	1082	9.042 912	269
9.013 593	17	9.018 554	139	9.032 021	770	9.033 346	50	9.040 652	168	9.041 148	317	9.042 239	1082	9.042 915	269
9.013 594	17	9.018 560	139	9.032 022	770	9.033 350	50	9.040 711	169	9.041 149	317	9.042 244	1082	9.042 916	269
9.013 595	17	9.018 584	1384	9.032 023	770	9.033 410	50	9.040 711	763	9.041 150	317	9.042 248	1082	9.042 917	269
9.013 600	16	9.018 601	143	9.032 024	770	9.033 412	50	9.040 712	169	9.041 151	317	9.042 319	1082	9.042 920	269
9.013 601	16	9.018 602	143	9.032 025	770	9.033 414	50	9.040 712	763	9.041 155	318	9.042 331	1082	9.042 921	269
9.013 602	16	9.018 603	143	9.032 026	770	9.033 416	50	9.040 713	169	9.041 169	323	9.042 338	1082	9.042 922	269
9.013 603	16	9.018 604	143	9.032 027	770	9.033 418	50	9.040 713	763	9.041 170	323	9.042 343	1082	9.042 925	269
9.013 604	16	9.018 691	143	9.032 028	770	9.033 420	50	9.040 714	169	9.041 171	323	9.042 347	1082	9.042 926	269
9.013 605	16	9.018 741	1381	9.032 029	770	9.033 430	50	9.040 714	763	9.041 172	323	9.042 419	1082	9.042 927	269
9.013 606	16	9.018 742	1381	9.032 030	770	9.033 440	50	9.040 715	169	9.041 173	323	9.042 431	1082	9.042 930	269
9.013 610	16	9.018 750	1386	9.032 031	770	9.033 632	145	9.040 715	763	9.041 174	323	9.042 438	1082	9.042 931	269
9.013 611	16	9.018 751	1386	9.032 032	770	9.033 636	145	9.040 716	169	9.041 175	323	9.042 443	1082	9.042 9	

Bestellnummernindex - Numerical index - Index numérique - Índice Numérico - Índice numerico - Indeks numerów katalogowych - Указатель по номерам

9.043 012	641	9.046 055	1355	9.049 048	738	9.049 505	714	9.049 856	1328	9.051 321	648	9.052 367	748	9.053 389	727
9.043 013	641	9.046 056	1355	9.049 049	738	9.049 510	715	9.049 857	1328	9.051 324	648	9.052 368	748	9.053 424	727
9.043 014	641	9.046 061	1355	9.049 050	738	9.049 511	715	9.049 858	1328	9.051 325	648	9.052 369	748	9.053 428	727
9.043 015	641	9.046 062	1355	9.049 051	738	9.049 512	715	9.049 859	1328	9.051 424	751	9.052 370	748	9.053 429	727
9.043 016	641	9.046 064	1355	9.049 052	738	9.049 513	715	9.049 860	1328	9.051 436	751	9.052 371	748	9.053 431	727
9.043 017	641	9.046 065	1355	9.049 053	737	9.049 514	715	9.049 861	1327	9.051 444	751	9.052 372	748	9.053 432	727
9.043 018	641	9.046 067	1355	9.049 054	737	9.049 515	715	9.049 862	1327	9.051 454	751	9.052 373	748	9.053 709	716
9.043 019	641	9.046 068	1355	9.049 055	737	9.049 520	715	9.049 863	1327	9.051 455	751	9.052 374	748	9.053 710	716
9.043 020	1268	9.046 077	1391	9.049 056	737	9.049 524	715	9.049 864	1327	9.051 456	752	9.052 375	748	9.053 717	716
9.043 021	641	9.046 081	1391	9.049 057	737	9.049 536	715	9.049 865	734	9.051 457	752	9.052 376	748	9.053 770	716
9.043 022	641	9.046 082	1391	9.049 058	737	9.049 550	709	9.049 866	734	9.051 458	752	9.052 377	748	9.054 002	728
9.043 023	641	9.046 151	1356	9.049 059	737	9.049 551	709	9.049 911	732	9.051 459	752	9.052 378	748	9.054 008	728
9.043 026	641	9.046 152	1356	9.049 060	737	9.049 552	709	9.049 912	732	9.051 460	752	9.052 379	748	9.054 009	728
9.043 027	641	9.046 153	1356	9.049 063	738	9.049 553	709	9.049 913	732	9.051 471	648	9.052 380	748	9.054 012	728
9.043 028	1268	9.046 200	711	9.049 065	737	9.049 571	714	9.049 915	732	9.051 474	648	9.052 381	748	9.054 014	728
9.043 029	1268	9.046 201	711	9.049 066	737	9.049 572	714	9.049 916	732	9.051 519	752	9.052 382	748	9.054 018	728
9.043 030	1268	9.046 202	711	9.049 067	737	9.049 577	715	9.049 917	732	9.051 531	752	9.052 383	748	9.054 019	728
9.043 031	1268	9.046 203	711	9.049 068	737	9.049 578	715	9.049 918	732	9.051 619	752	9.052 384	748	9.054 022	728
9.043 035	1268	9.046 204	711	9.049 069	737	9.049 579	715	9.049 919	732	9.051 631	752	9.052 385	748	9.054 023	728
9.043 036	1268	9.046 205	711	9.049 070	737	9.049 580	715	9.049 920	732	9.052 021	746	9.052 386	748	9.054 028	728
9.043 037	1268	9.046 300	712	9.049 073	736	9.049 581	715	9.049 925	732	9.052 022	746	9.052 387	748	9.054 032	728
9.043 038	1268	9.046 301	712	9.049 077	739	9.049 582	715	9.049 926	732	9.052 023	746	9.052 388	748	9.054 033	728
9.043 039	1268	9.046 302	712	9.049 078	739	9.049 583	715	9.049 927	732	9.052 024	746	9.052 389	748	9.054 034	728
9.043 040	1268	9.046 303	712	9.049 079	737	9.049 584	715	9.049 931	732	9.052 025	746	9.052 390	748	9.054 038	728
9.043 041	1268	9.046 304	712	9.049 080	737	9.049 585	715	9.049 932	732	9.052 031	746	9.052 391	750	9.054 039	728
9.043 042	1268	9.046 305	712	9.049 081	735	9.049 586	715	9.049 933	732	9.052 032	746	9.052 392	750	9.054 042	728
9.043 043	1268	9.047 400	700	9.049 082	735	9.049 587	715	9.049 934	732	9.052 033	746	9.052 393	750	9.054 043	728
9.043 301	625	9.047 401	700	9.049 084	735	9.049 588	715	9.049 936	732	9.052 034	746	9.052 394	750	9.054 044	728
9.043 302	625	9.047 402	700	9.049 085	735	9.049 589	715	9.049 937	732	9.052 036	745	9.052 395	750	9.054 048	728
9.043 305	625	9.047 403	700	9.049 087	735	9.049 590	715	9.049 941	734	9.052 037	745	9.052 400	751	9.054 049	728
9.043 901	1266	9.047 404	700	9.049 088	735	9.049 591	715	9.049 942	734	9.052 038	745	9.052 412	750	9.054 050	721
9.043 902	1266	9.047 405	700	9.049 091	735	9.049 600	718	9.049 943	734	9.052 039	745	9.052 417	750	9.054 051	721
9.043 903	1266	9.047 406	700	9.049 092	735	9.049 601	718	9.049 944	734	9.052 040	745	9.052 423	750	9.054 052	721
9.043 904	1266	9.047 407	700	9.049 094	735	9.049 602	718	9.049 948	734	9.052 041	745	9.052 427	750	9.054 053	721
9.043 905	1266	9.047 408	700	9.049 095	735	9.049 603	718	9.049 949	734	9.052 042	745	9.052 432	750	9.054 054	721
9.043 906	1266	9.047 409	700	9.049 097	735	9.049 604	718	9.049 950	734	9.052 043	745	9.052 436	750	9.054 055	721
9.043 907	1266	9.047 410	700	9.049 098	735	9.049 605	718	9.049 951	734	9.052 044	745	9.052 439	750	9.054 056	721
9.043 909	1266	9.047 411	700	9.049 103	735	9.049 606	718	9.049 955	734	9.052 060	745	9.052 443	750	9.054 057	721
9.043 910	1266	9.047 500	700	9.049 104	735	9.049 607	718	9.049 959	734	9.052 061	745	9.052 453	749	9.054 058	721
9.043 911	1266	9.047 501	700	9.049 105	735	9.049 619	709	9.049 960	734	9.052 062	745	9.052 454	749	9.054 059	721
9.043 915	1266	9.047 502	700	9.049 107	735	9.049 742	1328	9.049 961	734	9.052 063	745	9.052 744	743	9.054 060	721
9.043 916	1266	9.047 503	700	9.049 108	735	9.049 743	1328	9.049 962	734	9.052 064	745	9.052 901	748	9.054 061	721
9.043 917	1266	9.047 504	700	9.049 109	735	9.049 744	1328	9.049 963	734	9.052 065	745	9.052 903	746	9.054 062	721
9.043 918	1266	9.047 505	700	9.049 114	736	9.049 745	1328	9.049 964	734	9.052 066	748	9.052 905	746	9.054 063	721
9.043 950	1266	9.047 506	700	9.049 115	736	9.049 746	1328	9.049 965	734	9.052 067	748	9.052 910	746	9.054 122	728
9.045 700	1266	9.047 507	700	9.049 116	736	9.049 747	1328	9.049 980	734	9.052 068	748	9.052 913	747	9.054 122	1391
9.045 701	1266	9.048 500	700	9.049 117	736	9.049 750	1327	9.049 981	734	9.052 069	748	9.052 915	747	9.054 132	728
9.045 702	1266	9.048 501	700	9.049 122	735	9.049 753	1327	9.049 982	734	9.052 080	745	9.052 920	747	9.054 132	1391
9.045 703	1266	9.048 502	700	9.049 123	735	9.049 754	1328	9.049 990	734	9.052 081	745	9.052 923	747	9.054 133	728
9.045 704	1266	9.048 503	700	9.049 129	734	9.049 755	1327	9.049 991	734	9.052 082	745	9.052 925	747	9.054 133	1391
9.045 705	1266	9.048 504	700	9.049 130	734	9.049 756	1327	9.049 992	734	9.052 083	745	9.052 930	747	9.054 139	728
9.045 706	1266	9.048 505	700	9.049 146	736	9.049 757	1327	9.049 993	734	9.052 084	745	9.052 941	747	9.054 139	1391
9.045 707	1266	9.048 506	700	9.049 147	736	9.049 758	1327	9.049 996	734	9.052 085	745	9.052 942	747	9.054 202	1391
9.045 708	1266	9.048 507	700	9.049 151	741	9.049 759	1327	9.049 997	734	9.052 086	745	9.052 943	747	9.054 203	1391
9.045 709	1266	9.048 508	700	9.049 152	741	9.049 760	1327	9.050 018	77	9.052 087	745	9.052 944	747	9.054 304	722
9.045 710	1266	9.048 509	700	9.049 153	741	9.049 761	1327	9.050 019	77	9.052 088	745	9.052 951	747	9.054 308	722
9.045 711	1266	9.048 510	700	9.049 156	741	9.049 762	1327	9.050 020	77	9.052 089	745	9.052 952	747	9.054 309	722
9.045 800	699	9.048 511	700	9.049 157	741	9.049 763	1327	9.050 021	77	9.052 090	745	9.052 953	747	9.054 312	722
9.045 801	699	9.048 702	700	9.049 180	723	9.049 764	1327	9.050 022	77	9.052 091	745	9.052 954	747	9.054 315	722
9.045 802	699	9.048 703	700	9.049 181	723	9.049 765	1327	9.050 023	77	9.052 092	745	9.052 951	747	9.054 321	722
9.045 803	699	9.048 704	700	9.049 182	723	9.049 766	1327	9.050 601	173	9.052 114	746	9.052 962	747	9.054 324	722
9.045 804	699	9.048 705	700	9.049 183	723	9.049 767	1327	9.050 602	173	9.052 121	746	9.052 963	747	9.054 328	722
9.045 805	699	9.048 706	700	9.049 241	741	9.049 768	1327	9.050 603	173	9.052 126	746	9.052 964	747	9.054 329	722
9.045 806	699	9.048 707	700	9.049 242	741	9.049 769	1327	9.050 604	173	9.052 131	746	9.053 028	724	9.054 332	722
9.045 807	699	9.048 933	703	9.049 243	744	9.049 770	1327	9.050 696	173	9.052 213	746	9.053 044	724	9.054 335	722
9.045 808	699	9.048 934	703	9.049 300	1390	9.049 771	1328	9.050 750	174	9.052 214	746	9.053 048	724	9.054 341	722
9.045 809	699	9.048 937	701	9.049 304	1390	9.049 772	1328	9.050 751	174	9.052 215	746	9.053 049	724	9.054 344	722
9.045 810	699	9.048 938	703												

Bestellnummernindex - Numerical index - Index numérique - Índice Numérico - Índice numerico - Indeks numerów katalogowych - Указатель по номерам

9.055 500	1470	9.056 247	702	9.056 691	719	9.057 341	726	9.063 407	706	9.070 814	79	9.072 009	63	9.072 762	80
9.055 501	730	9.056 251	703	9.056 692	717	9.057 342	726	9.063 408	706	9.070 817	79	9.072 010	63	9.072 771	81
9.055 501	1470	9.056 252	703	9.056 693	717	9.057 565	724	9.063 409	706	9.070 824	79	9.072 011	63	9.072 773	81
9.055 502	730	9.056 253	703	9.056 699	719	9.057 571	724	9.063 410	706	9.070 836	79	9.072 012	63	9.072 783	81
9.055 502	1470	9.056 254	703	9.056 711	719	9.057 572	724	9.063 411	706	9.070 844	79	9.072 013	63	9.072 784	81
9.055 503	730	9.056 255	703	9.056 712	717	9.057 578	724	9.063 702	706	9.070 854	79	9.072 014	63	9.072 785	81
9.055 503	1470	9.056 256	703	9.056 713	717	9.057 605	724	9.063 704	706	9.070 863	79	9.072 015	63	9.072 786	81
9.055 504	730	9.056 257	703	9.056 716	717	9.057 611	724	9.063 705	706	9.070 873	79	9.072 016	63	9.072 787	81
9.055 504	1470	9.056 278	701	9.056 721	719	9.057 612	724	9.063 706	706	9.070 886	79	9.072 017	63	9.072 788	81
9.055 510	730	9.056 279	701	9.056 722	717	9.057 618	724	9.063 707	706	9.070 917	79	9.072 018	63	9.072 789	81
9.055 510	1470	9.056 294	705	9.056 723	717	9.057 712	723	9.063 904	706	9.070 924	79	9.072 019	63	9.072 808	87
9.055 511	730	9.056 295	705	9.056 724	719	9.057 771	723	9.063 905	706	9.070 936	79	9.072 020	63	9.072 814	87
9.055 511	1470	9.056 296	705	9.056 725	719	9.057 772	723	9.063 906	706	9.070 944	79	9.072 041	86	9.072 819	87
9.055 512	730	9.056 297	705	9.056 726	717	9.057 785	723	9.063 907	706	9.070 954	79	9.072 042	86	9.072 824	87
9.055 512	1470	9.056 298	705	9.056 727	719	9.057 791	723	9.063 909	706	9.070 963	79	9.072 051	86	9.072 850	90
9.055 513	730	9.056 299	705	9.056 729	719	9.057 792	723	9.065 104	706	9.071 405	73	9.072 052	86	9.072 851	90
9.055 513	1470	9.056 301	705	9.056 730	719	9.057 795	723	9.065 105	706	9.071 408	73	9.072 055	86	9.072 852	90
9.055 520	730	9.056 304	705	9.056 731	719	9.057 798	723	9.065 106	706	9.071 414	73	9.072 060	86	9.072 853	90
9.055 520	1470	9.056 305	705	9.056 732	719	9.057 800	725	9.065 107	706	9.071 419	73	9.072 061	86	9.072 854	90
9.055 521	730	9.056 306	705	9.056 733	719	9.057 812	725	9.065 108	706	9.071 424	73	9.072 062	86	9.072 855	90
9.055 521	1470	9.056 307	705	9.056 734	719	9.058 179	725	9.065 109	706	9.071 508	73	9.072 065	86	9.072 856	90
9.055 522	730	9.056 308	705	9.056 739	719	9.058 199	725	9.066 597	704	9.071 514	73	9.072 070	86	9.072 857	90
9.055 522	1470	9.056 309	705	9.056 740	719	9.058 200	725	9.067 003	709	9.071 519	73	9.072 071	86	9.072 858	90
9.055 523	730	9.056 331	701	9.056 741	719	9.058 327	726	9.067 004	709	9.071 524	73	9.072 072	86	9.072 859	90
9.055 523	1470	9.056 332	701	9.056 742	719	9.058 328	726	9.068 210	597	9.071 672	62	9.072 073	86	9.072 862	82
9.055 530	731	9.056 333	702	9.056 743	719	9.058 623	721	9.068 211	597	9.071 673	62	9.072 075	86	9.072 863	82
9.055 530	1471	9.056 334	702	9.056 744	719	9.058 624	721	9.068 212	597	9.071 674	62	9.072 076	85	9.072 866	82
9.055 531	731	9.056 337	701	9.056 745	719	9.058 642	721	9.068 213	597	9.071 675	62	9.072 077	85	9.072 867	82
9.055 531	1471	9.056 338	701	9.056 750	717	9.058 643	721	9.068 214	597	9.071 676	62	9.072 078	85	9.072 869	89
9.055 532	731	9.056 340	701	9.056 751	717	9.058 644	721	9.068 215	597	9.071 677	62	9.072 079	85	9.072 870	89
9.055 532	1471	9.056 341	701	9.056 752	717	9.058 663	721	9.068 216	597	9.071 678	62	9.072 080	86	9.072 871	89
9.055 533	731	9.056 399	712	9.056 753	717	9.058 664	721	9.068 218	597	9.071 679	62	9.072 081	86	9.072 872	89
9.055 533	1471	9.056 400	712	9.056 754	717	9.058 682	721	9.068 220	597	9.071 680	63	9.072 082	86	9.072 873	89
9.055 534	731	9.056 401	712	9.056 755	717	9.058 683	721	9.068 224	597	9.071 681	63	9.072 085	86	9.072 874	89
9.055 534	1471	9.056 402	712	9.056 756	717	9.058 684	721	9.068 225	597	9.071 682	63	9.072 090	86	9.072 875	89
9.055 535	731	9.056 403	712	9.056 759	717	9.058 809	725	9.068 226	597	9.071 683	63	9.072 092	86	9.072 876	89
9.055 535	1471	9.056 404	712	9.056 760	717	9.058 812	725	9.068 227	597	9.071 684	63	9.072 093	86	9.072 877	89
9.055 540	730	9.056 405	712	9.056 761	717	9.058 839	725	9.068 228	597	9.071 685	63	9.072 094	86	9.072 878	89
9.055 540	1471	9.056 406	712	9.056 762	717	9.058 842	725	9.068 229	597	9.071 686	64	9.072 095	86	9.072 879	89
9.055 541	730	9.056 407	712	9.056 763	717	9.058 865	725	9.068 276	597	9.071 687	64	9.072 155	66	9.072 880	89
9.055 541	1471	9.056 410	713	9.056 764	717	9.058 869	725	9.068 277	597	9.071 688	64	9.072 156	66	9.072 881	89
9.055 542	730	9.056 411	713	9.056 765	717	9.058 872	725	9.068 279	597	9.071 689	65	9.072 157	66	9.072 882	89
9.055 542	1471	9.056 412	713	9.056 771	719	9.058 935	725	9.068 281	597	9.071 690	65	9.072 158	66	9.072 883	89
9.055 543	730	9.056 413	713	9.056 772	719	9.058 939	725	9.068 282	597	9.071 691	65	9.072 159	1231	9.072 884	89
9.055 543	1471	9.056 414	713	9.056 773	719	9.058 942	725	9.068 283	597	9.071 692	69	9.072 160	78	9.072 885	89
9.055 550	731	9.056 415	713	9.056 774	719	9.058 946	725	9.068 284	597	9.071 701	66	9.072 161	78	9.072 886	89
9.055 550	1471	9.056 416	713	9.056 775	719	9.058 951	725	9.068 285	597	9.071 702	66	9.072 162	78	9.072 887	89
9.055 551	731	9.056 417	713	9.056 777	719	9.058 965	725	9.068 287	597	9.071 706	66	9.072 163	78	9.072 893	89
9.055 551	1471	9.056 419	713	9.056 780	717	9.058 969	725	9.068 288	597	9.071 707	66	9.072 164	69	9.072 898	90
9.055 552	731	9.056 420	713	9.056 781	717	9.058 975	382	9.068 289	597	9.071 817	73	9.072 165	69	9.072 894	89
9.055 552	1471	9.056 421	713	9.056 782	717	9.058 981	725	9.068 290	597	9.071 824	73	9.072 166	69	9.072 895	89
9.055 553	731	9.056 422	713	9.056 783	717	9.058 987	725	9.068 291	597	9.071 836	73	9.072 167	69	9.072 896	89
9.055 553	1471	9.056 423	713	9.056 784	717	9.059 513	741	9.068 292	597	9.071 844	73	9.072 178	1206	9.072 897	89
9.056 196	702	9.056 424	713	9.056 785	717	9.059 514	741	9.068 293	597	9.071 854	73	9.072 179	1207	9.072 898	89
9.056 198	701	9.056 425	713	9.056 787	717	9.060 102	711	9.068 294	597	9.071 863	73	9.072 181	63	9.072 899	89
9.056 199	701	9.056 426	713	9.056 790	719	9.060 103	711	9.068 295	597	9.071 896	70	9.072 182	63	9.072 900	89
9.056 200	701	9.056 427	713	9.056 801	719	9.060 104	711	9.068 296	597	9.071 897	71	9.072 183	63	9.072 901	89
9.056 201	701	9.056 450	703	9.056 802	717	9.060 105	711	9.068 500	717	9.071 899	70	9.072 184	63	9.072 902	89
9.056 202	701	9.056 451	703	9.056 803	717	9.060 106	711	9.068 501	717	9.071 917	73	9.072 185	63	9.072 903	89
9.056 203	701	9.056 452	703	9.056 805	717	9.060 200	712	9.068 502	717	9.071 924	73	9.072 210	69	9.072 904	89
9.056 204	701	9.056 453	703	9.056 807	733	9.060 201	712	9.068 503	717	9.071 936	73	9.072 211	69	9.072 905	82
9.056 205	701	9.056 454	703	9.056 809	733	9.060 202	712	9.068 504	717	9.071 944	73	9.072 325	70	9.072 914	87
9.056 206	701	9.056 455	703	9.056 810	733	9.060 203	712	9.068 505	717	9.071 954	73	9.072 326	70	9.072 915	87
9.056 207	701	9.056 456	703	9.056 811	719	9.060 204	712	9.068 506	717	9.071 961	64	9.072 327	70	9.072 919	87
9.056 208	701	9.056 457	703	9.056 814	719	9.060 205	712	9.068 507	717	9.071 962	64	9.072 331	62	9.072 924	87
9.056 209	701	9.056 459	703	9.056 816	717	9.060 206	712	9.069 003	442	9.071 963	73	9.072 332	62	9.072 929	87
9.056 210	701	9.056 480	711	9.056 820	733	9.060 207	712	9.069 003	1107	9.071 964	64	9.072 334	62	9.072 932	90
9.056 211	701	9.056 482	711	9.056 821	733	9.060 303	712	9.069 011	382	9.071 966	70	9.072 335	62	9.072 934	90
9.056 212	701	9.056 483	711	9.056 822	733	9.060 304	712	9.069 922	102	9.071 968	7				

Bestellnummernindex - Numerical index - Index numérique - Índice Numérico - Índice numerico - Indeks numerów katalogowych - Указатель по номерам

9.073 051	88	9.073 510	73	9.103 146	1227	9.106 103	188	9.112 589	1275	9.118 925	176	9.130 383	298	9.140 322	620
9.073 052	88	9.073 511	73	9.103 147	1227	9.106 104	188	9.112 595	1277	9.118 926	176	9.130 384	297	9.140 323	620
9.073 053	88	9.073 512	73	9.103 148	48	9.106 105	188	9.112 603	1275	9.118 928	176	9.130 385	298	9.140 324	620
9.073 054	88	9.073 512	543	9.103 149	48	9.106 106	188	9.112 604	1275	9.118 929	176	9.130 386	298	9.140 325	620
9.073 055	88	9.073 513	73	9.103 200	70	9.106 107	188	9.112 607	1275	9.118 945	177	9.130 387	298	9.140 326	620
9.073 056	88	9.073 514	73	9.103 201	70	9.106 205	188	9.112 609	1275	9.118 946	176	9.130 388	298	9.140 327	620
9.073 057	88	9.073 515	73	9.103 202	70	9.106 208	189	9.112 612	1276	9.118 947	176	9.130 389	298	9.140 328	620
9.073 060	88	9.073 516	73	9.103 221	76	9.106 210	189	9.112 613	1276	9.118 960	175	9.130 390	298	9.140 329	620
9.073 061	88	9.073 517	83	9.103 222	76	9.106 212	189	9.114 310	1475	9.118 961	175	9.130 391	298	9.140 330	620
9.073 062	88	9.073 518	83	9.103 223	76	9.106 213	189	9.114 331	1476	9.118 962	175	9.130 392	298	9.140 331	620
9.073 063	88	9.073 519	83	9.103 224	76	9.106 215	189	9.115 036	114	9.118 963	175	9.130 393	1236	9.140 332	620
9.073 064	88	9.073 520	83	9.103 225	76	9.106 240	189	9.115 041	114	9.118 964	175	9.130 394	1236	9.140 333	620
9.073 065	88	9.073 681	75	9.103 226	76	9.106 241	189	9.115 045	114	9.118 965	175	9.130 395	1236	9.140 334	620
9.073 066	88	9.073 682	75	9.103 227	76	9.106 242	189	9.115 140	114	9.118 970	176	9.130 396	1236	9.140 335	620
9.073 067	88	9.073 684	75	9.103 228	76	9.106 261	189	9.115 150	114	9.118 971	177	9.130 397	1236	9.140 336	620
9.073 070	88	9.073 686	75	9.103 229	76	9.106 263	189	9.115 160	114	9.118 975	176	9.130 398	1236	9.140 337	620
9.073 071	48	9.073 688	75	9.103 230	76	9.106 266	189	9.115 245	114	9.118 976	176	9.130 400	1236	9.140 385	619
9.073 071	88	9.073 740	1226	9.103 231	76	9.106 278	190	9.115 265	114	9.118 977	176	9.130 603	298	9.140 386	619
9.073 072	48	9.073 741	1227	9.103 232	76	9.106 279	190	9.115 295	114	9.118 978	176	9.130 626	298	9.140 387	619
9.073 072	88	9.073 742	1227	9.103 233	76	9.106 280	190	9.115 301	105	9.118 979	176	9.130 651	298	9.140 388	619
9.073 073	48	9.073 743	1227	9.103 234	76	9.106 284	190	9.115 302	105	9.118 980	177	9.130 652	298	9.140 389	619
9.073 073	88	9.073 778	75	9.103 235	76	9.106 286	190	9.115 303	105	9.118 981	177	9.130 657	298	9.140 401	624
9.073 074	48	9.073 779	75	9.103 236	76	9.106 287	190	9.115 304	105	9.118 982	177	9.139 806	1480	9.140 410	634
9.073 074	88	9.073 781	75	9.103 237	76	9.106 288	190	9.115 305	105	9.118 983	177	9.139 809	1480	9.140 411	634
9.073 075	88	9.073 782	75	9.103 238	76	9.106 360	1545	9.115 306	105	9.118 984	177	9.139 867	1480	9.140 412	634
9.073 170	85	9.074 051	88	9.103 239	76	9.106 361	1545	9.115 307	105	9.119 900	240	9.139 868	1480	9.140 413	634
9.073 171	85	9.074 052	88	9.103 248	76	9.106 362	1545	9.115 308	105	9.129 800	296	9.139 870	1480	9.140 414	634
9.073 172	85	9.074 053	88	9.103 249	76	9.106 363	1545	9.115 310	105	9.129 801	296	9.139 874	1481	9.140 415	634
9.073 300	1226	9.074 054	88	9.103 250	76	9.106 364	1545	9.115 311	105	9.129 802	296	9.139 875	1481	9.140 416	634
9.073 310	95	9.074 061	88	9.103 251	76	9.106 365	1545	9.115 312	105	9.129 803	296	9.139 876	1481	9.140 508	662
9.073 311	95	9.074 062	88	9.103 252	76	9.106 366	1545	9.115 313	105	9.129 805	296	9.139 882	1481	9.140 511	662
9.073 312	95	9.074 063	88	9.103 253	76	9.106 367	1545	9.115 314	105	9.129 806	297	9.139 883	1481	9.140 515	629
9.073 313	95	9.074 064	88	9.103 254	77	9.106 368	1545	9.115 315	105	9.129 807	297	9.139 888	1482	9.140 516	629
9.073 314	81	9.074 071	88	9.103 255	77	9.106 369	1545	9.115 316	105	9.129 808	297	9.139 889	1482	9.140 517	629
9.073 315	81	9.074 072	88	9.103 256	77	9.106 370	1545	9.115 350	381	9.129 902	1236	9.139 890	1483	9.140 518	629
9.073 318	81	9.074 073	88	9.103 257	77	9.106 371	1545	9.115 351	381	9.129 904	1236	9.139 892	266	9.140 519	629
9.073 319	81	9.100 030	169	9.103 258	77	9.106 450	192	9.115 404	942	9.129 909	1236	9.139 893	266	9.140 520	629
9.073 320	81	9.100 030	764	9.103 259	77	9.106 460	192	9.115 411	942	9.129 913	1236	9.139 894	266	9.140 536	645
9.073 321	87	9.100 031	169	9.103 260	84	9.106 508	192	9.115 430	942	9.129 914	1236	9.139 896	1480	9.140 537	645
9.073 322	87	9.100 031	764	9.103 261	84	9.106 510	192	9.115 450	942	9.129 916	1236	9.139 916	58	9.140 538	645
9.073 344	77	9.100 032	169	9.103 262	84	9.106 515	192	9.115 480	942	9.129 918	1236	9.139 917	58	9.140 539	645
9.073 345	77	9.100 032	764	9.103 263	84	9.106 520	192	9.115 485	942	9.129 919	1236	9.139 918	58	9.140 783	165
9.073 346	77	9.100 033	170	9.103 264	84	9.106 525	192	9.115 487	942	9.129 923	1236	9.139 919	58	9.140 784	1207
9.073 347	77	9.100 040	170	9.103 265	84	9.106 530	192	9.115 502	942	9.129 928	1236	9.139 925	58	9.140 786	165
9.073 355	93	9.100 041	170	9.103 266	84	9.106 538	192	9.115 510	1028	9.129 931	1236	9.139 926	58	9.140 787	1207
9.073 356	93	9.100 042	170	9.103 267	84	9.106 540	192	9.115 515	662	9.129 932	1236	9.139 929	56	9.140 788	1207
9.073 357	93	9.100 043	170	9.103 268	84	9.106 545	192	9.115 611	655	9.129 933	1236	9.139 930	56	9.140 789	1207
9.073 358	93	9.100 044	170	9.103 269	84	9.106 550	192	9.115 614	655	9.129 934	1236	9.139 931	56	9.140 790	1207
9.073 359	93	9.100 045	170	9.103 270	84	9.106 555	192	9.115 615	655	9.129 938	1236	9.139 932	56	9.140 791	1207
9.073 360	93	9.100 046	170	9.103 271	84	9.106 560	192	9.115 618	655	9.129 943	1236	9.139 933	56	9.140 792	1207
9.073 361	93	9.100 047	170	9.103 272	84	9.106 580	1326	9.115 631	655	9.130 001	298	9.139 934	56	9.140 813	165
9.073 362	93	9.100 048	170	9.103 273	84	9.106 581	1326	9.115 632	655	9.130 002	298	9.139 935	56	9.140 814	165
9.073 363	93	9.100 049	170	9.103 274	84	9.106 582	1326	9.115 633	655	9.130 003	298	9.139 936	56	9.140 815	165
9.073 364	93	9.100 050	170	9.103 275	84	9.106 583	1326	9.115 634	655	9.130 004	298	9.139 937	56	9.140 817	165
9.073 365	80	9.100 051	170	9.103 276	84	9.110 010	194	9.115 635	655	9.130 007	298	9.139 938	56	9.141 014	19
9.073 366	80	9.100 052	170	9.103 277	84	9.110 011	194	9.115 637	655	9.130 009	298	9.139 939	56	9.141 017	19
9.073 369	80	9.102 204	49	9.103 278	84	9.110 215	542	9.115 638	655	9.130 010	298	9.139 970	59	9.141 024	19
9.073 370	80	9.102 206	49	9.103 279	90	9.110 215	1213	9.115 639	655	9.130 013	298	9.139 975	59	9.141 028	19
9.073 373	82	9.102 208	49	9.103 280	90	9.110 220	542	9.115 642	655	9.130 016	298	9.139 996	59	9.141 032	19
9.073 374	82	9.102 210	49	9.103 281	90	9.110 220	1213	9.115 644	655	9.130 017	298	9.139 997	57	9.141 036	19
9.073 375	82	9.102 214	49	9.103 282	90	9.110 225	542	9.115 648	655	9.130 018	298	9.139 997	60	9.141 039	19
9.073 376	82	9.102 216	49	9.103 283	90	9.110 225	1213	9.116 771	158	9.130 050	1496	9.139 999	59	9.141 044	19
9.073 377	82	9.102 218	49	9.103 284	1348	9.110 230	542	9.116 772	158	9.130 051	1496	9.140 000	60	9.141 053	19
9.073 378	82	9.102 220	49	9.103 285	1348	9.110 230	1213	9.116 773	158	9.130 052	1496	9.140 001	59	9.141 054	19
9.073 379	82	9.102 224	49	9.103 286	1348	9.110 236	542	9.116 775	158	9.130 053	1496	9.140 002	59	9.141 063	19
9.073 380	82	9.102 226	49	9.103 287	1348	9.110 236	1213	9.116 776	158	9.130 054	1496	9.140 003	60	9.141 068	19
9.073 381	82	9.102 228	49	9.103 288	1348	9.110 237	542	9.116 777	158	9.130 055	1496	9.140 004	59	9.141 073	19
9.073 388	48	9.102 230	49	9.103 289	1348	9.110 237	1213	9.116 778	158	9.130 056	1496	9.140 011	59	9.141 079	19
9.073 389	48	9.102 232	49	9.105 700	253	9.110 29									

Bestellnummernindex - Numerical index - Index numérique - Índice Numérico - Índice numerico - Indeks numerów katalogowych - Указатель по номерам

9.141 170	1371	9.142 054	630	9.144 156	1153	9.150 221	115	9.160 036	1402	9.161 155	1116	9.170 002	1366	9.180 112	163
9.141 171	1371	9.142 063	630	9.144 157	1153	9.150 226	115	9.160 037	1402	9.161 161	1116	9.170 003	1366	9.180 117	163
9.141 172	1371	9.142 071	630	9.144 201	1154	9.150 312	117	9.160 040	1402	9.161 162	1116	9.170 003	1366	9.180 120	163
9.141 173	1371	9.142 076	630	9.144 202	1154	9.150 315	117	9.160 041	1368	9.161 163	1116	9.170 004	1366	9.180 125	163
9.141 174	1371	9.142 120	631	9.144 205	1154	9.150 318	117	9.160 042	1368	9.161 164	1116	9.170 004	1366	9.180 130	163
9.141 180	19	9.142 121	631	9.144 210	1154	9.150 321	117	9.160 043	1368	9.161 165	1116	9.170 005	1366	9.180 140	163
9.141 181	19	9.142 122	631	9.144 220	1154	9.150 325	117	9.160 050	1370	9.161 171	1116	9.170 005	1366	9.180 142	163
9.141 182	19	9.142 123	631	9.144 240	1154	9.150 330	117	9.160 052	1370	9.161 172	1116	9.170 006	1366	9.180 199	163
9.141 183	19	9.142 124	631	9.144 250	1154	9.150 565	117	9.160 053	1370	9.161 173	1116	9.170 015	1404	9.180 200	163
9.141 184	19	9.142 126	631	9.144 300	1152	9.150 570	117	9.160 054	1370	9.161 174	1116	9.170 020	1404	9.180 201	163
9.141 185	19	9.142 127	631	9.144 301	1152	9.150 610	116	9.160 055	1369	9.161 175	1116	9.170 141	1365	9.180 210	162
9.141 186	19	9.142 128	631	9.144 302	1152	9.150 620	117	9.160 056	1369	9.161 181	1117	9.170 143	1365	9.180 215	162
9.141 187	19	9.142 129	631	9.144 340	1152	9.150 643	120	9.160 057	1369	9.161 182	1117	9.170 146	1365	9.180 220	162
9.141 224	20	9.142 130	631	9.144 350	1152	9.150 644	120	9.160 058	1369	9.161 183	1117	9.170 148	1365	9.180 230	162
9.141 236	20	9.142 131	631	9.144 360	1152	9.150 645	120	9.160 061	1369	9.161 184	1117	9.170 151	1365	9.190 001	26
9.141 244	20	9.142 132	631	9.144 361	1152	9.150 646	120	9.160 062	1369	9.161 185	1117	9.170 153	1365	9.190 003	26
9.141 254	20	9.142 133	631	9.144 372	1153	9.150 665	116	9.160 063	1369	9.161 186	1117	9.170 401	1364	9.190 006	26
9.141 260	1371	9.142 134	631	9.144 385	1153	9.150 685	116	9.160 070	1402	9.161 187	1117	9.170 417	1364	9.190 008	26
9.141 261	1371	9.142 135	631	9.144 390	1155	9.150 700	116	9.160 072	1402	9.161 188	1117	9.170 432	1364	9.190 011	26
9.141 263	1371	9.142 136	631	9.144 391	1155	9.150 703	116	9.160 075	1402	9.161 189	1117	9.170 442	1364	9.190 013	26
9.141 270	19	9.142 137	631	9.144 410	1152	9.150 704	116	9.160 090	1402	9.161 190	1117	9.170 443	1364	9.190 016	26
9.141 270	884	9.142 138	631	9.144 450	1152	9.150 705	116	9.160 092	1402	9.161 208	1117	9.170 448	1364	9.190 021	26
9.141 271	19	9.142 139	631	9.144 460	1153	9.150 717	145	9.160 095	1402	9.161 210	1120	9.170 451	1364	9.190 023	26
9.141 271	884	9.142 140	631	9.144 465	1153	9.150 718	145	9.160 120	133	9.161 211	1120	9.170 456	1364	9.190 026	26
9.141 272	19	9.142 141	631	9.144 490	1153	9.150 719	145	9.160 121	133	9.161 215	1120	9.170 460	1364	9.190 028	26
9.141 272	884	9.142 142	631	9.144 510	1154	9.150 720	145	9.160 123	133	9.161 224	1120	9.170 461	1364	9.190 033	26
9.141 273	19	9.142 143	631	9.144 601	1154	9.150 721	145	9.160 124	137	9.161 230	1120	9.170 570	1364	9.190 036	26
9.141 273	884	9.142 246	630	9.144 602	1154	9.150 722	108	9.160 130	134	9.161 235	1120	9.170 571	1364	9.190 038	26
9.141 274	19	9.142 251	630	9.144 605	1154	9.150 723	108	9.160 131	134	9.161 250	1120	9.170 572	1364	9.190 101	27
9.141 274	884	9.142 257	630	9.144 610	1154	9.150 724	108	9.160 131	1325	9.161 260	1120	9.170 573	1364	9.190 103	27
9.141 275	19	9.142 259	630	9.144 620	1154	9.150 726	108	9.160 135	134	9.161 270	1119	9.170 574	1364	9.190 106	27
9.141 275	884	9.142 476	630	9.144 640	1154	9.150 727	108	9.160 200	1403	9.161 272	1119	9.170 575	1364	9.190 108	27
9.141 276	19	9.142 697	630	9.144 660	1156	9.150 728	108	9.160 205	135	9.161 274	1119	9.170 576	1364	9.190 111	27
9.141 276	884	9.142 698	630	9.144 662	1156	9.150 729	108	9.160 210	135	9.161 284	1121	9.170 577	1364	9.190 112	27
9.141 277	19	9.142 699	630	9.144 663	1156	9.150 730	108	9.160 270	190	9.161 285	1121	9.170 578	1364	9.190 113	27
9.141 277	884	9.142 726	630	9.144 664	1156	9.150 732	108	9.160 271	190	9.161 286	1121	9.170 579	1364	9.190 116	27
9.141 280	20	9.142 726	810	9.144 666	1156	9.150 733	108	9.160 380	134	9.161 287	1121	9.170 580	1364	9.190 121	27
9.141 280	885	9.142 727	630	9.144 667	1156	9.150 800	116	9.160 380	1118	9.161 288	1121	9.170 581	1364	9.190 123	27
9.141 281	20	9.142 727	810	9.144 730	1153	9.150 801	116	9.160 381	134	9.161 289	1121	9.170 621	1235	9.190 126	27
9.141 281	885	9.142 728	630	9.144 750	1152	9.150 802	116	9.160 381	1118	9.161 291	1119	9.170 622	1235	9.190 128	27
9.141 282	20	9.142 728	810	9.144 751	1153	9.150 810	116	9.160 386	135	9.161 292	1119	9.170 623	1235	9.190 133	27
9.141 282	885	9.142 741	630	9.144 756	1153	9.150 811	116	9.160 386	1118	9.161 293	1119	9.170 624	1235	9.190 136	27
9.141 283	20	9.142 741	810	9.144 758	1153	9.150 812	116	9.160 387	135	9.161 294	1119	9.170 701	1096	9.190 138	27
9.141 283	885	9.142 742	630	9.144 760	1155	9.150 815	119	9.160 387	1118	9.161 295	1120	9.171 010	133	9.190 151	27
9.141 304	1346	9.142 742	810	9.144 761	1155	9.150 816	119	9.160 388	135	9.161 296	1120	9.171 011	133	9.190 153	27
9.141 305	1346	9.142 744	630	9.144 770	1155	9.150 817	119	9.160 388	1118	9.161 297	1120	9.171 013	133	9.190 156	27
9.141 306	1346	9.142 744	810	9.144 771	1155	9.150 820	118	9.160 391	135	9.161 298	1120	9.171 014	133	9.190 158	27
9.141 307	1346	9.142 747	630	9.144 801	1155	9.151 040	1095	9.160 391	1118	9.161 300	1121	9.171 016	133	9.190 161	27
9.141 308	1346	9.142 747	810	9.145 020	1160	9.151 050	1095	9.160 392	135	9.161 302	1120	9.171 020	133	9.190 162	27
9.141 309	1346	9.142 754	630	9.148 099	271	9.151 051	1095	9.160 392	1118	9.161 340	1123	9.171 025	133	9.190 163	27
9.141 310	1346	9.142 754	810	9.148 100	271	9.151 052	1095	9.160 393	135	9.161 341	1123	9.171 030	133	9.190 166	27
9.141 311	1346	9.142 757	630	9.148 101	270	9.151 053	1095	9.160 393	1118	9.161 350	1123	9.171 110	133	9.190 171	27
9.141 312	1346	9.142 757	810	9.148 104	270	9.151 055	1095	9.160 394	137	9.161 352	1123	9.171 111	133	9.190 173	27
9.141 313	1346	9.142 759	630	9.148 300	271	9.151 106	1095	9.160 602	127	9.161 380	1120	9.171 113	133	9.190 176	27
9.141 381	21	9.142 759	810	9.148 301	271	9.151 107	1095	9.160 603	127	9.161 381	1120	9.171 114	133	9.190 178	27
9.141 382	21	9.142 766	631	9.148 302	271	9.151 108	1095	9.160 651	126	9.161 382	1120	9.171 115	133	9.190 183	27
9.141 383	21	9.142 766	826	9.148 303	294	9.151 155	1095	9.160 652	126	9.161 395	1119	9.171 116	133	9.190 186	27
9.141 384	21	9.142 767	631	9.148 304	294	9.151 181	1094	9.160 653	126	9.161 400	1123	9.171 121	132	9.190 188	27
9.141 385	21	9.142 767	826	9.149 842	593	9.151 182	1094	9.160 654	126	9.163 250	1122	9.171 122	132	9.190 200	25
9.141 417	21	9.142 768	631	9.149 843	593	9.151 423	1095	9.160 655	126	9.163 251	1122	9.171 123	132	9.190 202	25
9.141 424	21	9.142 768	826	9.149 844	593	9.151 427	1095	9.160 656	128	9.163 252	1122	9.171 124	132	9.190 205	25
9.141 436	21	9.142 781	631	9.149 860	432	9.151 433	1095	9.160 657	128	9.163 253	1122	9.171 211	133	9.190 215	27
9.141 444	21	9.142 781	826	9.149 862	432	9.151 442	1095	9.160 658	128	9.163 273	1124	9.171 213	133	9.190 230	27
9.141 454	21	9.142 782	631	9.149 872	432	9.151 453	1095	9.160 659	128	9.163 274	1124	9.171 214	133	9.190 235	27
9.141 464	21	9.142 782	826	9.149 873	432	9.151 680	1094	9.160 702	1370	9.163 275	1124	9.171 215	133	9.190 240	27
9.141 468	21	9.142 784	631	9.149 874	432	9.151 682	1094	9.160 703	1370	9.163 277	1124	9.171 217	133	9.190 410	27
9.141 471	21	9.142 784	826	9.149 875	432	9.151 688	1094	9.160 704	1370	9.163 278	1124	9.171 221	133	9.190 416	27

Bestellnummernindex - Numerical index - Index numérique - Índice Numérico - Índice numerico - Indeks numerów katalogowych - Указатель по номерам

9.191 268	1163	9.193 985	36	9.197 147	496	9.198 925	462	9.201 035	138	9.205 011	148	9.205 583	151	9.206 744	1330
9.191 268	1163	9.193 985	762	9.197 149	496	9.198 925	475	9.201 035	550	9.205 012	148	9.205 584	151	9.206 750	1330
9.191 272	1162	9.193 986	762	9.197 176	496	9.198 930	462	9.201 040	138	9.205 013	148	9.205 585	151	9.206 752	1330
9.191 277	1166	9.193 987	762	9.197 177	496	9.198 930	475	9.201 040	550	9.205 014	148	9.205 586	151	9.206 754	1330
9.191 278	1166	9.193 988	36	9.197 178	496	9.198 935	462	9.201 042	138	9.205 015	148	9.205 588	151	9.206 760	1330
9.191 292	1163	9.193 989	36	9.197 179	496	9.198 935	475	9.201 042	550	9.205 017	148	9.205 589	151	9.206 762	1330
9.191 293	1163	9.193 997	35	9.197 194	496	9.198 940	462	9.201 043	138	9.205 018	148	9.205 590	151	9.206 764	1330
9.191 295	1163	9.193 998	35	9.197 195	496	9.198 940	475	9.201 043	550	9.205 020	148	9.205 591	151	9.206 766	1330
9.192 387	1168	9.194 002	951	9.197 251	632	9.198 945	462	9.201 045	138	9.205 157	146	9.205 592	151	9.206 770	1330
9.192 401	1167	9.194 003	951	9.197 252	632	9.198 945	475	9.201 045	550	9.205 158	146	9.205 593	151	9.206 772	1330
9.192 403	1167	9.194 004	951	9.197 253	632	9.198 950	462	9.201 047	138	9.205 159	146	9.205 595	151	9.206 774	1330
9.192 404	1167	9.194 005	264	9.197 256	632	9.198 950	475	9.201 047	550	9.205 160	146	9.205 596	151	9.206 776	1330
9.192 405	1167	9.194 005	1084	9.197 257	632	9.198 960	462	9.201 048	138	9.205 166	146	9.205 597	151	9.206 779	1330
9.192 406	1167	9.194 006	264	9.197 258	632	9.198 960	475	9.201 048	550	9.205 170	146	9.205 598	151	9.206 780	1330
9.192 415	1167	9.194 006	1084	9.197 311	632	9.198 970	462	9.201 049	138	9.205 171	146	9.205 608	149	9.206 782	1330
9.192 418	1167	9.194 007	264	9.197 312	632	9.198 970	475	9.201 049	550	9.205 173	146	9.205 609	149	9.206 784	1330
9.192 420	1169	9.194 007	1084	9.197 313	632	9.198 980	462	9.201 050	138	9.205 174	146	9.205 616	149	9.206 786	1330
9.192 421	1169	9.194 011	638	9.197 314	632	9.198 980	475	9.201 050	550	9.205 179	146	9.205 619	149	9.206 790	1330
9.192 422	1169	9.194 021	38	9.197 321	632	9.200 014	108	9.201 091	138	9.205 180	146	9.205 621	149	9.206 792	1330
9.192 425	1170	9.194 022	38	9.197 322	632	9.200 017	108	9.201 092	138	9.205 184	146	9.205 630	149	9.206 794	1330
9.192 426	1170	9.194 023	38	9.197 355	633	9.200 020	108	9.201 093	138	9.205 187	146	9.205 634	149	9.206 803	1330
9.192 427	1170	9.194 024	38	9.197 356	633	9.200 022	108	9.201 113	138	9.205 192	146	9.205 644	149	9.206 804	1330
9.192 428	1170	9.194 025	38	9.197 359	633	9.200 028	108	9.201 113	548	9.205 195	146	9.205 645	149	9.206 805	1330
9.192 431	1168	9.194 027	35	9.197 363	633	9.200 035	108	9.201 118	138	9.205 200	146	9.205 657	149	9.206 807	1330
9.192 434	1168	9.194 028	35	9.197 364	633	9.200 037	108	9.201 118	548	9.205 210	147	9.205 658	149	9.206 808	1330
9.192 435	1168	9.194 029	35	9.197 400	492	9.200 114	108	9.201 121	138	9.205 220	147	9.205 665	149	9.206 809	1330
9.192 436	1169	9.194 513	40	9.197 403	126	9.200 117	108	9.201 121	548	9.205 223	147	9.205 668	149	9.206 810	1330
9.192 437	1169	9.194 514	40	9.197 404	126	9.200 120	108	9.201 125	138	9.205 231	147	9.205 672	149	9.206 811	1330
9.192 441	1170	9.194 515	40	9.197 405	126	9.200 122	108	9.201 125	548	9.205 233	147	9.205 680	149	9.206 812	1330
9.192 445	1168	9.194 516	40	9.197 406	126	9.200 128	108	9.201 126	138	9.205 243	147	9.205 700	150	9.206 813	1330
9.192 446	1169	9.194 517	40	9.197 407	126	9.200 135	108	9.201 126	548	9.205 247	147	9.205 701	150	9.206 814	1330
9.192 447	1169	9.194 523	40	9.197 408	126	9.200 137	108	9.201 131	138	9.205 256	147	9.205 702	150	9.206 815	1330
9.192 448	1169	9.194 524	40	9.197 424	126	9.200 150	107	9.201 131	548	9.205 263	147	9.205 703	150	9.206 816	1330
9.192 450	1170	9.194 525	40	9.197 426	126	9.200 155	107	9.201 135	138	9.205 267	150	9.205 704	150	9.206 817	1330
9.192 501	1173	9.194 526	40	9.197 431	126	9.200 160	107	9.201 135	548	9.205 267	1057	9.205 705	150	9.206 818	1330
9.192 551	1166	9.194 527	40	9.197 433	126	9.200 165	107	9.201 140	138	9.205 271	147	9.205 706	150	9.206 819	1330
9.192 566	1164	9.194 533	40	9.197 435	126	9.200 170	107	9.201 140	548	9.205 275	150	9.205 707	150	9.206 820	1330
9.192 567	1164	9.194 534	40	9.197 490	1367	9.200 177	107	9.201 143	138	9.205 275	1057	9.205 708	150	9.206 821	1330
9.192 568	1164	9.194 535	40	9.197 496	1367	9.200 181	107	9.201 143	548	9.205 280	148	9.205 709	150	9.206 822	1330
9.192 569	1165	9.194 536	40	9.197 497	1367	9.200 182	107	9.201 219	138	9.205 282	147	9.205 745	149	9.206 823	1330
9.192 570	1165	9.194 537	40	9.197 499	1367	9.200 183	107	9.201 219	549	9.205 285	150	9.205 758	149	9.206 824	1330
9.192 601	1193	9.194 543	40	9.197 502	476	9.200 184	107	9.201 222	138	9.205 285	1057	9.205 765	149	9.206 825	1330
9.192 602	1193	9.194 544	40	9.197 503	476	9.200 203	109	9.201 222	549	9.205 286	147	9.205 769	149	9.206 826	1330
9.192 605	1193	9.194 545	40	9.197 504	476	9.200 204	109	9.201 232	138	9.205 300	150	9.205 772	149	9.206 827	1330
9.192 610	1193	9.194 546	40	9.197 505	476	9.200 205	109	9.201 232	549	9.205 300	1057	9.205 774	149	9.206 828	1330
9.192 611	1193	9.194 547	40	9.197 506	476	9.200 206	109	9.201 235	138	9.205 301	150	9.205 782	149	9.206 829	1330
9.192 612	1193	9.194 553	40	9.197 507	476	9.200 207	109	9.201 235	549	9.205 301	1057	9.205 784	149	9.206 830	1330
9.192 615	1193	9.194 554	40	9.197 508	476	9.200 208	109	9.201 590	114	9.205 302	150	9.205 787	149	9.206 831	1330
9.192 711	1193	9.194 555	40	9.197 509	476	9.200 220	109	9.201 596	114	9.205 302	1057	9.205 792	149	9.206 841	150
9.192 712	1193	9.194 556	40	9.197 510	476	9.200 225	109	9.203 322	639	9.205 303	150	9.205 800	153	9.206 944	150
9.192 714	1193	9.194 557	40	9.197 512	476	9.200 232	109	9.203 323	639	9.205 303	1057	9.205 804	146	9.206 951	150
9.193 112	41	9.194 563	40	9.197 514	476	9.200 269	109	9.203 325	639	9.205 304	150	9.205 805	146	9.206 956	150
9.193 124	41	9.194 564	40	9.197 515	476	9.200 270	109	9.203 328	639	9.205 304	1057	9.205 806	146	9.206 957	150
9.193 141	36	9.194 565	40	9.197 520	476	9.200 275	109	9.203 330	639	9.205 305	150	9.205 807	146	9.206 961	150
9.193 142	36	9.194 566	40	9.197 525	476	9.200 282	109	9.203 332	639	9.205 305	1057	9.205 808	146	9.206 962	150
9.193 143	36	9.194 567	40	9.197 530	476	9.200 283	110	9.203 372	639	9.205 306	150	9.205 809	146	9.206 967	150
9.193 144	36	9.196 020	662	9.197 535	476	9.200 292	110	9.203 373	639	9.205 306	1057	9.205 824	149	9.206 968	150
9.193 145	36	9.196 024	662	9.197 540	476	9.200 297	110	9.203 375	639	9.205 307	150	9.205 825	149	9.206 969	150
9.193 200	40	9.196 036	662	9.197 545	476	9.200 324	107	9.203 376	639	9.205 307	1057	9.205 827	149	9.206 973	150
9.193 201	40	9.196 044	662	9.197 550	476	9.200 327	107	9.203 377	639	9.205 308	150	9.205 830	149	9.206 976	150
9.193 202	40	9.196 054	662	9.197 560	476	9.200 328	107	9.203 378	639	9.205 308	1057	9.205 833	149	9.206 977	150
9.193 230	39	9.196 063	662	9.197 570	476	9.200 335	107	9.203 462	639	9.205 309	150	9.205 836	149	9.207 113	157
9.193 231	39	9.196 224	663	9.197 580	476	9.200 345	107	9.203 463	639	9.205 309	1057	9.205 839	149	9.207 114	157
9.193 232	39	9.196 236	663	9.197 585	477	9.200 370	110	9.203 465	639	9.205 345	148	9.205 898	152	9.207 115	157
9.193 240	39	9.196 244	663	9.197 586	477	9.200 372	110	9.203 466	639	9.205 358	148	9.205 899	152	9.207 116	157
9.193 241	39	9.196 254	663	9.197 587	477	9.200 373	110	9.203 467	639	9.205 359	148	9.205 904	162	9.207 117	157
9.193 242	39	9.196 263	663	9.197 588	477	9.200 374	110	9.203 468	639	9.205 365	148	9.205 906	162	9.207 118	157
9.193 245	39	9.197 001	493	9.197 590	477	9.200 375									

Bestellnummernindex - Numerical index - Index numérique - Índice Numérico - Índice numerico - Indeks numerów katalogowych - Указатель по номерам

9.207 224	161	9.207 873	159	9.209 448	68	9.220 940	1232	9.222 030	1459	9.223 751	294	9.226 650	594	9.230 205	31
9.207 225	161	9.207 874	159	9.209 449	68	9.220 945	1232	9.222 032	1459	9.223 752	294	9.226 651	594	9.230 208	31
9.207 226	161	9.207 875	159	9.209 514	647	9.221 001	1455	9.222 035	1459	9.223 756	294	9.226 652	594	9.230 210	31
9.207 231	161	9.207 922	387	9.209 517	647	9.221 002	1455	9.222 061	1459	9.223 771	294	9.226 653	594	9.230 212	31
9.207 232	161	9.208 076	446	9.209 518	647	9.221 003	1455	9.222 062	1459	9.223 791	294	9.226 654	594	9.230 214	31
9.207 233	161	9.208 080	446	9.209 529	647	9.221 003	1455	9.222 065	1459	9.223 900	180	9.226 655	594	9.230 217	31
9.207 234	161	9.208 081	446	9.209 559	647	9.221 004	1455	9.222 070	1459	9.223 901	180	9.226 656	594	9.230 218	31
9.207 235	161	9.208 100	446	9.209 581	647	9.221 005	1455	9.222 072	1459	9.223 902	181	9.226 657	594	9.230 221	31
9.207 236	161	9.208 101	446	9.209 582	647	9.221 006	1455	9.222 075	1459	9.223 905	182	9.226 658	594	9.230 223	31
9.207 241	160	9.208 131	443	9.209 714	654	9.221 007	1455	9.223 110	81	9.223 906	182	9.226 659	594	9.230 226	31
9.207 242	160	9.208 131	446	9.209 718	654	9.221 010	1455	9.223 111	81	9.223 907	186	9.226 660	594	9.230 229	31
9.207 243	160	9.208 201	1047	9.209 725	654	9.221 011	1455	9.223 112	81	9.223 915	184	9.226 661	594	9.230 231	31
9.207 244	160	9.208 202	1047	9.209 732	654	9.221 012	1455	9.223 113	81	9.223 916	186	9.226 662	594	9.230 236	31
9.207 245	160	9.208 203	1047	9.209 735	654	9.221 013	1455	9.223 114	81	9.223 917	187	9.226 663	594	9.230 241	31
9.207 246	160	9.208 204	1047	9.209 803	156	9.221 014	1455	9.223 120	81	9.223 918	186	9.226 664	594	9.230 247	31
9.207 247	160	9.208 205	1047	9.209 806	156	9.221 015	1455	9.223 152	95	9.223 919	187	9.226 665	594	9.230 250	31
9.207 251	160	9.208 206	1047	9.209 807	156	9.221 016	1455	9.223 155	95	9.224 000	491	9.226 666	594	9.230 256	31
9.207 252	160	9.208 207	1047	9.209 808	156	9.221 021	1455	9.223 160	95	9.224 013	178	9.226 667	594	9.230 260	31
9.207 253	160	9.208 208	1047	9.209 809	156	9.221 022	1455	9.223 162	96	9.224 015	178	9.226 668	594	9.230 264	31
9.207 254	160	9.208 209	1047	9.209 810	156	9.221 023	1455	9.223 223	91	9.224 017	178	9.226 669	594	9.230 271	31
9.207 255	160	9.208 210	1047	9.209 817	156	9.221 024	1455	9.223 224	91	9.224 026	490	9.226 670	594	9.230 279	31
9.207 256	160	9.208 211	1047	9.209 819	156	9.221 025	1455	9.223 225	91	9.224 026	610	9.226 671	594	9.230 287	31
9.207 257	160	9.208 212	1047	9.209 820	156	9.221 026	1455	9.223 226	91	9.224 028	490	9.226 672	594	9.230 294	31
9.207 261	161	9.208 213	1047	9.209 821	156	9.221 040	1458	9.223 231	1229	9.224 028	610	9.226 673	594	9.230 310	30
9.207 262	161	9.208 214	1047	9.209 839	156	9.221 041	1458	9.223 232	1229	9.224 031	490	9.226 674	594	9.230 312	30
9.207 263	161	9.208 215	1047	9.209 840	156	9.221 061	1458	9.223 233	1229	9.224 031	610	9.226 675	594	9.230 314	30
9.207 264	161	9.208 216	1047	9.209 841	156	9.221 062	1458	9.223 234	1229	9.224 032	490	9.226 676	594	9.230 317	30
9.207 265	161	9.208 217	1047	9.209 842	156	9.221 063	1458	9.223 236	91	9.224 032	610	9.226 677	594	9.230 318	30
9.207 266	161	9.208 218	1047	9.209 844	158	9.221 080	1455	9.223 237	91	9.224 033	490	9.226 678	594	9.230 321	30
9.207 270	159	9.208 219	1047	9.209 849	158	9.221 081	1455	9.223 238	91	9.224 033	610	9.226 679	594	9.230 323	30
9.207 291	159	9.208 221	1047	9.209 851	158	9.221 082	1455	9.223 239	91	9.224 041	177	9.226 680	594	9.230 326	30
9.207 292	159	9.208 222	1047	9.209 852	158	9.221 083	1455	9.223 240	91	9.224 042	177	9.226 681	594	9.230 329	30
9.207 293	159	9.208 380	151	9.209 858	158	9.221 084	1455	9.223 261	93	9.224 043	177	9.226 682	594	9.230 331	30
9.207 294	159	9.208 381	151	9.209 859	158	9.221 085	1455	9.223 263	93	9.224 044	177	9.226 683	594	9.230 351	30
9.207 295	159	9.208 382	151	9.210 143	131	9.221 086	1455	9.223 265	93	9.224 045	177	9.226 684	594	9.230 476	30
9.207 296	159	9.208 383	151	9.220 013	119	9.221 105	1456	9.223 269	93	9.224 051	178	9.226 685	594	9.230 477	30
9.207 297	159	9.208 384	151	9.220 015	119	9.221 110	1456	9.223 301	93	9.224 054	178	9.226 686	594	9.230 478	30
9.207 298	159	9.208 385	151	9.220 018	119	9.221 111	1456	9.223 321	93	9.224 105	179	9.226 687	594	9.230 479	30
9.207 299	159	9.208 386	151	9.220 021	119	9.221 112	1456	9.223 331	93	9.224 106	179	9.226 688	594	9.230 480	30
9.207 336	159	9.208 387	151	9.220 025	119	9.221 113	1456	9.223 340	94	9.224 107	179	9.226 689	594	9.230 489	30
9.207 340	159	9.208 439	152	9.220 030	119	9.221 115	1456	9.223 341	94	9.224 110	179	9.226 690	594	9.230 499	30
9.207 356	160	9.208 440	152	9.220 113	119	9.221 116	1456	9.223 342	94	9.224 115	179	9.226 691	594	9.230 503	31
9.207 357	160	9.208 441	152	9.220 115	119	9.221 117	1456	9.223 343	94	9.224 126	179	9.226 692	595	9.230 505	31
9.207 435	164	9.208 442	152	9.220 118	119	9.221 118	1456	9.223 344	94	9.224 127	179	9.226 693	595	9.230 508	31
9.207 436	164	9.208 443	152	9.220 121	119	9.221 119	1456	9.223 345	94	9.224 130	179	9.226 694	595	9.230 510	31
9.207 437	164	9.208 444	152	9.220 125	119	9.221 120	1456	9.223 346	94	9.224 135	179	9.226 695	595	9.230 512	31
9.207 439	164	9.208 445	152	9.220 130	119	9.221 121	1457	9.223 347	94	9.224 206	179	9.226 696	595	9.230 514	31
9.207 440	164	9.208 611	1047	9.220 201	118	9.221 122	1457	9.223 348	94	9.224 207	179	9.226 697	595	9.230 517	31
9.207 445	164	9.209 004	647	9.220 202	118	9.221 125	1457	9.223 349	94	9.224 210	179	9.226 698	595	9.230 518	31
9.207 452	164	9.209 005	647	9.220 203	118	9.221 126	1457	9.223 350	94	9.224 226	179	9.226 699	595	9.230 521	31
9.207 460	164	9.209 015	68	9.220 204	118	9.221 131	1457	9.223 351	94	9.224 227	179	9.226 700	595	9.230 523	31
9.207 465	164	9.209 019	68	9.220 205	118	9.221 132	1457	9.223 354	94	9.224 230	179	9.226 701	595	9.230 526	31
9.207 510	164	9.209 026	68	9.220 206	118	9.221 172	1456	9.223 355	94	9.224 245	181	9.226 702	595	9.230 529	31
9.207 512	164	9.209 033	68	9.220 207	118	9.221 196	1458	9.223 356	94	9.224 251	181	9.226 703	595	9.230 531	31
9.207 514	164	9.209 044	68	9.220 208	118	9.221 270	1493	9.223 357	94	9.224 252	181	9.226 704	595	9.230 536	31
9.207 517	164	9.209 065	67	9.220 210	118	9.221 271	1493	9.223 358	94	9.224 254	180	9.226 705	595	9.230 541	31
9.207 521	164	9.209 067	67	9.220 213	118	9.221 272	1493	9.223 359	94	9.224 257	181	9.226 706	595	9.230 547	31
9.207 525	164	9.209 069	67	9.220 215	118	9.221 273	1493	9.223 360	94	9.224 258	182	9.226 707	595	9.230 550	31
9.207 529	164	9.209 070	69	9.220 216	118	9.221 274	1493	9.223 370	94	9.224 264	182	9.226 708	595	9.230 556	31
9.207 601	159	9.209 071	69	9.220 218	118	9.221 275	1493	9.223 371	94	9.224 266	490	9.226 709	595	9.230 560	31
9.207 602	159	9.209 072	69	9.220 221	118	9.221 276	1493	9.223 372	94	9.224 266	610	9.226 710	595	9.230 564	31
9.207 611	159	9.209 073	69	9.220 313	118	9.221 277	1491	9.223 373	94	9.224 267	180	9.226 711	595	9.230 571	31
9.207 612	159	9.209 074	69	9.220 318	118	9.221 278	1492	9.223 374	94	9.224 268	182	9.226 712	595	9.230 579	31
9.207 621	159	9.209 078	68	9.220 321	118	9.221 279	1492	9.223 375	94	9.224 269	182	9.226 713	595	9.230 587	31
9.207 707	164	9.209 079	68	9.220 363	118	9.221 280	1492	9.223 376	94	9.224 270	181	9.226 714	595	9.230 594	31
9.207 708	164	9.209 080	68	9.220 368	118	9.221 281	1494	9.223 377	94	9.224 274	182	9.226 715	595	9.230 640	30
9.207 709	164	9.209 082	68	9.220 371	118	9.221 282	1494	9.223 378	94	9.224 278	182	9.226 716	595	9.230 641	30
9.207 710	164	9.209 084	68	9.220 415	119	9.221 283	1494	9.223 379	94	9.224 291	180	9.226 717	595	9.230 642	30

Bestellnummernindex - Numerical index - Index numérique - Índice Numérico - Índice numerico - Indeks numerów katalogowych - Указатель по номерам

9.230 821	1377	9.231 345	1377	9.236 025	386	9.246 310	390	9.250 985	111	9.252 335	750	9.270 115	1021	9.272 118	932
9.230 822	1377	9.231 347	1377	9.236 026	386	9.246 311	390	9.250 986	111	9.252 338	750	9.270 116	1021	9.272 121	934
9.230 823	1377	9.231 369	1376	9.236 027	386	9.246 312	390	9.251 023	98	9.252 339	750	9.270 117	1021	9.272 122	934
9.230 824	1377	9.231 372	1376	9.236 028	386	9.246 313	390	9.251 036	98	9.252 500	749	9.270 144	1023	9.272 124	934
9.230 825	1377	9.231 374	1376	9.236 701	392	9.246 314	390	9.251 123	98	9.252 501	749	9.270 147	1023	9.272 125	934
9.230 826	1377	9.231 375	1376	9.236 702	392	9.246 315	390	9.251 128	98	9.252 502	749	9.270 148	1023	9.272 127	934
9.230 827	1377	9.231 377	1376	9.236 705	393	9.246 316	390	9.251 133	98	9.252 503	749	9.270 155	1022	9.272 129	934
9.230 828	1377	9.231 379	1376	9.236 706	392	9.246 317	390	9.251 138	98	9.252 504	749	9.270 156	1022	9.272 131	934
9.230 829	1377	9.231 381	1376	9.236 710	388	9.246 318	390	9.251 141	98	9.252 505	749	9.270 157	1022	9.272 260	927
9.230 830	1377	9.231 385	1376	9.236 711	388	9.246 319	390	9.251 146	98	9.252 506	749	9.270 158	1022	9.272 261	927
9.230 831	1377	9.231 388	1376	9.236 712	388	9.250 030	112	9.251 157	98	9.252 512	106	9.270 159	1022	9.272 262	927
9.230 832	1377	9.231 403	1377	9.236 713	388	9.250 035	112	9.251 161	98	9.252 513	106	9.270 160	1022	9.272 263	927
9.230 833	1377	9.231 404	1377	9.236 714	388	9.250 040	112	9.251 169	98	9.252 514	106	9.270 161	1021	9.272 264	927
9.230 834	1377	9.231 413	1377	9.236 715	394	9.250 045	112	9.251 185	98	9.252 515	106	9.270 162	1021	9.272 265	927
9.230 835	1377	9.231 414	1377	9.236 716	394	9.250 050	112	9.251 186	98	9.252 516	106	9.270 163	1021	9.272 266	927
9.230 836	1377	9.231 421	1376	9.236 717	394	9.250 060	112	9.251 187	98	9.253 006	790	9.270 164	1021	9.272 267	927
9.230 837	1377	9.231 422	1376	9.236 718	394	9.250 070	112	9.251 188	98	9.253 008	790	9.270 165	1021	9.272 268	927
9.231 010	1373	9.231 423	1376	9.236 719	394	9.250 130	112	9.251 189	98	9.253 131	628	9.270 166	1021	9.272 269	927
9.231 012	1373	9.231 424	1376	9.236 720	385	9.250 135	112	9.251 190	98	9.253 135	628	9.270 167	1021	9.272 270	927
9.231 015	1373	9.231 425	1376	9.236 721	385	9.250 140	112	9.251 191	99	9.253 140	628	9.270 168	1021	9.272 350	933
9.231 017	1373	9.231 426	1376	9.236 722	385	9.250 145	112	9.251 192	99	9.253 406	1121	9.270 169	1021	9.272 351	933
9.231 019	1373	9.231 427	1376	9.236 723	385	9.250 150	112	9.251 193	99	9.253 412	1121	9.270 540	1028	9.272 352	933
9.231 022	1373	9.231 428	1376	9.236 724	385	9.250 160	112	9.251 194	99	9.260 020	416	9.270 542	1028	9.272 353	933
9.231 024	1373	9.231 429	1376	9.236 725	385	9.250 170	112	9.251 195	99	9.260 150	414	9.270 764	1027	9.272 354	933
9.231 028	1373	9.231 441	1376	9.236 726	385	9.250 180	112	9.251 196	99	9.262 005	417	9.270 767	1027	9.272 355	933
9.231 032	1373	9.231 442	1376	9.236 727	385	9.250 225	112	9.251 197	99	9.262 010	417	9.270 768	1027	9.272 358	933
9.231 038	1373	9.231 443	1376	9.236 730	385	9.250 230	112	9.251 200	98	9.262 071	416	9.270 780	1026	9.272 359	933
9.231 042	1373	9.231 444	1376	9.236 731	385	9.250 235	112	9.251 201	98	9.262 080	417	9.270 785	1026	9.272 366	935
9.231 052	1373	9.231 445	1376	9.236 783	386	9.250 240	112	9.251 202	98	9.262 411	417	9.270 905	1028	9.272 367	935
9.231 066	1373	9.231 446	1376	9.236 784	386	9.250 245	112	9.251 203	98	9.263 020	103	9.270 921	1022	9.272 368	935
9.231 076	1373	9.231 447	1376	9.236 785	386	9.250 250	112	9.251 204	98	9.263 025	103	9.270 922	1022	9.272 369	935
9.231 100	1374	9.231 448	1376	9.236 786	386	9.250 260	112	9.251 205	98	9.263 030	103	9.270 923	1022	9.272 370	935
9.231 101	1374	9.231 449	1376	9.236 787	386	9.250 306	112	9.251 213	100	9.263 031	103	9.270 924	1022	9.272 371	935
9.231 102	1374	9.231 456	1376	9.236 788	386	9.250 308	112	9.251 237	98	9.263 032	103	9.270 925	1022	9.272 372	935
9.231 103	1374	9.231 457	1376	9.236 790	386	9.250 310	112	9.251 241	98	9.263 033	103	9.270 990	1028	9.272 373	935
9.231 104	1374	9.231 458	1376	9.236 800	386	9.250 313	112	9.251 248	98	9.263 034	103	9.270 995	1028	9.272 374	935
9.231 105	1374	9.231 460	1376	9.236 801	386	9.250 314	112	9.251 323	100	9.263 035	103	9.271 053	1025	9.272 375	935
9.231 106	1374	9.231 461	1376	9.236 810	425	9.250 316	112	9.251 332	100	9.263 036	103	9.271 055	1025	9.272 376	935
9.231 107	1374	9.231 462	1376	9.236 811	425	9.250 319	112	9.251 338	100	9.263 037	103	9.271 056	1025	9.272 377	935
9.231 108	1374	9.231 463	1376	9.236 812	425	9.250 327	112	9.251 340	100	9.263 038	103	9.271 058	1025	9.272 380	931
9.231 109	1374	9.231 464	1376	9.236 813	425	9.250 340	113	9.251 341	100	9.263 039	103	9.271 082	1025	9.272 381	931
9.231 120	1373	9.231 465	1376	9.236 814	425	9.250 350	113	9.251 342	100	9.263 040	103	9.271 084	1025	9.272 382	931
9.231 130	1373	9.231 466	1376	9.236 815	425	9.250 351	113	9.251 343	100	9.263 424	103	9.271 085	1025	9.272 383	931
9.231 140	1373	9.231 510	30	9.236 816	425	9.250 389	112	9.251 550	102	9.263 432	103	9.271 086	1025	9.272 384	931
9.231 150	1373	9.231 512	30	9.236 817	425	9.250 390	112	9.251 551	102	9.263 434	103	9.271 087	1025	9.272 385	931
9.231 160	1373	9.231 514	30	9.236 818	425	9.250 391	112	9.251 552	102	9.263 441	103	9.271 088	1025	9.272 387	931
9.231 178	1373	9.231 516	30	9.236 819	425	9.250 392	112	9.251 553	102	9.263 446	103	9.271 235	1023	9.272 388	931
9.231 185	1373	9.231 518	30	9.236 840	426	9.250 393	112	9.251 554	102	9.263 452	103	9.271 237	1023	9.272 389	931
9.231 190	1373	9.231 520	30	9.236 841	426	9.250 394	112	9.251 555	102	9.263 457	103	9.271 332	1030	9.272 390	931
9.231 205	1372	9.231 522	30	9.236 842	426	9.250 399	113	9.251 556	102	9.263 461	103	9.271 333	1030	9.272 391	931
9.231 207	1372	9.231 530	30	9.236 843	426	9.250 400	113	9.251 557	102	9.263 466	103	9.271 334	1030	9.272 392	931
9.231 209	1372	9.231 532	30	9.236 844	426	9.250 401	113	9.251 558	101	9.263 526	104	9.271 335	1030	9.272 507	935
9.231 210	1372	9.231 536	30	9.236 845	426	9.250 402	113	9.251 560	102	9.263 528	104	9.271 338	1030	9.272 510	935
9.231 211	1372	9.231 541	30	9.236 846	426	9.250 403	113	9.251 561	102	9.263 530	104	9.271 980	936	9.272 512	935
9.231 212	1372	9.231 641	29	9.236 847	426	9.250 404	113	9.251 602	99	9.263 532	104	9.271 985	936	9.272 513	935
9.231 213	1372	9.231 642	29	9.236 848	426	9.250 405	113	9.251 605	99	9.264 101	263	9.271 986	936	9.273 001	930
9.231 214	1372	9.231 643	29	9.236 849	426	9.250 406	113	9.251 610	99	9.264 102	263	9.272 016	933	9.273 002	930
9.231 215	1372	9.231 644	29	9.236 850	387	9.250 407	113	9.251 615	99	9.264 103	263	9.272 017	933	9.273 003	930
9.231 216	1372	9.231 645	29	9.236 852	387	9.250 408	113	9.251 620	99	9.264 104	263	9.272 018	933	9.273 007	930
9.231 218	1372	9.231 646	29	9.236 854	387	9.250 409	113	9.251 625	99	9.264 146	257	9.272 019	933	9.273 012	930
9.231 220	1372	9.231 647	29	9.236 856	387	9.250 410	113	9.251 630	99	9.264 147	257	9.272 020	933	9.273 014	930
9.231 224	1372	9.231 648	29	9.236 858	387	9.250 630	115	9.251 635	99	9.264 163	258	9.272 021	933	9.273 015	930
9.231 225	1372	9.231 649	29	9.236 860	387	9.250 635	115	9.251 640	99	9.264 190	262	9.272 022	933	9.273 018	930
9.231 226	1372	9.231 650	29	9.236 862	387	9.250 640	115	9.251 645	99	9.264 191	262	9.272 023	933	9.273 019	930
9.231 229	1372	9.232 994	472	9.236 864	387	9.250 650	115	9.251 650	99	9.264 210	261	9.272 024	933	9.273 101	928
9.231 231	1372	9.232 994	610	9.236 866	387	9.250 660	115	9.251 655	99	9.264 211	261	9.272 025	933	9.273 102	928
9.231 232	1372	9.232 996	472	9.236 868	387	9.250 665	115	9.251 660	99	9.264 212	261	9.272 026	933	9.273 103	928
9.231 233	1372	9.232 998	47												

Bestellnummernindex - Numerical index - Index numérique - Índice Numérico - Índice numerico - Indeks numerów katalogowych - Указатель по номерам

9.273 232	930	9.274 187	910	9.275 748	18	9.276 608	918	9.276 919	1229	9.280 173	954	9.282 466	967	9.283 139	1007
9.273 233	930	9.274 188	910	9.275 769	16	9.276 609	918	9.276 920	1229	9.280 174	954	9.282 467	967	9.283 140	1007
9.273 235	930	9.274 190	912	9.275 770	16	9.276 610	918	9.276 921	1229	9.280 175	954	9.282 470	970	9.283 141	1007
9.273 236	930	9.274 191	912	9.275 771	16	9.276 611	918	9.276 922	1229	9.280 176	954	9.282 471	970	9.283 142	1007
9.273 238	930	9.274 192	912	9.275 772	18	9.276 612	918	9.276 923	1229	9.280 177	954	9.282 472	970	9.283 143	1007
9.273 239	930	9.274 193	912	9.275 773	18	9.276 613	918	9.276 924	1229	9.280 178	954	9.282 473	970	9.283 144	1007
9.273 257	930	9.274 194	912	9.275 775	18	9.276 614	918	9.276 949	925	9.280 179	954	9.282 474	970	9.283 145	1007
9.273 258	930	9.274 195	912	9.275 776	18	9.276 620	923	9.276 950	925	9.280 581	980	9.282 475	970	9.283 146	1007
9.273 259	930	9.274 196	912	9.275 777	18	9.276 621	923	9.276 951	925	9.280 602	979	9.282 476	970	9.283 147	1007
9.273 260	930	9.274 197	912	9.275 778	18	9.276 622	923	9.276 952	925	9.280 605	979	9.282 477	970	9.283 148	1007
9.273 261	930	9.274 198	911	9.275 779	18	9.276 623	923	9.276 953	925	9.280 610	979	9.282 478	970	9.283 149	1007
9.273 262	930	9.274 199	911	9.275 850	18	9.276 624	923	9.276 954	925	9.280 620	979	9.282 479	970	9.283 150	1007
9.273 263	930	9.274 200	911	9.275 852	18	9.276 625	923	9.276 955	925	9.280 696	979	9.282 480	969	9.283 151	1007
9.273 264	930	9.274 201	911	9.275 860	18	9.276 626	923	9.276 970	926	9.280 705	979	9.282 481	971	9.283 152	1007
9.273 265	930	9.274 202	911	9.275 861	18	9.276 627	923	9.276 971	926	9.280 710	979	9.282 482	971	9.283 153	1007
9.273 266	930	9.274 203	911	9.275 862	18	9.276 628	923	9.276 972	926	9.280 720	979	9.282 483	971	9.283 154	1007
9.273 268	930	9.274 204	911	9.275 863	18	9.276 629	923	9.276 973	926	9.280 724	979	9.282 484	971	9.283 155	1007
9.273 269	930	9.274 206	911	9.276 001	917	9.276 630	923	9.276 974	926	9.280 726	979	9.282 501	991	9.283 156	1007
9.273 270	927	9.274 207	911	9.276 002	917	9.276 631	923	9.276 975	926	9.280 730	979	9.282 510	992	9.283 157	1007
9.273 271	927	9.274 408	914	9.276 003	917	9.276 645	917	9.276 976	926	9.280 732	979	9.282 511	992	9.283 158	1007
9.273 272	927	9.274 409	914	9.276 004	917	9.276 646	917	9.277 105	79	9.280 741	979	9.282 512	992	9.283 159	1007
9.273 273	927	9.274 410	914	9.276 006	917	9.276 647	917	9.277 110	79	9.280 742	979	9.282 513	992	9.283 160	1007
9.273 276	927	9.274 411	914	9.276 007	917	9.276 648	917	9.277 120	79	9.280 743	979	9.282 514	992	9.283 161	1007
9.273 280	927	9.274 412	914	9.276 008	917	9.276 649	917	9.277 125	79	9.280 745	979	9.282 515	992	9.283 162	1007
9.273 281	927	9.274 413	914	9.276 260	922	9.276 650	917	9.277 150	79	9.280 751	979	9.282 516	992	9.283 163	1007
9.273 282	927	9.274 414	914	9.276 261	922	9.276 651	917	9.277 305	427	9.280 752	979	9.282 517	992	9.283 164	1007
9.273 284	927	9.274 415	914	9.276 262	922	9.276 652	917	9.277 310	427	9.280 753	979	9.282 518	992	9.283 165	1007
9.273 286	927	9.274 420	914	9.276 263	922	9.276 653	917	9.277 325	427	9.280 755	979	9.282 519	992	9.283 166	1007
9.273 288	927	9.274 428	914	9.276 264	922	9.276 679	919	9.277 350	427	9.280 800	979	9.282 520	993	9.283 167	1007
9.273 301	935	9.274 438	914	9.276 265	922	9.276 680	919	9.277 400	427	9.280 801	979	9.282 521	993	9.283 171	968
9.273 302	935	9.274 448	914	9.276 270	922	9.276 681	919	9.277 515	949	9.280 802	979	9.282 522	993	9.283 181	975
9.273 305	935	9.274 454	914	9.276 271	922	9.276 682	919	9.277 516	949	9.280 803	979	9.282 523	993	9.283 182	975
9.273 310	935	9.274 462	914	9.276 272	922	9.276 683	919	9.277 517	949	9.280 805	979	9.282 524	993	9.283 183	975
9.273 320	935	9.274 464	914	9.276 273	922	9.276 684	919	9.277 518	949	9.280 810	979	9.282 526	993	9.283 184	975
9.273 325	935	9.274 608	912	9.276 274	922	9.276 685	919	9.277 519	949	9.280 850	980	9.282 527	993	9.283 185	975
9.273 826	943	9.274 620	912	9.276 275	922	9.276 686	919	9.277 522	949	9.280 901	979	9.282 528	993	9.283 186	975
9.273 827	943	9.274 628	912	9.276 436	919	9.276 687	919	9.277 526	949	9.280 903	979	9.282 529	993	9.283 187	978
9.273 850	942	9.274 638	912	9.276 438	919	9.276 688	919	9.280 000	949	9.280 905	979	9.282 530	993	9.283 188	978
9.273 851	942	9.274 648	912	9.276 443	919	9.276 689	919	9.280 001	949	9.280 944	1004	9.282 531	993	9.283 189	978
9.273 852	942	9.274 654	912	9.276 446	919	9.276 690	919	9.280 002	949	9.280 945	1004	9.282 532	993	9.283 190	978
9.273 853	942	9.274 662	912	9.276 447	919	9.276 691	919	9.280 003	949	9.280 949	1005	9.282 533	993	9.283 191	978
9.273 860	942	9.274 664	912	9.276 448	919	9.276 692	919	9.280 004	949	9.280 950	1005	9.282 544	994	9.283 192	978
9.273 861	942	9.274 760	913	9.276 449	919	9.276 693	919	9.280 005	949	9.280 951	1005	9.282 552	994	9.283 193	978
9.273 868	941	9.274 761	913	9.276 450	919	9.276 694	919	9.280 006	949	9.280 952	1005	9.282 554	994	9.283 194	978
9.273 868	942	9.274 762	913	9.276 451	919	9.276 695	919	9.280 007	949	9.280 953	1005	9.282 555	994	9.283 240	974
9.273 872	941	9.274 763	913	9.276 452	919	9.276 696	919	9.280 008	950	9.280 954	1005	9.282 556	994	9.283 241	974
9.273 873	941	9.274 764	913	9.276 453	919	9.276 697	919	9.280 009	950	9.280 955	1005	9.282 661	964	9.283 242	974
9.273 874	941	9.274 765	913	9.276 454	919	9.276 698	919	9.280 011	950	9.280 956	1005	9.282 662	964	9.283 243	974
9.273 875	941	9.274 766	913	9.276 455	919	9.276 699	924	9.280 014	950	9.280 957	1005	9.282 663	964	9.283 244	974
9.273 895	943	9.274 767	913	9.276 456	919	9.276 700	924	9.280 100	953	9.280 958	1005	9.282 664	964	9.283 245	974
9.273 896	943	9.274 790	915	9.276 457	919	9.276 701	924	9.280 101	953	9.280 959	1005	9.282 665	964	9.283 246	977
9.273 900	944	9.274 791	915	9.276 470	920	9.276 702	924	9.280 102	953	9.280 960	1005	9.282 666	964	9.283 247	977
9.273 920	944	9.274 792	915	9.276 471	920	9.276 703	924	9.280 103	953	9.280 961	1005	9.282 673	964	9.283 248	977
9.273 925	944	9.274 793	915	9.276 472	920	9.276 704	924	9.280 104	953	9.280 962	1005	9.282 674	964	9.283 249	977
9.273 928	944	9.274 794	915	9.276 473	920	9.276 705	924	9.280 105	953	9.280 963	1005	9.282 675	964	9.283 250	977
9.273 930	944	9.274 795	915	9.276 474	920	9.276 706	924	9.280 107	954	9.280 964	1005	9.282 676	964	9.283 251	977
9.273 980	944	9.274 796	915	9.276 475	920	9.276 707	924	9.280 108	954	9.280 965	1005	9.282 677	964	9.283 252	977
9.273 985	944	9.274 797	915	9.276 476	920	9.276 708	924	9.280 109	954	9.280 966	1005	9.282 678	964	9.283 257	977
9.273 990	944	9.274 870	914	9.276 477	920	9.276 709	924	9.280 110	954	9.280 967	1005	9.282 679	965	9.283 516	1410
9.274 005	912	9.275 006	911	9.276 478	920	9.276 710	924	9.280 111	954	9.280 968	1005	9.282 680	965	9.283 517	1410
9.274 008	912	9.275 007	911	9.276 479	920	9.276 711	924	9.280 112	954	9.280 969	1005	9.282 681	965	9.283 518	1410
9.274 020	912	9.275 008	916	9.276 480	920	9.276 712	924	9.280 113	953	9.281 005	939	9.282 682	965	9.283 576	1299
9.274 028	912	9.275 020	916	9.276 481	920	9.276 713	924	9.280 114	953	9.281 005	1346	9.282 683	965	9.283 577	1299
9.274 038	912	9.275 028	916	9.276 482	920	9.276 714	924	9.280 115	953	9.281 041	939	9.282 684	965	9.283 578	1299
9.274 048	912	9.275 038	916	9.276 483	920	9.276 715	921	9.280 116	953	9.281 041	1346	9.282 685	965	9.283 579	1294
9.274 054	912	9.275 048	916	9.276 484	920	9.276 716	921	9.280 117	954	9.281 080	948	9.282 686	965	9.283 579	1299
9.274 062	912	9.275 054	916	9.276 485	920	9.276 717	921	9.280 118	954	9.281 085	948	9.282 687	965	9.283 595	1296
9.274 064	912	9.275 062	916	9.276 486	920	9.276 718	921	9							

Bestellnummernindex - Numerical index - Index numérique - Índice Numérico - Índice numerico - Indeks numerów katalogowych - Указатель по номерам

9.283 810	1011	9.284 453	1234	9.287 966	1012	9.303 039	161	9.303 961	1234	9.315 017	688	9.318 077	103	9.400 220	28
9.283 958	940	9.284 456	1017	9.287 967	1012	9.303 125	1060	9.303 965	558	9.315 024	688	9.318 080	103	9.400 225	28
9.283 961	940	9.284 457	1019	9.287 968	1012	9.303 401	1257	9.303 966	558	9.315 026	688	9.318 107	103	9.400 230	28
9.283 962	940	9.284 457	1234	9.287 969	1012	9.303 403	1257	9.303 970	556	9.315 036	688	9.318 134	103	9.400 235	28
9.283 965	940	9.284 458	1019	9.287 970	1012	9.303 405	1257	9.303 980	548	9.315 201	688	9.318 136	103	9.400 240	28
9.283 966	940	9.284 458	1234	9.287 995	1012	9.303 431	1257	9.303 981	548	9.315 203	688	9.318 146	103	9.400 250	28
9.283 967	940	9.284 459	1016	9.287 996	1012	9.303 433	1258	9.303 982	548	9.315 207	688	9.318 168	103	9.400 260	28
9.283 968	940	9.284 462	1016	9.287 997	1012	9.303 720	557	9.303 983	548	9.315 210	688	9.318 201	103	9.400 270	28
9.283 969	940	9.284 510	70	9.287 998	1012	9.303 721	557	9.303 984	548	9.315 217	688	9.318 203	103	9.400 280	28
9.283 970	940	9.284 511	70	9.288 200	948	9.303 722	557	9.303 985	548	9.315 220	688	9.318 205	103	9.400 290	28
9.284 015	1004	9.284 512	70	9.288 201	948	9.303 723	557	9.303 986	548	9.315 225	688	9.318 210	103	9.400 310	1452
9.284 016	1004	9.284 513	70	9.300 021	383	9.303 728	546	9.303 989	548	9.315 237	688	9.318 221	103	9.400 311	1452
9.284 020	1029	9.284 514	70	9.300 022	383	9.303 729	546	9.303 990	548	9.315 240	688	9.318 232	103	9.400 312	1453
9.284 021	1029	9.284 515	70	9.300 023	383	9.303 730	546	9.303 991	548	9.315 245	688	9.380 421	693	9.400 313	1453
9.284 065	1004	9.284 516	70	9.300 032	383	9.303 731	546	9.303 992	548	9.315 329	696	9.380 422	693	9.400 314	1453
9.284 066	1004	9.284 517	70	9.300 037	383	9.303 732	557	9.303 993	548	9.315 339	696	9.380 423	693	9.400 315	1453
9.284 067	1004	9.284 518	70	9.300 041	383	9.303 733	557	9.303 994	548	9.315 340	696	9.380 440	938	9.400 316	1453
9.284 068	1004	9.284 519	70	9.300 113	383	9.303 734	557	9.303 995	548	9.315 343	1221	9.380 440	1345	9.400 615	695
9.284 069	1004	9.284 520	70	9.300 118	383	9.303 735	557	9.303 996	548	9.315 344	1221	9.380 441	938	9.400 632	695
9.284 164	1408	9.284 521	70	9.300 123	383	9.303 736	546	9.303 997	548	9.315 345	1221	9.380 441	1345	9.400 664	695
9.284 165	1408	9.284 522	71	9.300 124	383	9.303 775	163	9.303 998	548	9.315 346	1221	9.380 442	938	9.400 665	695
9.284 166	1408	9.284 523	71	9.300 127	383	9.303 776	163	9.303 999	548	9.315 412	689	9.380 442	1345	9.400 780	696
9.284 167	1408	9.284 524	71	9.300 150	383	9.303 777	163	9.304 000	548	9.315 413	689	9.380 443	938	9.400 782	696
9.284 168	1408	9.284 525	71	9.300 151	383	9.303 778	163	9.304 001	548	9.315 415	689	9.380 443	1345	9.400 787	696
9.284 169	1408	9.284 530	72	9.300 152	383	9.303 779	163	9.304 002	548	9.315 416	689	9.380 464	938	9.400 788	696
9.284 170	1408	9.284 533	73	9.300 153	383	9.303 780	163	9.304 003	548	9.315 417	689	9.380 464	1345	9.400 792	696
9.284 190	1002	9.284 534	73	9.300 154	383	9.303 781	163	9.304 038	1258	9.315 418	689	9.380 465	938	9.400 927	761
9.284 209	1416	9.284 535	73	9.300 155	383	9.303 782	163	9.304 048	1258	9.315 421	689	9.380 465	1345	9.400 929	794
9.284 225	1003	9.284 536	73	9.300 160	383	9.303 783	163	9.304 050	1258	9.315 423	689	9.380 466	938	9.400 930	794
9.284 228	1416	9.284 537	73	9.300 161	383	9.303 784	163	9.304 051	1258	9.315 509	688	9.380 466	1345	9.400 932	794
9.284 239	1002	9.284 538	73	9.300 162	383	9.303 785	163	9.304 170	1259	9.315 514	688	9.380 467	938	9.400 933	794
9.284 250	1416	9.284 539	73	9.300 163	383	9.303 786	163	9.304 262	1261	9.315 517	688	9.380 467	1345	9.400 935	768
9.284 251	1416	9.284 540	73	9.300 164	383	9.303 787	163	9.304 272	1261	9.315 654	697	9.380 468	938	9.400 944	765
9.284 252	1416	9.284 541	78	9.300 345	383	9.303 788	163	9.304 273	1261	9.315 655	697	9.380 468	1345	9.400 945	795
9.284 256	1416	9.284 541	1020	9.300 356	383	9.303 789	163	9.304 280	1261	9.315 656	697	9.380 469	938	9.400 945	1343
9.284 257	1416	9.284 542	78	9.300 357	383	9.303 790	163	9.304 281	1262	9.315 658	697	9.380 469	1345	9.400 946	761
9.284 258	1416	9.284 542	1020	9.300 360	383	9.303 800	555	9.305 319	1077	9.315 659	697	9.390 013	251	9.400 947	761
9.284 259	1416	9.284 543	78	9.301 006	381	9.303 801	555	9.305 324	1077	9.315 660	697	9.390 049	247	9.400 948	761
9.284 260	1416	9.284 543	1020	9.301 008	381	9.303 802	555	9.305 329	1077	9.315 661	697	9.390 050	247	9.400 949	761
9.284 283	1208	9.284 544	78	9.301 010	381	9.303 804	555	9.305 336	1077	9.315 691	697	9.390 051	247	9.400 950	755
9.284 285	1208	9.284 544	1020	9.301 026	381	9.303 806	555	9.305 340	1077	9.315 692	697	9.390 052	247	9.400 956	768
9.284 287	1208	9.284 545	78	9.301 028	381	9.303 807	555	9.305 341	1077	9.315 693	697	9.390 053	247	9.400 957	769
9.284 288	1208	9.284 545	1020	9.301 030	381	9.303 810	555	9.305 342	1077	9.315 694	697	9.390 054	250	9.400 958	765
9.284 292	1208	9.284 849	1019	9.301 065	1454	9.303 812	555	9.305 343	1077	9.315 695	697	9.390 055	250	9.400 967	755
9.284 293	1208	9.284 850	1019	9.301 066	381	9.303 814	555	9.305 344	1077	9.315 701	696	9.390 056	250	9.400 968	755
9.284 294	1208	9.284 851	1019	9.301 067	381	9.303 820	555	9.305 345	1077	9.315 701	1222	9.390 057	250	9.400 969	755
9.284 295	1416	9.284 852	1019	9.301 068	381	9.303 822	555	9.305 346	1077	9.315 702	696	9.390 058	250	9.400 970	755
9.284 296	1416	9.284 853	1019	9.301 069	382	9.303 824	555	9.305 349	1076	9.315 702	1222	9.390 059	250	9.400 971	755
9.284 297	1416	9.284 854	1019	9.301 216	107	9.303 828	556	9.305 350	1076	9.315 703	696	9.390 071	1508	9.400 978	762
9.284 298	1416	9.287 756	1029	9.301 220	107	9.303 829	556	9.305 351	1076	9.315 703	1222	9.390 076	1509	9.400 979	762
9.284 299	1416	9.287 779	1029	9.301 224	107	9.303 830	556	9.305 352	1076	9.315 708	696	9.390 077	1509	9.400 982	765
9.284 300	1416	9.287 780	1029	9.301 228	107	9.303 840	553	9.305 353	1076	9.315 709	696	9.390 090	191	9.400 983	765
9.284 380	1016	9.287 781	1029	9.301 232	107	9.303 842	553	9.306 107	131	9.315 711	697	9.390 091	191	9.400 984	765
9.284 381	1016	9.287 800	1014	9.301 236	107	9.303 844	553	9.306 111	131	9.315 712	697	9.390 092	191	9.400 990	795
9.284 382	1017	9.287 801	1014	9.301 240	107	9.303 846	556	9.306 115	131	9.315 713	697	9.390 093	191	9.400 990	1343
9.284 383	1017	9.287 802	1014	9.301 356	53	9.303 850	543	9.306 117	131	9.315 714	697	9.390 185	1528	9.400 991	795
9.284 384	1016	9.287 803	1014	9.301 357	53	9.303 851	557	9.306 125	131	9.315 716	698	9.390 186	1528	9.400 991	1343
9.284 385	1016	9.287 804	1014	9.301 358	53	9.303 854	543	9.306 127	130	9.315 717	698	9.390 187	1528	9.401 050	757
9.284 386	1016	9.287 805	1014	9.301 359	53	9.303 858	543	9.309 409	1148	9.315 718	698	9.390 188	1528	9.401 055	757
9.284 387	1016	9.287 806	1014	9.301 360	53	9.303 859	543	9.309 410	1148	9.315 719	698	9.390 189	1528	9.401 084	936
9.284 388	1016	9.287 807	1014	9.301 361	53	9.303 860	544	9.309 410	1148	9.315 720	698	9.390 190	1528	9.401 085	936
9.284 389	1016	9.287 808	1014	9.301 362	53	9.303 862	544	9.309 411	1148	9.315 721	698	9.390 330	1333	9.401 090	794
9.284 390	1016	9.287 809	1014	9.301 481	52	9.303 864	544	9.309 412	1148	9.315 723	698	9.390 331	1333	9.401 091	794
9.284 391	1016	9.287 815	1014	9.301 485	52	9.303 865	544	9.309 419	1148	9.315 724	698	9.390 332	1333	9.401 092	794
9.284 392	1016	9.287 816	1014	9.301 486	52	9.303 866	544	9.309 420	1148	9.315 725	698	9.390 333	1333	9.401 093	794
9.284 393	1016	9.287 831	1014	9.301 502	271	9.303 868	543	9.309 421	1148	9.315 732	698	9.390 345	1333	9.401 094	794
9.284 394	1017	9.287 832	1014	9.301 503	53	9.303 870	544	9.309 425	1148	9.315 733	698	9.390 346	1333	9.401 160	754

Bestellnummernindex - Numerical index - Index numérique - Índice Numérico - Indice numerico - Indeks numerów katalogowych - Указатель по номерам

9.401 835	45	9.404 223	258	9.405 850	760	9.408 983	1317	9.409 344	1410	9.409 707	986	9.409 926	1401	9.411 626	955
9.401 838	45	9.404 224	258	9.405 851	760	9.409 006	764	9.409 345	1410	9.409 708	986	9.409 927	1401	9.411 627	955
9.401 840	45	9.404 231	560	9.405 852	760	9.409 006	1298	9.409 346	1410	9.409 709	986	9.409 928	1401	9.411 628	955
9.401 850	45	9.404 232	560	9.405 855	760	9.409 008	764	9.409 347	1409	9.409 712	986	9.409 929	1401	9.411 630	958
9.401 851	45	9.404 233	560	9.405 870	757	9.409 008	1298	9.409 351	1295	9.409 713	986	9.409 930	1401	9.411 631	958
9.401 852	45	9.404 234	560	9.405 871	757	9.409 014	41	9.409 352	1410	9.409 714	986	9.410 025	1356	9.411 632	958
9.401 853	45	9.404 235	560	9.405 872	757	9.409 015	764	9.409 353	1410	9.409 715	986	9.410 025	1461	9.411 633	958
9.401 854	45	9.404 236	560	9.405 873	757	9.409 015	1298	9.409 354	1410	9.409 716	986	9.410 050	1356	9.411 634	958
9.401 855	45	9.404 301	260	9.405 875	757	9.409 016	764	9.409 355	1410	9.409 717	986	9.410 050	1461	9.411 635	958
9.401 860	47	9.404 303	260	9.405 876	757	9.409 016	1298	9.409 356	1410	9.409 718	986	9.410 403	1461	9.411 636	958
9.401 861	47	9.404 305	260	9.405 877	757	9.409 017	764	9.409 357	1410	9.409 719	986	9.410 431	1461	9.411 637	958
9.402 310	44	9.404 307	260	9.405 880	757	9.409 017	1298	9.409 358	1410	9.409 721	986	9.411 015	936	9.411 650	956
9.402 310	563	9.404 309	260	9.405 883	757	9.409 018	764	9.409 359	1410	9.409 722	986	9.411 020	936	9.411 651	956
9.402 313	44	9.404 310	260	9.405 890	760	9.409 018	1298	9.409 368	1295	9.409 723	987	9.411 030	936	9.411 652	956
9.402 313	563	9.404 311	260	9.405 891	760	9.409 023	690	9.409 370	1293	9.409 724	987	9.411 031	936	9.411 653	956
9.402 318	44	9.404 314	260	9.405 892	760	9.409 023	1406	9.409 371	1293	9.409 725	987	9.411 032	936	9.411 654	956
9.402 318	563	9.404 316	260	9.405 893	760	9.409 024	690	9.409 372	1293	9.409 726	987	9.411 033	936	9.411 655	956
9.402 321	44	9.404 326	260	9.405 894	760	9.409 024	1406	9.409 373	1294	9.409 727	987	9.411 035	936	9.411 660	957
9.402 321	563	9.404 952	653	9.405 895	760	9.409 025	690	9.409 374	1293	9.409 728	987	9.411 038	936	9.411 661	957
9.402 324	44	9.404 952	1231	9.405 896	760	9.409 025	1406	9.409 375	1293	9.409 729	987	9.411 039	936	9.411 662	957
9.402 324	563	9.404 955	653	9.405 897	760	9.409 088	35	9.409 377	1294	9.409 730	986	9.411 215	947	9.411 663	957
9.402 350	44	9.404 955	1231	9.405 898	760	9.409 097	981	9.409 379	1299	9.409 733	986	9.411 220	947	9.411 664	957
9.402 350	563	9.405 106	206	9.405 899	760	9.409 098	981	9.409 380	33	9.409 734	986	9.411 240	948	9.411 665	957
9.402 353	44	9.405 116	242	9.405 900	760	9.409 128	983	9.409 381	1295	9.409 735	986	9.411 265	947	9.411 666	957
9.402 353	563	9.405 117	242	9.405 901	760	9.409 129	983	9.409 383	1295	9.409 736	986	9.411 266	947	9.411 667	957
9.402 356	44	9.405 118	242	9.405 910	759	9.409 130	983	9.409 386	1297	9.409 737	986	9.411 267	947	9.411 668	958
9.402 356	563	9.405 119	242	9.405 911	759	9.409 131	34	9.409 386	1317	9.409 738	987	9.411 268	947	9.411 669	958
9.402 359	44	9.405 120	242	9.405 913	759	9.409 132	34	9.409 392	1159	9.409 739	987	9.411 270	947	9.411 670	958
9.402 359	563	9.405 121	242	9.406 011	1157	9.409 133	34	9.409 397	1159	9.409 740	987	9.411 271	947	9.411 671	958
9.402 416	45	9.405 122	242	9.406 012	1157	9.409 134	34	9.409 398	1159	9.409 741	987	9.411 273	947	9.411 672	958
9.402 421	45	9.405 123	242	9.406 110	1158	9.409 135	34	9.409 403	996	9.409 742	987	9.411 274	947	9.411 673	958
9.402 771	47	9.405 124	242	9.406 111	1158	9.409 136	34	9.409 404	996	9.409 743	987	9.411 275	947	9.411 674	958
9.402 777	47	9.405 125	242	9.406 114	1158	9.409 137	34	9.409 406	997	9.409 744	987	9.411 276	947	9.411 675	958
9.402 781	47	9.405 126	242	9.406 115	1158	9.409 138	983	9.409 407	996	9.409 745	987	9.411 277	947	9.411 680	957
9.402 783	47	9.405 127	242	9.406 118	1159	9.409 139	983	9.409 408	996	9.409 746	987	9.411 279	947	9.411 681	957
9.404 004	1397	9.405 128	242	9.406 119	1159	9.409 140	983	9.409 409	996	9.409 747	987	9.411 280	947	9.411 682	957
9.404 005	1397	9.405 129	242	9.406 120	1159	9.409 191	984	9.409 410	996	9.409 748	987	9.411 307	946	9.411 683	958
9.404 006	1397	9.405 130	242	9.406 121	1159	9.409 192	984	9.409 411	996	9.409 749	987	9.411 309	946	9.411 684	958
9.404 007	1397	9.405 131	242	9.406 122	1159	9.409 199	984	9.409 412	996	9.409 750	987	9.411 318	946	9.411 685	958
9.404 010	259	9.405 132	242	9.406 123	1159	9.409 223	984	9.409 413	996	9.409 751	987	9.411 322	946	9.411 690	959
9.404 011	259	9.405 133	242	9.406 124	1159	9.409 238	944	9.409 414	996	9.409 752	987	9.411 327	946	9.411 691	959
9.404 012	259	9.405 134	242	9.406 125	1159	9.409 239	944	9.409 415	996	9.409 753	987	9.411 328	946	9.411 692	959
9.404 013	259	9.405 135	242	9.406 126	1159	9.409 245	1294	9.409 416	996	9.409 754	987	9.411 333	946	9.411 693	959
9.404 014	259	9.405 136	242	9.406 127	1159	9.409 246	1294	9.409 417	996	9.409 755	987	9.411 344	946	9.411 694	959
9.404 020	258	9.405 137	242	9.406 431	1157	9.409 247	1295	9.409 418	996	9.409 756	987	9.411 345	946	9.411 695	959
9.404 030	258	9.405 138	242	9.406 432	1157	9.409 248	1295	9.409 429	998	9.409 757	985	9.411 357	946	9.411 696	959
9.404 050	258	9.405 139	242	9.406 433	1157	9.409 254	1295	9.409 490	998	9.409 758	985	9.411 440	946	9.411 697	959
9.404 051	258	9.405 140	244	9.406 434	1157	9.409 255	1295	9.409 491	998	9.409 759	985	9.411 449	989	9.411 731	956
9.404 052	258	9.405 141	244	9.406 435	1157	9.409 256	1295	9.409 492	998	9.409 760	985	9.411 478	956	9.412 800	1173
9.404 065	260	9.405 142	244	9.406 436	1157	9.409 257	1295	9.409 493	998	9.409 761	985	9.411 479	956	9.412 801	1173
9.404 066	260	9.405 143	244	9.406 437	1157	9.409 258	1295	9.409 495	998	9.409 762	985	9.411 480	956	9.412 805	1173
9.404 070	259	9.405 144	244	9.406 438	1157	9.409 259	1295	9.409 496	998	9.409 763	985	9.411 481	956	9.412 810	1170
9.404 099	258	9.405 145	244	9.406 439	1157	9.409 264	1295	9.409 497	998	9.409 764	985	9.411 482	956	9.413 015	1174
9.404 100	258	9.405 146	244	9.406 440	1157	9.409 265	1295	9.409 498	998	9.409 765	985	9.411 484	956	9.413 017	1174
9.404 101	258	9.405 147	244	9.406 441	1157	9.409 266	1295	9.409 520	998	9.409 766	985	9.411 491	960	9.413 018	1177
9.404 102	258	9.405 148	244	9.407 027	1333	9.409 277	692	9.409 521	998	9.409 767	985	9.411 492	960	9.413 019	1177
9.404 103	258	9.405 149	244	9.407 077	1333	9.409 277	1411	9.409 522	998	9.409 768	985	9.411 493	960	9.413 020	1174
9.404 104	258	9.405 162	206	9.407 152	1333	9.409 278	692	9.409 523	998	9.409 769	985	9.411 494	960	9.413 021	1174
9.404 105	258	9.405 165	206	9.407 230	1332	9.409 278	1411	9.409 558	999	9.409 770	985	9.411 501	989	9.413 033	1175
9.404 114	559	9.405 205	219	9.407 393	1332	9.409 279	692	9.409 628	1293	9.409 771	985	9.411 502	989	9.413 034	1177
9.404 115	559	9.405 206	219	9.407 395	1332	9.409 279	1411	9.409 633	1293	9.409 772	985	9.411 504	960	9.413 035	1177
9.404 116	559	9.405 207	219	9.407 398	1332	9.409 288	692	9.409 662	1119	9.409 773	985	9.411 505	960	9.413 036	1177
9.404 117	559	9.405 235	219	9.407 399	1332	9.409 288	1411	9.409 669	984	9.409 774	985	9.411 509	1005	9.413 043	1178
9.404 118	559	9.405 236	219	9.407 401	1332	9.409 289	692	9.409 670	984	9.409 775	985	9.411 511	1005	9.413 044	1177
9.404 119	559	9.405 237	219	9.407 471	1318	9.409 289	1411	9.409 671	984	9.409 776	985	9.411 513	1005	9.413 046	1177
9.404 120	559	9.405 238	219	9.407 473	1339	9.409 290	692	9.409 672	984	9.409 777	985	9.411 520	1008	9.413 047	1178
9.404 121	559	9.405 239	219	9.407 475	1339	9.409 290	1411	9.409 673	984	9.409 778	985	9.411 521	1008	9.413 050	1179
9.404 122	559	9.405 286													

Bestellnummernindex - Numerical index - Index numérique - Índice Numérico - Índice numerico - Indeks numerów katalogowych - Указатель по номерам

9.414 323	246	9.521 943	1394	9.537 976	867	9.571 117	607	9.604 619	742	9.642 621	846	9.645 815	839	9.651 692	1389
9.414 324	246	9.521 944	1394	9.537 977	866	9.571 119	607	9.620 404	1214	9.642 622	846	9.645 816	839	9.651 693	1389
9.414 325	246	9.521 945	1394	9.537 978	866	9.571 199	607	9.620 405	1214	9.642 623	846	9.645 819	839	9.651 694	1389
9.414 326	246	9.521 946	1394	9.537 979	866	9.571 200	607	9.620 407	1214	9.642 624	846	9.645 820	839	9.651 695	1389
9.414 327	246	9.521 947	1394	9.537 980	866	9.571 201	607	9.620 408	1214	9.642 625	846	9.645 824	845	9.695 000	791
9.414 328	246	9.521 948	1394	9.537 981	866	9.571 207	607	9.620 409	1214	9.642 626	846	9.645 827	845	9.695 001	791
9.414 329	246	9.521 960	1395	9.537 982	866	9.571 436	566	9.620 410	1213	9.642 627	846	9.645 828	845	9.695 002	791
9.414 330	246	9.524 383	768	9.537 983	866	9.571 437	566	9.620 411	1213	9.642 628	846	9.645 829	845	9.695 003	791
9.414 331	246	9.524 386	768	9.537 984	866	9.571 450	566	9.620 413	1215	9.642 630	849	9.645 950	451	9.695 004	791
9.414 342	245	9.524 392	768	9.537 985	867	9.571 453	566	9.620 414	1213	9.642 654	850	9.645 951	451	9.695 006	791
9.414 343	245	9.524 393	768	9.537 986	867	9.571 461	566	9.620 415	1213	9.642 660	850	9.645 954	455	9.695 007	791
9.414 344	245	9.524 394	768	9.537 987	867	9.571 492	600	9.620 416	1213	9.642 670	851	9.645 955	455	9.695 008	791
9.414 345	245	9.534 150	869	9.537 988	867	9.580 006	789	9.620 417	1213	9.642 671	851	9.645 956	457	9.695 009	791
9.414 346	245	9.534 153	869	9.537 989	867	9.580 009	789	9.620 418	1213	9.642 672	851	9.645 957	457	9.695 030	792
9.414 347	245	9.534 156	859	9.537 990	867	9.580 010	789	9.620 419	1213	9.642 673	851	9.645 958	457	9.695 031	792
9.414 348	245	9.534 157	860	9.537 991	867	9.580 016	789	9.620 420	1215	9.642 674	851	9.645 959	459	9.695 032	792
9.414 349	245	9.534 158	860	9.537 992	867	9.580 040	789	9.620 421	1214	9.642 720	850	9.645 960	459	9.695 033	792
9.414 350	245	9.534 159	859	9.538 001	873	9.580 041	789	9.620 424	1214	9.642 721	850	9.645 961	459	9.695 034	792
9.414 351	245	9.534 161	859	9.538 002	873	9.580 042	789	9.620 425	1215	9.642 722	850	9.645 962	459	9.698 395	781
9.414 352	245	9.534 162	860	9.538 003	873	9.580 043	789	9.620 426	1214	9.642 723	850	9.645 963	459	9.698 525	824
9.414 353	245	9.534 163	860	9.538 004	873	9.580 045	789	9.620 429	1214	9.642 724	850	9.645 964	459	9.698 526	824
9.414 355	245	9.534 165	860	9.538 005	873	9.580 046	789	9.620 432	1214	9.642 725	850	9.645 965	459	9.698 528	824
9.414 356	245	9.534 167	861	9.538 006	873	9.580 047	789	9.620 434	1214	9.642 726	850	9.645 966	459	9.698 530	825
9.414 357	245	9.534 168	861	9.538 007	873	9.580 048	789	9.620 437	1214	9.642 727	850	9.645 967	459	9.698 531	825
9.414 371	245	9.534 169	869	9.538 008	873	9.580 049	789	9.620 438	1214	9.642 728	850	9.645 968	459	9.698 532	825
9.414 373	245	9.534 170	869	9.538 009	873	9.584 650	1306	9.620 439	1214	9.642 729	850	9.645 969	459	9.698 533	825
9.414 375	245	9.534 171	861	9.538 010	873	9.584 651	1306	9.620 441	1215	9.642 750	850	9.645 970	459	9.698 534	825
9.414 377	245	9.534 171	869	9.538 011	872	9.584 652	1321	9.620 442	1215	9.642 751	850	9.645 971	459	9.698 535	825
9.414 379	245	9.534 172	861	9.538 012	872	9.584 654	1321	9.620 443	1215	9.642 752	850	9.645 978	451	9.698 536	825
9.414 415	248	9.534 172	869	9.538 021	874	9.584 663	1306	9.620 446	1215	9.642 753	850	9.645 979	451	9.698 537	825
9.414 417	248	9.535 537	1285	9.538 022	874	9.584 664	1306	9.620 447	1215	9.642 754	850	9.645 980	451	9.698 538	825
9.414 419	248	9.535 538	1285	9.538 023	874	9.584 670	1307	9.620 448	1215	9.642 755	850	9.645 981	451	9.698 539	825
9.414 605	234	9.535 539	1285	9.538 024	899	9.584 671	1307	9.620 449	1214	9.642 756	850	9.645 982	451	9.698 540	825
9.414 606	234	9.535 542	1285	9.538 025	899	9.584 695	1308	9.620 470	1216	9.642 757	850	9.645 985	459	9.698 541	825
9.414 607	234	9.535 543	1285	9.538 026	899	9.584 696	1308	9.620 471	1216	9.642 758	850	9.645 986	459	9.698 550	825
9.414 608	235	9.535 544	1285	9.538 027	899	9.584 697	1308	9.620 474	1216	9.643 033	847	9.646 000	455	9.698 677	788
9.414 609	235	9.535 825	1287	9.539 045	1499	9.584 751	1324	9.620 475	1216	9.643 034	847	9.646 011	460	9.698 680	786
9.414 610	235	9.535 826	1287	9.539 046	1499	9.584 752	1324	9.642 401	846	9.643 035	847	9.646 026	457	9.698 682	788
9.414 611	235	9.535 829	1287	9.569 991	614	9.584 753	1323	9.642 402	846	9.643 036	847	9.646 027	457	9.698 685	788
9.414 612	235	9.535 830	1287	9.569 992	614	9.584 770	1311	9.642 403	846	9.643 037	847	9.646 040	477	9.698 686	781
9.414 613	235	9.535 862	1288	9.570 075	616	9.584 771	1311	9.642 404	846	9.643 038	847	9.646 057	477	9.698 688	781
9.414 650	237	9.535 863	1288	9.570 077	616	9.584 772	1311	9.642 405	846	9.643 039	847	9.646 058	477	9.698 690	788
9.414 651	237	9.535 866	1288	9.570 078	616	9.584 773	1311	9.642 406	846	9.643 072	848	9.650 151	612	9.698 691	788
9.414 652	237	9.535 867	1288	9.570 079	616	9.584 774	1305	9.642 407	846	9.643 073	848	9.650 152	613	9.698 692	781
9.414 653	237	9.535 870	1288	9.570 080	616	9.584 775	1305	9.642 408	846	9.643 074	848	9.650 160	610	9.698 693	781
9.414 654	237	9.535 871	1288	9.570 081	616	9.584 788	1305	9.642 409	846	9.643 075	848	9.650 165	610	9.698 697	781
9.414 655	238	9.535 877	1286	9.570 082	616	9.595 290	1297	9.642 410	846	9.643 081	848	9.650 166	610	9.698 698	781
9.414 656	238	9.535 889	1286	9.570 083	616	9.595 291	1297	9.642 411	846	9.643 083	848	9.650 223	614	9.698 699	786
9.414 657	238	9.535 890	1286	9.570 084	616	9.595 306	1308	9.642 412	846	9.643 122	849	9.650 224	614	9.698 708	761
9.414 658	238	9.535 891	1286	9.570 085	616	9.595 314	1308	9.642 413	846	9.643 123	849	9.650 235	614	9.698 709	761
9.414 659	238	9.535 892	1286	9.570 086	616	9.595 330	523	9.642 440	846	9.643 124	849	9.650 236	614	9.698 710	761
9.414 660	240	9.535 923	1288	9.570 087	616	9.595 331	523	9.642 441	846	9.643 125	849	9.650 239	612	9.698 711	761
9.414 661	240	9.535 931	1288	9.570 088	616	9.595 501	1302	9.642 442	846	9.643 126	849	9.650 240	612	9.698 712	761
9.414 662	240	9.535 935	1288	9.570 089	616	9.595 502	1302	9.642 443	846	9.643 127	849	9.650 243	612	9.698 746	763
9.519 120	590	9.535 960	1287	9.570 090	616	9.595 503	1302	9.642 444	846	9.645 280	1393	9.650 244	612	9.698 772	758
9.519 213	590	9.535 960	1288	9.570 091	616	9.595 504	1302	9.642 445	846	9.645 281	1393	9.650 245	612	9.698 773	758
9.519 223	590	9.535 961	1287	9.570 092	616	9.595 505	1302	9.642 446	846	9.645 316	841	9.650 246	612	9.698 776	758
9.520 050	1378	9.535 961	1286	9.570 093	616	9.595 506	1302	9.642 500	847	9.645 317	843	9.650 247	612	9.698 780	758
9.520 051	1378	9.535 961	1288	9.570 098	615	9.595 507	1302	9.642 501	847	9.645 320	843	9.650 249	612	9.698 781	758
9.520 053	1378	9.535 963	1287	9.570 223	602	9.595 515	1303	9.642 502	847	9.645 321	843	9.650 250	612	9.698 782	758
9.520 056	1378	9.535 966	1288	9.570 225	602	9.595 516	1303	9.642 503	847	9.645 322	535	9.650 260	614	9.698 783	758
9.520 057	1378	9.535 968	1287	9.570 226	602	9.595 517	1303	9.642 504	847	9.645 323	535	9.650 261	614	9.698 786	758
9.520 058	1378	9.535 970	1288	9.570 227	602	9.600 105	946	9.642 505	847	9.645 324	536	9.650 264	614	9.698 787	758
9.520 059	1378	9.535 971	1286	9.570 228	602	9.600 110	946	9.642 506	847	9.645 325	536	9.650 267	614	9.698 788	758
9.520 060	1378	9.535 972	1288	9.570 480	666	9.600 120	946	9.642 507	847	9.645 326	536	9.650 268	614	9.698 789	758
9.520 061	1378	9.535 973	1288	9.570 500	603	9.600 122	946	9.642 508	847	9.645 327	536	9.650 290	1190	9.698 790	758
9.520 062	1378	9.536 213	782	9.570 506	603	9.600 125	946	9.642 509	847	9.645 328	536	9.650 291	1190	9.698 791	758
9.5															

Bestellnummernindex - Numerical index - Index numérique - Índice Numérico - Índice numerico - Indeks numerów katalogowych - Указатель по номерам

9.699 101	827	9.705 225	1113	9.721 067	814	9.733 819	256	9.738 848	583	9.774 340	341	9.801 244	1125	9.822 552	326
9.699 142	871	9.705 226	1113	9.721 070	1305	9.733 825	257	9.738 849	583	9.774 354	305	9.801 246	1125	9.822 553	344
9.699 142	1260	9.705 230	1113	9.721 072	529	9.737 790	575	9.738 852	583	9.774 356	306	9.801 247	1125	9.822 560	343
9.699 144	871	9.718 011	396	9.721 073	528	9.737 791	575	9.738 864	583	9.774 367	305	9.801 249	1125	9.822 594	343
9.699 144	1260	9.718 020	397	9.721 074	539	9.737 801	577	9.738 869	583	9.774 378	341	9.801 250	1125	9.822 595	343
9.699 145	871	9.718 200	396	9.721 077	1352	9.737 805	577	9.738 874	583	9.774 400	332	9.801 251	1125	9.822 604	344
9.699 145	1260	9.718 202	396	9.721 079	529	9.737 806	577	9.738 875	583	9.774 409	332	9.801 252	1125	9.826 131	594
9.699 146	871	9.718 208	395	9.721 080	529	9.737 807	577	9.738 880	583	9.775 411	1139	9.801 254	1125	9.826 132	594
9.699 146	1260	9.718 209	395	9.721 081	508	9.737 815	577	9.738 885	583	9.775 412	1139	9.801 255	1125	9.826 133	594
9.699 147	871	9.718 222	396	9.725 094	851	9.737 816	577	9.738 960	583	9.775 430	1139	9.801 256	1125	9.826 134	594
9.699 147	1260	9.718 230	396	9.725 320	851	9.737 817	577	9.738 961	583	9.775 454	1141	9.801 257	1133	9.826 402	593
9.699 230	1242	9.718 232	395	9.725 321	851	9.737 818	577	9.738 962	583	9.776 567	1297	9.801 259	1135	9.826 403	593
9.699 231	1244	9.718 418	401	9.725 322	851	9.737 828	578	9.738 963	583	9.776 620	1314	9.801 301	1126	9.828 142	1044
9.699 235	1241	9.720 137	452	9.725 323	851	9.738 151	573	9.738 965	583	9.776 621	1314	9.801 302	1126	9.828 144	1044
9.699 237	1241	9.720 145	469	9.725 363	852	9.738 170	573	9.738 966	583	9.776 622	1314	9.801 312	1126	9.828 146	1044
9.699 240	1244	9.720 167	449	9.725 381	851	9.738 172	573	9.738 970	571	9.776 623	1314	9.801 313	1126	9.828 152	1044
9.699 295	345	9.720 201	469	9.725 382	851	9.738 173	573	9.738 971	571	9.776 902	531	9.801 333	1126	9.828 154	1044
9.699 310	772	9.720 208	453	9.725 383	851	9.738 174	573	9.738 974	571	9.776 903	896	9.801 335	1126	9.828 156	1044
9.699 311	772	9.720 211	449	9.725 394	851	9.738 200	586	9.738 976	571	9.776 904	531	9.801 344	1128	9.828 155	1049
9.699 320	774	9.720 219	460	9.725 395	851	9.738 211	586	9.738 977	571	9.776 905	531	9.801 348	1126	9.828 216	1049
9.699 321	774	9.720 220	448	9.726 000	188	9.738 218	585	9.738 978	571	9.776 906	532	9.801 359	1126	9.828 346	1048
9.699 322	774	9.720 222	453	9.726 001	188	9.738 221	585	9.738 980	571	9.776 906	897	9.801 360	1126	9.828 347	1048
9.699 323	774	9.720 226	453	9.726 403	418	9.738 222	585	9.739 001	587	9.776 907	532	9.801 362	1127	9.828 348	1048
9.699 630	798	9.720 241	473	9.726 405	419	9.738 223	585	9.739 002	588	9.776 907	897	9.801 369	1128	9.828 349	1048
9.699 631	798	9.720 242	473	9.726 412	411	9.738 226	585	9.739 003	588	9.776 908	532	9.801 370	1126	9.828 350	1048
9.699 632	799	9.720 248	472	9.726 418	419	9.738 227	585	9.739 006	588	9.776 908	897	9.801 372	1126	9.828 351	1048
9.699 633	799	9.720 250	464	9.726 422	408	9.738 235	586	9.739 007	588	9.776 909	532	9.801 375	1127	9.828 352	1048
9.699 634	799	9.720 257	472	9.726 431	402	9.738 240	586	9.739 030	581	9.776 909	897	9.801 376	1128	9.828 353	1048
9.699 634	798	9.720 276	472	9.726 964	420	9.738 255	586	9.739 031	581	9.776 910	532	9.801 377	1128	9.828 354	1048
9.699 640	800	9.720 352	472	9.726 965	420	9.738 257	586	9.739 032	581	9.776 910	897	9.801 378	1128	9.828 355	1048
9.699 641	800	9.720 402	464	9.727 030	1100	9.738 276	588	9.739 033	581	9.776 911	532	9.801 379	1128	9.828 356	1048
9.699 642	800	9.720 411	465	9.727 031	1100	9.738 277	588	9.739 034	581	9.776 911	897	9.801 382	1127	9.828 357	1048
9.699 643	800	9.720 412	465	9.727 050	1098	9.738 278	588	9.739 064	571	9.776 912	532	9.801 383	1127	9.828 358	1048
9.699 644	800	9.720 414	465	9.727 051	1098	9.738 279	588	9.739 065	571	9.776 912	897	9.801 472	1126	9.828 360	1048
9.699 645	800	9.720 417	465	9.727 052	1098	9.738 282	588	9.739 066	571	9.776 913	532	9.803 719	1196	9.828 361	1048
9.699 646	800	9.720 418	465	9.727 053	1098	9.738 283	588	9.739 067	574	9.776 913	897	9.803 720	1196	9.828 362	1048
9.699 647	800	9.720 480	454	9.728 800	525	9.738 284	588	9.739 069	574	9.776 914	532	9.803 737	1196	9.828 363	1048
9.699 648	800	9.720 490	467	9.728 801	520	9.738 285	588	9.739 083	574	9.776 914	897	9.803 738	1196	9.828 364	1048
9.699 649	800	9.720 491	467	9.728 810	537	9.738 286	588	9.739 091	583	9.776 915	532	9.803 755	1196	9.828 365	1048
9.699 650	800	9.720 492	467	9.728 811	537	9.738 287	588	9.739 093	590	9.776 915	897	9.803 756	1196	9.828 366	1049
9.699 651	800	9.720 493	452	9.728 812	537	9.738 288	588	9.739 098	590	9.776 916	532	9.803 759	1196	9.828 367	1049
9.699 652	800	9.720 494	452	9.728 813	537	9.738 289	588	9.739 147	598	9.776 916	897	9.803 760	1196	9.828 368	1054
9.699 653	800	9.720 495	452	9.728 821	520	9.738 290	588	9.739 200	598	9.776 917	532	9.803 765	1196	9.828 370	1048
9.699 654	800	9.720 496	843	9.728 830	507	9.738 298	588	9.739 201	598	9.776 918	532	9.803 766	1196	9.828 371	1049
9.699 655	800	9.720 497	843	9.728 840	511	9.738 299	588	9.739 202	598	9.776 936	531	9.812 217	663	9.828 372	1049
9.699 656	800	9.720 498	843	9.728 890	475	9.738 300	586	9.739 203	598	9.776 937	531	9.812 365	1069	9.828 373	1049
9.699 657	800	9.720 603	474	9.728 891	475	9.738 310	598	9.739 204	598	9.777 000	1352	9.812 385	1072	9.828 375	1049
9.699 658	800	9.720 604	474	9.728 892	475	9.738 311	585	9.739 205	598	9.777 001	1352	9.812 477	1069	9.828 376	1045
9.699 659	800	9.720 605	474	9.728 893	475	9.738 315	587	9.739 238	594	9.777 005	1352	9.812 478	1069	9.828 376	1049
9.699 660	800	9.720 606	474	9.728 897	475	9.738 325	585	9.739 242	592	9.777 007	1352	9.813 010	657	9.828 377	1049
9.699 661	800	9.720 607	474	9.728 898	475	9.738 327	585	9.739 243	594	9.777 008	1352	9.813 016	657	9.828 378	1045
9.699 662	800	9.720 608	474	9.728 900	475	9.738 329	588	9.739 270	585	9.777 009	1352	9.813 017	656	9.828 378	1049
9.699 663	800	9.720 609	474	9.728 901	475	9.738 340	585	9.739 271	585	9.777 010	1352	9.813 018	656	9.828 379	1049
9.699 664	800	9.720 610	474	9.729 917	603	9.738 343	585	9.739 274	585	9.778 950	491	9.813 019	656	9.828 381	1049
9.699 665	800	9.720 611	474	9.729 918	839	9.738 345	585	9.739 275	585	9.778 951	491	9.813 026	657	9.828 391	1045
9.699 666	800	9.720 650	456	9.729 919	603	9.738 354	585	9.739 276	592	9.778 952	491	9.816 562	489	9.828 394	1049
9.699 667	800	9.721 000	499	9.729 936	500	9.738 355	589	9.739 277	591	9.778 953	491	9.816 564	489	9.828 396	1049
9.699 668	800	9.721 001	667	9.729 938	502	9.738 424	589	9.739 281	584	9.778 954	491	9.816 566	489	9.828 420	1054
9.699 669	800	9.721 004	667	9.729 939	502	9.738 429	589	9.739 287	584	9.778 960	491	9.816 595	495	9.828 421	1054
9.699 670	800	9.721 009	892	9.729 950	500	9.738 429	589	9.739 299	584	9.778 961	491	9.816 596	495	9.828 423	1054
9.699 671	800	9.721 010	892	9.729 970	538	9.738 432	589	9.739 321	589	9.778 962	491	9.816 597	495	9.828 476	1048
9.700 400	278	9.721 011	522	9.729 971	538	9.738 433	589	9.739 331	589	9.778 963	491	9.816 598	495	9.828 487	1045
9.700 401	278	9.721 014	522	9.729 972	538	9.738 435	589	9.739 333	589	9.778 964	491	9.816 599	495	9.828 510	1050
9.700 420	1044	9.721 015	521	9.729 973	538	9.738 437	589	9.739 335	589	9.779 013	492	9.816 622	486	9.828 511	1054
9.700 421	1044	9.721 016	533	9.729 982	536	9.738 441	589	9.739 340	589	9.779 014	492	9.816 630	486	9.828 512	1049
9.700 422	1044	9.721 017	523	9.729 983	536	9.738 442	589	9.739 341	589	9.779 065	492	9.816 631	486	9.828 513	1045
9.700 423	1044	9.721 018	505	9.729 984	519	9.738 449	589	9.739 350	589	9.779 163	491	9.816 632	486	9.828 514	1045

Bestellnummernindex - Numerical index - Index numérique - Índice Numérico - Índice numerico - Indeks numerów katalogowych - Указатель по номерам

9.837 882	885	9.842 418	1204	9.843 974	1269	9.857 923	833	9.868 027	898	9.877 651	1188	9.880 614	1066	9.883 566	901
9.837 883	885	9.842 420	1203	9.851 018	417	9.857 924	833	9.868 028	898	9.877 653	1188	9.880 615	1067	9.883 567	901
9.837 884	885	9.842 421	1203	9.851 019	417	9.857 925	833	9.868 029	898	9.877 655	1188	9.880 616	1067	9.883 568	871
9.837 885	885	9.842 422	1203	9.851 023	400	9.857 926	833	9.869 681	854	9.877 657	1188	9.880 627	1071	9.883 569	871
9.837 886	885	9.842 423	1203	9.851 027	416	9.857 927	833	9.869 682	854	9.877 658	1188	9.880 632	1071	9.883 570	871
9.837 890	886	9.842 424	1203	9.851 028	392	9.857 928	833	9.869 683	854	9.877 694	1188	9.880 675	1066	9.883 571	871
9.837 891	886	9.842 425	1203	9.851 029	392	9.857 929	833	9.869 684	854	9.877 697	1188	9.880 680	1062	9.883 572	871
9.837 892	886	9.842 427	1204	9.851 300	397	9.857 931	833	9.869 685	854	9.877 698	1188	9.880 828	1073	9.883 573	902
9.837 893	886	9.842 428	1204	9.851 324	396	9.857 932	833	9.869 686	854	9.877 699	1188	9.880 832	1073	9.883 574	902
9.837 894	886	9.842 429	1204	9.851 352	397	9.857 933	833	9.869 687	854	9.877 700	1188	9.880 837	1073	9.883 575	902
9.837 897	886	9.842 430	1204	9.851 714	397	9.857 934	833	9.869 688	854	9.877 701	1188	9.880 883	1064	9.883 576	902
9.838 046	513	9.842 431	1204	9.851 716	397	9.857 935	833	9.869 689	855	9.877 702	1188	9.880 884	1064	9.883 583	900
9.838 049	513	9.842 432	1204	9.851 720	397	9.858 040	819	9.869 690	855	9.877 703	1188	9.880 885	1064	9.883 584	900
9.838 050	513	9.842 433	1204	9.851 723	397	9.858 040	830	9.869 691	855	9.877 712	1188	9.880 887	1064	9.883 599	867
9.838 063	516	9.843 706	1271	9.851 724	396	9.859 201	801	9.869 692	855	9.877 713	1188	9.880 890	1064	9.883 603	867
9.838 074	511	9.843 707	1271	9.851 876	1201	9.859 203	802	9.869 693	855	9.877 715	1188	9.880 894	1065	9.883 710	901
9.838 080	517	9.843 708	1271	9.851 877	1201	9.859 204	802	9.869 694	855	9.877 716	1188	9.880 896	1065	9.883 711	901
9.838 101	517	9.843 709	1271	9.851 879	1201	9.859 205	802	9.869 695	855	9.877 717	1189	9.880 898	1065	9.883 712	901
9.838 111	517	9.843 710	1271	9.851 888	1200	9.859 206	802	9.869 696	855	9.877 720	1188	9.880 900	1065	9.883 713	901
9.838 115	517	9.843 741	1219	9.851 893	1201	9.859 207	802	9.869 697	854	9.877 721	1188	9.880 921	1073	9.883 714	901
9.838 121	517	9.843 744	1219	9.851 894	1201	9.859 208	802	9.869 698	854	9.877 731	1190	9.880 926	1065	9.883 726	877
9.838 131	517	9.843 745	1219	9.851 895	1201	9.859 209	802	9.869 699	854	9.877 733	1190	9.880 930	1063	9.883 732	877
9.838 135	517	9.843 750	1273	9.851 896	1201	9.859 210	802	9.869 700	854	9.877 746	1190	9.880 932	1063	9.883 738	877
9.838 140	509	9.843 751	1273	9.851 897	1201	9.859 211	802	9.869 701	854	9.877 781	1190	9.880 934	1063	9.883 744	877
9.838 175	511	9.843 752	1273	9.851 898	1200	9.859 212	802	9.869 702	854	9.877 784	1190	9.880 936	1063	9.883 803	855
9.838 185	516	9.843 753	1273	9.851 924	423	9.859 213	804	9.869 703	854	9.877 800	1189	9.880 940	1064	9.883 808	855
9.838 191	517	9.843 754	1273	9.851 925	423	9.859 220	804	9.869 704	854	9.877 801	1189	9.880 941	1064	9.884 140	902
9.838 192	517	9.843 756	1272	9.851 935	423	9.859 221	804	9.869 705	855	9.877 802	1189	9.880 943	1065	9.884 141	902
9.838 193	517	9.843 757	1271	9.851 936	423	9.859 222	804	9.869 706	855	9.877 803	1189	9.880 944	1065	9.884 142	902
9.838 201	517	9.843 758	1272	9.851 937	423	9.859 223	804	9.869 707	855	9.877 804	1189	9.880 947	1063	9.884 143	902
9.838 205	517	9.843 759	1272	9.851 938	423	9.859 224	804	9.869 708	855	9.877 806	1189	9.880 950	1064	9.900 501	380
9.838 208	517	9.843 760	1272	9.851 948	423	9.859 225	815	9.869 709	855	9.877 830	1187	9.880 952	1064	9.900 502	380
9.838 210	517	9.843 766	1273	9.851 949	423	9.859 226	815	9.869 710	855	9.877 831	1187	9.880 953	1064	9.900 505	380
9.838 211	517	9.843 767	1273	9.851 954	423	9.859 227	814	9.869 711	855	9.877 832	1187	9.880 954	1064	9.900 510	380
9.838 305	516	9.843 768	1271	9.851 955	423	9.859 228	814	9.869 712	855	9.877 833	1187	9.880 955	1065	9.900 512	380
9.838 306	516	9.843 769	1271	9.851 959	423	9.859 229	814	9.869 713	855	9.877 834	1187	9.880 956	1065	9.900 515	380
9.838 307	516	9.843 770	1271	9.851 961	423	9.859 230	814	9.877 021	1185	9.877 835	1187	9.880 957	1065	9.900 520	380
9.838 308	516	9.843 771	1271	9.851 992	423	9.859 232	815	9.877 051	1185	9.877 836	1187	9.880 958	1065	9.900 522	380
9.838 320	515	9.843 773	1273	9.851 995	423	9.859 233	815	9.877 052	1185	9.877 837	1187	9.880 960	1065	9.900 525	380
9.838 400	514	9.843 775	1273	9.851 996	400	9.859 234	815	9.877 100	1185	9.877 838	1187	9.880 965	1073	9.900 531	380
9.838 403	514	9.843 776	1273	9.851 997	392	9.859 235	815	9.877 101	1185	9.877 839	1187	9.880 968	1073	9.900 532	380
9.839 805	535	9.843 777	1268	9.851 998	400	9.859 236	815	9.877 103	1185	9.877 840	1187	9.880 970	1073	9.900 535	380
9.839 806	535	9.843 778	1268	9.851 999	392	9.859 237	816	9.877 105	596	9.877 841	1187	9.880 976	1073	9.900 785	384
9.839 807	535	9.843 779	1268	9.852 000	423	9.859 238	816	9.877 105	1186	9.877 842	1187	9.881 368	1075	9.900 786	384
9.839 810	503	9.843 786	1268	9.852 001	423	9.859 239	816	9.877 106	596	9.877 848	1187	9.881 369	1075	9.900 787	384
9.839 830	540	9.843 800	1219	9.852 002	423	9.859 240	816	9.877 106	1186	9.877 849	1187	9.881 370	1075	9.900 788	383
9.839 831	540	9.843 801	1220	9.852 003	423	9.859 241	817	9.877 107	596	9.877 850	1187	9.882 101	1262	9.900 789	384
9.839 832	540	9.843 802	1220	9.852 004	423	9.859 242	817	9.877 107	1186	9.877 851	1187	9.882 102	1262	9.900 790	384
9.839 855	521	9.843 803	1273	9.852 005	423	9.859 243	816	9.877 108	596	9.877 852	1187	9.882 103	1262	9.900 791	384
9.839 856	521	9.843 813	1273	9.852 006	423	9.859 245	817	9.877 108	1186	9.877 853	1187	9.882 104	1262	9.900 800	384
9.839 857	526	9.843 814	1273	9.852 007	423	9.859 246	817	9.877 114	1185	9.877 854	1187	9.882 114	1278	9.900 801	383
9.839 859	526	9.843 815	1273	9.852 008	423	9.859 247	817	9.877 155	1185	9.877 855	1187	9.882 115	1278	9.900 893	384
9.839 875	878	9.843 816	1273	9.852 120	506	9.859 248	817	9.877 156	1185	9.877 857	1187	9.882 116	1278	9.900 894	384
9.839 876	878	9.843 817	1273	9.852 121	506	9.859 249	817	9.877 256	1185	9.877 860	1187	9.882 117	1278	9.900 895	384
9.839 877	878	9.843 818	1273	9.852 125	506	9.859 256	817	9.877 510	1185	9.877 862	1187	9.882 118	1278	9.900 896	384
9.839 878	878	9.843 824	1269	9.852 127	506	9.863 154	1032	9.877 511	1185	9.877 863	1187	9.882 119	1278	9.900 938	359
9.840 202	283	9.843 825	1269	9.852 129	506	9.863 155	1032	9.877 512	1185	9.877 864	1192	9.882 120	1279	9.900 955	368
9.840 514	292	9.843 826	1269	9.852 146	506	9.863 156	1032	9.877 515	1185	9.877 865	1187	9.882 121	1279	9.900 956	368
9.840 532	292	9.843 830	1274	9.852 300	894	9.863 157	1032	9.877 516	1185	9.877 866	1187	9.882 122	1279	9.900 957	368
9.840 608	293	9.843 831	1274	9.852 301	894	9.863 158	1032	9.877 528	596	9.877 867	1187	9.882 123	1279	9.900 958	368
9.840 609	293	9.843 835	1268	9.852 302	894	9.863 159	1033	9.877 528	1186	9.877 868	1187	9.882 124	1279	9.900 959	368
9.840 681	289	9.843 836	1268	9.852 303	894	9.863 159	1032	9.877 529	1185	9.877 869	1187	9.882 125	1279	9.901 007	360
9.840 682	289	9.843 837	1268	9.852 307	893	9.863 160	1034	9.877 530	596	9.877 870	1187	9.882 126	1279	9.901 008	360
9.840 689	292	9.843 838	1268	9.852 308	893	9.863 161	1034	9.877 530	1186	9.877 871	1187	9.882 127	1279	9.901 009	360
9.840 690	292	9.843 839	1268	9.852 309	893	9.863 162	1034	9.877 537	1185	9.880 080	1063	9.882 128	1279	9.901 010	360
9.840 691	293	9.843 844	1271	9.852 310	893	9.863 163	1034	9.877 538	596	9.880 083	1063	9.882 207	1080	9.901 011	360
9.840 692	293	9.843 845	1271	9.852 315	894	9.863 16									

Bestellnummernindex - Numerical index - Index numérique - Índice Numérico - Índice numerico - Indeks numerów katalogowych - Указатель по номерам

9.901 418	363	9.906 585	834	9.915 736	1281	9.920 721	1251	9.945 947	680	9.950 307	1462	9.951 038	722	9.951 337	1266
9.901 422	363	9.906 586	834	9.915 737	1281	9.920 723	1252	9.945 948	680	9.950 308	1497	9.951 039	722	9.951 338	1266
9.901 441	376	9.906 591	835	9.915 738	1281	9.920 730	1252	9.945 949	680	9.950 309	1497	9.951 040	722	9.951 339	1266
9.901 442	363	9.906 592	835	9.920 045	343	9.920 748	1253	9.945 950	678	9.950 310	1497	9.951 041	722	9.951 340	1266
9.901 443	363	9.906 593	835	9.920 080	1247	9.920 764	799	9.945 951	678	9.950 311	1497	9.951 042	722	9.951 341	1266
9.901 444	363	9.906 594	835	9.920 090	311	9.920 765	799	9.945 952	680	9.950 312	1497	9.951 043	722	9.951 342	1266
9.901 445	363	9.906 595	835	9.920 091	311	9.920 766	799	9.945 953	680	9.950 313	1497	9.951 044	722	9.951 343	1266
9.901 451	367	9.906 596	835	9.920 092	311	9.920 806	1249	9.945 954	680	9.950 314	1497	9.951 045	722	9.951 344	1266
9.901 452	367	9.906 650	835	9.920 093	311	9.920 807	1249	9.947 065	1243	9.950 315	1497	9.951 046	722	9.951 345	1266
9.901 453	367	9.906 651	835	9.920 096	333	9.920 808	1249	9.947 066	1243	9.950 316	1497	9.951 047	722	9.951 346	1266
9.901 454	367	9.908 017	406	9.920 097	333	9.920 862	1248	9.947 067	1243	9.950 317	1497	9.951 048	722	9.951 347	1266
9.901 455	367	9.908 018	393	9.920 100	311	9.920 864	1248	9.947 069	1243	9.950 319	1497	9.951 049	722	9.951 348	1266
9.901 456	367	9.908 021	398	9.920 101	311	9.920 880	1248	9.947 070	1243	9.950 322	1498	9.951 061	732	9.951 349	1266
9.901 457	367	9.908 022	398	9.920 102	311	9.920 887	1248	9.947 071	1243	9.950 323	1498	9.951 062	732	9.951 350	1266
9.902 361	371	9.908 023	398	9.920 104	311	9.920 900	1248	9.947 072	1243	9.950 324	1498	9.951 063	732	9.951 351	1266
9.902 362	371	9.908 024	398	9.920 107	311	9.920 906	1248	9.947 073	1243	9.950 325	1498	9.951 064	732	9.951 352	1266
9.902 363	371	9.908 025	398	9.920 108	341	9.920 916	1248	9.947 074	1243	9.950 326	1498	9.951 065	732	9.951 353	1266
9.902 364	371	9.908 026	393	9.920 109	341	9.920 918	1248	9.947 075	1244	9.950 327	1498	9.951 066	732	9.951 354	1266
9.902 366	371	9.908 027	406	9.920 110	341	9.920 927	1248	9.947 076	1244	9.950 328	1498	9.951 067	732	9.951 355	1266
9.902 368	371	9.908 032	401	9.920 111	341	9.920 934	1248	9.947 079	1243	9.950 329	1498	9.951 068	732	9.951 356	1266
9.902 370	371	9.908 056	397	9.920 114	333	9.920 936	1248	9.947 080	1243	9.950 330	1498	9.951 069	731	9.951 491	1263
9.902 371	371	9.908 057	397	9.920 115	333	9.920 945	1248	9.947 081	1243	9.950 331	1498	9.951 070	731	9.951 492	1263
9.902 373	371	9.908 059	397	9.920 117	333	9.920 948	1248	9.947 100	1244	9.950 332	1498	9.951 071	731	9.951 600	384
9.902 375	371	9.908 069	403	9.920 120	352	9.920 956	1248	9.947 101	1244	9.950 333	1498	9.951 072	731	9.951 612	884
9.902 611	379	9.908 070	410	9.920 121	352	9.920 966	1248	9.947 130	1244	9.950 334	1498	9.951 073	731	9.951 617	894
9.902 612	379	9.908 073	403	9.920 122	352	9.923 601	1245	9.947 131	1244	9.950 371	1497	9.951 074	732	9.951 618	894
9.902 636	371	9.908 074	410	9.920 123	352	9.923 602	1245	9.947 172	1147	9.950 372	515	9.951 075	732	9.951 619	894
9.905 723	800	9.908 075	398	9.920 124	352	9.923 603	1264	9.947 173	1147	9.950 399	1393	9.951 076	732	9.951 620	894
9.905 724	800	9.908 076	398	9.920 125	352	9.923 604	1264	9.947 280	1147	9.950 400	446	9.951 077	732	9.951 621	894
9.905 725	800	9.908 077	398	9.920 127	352	9.923 624	1245	9.947 281	1147	9.950 408	460	9.951 126	740	9.951 622	894
9.905 726	800	9.908 078	398	9.920 202	1240	9.923 625	1245	9.947 282	1147	9.950 424	474	9.951 127	740	9.951 623	894
9.905 860	831	9.908 098	406	9.920 203	1263	9.923 626	1245	9.947 283	1147	9.950 531	1240	9.951 128	740	9.951 624	894
9.905 861	831	9.908 099	406	9.920 204	1249	9.923 631	1246	9.947 284	1147	9.950 533	1250	9.951 129	740	9.951 625	894
9.905 862	831	9.908 100	406	9.920 205	1250	9.923 632	1246	9.947 285	1147	9.950 534	1250	9.951 186	733	9.951 661	893
9.905 863	831	9.908 127	1365	9.920 509	1259	9.923 635	1246	9.947 286	1147	9.950 535	1250	9.951 187	733	9.951 662	893
9.905 864	831	9.908 128	1365	9.920 513	1259	9.923 636	1246	9.947 287	1147	9.950 979	726	9.951 188	733	9.951 663	893
9.905 865	831	9.908 130	50	9.920 514	1259	9.923 638	1246	9.947 310	377	9.950 980	726	9.951 189	733	9.951 664	893
9.905 866	831	9.910 338	472	9.920 515	1259	9.941 600	384	9.947 312	377	9.950 981	726	9.951 190	733	9.951 665	893
9.905 867	831	9.914 432	1281	9.920 537	1274	9.945 728	676	9.947 316	371	9.950 982	726	9.951 191	733	9.951 666	893
9.905 870	831	9.914 437	1281	9.920 538	1274	9.945 729	676	9.947 341	1147	9.950 983	726	9.951 198	733	9.951 667	893
9.905 871	831	9.914 442	1281	9.920 540	1250	9.945 737	676	9.947 342	1147	9.950 984	726	9.951 199	733	9.951 668	893
9.905 872	831	9.914 452	1281	9.920 541	1250	9.945 738	676	9.947 343	1147	9.950 985	726	9.951 200	733	9.951 669	893
9.905 873	831	9.914 502	1281	9.920 542	1251	9.945 739	676	9.947 344	1147	9.950 988	726	9.951 201	733	9.961 000	132
9.905 875	830	9.914 506	1281	9.920 543	1251	9.945 740	676	9.947 345	1147	9.950 989	726	9.951 202	733	9.971 703	66
9.905 876	830	9.914 509	1281	9.920 545	1220	9.945 760	530	9.947 538	314	9.950 991	726	9.951 203	733	9.971 704	66
9.905 877	830	9.914 510	1289	9.920 546	1274	9.945 761	530	9.947 540	314	9.950 992	726	9.951 204	733	9.971 910	1311
9.906 200	840	9.914 512	1281	9.920 547	1274	9.945 763	890	9.947 555	1129	9.950 994	726	9.951 238	732	9.971 911	1311
9.906 383	838	9.914 519	1289	9.920 548	1274	9.945 764	890	9.947 556	1129	9.950 995	726	9.951 239	732	9.971 912	1311
9.906 384	838	9.914 519	1290	9.920 584	1273	9.945 765	890	9.947 604	377	9.950 998	726	9.951 240	732	9.971 913	1311
9.906 401	838	9.914 520	1289	9.920 585	1273	9.945 780	890	9.947 605	377	9.951 001	726	9.951 241	732	9.971 914	1311
9.906 402	838	9.914 520	1290	9.920 598	1217	9.945 790	668	9.950 034	427	9.951 002	726	9.951 245	732	9.971 915	1310
9.906 420	838	9.914 524	1289	9.920 599	1217	9.945 793	670	9.950 035	427	9.951 003	726	9.951 246	732	9.971 918	1310
9.906 421	838	9.914 524	1290	9.920 600	1217	9.945 794	670	9.950 036	427	9.951 004	726	9.951 249	731	9.971 921	1310
9.906 422	838	9.914 527	1289	9.920 602	1217	9.945 795	670	9.950 037	427	9.951 005	726	9.951 250	731	9.971 922	1310
9.906 423	838	9.914 527	1290	9.920 605	1217	9.945 796	670	9.950 038	427	9.951 006	726	9.951 252	731	9.971 923	1500
9.906 530	835	9.914 548	1284	9.920 606	1217	9.945 797	670	9.950 039	427	9.951 008	726	9.951 253	731	9.971 926	1500
9.906 531	835	9.914 549	1284	9.920 639	1218	9.945 798	670	9.950 177	444	9.951 009	726	9.951 255	731	9.971 927	1500
9.906 532	835	9.914 550	1284	9.920 640	1218	9.945 937	680	9.950 194	383	9.951 010	726	9.951 256	731	9.971 936	1310
9.906 533	835	9.914 553	1284	9.920 641	1218	9.945 938	680	9.950 195	383	9.951 011	726	9.951 257	731	9.971 938	1310
9.906 534	835	9.914 587	1281	9.920 642	1218	9.945 939	680	9.950 196	383	9.951 012	726	9.951 258	731	9.971 948	1313
9.906 537	835	9.914 623	1289	9.920 643	1218	9.945 940	680	9.950 197	383	9.951 013	726	9.951 264	732	9.971 949	1313
9.906 561	835	9.915 730	1279	9.920 644	1218	9.945 941	680	9.950 301	1461	9.951 014	726	9.951 265	732	9.971 950	1313
9.906 562	835	9.915 731	1279	9.920 706	1252	9.945 942	680	9.950 302	1462	9.951 016	725	9.951 266	732	9.971 951	1313
9.906 581	834	9.915 732	1279	9.920 710	638	9.945 943	680	9.950 303	1462	9.951 018	725	9.951 268	732		
9.906 582	834	9.915 733	1279	9.920 710	1252	9.945 944	680	9.950 304	1462	9.951 034	722	9.951 269	732		
9.906 583	834	9.915 734	1279	9.920 710	1273	9.945 945	680	9.950 305	1462	9.951 035	722	9.951 335	1266		
9.906 584	834	9.915 735	1279	9.920 713	1252	9.945 946	680	9.950 306	1462	9.951 036	722	9.951 336			

our locations

BRANCH OFFICE VIENNA

BARTELT Gesellschaft m. b. H.
Tannengasse 20, A-1150 Wien, Austria
Phone +43 (1) 789 53 46
Fax +43 (1) 789 53 46 - 55
baw@bartelt.at



OFFICE GRAZ – HEADQUARTER

BARTELT Gesellschaft m. b. H.
Neufeldweg 42, A-8010 Graz, Austria
Phone +43 (316) 47 53 28 - 0
Fax +43 (316) 47 53 28 - 55
office@bartelt.at

BRANCH OFFICE INNSBRUCK

BARTELT Gesellschaft m. b. H.
Anichstraße 29/2, A-6020 Innsbruck, Austria
Phone +43 (512) 58 13 55
Fax +43 (512) 58 13 55 - 55
bat@bartelt.at

LOGISTICS CENTER

BARTELT Gesellschaft m. b. H.
Gewerbepark 12a , A-8075 Hart bei Graz, Austria
Phone +43 (316) 47 53 28 - 401
Fax +43 (316) 47 53 28 - 44
logistik@bartelt.at

**special prices for
registered onlineshop
customers!**

bartelt.at

**Our service(s) for
your success!**

**BARTELT Gesellschaft m. b. H.
Headquarter Graz**

Neufeldweg 42, 8010 Graz, Austria

Phone: +43 (316) 47 53 28 - 0

Fax: +43 (316) 47 53 28 - 55

office@bartelt.at

www.bartelt.at